

HP 20b Business Consultant  
HP 30b Business Professional  
Financial Calculator User's Guide



HP Part Number: NW238-90001

Edition 1, December 2009

## Legal Notice

This manual and any examples contained herein are provided "as is" and are subject to change without notice. Hewlett-Packard Company makes no warranty of any kind with regard to this manual, including, but not limited to, the implied warranties of merchantability, non-infringement and fitness for a particular purpose. In this regard, HP shall not be liable for technical or editorial errors or omissions contained in the manual.

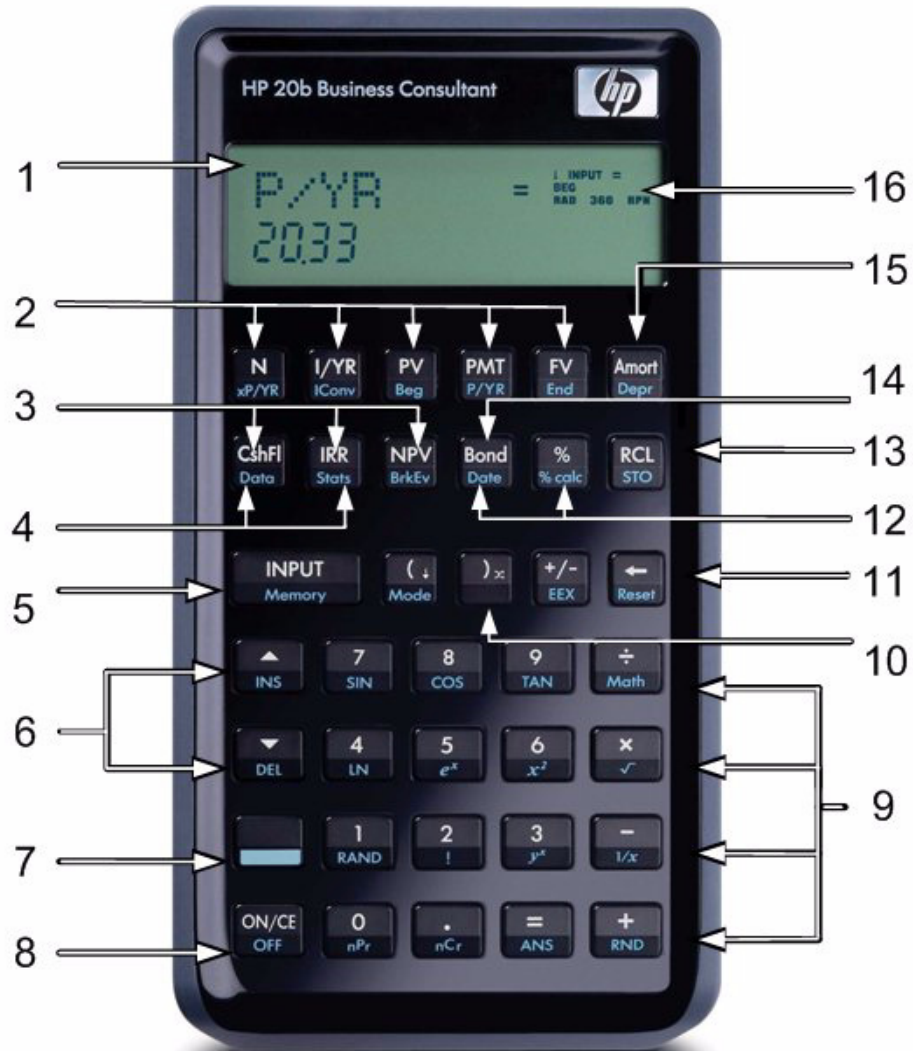
Hewlett-Packard Company shall not be liable for any errors or for incidental or consequential damages in connection with the furnishing, performance, or use of this manual or the examples contained herein.

Copyright © 2009 Hewlett-Packard Development Company, L.P.

Reproduction, adaptation, or translation of this manual is prohibited without prior written permission of Hewlett-Packard Company, except as allowed under the copyright laws.

Hewlett-Packard Company  
16399 West Bernardo Drive  
MS 66M-785  
San Diego, CA 92127-1899  
USA

# HP 20b Business Consultant



# HP 30b Business Professional



# Keyboard Map Legend

Number	Feature	Number	Feature
1	2-line, alphanumeric scrolling display screen	9	Common Mathematical functions and Math (Math) menu
2	Time Value of Money keys (TVM)	10	Program menu* RPN Swap/Close parenthesis
3	Cash Flow, IRR and NPV keys	11	Backspace key/Reset menu
4	Data and Statistics menus	12	Percent/Percent calculation (business) and Date menus
5	Input key and Memory menu	13	Recall and Store
6	Insert and Delete/scroll (up and down)	14	Black-Scholes** and Bond menus
7	Shift key	15	Amortization/Depreciation menus
8	On/Off/Cancel	16	Annunciators

\* Only applies to HP 30b.

\*\*Does not apply to the HP 20b.



# Table of Contents

Legal Notice.....	ii
HP 20b Business Consultant .....	iii
HP 30b Business Professional .....	iv
Keyboard Map Legend .....	v
<b>1 Basic Features .....</b>	<b>1</b>
Welcome to your new HP Financial Calculator .....	1
Turning the Calculator On and Off .....	1
Selecting a Language .....	1
Adjusting the Display Contrast .....	1
Cursor .....	2
Two Line Display.....	2
The Mode Menu: Setting Preferences.....	2
Changing the Calculation Mode .....	4
Key Presses, the Shift Key, Secondary, and Tertiary Functions* .....	4
Annunciators .....	6
The Input Key .....	6
The Equals Key .....	6
Using the Input and Equals Keys .....	6
Editing and Clearing Entries .....	7
The On/CE Key .....	7
The Reset Menu .....	7
Notes about Special Menus .....	8
Memory and the Memory Menu.....	8
Accessing Menus and Menu Maps.....	8
<b>2 Mathematical Calculations .....</b>	<b>11</b>
Mathematical Functions .....	11
Number Entry and Display .....	11
Chain Mode.....	12
Algebraic Mode .....	12
Reverse Polish Notation (RPN) Mode .....	13
The RPN Stack .....	13
Last Number.....	14
One-Number Functions and the Math Menu .....	18
Random number .....	19
The Math Menu .....	19
The Probability Sub-menu .....	21
Binomial Functions .....	23
Two-Number Functions .....	23
Storing and Recalling Numbers .....	24
Recall Arithmetic .....	24
Storing and Recalling with Time Value of Money (TVM) Keys .....	24
Recalling a Menu Item Value in a Menu.....	25
Recalling and Storing Values in the Data and Cash Flow Menus .....	25
Rounding Numbers .....	25
Percentages.....	25
<b>3 Time Value of Money .....</b>	<b>27</b>
Time Value of Money (TVM) Keys.....	27

Amortization .....	29
Interest Conversion Menu .....	33
<b>4 Canadian Mortgages: TVM Canada .....</b>	<b>35</b>
Canadian Mortgage Example .....	36
<b>5 Cash Flows .....</b>	<b>37</b>
Cash Flow Example .....	38
Sample Cash Flow Diagrams .....	46
<b>6 Bonds .....</b>	<b>47</b>
The Bond Menu .....	48
<b>7 Black-Scholes Calculation Menu* .....</b>	<b>51</b>
The Black-Scholes Menu .....	52
<b>8 Date Calculation .....</b>	<b>57</b>
The Date Calculation Menu .....	57
<b>9 Break-even .....</b>	<b>59</b>
The Break-even Menu .....	59
<b>10 Business Problems .....</b>	<b>61</b>
The Percent Calculation Menu .....	61
<b>11 Depreciation .....</b>	<b>65</b>
The Depreciation Menu .....	66
<b>12 Statistical Operations .....</b>	<b>69</b>
The Data and Stats Menus .....	70
<b>13 Programming .....</b>	<b>75</b>
Programming the HP 30b .....	75
Key Presses for Program Instructions .....	75
Programming Example .....	77
Program Step 0 .....	78
Reassigning Menu Functions .....	79
The Program Menu and Program Editing .....	80
Tests and Jump Functions .....	81
Long Programs and Battery Life .....	82
Sub-Function Call .....	82
Other Programming Functions .....	83
Messages .....	84
Debugging a Program .....	85
Saving, Restoring, and Modifying Mode Settings .....	86
Solve .....	87
<b>14 Error Messages .....</b>	<b>89</b>
Error Messages and Calculator Status .....	89
<b>15 Warranty, Regulatory, and Contact Information .....</b>	<b>91</b>
Replacing the Batteries .....	91
HP Limited Hardware Warranty and Customer Care .....	91
Contact Information .....	95



# 1 Basic Features


## Welcome to your new HP Financial Calculator

This manual is designed to familiarize you with the many features available on your new HP Business and Financial calculators. It includes menu maps, cash flow diagrams, and example problems and solutions with key presses and screen shots. Also included are sections which list the error messages, a chapter about programming, and an explanation of how Reverse Polish Notation (RPN) works. Refer to the *Table of Contents* for quick access to various topics. If you need more information about your calculator or calculator operation, please refer to the training materials available at: [www.hp.com/calculators](http://www.hp.com/calculators).

This manual describes in detail the features available on both the HP 20b and the HP 30b calculators. In addition to all of the features found on the HP 20b, the HP 30b includes the Black-Scholes option pricing model, Modified Internal Rate of Return (MIRR), Financial Management Rate of Return (FMRR), and programming capabilities. When features apply only to a particular model, they will be identified throughout the manual with an asterisk\*.






## Turning the Calculator On and Off

To turn on your calculator, press . To turn it off, press .






Turning the calculator off does not erase any data. The calculator automatically turns itself off after approximately five minutes to conserve energy. If you see the low battery symbol () in the display, replace the batteries. See the Chapter 15, *Warranty, Regulatory, and Contact Information* for instructions on replacing the batteries.

## Selecting a Language

English is the default language for messages displayed on the screen. To select a language other than English:

1. Press   to access the Mode menu. **FIX** displays on the top line of the screen.
2. Press  repeatedly until **English** displays on the screen.
3. Press  until the desired language is displayed. The displayed language is the active setting.
4. Press  to return to the default calculator screen.
5. For more information on accessing menus and changing calculator settings, refer to the section below titled, *The Mode Menu: Setting Preferences*.

## Adjusting the Display Contrast

To adjust the contrast of the display, press and hold  while pressing the  or  keys. Each press of the  or  keys slightly increases or decreases the contrast of the display.

## Cursor

When you enter a number, the cursor (|) blinks in the display and indicates you are in number entry mode.

## Two Line Display

There are two lines in the display screen as shown in Figure 1.









Figure 1 Display Screen














The top line of the screen displays operation status, operator symbols, annunciators, and abbreviations of the variables and menu names. Throughout this manual, this line is referred to as the *top line*. In Figure 1, **SIN** is on the top line. The bottom line displays numbers you have entered, or results. Throughout this manual, this line is referred to as the *bottom line*.

When no operations have been entered and no operations are pending, the bottom line of the screen displays **0.00**. This state of the calculator is referred to as the *default calculator screen*.




## The Mode Menu: Setting Preferences

The Mode menu allows you to customize the calculator. To access the Mode menu, press  . Press  or  repeatedly to scroll through the menu starting with **FIX=2** (the number of digits displayed to the right of the decimal point). Once an item is displayed, press  to cycle through the other options for that setting. To exit the Mode menu, press . Table 1-1 lists the items in the Mode menu.

**Table 1-1 Mode Menu Settings**

Setting (top line)	Description
<b>FIX= 2</b>	<p>Display precision (number of digits displayed to the right of the decimal point). Default is <b>2</b>.</p> <p>Key in the number of digits you want and press , or press  until the number of digits you want is displayed.</p> <p>The display precision can be any number from 0-11. If you specify -1, the calculator displays numbers with the most appropriate number of digits after the decimal point.</p> <p>If you find you need to change the <b>FIX</b> setting often, use the following shortcut:</p> <ol style="list-style-type: none"> <li>1. Press  and release it. Check that the secondary function indicator is displayed.</li> <li>2. Press  again, and, without releasing it, press a key,  through  that corresponds to the desired <b>FIX</b> setting. <b>FIX</b> settings for 10 and 11 are not available using this shortcut. If you press  instead of a numbered key, <b>FIX= -1</b> is selected.</li> </ol>
<b>Degree or Radian</b>	<p>Angular mode in degrees or radians for trigonometric functions. Default is <b>Degree</b>.</p> <p>Pressing  toggles between these options.</p>
<b>Date:</b> <b>mm.ddyyyy</b> or <b>dd.mmyyyy</b>	<p>Format for dates. December 3, 2010 is entered as <b>12.032010</b> in <b>mm.ddyyyy</b> format, or <b>3.122010</b> in <b>dd.mmyyyy</b> format. Note the (.) in both formats separating the first and second groups. The valid range of dates is October 15, 1582 to December 31, 9999. Default is <b>mm.ddyyyy</b> format.</p> <p>Pressing  toggles between these options.</p> <p>Note that when a date is displayed, a number between <b>1</b> and <b>7</b> also displays at the right of the screen. This number indicates the day of the week corresponding to that date. Monday is <i>1</i>, and Sunday is <i>7</i>.</p> <p>NOTE: in 360-day calendar mode (<b>Cal.360</b>), days of the week are displayed only if the date is valid.</p>
<b>1.23</b> or <b>1,23</b>	<p>Selects point or comma as decimal separator. Default is decimal point, <b>1.23</b>.</p> <p>Pressing  toggles between these options.</p>
<b>1000.00, 1,000.00,</b> <b>1000,00</b> or <b>1.000,00</b>	<p>Selects thousands separator. Default is none, <b>1000.00</b></p> <p>Pressing  toggles between these options.</p> <p>NOTE: the 1000.00 and 1,000.00 options are only available if the decimal separator is set for point (.); 1000,00 and 1.000,00 are available only if the decimal separator is set for comma (,).</p>
<b>Chain, Algebraic,</b> or <b>RPN</b>	<p>Calculation mode. For more information, refer to Chapter 2, <i>Mathematical Calculations</i>.</p> <p>Pressing  cycles through these options.</p>
<b>English, Français,</b> <b>Deutsch,</b> or <b>Español</b>	<p>Language setting for the messages displayed on the screen. Default is <b>English</b>.</p> <p>Pressing  cycles through these options.</p>










**Table 1-1 Mode Menu Settings**

Setting (top line)	Description
<b>Actual</b> or <b>Cal.360</b>	Calendar options for bonds and date calculations. Default is <b>Actual</b> . Pressing  toggles between these options.
<b>Annual</b> or <b>Semiannual</b>	Bond type. Default is <b>Annual</b> . Pressing  toggles between these options.
<b>TVM Standard</b> or <b>TVM Canada</b>	Activate or deactivate the compounding per year ( <b>C/YR</b> ) option in time value of money ( <b>TVM</b> ) calculations. This option is primarily used for Canadian mortgage calculations. See Chapter 4, <i>Canadian Mortgages: TVM Canada</i> for more information. Pressing  toggles between these options.

## Changing the Calculation Mode

After viewing the default settings, suppose you want to change the calculation mode from **Chain** to **RPN**. See Table 1-2.



**Table 1-2 Changing the Calculation Mode**

Keys	Display	Description
 		Opens the Mode menu, starting with first setting option, <b>FIX</b> , the number of digits displayed to the right of the decimal point.
 (Press five times)		Scrolls to the current setting for the calculation mode, <b>Chain</b> .
 (Press two times)		Selects <b>RPN</b> as the active setting. Note the <b>RPN</b> annunciator to the right.
		Exits the Mode menu and returns you to the default calculator screen.

## Key Presses, the Shift Key, Secondary, and Tertiary Functions\*

To execute the function associated with a key, press and release the desired key. However, most of the calculators' keys have more than one function: the first, or primary function, the shifted, or secondary function, and, in some cases, a third, or tertiary function (see Figure 2).

\* Tertiary functions do not apply to the HP 20b.

- The primary function is printed on the top of the key.
- The secondary function is printed on the bevel of the key. To activate the secondary function of a key, press and release  followed by the key with the secondary function printed on the bevel.
- The third, or tertiary functions are printed above specific keys on the keyboard. To activate the tertiary function of a key, press and hold  and simultaneously press the key below the printed function. Release both keys.

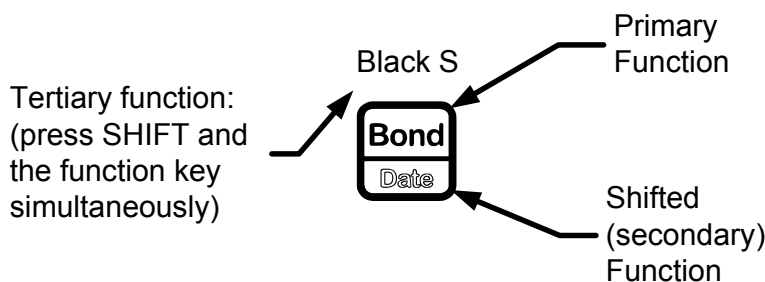











Figure 2 Primary, Secondary, and Tertiary Key Functions

In this manual, key symbols of the commands are provided throughout the manual so you can follow along with the examples.

- The primary functions are represented by the key symbol with the primary function.
- The secondary key functions are represented by the shift key symbol, , followed by the key with the secondary function. For example, to execute sine, press  . Note how the **SIN** portion of the key is highlighted, while the **7** is grayed out. This highlighting focuses on the function of the key that will be activated in a given command.
- Commands with a tertiary function are represented by the shift key symbol, , followed by the term (HOLD), followed by the key with the tertiary function. For example, to activate the Black-Scholes feature shown above, press  (HOLD) \*.

When  is active, the down arrow annunciator appears on screen, indicating that the next key pressed will execute the secondary function of the key. To cancel an accidental press of , simply press  a second time.

Key commands for example problems are provided throughout the text and in tables. Key symbols are placed in the order they are to be pressed, from left to right.

\* Does not apply to the HP 20b.

# Annunciators

Annunciators are symbols that appear in the display as messages, or after certain keys or key combinations have been pressed. Annunciators are special symbols indicating a specific status in the calculator. Figure 3 illustrates the annunciator symbols in the display.

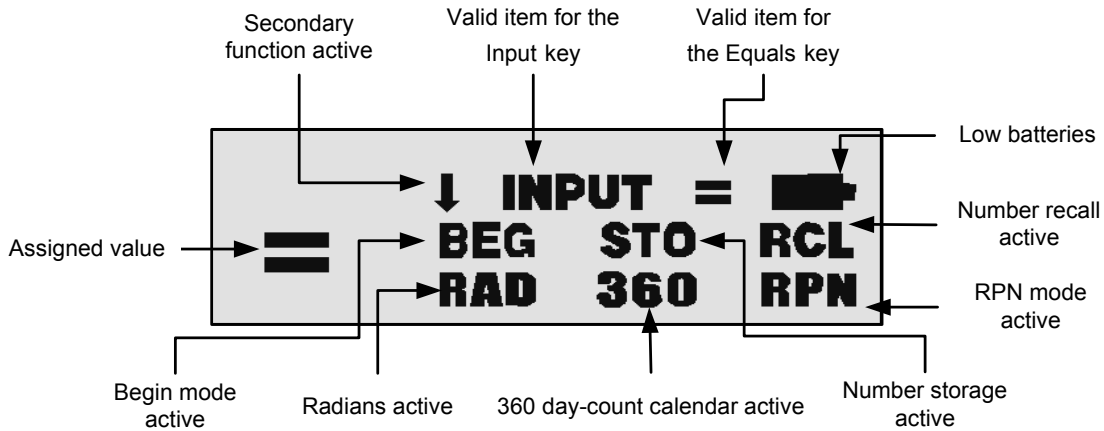








Figure 3 Annunciator Symbols in the Screen Display


## The Input Key

The  key is used to input values for variables and execute menu items.

The  key is also used in Reverse Polish Notation (RPN) mode to enter a number on the stack or duplicate it.



## The Equals Key

The  key is used at the end of a mathematical operation to calculate the final result. For example,      returns a final result of **3**.

The  key, when pressed outside of a mathematical operation, also allows you to request a calculation for the value of an item. This request only applies to items that can be calculated.

## Using the Input and Equals Keys

Suppose you wanted to calculate the effective interest rate for a 12% nominal interest rate with 12 payments per year in the Interest Conversion (IConv) menu. To open the IConv menu, press

  . **Nom %=** displays on the top line, and the current value assigned to the nominal

interest rate is displayed on the bottom line. With this screen displayed, press








   to input a new value for the nominal rate. Press  followed by  to calculate the value for the effective rate. See Figure 4.




Figure 4


When an item for which the  key is valid displays, the small annunciator (=) is displayed on the top line at the right of the screen. Do not confuse this small annunciator (=) with the larger annunciator (=) found to the right of a variable.

When an item for which the  key is valid displays, the **INPUT** annunciator is displayed on the top line at the right of the screen.

## Editing and Clearing Entries














### The On/CE Key

Pressing  one time cancels current number entries, mathematical operations, or a menu selection, in that order.

Pressing  repeatedly when performing multiple operations cancels one operation at a time, from the latest to the earliest.


### The Reset Menu

The Reset menu allows you to reset some, or all, of the menu items, variables, and registers to their default values.





To open the Reset menu, press  . **TVM** displays on the top line. Press  or  repeatedly to scroll to a specific item. To validate a choice and reset the selected items, press . Press  to cancel. If you select the command to reset the cash flow (**Cash Flow**), statistics (**Stats**), programs (**Prgm**)\* or all values (**All**) items, you will be prompted to confirm your choice. At the **Del. All?**, **Del. Data?**, **Del. Prgm?\***, and **Del. CF?** prompts, press  again to confirm the reset, or  to cancel. While working within a specific menu, pressing   takes you directly to the item of the Reset menu that allows you to reset that specific menu. For example, if you are working in the Bond menu and you wish to reset all your entries in the Bond menu, with any item of the Bond menu displayed, press  . **Bond** displays on screen. At this prompt, pressing  resets the Bond menu and returns you to the last item you were working with in the Bond menu.


\* Only applies to the HP 30b.

## Notes about Special Menus

The Mode, Memory, Math and Reset menus are unique menus; they allow you to work in another menu simultaneously without having to exit. For example, if you were working in the Bond menu prior to entering one of these menus, pressing  to exit returns you to your previous work in the Bond menu.

## Memory and the Memory Menu




The Memory menu contains the following items: memories 1–9 (**Mem 1–9**) and 0 (**Mem 0**), **Cash Flow**, Statistics (**Stats**), programs (**Prgm**)\*, and **Memory**. To enter the menu, press  . Press  or  repeatedly to scroll through the items starting with memory 1 (**Mem 1**).

When a memory item is displayed, you can key in a new number and modify the value of the memory by pressing .


For more information about storing and recalling numbers, refer to the section titled, *Storing and Recalling Numbers* in Chapter 2.

The Cash Flow and Statistics data share the same memory and are limited to a combined total of 50 memory slots. The number displayed with **Memory** refers to the number of remaining memory slots. When the cash flow or statistics items are displayed, a number also appears on the bottom line. This number indicates the number of memory slots used by the cash flow or statistical data.

290 bytes are available for programs. The **Prgm**\* menu item displays the number of bytes used.

Press  on the **Cash Flow**, **Statistic**, or **Prgm**\* menu item to erase the associated data. Since entering data in these menus can represent a significant amount of work, you will be asked to confirm your choice. At the **Del.Data?**, **Del. Prgm?\***, or **Del.CF?** prompts, press  to confirm, or  to cancel.





## Accessing Menus and Menu Maps

Many of the calculator's functions are located within menus. To access a menu, press the key, or secondary-function, key combination for the menu in which you wish to work. To exit a menu, press .

For example, to access the Break-even menu, press  .

\* Only applies to the HP 30b.



Once opened, you can scroll through the items in the menu by pressing  or  repeatedly. In most menus, when you arrive at the last item in a menu, pressing  returns you to the first item. Similarly, pressing  once on the first menu item scrolls to the last item in the menu.

Most items consist of two parts: a name and an associated number. For example, the **Fixed** item in the Break-even menu (Figure 7) is displayed in Figure 5.



Figure 5













The large (=) annunciator shows that the value assigned to **Fixed** is **120,000**. For example, if you perform a calculation with the operating mode set to RPN with this item displayed by pressing    , **Fixed** is still selected as the current item, but the large (=) annunciator is now turned off, indicating that the **3** is not the value assigned to **Fixed** (see Figure 6).



Figure 6

At this point, to return to the display of the **Fixed** menu item shown in Figure 5, press .

Some menus have sub-menus. If an item represents a sub-menu, pressing  with that menu item displayed opens the sub-menu. Once the menu sub-menu is open, use  and  to navigate through the items of the sub-menu, unless otherwise directed.

In this manual, diagrams called *Menu Maps* are included at the beginning of each section to assist you with navigating through the menus described in that section. For an example of a menu map, see Figure 7 below. Once opened, use the  and  keys to navigate through the menu items of the Break-even menu. The downward arrows in the map indicate you press  to scroll to the next item. If a press of the  key is required to open a sub-menu, the word *INPUT* appears in the arrow(s). For examples of menu maps with sub-menus, see chapters 10-12. The return arrows direct you to the next item displayed after the last item in a menu. For example, in Figure 7, pressing  on the last item in the menu returns you to the *FIXED* item.

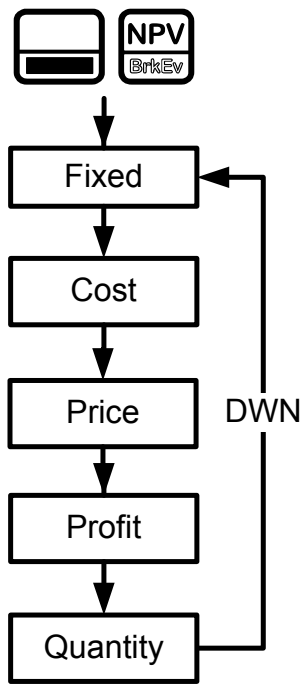







Figure 7 Menu Map of the Break-even menu









There are four types of menu items:

1. **Read/write.** Read/write menu items, such as **Fixed** in the Break-even menu shown above, are easily recognizable, because when they are selected, both the **INPUT** and small (=) annunciators are lit. When lit, these annunciators indicate that keying in a number and pressing  will store the entered number in the displayed menu item. Pressing  (outside of a mathematical operation) calculates the value for that item based on available data.
2. **Read-only.** Read-only items such as Internal Rate of Return (**IRR%**) in the IRR menu are display-only; they are values computed internally by the calculator.
3. **Write-only.** Write-only items, such as investment interest rate (**Inv. I%**) in the Net Present Value (NPV) menu, are similar to read/write items in that the **INPUT** annunciator is lit when these items are selected, indicating that keying in a number and pressing  stores that number in that menu item. However, the  key does not calculate a value for that item.
4. **Special items.** Special items, such as the **Degree/Radian** option in the Mode menu, the items of the Reset menu, and the items of the Percent Calculation (**%calc**) menu perform an action when  is pressed. Depending on the menu, this action can be the selection of a sub-menu (**%calc**), changing a mode or setting (Mode menu), or erasing data (Reset menu)

## 2 Mathematical Calculations







### Mathematical Functions

Mathematical functions are located:

- On keys, such as,    , etc.
- On shifted, or secondary functions, such as,  
- In the Math menu,  

### Number Entry and Display

Numbers are entered by pressing:

- Numbered keys,  
- The decimal point 
- The  key
- The   keys

To correct a number entry, press the backspace key, . Each press of  erases the last digit or symbol you entered.

To enter a number in the display, press the number digits successively. A number can have up to 12 digits.

To change the sign of a number from positive to negative, press .

Use scientific notation to enter very large and very small numbers. For example, to enter the number  $1.23 \times 10^{127}$  in scientific notation, first enter the mantissa (**1.23**) and then press



  and enter the number (**127**) representing the exponent. The exponent must have a value between  $-499$  and  $+499$ . If an expression has more than 12 digits, or if an operation returns a result with more than 12 digits, the calculator automatically displays scientific notation.



Figure 1 Scientific Notation in FIX=2 Mode

## Chain Mode

Calculations in Chain mode are interpreted in the order in which they are entered. For example, entering the following numbers and operations as written from left to right,

$\left[ \frac{1}{\text{RAND}} \right] \left[ \frac{+}{\text{RND}} \right] \left[ \frac{2}{!} \right] \left[ \frac{x}{\sqrt{}} \right] \left[ \frac{3}{y^x} \right] \left[ \frac{=}{\text{ANS}} \right]$ , returns **9**. See Figure 2.

A rectangular box representing a calculator display with the number 9.00 in a digital font.

Figure 2 Calculation in Chain Mode


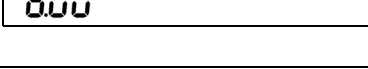

NOTE: if you press an operator key,  $\left[ \frac{+}{\text{RND}} \right] \left[ \frac{-}{1/x} \right] \left[ \frac{x}{\sqrt{}} \right] \left[ \frac{\div}{\text{Math}} \right]$ , after  $\left[ \frac{=}{\text{ANS}} \right]$ , the calculation is continued using the currently displayed value.

In Chain mode, if you wish to override the left to right order of entry, use parentheses

$\left[ \frac{(}{\text{Mode}} \right] \left[ \frac{)}{x} \right]$  to prioritize operations.

For example, to calculate  $1 + (2 \times 3)$ , you may enter the problem as written from left to right, with parentheses to prioritize the multiplication operation. See Table 2-1 below.

Table 2-1 Simple Arithmetic Calculations in Chain Mode

Keys	Display	Description
$\left[ \frac{1}{\text{RAND}} \right] \left[ \frac{+}{\text{RND}} \right]$		Sets operational priority, inputs numbers, and multiplies 2 and 3.
$\left[ \frac{(}{\text{Mode}} \right] \left[ \frac{2}{!} \right] \left[ \frac{x}{\sqrt{}} \right] \left[ \frac{3}{y^x} \right] \left[ \frac{)}{x} \right]$		
$\left[ \frac{=}{\text{ANS}} \right]$		Adds 1 to 6 and returns <b>7.00</b> on the bottom line as the final result.

## Algebraic Mode

To set the calculator in Algebraic mode, refer to the section titled, *The Mode Menu: Setting Preferences* in Chapter 1.

In Algebraic mode, multiplication and division have a higher priority than addition and subtraction.

For example, in Algebraic mode, pressing  $\left[ \frac{1}{\text{RAND}} \right] \left[ \frac{+}{\text{RND}} \right] \left[ \frac{2}{!} \right] \left[ \frac{x}{\sqrt{}} \right] \left[ \frac{3}{y^x} \right] \left[ \frac{=}{\text{ANS}} \right]$  returns a result of **7.00**. In Chain mode, the same key presses return a result of **9.00**.

In Algebraic mode, operations between two numbers have the following priority:

- Highest priority: the power function ( $y^x$ )
- Second priority: combinations and permutations
- Third priority: multiplication and division
- Lowest priority: addition and subtraction

For example, key in  $1 + 2 \times 5 \text{ nPr } 2^2$  in Algebraic mode by pressing:

. The result is 241.

NOTE: the calculator is limited to 12 pending operations. An operation is pending when it is waiting for the input of a number or the result of an operation of higher priority.

## Reverse Polish Notation (RPN) Mode

To set the calculator in RPN mode, refer to the section titled, *The Mode Menu: Setting Preferences* in Chapter 1. In RPN mode, numbers are keyed in first, separated by pressing

or , followed by an operation key.

NOTE: pressing or is optional after keying in a number, if the next key pressed is an operation.

Each time you press an operation or function key in RPN, the answer is calculated immediately and displayed. For example, suppose you wanted to add two numbers in RPN, 1 and 2. Press

. The result, **3.00**, is calculated and displayed immediately on the bottom line along with the (+) symbol on the top line.


NOTE: in RPN mode, when you are in a menu for which or are valid, pressing these keys enters the number, but it also performs the action associated with the key for the menu item, which is generally saving the number in the variable or calculating the item's value.


## The RPN Stack


RPN works by placing numbers in storage registers called the *stack*. The RPN stack has four levels numbered 1–4. The levels are stacked on top of one another. See Figure 3.

Stack Level 4	-15
Stack Level 3	12
Stack Level 2	41
Stack Level 1	23

Figure 3 The RPN Stack

In Figure 3, the stack contains four numbers, 23, 41, 12, and -15. Each level (1– 4) contains one number. When a number is typed and entered into the stack by pressing , this new number is "pushed" into level one of the stack, and each number already in the stack moves up one level. The number in Level 4, -15, is pushed out and is lost.

When an operation is performed on the stack, addition () for instance, the calculator "pops" or moves the two numbers from the bottom levels (Levels 1 and 2) out of the stack, performs the operation, and "pushes" the results back into the stack.

With the numbers entered into the stack as shown in Figure 3, pressing  changes the stack as shown in Figure 4. Note that when the numbers are "popped" out to add 23 and 41, Level 4 of the stack remains unchanged.

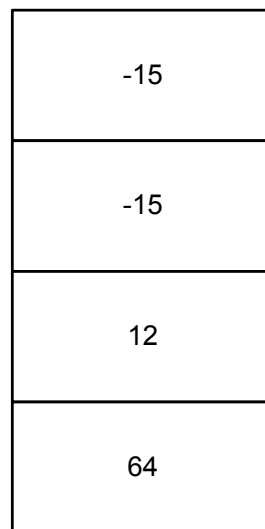



Figure 4 The RPN Stack of Figure 3 Shown After the Addition Operation

## Last Number

Each time you perform a mathematical operation, the content of Level 1 of the stack is saved. Pressing  recalls that number. This functionality can be used to undo an erroneous key press, or if you want to reuse a number, such as 56.123 in the expression:

$$\frac{(1.23 + 56.123)}{(56.123)}$$

See Table 2-2 for an example using the *last number* function.

Table 2-2 Last Number

Keys	Display	Description
		Sets <b>FIX=</b> to <b>3.000</b>
		Selects <b>RPN</b> as the operating mode.
		Inputs <b>1.23</b> and <b>56.123</b>
		Adds 1.23 and 56.123, then divides the sum by the last number, 56.123. Returns results in the selected display format.

For more complex problems requiring two or more operations, you do not need to enter parentheses to set operational priority. Key in numbers and operations inside the parentheses first, followed by those outside of the parentheses. If a problem has more than one set of parentheses, start by working with the operations and numbers in the innermost parentheses and work out. For example, calculate:

$$(3 + 4) \times (5 + 6)$$

One way to calculate this problem is to key in the numbers and operations within the parentheses first, followed by the operation outside of the parentheses. See Table 2-3.

Table 2-3 Simple Arithmetic Calculations in RPN Mode

Keys	Display	Description	RPN Stack
<div style="display: flex; justify-content: space-around; align-items: center;"> <div style="border: 1px solid black; padding: 2px; margin: 2px;">3 y<sup>x</sup></div> <div style="border: 1px solid black; padding: 2px; margin: 2px;">INPUT Memory</div> <div style="border: 1px solid black; padding: 2px; margin: 2px;">4 LN</div> </div> <div style="margin-top: 5px; display: flex; justify-content: center;"> <div style="border: 1px solid black; padding: 2px; margin: 0 5px;">+</div> <div style="border: 1px solid black; padding: 2px; margin: 0 5px;">RND</div> </div>	<div style="border: 1px solid black; padding: 5px; width: 150px; margin: 0 auto;">           + 7.00         </div>	<p>Inputs the numbers and the operation in the first set of parentheses. Intermediate results are displayed. Note the (+) and (RPN) annunciators.</p>	<div style="border: 1px solid black; padding: 2px; margin-bottom: 2px;">Previous Value</div> <div style="border: 1px solid black; padding: 2px; margin-bottom: 2px;">Previous Value</div> <div style="border: 1px solid black; padding: 2px; margin-bottom: 2px;">Previous Value</div> <div style="border: 1px solid black; padding: 2px; margin-bottom: 2px;">7</div>
<div style="display: flex; justify-content: space-around; align-items: center;"> <div style="border: 1px solid black; padding: 2px; margin: 2px;">5 e<sup>x</sup></div> <div style="border: 1px solid black; padding: 2px; margin: 2px;">INPUT Memory</div> <div style="border: 1px solid black; padding: 2px; margin: 2px;">6 x<sup>2</sup></div> </div> <div style="margin-top: 5px; display: flex; justify-content: center;"> <div style="border: 1px solid black; padding: 2px; margin: 0 5px;">+</div> <div style="border: 1px solid black; padding: 2px; margin: 0 5px;">RND</div> </div>	<div style="border: 1px solid black; padding: 5px; width: 150px; margin: 0 auto;">           + 1.00         </div>	<p>Inputs the numbers and the operation in the second set of parentheses. Intermediate results are displayed. Note the (+) annunciator.</p>	<div style="border: 1px solid black; padding: 2px; margin-bottom: 2px;">Previous Value</div> <div style="border: 1px solid black; padding: 2px; margin-bottom: 2px;">Previous Value</div> <div style="border: 1px solid black; padding: 2px; margin-bottom: 2px;">7</div> <div style="border: 1px solid black; padding: 2px; margin-bottom: 2px;">11</div>
<div style="border: 1px solid black; padding: 2px; margin: 5px auto; width: 40px; text-align: center;">           x √         </div>	<div style="border: 1px solid black; padding: 5px; width: 150px; margin: 0 auto;">           * 77.00         </div>	<p>Finishes the operation and displays the results.</p>	<div style="border: 1px solid black; padding: 2px; margin-bottom: 2px;">Previous Value</div> <div style="border: 1px solid black; padding: 2px; margin-bottom: 2px;">Previous Value</div> <div style="border: 1px solid black; padding: 2px; margin-bottom: 2px;">Previous Value</div> <div style="border: 1px solid black; padding: 2px; margin-bottom: 2px;">77</div>

Pressing INPUT  
Memory or =  
ANS when you are not entering a number duplicates the number on Level 1. That is, the number on Level 1 is pushed on the stack, making Levels 1 and 2 equal. In the example above, pressing INPUT  
Memory after x  
√ duplicates **77** on the stack, making Levels 1 and 2 equal. See Figure 5.



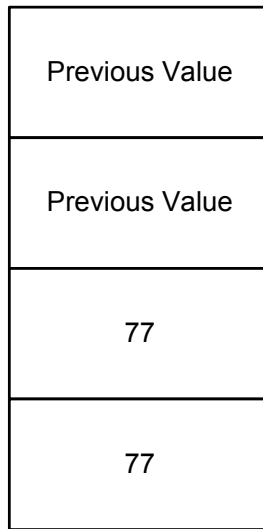


Figure 5 Duplicating a Number on the Stack

In RPN, the parentheses keys  $\boxed{\downarrow}$  and  $\boxed{\times}$  manipulate the stack. Pressing  $\boxed{\downarrow}$  performs a *roll down* of the stack. A roll down causes the stack to *roll* towards the bottom of the stack, during which the number in Level 2 to moves down to Level 1, the number in Level 3 to moves down to Level 2, the number in Level 4 to moves down to Level 3, and the number of Level 1 to moves up to Level 4. The  $\boxed{\downarrow}$  key has a small down arrow on it to indicate the roll down feature. With the numbers entered into the stack shown in the left column in Figure 6, pressing  $\boxed{\downarrow}$  performs the roll down of the stack shown in the right column.

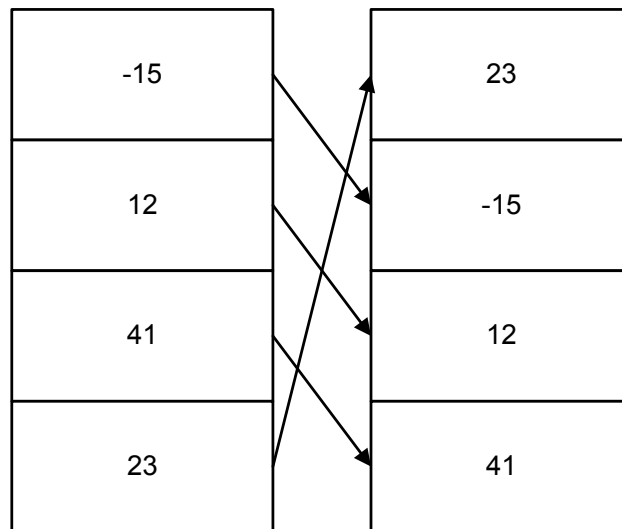


Figure 6 The RPN Stack and the Roll Down Operation

Pressing  $\boxed{\text{)x}}_{\text{PRGM}}$  performs a *swap*. A swap operation exchanges the numbers on Levels 1 and 2 of the stack. The  $\boxed{\text{)x}}_{\text{PRGM}}$  key has a small symbol to the right of the parenthesis symbol to indicate the swap feature. With the numbers entered into the stack shown in the left column in Figure 7, pressing  $\boxed{\text{)x}}_{\text{PRGM}}$  performs a swap to the stack as shown in the right column.

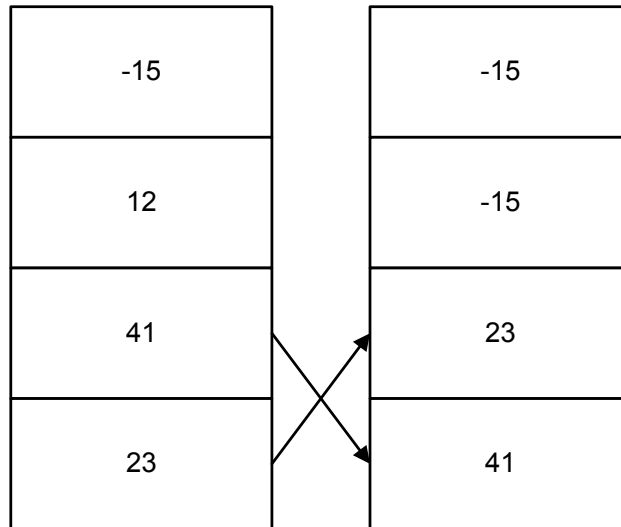


Figure 7 The RPN Stack and the Swap Operation

NOTE: when no menu is selected, the  $\boxed{\text{)x}}_{\text{PRGM}}$  key performs the same function as the  $\boxed{\text{)x}}_{\text{PRGM}}$  key. The  $\boxed{\text{)x}}_{\text{PRGM}}$  key performs the inverse operation called, *roll up*.

























## One-Number Functions and the Math Menu

The key presses for the one-number mathematical functions listed in Table 2-4 below apply to all modes, Chain, Algebraic, and RPN. To execute one-number functions, with a number displayed, press the key or key combination corresponding to the operation you wish to execute. The result is displayed on the bottom line.

For example, to calculate  $\sqrt{6}$ , press  $\boxed{6} \boxed{\text{)x}}_{\text{PRGM}} \boxed{\sqrt{\quad}}$ . The result of **2.45** is calculated immediately and displayed on the bottom line. Note the square root symbol appears on the top line.





NOTE: before doing any trigonometric calculations in the Math menu, check whether the angle mode is set for degrees (**Degree**) or radians (**Radian**). You will need to change the setting if the active mode is not what your problem requires. For more information on the Mode menu and calculator settings, refer to the section titled, *The Mode Menu: Setting Preferences* in Chapter 1. Table 2-4 lists one-number functions along with their corresponding keys.

Table 2-4 Shifted Function Mathematical Operations

Keys	Description
 	Calculates sine.
 	Calculates cosine.
 	Calculates tangent.
 	Calculates natural log.
 	Calculates natural exponent to the power of $x$ .
 	Calculates square of $x$ .
 	Calculates square root.
 	Executes the <i>Random</i> function. Returns a random number in the range $0 < x < 1$ .
 	Calculates factorial of $x$ (where $-253 < x \leq 253$ ). The Gamma function is used to calculate $x!$ for non-integers or negative numbers.
 	Calculates the reciprocal.
 	In <b>Chain</b> or <b>Algebraic</b> mode, recalls the result of the last operation. In RPN mode, returns the content of the <i>Last Number</i> variable.
 	Rounds $x$ to the number specified by the display format.



## Random number

Press   to generate a randomly distributed number between 0 and 1.

Type a number and press     to store a new seed for random number generation.

## The Math Menu

There are additional functions available in the Math menu. To open the Math menu, press

 . See Figure 8 for the menu map of the Math menu.

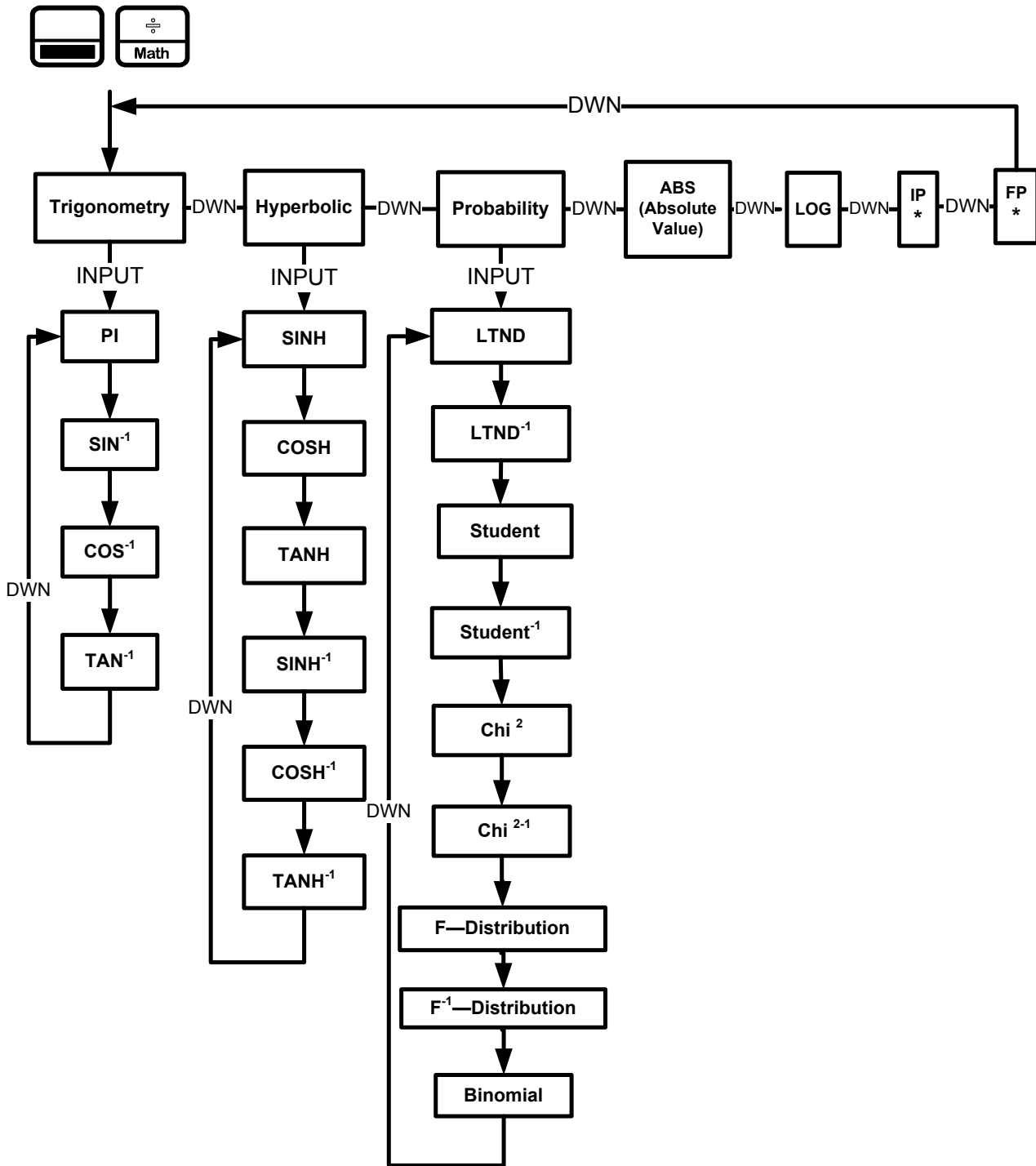







Figure 8 The Menu Map for the Math Menu













Press  to scroll through the menu items, starting with **Trigonometry**. The **Trigonometry**, **Hyperbolic**, and **Probability** items have sub-menus. Press  on any of these items to access the functions within the sub menus. Press  to scroll through the functions.

\* IP and FP functions are not available on the HP 20b.

Press  to cancel the Math menu and return to current work. Press  to return to the top of the Math menu.

For example, using the math menu calculate  $\text{Sin}^{-1}(0.5)$ , see Table 2-5.

**Table 2-5 Math Menu Example**

Keys	Display	Description
    		Enters 0.5 and opens the Math menu starting with <b>Trigonometry</b> .
 		Selects the <b>Trigonometry</b> sub-menu and scrolls to $\text{Sin}^{-1}$ . Note the value for $\text{Sin}^{-1}$ is calculated immediately and displayed.
 or 		Validates the result.

In the Math menu, *PI* does not *perform* calculations; it enters *PI* for calculations. You may start an operation, use the Math menu to execute a function, and continue calculating with your original operation without losing your work.



## The Probability Sub-menu

Lower Tail Normal Distribution (LTND) calculates the probability for a normally distributed, random variable to be less than the input.

Inverse Lower Tail Normal Distribution (LTND<sup>-1</sup>) is the inverse function for LTND; it calculates the value (V) for which the probability of a normally distributed, random variable to be less than V is the given input. Student, Inverse Student, Chi<sup>2</sup> ( $\chi^2$ ), Inverse Chi<sup>2</sup>, F-Distribution and Inverse F-Distribution perform similar operations for Student, Chi<sup>2</sup>, and F-Distributions.

Student, Chi<sup>2</sup>, and F-Distribution and their inverse operations are special cases, as they require more than one number as input. Student and Chi<sup>2</sup> require (N), the number of degrees of freedom, and F-Distribution requires (N1) and (N2), two degrees of freedom.

To perform Student and Chi<sup>2</sup> operations or their inverse:

1. Enter the number of degree(s) of freedom by typing the number and pressing  or .
2. Type the number for which you want to calculate the probability, or, for the inverse, the probability for which you want the number.
3. Navigate to the appropriate function in the Probability sub-menu of the Math menu.

To perform F-Distribution operations or their inverse:



1. Enter the two degrees of freedom by typing each number followed by  or .
2. Type the number for which you want to calculate the probability, or, for the inverse, the probability for which you want the number.
3. Navigate to the appropriate function in the Probability sub-menu of the Math menu. See Table 2-6. Note: the examples below are calculated with **Chain** set as the operating mode.

Table 2-6 Probability Example









































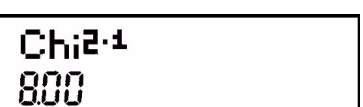




Keys	Display	Description
      		Enters 10 degrees of freedom and the number for which probability is to be calculated. Opens the Math menu.
      		Selects the <b>Probability</b> menu item and scrolls to <b>Chi<sup>2</sup></b> .
 or 		Validates the result.





Table 2-7 Inverse Probability Example

Keys	Display	Description
           		Enters 10 degrees of freedom and the probability. Opens the Math menu.
       		Selects the <b>Probability</b> menu item. Scrolls to <b>Chi<sup>2-1</sup></b> .
 or 		Validates the result.

## Binomial Functions

The binomial function calculates the probability of having up to  $k$  successes out of  $n$  throws, when the probability of success is  $p$ . Enter  $n$  and  $p$  each followed by  and type  $k$  and navigate to the binomial function in the math menu.

## Two-Number Functions

Apart from    , the three additional two-number functions accessible on the keyboard are:

- $y^x$
- $nCr$
- $nPr$

$y^x$  is the power function,  $nCr$  stands for the number of combinations of  $n$  items taken  $r$  at a time, and  $nPr$  stands for the number of permutations of  $n$  items taken  $r$  at a time.







$$\text{Combination} = \frac{n!}{r!(n-r)!}$$

$$\text{Permutation} = \frac{n!}{(n-r)!}$$

Perform calculations with these functions in the same way you would perform calculations with

   and , but press  to access the secondary function key. For

example, to calculate  $15^3$ :

1. Press  .
2. Press  .
3. Press  . The result is shown in Figure 9.

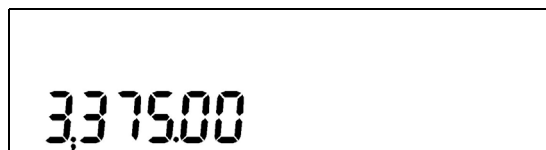











Figure 9

In RPN mode, key in the numbers first, followed by , then press the function key. For example, for the power function example above, in RPN press:

     .













## Storing and Recalling Numbers





The calculator has ten memories available for use during calculations. These memories are numbered from 1–9 and 0. To store a number in a memory, press  , followed by the key representing the memory number. To recall a number stored in a memory, press  followed by the key representing the memory number. You can use the store and recall functions for these memories any time a number is displayed, or when you wish to enter a number.






For example, to store **15** in memory 1, press     .

To recall the number in memory 1, press  .




You can also perform operations to numbers stored in memories. For example, press

    to store **5** in memory 2. To add **12** to the value of memory 2, press      . Later on, during a calculation, you can press   to recall memory 2. Note how the current value now stored in memory 2 is **17**, (5 + 12).

   and  are valid mathematical operations for memories.



To view the stored values in memories 1–9 and 0, press  , followed by  or  repeatedly to scroll through each memory starting with memory 1 (**Mem 1**). Note that in the Memory menu, you can change the value of any memory by selecting the memory and typing a number followed by the  key.


## Recall Arithmetic


In RPN, typing    adds the value of memory 2 to the first level of the stack, but it will not modify the stored value of memory 2. This is useful, as it "saves" one stack level.

You can also use   and  after .

## Storing and Recalling with Time Value of Money (TVM) Keys








To store the current number in the Time Value of Money (TVM) variables, press   followed by the desired TVM key.

To recall the stored value of a TVM variable, press  followed by the key of the desired TVM variable.






Note: pressing  does not calculate the variable; it recalls the current value.






## Recalling a Menu Item Value in a Menu

In a menu, you can recall the current value of a menu item. For example, open the Interest Conversion menu (IConv) by pressing  . With **Nom.%** displayed, pressing      calculates 2 times the nominal rate. This feature is useful when you need to insert the contents of a menu item into an algebraic operation.

## Recalling and Storing Values in the Data and Cash Flow Menus

If you store an index ( $i$ ) from 0 to 99 in the variable 0, you can then use the store/recall features to store a number in the Data and Cash Flow menus. Press either   or  , followed by the CashFlow key , to either store or recall a number, as desired, in the CF( $i/2$ ) (if  $i$  is even) or #CF( $(i-1)/2$ ) if  $i$  is odd.

In addition, you can store or recall  $x(i/2+1)$  if  $i$  is even, or  $y((i+1)/2)$  if  $i$  is odd, as desired, by pressing the Data key   instead of the CashFlow key, , as shown above.






## Rounding Numbers



All calculations are performed internally with 15-digit precision and are rounded to 12 digits when returning the results. In certain instances, calculations are performed internally with greater than 15-digit precision.

When displayed, a number is further rounded to the number of digits after the decimal point set by the **FIX** item in the Mode menu. The default setting is two digits to the right of the decimal point. For more information, refer to the section titled, *The Mode Menu: Setting Preferences* in Chapter 1.









NOTE: the **FIX** setting only affects the display; it does not affect the actual numbers.

## Percentages



In Algebraic or Chain modes, pressing   divides a number by 100. For example, pressing    returns **0.25**.









To find a percentage of a given number, key in the number and multiply it by the desired percentage, followed by  . For example, to find 25% of 200, press

         to return a result of **50**.

To add or subtract a percentage of a number, key in the first number, followed by   or   and the percentage followed by  . Finish your calculation with  .

For example, to add 10% to 50, press           to return a result of **55**.

In RPN mode, the  key calculates  $x\%$  of the number on Level 2 of the stack, when  $x$  is the number on Level 1 of the stack. It does not modify the number on Level 2 of the stack, and thus allows you to perform addition or subtraction after pressing  to add or subtract  $x\%$  from the number.

For example,        returns **50**, but **200** is still on Level 2 of the stack, and pressing  returns **150**, or  $200 - 25\%$ .

### 3 Time Value of Money

The examples in the following sections are calculated with the Mode menu preferences in their default settings, unless otherwise noted. For more information about basic features and setting preferences, see Chapter 1, *Basic Features*.

#### Time Value of Money (TVM) Keys

Cash flow diagrams are useful tools for analyzing financial situations, as they help you identify the TVM functions needed to resolve your problem. A cash flow diagram is a drawing with a set of vertical arrows arranged on a horizontal line. The horizontal line represents the period of time from the beginning of the financing to the end. The vertical arrows represent the money or cash flows at certain times throughout the period. The arrows' length is proportional to the cash flow amount each arrow represents; a longer arrow indicates a larger amount, a shorter arrow, a smaller amount. Each arrow's position on the line represents the time at which the cash flow occurs. The orientation of the arrow, up or down, represents the "direction" of the cash flow: up for money received, down for money paid out. See Figure 1.

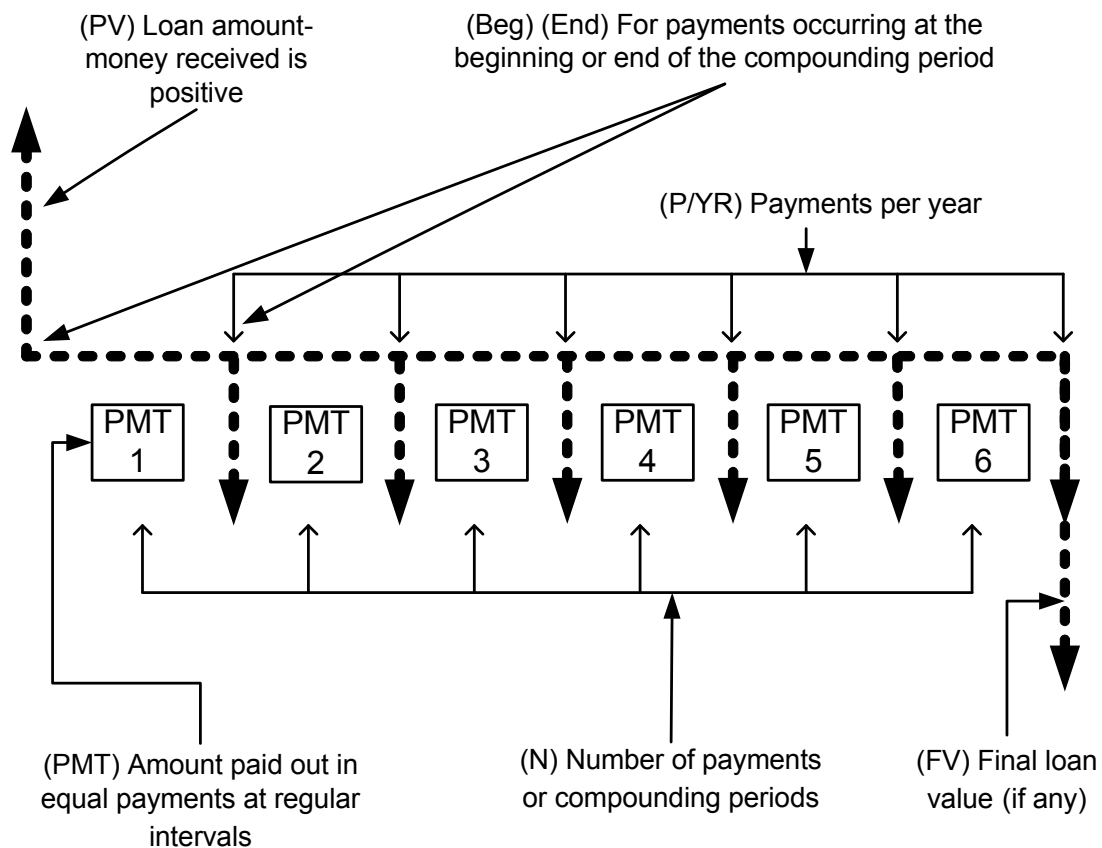















Figure 1 Cash Flow Diagram Example with Corresponding TVM Keys

The TVM functions of the calculator can solve problems with at least one cash flow, and problems in which all the cash flows, except the first and last, are of the same value. To solve other types of cash flows, refer to Chapter 4, *Canadian Mortgages: TVM Canada*, or Chapter 5, *Cash Flows*.

Figure 1 illustrates a cash flow diagram and how the data in the diagram corresponds to the TVM keys. For a complete list of keys used for TVM problems, along with their descriptions, see Table 3-1.

To save values for the TVM variables, enter the desired number, followed by the corresponding TVM key. To calculate an unknown value, enter all known values and press the key of the item you want solved.

**Table 3-1 TVM Keys**

Keys	Description
	Stores or calculates the number of payments or compounding periods.
 	Multiplies a value by the number of payments per year and stores as <b>N</b> .
	Stores or calculates the nominal, annual interest rate.
	Stores or calculates the present value ( <b>PV</b> ). To a lender or borrower, <b>PV</b> is the amount of a loan; to an investor, <b>PV</b> is the initial investment. <b>PV</b> always occurs at the beginning of the first period.
	Stores or calculates the amount of each periodic payment.
 	Stores the number of payments or compounding periods per year. This value is 12 by default, but it maintains its current entered value when TVM Reset is used.
	Stores or calculates the future value ( <b>FV</b> ), a final cash flow. <b>FV</b> always occurs at the end of the last compounding period.
 	Sets Begin mode ( <b>BEG</b> ). Payments occur at the beginning of each compounding period.
 	Sets End mode ( <b>END</b> ). Payments occur at the end of each compounding period.

## Calculating Payments on a Loan

You borrow 140,000.00 for 30 years (360 months) at 6.5% annual interest, compounded monthly. What is your monthly payment to the lender? Note: the following example is calculated with RPN set as the operating mode.

At the end of the 30 years, you expect to have a zero balance (**FV=0**). The example is calculated with **RPN** set as the operating mode

Table 3-2 TVM Example

Keys	Display	Description
		Inputs <b>12</b> as the number of payments per year, or compounding periods per year.
		Inputs <b>360</b> as the number of payments over 30 years.
		Inputs <b>6.5%</b> as the nominal interest rate percentage per year.
		Inputs the present value of the loan at the time of the first payment. This value is positive (+); it is money you receive.
		Inputs <b>0</b> as the future value of the loan (the remaining balance).
		Returns the monthly payment. This result is negative (-); it is money you pay out.

To reset the TVM variables to their default values, press . Press or repeatedly until **TVM** displays. Press to reset the **TVM** values, or press to cancel. Note: the value for P/YR is not reset; it maintains its current entered value when TVM Reset is used.

## Amortization

Refer to Figure 2 for a menu map of the Amortization menu (**Amort**). Table 3-3 lists the keys and variables of the Amortization menu. To open the menu, press . The Amortization menu calculations are based on values stored in the following TVM registers: , , , and .

To enter values for the TVM variables, enter a number followed by the corresponding key. For an amortization example, see Table 3-4.

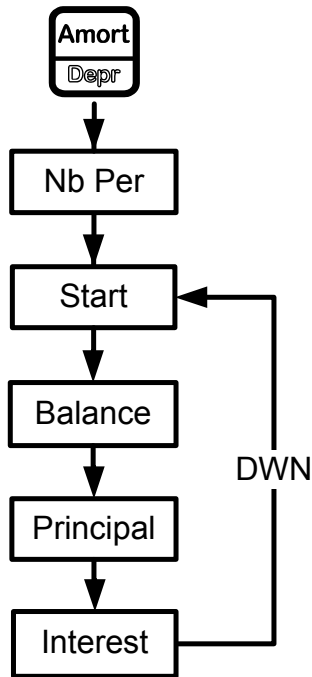


Figure 2 The Menu Map for the Amortization Menu

Table 3-3 Amortization Menu Items

Menu Item/Key	Description
	Opens the Amortization menu ( <b>Amort</b> ).
<b>Nb Period</b>	Number of periods to group together in the amortization calculation. The default value is the number of payments per year defined by the  key.
<b>Start</b>	Period on which to start amortization. Default is <b>1</b> . If you want to amortize for the second year with 12 payments per year, enter <b>13</b> (the second year starts at the 13 <sup>th</sup> payment with 12 payments per year).
<b>Balance</b>	The loan balance at the end of the assigned amortized period.
<b>Principal</b>	Amount of the loan payment applied to the principal at the end of the amortized period.
<b>Interest</b>	Amount of the loan payment applied to the interest at the end of the amortized period.

Enter the values for the TVM keys for the example below. Press followed by or to view the amortization schedule.

## Creating an Amortization Schedule

You borrow 140,000.00 for 360 months at 10% interest. Create an amortization schedule for the loan. How much interest did you pay for the first year? What is the balance of your loan after the first year? See Table 3-4. The example below is calculated with **Chain** set as the operating mode, but it can be performed in RPN, Chain, or Algebraic.

Table 3-4 Amortization Example


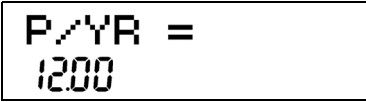



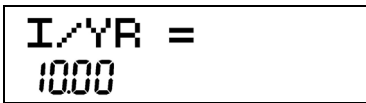





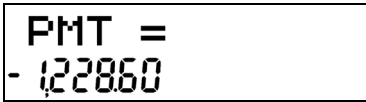



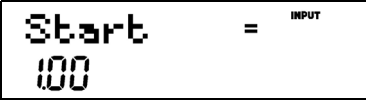

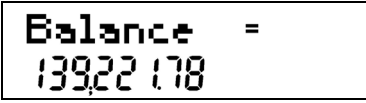





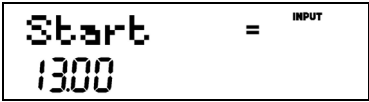





Keys	Display	Description
		Inputs <b>12</b> as the number of payments per year. This value is 12 by default, but it maintains its current entered value when TVM Reset is used.
		Inputs <b>360</b> (30 times 12 payments per year) as the number of payments for the 30-year loan.
		Inputs <b>10</b> as the interest rate percentage per year.
		Inputs the value of the loan at the time of the first payment.
		Inputs <b>0</b> as the future value of the loan (zero balance).
		Calculates the monthly payment.
		Displays the number of periods to group together in the amortization schedule. Default is the current value of <b>P/YR</b> .
		Displays the first period of the group of periods to amortize.
		Displays the current balance remaining after the first year.
		Displays the current amount of the principal applied towards the loan for the first year.

Table 3-4 Amortization Example

Keys	Display	Description
		Displays the amount of interest paid on the loan for the first year. The amount of your payments applied towards interest for the first year is about 14,000.00.
		Displays the first payment in the next period to amortize (the second year). Note that the calculator automatically updates <b>Start</b> to the next group of periods to amortize.

To reset the menu items to their default values, with any item of the Amortization menu displayed press  . With **TVM** displayed, press . At the **TVM** Reset prompt, press  to reset, or  to cancel.



# Interest Conversion Menu

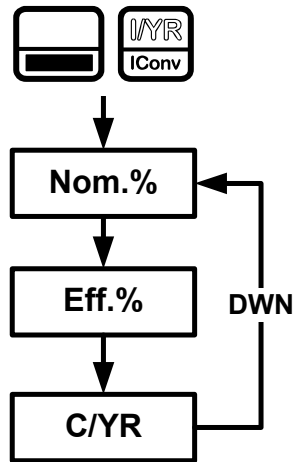




Figure 3 The Menu Map for the Interest Conversion Menu

To open the Interest Conversion menu (**IConv**) press  .










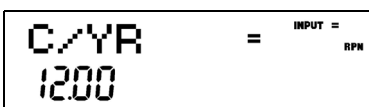




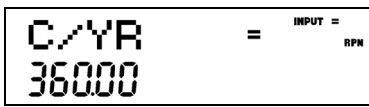



**Table 3-5 Interest Conversion Menu Items**

Item	Description
<b>Nom.%</b>	Nominal interest rate: the stated annual interest rate compounded as represented by <b>C/YR</b> , such as 18% compounded monthly ( <b>C/YR=12</b> ).
<b>Eff.%</b>	Effective annual interest rate taking compounding into account.
<b>C/YR</b>	Compounding periods per year. Default is <b>12</b> .

## Using the Interest Conversion Menu

Find the effective rate of a 36.5% nominal rate compounded daily. See Table 3-6. See Figure 3 for help with navigating through the menu.






**Table 3-6 Interest Rate Conversion Example**

Keys	Display	Description
		Opens the IConv menu, starting with the current value of the nominal percentage rate
    		Inputs <b>36.5</b> as the nominal percentage rate.
		Scrolls to compounding periods per year, <b>C/YR</b> . Default value is <b>12</b> .
   		Inputs <b>360</b> as the value for the number of compounding periods per year.
 		Scrolls to the variable for the effective rate and calculates it. A <b>36.5%</b> nominal rate compounded daily equals an effective rate of <b>44.02%</b> .

Note: in **TVM Standard**, **C/YR** is the same number as **P/YR** in TVM calculations, since most interest calculations are based on the same number of payments and compounding periods per year, and interest rate conversions are commonly linked to a subsequent TVM calculation. This feature is provided for your convenience, but this means modifying one number also modifies the other when you are calculating in **TVM Standard**.

The **IConv** menu permits you to solve for **C/YR**, but the result is not always a positive integer. TVM calculations, however, require **C/YR** to be an integer larger than zero. If you attempt to perform a TVM calculation without a valid value for **C/YR** or **P/YR**, an invalid **P/YR** error (**ER: Invalid P/YR**) will occur.

If you set **C/YR** to **0**, the resulting interest conversions are calculated assuming a continuous compounding. As stated above, **0** is not a valid value for **P/YR** or **C/YR** when used in TVM calculations, and you will have to reset it to a valid value before performing TVM calculations.

To reset the menu items to their default values, with any item of the **Interest Conversion** menu displayed press  . With **IConv** displayed, press  to reset, or  to cancel. To exit the menu, press  once again.

## 4 Canadian Mortgages: TVM Canada

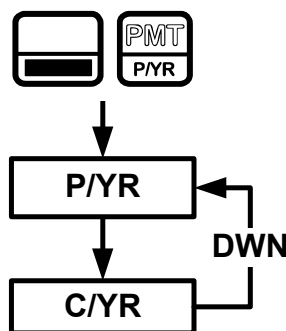




Figure 1 The Menu Map for the P/YR Menu

In Canada, interest rates for mortgages are, by law, given as a nominal interest rate, compounded twice yearly. This means that the compounding period for the per-period interest rate calculation differs from the compounding period when payments are made.

By default, the calculator performs calculations assuming that the number of compounding periods always equals the number of payments per year. You can, however, enable the **TVM Canada** option in the Mode menu, which enables you to select the number of compounding periods per year. For more information, refer to Chapter 1, *Basic Features*.
















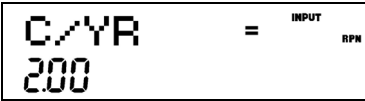
















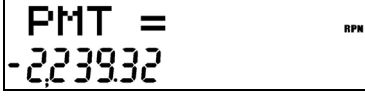
To open the **P/YR** menu, press  . Note the following change in features with **TVM Canada** enabled:







1. The P/YR key opens a menu with two items: **P/YR** and **C/YR** in which you can specify the number of payments and compounding periods per year. See Figure 1.
2. In the Interest Conversion menu, the **C/YR** item is the same value as the **C/YR** item in the **P/YR** menu, and it no longer affects **P/YR**. However, note how if you now change the value of **P/YR**, the calculator automatically sets **C/YR** so it equals your new value assigned to **P/YR**. This means that if you modify **P/YR**, you also need to modify **C/YR**, if **P/YR** and **C/YR** are different values in your TVM problem.

# Canadian Mortgage Example

Calculate the monthly payment for a 25-year (**N=300**) Canadian mortgage valued at 350,000.00, if the nominal interest rate is 6.0%, compounded twice yearly (**C/YR=2**) with 12 payments per year (P/YR). The example is calculated with **RPN** set as the operating mode.

Table 4-1 Canadian Mortgage Example

Keys	Display	Description
 		Opens the Mode menu, starting with the current <b>FIX</b> value (number of digits to the right of the decimal point).
 		Scrolls to TVM mode and sets mode to <b>TVM Canada</b> .
		Returns to default calculator screen.
      		Opens P/YR menu. Inputs 12 for P/YR and 2 for C/YR.
             		Exits menu and inputs values for N, I/YR, and PV.
		Calculates the monthly payment as required by the example.

To reset the menu, press  . With **TVM** displayed, press . At the **TVM Reset** prompt, press  to reset, or  to cancel. To exit the menu, press  once again. With the menu in its default settings, **P/YR** and **C/YR** are both set to 12 payments/compounding periods per year.

## 5 Cash Flows

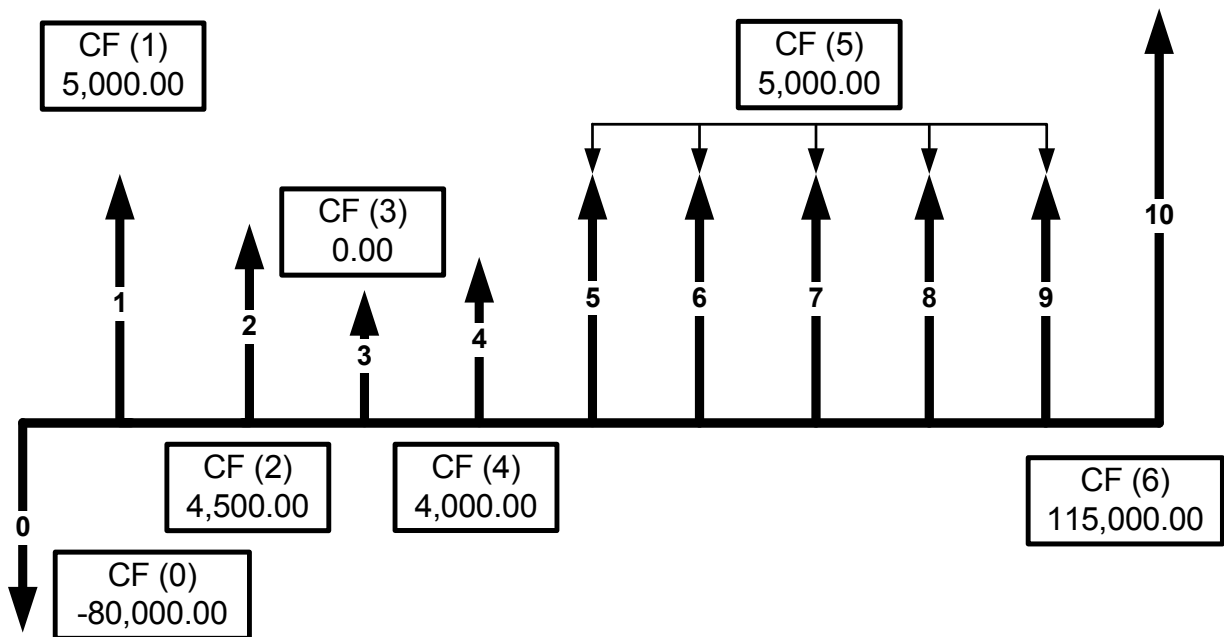








Figure 1 Cash Flow Diagram

In the calculator, a cash flow list is a set of numbered pairs,  $CF(n)$  and  $\#CF(n)$ , where  $n$  is the index of the cash flow list. Each pair represents one or more cash flows in a cash flow diagram. As with TVM problems, it helps to sketch a cash flow diagram as a first step in solving cash flow problems. For some examples of cash flow diagrams, see Figure 3 at the end of this chapter.

$CF(n)$  represents the monetary value of the cash flow;  $\#CF(n)$  is the number of consecutive occurrences of that cash flow. By default,  $\#CF(n)$  is equal to 1, as most cash flows occur only once. However, in cases where a cash flow is repeated multiple times, using  $\#CF(n)$  instead of entering the cash flow value multiple times saves calculation time and memory space in the calculator.

To enter a cash flow list, press  to open the cash flow menu.

For each cash flow item, first enter the monetary value followed by , then enter the number of occurrences followed by .

If a cash flow occurs once, you do not need to type  . Simply press  or  as 1 is the default.














To erase a cash flow list, with any cash flow displayed press  . The number of cash flows in the list is displayed on the bottom line, along with **Cash Flow=**. At this prompt, press . You will be asked to confirm your choice. Either press  to confirm the reset, or  to cancel.

Table 5-1 lists the keys used for cash flow problems. For a cash flow example, see Table 5-2.

**Table 5-1 Cash Flow Keys**

Key	Description
	Opens the cash flow list.
	Inputs new values for variables in the cash flow list, the Net Present Value ( <b>NPV</b> ) menu, and the Internal Rate of Return ( <b>IRR</b> ) menu.
 	Scrolls up and down.
	Inserts cash flows into a cash flow list.
	Removes cash flows from a cash flow list.
 	Opens the Internal Rate of Return ( <b>IRR</b> ) and Net Present Value ( <b>NPV</b> ) menus.



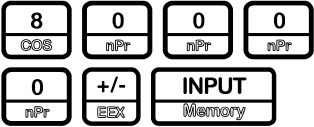




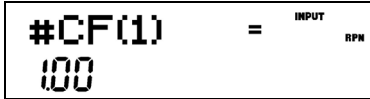

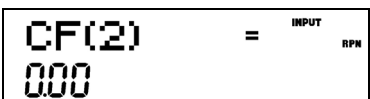
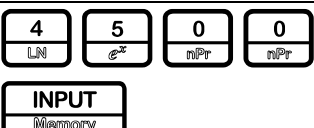
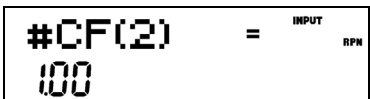

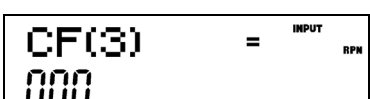

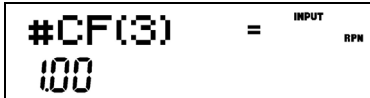

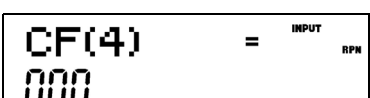
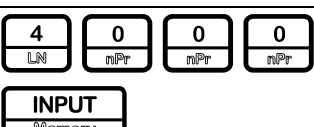
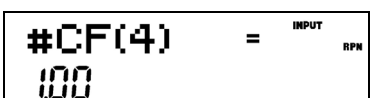


## Cash Flow Example

After an initial investment of 80,000.00, **CF (0)**, you expect returns over the next five years as follows:

Cash Flow Number	Cash Flow Amount	Occurrences
1	5,000.00	1
2	4,500.00	1
3	0.00	1
4	4,000.00	1
5	5,000.00	5
6	115,000.00	1

Given this information, calculate the total of the cash flows and the internal rate of return (**IRR**) of the investment. Calculate net present value (**NPV**) and net future value (**NFV**), assuming an annual investment interest rate of 10.5%. See Figure 1 for the cash flow diagram and Table 5-2 for how to enter the cash flows. The example is calculated with **RPN** as the active operating mode.

Table 5-2 Cash Flow Example





Keys	Display	Description
		Opens the cash flow list.
		Inputs <b>-8000</b> as the monetary value of the initial cash flow. Note: the sign of the cash outflow is negative.
		Accepts <b>1</b> as the number of occurrences for <b>CF(0)</b> . Displays the current monetary value of <b>CF(1)</b> .
		Inputs <b>5000</b> as the monetary value of <b>CF(1)</b> . Displays the current value, <b>1</b> , for the number of times <b>CF(1)</b> occurs.
		Accepts <b>1</b> as the number of occurrences for <b>CF(1)</b> . Displays the current monetary value of <b>CF(2)</b> .
		Inputs <b>4500</b> as the monetary value of <b>CF(2)</b> . Displays the current value, <b>1</b> , for the number of times <b>CF(2)</b> occurs.
		Accepts <b>1</b> as the number of occurrences for <b>CF(2)</b> . Displays the current monetary value of <b>CF(3)</b> .
		Accepts <b>0</b> as the monetary value of <b>CF(3)</b> . Displays the current value, <b>1</b> , for the number of times <b>CF(3)</b> occurs.
		Accepts <b>1</b> as the number of occurrences for <b>CF(3)</b> . Displays the current monetary value of <b>CF(4)</b> .
		Inputs <b>4000</b> as the monetary value of <b>CF(4)</b> . Displays the current value, <b>1</b> , for the number of times <b>CF(4)</b> occurs.
		Accepts <b>1</b> as the number of occurrences for <b>CF(4)</b> . Displays the current monetary value of <b>CF(5)</b> .

**Table 5-2 Cash Flow Example**



Keys	Display	Description
<div style="display: flex; flex-wrap: wrap; gap: 5px;"> <div style="border: 1px solid black; padding: 2px; margin: 2px;">5 <small>e<sup>z</sup></small></div> <div style="border: 1px solid black; padding: 2px; margin: 2px;">0 <small>nPr</small></div> <div style="border: 1px solid black; padding: 2px; margin: 2px;">0 <small>nPr</small></div> <div style="border: 1px solid black; padding: 2px; margin: 2px;">0 <small>nPr</small></div> </div> <div style="border: 1px solid black; padding: 2px; margin-top: 5px; width: fit-content;">INPUT <small>Memory</small></div>	<p>#CF(5) = <small>INPUT</small> 100 <small>RPN</small></p>	Inputs <b>5000</b> as the monetary value of <b>CF(5)</b> . Displays the current value, <b>1</b> , for the number of times <b>CF(5)</b> occurs.
<div style="display: flex; flex-wrap: wrap; gap: 5px;"> <div style="border: 1px solid black; padding: 2px; margin: 2px;">5 <small>e<sup>z</sup></small></div> <div style="border: 1px solid black; padding: 2px; margin: 2px;">INPUT <small>Memory</small></div> </div>	<p>CF(6) = <small>INPUT</small> 000 <small>RPN</small></p>	Inputs <b>5</b> for the number of occurrences for <b>CF(5)</b> . Displays the current monetary value of <b>CF(6)</b> .
<div style="display: flex; flex-wrap: wrap; gap: 5px;"> <div style="border: 1px solid black; padding: 2px; margin: 2px;">1 <small>RAND</small></div> <div style="border: 1px solid black; padding: 2px; margin: 2px;">1 <small>RAND</small></div> <div style="border: 1px solid black; padding: 2px; margin: 2px;">5 <small>e<sup>z</sup></small></div> <div style="border: 1px solid black; padding: 2px; margin: 2px;">0 <small>nPr</small></div> </div> <div style="border: 1px solid black; padding: 2px; margin-top: 5px; width: fit-content;">0 <small>nPr</small></div> <div style="border: 1px solid black; padding: 2px; margin-top: 5px; width: fit-content;">0 <small>nPr</small></div> <div style="border: 1px solid black; padding: 2px; margin-top: 5px; width: fit-content;">INPUT <small>Memory</small></div>	<p>#CF(6) = <small>INPUT</small> 100 <small>RPN</small></p>	Inputs <b>115000</b> as the monetary value of <b>CF(6)</b> . Displays the current value, <b>1</b> , for the number of times <b>CF(6)</b> occurs.
<div style="border: 1px solid black; padding: 2px; margin: 5px; width: fit-content;">INPUT <small>Memory</small></div>	<p>CF(7) = <small>INPUT</small> 000 <small>RPN</small></p>	Accepts <b>1</b> as the number of occurrences for <b>CF(6)</b> .



## Analyzing Cash Flows

The various functions used to analyze cash flows are located in the **NPV**  and **IRR**  menus. If you press  or  before entering cash flows, you will be redirected to the cash flow menu to enter values into the cash flow list. The menu maps for the **IRR** and **NPV** menus are shown in Figure 2. Table 5-3 describes the items within these menus. The results shown in Table 5-4 are based on the values entered in the cash flows as shown in Table 5-2.

**Table 5-3 Analyzing Cash Flows**

Item	Description
<b>Inv. I%</b>	Investment or discount rate. Enter the investment rate or discount rate for the cash flow followed by  . This rate must be entered in both the NPV and IRR menus.*
<b>NetPV</b>	Net Present Value. Shows the value of the cash flows at the time of the initial cash flow, discounting the future cash flows by the value set for <b>Inv. I%</b> .
<b>NetFV</b>	Net Future Value. Shows the value of the cash flows at the time of the last cash flow, discounting the earlier cash flows by the value set for <b>Inv. I%</b> .
<b>NetUS</b>	Net Uniform Series. Shows the per-period payment of a regular, periodic cash flow of equivalent present value to the cash flow list.
<b>Payback</b>	Payback. Shows the number of periods for the investment to return value.
<b>Discounted Payback</b>	Discounted Payback. Shows the number of periods required for the investment to return value if the cash flows are discounted using the value set in <b>Inv. I%</b> .
<b>Total</b>	The sum of all the cash flows, equivalent to NPV if <b>Inv. I%</b> is <b>0</b> .
<b>#CF/Yr</b>	The number of cash flows per year. The default is <b>1</b> .
<b>IRR%</b>	Internal Rate of Return. This is the discount rate that returns a Net Present Value for the entered cash flows.
<b>Safe I%*</b>	Safe Interest Rate. Enter the safe investment rate followed by  .
<b>MIRR*</b>	Modified Internal Rate of Return. Used primarily when there is more than one sign change in a series of cash flows to evaluate the overall profitability of an investment.
<b>FMRR*</b>	Financial Management Rate of Return. Used primarily when there is more than one sign change in a series of cash flows to evaluate the overall profitability of an investment.

\*Does not apply to the HP 20b.

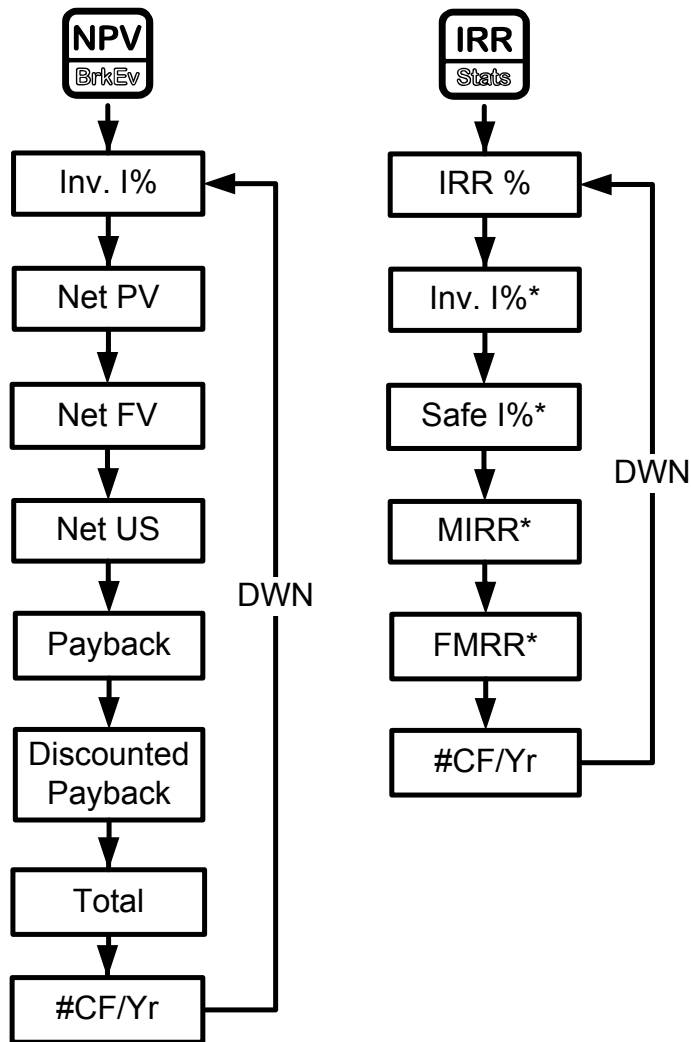

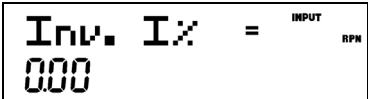





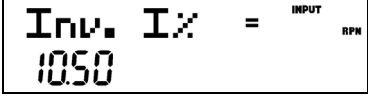



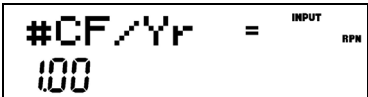


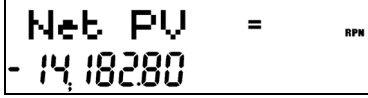



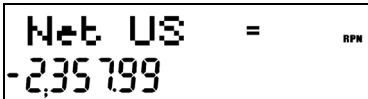






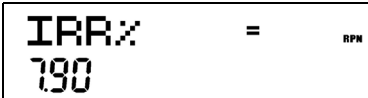









Figure 2 The Menu Maps for the NPV and IRR Menus





\*Does not apply to the HP 20b.


Table 5-4

Keys	Display	Description
		Opens the <b>NPV</b> menu.
    		Inputs <b>10.5</b> for investment rate.
  		(Optional) Verifies one cash flow list per year, as per the example.
 		Displays the <b>NPV</b> of the cash flow with the given <b>Inv. I%</b> .
		Displays the <b>NFV</b> of the cash flow with the given <b>Inv. I%</b> .
		Displays the <b>Net US</b> of the cash flow with the given interest rate.
		Displays the number of periods required for the cash flow to repay the investment
 		Scrolls to the total value of the cash flow.
		Displays the <b>IRR</b> for the cash flow.

## Editing Cash Flows

In the cash flow list, you can view and modify the current monetary value of a specific cash flow, or cash flows. Press  or  repeatedly to scroll through the list. To modify the displayed entry, type a new number and press . For example, to change the current monetary value of the cash flow three, **CF(3)**, in the example in Table 5-2 from 0 to 200, with **CF(3)=** displayed, press    followed by .

You can also modify the number of occurrences of a cash flow in the same manner with **#CF(n)** displayed. Pressing   with a cash flow displayed erases the displayed cash flow. Pressing   inserts a cash flow into the list before the displayed cash flow.

Note that the values for the number of cash flows occurring for a given year, (**#CF/Yr**) Investment interest rate, (**Inv. I%**), and safe interest rate (**Safe I%**) can be entered in both the NPV and IRR menus\*. Key in the desired number or rate followed by  with the item displayed. The other items are then calculated internally.

## Modified Internal Rate of Return (MIRR) and Financial Management Rate of Return (FMRR)\*


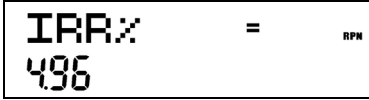








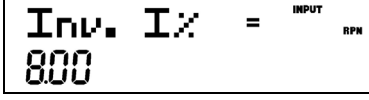



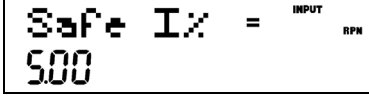




For the cash flow example you entered in Table 5-2, edit the cash flows using the cash flow amounts and number of occurrences shown in Table 5-5 below. For the initial cash flow, **CF(0)**, enter **-1,250,000**. In the IRR menu, enter **8%** for investment interest rate, and **5%** as a safe rate. Verify the number of cash flows per year, **#CF/Yr**, is set to **1**. The results for MIRR and FMRR are shown in Table 5-6. This example was calculated in Algebraic mode.

Table 5-5

Cash Flow Number	Cash Flow Amount	Occurrences
1	-300,000.00	1
2	200,000.00	1
3	450,000.00	1
4	-200,000.00	1
5	700,000.00	1
6	300,000.00	1
7	500,000.00	1

\*Does not apply to the HP 20b.

Table 5-6

Keys	Display	Description
		Opens the IRR menu. Displays the <b>IRR</b> for the cash flow.
  		(Optional) Verifies one cash flow list per year, as per the example.
   		Inputs <b>8%</b> for investment rate.
  		Inputs <b>5%</b> for the safe investment rate.
		Displays MIRR%.
		Displays FMRR%.

# Sample Cash Flow Diagrams

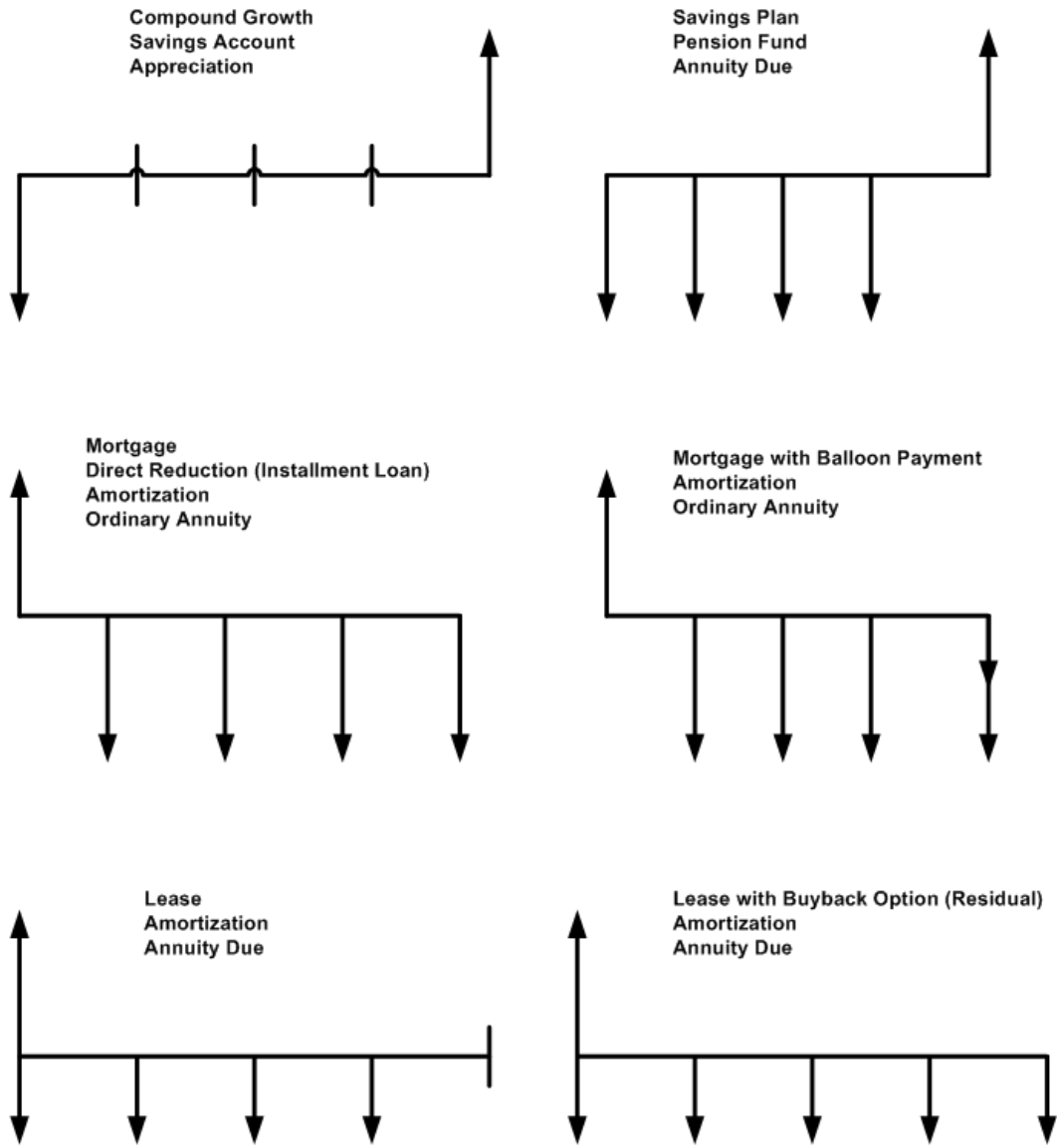


Figure 3 Sample Cash Flow Diagrams

# 6 Bonds

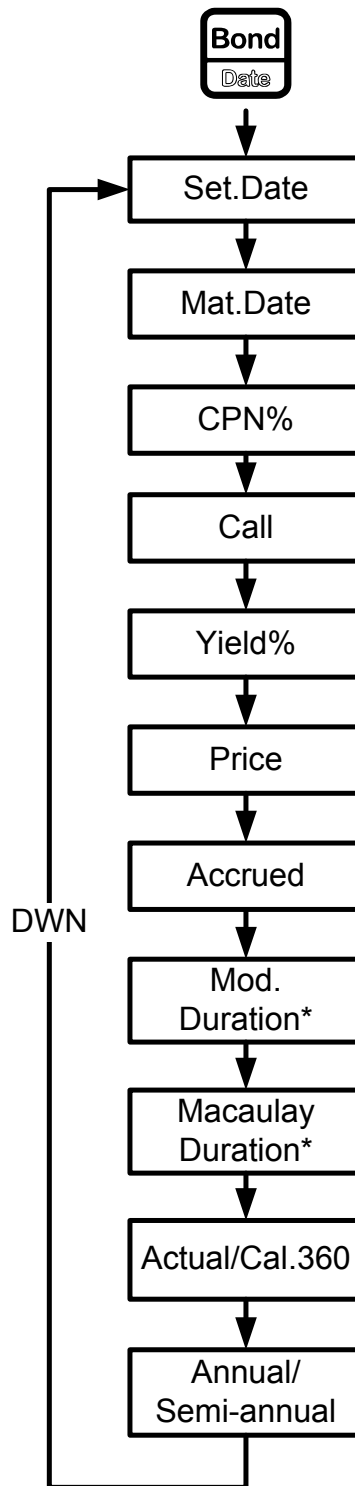



Figure 1 The Menu Map for the Bond Menu

\*Does not apply to the HP 20b.

# The Bond Menu

Before you enter the Bond menu, be sure to verify the date format is set appropriately for your problem. The default setting is **mm.ddyyyy**, but it can be set for **dd.mmyyyy**. The range of acceptable dates is October 15, 1582 to December 31, 9999. Bond day counts (360/365) and annual or semiannual coupon payment schedules may be set from either the Mode menu or the Bond menu. For more information on setting the preferences in the Mode Menu, see the section titled, *The Mode menu: Setting Preferences* in Chapter 1.

To open the Bond menu, press .

Press  or  repeatedly to scroll through the items shown in Figure 1.

To change the value of the displayed item, key in a number or a date and press .






Once you have entered all known data, Press  or  repeatedly to scroll to an unknown item, and press  to calculate it.

Table 6-1 lists the items in the Bond menu.

**Table 6-1 Bond Menu Items**

Variable	Description
<b>Settlement Date</b>	Settlement date. Displays the current settlement date. Note: input only.
<b>Maturity Date</b>	Maturity date or call date. The call date must coincide with a coupon date. Displays the current maturity. Note: input only.
<b>CPN%</b>	Coupon rate stored as an annual %. Note: input only.
<b>Call</b>	Call value. Default is set for a call price per 100.00 face value. A bond at maturity has a call value of 100% of its face value. Note: input only.
<b>Yield%</b>	Yield% to maturity or yield% to call date for given price. Note: input/output.
<b>Price</b>	Price per 100.00 face value for a given yield. Note: input/output.
<b>Accrued</b>	Interest accrued from the last coupon or payment date until the settlement date for a given yield. Note: this item is Read-only.
<b>Mod. Duration*</b>	Modified duration for the bond. This is a measure of bond price sensitivity to yield changes.
<b>Macaulay D.*</b>	Macaulay Duration for the bond. This is a measure of bond price sensitivity to yield changes.
<b>Actual/Cal.360</b>	Actual (365-day calendar) or Cal.360 (30-day month/360-day year calendar). Press  to toggle between these options.
<b>Annual/Semiannual</b>	Bond coupon (payment) frequency. Press  to toggle between these options.




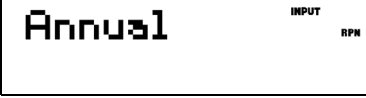


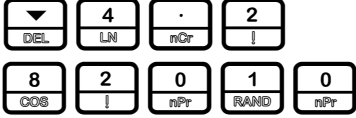



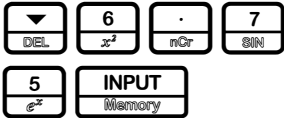


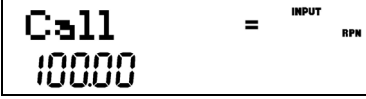

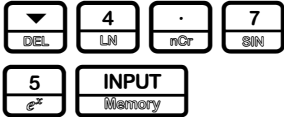



\*Does not apply to the HP 20b.






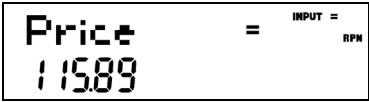











## Bond Calculation Example

What price should you pay on April 28, 2010 for a 6.75% U.S. Treasury bond maturing on June 4, 2020, if you want a yield of 4.75%? Assume the bond is calculated on a semiannual coupon payment on an actual/actual basis. See Table 6-2. The example below is calculated with RPN as the active operating mode.






Table 6-2 Bond Calculation Example

Key	Display	Description
		Opens the Bond menu.
		Scrolls to bond coupon (payment) frequency.
		Selects semiannual coupon payment, as required by the example.
		Inputs April 28, 2010 for the settlement date (mm.ddyyyy format).
		Inputs <b>June 4, 2020</b> for the maturity date.
		Inputs <b>6.75%</b> for the value for CPN%.
		Displays current call value. Default is <b>100</b> . Note: if <b>Call</b> requires another value, key in the number followed by  .
		Inputs <b>4.75%</b> for <b>Yield%</b> .
		Calculates the current value for <b>Price</b> .

**Table 6-2 Bond Calculation Example**

Key	Display	Description
  		Stores <b>115.89</b> in memory 1.
		Displays the current value for accrued interest.
   		Returns the result for total price (value of price + value of accrued interest) in <b>RPN</b> mode. If calculating in Chain or Algebraic modes, at this point, press     . The net price you should pay for the bond is <b>118.58</b> .

To reset the menu items to their default values, with any item of the Bond menu displayed press


 . With **Bond** displayed, press  to reset the menu, or  to cancel. Press  again to exit the menu.

# 7 Black-Scholes Calculation Menu\*

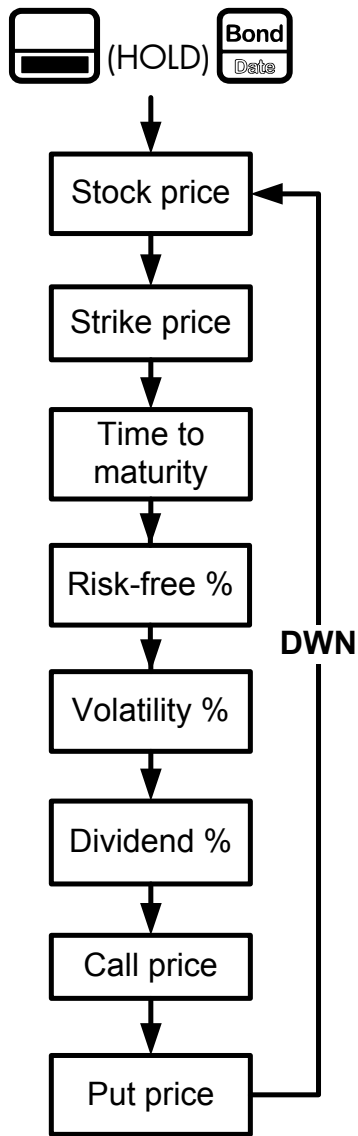









Figure 1 The Menu Map the Black-Scholes menu




\*Does not apply to the HP 20b.

## The Black-Scholes Menu

To open the Black-Scholes menu (the Black-Scholes key is  (HOLD) ). To open the menu:

1. Press and hold the  key.
2. Press the  (the Black-Scholes key).
3. Release both keys.

In other words, press on the  and  keys simultaneously and hold both keys, just as you would when accessing a shifted-function on a PC keyboard. If you press and release  and then press on the  (Black-Scholes key), you will enter the Date menu.

To change the value of the displayed item, key in a number and press . Once you have entered all known data, the unknown items are calculated automatically. Press  or  repeatedly to scroll to view the items.

An option is a contract between two parties giving party *A* the option to buy or sell an asset from/to party *B* at a given price.

The Black-Scholes model is used to calculate an estimated fair market price for that option, meaning that it calculates the fair price that someone would pay to buy or sell the option to later buy or sell an asset at a given price!



The asset or stock that the option refers to is often called the “underlying asset.”

The Black-Scholes calculation is based on the contract terms (i.e., the price and date at which the underlying asset can be sold or bought), the quality of the asset itself, its price, volatility and return on investment, and the other available alternatives, such as storing your asset in a safe investment account, for example.

Intuitively, if the option is to buy a stock at 10, and the stock is already worth 30 and has little volatility, the value of the option is close to  $30-10=20$ , plus or minus other risk factors. Table 7-1 lists the Black-Scholes menu items along with their descriptions.

Table 7-1

Item	Description
<b>Stock price (input)</b>	Current underlying asset price
<b>Strike price (input)</b>	Predetermined price at which the option agrees to buy or sell the underlying asset at maturity.
<b>Time to maturity (input)</b>	Time remaining until expiration of the option in years.
<b>Risk free% (input)</b>	Current risk-free interest rate (for example, the current US Treasury Bond rate).
<b>Volatility % (input)</b>	Degree of unpredictable change of the stock price. This is usually approximated by the standard deviation of the variation of the stock price.
<b>Dividend % (input)</b>	Estimation of the average dividend yield of the stock as a percentage of its price.
<b>Call price (output)</b>	Estimated fair market value for a call option at expiration (a call option is the right to purchase the asset at a given price).
<b>Put price (output)</b>	Estimated fair market value for a put option at expiration (a put option is the right to sell the asset at a given price).

Note that if you enter a history of the underlying asset price and its yield in the data menu, pressing the  key on the **Volatility %** menu item automatically calculates the standard deviation of the variation of the asset price based on the given data. Pressing  in the **Dividend %** menu item automatically calculates the average dividend as a percent of the asset price.



## Black-Scholes Example

The historic prices for an asset and their dividends are listed in Table 7-2 below. Given this data, calculate the call and put prices for the asset. The example is calculated with RPN set as the operating mode.

First, enter the historical asset prices and the dividend as ordered pairs in the Data menu. Enter the historical prices for the  $x$  values, and the dividend for each  $y$  value. For more information about entering data in the Data menu, see Chapter 12, *Statistical Operations*.

Table 7-2

Historical Asset Price (x)	Dividend (y)
80	3
85	5
78	1
72	0



































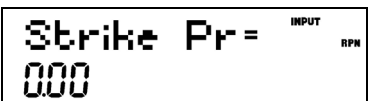




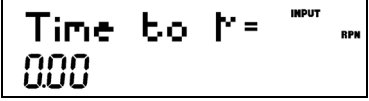








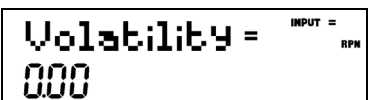
Open the Black-Scholes menu. Use the arrow keys,  or , to scroll through the menu. With the menu item displayed, key in the value in the right column of the table followed by

 :



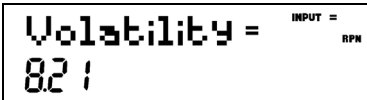







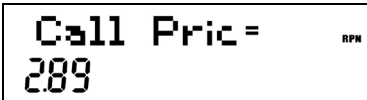


Table 7-3





Menu item	Value
Stock Price	74
Strike Price	72
Time to Maturity	0.3 (years)
Risk Free%	5
Volatility%	8.21
Dividend%	2.73

Table 7-4 Black-Scholes Example

Keys	Display	Description
 		Opens the Data menu.
    		Inputs 80 for x and 3 for y.
    		Inputs 85 for x and 5 for y.
    		Inputs 78 for x and 1 for y.
    		Inputs 72 for x and 0 for y.
 (HOLD) 		Opens Black-Scholes menu.
   		Inputs 74 for Stock Price. Scrolls to Strike Price.
   		Inputs 72 for Strike Price. Scrolls to Time to Maturity.
   		Inputs 0.3 years for Time to Maturity. Scrolls to Risk Free%.
  		Inputs 5 for Risk-Free%. Scrolls to Volatility.

**Table 7-4 Black-Scholes Example**

Keys	Display	Description
 Press  to scroll to the next item.		Calculates the standard deviation of the price of the underlying asset based on the historical data entered in the Data menu. If you have not entered the historical data, you can enter the standard deviation of the price of the underlying asset directly by typing the number and pressing  . Press  to scroll to the next item.
 Press  to scroll to the next item.		Calculates the average dividend return as a percentage of the underlying asset cost based on the historical data entered in the Data menu. If you have not entered the historical data, enter the average dividend return as a percentage of the underlying asset cost directly by typing the number and pressing  .
		Scrolls to Call Price.
		Scrolls to Put Price.

To reset the menu items to their default values, with any item of the Black-Scholes menu displayed press . With **Black-Scholes** displayed, press  to reset the menu, or  to cancel. Press  again to exit the menu.



## 8 Date Calculation

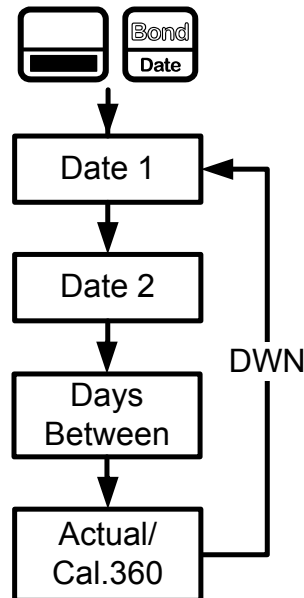










Figure 1 The Menu Map for the Date Calculation Menu

### The Date Calculation Menu

The Date Calculation menu is used to calculate the number of days between two dates, or a second date given a number of days from an initial, or final date. To open the Date Calculation menu, press  . Press  or  repeatedly to scroll through the items shown in Figure 1. Before you enter dates, verify the date is set in the format required for your problem. Date and calendar formats may be set in the Mode menu. The range of acceptable dates is October 15, 1582 to December 31, 9999. For more information on setting the preferences in the Mode Menu, see the section titled, *The Mode menu: Setting Preferences* in Chapter 1.



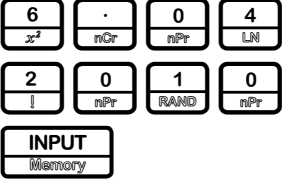
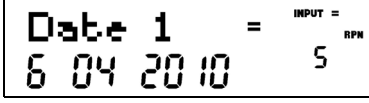
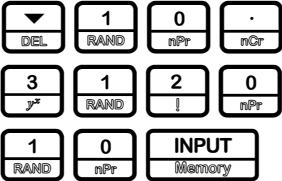
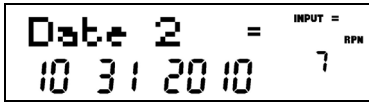


To change the value of a displayed item, key in a number or a date and press .

Once you have entered all known data, press  or  repeatedly to scroll to the unknown item and press  to calculate it.





### Date Calculation Example

How many days remain in the 2010 fiscal year if today's date is June 4, 2010? Assume the fiscal year ends on October 31st, and you wish to calculate the actual number of days (**Actual**).

Table 8-1 Date Calculation Example

Key	Display	Description
		Opens the Date Calculation menu. NOTE: <b>2</b> in the right of the display represents the day of the week. <b>2</b> represents Tuesday.
		Inputs the starting date in the selected format.
		Inputs the ending date in the selected format.
		Calculates the number of actual days between the starting and ending dates.

To reset the menu items to their default values, with any item of the Date menu displayed press

 . With **Date** displayed, press  to reset the menu, or  to cancel. Press  again to exit the menu.

## 9 Break-even

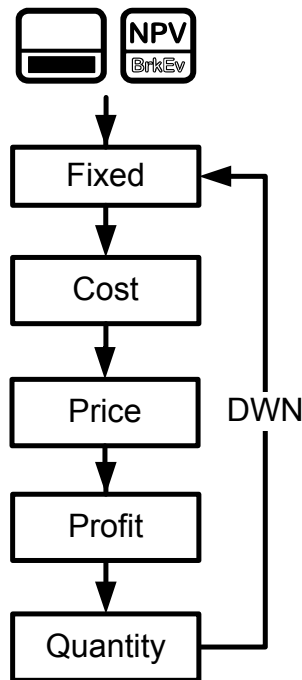








Figure 1 The Menu Map for the Break-even Menu

### The Break-even Menu





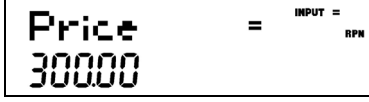


To open the Break-even menu, press  . To change the value of the displayed item, key in a number and press . Once you have entered all known data, press  or  repeatedly to scroll to the unknown item and press  to calculate it.





The break-even function allows you to study problems involving a profit, when a quantity of items, with a cost to manufacture and a fixed price to develop and market, is sold at a given price (see Figure 1).

### Break-even Example

The sale price of an item is 300.00, the cost is 250.00, and the fixed cost is 150,000.00. How many units would have to be sold to make a profit of 10,000.00?

Table 9-1 Break-even Example

Keys	Display	Description
 <b>CashFl</b> Data		Opens the Break-even menu starting with the current value for fixed costs.
1 5 0 0 RAND e <sup>x</sup> nPr nPr 0 0 INPUT nPr nPr Memory		Inputs <b>150,000.00</b> for fixed cost.
▼ 2 5 0 DEL ! e <sup>x</sup> nPr INPUT Memory		Inputs <b>250.00</b> for variable cost per unit.
▼ 3 0 0 DEL y <sup>x</sup> nPr nPr INPUT Memory		Inputs <b>300.00</b> for price.
▼ 1 0 0 DEL RAND nPr nPr 0 0 INPUT nPr nPr Memory		Inputs <b>10,000.00</b> for profit.
▼ = DEL ANS		Calculates the current value for the unknown item. 3200 units would have to be sold to return a profit of 10,000.00.

To reset the menu items to their default values, with any item of the Break-even menu displayed press . With **BrkEven** displayed, press  to reset the menu, or  to cancel. Press  again to exit the menu.

# 10 Business Problems

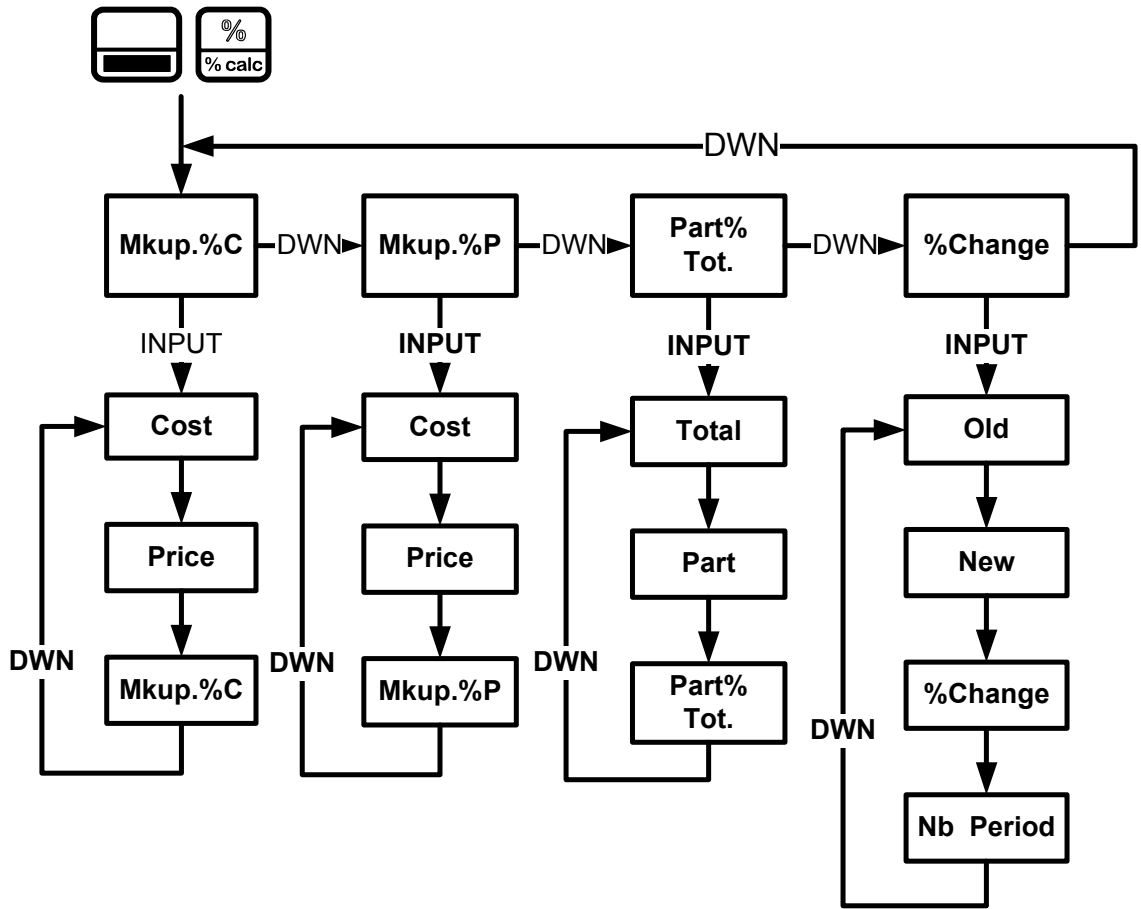











Figure 1 The Menu Map for the Percent Calculation (%calc) Menu

## The Percent Calculation Menu

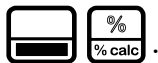
Press   to open the menu. There are four items in this menu:

1. Markup as a percentage of cost (**Mkup. %C**)
2. Markup as a percentage of price (**Mkup. %P**)
3. Part as a percentage of total (**Part%Tot.**)
4. Percent change (**%Change**).

These items allow you to access sub-menus. Press  or  repeatedly to scroll to the desired sub-menu, then press  to open it (see Figure 1).

To change the value of a displayed item, key in a number and press . Once you have entered all known data, press  or  repeatedly to scroll to the unknown item and press  to calculate it.

To return to the percent calculation menu, from anywhere within the menu or sub-menus, press



To exit the menu, press



NOTE: for business problems, margin is based on price; markup is based on cost. The examples below are calculated with **RPN** as the active operating mode.

## Percent Calculation Examples

See the tables below for examples of calculations in the %calc menu.






















1. Find the markup on an item if the cost price is 15.00 and the selling price is 22.00.


Table 10-1 Markup Example

Keys	Display	Description
		Opens the %Calc menu.
		Opens the Mkup.%C sub-menu.
		Inputs <b>15</b> for <b>Cost</b> .
		Inputs <b>22</b> for <b>Price</b> .
		Calculates the value of <b>Mkup.%C</b> for the given data.

2. Find the percent change between 20 and 35 with no compounding.

Table 10-2 Percent Change Example

Keys	Display	Description
 		Opens the %Calc menu.
  		Scrolls to %Change.
		Opens the %Change sub-menu.
  		Inputs <b>20</b> for <b>Old</b> .
   		Inputs <b>35</b> for <b>New</b> .
 		Calculates the current value of %Change for the given data.

NOTE: although the example in Table 10-2 calls for no compounding, you may specify the number of compounding periods used in calculations with the **Nb Period** item in the %Change sub-menu. **Nb Period** is the number of compounding periods used in calculations between the old value and new value. The default is **1**, but to change the setting, key in a number with **Nb Period** displayed, followed by .

After calculating the example above with no compounding, say, for example, you wish to calculate the percent change over six compounding periods:

Table 10-3 Percent Change Example with Compounding

Keys	Display	Description
		The current value of <b>%Change</b> for the given data.
		Inputs <b>6</b> for the number of compounding periods.
		Calculates the percent change between the old value and the new value over six compounding periods.

3. 30 is what % of 80?

Table 10-4 Part % of Total Example

Keys	Display	Description
		Opens the <b>%Calc</b> menu.
		Scrolls to the <b>Part %Total</b> menu item.
		Opens the <b>Part as %Total</b> sub-menu.
		Inputs <b>80</b> for <b>Total</b> .
		Inputs <b>30</b> for <b>Part</b> .
		Calculates the value of <b>Part %Total</b> for the given data.

To reset the menu items to their default values, with any item of the **%calc** menu displayed press . With **%Calc** displayed, press to reset the menu, or to cancel. Press to exit the menu.



# 11 Depreciation

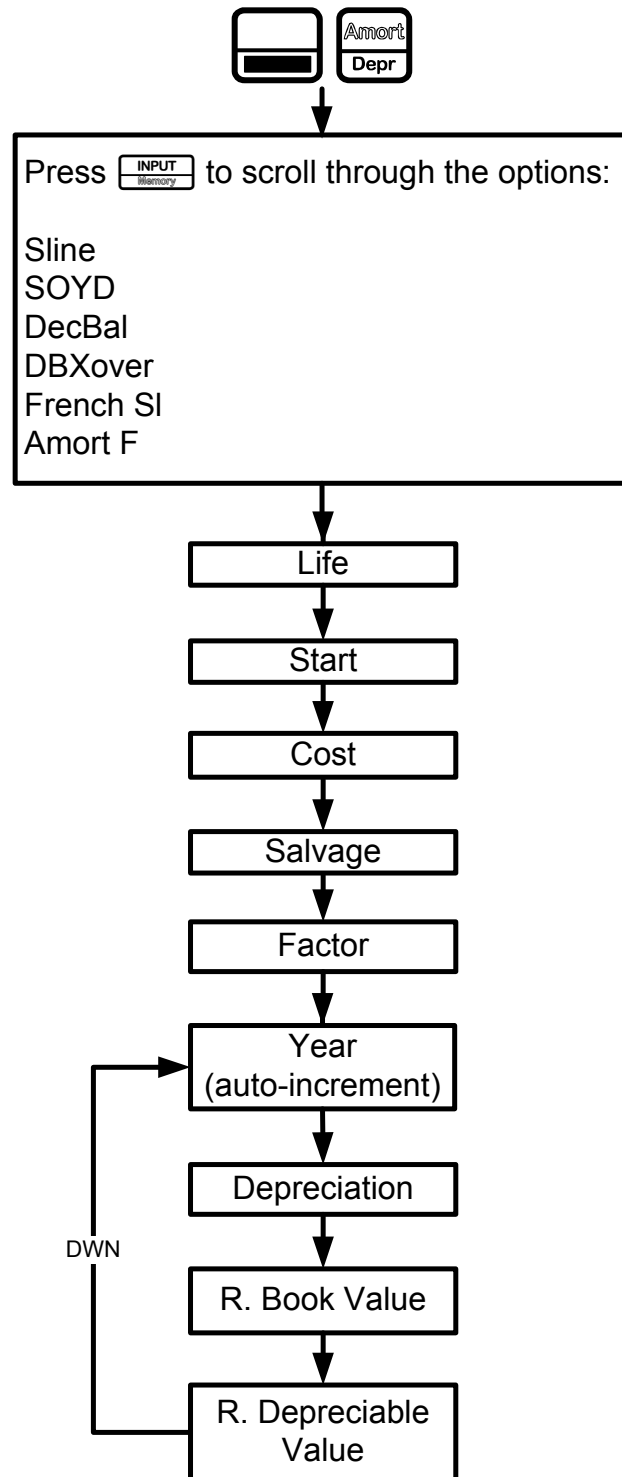









Figure 1 The Menu Map for the Depreciation Menu

## The Depreciation Menu

Press  to open the Depreciation menu. To select a depreciation method, press . See Figure 1. Input the values required for the calculation:

- Asset life
- Starting date or month of the depreciation
- Cost and salvage values
- Declining balance factor (DecBal and DBXover only)
- The first year for which you want to view the depreciation schedule

Scroll through the items of the sub-menu for the selected depreciation method by pressing  or  repeatedly. To change the value of the displayed item, key in a number and press . For the **Start** item, enter either a number or an actual date, depending on the type of depreciation selected. Press  repeatedly to view the depreciation schedule.

NOTE: pressing  on the last item of a sub-menu returns you to the **Year** item and increments it (see Figure 1).

Brief descriptions of the methods used to calculate depreciation are provided in Table 11-1. Table 11-2 describes the items found in the depreciation sub-menus. For an example calculating depreciation using the straight-line method, see Table 11-3.

**Table 11-1 Depreciation Methods**

Depreciation Method	Description
<b>Sline</b>	Straight line is a method of calculating depreciation presuming an asset loses a certain percentage of its value annually at an amount evenly distributed throughout its useful life.
<b>SOYD</b>	Sum-of-the-years' digits is an accelerated depreciation method. In <b>SOYD</b> , the depreciation in year $y$ is $(\text{Life}-y+1)/\text{SOY}$ of the asset, where <b>SOY</b> is the sum-of-the-years for the asset, or, for an asset with a 5-year life, $5+4+3+2+1=15$ .
<b>DecBal</b>	Declining balance is an accelerated depreciation method that presumes an asset will lose the majority of its value during the first few years of its useful life.
<b>DBXover</b>	Declining balance crossover is an accelerated depreciation method that presumes an asset will lose the majority of its value in the first few years of its useful life, but that it will revert to a consistent depreciation during the latter part of its life, which is then calculated using the straight line method.
<b>French SL</b>	Straight line French. This method of depreciation is similar to the Straight line method, except an actual calendar date in <i>mm.dd</i> format is entered in for <b>Start</b> to indicate when the asset was first placed into service.
<b>Amort F</b>	French amortization. This method is an accelerated depreciation method with a crossover to the French Straight Line method.

**Table 11-2 Depreciation Menu Items**

Item	Description
<b>Life</b>	The expected useful life of the asset in years.
<b>Start</b>	<b>Start</b> refers to the date or month in which the asset is first placed into service. Depending on the type of depreciation, this can be the month (1-12), or, in the case of French Straight-line and Amort F, the actual date in the selected format. Note: for non-French depreciations, if the asset was placed into service in the middle of March, for example, enter <b>3.5</b> for <b>Start</b> .
<b>Cost</b>	The depreciable cost of the asset at acquisition.
<b>Salvage</b>	The salvage value of the asset at the end of its useful life.
<b>Factor</b>	The declining balance factor as a percentage. This is used for declining balance and declining balance crossover methods only.
<b>Year</b>	Year for which you want to calculate the depreciation.
<b>Depreciation</b>	Depreciation in the given year.
<b>R.Book Value</b>	Remaining book value at the end of the given year.
<b>R.Depreciable Value</b>	Remaining depreciable value at the end of the given year.

### Depreciation Example

A metalworking machine, purchased for 10,000.00, is to be depreciated over five years. Its salvage value is estimated at 500.00. Using the straight-line method, find the depreciation and remaining depreciable value for each of the first two years of the machine's life. See Table 11-3.

**Table 11-3 Straight Line Depreciation Example**









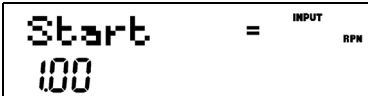





































Key	Display	Description
 		Opens the Depreciation menu starting with the straight line method.
  		Inputs <b>5</b> for the useful life.
		Displays the current value of <b>Start</b> . <b>1</b> (January) is the default value. For this example, this value remains unchanged, since the depreciation of the machine starts January 1 <sup>st</sup> ( <b>1.00</b> ).
      		Inputs <b>10,000.00</b> for the cost of the item.
    		Inputs <b>500.00</b> for the salvage value of the item.

Table 11-3 Straight Line Depreciation Example

Key	Display	Description
		Year for which to calculate the depreciation. <b>Year 1</b> is the default value. To calculate for a year other than <b>1</b> , type a number and press  .
		Depreciation of the asset in year one.
		Remaining book value after year one.
		Remaining depreciable value after year one.
		The next year for which to calculate the depreciation. To calculate for a year other than <b>2</b> , type a number and press  .
		Depreciation of the asset in year two.
		Remaining book value after year two.
		Remaining depreciable value after year two.

To reset the menu items to their default values, with any item of the Depreciation menu displayed press  . With **Depreciation** displayed, press  to reset the menu, or  to cancel. Press  to exit the menu.

# 12 Statistical Operations

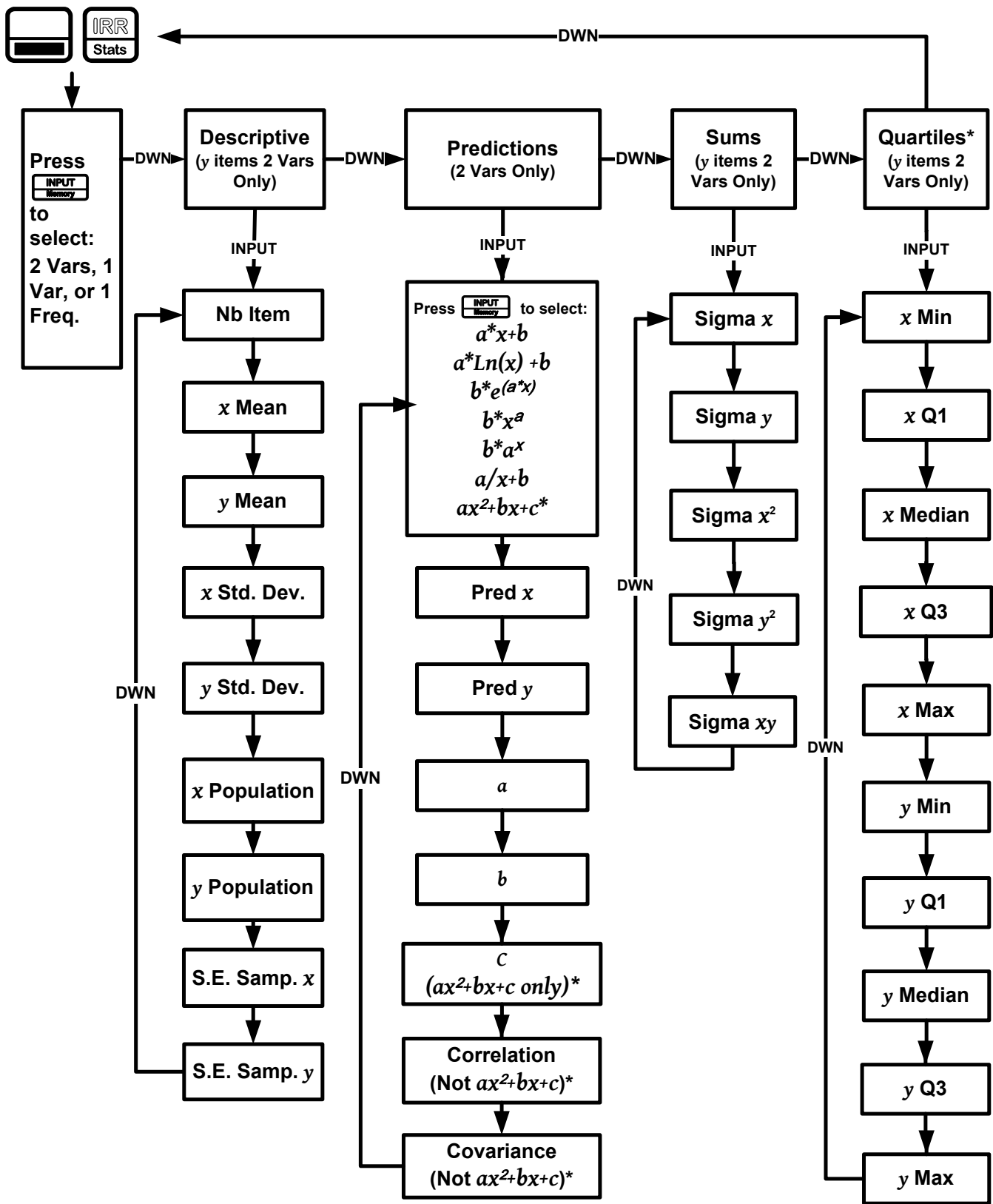












Figure 1 The Menu Map for the Statistics Menu








\* $ax^2+bx+c$  and Quartiles do not apply to the HP 20b.

## The Data and Stats Menus



Statistics analysis functions are located in the Data and Statistics menus accessible with the   and   keys. See Figure 1 for assistance with navigating through the menus.

Press   to open the Data menu. In this menu, enter a list of  $x$  values for one-variable statistics, a list of pairs,  $(x, f)$  for one-variable statistics with frequency, or a list of pairs,  $(x, y)$  for two-variable statistics. To enter data, key in a number and press .

Press   to analyze the data. If you attempt to open the Statistics (**Stats**) menu before entering data, you will be redirected to the Data menu. When opened, the Stats menu displays **2 Vars** for two-variable statistics. Press  repeatedly to select the type of statistical operations desired, two-variable, (**2 Vars**), one-variable, (**1 Var**), or one-variable with frequency (**1 Freq**).

After selecting the type of statistical operation you want, select a sub-menu by pressing  or , and press  to open it. Once in a sub-menu, press  or  repeatedly to view the results. To return from the sub-menu to the Statistics menu, press  .

NOTE: in one-variable modes, there are no items for  $y$ , and the **Predictions** sub-menu is not available.

Pressing  with the **Predictions** sub-menu displayed opens a sub-menu, in which you can choose among seven different types of regression lines. See Figure 1. To select a specific type of regression line in the **Predictions** sub-menu, press  to cycle through the options.

NOTE: if you press , the calculator automatically selects the curve that is the best fit for your data.

Once you select a regression line, press  to see the regression line parameters and perform predictions.

Table 12-1 The Statistics Menu Items

Menu Item	Description
Nb Item	Number of items.
$\bar{X}$ Mean	Average of $x$ values.
$\bar{Y}$ Mean	Average of $y$ values.
$x$ Std. Dev	Standard deviation for $x$ : a measure of how dispersed the $x$ data values are about the mean.

**Table 12-1 The Statistics Menu Items**

<b>Menu Item</b>	<b>Description</b>
<b>y Std. Dev</b>	Standard deviation for <b>y</b> : a measure of how dispersed the <b>y</b> data values are about the mean.
<b>x Population Dev</b>	Population Standard deviation for <b>x</b> : a measure of how dispersed the <b>x</b> data values are about the mean, assuming the data constitutes a complete set of data.
<b>y Population Dev</b>	Population Standard deviation for <b>y</b> : a measure of how dispersed the <b>y</b> data values are about the mean, assuming the data constitutes a complete set of data.
<b>S.E.Samp.x</b>	Standard error for the sample <b>x</b> : a measure of the dispersion of <b>x</b> mean, assuming the data is a sampling of a large, more complete data set.
<b>S.E.Samp.y</b>	Standard error for the sample <b>y</b> : a measure of the dispersion of <b>y</b> mean, assuming the data is a sampling of a large, more complete data set.
<b>Pred x</b>	Predicts <b>x</b> for a given hypothetical value of <b>y</b> , based upon the model calculated to fit the data.
<b>Pred y</b>	Predicts <b>y</b> for a given hypothetical value of <b>x</b> , based upon the model calculated to fit the data.
<b>a</b>	The <b>a</b> coefficient for the chosen regression model, which is the slope for a linear model.
<b>b</b>	The <b>b</b> coefficient for the chosen regression model, which is the <b>y</b> -intercept for a linear model.
<b>c</b>	The <b>c</b> coefficient for the chosen regression model, applies only for $ax^2+bx+c$ .
<b>Correlation</b>	The correlation coefficient for the given ( <b>x</b> , <b>y</b> ) data. The correlation coefficient is a number in the range -1 through 1 that measures how closely the calculated line fits the data.
<b>Covariance</b>	A measure of how much two variables change in relation to one another.
$\Sigma x$	The sum of the <b>x</b> values.
$\Sigma y$	The sum of the <b>y</b> values.
$\Sigma x^2$	The sum of the squares of the <b>x</b> values.
$\Sigma y^2$	The sum of the squares for the <b>y</b> values.
$\Sigma xy$	The sum of the products of the <b>x</b> and <b>y</b> values.
<b>Quartiles*</b>	The boundaries of a given frequency distribution divided into four parts.
<b>Median*</b>	The middle value in a given frequency distribution.
<b>Maximum*</b>	The largest value in a given frequency distribution.
<b>Minimum*</b>	The lowest value in a given frequency distribution.

\*Does not apply to the HP 20b.

## Statistics Example

Sales for the last five months are represented by the pairs of values shown below, with the month number as  $x$ , and the sales values as  $y$ . Enter these into the Data menu. Using the Statistics menu for **Predictions**, predict sales for month seven. What is the linear regression line? What is the sum of all the  $y$  values? See Table 12-2 and Table 12-3.

**Table 12-2 Statistics Example Months and Sales Values**

Month	Sales Values
1	150
2	165
3	160
4	175
5	170



Table 12-3 Statistics Example


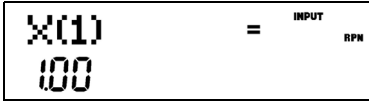
















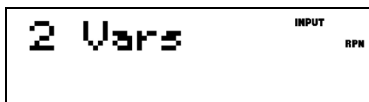


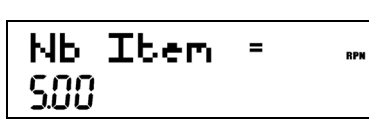








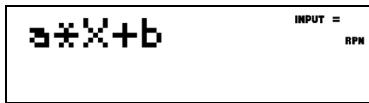










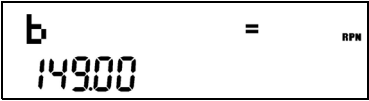

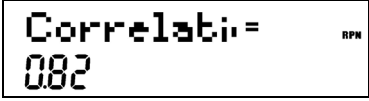







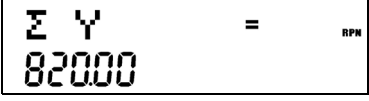




Keys	Display	Description
		Opens Data menu.
 		Inputs values for x(1) and y(1).
 		Inputs values for x(2) and y(2).
 		Inputs values for x(3) and y(3).
 		Inputs values for x(4) and y(4).
 		Inputs values for x(5) and y(5).
		Opens Stats menu.
 		Opens Descriptive sub-menu.
 		Displays average y.
    		Opens Predictions sub-menu. NOTE: this example performs calculations based on a linear ( $a*x+b$ ) regression line.
  		Inputs <b>7</b> as the <b>Prediction x</b> value (month 7).
 		Calculates <b>Prediction y</b> value (sales at month 7).

Table 12-3 Statistics Example

Keys	Display	Description
		Displays value for <b>a</b> : the slope of the regression line.
		Displays current value for <b>b</b> : the <b>y</b> -intercept of the regression line.
		Displays value for <b>Correlation</b> .
      		Opens <b>Sums</b> sub-menu. Displays the sum of all <b>y</b> values (Sigma <b>y</b> ).

To reset the menu items to their default values, with any item of the Data or Statistics menus displayed press  . At the prompt, **Stats**, press . Confirm your choice by pressing .

---

# 13 Programming




## Programming the HP 30b

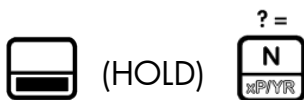
This chapter applies only to the HP 30b, and explains how to program specifically on the HP 30b. If you are unfamiliar with the basics of programming, you may have trouble understanding some of the following information. Reviewing the material and practicing the concepts illustrated below will help you understand how this feature works on the HP30b.

The HP 30b Business Professional is a powerful business calculator, but it may lack a function important to you. The HP 30b programming functions allow you to create up to ten programs to fulfill your needs. In order to keep the calculator keyboard clear and consistent, the programming functions are not written on the keyboard.

However, included in the calculator package, you should find an overlay which shows the programming functions. This is designed to be placed on the top surface of the calculator and left in place for the life of the calculator. If you are interested in programming the calculator, you will need to place the overlay on your keyboard before getting started.

### Key Presses for Program Instructions

Enter the Program menu by pressing  followed by . The instructions specific to programming (illustrated on the overlay) are inserted by pressing  and simultaneously pressing the key with the desired programming instruction. Then release both keys before pressing any additional keys for your program. In the following chapter, this combination is represented in the following manner:













































This sequence is identical to using the shift key on a computer keyboard to invoke the shifted-function.

For reference, the table on the following page lists the keys along with their associated programming instructions.

Table 13-1

Programming Key Instructions

	? = 		? ≠ 		? < 		? ≤ 		? ≥ 		? > 
(HOLD)	Equal to	(HOLD)	Not equal to	(HOLD)	Less than	(HOLD)	Less than or equal to	(HOLD)	Greater than or equal to	(HOLD)	Greater than
	GOTO 		GOTOT 		GOTOF 				LBL 		STOP 
(HOLD)	GOTO	(HOLD)	GOTO if True	(HOLD)	GOTO if False			(HOLD)	Label	(HOLD)	Stop
	DISP 		R/S 		DSE 		ISG 				
(HOLD)	Display	(HOLD)	Run/Stop	(HOLD)	Decrement, skip if ≤	(HOLD)	Increment, skip if >				
	 or 		CALL 		RETURN 		MSG 		SOLVE 		
(HOLD)	Debug	(HOLD)	Call	(HOLD)	Return	(HOLD)	Message	(HOLD)	Solve		

All programming key combinations listed in the above table require you to press the  key and (HOLD) it while simultaneously pressing the desired program instruction. The instructions are described in more detail in the following pages.

Almost any function you perform with the calculator can be programmed. A program allows you to repeat an algorithm or sequence of commands without having to retype all the keys each time you want to use that particular function.





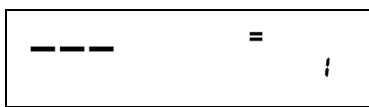



















## Programming Example









The following programming example, and all examples in this chapter, were written with **Chain** or **Algebraic** set as the operating mode. Since a program executes the keys exactly as if you were manually pressing them, the current operating mode affects how the program executes. If you normally operate in RPN, verify your operating mode is set to either **Chain** or **Algebraic** before proceeding so you can follow along with the examples below.

For more information about setting the operating mode, refer to the section titled, *The Mode Menu: Setting Preferences* in Chapter 1, *Basic Features*.


The volume of a sphere is represented by the equation,  $\frac{4}{3}\pi r^3$ . We will create a program that can calculate the volume of a sphere without having to retype all the keys each time you wish to calculate the volume of a given sphere. Verify your **FIX** setting is set for three digits to the right of the decimal point. For more information on the **FIX** setting, refer to the section titled, *The Mode Menu: Setting Preferences* in Chapter 1, *Basic Features*.



Table 13-2

Keys	Display	Description
 		Enters program mode. The first program is selected.
		Starts editing program 0. Note the counter shows your current position in the program.
            		We have entered a program that takes the currently displayed number, raises it to the 3rd power, and multiplies it by 4/3 of PI.
  		The STOP instruction tells the calculator that the program is ending. Note that to enter that special instruction, you need to press and hold the shift key, then press the  key (STOP) before releasing both keys.

Keys	Display	Description
 		Quits program editing mode. Note that program 0 uses <b>13</b> bytes and has a checksum of <b>104</b> . <i>Checksum</i> is a number that verifies the program data is correct. You must be set in <b>FIX 3</b> or higher to see the full checksum. If your number does not match that shown, verify your <b>FIX</b> setting is set for 3 or higher. If three digits are showing and the number differs from that shown, the program has been keyed in incorrectly.
  		Enters the number 5 (the sphere radius) and executes program 0. The result, the volume of the sphere, is 523.6. We press  twice: the first press completes the entry of the 5 (after all, we could have been in the process of entering an equation, such as 5*2). The second press runs the program.

## Program Step 0

Programs start at step 1, however, if you edit a program by pressing  with the program displayed and press the up key , you will find there is a step 0. Press any key with step 0 displayed and that key becomes a shortcut for the program. You may also assign any  (HOLD) key combination as well.

For example, with the sphere example shown in Table 13-2, after your program has calculated the solution, press   to open the program menu once again. **Prgm 0** is displayed,

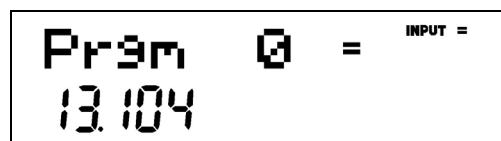













Figure 1



















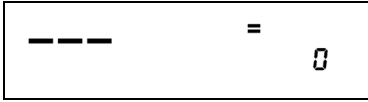









the program used for the sphere example (Figure 1). Press , followed by  to select step 0. Press  followed by  (assuming you are not interested in using the  key). Exit the program by pressing , key in a number, 5, and then press   and you will see the your program was executed with the same results as shown in the table!

If you assign a program to a shift key and there is no  (HOLD) function on that key, the standard function will be executed by pressing the  (HOLD) option of that key. This way you still have the option of using the standard shifted function of the key should you need it. Press  to clear your screen before the next section.

## Reassigning Menu Functions



Often, the best use for a program is to bring a function you use frequently out onto the keyboard. For example, if you use SIN frequently, you may want to have ASIN available directly on the keyboard as well. Having the ability to assign keys permits you to do this easily. Table 13-3 below illustrates how to reassign a menu function to the keyboard.

**Table 13-3 Reassigning Menu Functions**

Keys	Display	Description
   		Opens Program menu. Scrolls to step 1 of Program 9.
    (HOLD)    (HOLD) 		Press the keys to enter the steps of the program. Note: to enter the scroll down command as an instruction, you must press and hold  and the  key as shown.
 		Scroll to step 0.
 (HOLD) 		The ASIN function is now assigned to the SIN key.
    (HOLD) 		Exits the program menu, keys in .5, executes the program and returns results for ASIN.

## The Program Menu and Program Editing

Now that we have been through some short examples, let us look at some of the programming details.

The Program menu displays a list of the ten programs that are in the calculator. Use the  and  keys to scroll through the program menu. For each program, the number displayed at the bottom is the memory space used/occupied by the program and a checksum value of that program. For example, program 0 for the sphere uses 13 bytes and has a checksum of 104 (see Figure 2).

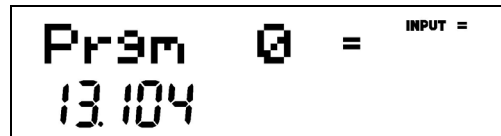












Figure 2
















There are 290 bytes of program space available.

To erase all the programs, open the Reset menu (press  ) from *outside* of program mode. In the reset menu, select **Prgm**. The number at the bottom of the display represents the amount of programming steps in use. Press  twice to erase all programs.

To erase a specific program, go to the program menu, select the program with the  or  keys, and press    to erase that specific program.

To execute a program, select the program in the program menu and press .

To edit or modify an existing program, select the program in the program menu and press :

1. Review your program by pressing the  or  keys.
2. Delete the currently displayed instruction by pressing .
3. Exit the program by pressing  or  .
4. Any other key that you press will be inserted as an instruction in the program.
5. Insert an , , , or  instruction by pressing  (HOLD) and , , , or .


Note: you can  (HOLD)   (HOLD)  followed by a label number to go to a specific label.







## Tests and Jump Functions

When creating a program, there is often a need for the conditional execution of an instruction based on a specific condition, as well as the repetition of a set of instructions.



















This is handled on the HP 30b using the **GOTO**, **LBL** (label) and Test instructions. LBL is an instruction that does not do anything by itself, but it acts as a marker for Jump instructions.

1. To enter a label or GOTO instruction, press and hold  and simultaneously press the GOTO, GOTOT, or GOTOF key, then release both keys.
2. Type a number between 00 and 99 (for numbers smaller than 10, you must type the 0 first, such as 03).


3. For example,  (HOLD)    creates label **03** in your program. You can then use a GOTO 03 instruction to *jump* to that label from any location in your program to the position of the label. **GOTOT** (Go To If True) and **GOTOF** (Go To If False) will only jump if the current displayed number is non-0 (true) for **GOTOT** or 0 (false) for **GOTOF**. Used together, these instructions allow you to create programs like the following:

```
8=
LBL 01
  DISP 5
  - 1=
GOTOT 01
STOP
```

Use the following keystrokes to enter the program:

1.    (HOLD)   
2.  (HOLD)  
3.     (HOLD)   
4.  (HOLD)  . This program has 13 bytes, and the checksum is 234. This program counts from eight to zero displaying each number 1 second.

Note:

- Label numbers must be unique. Only one label with a given number can exist in the calculator.
- You can jump from one program to another if you know that there is a specific label number in another program.
- Use the tests  $? =$  ,  $? \neq$  ,  $? <$  ,  $? \leq$  ,  $? >$  and  $? \geq$  (the top row of keys) to verify if two numbers are equal, different, and strictly, or not strictly, greater or smaller. These are dual operator-operands and are used in the same way as addition or multiplication ( in Algebraic and Chain modes, number1  $? =$  number2  $=$ , and in RPN mode, number1  number2  $? =$  ) are used, in that they return 0 if false, and 1 if true. Note that in RPN mode, the tests do not remove the arguments from the stack, but do push a 0 or 1.

## Long Programs and Battery Life

Although it is possible to create programs on the HP 30b that can run for a long period of time (calculating PI to 700 decimal places, for example) this is not something that we advise, as it will drain the batteries in less than a day.

Programming on the HP 30b was designed to create small programs to perform a function not present in the calculator, or to automate a task requiring many keystrokes and then run relatively quickly. If a program takes more than one second to run, the CPU speed will be reduced in order to preserve battery life.

## Sub-Function Call


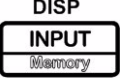
It is often useful in a program to have the option to reuse a sub-program from various locations. To avoid having to retype these sub-programs each time they are necessary, you can use the



 (HOLD)  and  (HOLD)  functions.



CALL, followed by a label number, will jump to the specified label, in the same way a GOTO instruction does, but, when the RETURN instruction is encountered, the program will continue execution just after the CALL function. This is equivalent to you temporarily pausing in an activity to answer a phone call, and then returning to your prior activity after the call. Up to four calls can be nested at the same time. Another way to picture this might be going to turn off your stove, while you are answering the doorbell that rang while you were answering your phone, while you were writing an email... it's hard for us, but computers are good at *stacking* tasks in this way.



Enter a call function the same way you enter a GOTO function.





## Other Programming Functions

 (HOLD)  **DISP:** takes a number that represents 1/5 of a second. DISP5 is thus one second.

 (HOLD)  **STOP:** Stops the execution of the program. This instruction should be placed at the end of every program.

 (HOLD)  **R/S:** Pauses the program execution and returns to the normal system.

You can then resume program execution by pressing   again. This can be used, for example, when you need to enter a number.

 (HOLD)  **DSE** ( $\leq$ ) and  (HOLD)  **ISG** ( $>$ ), followed by 1 digit (0 to 9): Loop control function. Place a number of the form cccc.eeeeii where cccc is the counter, eee is the end value for the counter and ii is the increment in variable 1. For example, DSE 1 will decrement the counter part of the variable by ii (if ii is 0, it decrements by 1) and, if cccc is less or equal to eee, it will skip the next instruction (usually a GOTO).

For example, to loop from 0 to 50, incrementing by 3 each loop, use 0.05003 as start the value and the ISG instruction. The following program will loop from 0-50, incrementing by 3 each loop and pause shortly at each loop to show the counter. At the end, it will leave 12 with a blinking cursor. Once in Program mode, select an unused program number and press:



 (HOLD)       (HOLD)  

 (HOLD)    (HOLD)       (HOLD) 



This program has 22 bytes, and the Checksum is 146.








## Messages

The MSG function is used to display messages on screen; it is especially useful when used










before halting the program with  (HOLD) , as it allows you to display messages on the screen for the user.

To enter a message while creating a program:

Press  (HOLD) . Release both keys. You can now enter messages.

In this mode, you may press  or  to select a character and  (HOLD)  or  to jump 10 characters at a time. Once you have found the desired character, press  to validate and move to the next character. Press  to remove the last character.

There are also shortcuts for commonly used characters:





-  -  selects the corresponding numeric character
-  selects ?
-  selects =
-     are shortcuts for the corresponding mathematical operator signs
-  selects space



Once the character appears, press  to validate. Press  to exit message entry.


















If you want to modify a message that has been entered in a program, select the message and

press  (HOLD)  message mode.





As an example using the message mode, let's return to our sphere calculation program:




1.    opens the Program menu, and you are now at step 1 of Program 0. To insert a message at step 1 and push everything else down, simply begin editing at step 1. If you want to delete the current step, press .

2. Press  (HOLD) .






3. Press  until the letter **R** appears, and then press . Press  and the screen should display a **?**.
4. Press  to exit.
5. Press  (HOLD) . Then press  to exit.
6. Now enter program mode again by pressing  . The display will show **R?** in video inverse. Since program 0 has a message as the first command, it is now named **R?**. The video inverse signifies that it is assigned to a key, in this case . Press  to exit.
7. Now press  . Notice **R?** appears, and the program pauses to wait for input.  
Type   and press  (HOLD)  to resume. The program continues and calculates the volume.

## Debugging a Program



At times, programs do not work as expected. You can debug your programs by pressing the  (HOLD)  or  (HOLD)  keys as follows:

Open the Program menu and select the program you want to debug. To execute the first instruction, press  (HOLD) . Press this key combination repeatedly to execute your program one instruction at a time. The current instruction is displayed as long as the  key is pressed.

If you want to see the next instruction without executing it, press  (HOLD)  in the same manner.

If you want to let the program continue by itself, press  (HOLD) . If you want to start debugging a program in the middle, place a run/stop (R/S) instruction where you want to start debugging the program, run the program and start debugging using  (HOLD)  or  when the program stops due to the R/S.

## Saving, Restoring, and Modifying Mode Settings

Often, programs are designed to run in a specific mode (for example, **FIX 4** or **RPN**). You can use  to recall the current mode, save it, modify the settings, either by going in the menu, or using the  function and then restoring it. For example:






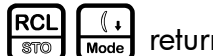

-   recalls and stores the current mode settings in Memory 1.
-  selects **FIX=4**.
- Your program:   restores the mode settings to what they were at the beginning of the program.
-  returns a 12 digit number: **CactdmrvAOff**. See Table 13-4 for a description of each digit.

Table 13-4

Digit	Description
<b>A</b>	is "1" for radian mode, "2" for degree mode.
<b>a</b>	is "1" in Semi-annual mode, "2" in Annual mode.
<b>C</b>	is "1" in Standard TVM mode, "2" in Canadian TVM mode.
<b>c</b>	is "1" in Actual day count mode, "2" in 360 day count mode.
<b>d</b>	is "1" if the decimal separator is ".", 2 for ","
<b>ff</b>	is "00" to "11" or "13" and indicates the FIX setting (13 is for FIX=-1).
<b>m</b>	is "1" for "mm.ddyyyy" mode, "2" for "dd.mmyyyy" mode.
<b>O</b>	is "1" for Chain mode, "2" for Algebraic mode, and "3" for RPN mode.
<b>r</b>	defines the regression line type. "1" for $a*x+b$ , "2" for $a*\ln(x)+b$ , "3" for $b*e^{(ax)}$ , "4" for $b*x^a$ , "5" for $b*a^x$ , "6" for $a/x+b$ and "7" for $ax^2+bx+c$ .
<b>t</b>	is "1" if thousands separators are not visible, "2" if they are visible.
<b>v</b>	is "1" for 2 variable statistics, "2" for 1 variable, and "3" for 1 variable frequency.


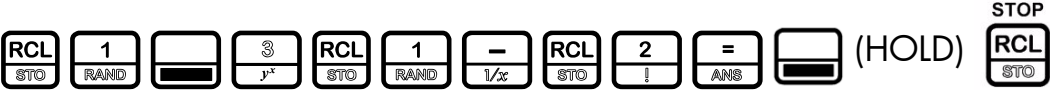



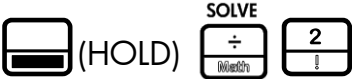

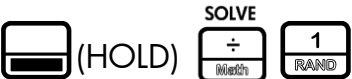

When using , any illegal value is ignored and this setting will not change. For example:

    will switch to RPN mode. No other setting will change.

# Solve

The solve key is not programmable, but it is a powerful addition to the calculator functionality. The solve function utilizes HP Solve, a feature unique to HP calculators, which allows you to find a number for a variable that will cause a program to return a 0. This can be used to solve complex equations.

For example, if you want to solve  $x^x - y = 0$ .

-  (select and edit program 2)
-  (enter program  $var1^{var1} - var2 =$ )
- Press  to exit. Store 3 into variable 2 by pressing . Press  and note that **Prgram 2** is selected, as the calculator displays the program that was last edited. For verification, this program has 11 bytes, and the checksum, 199.
- Press  to solve for variable 2. The calculator will attempt to find what value in variable 2 would cause the program to result in 0. In this case, the result is 27.
- Now store 10 into variable 2: . Since **Prgram 2** was the last program selected in the program menu, you can use the SOLVE feature directly. Press  to solve for variable 1, such that the result of the program is 0. The result this time is 2.506184..., since you stored 10 into variable 2.
- You can verify this is correct by pressing  and see that 10 is returned.





# 14 Error Messages

## Error Messages and Calculator Status

**Table 14-1 Error Messages**

Error Message	Status
ER: Underflow	The calculation generated an underflow (result of 0).
ER: $x/0$	Division by zero.
ER: $0/0$	Zero divided by zero.
ER: $\infty * 0$	Infinite multiplied by zero.
ER: $\infty / \infty$	Infinite divided by infinite.
ER: $\sqrt{\quad}/(x < 0)$	Square root of a negative number.
ER: LN (0)	LN of 0.
ER: LN ( $x < 0$ )	LN of a negative number.
ER: ATrig( $ x  > 1$ )	ASIN or ACOS of a number for which the absolute value is $> 1$ .
ER: $1^{\infty}$	Attempted calculation of $1^{+/-\text{Infinite}}$
ER: $(x < 0)^{\infty}$	Attempted calculation of the infinite power of a negative number.
ER: $\infty^0$	Attempted calculation of $+/-\infty^0$ .
ER: $\infty^{\text{Frac}}$	Attempted calculation of $+/-\infty^{\text{(non-integer y)}}$ .
ER: $(x < 0)^{\text{Frac}}$	Attempted calculation of $(-x)^{\text{(non-integer y)}}$ .
ER: Out of Bounds	Input out of bounds.
ER: Invalid P/YR	Returned by TVM functions if payments per year are invalid (0 or non-integer).
ER: Invalid Input	Returned if arguments are invalid for any reason.
ER: Invalid I%	Returned by finance functions if I is $\leq 100\%$ .
ER: No Solution	Returned when there is no solution to the problem.
ER: Many or No Solutions	Returned if there is no solution, or more than one solution to the problem.
ER: Many Solutions	Returned when there are many solutions to the problem.
ER: Invalid N	Returned by TVM/Amort if N is invalid.
ER: User Abort	Returned by long functions if user stops the calculation prior to completion.
ER: $\infty$ Result	Returned if the result is infinite.
ER: Insufficient Data	Returned by statistics functions if there is insufficient data for analysis.
ER: No Payback	Returned by payback function if there is no payback on this problem.

**Table 14-1 Error Messages**

<b>Error Message</b>	<b>Status</b>
ER: Unique solution to IRR Not Found	Returned if IRR tries to calculate a solution but cannot find it. User should supply a new guess...
ER: Stack	Stack overflow when performing calculations with more than 12 pending operations.
ER: Parenthesis:	An error linked to use of parentheses: unmatched, too many, etc.
ER: Insufficient Memory	Insufficient memory to complete the operation.
ER: No Solution Found	No solution found.

---

# 15 Warranty, Regulatory, and Contact Information

## Replacing the Batteries

Use only fresh batteries. Do not use rechargeable batteries. The calculator takes two, 3-volt CR2032 lithium batteries. To install a new battery:

1. With the calculator turned off, slide the back cover off.
2. Remove one of the old batteries and replace it with a new battery with the positive polarity symbol facing outward.
3. Remove the second battery and replace it with a new battery with the positive polarity symbol facing outward.
4. Replace the back cover.

Warning! There is danger of explosion if the battery is incorrectly replaced. Replace only with the same or equivalent type recommended by the manufacturer. Dispose of used batteries according to the manufacturer's instructions. Do not mutilate, puncture, or dispose of batteries in fire. The batteries can burst or explode, releasing hazardous chemicals.

## HP Limited Hardware Warranty and Customer Care

This HP Limited Warranty gives you, the end-user customer, express limited warranty rights from HP, the manufacturer. Please refer to HP's Web site for an extensive description of your limited warranty entitlements. In addition, you may also have other legal rights under applicable local law or special written agreement with HP.

### Limited Hardware Warranty Period

Duration: 12 months total (may vary by region, please visit [www.hp.com/support](http://www.hp.com/support) for latest information)

## General Terms

HP warrants to you, the end-user customer, that HP hardware, accessories and supplies will be free from defects in materials and workmanship after the date of purchase, for the period specified above. If HP receives notice of such defects during the warranty period, HP will, at its option, either repair or replace products which prove to be defective. Replacement products may be either new or like-new.

HP warrants to you that HP software will not fail to execute its programming instructions after the date of purchase, for the period specified above, due to defects in material and workmanship when properly installed and used. If HP receives notice of such defects during the warranty period, HP will replace software media which does not execute its programming instructions due to such defects.

HP does not warrant that the operation of HP products will be uninterrupted or error free. If HP is unable, within a reasonable time, to repair or replace any product to a condition as warranted, you will be entitled to a refund of the purchase price upon prompt return of the product with proof of purchase.

HP products may contain remanufactured parts equivalent to new in performance or may have been subject to incidental use.

Warranty does not apply to defects resulting from the following:

- a. improper or inadequate maintenance or calibration
- b. software, interfacing, parts or supplies not supplied by HP
- c. unauthorized modification or misuse
- d. operation outside of the published environmental specifications for the product
- e. improper site preparation or maintenance.

HP MAKES NO OTHER EXPRESS WARRANTY OR CONDITION WHETHER WRITTEN OR ORAL. TO THE EXTENT ALLOWED BY LOCAL LAW, ANY IMPLIED WARRANTY OR CONDITION OF MERCHANTABILITY, SATISFACTORY QUALITY, OR FITNESS FOR A PARTICULAR PURPOSE IS LIMITED TO THE DURATION OF THE EXPRESS WARRANTY SET FORTH ABOVE. Some countries, states or provinces do not allow limitations on the duration of an implied warranty, so the above limitation or exclusion might not apply to you. This warranty gives you specific legal rights and you might also have other rights that vary from country to country, state to state, or province to province.

TO THE EXTENT ALLOWED BY LOCAL LAW, THE REMEDIES IN THIS WARRANTY STATEMENT ARE YOUR SOLE AND EXCLUSIVE REMEDIES. EXCEPT AS INDICATED ABOVE, IN NO EVENT WILL HP OR ITS SUPPLIERS BE LIABLE FOR LOSS OF DATA OR FOR DIRECT, SPECIAL, INCIDENTAL, CONSEQUENTIAL (INCLUDING LOST PROFIT OR DATA), OR OTHER DAMAGE, WHETHER BASED IN CONTRACT, TORT, OR OTHERWISE. Some countries, States or provinces do not allow the exclusion or limitation of incidental or consequential damages, so the above limitation or exclusion may not apply to you.

The only warranties for HP products and services are set forth in the express warranty statements accompanying such products and services. HP shall not be liable for technical or editorial errors or omissions contained herein.

FOR CONSUMER TRANSACTIONS IN AUSTRALIA AND NEW ZEALAND: THE WARRANTY TERMS CONTAINED IN THIS STATEMENT, EXCEPT TO THE EXTENT LAWFULLY PERMITTED, DO NOT EXCLUDE, RESTRICT OR MODIFY AND ARE IN ADDITION TO THE MANDATORY STATUTORY RIGHTS APPLICABLE TO THE SALE OF THIS PRODUCT TO YOU.

## Regulatory Information

### Federal Communications Commission Notice

This equipment has been tested and found to comply with the limits for a Class B digital device, pursuant to Part 15 of the FCC Rules. These limits are designed to provide reasonable protection against harmful interference in a residential installation. This equipment generates, uses, and can radiate radio frequency energy and, if not installed and used in accordance with the instructions, may cause harmful interference to radio communications. However, there is no guarantee that interference will not occur in a particular installation. If this equipment

does cause harmful interference to radio or television reception, which can be determined by turning the equipment off and on, the user is encouraged to try to correct the interference by one or more of the following measures:

- Reorient or relocate the receiving antenna.
- Increase the separation between the equipment and the receiver.
- Connect the equipment into an outlet on a circuit different from that to which the receiver is connected.
- Consult the dealer or an experienced radio or television technician for help.

## Modifications

The FCC requires the user to be notified that any changes or modifications made to this device that are not expressly approved by Hewlett-Packard Company may void the user's authority to operate the equipment.

## Declaration of Conformity for Products Marked with FCC Logo, United States Only

This device complies with Part 15 of the FCC Rules. Operation is subject to the following two conditions:

1. This device may not cause harmful interference
2. This device must accept any interference received, including interference that may cause undesired operation.

If you have questions about the product that are not related to this declaration, write to

Hewlett-Packard Company  
P. O. Box 692000, Mail Stop 530113  
Houston, TX 77269-2000

For questions regarding this FCC declaration, write to  
Hewlett-Packard Company  
P. O. Box 692000, Mail Stop 510101  
Houston, TX 77269-2000  
or call HP at 281-514-3333

To identify your product, refer to the part, series, or model number located on the product.

## Canadian Notice

This Class B digital apparatus meets all requirements of the Canadian Interference-Causing Equipment Regulations.

## Avis Canadien

Cet appareil numérique de la classe B respecte toutes les exigences du Règlement sur le matériel brouilleur du Canada.

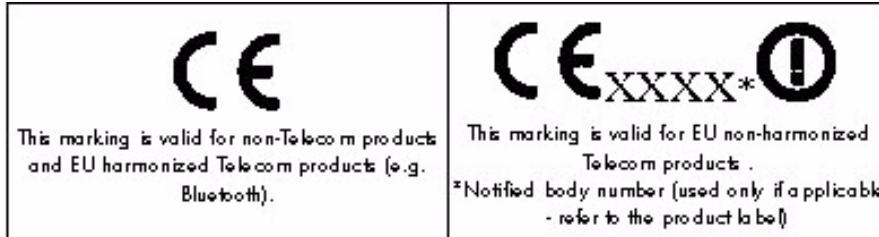
## European Union Regulatory Notice

This product complies with the following EU Directives:

- Low Voltage Directive 2006/95/EC
- EMC Directive 2004/108/EC

Compliance with these directives implies conformity to applicable harmonized European standards (European Norms) which are listed on the EU Declaration of Conformity issued by Hewlett-Packard for this product or product family.

This compliance is indicated by the following conformity marking placed on the product:



Hewlett-Packard GmbH, HQ-TRE, Herrenberger Strasse 140, 71034 Boeblingen, Germany

The official EU CE declaration of conformity for this device may be found at <http://www.hp.com/go/certificates>.

## Japanese Notice

この装置は、クラスB情報技術装置です。この装置は、家庭環境で使用することを目的としていますが、この装置がラジオやテレビジョン受信機に近接して使用されると、受信障害を引き起こすことがあります。

取扱説明書に従って正しい取り扱いをして下さい。 VCCI-B

## Korean Notice

B급 기기 (가정용 방송통신기기)	이 기기는 가정용(B급)으로 전자파적합등록을 한 기기로서 주로 가정에서 사용하는 것을 목적으로 하며, 모든 지역에서 사용할 수 있습니다.
-----------------------	--

## Disposal of Waste Equipment by Users in Private Household in the European Union



This symbol on the product or on its packaging indicates that this product must not be disposed of with your other household waste. Instead, it is your responsibility to dispose of your waste equipment by handing it over to a designated collection point for the recycling of waste electrical and electronic equipment. The separate collection and recycling of your waste equipment at the time of disposal will help to conserve natural resources and ensure that it is recycled in a manner that protects human health and the environment. For more

information about where you can drop off your waste equipment for recycling, please contact your local city office, your household waste disposal service or the shop where you purchased the product.

## Perchlorate Material - special handling may apply

This calculator's Memory Backup battery may contain perchlorate and may require special handling when recycled or disposed in California.

## Customer Care

In addition to the one year hardware warranty your HP calculator also comes with one year of technical support. If you need assistance, HP customer care can be reached by either email or telephone. Before calling please locate the call center nearest you from the list below. Have your proof of purchase and calculator serial number ready when you call.

Telephone numbers are subject to change, and local and national telephone rates may apply. A complete list is available on the web at: [www.hp.com/support](http://www.hp.com/support).

## Contact Information

**Table 15-1 Contact Information**

Country/Region	Contact
Algeria	<a href="http://www.hp.com/support">www.hp.com/support</a>
Anguila	1-800-711-2884
Antigua	1-800-711-2884
Argentina	0-800-555-5000
Aruba	800-8000 ; 800-711-2884
Austria Österreich	01 360 277 1203
Bahamas	1-800-711-2884
Barbados	1-800-711-2884
Belgique (Français)	02 620 00 85
Belgium (English)	02 620 00 86
Bermuda	1-800-711-2884
Bolivia	800-100-193
Botswana	<a href="http://www.hp.com/support">www.hp.com/support</a>
Brazil Brasil	0-800-709-7751
British Virgin Islands	1-800-711-2884
Bulgaria	<a href="http://www.hp.com/support">www.hp.com/support</a>
Canada	800-HP-INVENT
Cayman Island	1-800-711-2884
Chile	800-360-999

**Table 15-1 Contact Information**

<b>Country/Region</b>	<b>Contact</b>
China 中国	800-820-9669
Colombia	01-8000-51-4746-8368 (01-8000-51- HP INVENT)
Costa Rica	0-800-011-0524
Croatia	<a href="http://www.hp.com/support">www.hp.com/support</a>
Curacao	001-800-872-2881 + 800-711-2884
Czech Republic Česká republikaik	296 335 612
Denmark	82 33 28 44
Dominica	1-800-711-2884
Dominican Republic	1-800-711-2884
Egypt	<a href="http://www.hp.com/support">www.hp.com/support</a>
El Salvador	800-6160
Ecuador	1-999-119 ; 800-711-2884 (Andinatel) 1-800-225-528; 800-711-2884 (Pacifitel)
Estonia	<a href="http://www.hp.com/support">www.hp.com/support</a>
Finland Suomi	09 8171 0281
France	01 4993 9006
French Antilles	0-800-990-011; 800-711-2884
French Guiana	0-800-990-011; 800-711-2884
Germany Deutschland	069 9530 7103
Ghana	<a href="http://www.hp.com/support">www.hp.com/support</a>
Greece Ελλάδα	210 969 6421
Grenada	1-800-711-2884
Guadelupe	0-800-990-011; 800-711-2884
Guatemala	1-800-999-5105
Guyana	159 ; 800-711-2884
Haiti	183 ; 800-711-2884
Honduras	800-0-123 ; 800-711-2884
Hong Kong 香港特別行政區	800-933011
Hungary	<a href="http://www.hp.com/support"><b>www.hp.com/support</b></a>
India	1-800-114772
Indonesia	(21)350-3408
Ireland	01 605 0356
Italy Italia	02 754 19 782



**Table 15-1 Contact Information**

<b>Country/Region</b>	<b>Contact</b>
Jamaica	1-800-711-2884
Japan 日本	00531-86-0011
Kazakhstan	www.hp.com/support
Latvia	www.hp.com/support
Lebanon	www.hp.com/support
Lithuania	www.hp.com/support
Luxembourg	2730 2146
Malaysia	1800-88-8588
Martinica	0-800-990-011 ; 877-219-8671
Mauritius	www.hp.com/support
Mexico México	01-800-474-68368 (800 HP INVENT)
Montenegro	www.hp.com/support
Montserrat	1-800-711-2884
Morocco	www.hp.com/support
Namibia	www.hp.com/support
Netherlands	020 654 5301
Netherland Antilles	001-800-872-2881 ; 800-711-2884
New Zealand	0800-551-664
Nicaragua	1-800-0164; 800-711-2884
Norway Norwegen	23500027
Panama Panamá	001-800-711-2884
Paraguay	(009) 800-541-0006
Peru Perú	0-800-10111
Philippines	(2)-867-3351
Poland Polska	www.hp.com/support
Portugal	021 318 0093
Puerto Rico	1-877 232 0589
Romania	www.hp.com/support
Russia Россия	495-228-3050
Saudi Arabia	www.hp.com/support

**Table 15-1 Contact Information**

<b>Country/Region</b>	<b>Contact</b>
Serbia	www.hp.com/support
Singapore	6272-5300
Slovakia	www.hp.com/support
South Africa	0800980410
South Korea 한국	00798-862-0305
Spain España	913753382
St Kitts & Nevis	1-800-711-2884
St Lucia	1-800-478-4602
St Marteen	1-800-711-2884
St Vincent	01-800-711-2884
Suriname	156 ; 800-711-2884
Swaziland	www.hp.com/support
Sweden Sverige	08 5199 2065
Switzerland	022 827 8780
Switzerland (Suisse Français)	022 827 8780
Switzerland (Schweiz Deutsch)	01 439 5358
Switzerland (Svizzera Italiano)	022 567 5308
Taiwan 臺灣	00801-86-1047
Thailand ไทย	(2)-353-9000
Trinidad & Tobago	1-800-711-2884
Tunisia	www.hp.com/support
Turkey Türkiye	www.hp.com/support
Turks & Caicos	01-800-711-2884
UAE	www.hp.com/support
United Kingdom	0207 458 0161
Uruguay	0004-054-177
US Virgin Islands	1-800-711-2884
United States	800-HP INVENT
Venezuela	0-800-474-68368 (0-800 HP INVENT)

**Table 15-1 Contact Information**

<b>Country/Region</b>	<b>Contact</b>
Vietnam Việt Nam	+65-6272-5300
Zambia	<a href="http://www.hp.com/support">www.hp.com/support</a>

**产品中有毒有害物质或元素的名称及含量**  
**根据中国《电子信息产品污染控制管理办法》**

部件名称	有毒有害物质或元素					
	铅 (Pb)	汞 (Hg)	镉 (Cd)	六价铬 (Cr(VI))	多溴联苯 (PBB)	多溴二苯醚 (PBDE)
PCA	X	0	0	0	0	0
外觀殼 / 字鍵	0	0	0	0	0	0

0：表示该有毒有害物质在该部件所有均质材料中的含量均在SJ/T 11363-2006标准规定的限量要求以下。

X：表示该有毒有害物质至少在该部件的某一均质材料中的含量超出SJ/T 11363-2006标准规定的限量要求。

表中标有“X”的所有部件都符合欧盟RoHS法规

“欧洲议会和欧盟理事会2003年1月27日关于电子电器设备中限制使用某些有害物质的2002/95/EC号指令”

注：环保使用期限的参考标识取决于产品正常工作的温度和湿度等条件

# Symbols

## A

Algebraic mode 12

Amortization 29

- Amortization menu 29
- creating a schedule 31
- menu and menu items 30
- resetting menu to defaults 32

Angular mode

- degrees or radians 3

Annunciators 6

## B

Battery

- low battery symbol 1
- replacing the batteries 91

Black-Scholes

- Black-Scholes menu 52
- call price 53
- dividend 53
- example 54
- put price 53
- resetting menu items to defaults 56
- risk-free interest rate 53
- signature return 53
- Stock price 53
- strike price 53
- time to maturity 53

Bond

- accrued interest 48
- Bond menu 48
- calendars 48
- call 48
- coupon rate 48
- example 49
- maturity date 48
- price 48
- resetting menu to defaults 50
- settlement date 48
- yield 48

Bond annual, semiannual 48

Bond type Annual, Semiannual 4

Break-even

- Break-even menu 59
- example 59
- resetting menu items to defaults 60

Business problems

- see Percent Calculation menu 61

## C

Calculation mode

- Chain, Algebraic, RPN, setting preferences 3
- changing the 4

## Calendar

setting, Actual or Cal. 360 4

cash 38

## Cash flow

analyzing with IRR and NPV 41

diagram, description of 27

editing 41

erasing lists and resetting to defaults 38

example 38

IRR and NPV menu items 41

keys used 38

lists 37

sample cash flow diagrams 46

Chain mode 12

checksum 78

Combinations 21

## **D**

### Date

calculation example 57

Date Calculation menu 57

resetting menu items to defaults 58

setting format for 3

debugging 85

### Decimal

comma or point, setting preferences 3

### Default settings

see Mode menu 2

### Depreciation

cost 67

Declining balance 66

Declining balance crossover 66

Depreciation menu 66

example 67

factor 67

French amortization 66

French Straight line 66

life 67

methods 66

remaining book value 67

remaining depreciable value 67

resetting items to defaults 68

salvage 67

start 67

Straight line 66

Sum-of-the-years' digits 66

values required 66

year 67

Discounted payback 41

### Display

contrast 2

degree or radian 3

precision and number format 3

two line 1

## **E**

Error messages 89

## **F**

FMRR 41

    example 44

## **I**

Insert and delete keys 38

Interest Conversion

    Interest Conversion menu 33

    resetting the menu to defaults 34

    using P/YR and C/YR 33

Internal rate of return 41

Investment Rate 41

## **K**

Key

    ANS, last operation, last number 19

    change sign 11

    cosine 19

    equals 6

    factorial 19

    input key 6

    insert and delete 38

    LN, natural log 19

    natural exponent 19

    On/CE 7

    parentheses 12

    presses 4

    random function 19

    recall 24

    reciprocal 19

    round 19

    scientific notation 11

    secondary functions 4

    shift key 4

    sine 19

    square 19

    square root 19

    store 24

    tangent 19

    up and down scroll keys 2

key instructions 76

key presses 75

Keyboard map and legend v

## **L**

Language

    selecting a 1

## **M**

Margin

    See Percent Calculation menu 61

Markup

    See Percent Calculation menu 61

## Math

Math menu 18

## Menu

Black-Scholes menu 51

Bond menu 47

Break-even menu 59

Data menu 70

Date Calculation menu 57

Depreciation menu 65

Math menu 19

Mode menu, setting preferences and number format 2

NPV and IRR menus 41

Percent Calculation menu 61

Reset menu 7

Statistics menu 70

Time Value of Money keys 27

messages 84

MIRR 41

example 44

mode settings 86

## **N**

Net Future Value 41

Net Present Value 41

Net US 41

Number

entry 11

last number function 14

rounding 25

storing and recalling 24

Number format

setting preferences 2

## **O**

on HP 30b 75

## **P**

Parentheses

prioritizing operations 12

Payback 41

Percent Calculation

compounding periods 63

examples 62

markup and margin 61

Percent Calculation menu 61

percentage of total 61

resetting menu items to defaults 64

sub-menus 61

Percentages 25

Permutations 23

PI

location of, entering for calculations. See also, Math menu 21

Probability Sub-menu

see also, Math menu 21

program step 0 78



Programming 75, 76, 78, 79, 83, 84, 85, 86

Decrement, skip 83

display 83

editing programs 80

erasing 80

example 77

executing 80

Program menu 75

R/S pause and return 83

solve 87

sub-function call 82

test and jump 81

## R

reassigning menu functions 79

Recall

number 24

Reverse Polish Notation

see RPN 13

RPN

description of 13

example 15

manipulating the stack 15

roll down 17

stack 13

swap 18

## S

Safe interest rate 41

saving, storing, modifying 86

Scientific notation 11

Statistics

a slope for linear model 71

b y-intercept for linear model 71

covariance 71

data entry, sub-menus 70

example 72

maximum and minimum 71

median 71

number of items 70

one-variable 70

population standard deviation for X and Y 71

predictions for X and Y 71

quartile 71

resetting items to defaults 74

sample error for X and Y 71

standard deviation, X and Y 70

Statistics menu 69

two-variable 70

X mean 70

Y mean 70

stop 83

Store

numbers 24

## T

Thousands separator 3

Time Value of Money

see TVM 27

TVM

begin mode 28

Canadian Mortgage example 35

end mode 28

example 28

future value 28

keys 28

nominal interest rate 28

number of payments 28

number of payments per year 28

periodic payment value 28

present value 28

setting for TVM Standard or TVM Canada 4

storing and recalling with TVM keys 24

storing values in TVM variables 28

TVM Canada, Canadian mortgages 35

## Free Manuals Download Website

<http://myh66.com>

<http://usermanuals.us>

<http://www.somanuals.com>

<http://www.4manuals.cc>

<http://www.manual-lib.com>

<http://www.404manual.com>

<http://www.luxmanual.com>

<http://aubethermostatmanual.com>

Golf course search by state

<http://golfingnear.com>

Email search by domain

<http://emailbydomain.com>

Auto manuals search

<http://auto.somanuals.com>

TV manuals search

<http://tv.somanuals.com>