

HP3852A Data Acquisition/Control Unit

High-Speed Voltmeters

HP 44702A/B and HP 44704A

Configuration and Programming Manual



©Copyright Hewlett-Packard Company 1990

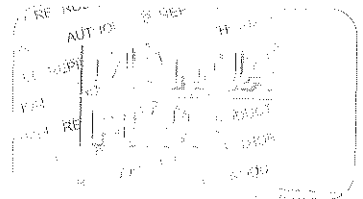

Manual Part Number: 44702-90002
Microfiche Part Number: 44702-99002

Printed: JANUARY 1990 Edition 2
Printed in USA E0190

1
2
3
4
5
6
7
8
9
10
11
12
13
14
15
16
17
18
19
20
21
22
23
24
25
26
27
28
29
30
31
32
33
34
35
36
37
38
39
40
41
42
43
44
45
46
47
48
49
50
51
52
53
54
55
56
57
58
59
60
61
62
63
64
65
66
67
68
69
70
71
72
73
74
75
76
77
78
79
80
81
82
83
84
85
86
87
88
89
90
91
92
93
94
95
96
97
98
99
100

Appendix A

Specifications

Contents

DC Voltage	A-1
Accuracy:	A-1
1 Year Accuracy	A-1
Temperature coefficient:	A-2
Resolution:	A-2
Over-ranging:	A-2
Reading Rate:	A-2
Resistance	A-3
Accuracy:	A-3
1 Year Accuracy	A-3
Temperature coefficient:	A-4
Reading Rate:	A-4

Specifications

DC Voltage

Accuracy: \pm (% of reading + volts) in 16-bit mode, rear terminal input, one-hour warm-up, specified over time since last calibration, and operating temperature, with auto-zeroing performed within one minute of measurement. Accuracy in 13-bit and 14-bit modes limited to resolution of reading.

90 Days, 18 to 28 °C

Range	Accuracy
40 mV	.03% + 30 μ V
320 mV	.015% + 50 μ V
2.56 V	.015% + 340 μ V
10.24 V	.015% + 1.35 mV

Averaged Readings, 90 Days, 18 to 28 °C

Accuracy if 100 readings are averaged.	
Range	Accuracy
40 mV	.03% + 10 μ V
Accuracy if 10 readings are averaged: (little advantage to averaging more readings)	
Range	Accuracy
320 mV	.015% + 18 μ V
2.56 V	.015% + 113 μ V
10.24 V	.015% + 450 μ V

1 Year Accuracy Add .005% of reading to 90-day specifications

Temperature coefficient: Add as an additional accuracy error using \pm of reading per $^{\circ}\text{C}$ change outside 18 to 28 $^{\circ}\text{C}$, as long as the operation temperature is maintained between 0 to 18 or 28 to 55 $^{\circ}\text{C}$.

Range	Add % of reading
40 mV	.002%
all other ranges	.001%

Resolution: 13, 14, or 16 bits including sign bit

Range	Resolution		
	13-bit	14-bit	16-bit
40 mV	9.77 μV	4.88 μV	1.22 μV
320 mV	78.1 μV	39.1 μV	9.71 μV
2.56 V	625 μV	313 μV	78.1 μV
10.24 V	2.5 mV	1.25 mV	313 μV

Over-ranging: None; maximum signal (high to low) + common mode voltage (low to chassis) to prevent out-of-range indications is ± 10.24 volts

Reading Rate: 100,000 readings/sec in 13-bit, 14-bit, and 16-bit modes. Proper auto-ranging in the 13-bit and 14-bit mode will occur at 100,000 readings/sec as long as a single-channel signal changes no more than 600 volts/sec during auto-ranging.

Resistance

Accuracy: \pm (% of reading + ohms), 4- or 2-wire ohms, max resistance expected (resistance function) determines the current source used, rear terminal inputs, one-hour warmup, specified over time since of last calibration, and operating temperature, with auto-zeroing performed within one minute of measurement. Current source compliance voltage is at least 17 V. For high-speed (ribbon cable) operation, only the HP 44711B or HP 44713B FET multiplexer is recommended for measuring resistance properly.

90 Days, 18 to 28 °C

10 kohm Function (1 mA current source)	
Range	Accuracy
40 ohms	.055% + 60 mohms
320 ohms	.04% + 70 mohms
2.56 kohms	.04% + 450 mohms
10.24 kohms	.04% + 1.8 ohms
100 kohm Function (100 μ A current source) Range:	
400 ohms	.055% + 0.6 ohms
3.2 kohms	.04% + 0.7 ohms
25.6 kohms	.04% + 4.5 ohms
102.4 kohms	.04% + 18 ohms
1 Mohm Function (10 μ A current source) Range:	
4 kohms	.055% + 6 ohms
32 kohms	.04% + 7 ohms
256 kohms	.04% + 45 ohms
1.024 kohms	.04% + 180 ohms

Averaged Readings, 90 Days, 18 to 28 °C

Accuracy if 100 readings are averaged:	
Range	Accuracy
40 ohm	.055% + 15 mohms
4 kohm	.055% + 150 mohms
400 ohm	.055% + 1.5 ohms
Accuracy if 10 readings are averaged: (little advantage to averaging more readings)	
320 ohm	.04% + 18 mohms
3.2 kohm	.04% + 180 mohms
32 kohm	.04% + 1.8 ohms
2.56 kohm	.04% + 113 mohms
25.6 kohm	.04% + 1.13 ohms
256 kohm	.04% + 11.3 ohms
10.24 kohm	.04% + 450 mohms
102.4 kohm	.04% + 4.5 ohms
1.024 Mohm	.04% + 45 ohms

1 Year Accuracy Add .01% of reading to 90-day specifications

Temperature coefficient: Add as an additional accuracy error using \pm (% of reading + volts) per °C change outside 18 to 28 °C, as long as the operating temperature is maintained between 0 to 18 or 28 to 55 °C.

Range	Add % of reading Range:
40 ohm, 400 ohm, 4 kohm	.003%
all other ranges	.002%

Reading Rate: 100,000 readings/sec in 13-bit, 14-bit, and 16-bit modes. Proper auto-ranging in the 13-bit and 14-bit mode will occur at 100,000 readings/sec as long as a single-channel signal changes no more than 600 volts/sec during auto-ranging.

Printing History

The Printing History shown below lists the printing dates of all Editions and Updates created for this manual. The Edition number changes as the manual undergoes subsequent revisions. Editions are numbered sequentially starting with Edition 1. Updates, which are issued between Editions, contain individual replacement pages which the customer uses to update the current Edition of the manual. Updates are numbered sequentially starting with Update 1. When a new Edition is created, all Updates associated with the previous Edition are merged into the manual. Each new Edition or Update also includes a revised copy of this printing history page.

Many product updates and revisions do not require manual changes and, conversely, manual corrections may be done without accompanying product changes. Therefore, do not expect a one-to-one correspondence between product updates and manual updates.

Edition 1 (Part Number 44702-90001)	MARCH 1987
Edition 2 (Part Number 44702-90002)	JANUARY 1991

RESTRICTED RIGHTS LEGEND

Use, duplication, or disclosure by the Government is subject to restrictions as set forth in subdivision (b)(3)(ii) of the Rights in Technical Data and Computer Software clause at 52.227-7013.

Hewlett-Packard Company
3000 Hanover Street, Palo Alto, California 94304





**HEWLETT
PACKARD**

Herstellerbescheinigung

Hiermit wird bescheinigt, daß das Gerät/System HP 3852A
in Übereinstimmung mit den Bestimmungen von Postverfügung 1046/84 funkentstört ist.

Der Deutschen Bundespost wurde das Inverkehrbringen dieses Gerätes/Systems angezeigt und die Berechtigung zur Überprüfung der Serie auf Einhaltung der Bestimmungen eingeräumt.

Zusatzinformation für Meß- und Testgeräte

Werden Meß- und Testgeräte mit ungeschirmten Kabeln und/oder in offenen Meßaufbauten verwendet, so ist vom Betreiber sicherzustellen, daß die Funk-Entstörbestimmungen unter Betriebsbedingungen an seiner Grundstücksgrenze eingehalten werden.

Manufacturer's declaration

This is to certify that the equipment HP 3852A
is in accordance with the Radio Interference Requirements of Directive FTZ 1046/84. The German Bundespost was notified that this equipment was put into circulation, the right to check the series for compliance with the requirements was granted.

Additional Information for Test- and Measurement Equipment

If Test- and Measurement Equipment is operated with unshielded cables and/or used for measurements on open set-ups, the user has to assure that under operating conditions the Radio Interference Limits are still met at the border of his premises.

NOTICE

The information contained in this document is subject to change without notice.

HEWLETT-PACKARD MAKES NO WARRANTY OF ANY KIND WITH REGARD TO THIS MATERIAL, INCLUDING, BUT NOT LIMITED TO, THE IMPLIED WARRANTIES OF MERCHANTABILITY AND FITNESS FOR A PARTICULAR PURPOSE. Hewlett-Packard shall not be liable for errors contained herein or for incidental or consequential damages in connection with the furnishing, performance or use of this material.

Hewlett-Packard assumes no responsibility for the use or reliability of its software on equipment that is not furnished by Hewlett-Packard.

This document contains proprietary information which is protected by copyright. All rights are reserved. No part of this document may be photocopied, reproduced or translated to another language without the prior written consent of Hewlett-Packard Company.

Copyright © 1985 by HEWLETT-PACKARD COMPANY



CERTIFICATION

Hewlett-Packard Company certifies that this product met its published specifications at the time of shipment from the factory. Hewlett-Packard further certifies that its calibration measurements are traceable to the National Institute of Standards and Technologies, to the extent allowed by the the Institute's calibration facility, and to the calibration facilities of other International Standards Organization members.

WARRANTY

This Hewlett-Packard instrument product is warranted against defects in materials and workmanship for a period of one year from date of shipment. During the warranty period, Hewlett-Packard Company will, at its option, either repair or replace products which prove to be defective.

For warranty service or repair, this product must be returned to a service facility designated by -hp-. Buyer shall prepay shipping charges to -hp- and -hp- shall pay shipping charges to return the product to Buyer. However, Buyer shall pay all shipping charges, duties, and taxes for products returned to -hp- from another country.

Duration and conditions of warranty for this instrument may be superceded when the instrument is integrated into (becomes a part of) other -hp- instrument products.

Hewlett-Packard warrants that its software and firmware designated by -hp- for use with an instrument will execute its programming instructions when properly installed on that instrument. Hewlett-Packard does not warrant that the operation of the instrument, or software, or firmware will be uninterrupted or error free.

LIMITATION OF WARRANTY

The foregoing warranty shall not apply to defects resulting from improper or inadequate maintenance by Buyer, Buyer-supplied software or interfacing, unauthorized modification or misuse, operation outside of the environmental specifications for the product, or improper site preparation or maintenance.

NO OTHER WARRANTY IS EXPRESSED OR IMPLIED. HEWLETT-PACKARD SPECIFICALLY DISCLAIMS THE IMPLIED WARRANTIES OF MERCHANTABILITY AND FITNESS FOR A PARTICULAR PURPOSE.

EXCLUSIVE REMEDIES

THE REMEDIES PROVIDED HEREIN ARE BUYER'S SOLE AND EXCLUSIVE REMEDIES. HEWLETT-PACKARD SHALL NOT BE LIABLE FOR ANY DIRECT, INDIRECT, SPECIAL, INCIDENTAL, OR CONSEQUENTIAL DAMAGES, WHETHER BASED ON CONTRACT, TORT, OR ANY OTHER LEGAL THEORY.

ASSISTANCE

Product maintenance agreements and other customer assistance agreements are available for Hewlett-Packard products.

For any assistance, contact your nearest Hewlett-Packard Sales and Service Office. Addresses are provided at the back of this manual.



SAFETY SUMMARY

The following general safety precautions must be observed during all phases of operation, service, and repair of this instrument. Failure to comply with these precautions or with specific warnings elsewhere in this manual violates safety standards of design, manufacture, and intended use of the instrument. Hewlett-Packard Company assumes no liability for the customer's failure to comply with these requirements.

GROUND THE INSTRUMENT

To minimize shock hazard, the instrument chassis and cabinet must be connected to an electrical ground.

DO NOT OPERATE IN AN EXPLOSIVE ATMOSPHERE

Do not operate the instrument in the presence of flammable gases or fumes. Operation of any electrical instrument in such an environment constitutes a definite safety hazard.

KEEP AWAY FROM LIVE CIRCUITS

Operating personnel must not remove instrument covers. Component replacement and internal adjustments must be made by qualified maintenance personnel. Under certain conditions, dangerous voltages may exist even with the instrument switched off. To avoid injuries, always disconnect input voltages and discharge circuits before touching them.

DO NOT SERVICE OR ADJUST ALONE

Do not attempt internal service or adjustment unless another person, capable of rendering first aid and resuscitation, is present.

DO NOT SUBSTITUTE PARTS OR MODIFY INSTRUMENT

Because of the danger of introducing additional hazards, do not install substitute parts or perform any unauthorized modification to the instrument. Return the instrument to a Hewlett-Packard Sales and Service Office for service and repair to ensure that safety features are maintained.

DO NOT OPERATE A DAMAGED INSTRUMENT

Whenever it is possible that the safety protection features built into this instrument have been impaired, either through physical damage, excessive moisture, or any other reason, REMOVE POWER and do not use the instrument until safe operation can be verified by service-trained personnel. If necessary, return the instrument to a Hewlett-Packard Sales and Service Office for service and repair to ensure that safety features are maintained.



Operating and Safety Symbols

Symbols Used On Products And In Manuals

- LINE AC line voltage input receptacle.



Instruction manual symbol affixed to product. Cautions the user to refer to respective instruction manual procedures to avoid possible damage to the product.



Indicates dangerous voltage – terminals connected to interior voltage exceeding 1000 volts.

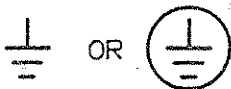

Protective conductor terminal. Indicates the field wiring terminal that must be connected to earth ground before operating equipment – protects against electrical shock in case of fault.



Clean ground (low-noise). Indicates terminal that must be connected to earth ground before operating equipment – for single common connections and protection against electrical shock in case of fault.



Frame or chassis ground. Indicates equipment chassis ground terminal – normally connects to equipment frame and all metal parts.



Affixed to product containing static sensitive devices – use anti-static handling procedures to prevent electrostatic discharge damage to components.

NOTE

NOTE

Calls attention to a procedure, practice, or condition that requires special attention by the reader.

CAUTION

CAUTION

Calls attention to a procedure, practice, or condition that could possibly cause damage to equipment or permanent loss of data.

WARNING





WARNING

Calls attention to a procedure, practice, or condition that could possibly cause bodily injury or death.

WARNING, CAUTION, and NOTE Symbols

Some labels on the HP 3852A, HP 3853A, and plug-in accessories include an international warning symbol (triangle with subscripted number) which refers the reader to the manuals for further information. This table shows the warning symbols used for the HP 3852A/3853A and plug-in accessories. Refer to the manual set for specific information on WARNINGS, CAUTIONS, or NOTES referenced with a warning symbol.

HP 3852A WARNING, CAUTION, and NOTE Symbols

Symbol	Meaning	Location
	Shock hazard originating outside the instrument (field wiring)	<ul style="list-style-type: none"> . Analog Extender Connector on Power Supply Modules . Terminal modules on plug-in accessories . Component module covers on plug-in accessories
	Treat all channels as "one circuit" for safety purposes.	<ul style="list-style-type: none"> . Inside terminal modules on plug-in accessories . Metal cover on component modules of plug-in accessories
	Maximum number of certain plug-in accessories to be installed into an HP 3852A or HP 3853A.	<ul style="list-style-type: none"> . HP 44701A, HP 44702A/B, HP 44727A/B/C plug-in accessories
	If High-Speed FET multiplexers are used with the HP 44702A/B, ribbon cable may be connected.	<ul style="list-style-type: none"> . HP 44711A, 44712A, 44713A (referenced on HP 44702A and HP 44702B)

1
2
3
4
5
6
7
8
9
10
11
12
13
14
15
16
17
18
19
20
21
22
23
24
25
26
27
28
29
30
31
32
33
34
35
36
37
38
39
40
41
42
43
44
45
46
47
48
49
50
51
52
53
54
55
56
57
58
59
60
61
62
63
64
65
66
67
68
69
70
71
72
73
74
75
76
77
78
79
80
81
82
83
84
85
86
87
88
89
90
91
92
93
94
95
96
97
98
99
100

TABLE OF CONTENTS

Chapter 1 – Introduction		
Manual Contents	1-1	
Using This Manual	1-1	
Voltmeter Descriptions	1-3	
Getting Started	1-4	
Chapter 2 – Defining Your Measurement		
Introduction	2-1	
Measurements Overview	2-1	
Measurement Types	2-1	
Voltmeter Programming	2-3	
Data Transfers	2-4	
Defining Measurement Requirements	2-5	
Measurement Parameters	2-5	
Data/ Interrupt Requirements	2-6	
Selecting Voltmeter Configuration	2-7	
Voltmeter Function	2-7	
Multiplexers Used	2-8	
Triggering Method	2-10	
Programming Mode	2-10	
Configuration Examples	2-11	
Chapter 3 – Installation and Checkout		
Introduction	3-1	
Chapter Contents	3-1	
Warnings, Cautions, and Notes	3-1	
Connecting User Inputs	3-5	
Multiplexer Connections	3-5	
Rear Panel Connections	3-5	
Installing the Voltmeter	3-9	
Multiplexer Measurements Installation	3-9	
Ribbon Cable Measurements Installation	3-12	
Initial Checks	3-12	
Voltmeter ID Check	3-12	
Voltmeter Self-Test	3-12	
Checking Wiring Connections	3-15	
Mainframe Firmware Revision	3-16	
Chapter 4 – System Mode Programming		
Introduction	4-1	
Chapter Contents	4-1	
Program Titles	4-1	
Getting Started	4-2	
Measurements Using CONFMEAS	4-4	
CONFMEAS Command	4-4	
CONFMEAS Operation	4-7	
CONFMEAS Presets	4-7	
Examples: Measurements Using CONFMEAS	4-9	
Measurements Using CONF and MEAS	4-11	
Programming Overview	4-11	
Setting Voltmeter Operation	4-17	
Setting Voltmeter Triggering	4-20	
Setting Scan Triggering	4-23	
Measurements Not Using MEAS	4-24	
Low-Level Multiplexer Measurements	4-25	
Rear Panel Measurements	4-27	
Enabling Interrupts	4-30	
System Mode Command Summary	4-36	
Chapter 5 – Scanner Mode Programming		
Introduction	5-1	
Chapter Contents	5-1	
Scanner Mode Measurements	5-2	
Getting Started	5-4	
Measurements Using CONFMEAS	5-6	
CONFMEAS Programming	5-6	
CONFMEAS Measurement Examples	5-11	
Measurements Using CONF and MEAS	5-13	
Programming Overview	5-14	
CONF and MEAS Overview	5-16	
Selecting Voltmeter Configuration	5-22	
Selecting Voltmeter Triggering	5-26	
Measurements Using CONF and Low-Level Commands	5-31	
Programming Overview	5-32	
Scanner Mode Overview	5-34	
Selecting Voltmeter Configurations	5-41	
Selecting Voltmeter Triggering	5-52	
Selecting Data Transfers/ Interrupts	5-77	
Measurement Examples	5-86	
Digitizing Waveforms	5-86	
High-Speed Data Transfers	5-91	
Special Applications	5-96	
Scanner Mode Command Summary	5-107	
Chapter 6 – The HP 44704A in 16 Bit Mode		
Introduction	6-1	
Chapter Contents	6-1	
The 16 Bit Data Format	6-1	
Controlling Voltmeter Ranges	6-1	
Changing Ranges	6-3	
Managing Range Information	6-3	
System Mode and Range	6-4	
Scanner Mode and Range	6-5	
Entering 16 Bit Resolution Mode	6-10	
Chapter 7 – GPIO Operation		
Introduction	7-1	
The GPIO Interface	7-1	
GPIO Interface Signals	7-2	
GPIO Signal Timing	7-3	
GPIO Interface Switches	7-3	
GPIO Programming	7-4	
GPIO Data Transfers	7-5	
GPIO Triggering	7-9	
GPIO Interrupts	7-10	
Programming Examples	7-10	
Example: GPIO Operations	7-11	

Example: Transfer Data @ 100 kHz 7-15

Chapter 8 – Using Read/Write Registers

Introduction 8-1
Register Definitions 8-1
Reading the Registers 8-2

Chapter A – Specifications

DC Voltage A-1
Accuracy: A-1
Temperature coefficient: A-2
Resolution: A-2
Over-ranging: A-2
Reading Rate: A-2
Accuracy: A-3
Temperature coefficient: A-4
Reading Rate: A-4

Chapter 1

Introduction

Contents

Manual Contents	1-1
Using This Manual	1-1
Voltmeter Descriptions	1-3
Getting Started	1-4

Introduction

Manual Contents

This manual shows how to configure and program the HP High-Speed Voltmeters (HP 44702A/B and HP 44704A). The manual has eight chapters:

- **Chapter 1 - Introduction** contains a manual overview, summarizes voltmeter features, and shows a suggested getting started sequence.
- **Chapter 2 - Defining Your Measurement** gives guidelines to select measurement requirements and voltmeter operating parameters for your measurement.
- **Chapter 3 - Installation and Checkout** shows how to connect user inputs and how to install and check the voltmeter.
- **Chapter 4 - System Mode Programming** shows how to use System Mode commands for multiplexer and rear panel measurements.
- **Chapter 5 - Scanner Mode Programming** shows how to use Scanner Mode commands for ribbon cable and rear panel measurements.
- **Chapter 6 - The HP 44704A in 16-Bit Mode** explains some differences in operation when using this high resolution mode.
- **Chapter 7 - GPIO Operation** shows how to use GPIO operation for measurements.
- **Chapter 8 - Using Read/Write Registers** shows how to access the voltmeter read and write registers.

Using This Manual

The HP 44704A in its 13 and 14 bit resolution modes is so similar in operation to the HP 44702A/B that Chapters 2 through 5, and 7 and 8 apply to both models. Refer to these chapters when learning to use either model. Owners of the HP 44704A who will use its 16 bit resolution mode should refer to Chapter 6 for a discussion of programming differences for this mode.

Voltmeter Measurements

The High Speed Voltmeters can directly measure DC voltage and resistance. By using an appropriate multiplexer, you can make DC voltage, DC current, resistance, strain, or temperature measurements.

Four ranges (40 mV, 320 mV, 2.56 V, and 10.24 V) plus autorange are available for voltage measurements. Three current source levels (10 A, 100 A, and 1 mA) are available for resistance measurements.

GPIO Port

Use the GPIO port to directly output data from the voltmeter memory to the controller via GPIO. With GPIO, the user must convert raw voltmeter data (PACKED format) to readable data.

Rear Panel Terminals

Use the voltage input terminals (HI, LO, CHASSIS) to make DC voltage measurements. Use the current source terminals and the voltage terminals for 4-wire ohms measurements. When these terminals are used, multiplexer inputs to the voltmeter are not required (or allowed).

External Trigger Ports

Use the EXTERNAL TRIGGER Ports (EXT0 and EXT1) to input an external trigger to the voltmeter. When programmed, EXT0 can also output a trigger signal for applications such as synchronizing operation of other HP 44702A/B voltmeters.

Release Lever

Lift and pull on the release lever to remove the voltmeter from its slots. Since the HP High Speed Voltmeter requires two slots, it cannot be installed in slots 3 and 4 of the mainframe or in slots 5 and 6 of a HP 3853A Extender.

User Signal Inputs

User signals can be input to the voltmeter on one of three ways:

- (1) Directly into the rear panel terminals (rear panel measurements).
- (2) Via multiplexers and the mainframe backplane into the backplane connectors (multiplexers measurements).
- (3) Via High-Speed FET multiplexers and a dedicated ribbon cable into the ribbon cable connector (ribbon cable measurements).

Reading Rates

Make up to 100,000 readings/second with autoranging. Proper autoranging is ensured as long as a single-channel signal does not change more than 600 volts/sec during autoranging.

For multiplexer measurements, make measurements at speeds up to 100,000 readings/second on a single channel or up to 5500 channels/second (with FET multiplexers) on channel-to-channel scans.

For ribbon cable measurements, make measurements at speeds up to 100,000 readings/second for single-channel and channel-to-channel measurements.

Operating Modes

The voltmeter has two modes of operation: System Mode and Scanner Mode. In Scanner Mode, the user has the full set of commands and capabilities to use the voltmeter. In System Mode, the user has a simplified version of the commands available.

Use System Mode operation for rear panel or multiplexer measurements. Use Scanner Mode operation for panel, multiplexers, or ribbon cable measurements. For rear panel or multiplexer measurements, the voltmeter is controlled by the mainframe. For ribbon cable measurements, the voltmeter is capable of independent operation.

On-Board Buffer

The voltmeter has an on-board storage buffer. All readings are first stored in the buffer. Readings stored in the buffer can be sent to mainframe memory, to the HP-IB output buffer, or to the GPIO port.

Differential Input

The voltmeter uses a balanced input, differential measurement technique. With this method, equal impedances between high to chassis and low to chassis provide good common mode noise rejection.

The voltmeter does not have overranging. Maximum signal (high to low) plus common mode voltage (low to chassis) to prevent and overload indication (IE + 38) must be 10.24 V.

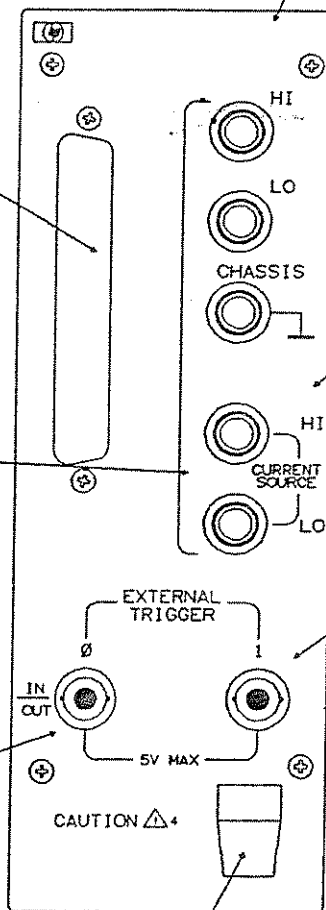

Figure 1-1. Voltmeter Features

Voltmeter Descriptions

The HP 44702A, HP 44702B, and HP 44704A are high-speed voltmeters which can make DC voltage, resistance, strain, and temperature measurements at speeds up to 100,000 readings/second. In addition, with an external shunt resistor, the voltmeters can be used to make current measurements.

The HP 44702A/B voltmeter provides 13 bit resolution (12 bits plus sign bit). The HP 44704A voltmeter provides a choice of three resolutions:

- **13 bit resolution** provides complete performance and programming compatibility with the HP 44702A/B
- **14 bit resolution** provides twice the resolution of the HP 44702A/B. Except for its 14 bit packed data format, the HP 44704A in 14 bit mode operates and programs like the HP 44702A/B.
- **16 bit resolution** provides eight times the resolution of the HP 44702A/B. Except for its 16 bit packed data format, and manually programmed range setting, the HP 44704A in the 16 bit mode programs and operates like the HP 44702A/B.

The HP 44704A also adds the capability to programmatically (using the FILTER command) switch in a low-pass filter to help measure noisy signals.

Both voltmeters use the successive approximation technique for analog-to-digital conversion. Figure 1-1 summarizes voltmeter features.

NOTE

Except for the amount of memory, the HP 44702A and 44702B are identical. The HP 44702A can store up to 8,192 readings (8k). The HP 44702B (has the 44703C memory card added) can store 65,536 readings (64k). The HP 44702A can be upgraded by ordering and installing the HP 44703C Extended Memory Board. HP 44702B versions shipped from the factory have the HP 44703C board installed.

The HP 44704A can store 65,536 (64k) readings.

NOTE on Firmware Revision

Your HP 3852A mainframe must have firmware revision 4.2 or greater to take advantage of the HP 44704A's 14 and 16 bit resolution modes. With earlier revisions, the HP 44704A emulates an HP 44702B.

Getting Started

There are three main steps to configure and program the voltmeter for your application:

- Define your measurement
- Configure the voltmeter
- Program the voltmeter

Define Your Measurement

The first step is to define your measurement application and select voltmeter operation for the measurement. Refer to Chapter 2 - Defining Your Measurement for guidelines.

Configure the Voltmeter

Next, hardware configure the voltmeter for the measurement. Refer to Chapter 3 - Installation and Checkout to connect user inputs and trigger sources (as required) and to install and initially check the voltmeter.

Program the Voltmeter

The voltmeter has two programming modes: System Mode and Scanner Mode. Typically, System Mode is used when high-speed scanning is not required. With System Mode, a subset of the voltmeter commands are available and multiplexer or rear panel measurements can be made. Refer to Chapter 4 - System Mode Programming to program the voltmeter for System Mode measurements.

For high-speed measurements, you will need to use Scanner Mode operation. With Scanner Mode, data can be transferred to the mainframe memory at rates up to 90,000 readings per second, to an HP Series 200/300 controller via HP-IB at rates up to 35,000 readings per second, or to an HP Series 200/300 controller via GPIO at rates up to 100,000 readings per second.

Therefore, for measurement speeds up to 90,000 readings per second, refer to Chapter 5 - Scanner Mode Programming. For measurement speeds up to 100,000 readings per second, first refer to Chapter 5 for information on Scanner Mode programming and then to Chapter 7 - GPIO Operation for information on GPIO programming.

If you intend to use the HP 44704A in its 16 bit resolution mode (RESOL 16 command), refer to Chapter 6 - The HP 44704A in 16 Bit Mode for programming differences for this mode.

If you need to access the voltmeter read/write registers, refer to Chapter 8 - Using Read/Write Registers.



Chapter 2

Defining Your Measurement

Contents

Introduction	2-1
Measurements Overview	2-1
Measurement Types	2-1
Voltmeter Programming	2-3
Data Transfers	2-4
Defining Measurement Requirements	2-5
Measurement Parameters	2-5
Data/ Interrupt Requirements	2-6
Selecting Voltmeter Configuration	2-7
Voltmeter Function	2-7
Multiplexers Used	2-8
Triggering Method	2-10
Programming Mode	2-10
Configuration Examples	2-11

Defining Your Measurement

Introduction

This chapter gives guidelines to define your measurement and to select the proper voltmeter configuration for the measurement. Chapter sections are:

- **Measurements Overview** summarizes the three main parameters of voltmeter measurements: measurement types, voltmeter programming, and data transfers.
- **Defining Measurement Requirements** gives guidelines to define measurement parameters and data/interrupt requirements.
- **Selecting Voltmeter Configuration** gives guidelines to select the voltmeter measurement function, the multiplexer(s) used, the voltmeter triggering method, and programming mode for your measurement.
- **Configuration Examples** shows example voltmeter configurations for typical measurements: one for System Mode and one for Scanner Mode.

Measurements Overview

Figure 2- 1 shows three parameters of voltmeter measurements: measurement types, voltmeter programming, and data transfer.

Measurement Types

There are three main types of voltmeter measurements: multiplexer measurements, ribbon cable measurements, and rear panel measurements.

Multiplexer Measurements

DC voltage, DC current (with multiplexer shunt), resistance (2-wire ohms or 4-wire ohms), strain, or temperature (RTD, thermistor, or thermocouple) inputs can be sent to the voltmeter via HP 447XXX multiplexers and the mainframe backplane. These are called multiplexer (backplane) measurements.

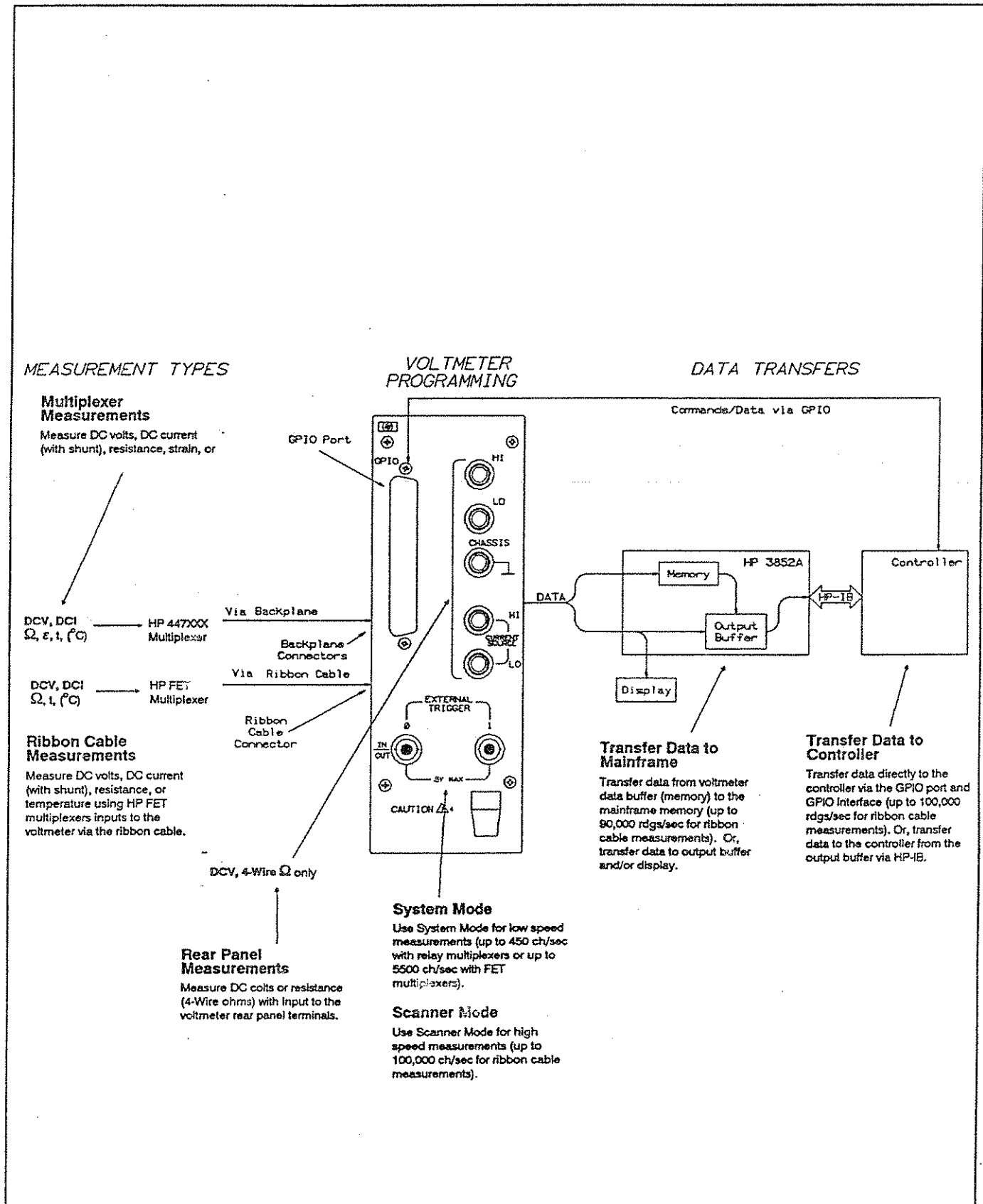

Figure 2-1. Voltmeter Measurements Overview

Since scanning rates for multiplexer measurements are limited to a maximum of about 5500 channels/second, this mode is typically used when high switching rates are not required. Note, however, that you can still make measurements at up to 100,000 readings/sec on a single channel.

Ribbon Cable Measurements

DC volts, DC current (with multiplexer shunt), resistance (4-wire ohms), and temperature inputs can also be sent to the voltmeter via an HP 44711A/B, 44712A, or 44713A/B High-Speed FET Multiplexer over a dedicated ribbon cable connected between the multiplexer and the voltmeter. These are called ribbon cable measurements.

With ribbon cable measurements, data rates up to 100,000 readings/sec in single-channel or in channel-to-channel operation are possible. Thus, ribbon cable measurements are typically used for high-speed scanning and sampling applications.

Rear Panel Measurements

DC volts and 4-wire ohms (only) inputs can be sent directly to the rear panel terminals of the voltmeter. The obvious advantage of rear panel measurements is that a multiplexer is not required. Rear panel measurements can also be used for high-speed measurements up to 100,000 readings/sec.

Voltmeter Programming

The voltmeter has two modes of operation (System Mode and Scanner Mode) as set with the SCANMODE command. SCANMODE OFF sets System Mode while SCANMODE ON sets Scanner Mode. With System Mode operation, only multiplexer and rear panel measurements can be made. With Scanner Mode operation, multiplexer, ribbon cable, and rear panel measurements can be made.

System Mode

System Mode is typically used when high-speed scanning is not required or when the user does not require the full set of commands for the measurement application. System Mode (SCANMODE OFF) is set at power-on, after a reset (RST or RST *slot*), or by sending SCANMODE or SCANMODE OFF.

In System Mode, switching speed is limited to about 450 channels/sec (with relay multiplexers) or to about 5500 channels/sec (with FET multiplexers). The System Mode command set is a simplified version of the Scanner Mode command set and is very similar to the HP 44701A Integrating Voltmeter command set.

Scanner Mode

Scanner Mode operation is set with SCANMODE ON. With Scanner Mode, you can make backplane, ribbon cable, or rear panel measurements and you can use the full set of voltmeter commands. Switching rates up to 100,000 channels/sec are available for ribbon cable measurements.

Data Transfers For any voltmeter measurement, the data is first stored in the on-board voltmeter buffer in PACKED (2 bytes/reading) format. Data stored in the voltmeter can then be transferred to the mainframe memory, to the HP-IB output buffer and/or display, or directly to the controller via the 16-bit parallel (GPIO) interface. Refer to Chapter 6 in the HP 3852A Mainframe Configuration and Programming Manual for details on data storage and transfers.

NOTE

Users of the HP 44704A's 16 bit resolution mode should refer to Chapter 6 for differences in converting 16 bit data and maintaining voltmeter range information.

Transfer Data to Mainframe Memory

Data stored in the voltmeter buffer can be transferred to mainframe memory in unconverted (PACKED) format and stored in a PACKED array or can be converted into RL64 or IN16 and stored in a REAL or INTEGER array (or variable) respectively. Data stored in mainframe memory can then be transferred to the HP-IB output buffer in unconverted or converted format.

Transfer Data Directly to Output Buffer

Data can be transferred directly from the voltmeter buffer to the HP-IB output buffer in unconverted (PACKED) format or in any of six converted formats (IASC, LASC, RASC, DASC, RL64, or IN16). IASC, LASC, RASC, or DASC data can also be displayed.

Transfer Data via GPIO

Data can also be transferred directly from the voltmeter buffer to the controller via the GPIO port and GPIO interface. Data is transferred ONLY in unconverted (PACKED) format and must be converted by the user to a readable format.

Defining Measurement Requirements

Guidelines to help you characterize your measurement follow. When defining your measurement, refer to the Specifications appendix in the HP 3852A Mainframe Configuration and Programming Manual to ensure that the HP 3852A can meet the measurement requirements.

Measurement Parameters

Guidelines follow for these measurement parameters:

- Type of measurement
- Scanning speed
- Number of measurements

Type of Measurement

The first step is to select the type of measurement (DC voltage, DC current, resistance, strain, or temperature) to be made. The voltmeter can measure DC voltages up to ± 10.24 V; resistances up to 1 M Ω with 2-wire or 4-wire techniques; strain from strain gages; or temperatures (in $^{\circ}\text{C}$) from thermocouples, thermistors, or RTDs.

Scanning Speed

Next, determine the scanning speed required for your measurement. The speed selected will influence the multiplexers required. For example, if the speed requirement is less than 450 channels/sec, you can use any of the HP 447XXX multiplexers. However, for high-speed scanning (>5500 channels/sec) you will need to use an HP 44711A/B, 44712A, or 44713A/B multiplexer.

Number of Measurements

Next, determine the number of measurements to be made by defining the number of sources to be measured and the number of measurements per channel. This will determine the number of multiplexers and voltmeters required for your measurement. For example, to measure more than 20 inputs you'll need two HP 44705A 20-channel multiplexers or one HP 44706A 60-channel multiplexer, etc.

Data/ Interrupt Requirements

When you have defined your measurement parameters, determine how to handle the data from the measurement. Three main considerations are:

- Data storage mode
- Data transfer mode
- Interrupt requirements

Data Storage Mode

As shown in Figure 2- 1 , data stored in the voltmeter buffer can be transferred to the mainframe or to the GPIO port. However, data is transferred only when the data is available. The “data available” condition is defined by the data storage mode set with the RDGSMODE command.

In general, data stored in the buffer will not be overwritten when the buffer is full (8192 readings for the HP 44702A or 65536 readings for the HP 44702B and HP 44704A). However, you can transfer data out of the buffer before the buffer fills or you can allow new data to overwrite old data. The four data storage modes follow. Select the mode which best fits your requirements.

Data Available Conditions:

- when any reading is in the buffer.
- when the buffer has room for only 4096 more readings.
- when measurements are complete (data is not overwritten).
- when measurements are complete (data is overwritten).

Data Transfer Mode

Next, select the method to transfer data stored in the voltmeter buffer to the mainframe or to the controller. Measurement data is stored in the voltmeter data buffer in PACKED format (2 bytes/reading). As noted, the HP 44702A can store up to 8192 (8k) readings while the HP 44702B and HP 44704A can store up to 65536 (64k) readings.

PACKED data can be transferred to the mainframe memory at rates up to 90,000 readings/sec or to the controller (via GPIO) at rates up to 100,000 readings/sec. If more readings are required than can be stored in the voltmeter buffer, readings must be transferred as they are taken to avoid buffer overflow.

Interrupt Requirements

Determine if interrupts are required for your measurement. When enabled, interrupts can be handled in the mainframe or in the controller. Note, however, that interrupts are generated only on the "data available" condition specified for the data storage mode.

Selecting Voltmeter Configuration

After you have defined your measurement requirements, select voltmeter configuration for the measurement. Guidelines to select four voltmeter configuration areas follow.

- Voltmeter function
- Multiplexers used
- Triggering method
- Programming mode

Voltmeter Function

As noted, the voltmeter can make DC voltage, DC current (with multiplexer shunt), resistance (2-wire and 4-wire ohms), strain, and temperature (RTD, thermistor, or thermocouple) measurements. Refer to the Specifications Appendix of the HP 3852A Mainframe Configuration and Programming Manual for detailed specifications.

DC Voltage/Current Measurements

The voltmeter has four voltage ranges (40 mV, 320 mV, 2.56V, or 10.24V). The effective range of DC voltage measurements is from ± 10.24 V peak down to about ± 10 μ V with the HP 44702A/B or about ± 1.3 μ V with the HP 44704A in 16 bit mode.

Resistance Measurements

The voltmeter can make 2-wire or 4-wire ohms measurements using HP 447XXX multiplexers or make 4-wire ohms measurements using the rear panel terminals. Three resistance ranges are available: up to 10 k Ω (1 mA current source); up to 100 k Ω (100 μ A source); or up to 1 M Ω (10 μ A source).

Strain Measurements

The voltmeter and the HP 44717A, 44718A, 44719A, or 44720A strain gage multiplexers can be used to make strain measurements, including $\frac{1}{4}$ bridge, $\frac{1}{2}$ bridge, and full-bridge measurements of strain gages or rosettes. For strain measurements, the data is returned in equivalent strain (or microstrain) value. For rosette measurements, the user must convert the data to an equivalent strain value.

Temperature Measurements

The voltmeter can make temperature measurements of thermocouples, thermistors, or resistance temperature detectors (RTD). The data returned is the equivalent temperature in °C. In addition, the reference temperature can be independently measured for thermocouple measurements.

The HP 3852A supports Type B, E, J, K, N14 [N (AWG 14)], N28 [N (AWG 28)], R, S, and T thermocouples, Type 2252, 5K, and 10K thermistors, and Type 85 ($\alpha = .00385 \Omega/\Omega/^{\circ}\text{C}$) or Type 92 ($\alpha = 0.003916 \Omega/\Omega/^{\circ}\text{C}$) RTDs. Other types of thermocouples can be measured with user-supplied linearization programs.

NOTE

Refer to Hewlett-Packard Application Note 290, "Practical Temperature Measurements", (part number 5952-8801) for guidelines on using thermocouples, thermistors, and RTDs for temperature measurements.

Multiplexers Used

As shown in Figure 2-1, there are three types of voltmeter measurements: multiplexer measurements, ribbon cable measurements, and rear panel measurements. The type of measurement selected determines the multiplexer(s) to be used.

Up to six multiplexers (up to eight in an HP 3853A Extender) can be used with a voltmeter. Table 2-1 summarizes the multiplexers available for use with the voltmeter and typical (primary) measurements with each.

Table 2-1. Multiplexer Characteristics

Multiplexer	Ch	Range	Speed*	Primary Measurement
Relay Multiplexers:				
HP 44705A	20	±170V	450	DCV, DCI, 2W/4W Ω, RTDs, thermistors
HP 44705H	20	±354V	250	DCV, DCI, 2W/4W Ω, RTDs, thermistors
HP 44706A	60	±42V	450	DCV, DCI, 2W ohms**
HP 44708A	20	±170V	450	DCV, DCI, 2W Ω, thermocouples**
HP 44708H	20	±354V	250	DCV, DCI, 2W Ω, thermocouples**
HP 44717H	10	±42V	450	120 Ω strain gage, rosettes
HP 44718A	10	±42V	450	350 Ω strain gage, rosettes
FET Multiplexers:				
HP 44709A	20	±10.24V	5500	DCV, DCI, 2W/4W Ω, RTDs, thermistors
HP 44710A	20	±10.24V	5500	DCV, DCI, 2W Ω, thermocouples
HP 44719A	10	±10.24V	5500	120 Ω strain gage, rosettes
HP 44720A	10	±10.24V	5500	350 Ω strain gage, rosettes
High Speed FET Multiplexers:				
HP 44711A/B	24	±10.24V	100,000	DCV, DCI, 4W Ω, RTDs, thermistors
HP 44712A	48	±10.24V	100,000	DCV, DCI
HP 44713A/B	24	±10.24V	100,000	DCV, DCI, thermocouples
* = Maximum number of samples/second channel-to-channel with mainframe ROM revision 2.0 or higher. 100,000 samples/second with High-speed FET Multiplexers ONLY for ribbon cable measurements.				
** = Will also do 2-Wire thermistor measurements reasonably well.				

Multiplexer Measurements

With multiplexer measurements, you can measure DC volts, DC current, resistances, strain, or temperature by using the appropriate HP 447XXX multiplexer (including the HP 44711A/B, HP 44712A, or HP 44713A/B). Multiplexer channels can be scanned at rates up to 450 channels/sec with relay multiplexers or up to 5500 channels/sec with FET multiplexers (for mainframe firmware revision 2.0 or greater).

Ribbon Cable Measurements

With ribbon cable measurements, user sources are input to HP 44711A/B, HP 44712A, or HP 44713A/B multiplexers and sent to the voltmeter via a dedicated ribbon cable. In this mode, the voltmeter operates independently of the mainframe. For ribbon cable measurements, ONLY HP 44711A/B, HP 44712A, or HP 44713A/B multiplexers can be used, the ribbon cable must be connected, Scanner Mode (SCANMODE ON) must be set, and TERM RIBBON must be set.

Ribbon cable measurements are typically used when fast scanning rates are required. Use ribbon cable operation to transfer data to the mainframe memory at rates up to 90,000 readings/sec or to the controller via GPIO at rates up to 100,000 readings/sec.

Rear Panel Measurements

With rear panel measurements, user sources are input directly to the voltmeter rear panel terminals (HI, LO, and CHASSIS) for voltage measurements on a single channel. You can also use the CURRENT SOURCE (HI and LO) terminals with the voltage terminals for 4-wire ohms measurements. Rear panel measurements are useful for DC voltage or 4-wire ohms measurements on a single input and can be used for high-speed measurements of a single channel.

Triggering Method

When the voltmeter measurement function and multiplexer(s) have been selected, select the type of voltmeter triggering required. The voltmeter can be triggered from the mainframe, internally from the voltmeter, or from an external source via the voltmeter EXT0, EXT1, and GPIO ports.

Mainframe Backplane Triggering

The voltmeter can be software triggered via the mainframe backplane by using the TRIG and/or TRG commands. Refer to Chapter 7 in the HP 3852A Mainframe Configuration and Programming Manual for a discussion of mainframe triggering.

Voltmeter Internal Triggering

The voltmeter can also be internally triggered by a pacer trigger or when the input crosses a specified threshold in the proper direction.

Voltmeter Port Triggering

The voltmeter can also be triggered by a suitable input from an external source into the EXT0 or EXT 1 port or into the GPIO port.

Programming Mode

As noted, the voltmeter has two programming modes: System Mode (SCANMODE OFF) and Scanner Mode (SCANMODE ON). The programming mode to use depends on the type of measurement required. Table 2-2 summarizes guidelines to select System or Scanner Mode operation as a function of measurement speed, type of measurement, input source, and general application.

When you have selected the programming mode required, refer to Chapter 3 - Installation and Checkout to install and initially check the voltmeter. Then, refer to Chapter 4 - System Mode Programming to program the voltmeter for System Mode operation or to Chapter 5 - Scanner Mode Programming to program the voltmeter for Scanner Mode operation.

Table 2-2. System Mode vs. Scanner Mode

	System Mode	Scanner Mode
Max Speed	450 ch/sec (relay mux) 5500 ch/sec (FET mux)	100,000 rdgs/sec (mainframe) 100,000 rdgs/sec (GPIO)
Measurement Type	DCV, DCI ohms, strain, temp (all muxs) DCV, 4W ohms (rear panel)	DCV, DCI, ohms, strain, temp (all muxs) DCV, 4W ohms (rear panel) DCV, DCI, ohms, temp (ribbon cable, HP 44711A/B, 44712A, 44713A/B muxs)
Input Source	Backplane (all muxs) Rear panel	Backplane (all muxs) Ribbon cable (44711A/B, 12A, 13A/B) Rear panel
Commands/Operation	Subset - requires mainframe for operation	Full set - independent operation with ribbon cable
Typical Applications	Low-speed measurements General scanning HP-IB operations	High-speed measurements Digitize waveforms HP-IB or GPIO operation

Configuration Examples

This section shows two example ways to define your measurement and select voltmeter configuration for the measurement. The first example shows typical selections for a System Mode measurement. The second example shows typical selections for a Scanner Mode measurement.

Example: System Mode Voltage Measurements

For this example, the application is DC voltage measurement of 20 inputs at a switching speed of 200 readings/second. Each input is to be measured 10 times so 200 readings are required. Table 2-3 show typical selections for this measurement.

Table 2-3. System Mode Measurements Selections

Measurement Requirements	
Measurement Characteristics	
Type	DC voltages (5V input)
Speed	200 readings/sec
Accuracy	0.10%
Number	200 readings
Data/Interrupt Requirements	
Storage Mode	Data available when reading stored
Transfer Mode	To controller via HP-IB
Interrupts	Not required
Voltmeter Configuration	
Voltmeter Function	DC volts, autorange
Multiplexer Used	HP 44705A 20-Channel Relay Multiplexer
Triggering Method	Voltmeter internal triggering
Programming Mode	System Mode

For this measurement, the voltmeter function selected is DC voltage measurements with autorange mode and internal voltmeter triggering. An HP 44705A 20-Channel Relay Multiplexer will be used since it has the required number of channels and accuracy (see Table 2-1).

The voltmeter will be programmed to make the 200 measurements with System Mode operation, since the speed requirements are <450 readings/second. Data destination will be the output buffer, data storage will be set so that readings are available when any reading is stored in the voltmeter buffer, and interrupts will be disabled.

With these selections, we can now go to Chapter 3 - Installation and Checkout to configure the voltmeter and then to Chapter 4 - System Mode Programming to program the voltmeter.

Example: Scanner Mode Measurements

For this example, the application is DC voltage measurement of 20 inputs at a speed of 30,000 readings/second. Each input is to be measured 100 times so 2000 readings are required. Table 2-4 shows typical selections.

Table 2-4. Scanner Mode Measurements Selections

Measurement Requirements	
Measurement Characteristics	
Type	DC voltages (5V input)
Speed	30,000 readings/sec
Accuracy	0.07%
Number	2000 readings
Data/Interrupt Requirements	
Storage Mode	Data available when reading stored
Transfer Mode	To HP-IB output buffer (via mainframe memory)
Interrupts	When meas completes (no overwrite) - handle in controller
Voltmeter Configuration	
Voltmeter Function	DC voltage, autorange
Multiplexer Used	HP 44711A/B High-speed FET Multiplexer
Triggering Method	Voltmeter internal triggering
Programming Mode	Scanner Mode (ribbon cable)

For this measurement, the voltmeter function is DC voltage with autorange and internal voltmeter triggering is used. An HP 44711A/B 24-Channel High-Speed FET Multiplexer is used since it has the required number of channels and accuracy (see Table 2- 1). The input to the voltmeter will be via the dedicated ribbon cable from the multiplexer to the voltmeter.

The voltmeter will be programmed to make the 2000 measurements with Scanner Mode (ribbon cable) operation, since the speed requirements are >450 readings/second. Data destination will be the HP-IB output buffer via the mainframe memory. Data storage mode will be set so that readings are available when the measurements are complete. Interrupts will be enabled

(interrupt when measurement is complete) and will be handled by the controller.

With these selections, we can go to Chapter 3 - Configuring the Voltmeter to configure the voltmeter and then to Chapter 5 - Scanner Mode Programming to program the voltmeter.



Chapter 3

Installation and Checkout

Contents

Introduction	3-1
Chapter Contents	3-1
Warnings, Cautions, and Notes	3-1
Voltmeter Input Protection	3-4
Connecting User Inputs	3-5
Multiplexer Connections	3-5
Rear Panel Connections	3-5
Installing the Voltmeter	3-9
Multiplexer Measurements Installation	3-9
Ribbon Cable Measurements Installation	3-12
Initial Checks	3-12
Voltmeter ID Check	3-12
Voltmeter Self-Test	3-12
Checking Wiring Connections	3-15
Mainframe Firmware Revision	3-16

Installation and Checkout

Introduction

This chapter shows recommended ways to connect user inputs to the voltmeter and shows how to install and initially check the voltmeter.

Chapter Contents

This chapter has four sections:

- **Introduction** summarizes chapter contents and lists WARNINGS, CAUTIONS, and NOTES which apply to the voltmeter.
- **Connecting User Inputs** shows recommended connections to multiplexers used with the voltmeter and connections to the voltmeter rear panel terminals.
- **Installing the Voltmeter** shows how to install the voltmeter and associated multiplexers for multiplexer and ribbon cable measurements.
- **Initial Checks** shows how to check the voltmeter ID, how to make the voltmeter self-test, how to check wiring connections, and how to check the mainframe firmware revision.

Warnings, Cautions, and Notes

This section summarizes WARNINGS, CAUTIONS, and NOTES which apply to the HP 44702A/B, HP 44704A, and associated multiplexers. You should review the WARNINGS and CAUTIONS before handling or configuring any accessory.

WARNING

SHOCK HAZARD. Only qualified, service-trained personnel who are aware of the hazards involved should install, remove, or configure any accessory. Before touching any installed accessory, turn off all power to the mainframe, extenders, and to all external devices connected to the mainframe, extenders, or accessories.

WARNING

POSSIBLE OPERATOR INJURY. For safety, consider all accessory channels to be at the highest potential applied to any channel. Under most conditions of failure, the relays on the relay multiplexers will remain in the position programmed before the failure.

However, for some equipment failures, the relays may not remain in their programmed state. If the relays settle in the closed state, the relay contacts may weld together and the highest voltage present on any one channel may be present on all channels. This condition may cause operator injury if the terminals are touched, or further equipment damage may result.

WARNING

MAXIMUM VOLTAGE LIMITATIONS. The HP 3852A and the HP 3853A internal analog buses interconnect the multiplexer and voltmeter accessories to form one circuit. To protect against possible personal injury due to equipment failure or programming error, limitations are placed on the potentials that can appear between any two points in the circuit (or between the circuit and chassis).

These limitations are listed for the HP 3852A, HP 3853A, and all plug-in accessories. For any given set of accessories installed in the mainframe or extender, the maximum potential between any two points is determined by the accessory with the LOWEST peak voltage limitations, as follows. (If the analog extender cable is NOT connected between the mainframe and the extenders, each instrument is considered as a separate circuit.)

Instrument/Accessory	Peak Voltage
HP 3852A Mainframe	354 V
HP 3853A	354 V
HP 44701A Integrating Voltmeter	354 V
HP 44702A/B or HP 44704A High-Speed Voltmeter	42 V
HP 44705A, 08A, 17A, 18A 20-Channel Relay Multiplexers	170 V
HP 44705H, 08H 20-Channel High-Voltage Relay Multiplexers	354 V
HP 44706A 60-Channel Relay Multiplexer	42 V
HP 44709A, 10A, 11A/B, 12A, 13A/B FET Multiplexers	42 V

The HP 44702A/B and HP 44704A voltmeter analog input is protected to ± 12 volts peak between any of the input terminals (HI, LO, CHASSIS). When the relay to the backplane is open (TERM EXT set), the input is protected to ± 42 volts peak. Do not exceed this voltage or the HP 44702A/B or HP 44704A will be damaged.

Maximum compliance voltage for the HP 44702A/B or HP 44704A voltmeter CURRENT SOURCE terminals (HI, LO) is ± 10.24 volts. Do NOT exceed this voltage or the HP 44702A/B or HP 44704A will be damaged.

CAUTION

POSSIBLE EQUIPMENT DAMAGE. When making high-voltage measurements with the HP 44705A or HP 44705H, the HP 3852A analog backplane becomes charged to the voltage on the last channel connected to it. Thus, the next channel that closes may have to absorb all of the energy stored on the backplane.

If the backplane is not discharged after making a high-voltage measurement, the voltage present on the backplane must be added to the voltage being switched on the next channel to determine the total rally contact voltage. See figure 3-1 for guidelines to maximize relay life and prevent damage to sensitive transducers by high backplane discharge voltages.

When measuring high voltages, connect the line which has the highest maximum (1) absolute peak voltage of the source to the HIGH terminal on the terminal module. Connect the line which has the lowest absolute peak voltage on the source to the LOW terminal on the terminal module. Connect the guard line ONLY if high common mode noise rejection is necessary, otherwise, do not connect the guard line.

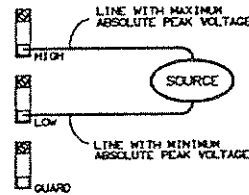

OR

Discharge the HP 3852A analog backplane to earth ground through 1 M-10 M resistors connected to HIGH, LOW, and GUARD on an unused channel.

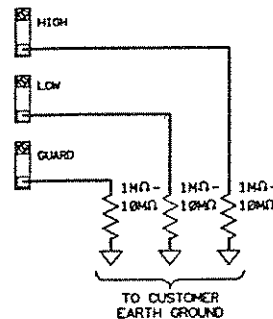

[1] = if the backplane is not discharged, high common mode voltage may appear on the backplane and cause the HP High Speed Voltmeter to generate an overload reading even though the signal input is within the voltmeter range.

Figure 3-1. Discharging the HP 3852A Backplane

Voltmeter Input Protection The HP 44702A/B and the HP 44704A have input protection relays (backplane only on the HP 44702A/B). If excessive input voltage appears on the protected inputs, the protection relays will open. On the HP 44702A/B, only the incorrect reading values will indicate that the protection relays are open. On the HP 44704A, the voltmeter will return overload readings if the protection relays are open. The HP 44704A has protection relays for the backplane, high-speed multiplexer inputs (ribbon cable), and rear panel terminals. To reset the protection relays, execute a CONFMEAS, CONF, MEAS, or TERM command. For either voltmeter model, DO NOT routinely rely on the input protection system. Damage to the voltmeter would probably result.

NOTE

SHIELDED CABLE REQUIRED. Shielded twisted-pair cable is required for connections to the multiplexer terminal module for measurements with the HP 44702A/B and HP 44704A voltmeter.

Since the HP High-Speed voltmeters use a high-speed successive approximation technique for measurements (rather than an integrating technique), they will not reject power-line noise pickup through input cables unless the noise is common to both the HI and LO inputs.

Therefore, regardless of whether user inputs are to the voltmeter rear panel terminals or to multiplexers, it is ESSENTIAL to connect the inputs with shielded, twisted-pair cables to reduce noise and keep measurement error to a minimum.

You can order the appropriate cable from your nearest Hewlett-Packard Sales and Support Office. Order HP part number 03498-61602 which is a 2 meter cable with crimped and heat-shrunk wires attached to the braided shield at both ends.

NOTE

HP-IB ADDRESS. The example programs in this manual use "709" as the HP-IB address for the HP 3852A. Specific slot and channel numbers are also used. Program syntax and data return formats apply to the HP Series 200/300 controllers. Modify slot and channel numbers and program syntax as required.

Connecting User Inputs

This section shows recommended ways to connect user inputs to multiplexer terminal modules or to the voltmeter rear panel terminals.

Multiplexer Connections

Always use shielded, twisted-pair cable when connecting user inputs to multiplexers, especially in a high common mode noise environment. Since the HP 44702A/B and HP 44704A use a differential input, chassis referenced measurement technique, high common mode noise can cause the voltmeter to indicate an overload condition even when the transducer outputs a signal which is within the voltmeter range. Maximum voltage on HI or LO is $\pm 10.24\text{V}$ peak (including common mode voltage).

Figure 3-2 shows typical voltage, 2-wire Ω , and 4-wire Ω connections to an HP 44705A 20-Channel Relay Multiplexer. Figure 3-3 shows typical connections to an HP 44711A/B 24-Channel High-Speed FET Multiplexer for these measurements. Since connections may vary with the individual multiplexer, refer to the appropriate multiplexer configuration and programming manual for details.

NOTE

If the ribbon cable from an HP 44711A/B, HP 44712A, or HP 44713A/B multiplexer is connected to the voltmeter, ONLY ribbon cable measurements with Scanner Mode (SCANMODE ON) and TERM RIBBON can be made. If the ribbon cable is not connected, the HP 44711A/B, HP 44712A, or HP 44713A/B can be used for backplane measurements, but ribbon cable measurements cannot be made.

Rear Panel Connections

Figure 3-4 shows typical connections to the rear panel terminals for voltage and 4-wire ohms measurements (the only measurements which can be made using the rear panel terminals).

When connecting user inputs to the voltmeter rear panel terminals (HI, LO, and CHASSIS for voltage or HI, LO, CHASSIS and CURRENT SOURCE HI and LO for resistance measurements), use shielded, twisted-pair cables and keep the exposed part of the cable as short as possible.

DC VOLTAGE OR 2-WIRE Ω CONNECTIONS

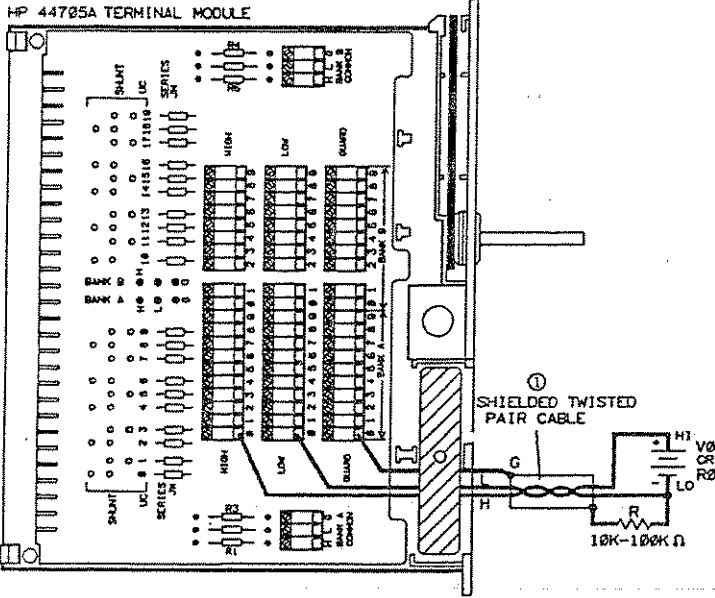

4-WIRE Ω MEASUREMENTS

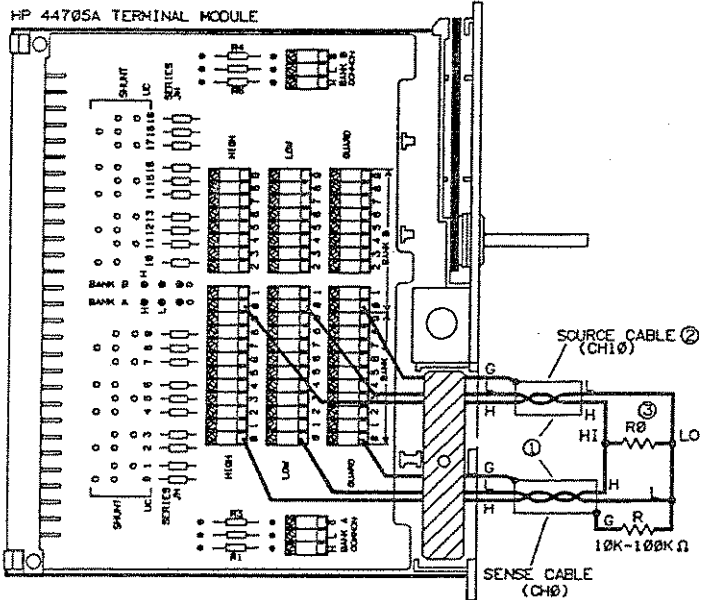

Notes

1 = Shielded cable and external resistor R are required for measurements with the HP High-Speed Voltmeter.

2 = Do NOT connect Source channel shield lead to R0 LO as this will reduce the effective compliance voltage.

3 = R0 can be a resistor, and RTD, or a thermistor. The HP 3852A supports Type 85 and 92 2252, 5K, and 10K thermistors.

Figure 3-2. HP 44705A Multiplexer Connections

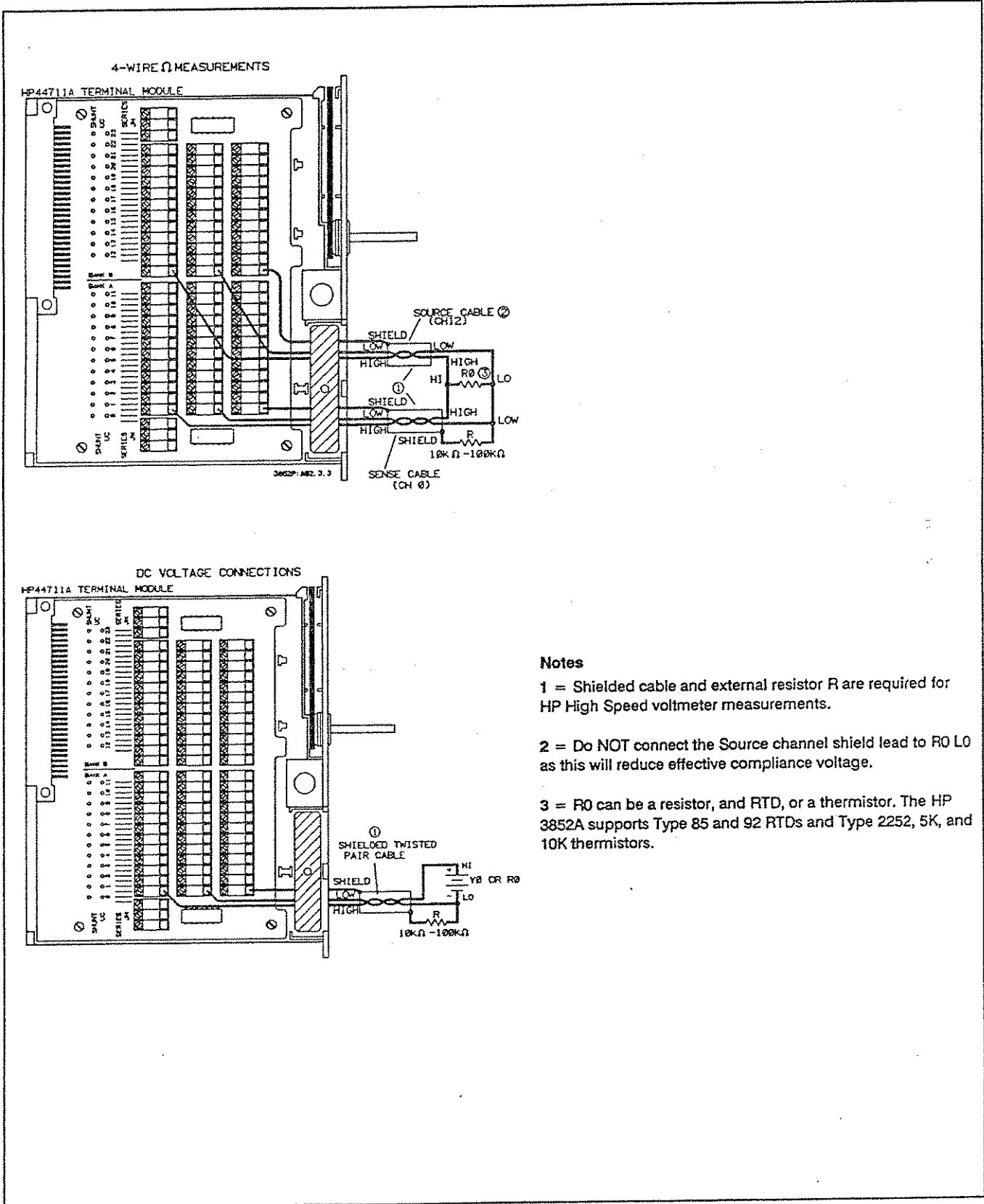

Notes

- 1 = Shielded cable and external resistor R are required for HP High Speed voltmeter measurements.
- 2 = Do NOT connect the Source channel shield lead to R0 LO as this will reduce effective compliance voltage.
- 3 = R0 can be a resistor, and RTD, or a thermistor. The HP 3852A supports Type 85 and 92 RTDs and Type 2252, 5K, and 10K thermistors.

Figure 3-3. HP 44711A Multiplexer Connections

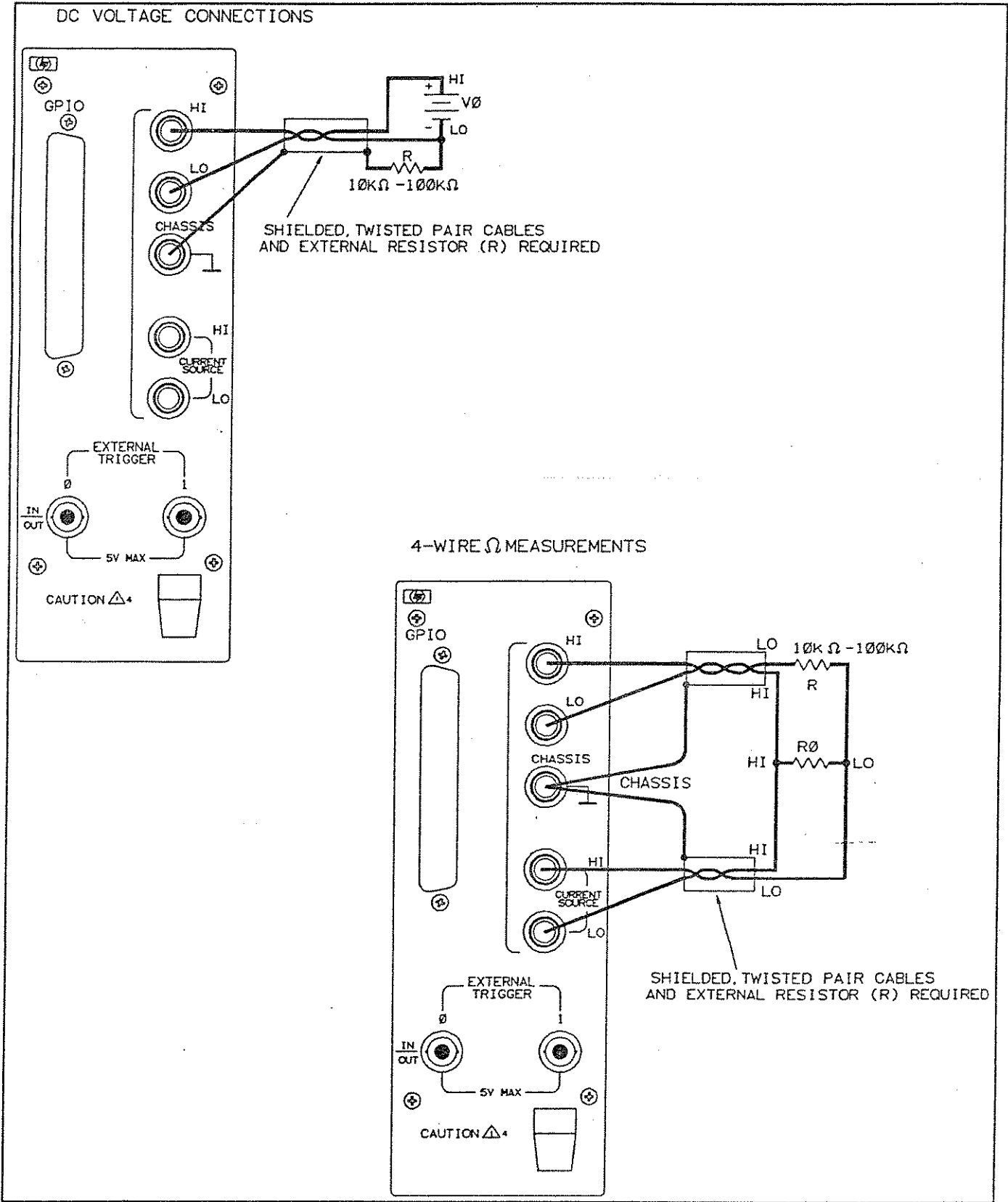

Figure 3-4. Rear Panel Connections

Installing the Voltmeter

When user inputs are connected, install the voltmeter and multiplexers in desired slots. Guidelines to install the voltmeter and associated multiplexers for multiplexer or ribbon cable measurements follow.

Before installing the voltmeter, write down the voltmeter serial number printed on the bar code label on the left side of the instrument. A typical number is 44702 2612A00259, where 44702 is the voltmeter model (HP 44702) and 2612A00259 is the serial number. You'll need the serial number to see if faster backplane scanning rates can be used. Refer to "Mainframe Firmware Revision".

Multiplexer Measurements Installation

When user inputs are connected to the multiplexers, replace the terminal module(s) and install the multiplexer(s) and voltmeter(s) in the slot(s) desired as shown in Figure 3-5.

For multiplexer measurements, you can install up to 76 multiplexers (up to eight in the mainframe and up to ten in each extender). Because of mechanical restraints, the HP 44702A/B and HP 44704A voltmeter cannot be installed in slots 3 and 4 of the mainframe or in slots 5 and 6 of an extender.

If all multiplexers are in the same frame (mainframe or extender) as the voltmeter, the analog extender cable is not connected. If any multiplexers are not in the same frame, the analog extender cable must be connected. (The digital extender cable is always required.)

NOTE

1. Do NOT use the installation steps in Figure 3-5 for ribbon cable measurements installation. See Figure 3-6 for ribbon cable measurements installation.

2. If an HP 44711A/B, HP 44712A, or HP 44713A/B multiplexer is used for multiplexer measurements, the ribbon cable must be attached (looped back) to the connector on the multiplexer.

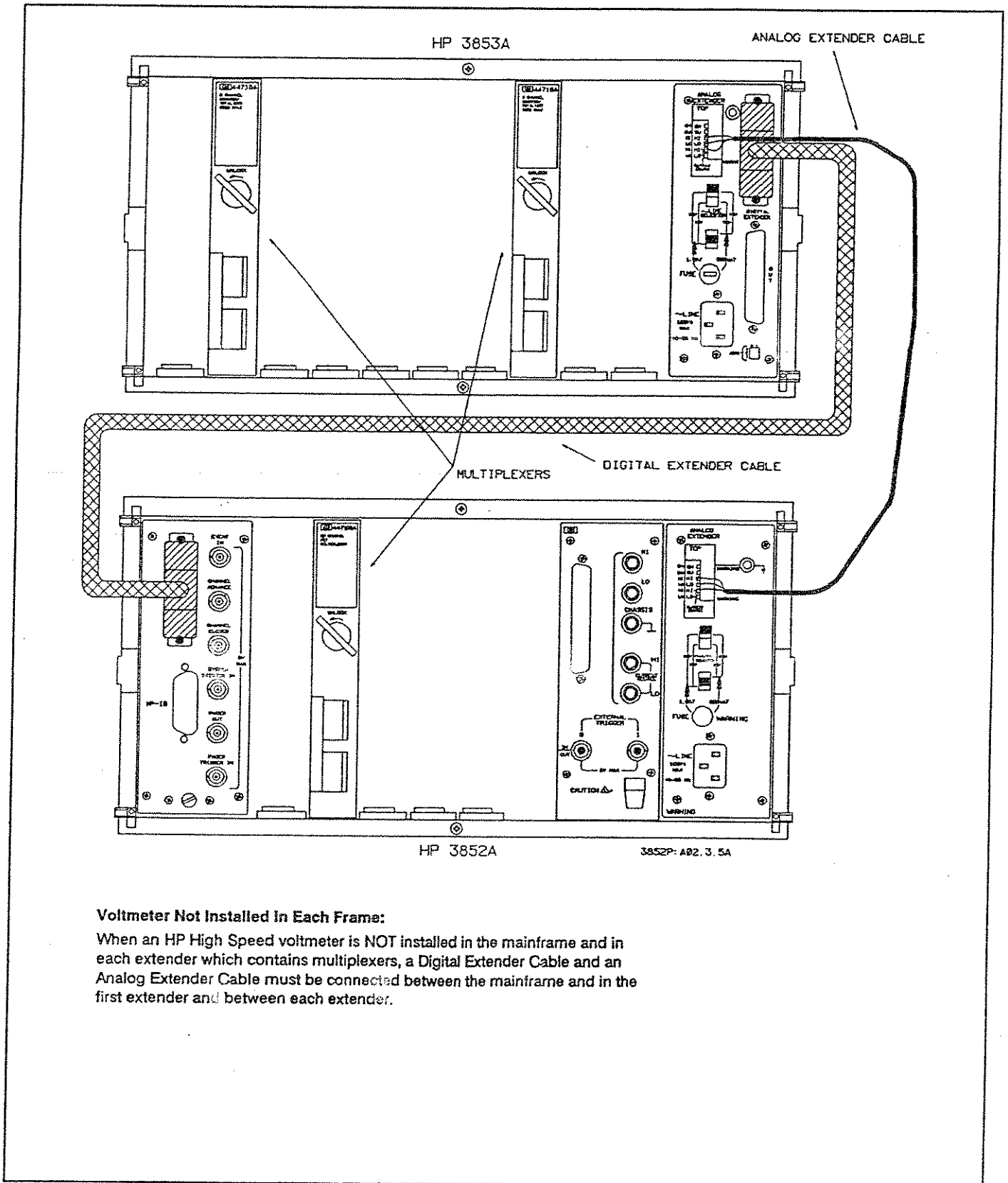

Voltmeter Not Installed in Each Frame:
 When an HP High Speed voltmeter is NOT installed in the mainframe and in each extender which contains multiplexers, a Digital Extender Cable and an Analog Extender Cable must be connected between the mainframe and in the first extender and between each extender.

Figure 3-5. Multiplexer Measurements Installation

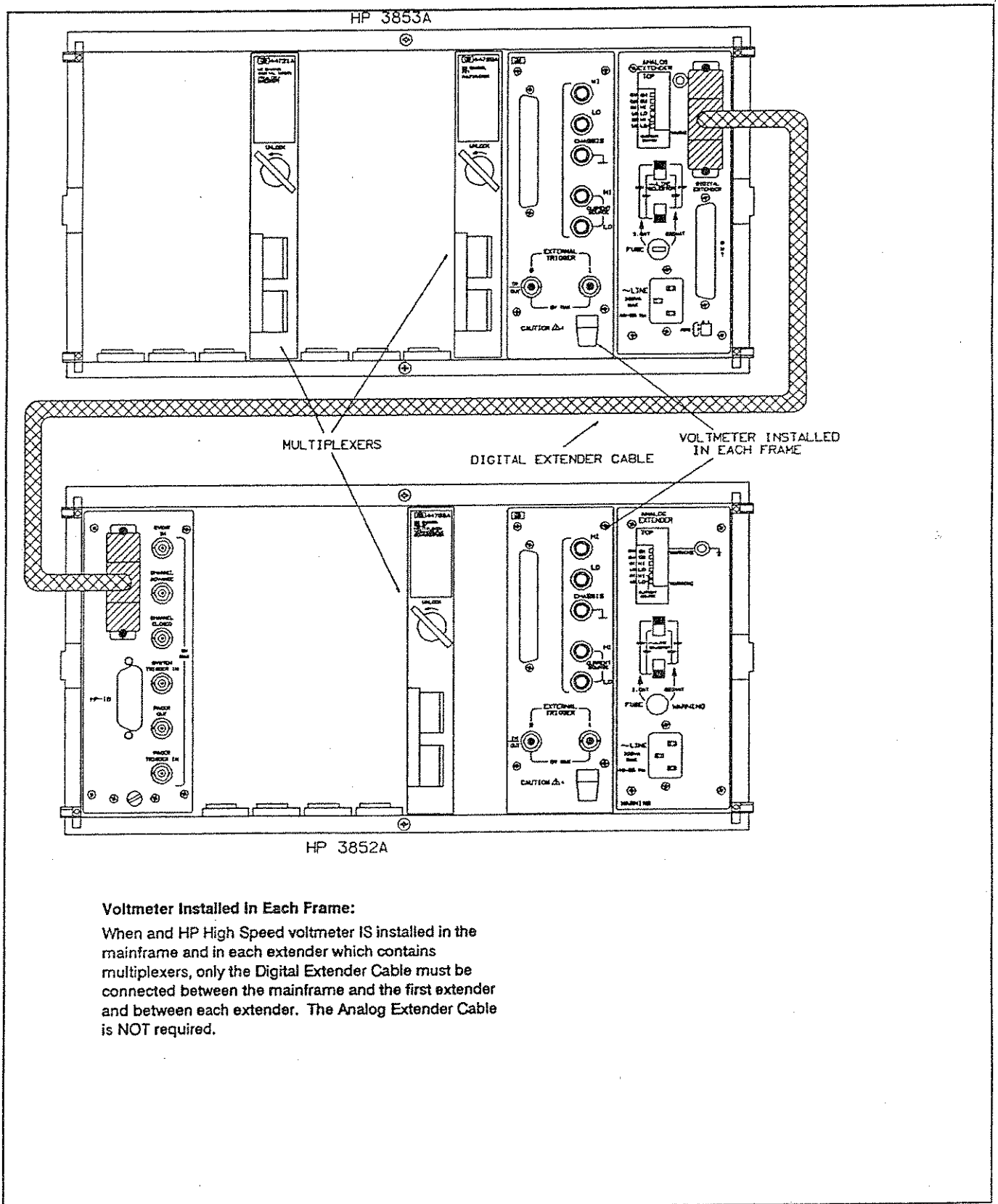

Voltmeter Installed in Each Frame:
 When an HP High Speed voltmeter is installed in the mainframe and in each extender which contains multiplexers, only the Digital Extender Cable must be connected between the mainframe and the first extender and between each extender. The Analog Extender Cable is NOT required.

Figure 3-5. Multiplexer Measurements Installation (Cont)

Ribbon Cable Measurements Installation

With ribbon cable measurements, user signals are input to the voltmeter via a dedicated ribbon cable from one or more (up to eight) HP 44711A/B, HP 44712A or HP 44713A/B High-Speed FET Multiplexers. The first multiplexer must be installed in the slot next to the voltmeter and additional multiplexers must be installed in adjacent slots. Also, the ribbon cable must be connected from the first multiplexer to the voltmeter and ribbon cables must be connected between multiplexers used. See Figure 3-6.

For ribbon cable measurements, an HP 44702A/B or HP 44704A voltmeter must be installed in each mainframe and each extender which has multiplexers used with the voltmeter. The analog extender cable is not necessary.

Initial Checks

When the voltmeter and multiplexers have been installed, the next step is to initially check the voltmeter for proper operation. This section shows how to check the voltmeter ID, voltmeter self-test, multiplexer wiring connections, and mainframe firmware revision number.

Voltmeter ID Check

When the voltmeter has been installed, check the voltmeter identity by entering the `ID? slot` command from the front panel. Since the voltmeter takes two slots, always address the voltmeter by the lowest slot number. For example, if the voltmeter is in slots 6 and 7, use slot 6 as the address.

For example, if an HP 44702A is installed in slots 6 and 7, `ID? 600` returns 44702A. If an HP 44702B is installed, 44702B is returned. An HP 44704A installed in a mainframe with firmware revision 4.2 or greater returns 44704A. An HP 44704A installed in a mainframe with firmware revisions earlier than 4.2 returns 44702B. If no accessory is installed in the slot addressed, 000000 is returned.

Voltmeter Self-Test

To self-test the voltmeter, enter the `TEST slot` command from the front panel. If the voltmeter passes the self-test check, you can be reasonably sure the voltmeter is operating correctly. The `TEST slot` command checks the voltmeter for proper operation.

Passing the self-test does not guarantee that the voltmeter is properly calibrated. It only means that the calibration constants are within an acceptable range. Refer to the HP 3852A Assembly Level Service Manual for voltmeter calibration procedures.

The `TEST slot` command changes the state of the HP High-Speed voltmeter. We recommend you use the `RST slot` (or `RESET slot`) command to reset the voltmeter to its power-on state after executing the `TEST` command.

Ribbon Cable Operation Connection/Installation Steps

Caution

To prevent possible damage to the ribbon cable, check the ribbon cable connections before fully removing and HP FET Multiplexer

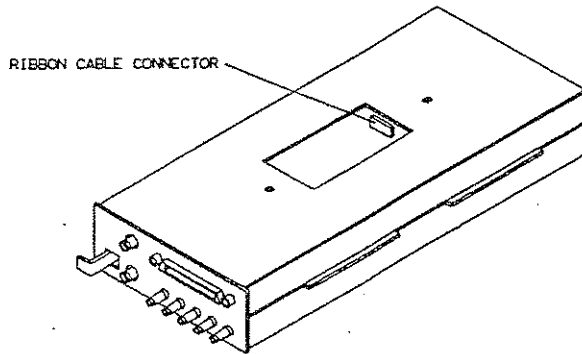

1. Position Voltmeter

Place the HP High Speed Voltmeter with ribbon cable connector side up.

2. Disconnect Ribbon Cable

Remove HP FET Multiplexer terminal module. Disconnect ribbon cable from connector and feed cable through cutout on multiplexer.

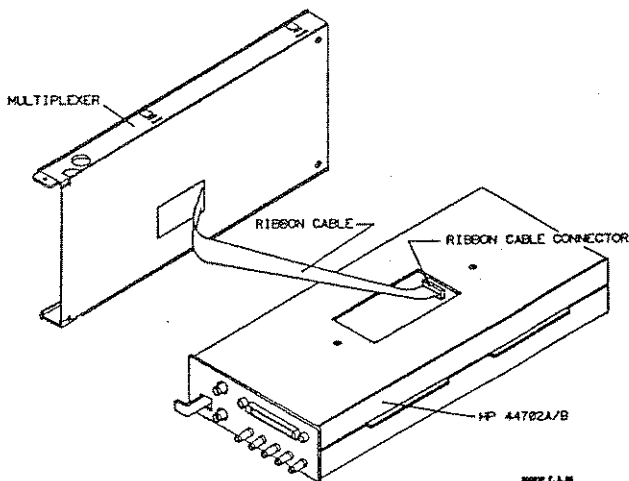
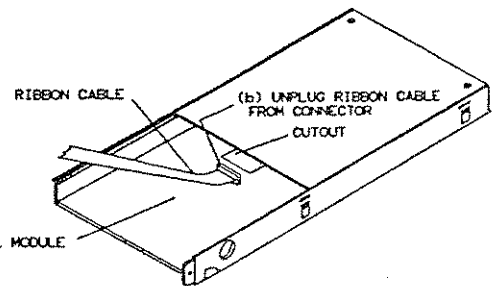

3. Connect Cable to Voltmeter

Attach ribbon cable from multiplexer to voltmeter ribbon cable connector. Replace multiplexer terminal module..

Figure 3-6. Ribbon Cable Measurements Installation

4. Connect Multiplexers

For each frame, join multiplexers by connecting the ribbon cable between multiplexers. For ribbon cable operation, an HP High Speed Voltmeter required in the mainframe and in EACH extender, containing multiplexers.

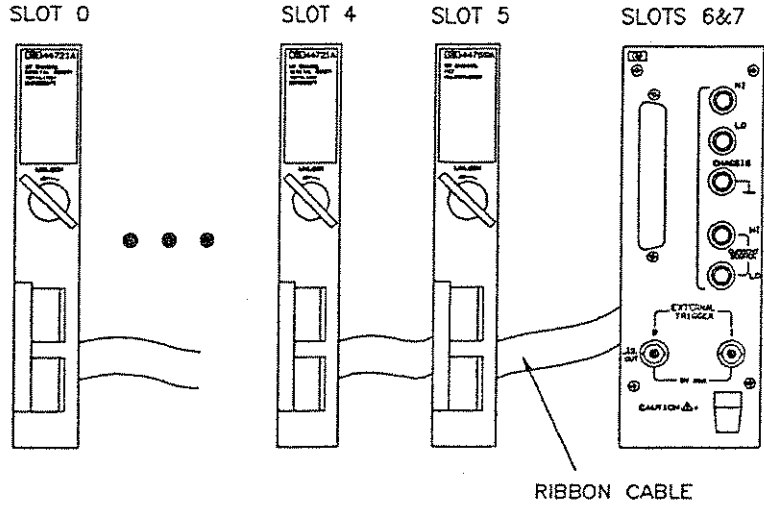

- UP TO 6 MULTIPLEXERS IN MAINFRAME
- UP TO 8 MULTIPLEXERS IN EACH EXTENDER

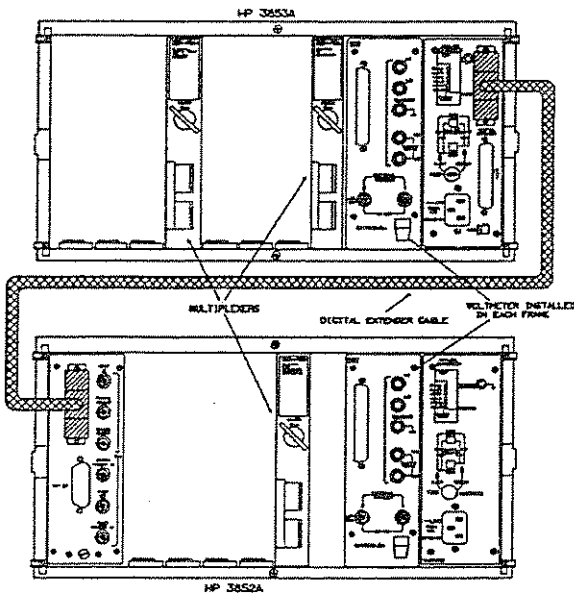

5. Install Voltmeter(s) Multiplexer(s)

Install voltmeter(s) and multiplexers in desired slots. The voltmeter cannot be installed in slots 3 and 4 of mainframe or in slots 4 and 5 of an extender. Recommend installing voltmeter in mainframe slots 6 and 7 and in extender slots 8 and 9.

Notes

1. Procedures shown apply only to ribbon cable inputs. See Figure 3-5 for (backplane) multiplexer inputs.
2. If an HP FET Multiplexer is used in other than ribbon cable mode, the ribbon cable must be connected to the connector on the multiplexer.

Figure 3-6. Ribbon Cable Measurements Installation (Cont)

CAUTION

To avoid potential damage to the instrument do NOT use the voltmeter if the self-test fails. Refer to the HP 3852A Assembly Level Service Manual for the service procedures.

For example, for an HP 44702A/B in slots 6 and 7 of the mainframe, TEST 600 displays SELF TEST OK in the right display window if the self-test passes. Enter RST 600 to reset the voltmeter to its power-on state.

Checking Wiring Connections

When the voltmeter passes the self-test, you can check wiring connections to the multiplexers by using the MONMEAS command. (MONMEAS works for DC volts, resistance, RTD, and thermistor connections only.)

With MONMEAS, the voltage (or resistance) on a specified channel is continuously monitored and the result sent to the front panel display ONLY. To advance the monitoring to the next channel in the list, press the SADV KEY key on the front panel. An example follows.

Example: Monitoring Multiplexer Inputs (MONMEAS)

This program checks the DC voltage input to channels 200 through 204 of an HP 44705A multiplexer in slot 2 of the mainframe using an HP 44702A/B voltmeter in slots 6 and 7 of the mainframe. (To monitor 2-wire ohms, use CONF OHM in line 30. To monitor 4-wire ohms, use CONF OHMF in line 30).

When MONMEAS is executed, channel 200 is closed. The voltmeter makes repeated measurements on channel 200 and continuously displays the results on the front panel display only.

Pressing the front panel SADV KEY key advances the scan to channel 201. Pressing the SADV KEY key again advances the scan to channel 202, etc. When the scan reaches channel 204, pressing the SADV KEY key once more ends the sequence. (You can also use the CLEAR key to stop the scan.

10 OUTPUT 709;"RST 600"	<i>!Reset the voltmeter</i>
20 OUTPUT 709;"USE 600"	<i>!Use voltmeter in mainframe slot 6</i>
30 OUTPUT 709;"CONF DCV"	<i>! Select DC volts measurements</i>
40 OUTPUT 709;"MONMEAS DCV,200-204"	<i>!Meas/display volts on ch 200-204</i>
50 END	

A typical return for a 9V 5 % source connected to channel 200 (value in volts) is:

DCV	200
-----	-----

8.999874E + 00

Mainframe Firmware Revision

With early versions of the HP 44702A/B voltmeters, backplane (multiplexer measurements) scanning rate was limited to about 450 channels/second with relay multiplexers. However, later versions of the voltmeter, combined with mainframe firmware revision 2.0 or higher, allowed faster backplane scanning rates.

To determine the applicable serial numbers, check the label entitled "HP 44702 VOLTMETER ENHANCEMENTS" on the voltmeter metal shield. As shown on the label, the enhanced scanning rate is available for HP 44702As with serial number 2626A 00600 and higher or for HP 44702Bs with serial number 2626A 00450 and higher or when the UPGRADES box is checked on the "HP 44702 VOLTMETER ENHANCEMENTS" label on the voltmeter.

The HP 44704A requires mainframe firmware revision 4.2 or higher. HP 44704A voltmeters in mainframes with earlier revision firmware will emulate an HP 44702B voltmeter.

To check the voltmeter serial number, note the number printed on the component module metal shield. To determine the mainframe firmware revision, use the following program or enter the IDN? command from the front panel.

```
10 DIM Identity$(1:4)[17]
20 OUTPUT 709;"IDN?"
30 ENTER 709;Identity$(*)
40 PRINT USING "K,/";Identity$(*)
50 END
```

For example, if the firmware revision is 4.2, a typical return is as shown. Since the firmware revision is higher than 2.0, enhanced backplane scanning capability is available when a voltmeter with the appropriate serial number is used.

```
HEWLETT PACKARD
3852A
0
4.2
```

(Company name)

(Model number)

(Mainframe serial number unknown)

(Firmware revision 4.2)

Chapter 4

System Mode Programming

Contents

Introduction	4-1
Chapter Contents	4-1
Program Titles	4-1
Getting Started	4-2
Measurements Using CONFMEAS	4-4
CONFMEAS Command	4-4
CONFMEAS Operation	4-7
CONFMEAS Presets	4-7
Examples: Measurements Using CONFMEAS	4-9
Measurements Using CONF and MEAS	4-11
Programming Overview	4-11
System Mode Commands	4-12
CONF and MEAS Commands	4-13
CONF and MEAS Operation	4-15
Setting Voltmeter Operation	4-17
Setting Number of Readings/Trigger (NRDGS)	4-17
Setting Measurement Delays (DELAY)	4-18
Setting Voltmeter Range (RANGE)	4-18
Setting Autorange Mode (ARMODE)	4-19
Example: Setting Voltmeter Operation	4-19
Setting Voltmeter Triggering	4-20
Setting Trigger Source/ Mode (TRIG)	4-20
Setting Input Slope (SLOPE)	4-22
Example: Setting Voltmeter Triggering	4-22
Setting Scan Triggering	4-23
Setting Scan Trigger Source (STRIG)	4-23
Setting Scan Advance Source (SADV)	4-23
Example: Setting Scan Triggering	4-23
Measurements Not Using MEAS	4-24
Low-Level Multiplexer Measurements	4-25
Controlling Multiplexer Channels (CLOSE/OPEN)	4-25
Transferring Readings (CHREAD)	4-26
Example: Low-Level Multiplexer Measurements	4-26
Rear Panel Measurements	4-27
Setting Input Terminals (TERM)	4-27
Setting Input Threshold (PERC)	4-27
Setting Measurement Function (FUNC)	4-28
Setting Autozero Mode (AZERO)	4-28
Transferring Multiple Readings (XRDGS)	4-28
Example: Rear Panel Measurements	4-29
Enabling Interrupts	4-30
Setting Readings Destination (RDGS)	4-30
Setting Readings Storage Mode (RDGSMODE)	4-31
Setting Interrupts (ENABLE INTR)	4-32
Example: Enabling Interrupts	4-34
System Mode Command Summary	4-36

System Mode Programming

Introduction

This chapter shows how to program the voltmeter for multiplexer and rear panel measurements when the voltmeter is set for System Mode (SCANMODE OFF) operation. Refer to Chapter 5 - Scanner Mode Programming for measurements with the voltmeter in Scanner Mode (SCANMODE ON).

NOTE

This chapter applies directly to the HP 44702A/B, and HP 44704A in 13 and 14 bit resolution modes. The fundamentals covered here also apply to the HP 44704A in 16 bit resolution mode, but some differences exist. These are covered in Chapter 6 - The HP 44704A in 16 Bit Mode.

Chapter Contents

This chapter has five sections:

- **Introduction** lists the chapter contents, shows example program titles, and shows a suggested getting started sequence.
- **Measurements Using CONFMEAS** shows how to make System Mode multiplexer measurements using the CONFMEAS command.
- **Measurements Using CONF and MEAS** shows how to make System Mode multiplexer measurements using the CONF, MEAS, and low-level commands.
- **Measurements Not Using MEAS** shows how to use CONF and/or low-level commands to make multiplexer and rear panel measurements and to enable interrupts.
- **System Mode Command Summary** is an alphabetical summary of System Mode commands.

Program Titles

Table 4-1 lists the titles of the example programs in this chapter, listed by section title.

Table 4-1. Example Program Titles

Measurements Using CONFMEAS		
DC Voltage Measurements	Measure DC voltages on multiplexer channels.	CONFMEAS
Resistance Measurements	Measure the resistance on multiplexer channel.	CONFMEAS
Temperature Measurements	Measure the temperature of a thermistor.	CONFMEAS
Reference Temperature Measurement	Measure the isothermal block temperature.	CONFMEAS
Measurements Using CONF and MEAS		
Setting Voltmeter Operation	Set number readings/trigger, delays, and range.	NRDGS, DELAY, RANGE
Setting Voltmeter Triggering	Set voltmeter trigger source and input edge.	TRIG, SLOPE
Setting Scan Triggering	Set scan trigger source and scan advance source.	SADV, STRIG
Measurements Not Using MEAS		
Low-Level Multiplexer Measurements	Use CONF and low-level commands for multiplexer measurements.	CLOSE, TRIG, CHREAD
Rear Panel Measurements	Use low-level commands for a rear panel measurement.	FUNC, TERM, XRDGS
Digitizing a Waveform	Use low-level commands to digitize a waveform and to enable a voltmeter interrupt.	ENABLE INTR

Getting Started With System Mode operation, you can program the voltmeter for multiplexer or rear panel measurements or you can make field wiring checks.

Multiplexer Measurements

You can make multiplexer measurements in one of three ways: use CONFMEAS; use CONF and MEAS along with low-level commands; or use CONF and/or low-level commands (not using MEAS).

The easiest way to make multiplexer measurements is to use CONFMEAS which sets the voltmeter to a known condition and makes the measurement with a single command. Therefore, first refer to "Measurements Using CONFMEAS" to see if your measurement can be made with CONFMEAS.

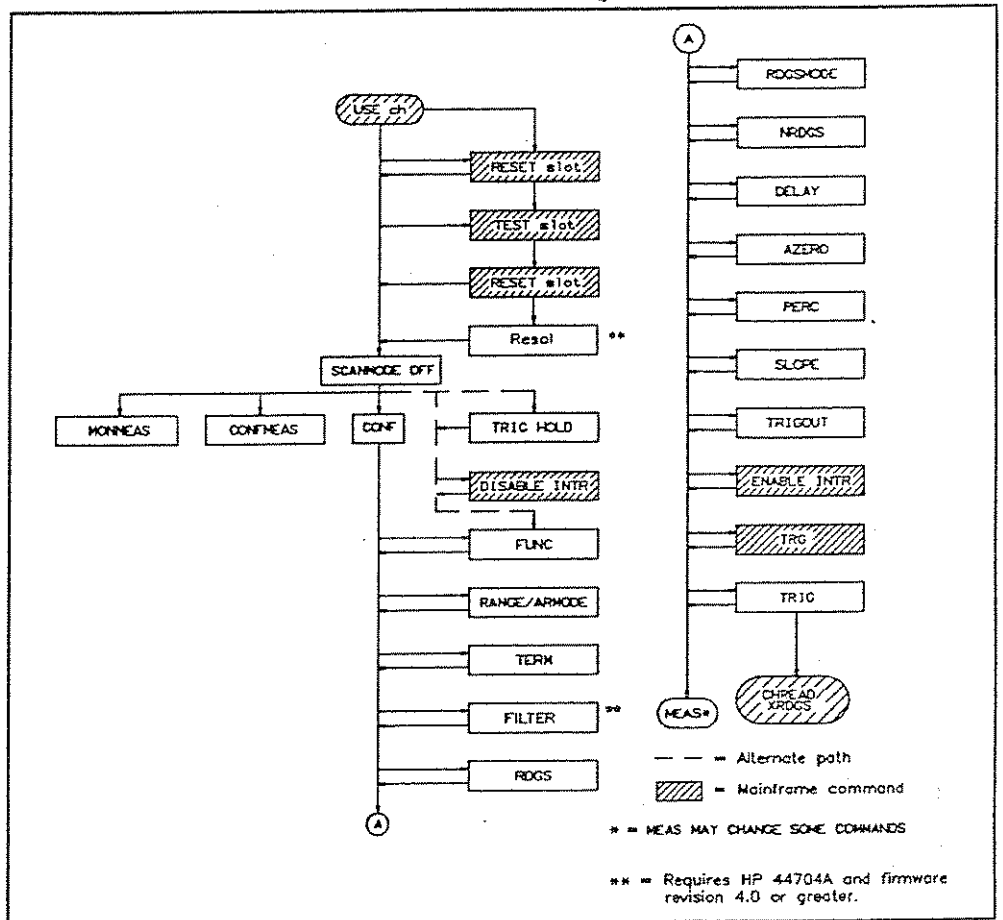

Figure 4-1. System Mode Measurements

Since CONFMEAS sets the voltmeter to a preset condition, if you need to change operating conditions set by CONFMEAS you can use CONF and MEAS along with low-level commands. Refer to "Measurements Using CONF and MEAS" for details.

Using CONFMEAS or CONF and MEAS along with low-level commands will probably meet most multiplexer measurement requirements. However, if you need to enable interrupts, make rear panel measurements, or close channels with the CLOSE command, CONFMEAS or MEAS cannot be used. Refer to "Measurements Not Using MEAS" for applications when CONFMEAS or MEAS cannot be used.

Other Measurements

You can make rear panel measurements using CONF and/or low-level commands. Refer to "Measurements Not Using MEAS" for details. Or, you can check wiring connections by using the MONMEAS command. Refer to Chapter 3 - Installation and Checkout to check multiplexer field wiring connections using MONMEAS.

Programming Sequence

Figure 4-1 shows a suggested programming sequence for System Mode measurements. There are three primary methods of programming (other than using MONMEAS: (1) use CONFMEAS: (2) use CONF and MEAS along with low-level commands: or (3) use CONF and low-level commands (not using MEAS).

In Figure 4-1, solid lines indicate the preferred programming path, dotted lines indicate alternate paths, and striped boxes indicate a mainframe command. For example, for System Mode measurements using CONF and MEAS are required commands, while FUNC, RANGE, etc. are optional commands which can be used to modify the CONF settings as needed.

Use the CONFMEAS sequence for measurements discussed in "Measurements Using CONFMEAS", use the CONF and MEAS sequence for measurements discussed in "Measurements Using CONF and MEAS", or use the CONF and low-level sequence (ending the CHREAD/XRDGS) for measurements discussed in "Measurements Not Using MEAS."

Measurements Using CONFMEAS

This section shows how to make multiplexer measurements using the CONFMEAS command. It includes a summary of the CONFMEAS command, describes voltmeter operation with CONFMEAS in System Mode, shows the preset values for the CONF phase of CONFMEAS, and shows measurement examples using CONFMEAS.

To decide if your measurement can be made with CONFMEAS, read the "CONFMEAS Command", "CONFMEAS Operation", and "CONFMEAS Presets" subsections which follow. If the CONFMEAS operation and presets are acceptable, refer to "Examples: Measurements Using CONFMEAS" for example programs using CONFMEAS. If not, refer to the next section "Measurements Using CONF and MEAS".

CONFMEAS Command

CONFMEAS can be used with the HP High-Speed voltmeter to make DC voltage, DC current (when user-supplied shunt is installed), strain, resistance (2-wire or 4-wire ohms), and temperature (thermocouples, thermistors, or RTDs) measurements. The advantage of using CONFMEAS is that it allows you to quickly and easily configure the voltmeter for a wide variety of measurements with a single command. The CONFMEAS syntax is:

```
CONFMEAS function ch_list [NSCAN number] [USE ch] [INTO name] or  
[fmt]
```

NOTE

1. The *NSCAN* number parameter applies only to instruments which have firmware revision 2.2 or greater.
 2. For the HP 44717A, 44718A, 44719A, and 44720A strain gage multiplexers, *CONFMEAS* includes additional optional and/or required parameters. Refer to the HP 44717A, 44718A, 44719A, 44720A Strain Gage Accessories Configuration and Programming Manual for Details.
-

CONFMEAS configures the voltmeter for a specific measurement function, scans, measures, and transfers data. *CONFMEAS* can be used only for multiplexer measurements. *CONFMEAS* does the following:

- Configures the voltmeter to a function appropriate to the specified measurement function (DCV, OHM, etc.) and sets the voltmeter to a known programmed state. The measurement function is specified by the *function* parameter.
- Causes specified multiplexer channel(s) to be scanned and measured and associated data conversion (voltage to temperature in °C or voltage to strain) to be performed (as required) on the results. The channels to be scanned are defined by the *ch_list* parameter. (The optional *NSCAN number* parameter sets the number of times the channels in the *ch_list* will be scanned.)
- As part of thermocouple measurements, measures the isothermal block reference thermistor on the terminal module to provide a reference value for temperature conversions. *CONFMEAS* can also be used to measure the isothermal block reference temperature only.
- Transfers measurement data to the mainframe memory (when *INTO name* is used) or to the output buffer and/or display (when *INTO name* is not used).

Table 4-2 shows *CONFMEAS function* parameters and data returns for the *function*. Note that *CONFMEAS* is actually two commands in one: *CONF* and *MEAS*. The configuration phase of *CONFMEAS* is equivalent to the *CONF* command, while the measurement phase of *CONFMEAS* is equivalent to the *MEAS* command. That is, *CONFMEAS* is equivalent to a *CONF* command followed immediately by a *MEAS* command.

Table 4-2. CONFMEAS Functions/Data Returns

function:	Configure for:	Data Returned:
DC Voltage		
DcV	DC voltage	DC voltage on chs in ch-list
Resistance		
OHM	2-wire ohms (same as OHM100K)	Resistance on chs in ch_list
OHM10K	2-wire ohms up to 10 k Ω	Resistance on chs in ch_list
OHM100K	2-wire ohms up to 100 k Ω	Resistance on chs in ch_list
OHM1M	2-wire ohms up to 1 M Ω	Resistance on chs in ch_list
OHMF	4-wire ohms (same as OHMF100K) [1]	Resistance on chs in ch_list
OHMF10K	4-wire ohms up to 10 k Ω [1]	Resistance on chs in ch_list
OHMF100K	4-wire ohms up to 100 k Ω [1]	Resistance on chs in ch_list
OHMF1M	4-wire ohms up to 1 M Ω [1]	Resistance on chs in ch_list
Temperature		
TEMPtype	Reference temperature and thermocouple voltage measurements type = B, E, J, K, N14 [N (AWG 14)], N28 [N (AWG 28)], R, S, and T	Thermocouple temp ($^{\circ}$ C) on chs in ch_list, compensated to 0 $^{\circ}$ reference
REFT	Reference temperature measurement of isothermal block	Reference temp ($^{\circ}$ C) of isothermal block in slot addressed
THMtype	2-wire ohms measurement of thermistor type = 2252 (2252 Ω thermistor) = 5K (5 k Ω thermistor) = 10K (10 k Ω thermistor)	Thermistor temp ($^{\circ}$ C) on ch in ch_list
THMFtype	4-wire ohms measurement of thermistor [1] type = Same type as THMtype	Thermistor temp ($^{\circ}$ C) on ch in ch_list
RTDtype	2-wire ohms measurement of RTD type = 85 (RTDs with a = 0.00385 Ω/Ω°) = 92 (RTDs with a = 0.003916 Ω/Ω°)	RTD temp ($^{\circ}$ C) on ch in ch_list
RTDFtype	4-wire ohms measurement of RTD [1] type = same as RTDtype	RTD temp ($^{\circ}$ C) on ch in ch_list
Strain [2]		
STRVEX	Bridge excitation voltage (\pm VS)	Bridge excitation voltage
STRUN	Bridge output which is ref for corresponding strain measurement	Bridge output voltage
STRQ	1/4 bridge strain	Strain or microstrain [3]
STRFB	Bending full bridge strain	Strain or microstrain [3]
STRHB	Bending half bridge strain	Strain or microstrain [3]
STRQTEN	Shunt verification (tension shunt) diagnostic (HP 44717A or 44718A only)	Strain or microstrain [3]
STRQCOMP	Shunt verification (compression shunt) diagnostic (HP 44717A or 44718A only)	Microstrain
STRHP	1/2 bridge Poisson strain	Strain or microstrain [3]
STRFBP	Bending full bridge Poisson strain	Strain or microstrain [3]
STRFP	Full bridge Poisson strain	Strain or microstrain [3]
Notes:		
[1] = For 4-wire ohms functions		
[2] = Refer to the CONFMEAS command in the HP 3852A Command Reference Manual for definitions.		
[3] = Depends on Gage factor (GF factor).		

CONFMEAS Operation

Figure 4-2 is a simplified version of voltmeter operation for CONFMEAS in system Mode. When CONFMEAS is executed the voltmeter is configured (1), any required thermocouple or strain references are measured (2), and the scan sequence is started (3).

When the scan sequence is started, the first channel in the channel list is closed and the voltmeter is triggered. After a 1 msec delay (6 msec if the CONFMEAS *function* is OHM1M or OHMF1M), a measurement (m_1) is made on the first channel in the channel list (4).

When the first channel is measured, the data is transferred to the mainframe (5), the scan is advanced to the second channel in the channel list (6), and a measurement is taken on the second channel. This sequence repeats for each channel in the channel list. When the last channel is measured, the channel is opened and the scan ends (7).

If the CONFMEAS NSCAN *number* parameter (valid only for firmware revision 2.2 and greater) is not specified, the scan sequence ends at (7). If NSCAN *number* is specified, the scan sequence is repeated *number* times. For example, with NSCAN 3 and 10 channels in the channel list, 30 measurements are taken.

CONFMEAS Presets

As noted, executing CONFMEAS is equivalent to executing a CONF command followed immediately by a MEAS command. To help you decide whether to use CONFMEAS or to use CONF and low-level commands, Table 4-3 shows the values set with the CONF command (presets) for System Mode operation (the same values set by the CONF phase of CONFMEAS).

If these presets are acceptable for your measurement, refer to the next subsection "Examples: Measurements Using CONFMEAS" for some example programs using CONFMEAS. If not, refer to the next section "Measurements Using CONF and MEAS".

Executing CONF (or the CONF phase of CONFMEAS) is equivalent to setting the twelve low-level commands shown in Table 4-3 in the order shown. CONF does not change the previous settings of any other System Mode commands.

Thus, CONF does not change the voltmeter mode of operation (SCANMODE OFF is not changed to SCANMODE ON or vice-versa). At power-on or following a reset (RST or RST *slot*), System Mode (SCANMODE OFF) is set.

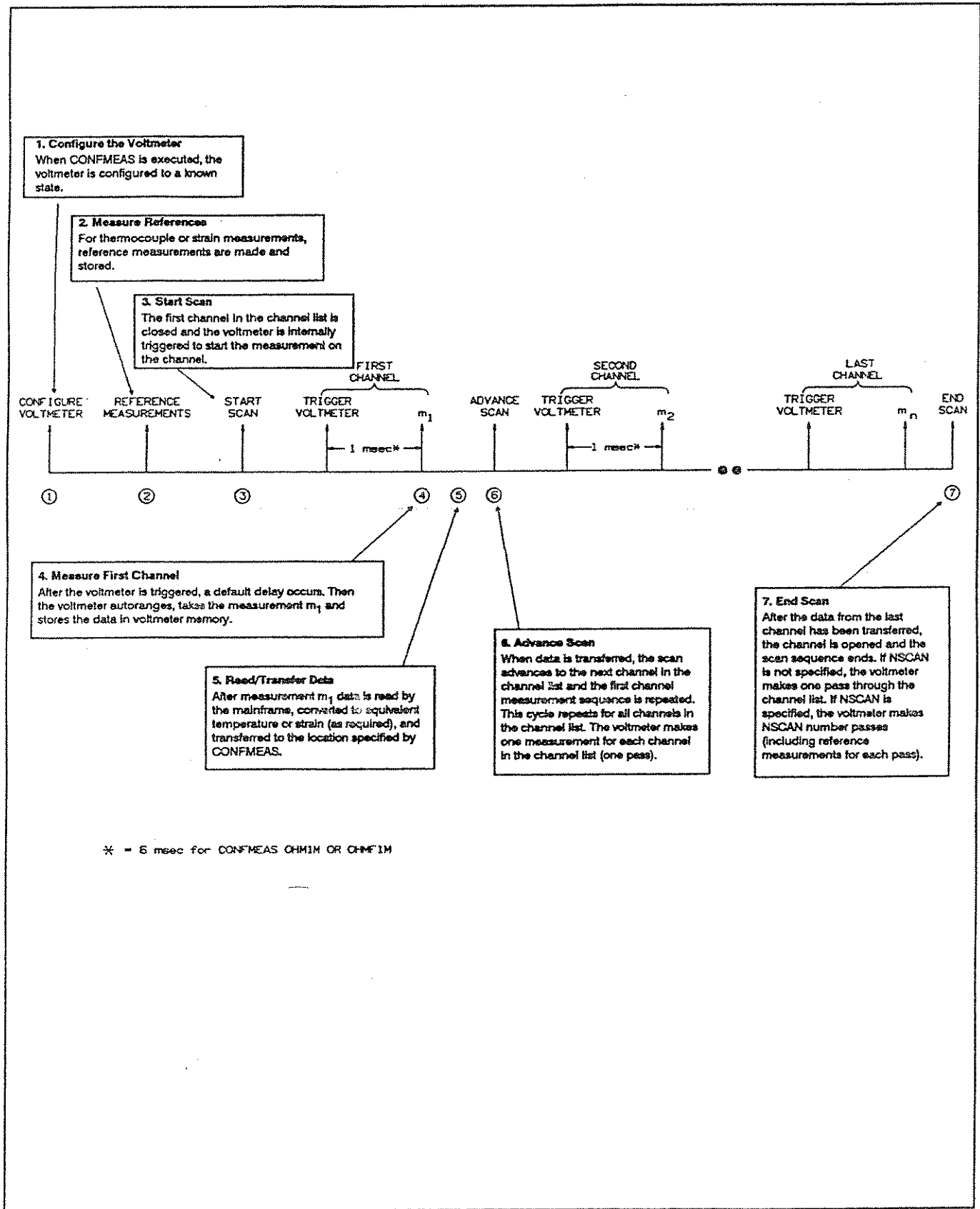

Figure 4-2. CONFMEAS (System Mode) Operation

Table 4-3. CONFMEAS Presets (System Mode)

Command/Presets(S)	Definitions
TRIG SCAN	Starts scan immediately.
SADV SCAN	Advance scan as soon as NRDGS readings are available.
TRIG HOLD	Trigger is disabled. [1]
FUNC DCV or OHMxx	As appropriate for CONF function parameter.
RANGE AUTO	Autorange mode. [2]
NRDGS 1	One reading per trigger.
RDGSMODE DAV	Reading is available when any reading stored.
DELAY 0.001, 0.00001	1 msec trigger-delay, 10 μ sec sample-period. [3]
AZERO ONCE	Autozero once
Notes:	
[1] = Voltmeter is triggered (TRIG SCAN) by the MEAS phase of CONFMEAS.	
[2] = Mainframe firmware revisions before revision 2.2 set a fixed range for CONF TEMPxx.	
[3] = CONF OHM1M and CONF OHMF1M set 6 msec trigger delay and sample period.	

Examples: Measurements Using CONFMEAS

Four program examples using CONFMEAS for System Mode multiplexer measurements follow. The first example measures DC voltage, the second measures resistance using 4-wire ohms, the third measures the temperature of a thermistor and the fourth measures a reference temperature.

The first three examples use an HP 44705A 20-Channel Relay Multiplexer in slot 5 of the mainframe and an HP 44702A/B or HP 44704A voltmeter in slots 6 and 7 of the mainframe (programming slot 6). See Figure 3-2 in Chapter 3 for typical connections. The fourth example uses an HP 44708A in slot 5 of the mainframe. You should also refer to the appropriate multiplexer configuration and programming manual for additional details.

Example:DC Voltage Measurements (CONFMEAS)

This program uses CONFMEAS to measure DC voltages connected to channels 500 through 509 of an HP 44705A multiplexer. Since NSCAN number is not specified, the voltmeter makes a single pass through the channel list.

```

10 DIM Volts(0:9)                                ! Dimension controller array
20 OUTPUT 709;"USE 600"                          ! Use voltmeter in mainframe slot 6
30 OUTPUT 709;"CONFMEAS DCV,500-509"           ! Confmeas DC volts, ch 500-509
40 INTER 709;Volts(*)                            ! Enter 10 readings
50 PRINT USING "K, /";Volts(*)                  ! Display 10 readings
60 END
    
```

For a set of 5V 5 % sources, typical return values (in volts) are:

```

4.9975
5.0025
.
.
4.9875
    
```

Example: Resistance Measurements (CONFMEAS)

CONFMEAS can also be used for 2-wire or 4-wire ohms resistance measurements (refer to Table 4-2). This program measures resistance using 4-wire ohms on channel 500 of an HP 44705A multiplexer.

Note that only the Sense channel (channel 500) is specified in the CONFMEAS *ch_list* parameter, since CONFMEAS automatically assigns the correct channel (channel 510 in this case) as the Source channel. Also, note that CONFMEAS OHMF configures the voltmeter for 4-wire ohms measurements up to 100 k Ω (assumed for this program) and that measurement results are returned in Ω .

```
10 OUTPUT 709;"USE 600"           / Use voltmeter in mainframe slot 6
20 OUTPUT 709;"CONFMEAS OHMF,500" / Conf/meas resistance on ch 500
30 ENTER 709;A                   / Enter results
40 PRINT A                       / Display results
50 END
```

A typical return for a 10 k Ω 5% resistor value (in Ω) is:

9993.75

Example: Temperature Measurements (CONFMEAS)

CONFMEAS can be used for a wide variety of temperature measurements, including RTDs, thermistors, and thermocouples. CONFMEAS can also be used to measure the reference temperature for thermocouple measurements.

The HP 3852A supports 2252 Ω , 5 k Ω , and 10 k Ω thermistors; Type 85 and 92 RTDs; and Type B, E, J, K, N14 [N (AWG 14)], N28 [N (AWG 28)], R, S, and T thermocouples. Both 2-wire and 4-wire ohms techniques can be used for RTD or thermistor measurements, but accuracy is reduced for 2-wire ohms measurements (2-wire ohms measurements are NOT recommended for FET multiplexers).

This program uses CONFMEAS to measure the temperature of a 2252 Ω thermistor connected to channel 500 of an HP 44705A multiplexer. See Figure 3-2 for typical thermistor connections to channels 500 and 510 of the multiplexer.

```

10 OUTPUT 709;"USE 600"           ! Use voltmeter in mainframe slot 6
20 OUTPUT 709;"CONFMEAS THMF2252,500" ! Conf/meas Type 2252 thermistor
30 ENTER 709;A                   ! Enter temperature
40 PRINT A                       ! Display temperature
50 END

```

For a 2252 Ω thermistor at room temperature, a typical return (value in $^{\circ}\text{C}$) is:
24.312

Example: Reference Temperature Measurement (CONFMEAS)

As noted, the HP 3852A supports Type B, E, J, K, N14 [N (AWG 14)], N28 [N (AWG 28)], R, S, and T thermocouples. However, if you want to measure other thermocouples, you will need to measure the reference temperature for use in your own linearization program. This program uses CONFMEAS to measure the reference temperature of an HP 44708A multiplexer in slot 5 of the mainframe.

```

10 OUTPUT 709;"USE 600"           ! Use voltmeter in mainframe slot 6
20 OUTPUT 709;"CONFMEAS REFT,500" ! Measure reference temperature
30 ENTER 709;A                   ! Enter reference temperature
40 PRINT A                       ! Display reference temperature
50 END

```

A typical return value at room temperature (in $^{\circ}\text{C}$) is:
24.312

Measurements Using CONF and MEAS

This section shows how to use CONF and MEAS along with some System Mode low-level commands for multiplexer measurements. Low-level commands discussed in this section are ARMODE, DELAY, NRDGS, RANGE, SADV, SLOPE, STRIG, and TRIG. For rear panel measurements or for a discussion of other System Mode low-level commands, refer to the next section "Measurements Not Using MEAS".

Programming Overview

As previously shown, CONFMEAS configures the voltmeter, takes the measurement, and reads the data with a single command. However, CONFMEAS sets the voltmeter to a specific configuration. If your measurement cannot be made with CONFMEAS, you can modify the voltmeter configuration by using the CONF and MEAS commands and low-level commands.

The programming sequence used in this section will be to first configure the voltmeter to a known state with the CONF command, modify the CONF settings with one or more low-level commands, and use MEAS to make the measurements and transfer the data. We will show how to use seven low-level commands to modify the voltmeter settings: DELAY, NRDGS, RANGE, SADV, SLOPE, STRIG, and TRIG.

Refer to "Setting Voltmeter Operation" for the NRDGS, DELAY, and RANGE commands. Refer to "Setting Voltmeter Triggering" for the TRIG and SLOPE commands. Refer to "Setting Scan Triggering" for the SADV and STRIG commands.

NOTE

You can probably make most System Mode measurements using CONF, MEAS, and one or more of these seven low-level commands. However, if you need to make rear panel measurements, use OPEN and CLOSE, or enable interrupts, MEAS cannot be used. In this case, refer to the next section "Measurements Not Using MEAS".

System Mode Commands Table 4-4 summarizes System Mode low-level commands for the voltmeter with power-on/reset and default values (as applicable). If a command (such as DELAY and RANGE) has two parameters, the command is listed twice - once for each parameter. Refer to the HP 3852A Command Reference Manual for details on the commands.

Table 4-4. System Mode Low-Level Commands

Command	Description	Power-On	Default	Note
ARMODE mode	Autorange mode	AFTER	-	
AZERO [mode]	Autozero mode	ONCE	ONCE	
CAL	Service cmd	-	-	[1]
CHREAD ch	Single data read	-	-	
DELAY trig-delay	Trigger delay	0 μ sec	-	
DELAY [sample-period]	Sample period	10 μ sec	unchd	
DISABLE INTR	Disable intr	-	-	[2]
ENABLE INTR	Enable intr	-	-	
FUNC function	Meas function	DCV	-	
FUNC [range]	Meas range	AUTO	AUTO	
NRDGS number	Rdgs/trigger	1	-	
PERC threshold	Threshold level	0%	-	
RANGE [range]	Voltmeter range	AUTO	AUTO	
RDGS dest	Readings dest	SYS	-	
RDGSMODE mode	Rdgs storage	DAV	-	
SADV source	Scan adv source	SCAN	-	[3]
SCANMODE [mode]	Operating mode	OFF	ON	
SLOPE mode	Input slope	LH	-	
STRIG source	Scan start source	SCAN	-	[3]
TERM terminal	Input terminals	EXT	-	
TRIG [source]	Trigger source	HOLD	SGL	
TRIGOUT [mode]	EXT0 trig mode	OFF	ON	
USE ch	Voltmeter slot	Lowest valid slot and channel	-	[4]
XRDGS ch	Slot to be read	-	-	
XRDGS [Number]	Number readings	-	NRDGS	[5]

Notes:
 [1] = Refer to HP 3852A Assembly Level Service Manual.
 [2] = Interrupts disabled at power-on.
 [3] = Valid for HP 44702A/B or HP 44704A operation only when MEAS is used.
 [4] = May or may not be the slot the voltmeter is in.
 [5] = For System Mode, default is number of readings set by NRDGS

CONF and MEAS Commands Before showing how to use the low-level commands to modify voltmeter settings, we will briefly discuss the CONF and MEAS commands and show the conditions (called preset values) set by CONF.

The CONF Command

Executing CONF *function* [USE *ch*] is equivalent to setting the low-level commands shown in Table 4-5 in the order shown. CONF does not change the previous settings of any other System Mode commands.

Thus, CONF does not change the voltmeter mode of operation (SCANMODE OFF is not changed to SCANMODE ON or vice-versa). At power-on or following a reset (RST or RST *slot*), System Mode (SCANMODE OFF) is set.

Table 4-5. CONF Preset Values (System Mode)

Command/Preset(s)	Definition
STRIG SCAN	Start scan immediately
SADV SCAN	Advance scan as soon as NRDGS readings are available.
TRIG HOLD	Trigger is disabled.
FUNC DCV or OHMxx	As appropriate for CONF function parameter.
RANGE AUTO	Autorange mode [1].
TERM INT	Backplane bus is the input terminal.
NRDGS 1	One reading per trigger
RDGS SYS	Readings are returned to the mainframe.
RDGSMODE DAV	Reading is available when any reading stored.
ARMODE AFTER	Autorange after measurement.
DELAY 0.001,0.00001	1 msec trigger-delay
AZERO ONCE	Autozero once.
Notes:	
[1] = Mainframe firmware revisions before revision 2.2 set a fixed range for CONF TEMPxx.	
[2] = CONF OHM1M and CONF OHMF1M set 6 msec trigger-delay and sample-period.	

The MEAS Command

MEAS *function ch_list* [NSCAN *number*] [USE *ch*] [INTO *name*] or [*fmt*] sets the measurement function appropriate for the *function* parameter, initiates a scan and measurement of the multiplexer channels specified by *ch_list*, and makes the number of passes set by the NSCAN *number* parameter.

When measurements have been taken, MEAS automatically transfers the readings to the mainframe memory (when INTO *name* is used) or to the output buffer and/or display (when INTO *name* is not used). For temperature or strain measurements, MEAS also causes associated conversions to be performed on the results.

For thermocouple and strain measurements, all reference measurements are first made (automatically) and then all channel measurements are made. A reference measurement is made each time a slot is crossed in the channel list. For example, MEAS TEMPJ, 100-223 makes two reference measurements: one for slot 100 and the second for slot 200. However, MEAS TEMPJ,100,200,101,201 makes four reference measurements: slot 100, slot 200, slot 100 again, and slot 200 again.

Executing MEAS disables all interrupts on the voltmeter unless RDGS GPIO (readings destination is the GPIO port) is set. If MEAS detects that the voltmeter function set is not compatible with the MEAS *function* specified, the voltmeter is re-configured and autorange is set. In addition, for System Mode operation, MEAS checks and changes (as necessary) the commands shown in Table 4-6.

Table 4-6. System Mode Commands Changed by MEAS

Command	Setting
FUNC	Changed to function set by MEAS function.
TRIG	TRIG HOLD or TRIG INT changed to TRIG SCAN.
TERM	TERM ZERO changed to TERM INT [1].
DISABLE INTR	DISABLE INTR is set if RDGS SYS is set.
Note:	
[1] = TERM ZERO is a service-related command. Refer to the HP 3852A Assembly Level Service Manual for details on TERM ZERO.	

CONF and MEAS Operation

Since CONF followed immediately by MEAS is equivalent to a CONFMEAS command, voltmeter operation for CONF and MEAS is identical to that for CONFMEAS (see Figure 4-2). However, by using CONF and MEAS along with low-level commands, you can modify voltmeter operation for specific measurement requirements.

Figure 4-3 shows voltmeter operation when CONF and MEAS are used in System Mode and also shows how seven low-level commands (DELAY, NRDGS, RANGE, SADV, SLOPE, STRIG, and TRIG) can be used to modify voltmeter settings). (Note that CONF does not change the previous setting of SLOPE.) A summary of voltmeter operation and the related commands shown in Figure 4-3 follows.

When CONF is executed, the voltmeter is configured and MEAS ensures that the voltmeter is properly set for the specified measurement (1). Then, for strain or temperature measurements, the voltmeter automatically takes and stores the reference measurements (2).

The scan is started by a trigger from the source set by STRIG and the first channel is closed (3). Then, the voltmeter is triggered from the source set by TRIG (4). For TRIG MEAS, EXT0, EXT1, or GPIO, SLOPE sets the input edge (LH or HL) which will trigger the voltmeter.

After the voltmeter is triggered, the voltmeter takes NRDGS *number* readings on the first channel (5) as set by the NRDGS *number* parameter. DELAY *trig_delay* sets the delay between the trigger and the first measurement (m1). The sample period between the start of each measurement (m1 to m2, etc.) is set by the DELAY *sample_period* parameter. As each measurement is taken, data is stored in the voltmeter data buffer.

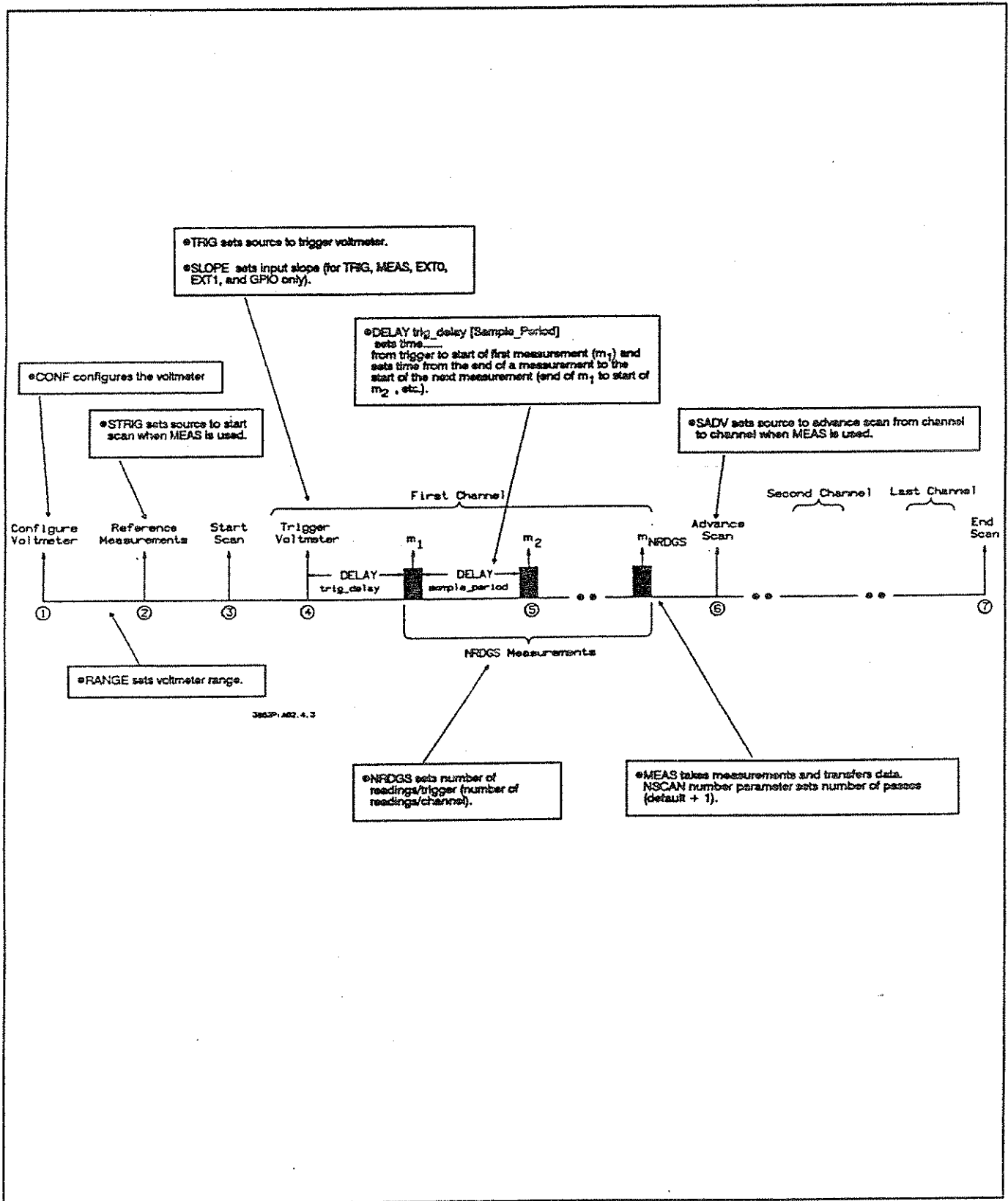

Figure 4-3. CONF and MEAS (System Mode) Operation

Stored readings are transferred to the destination specified by MEAS. All readings from the first channel must be transferred out of the voltmeter buffer before the scan will advance to the second channel.

After readings have been transferred, the scan is advanced to the next channel by a trigger from the source set by SADV (6). (Note that when MEAS is used, STRIG sets the source to start the scan, while SADV sets the source to advance the scan from channel to channel.)

The scan advances through each of the channels in the channel list and the first channel measurement sequence is repeated for each channel. When the data from the last channel has been read, the last channel is opened and the first pass ends (7).

If MEAS NSCAN *number* is not specified, the voltmeter makes one pass through the channel list and the scan sequence ends. Otherwise, the voltmeter makes the number of passes set by NSCAN *number*. For example, with NSCAN 3, ten channels in the channel list, and ten readings/trigger, the voltmeter makes 300 measurements.

Setting Voltmeter Operation

This subsection shows how to use the NRDGS, DELAY, and RANGE commands to set voltmeter operation for System Mode multiplexer measurements and includes a definition of the ARMODE (autorange mode) command.

Setting Number of Readings/Trigger (NRDGS)

For System Mode operation, the voltmeter can be programmed to make from 1 to 65535 measurements for each channel in the channel list as set with NRDGS *number* [USE *ch*]. At power-on, reset (RST), or when CONF is sent the number of readings is set at 1 for each channel (NRDGS 1 is set).

As shown in Figure 4-3, since the voltmeter makes NRDGS *number* readings on each channel in the channel list, the total number of readings taken is the number of channels in the channel list times the number of readings per trigger times NSCAN.

For example, with NRDGS 10 and 10 channels in the channel list, the voltmeter makes 100 readings. Note however, that the 10 readings for channel 1 must be read from the voltmeter buffer before the scan will advance to the next channel. (MEAS automatically transfers the readings as required.)

NOTE

For the HP 44702A, if NRDGS is set >8192 the voltmeter will stop the measurement sequence early if the voltmeter data buffer fills. In this case, the number of measurements taken will vary and no error indication will be given.

Setting Measurement Delays (DELAY) CONF sets a 1 msec delay from the trigger to the first measurement on each channel and sets a 10 μ sec period between each measurement (such as m_1 to m_2 in Figure 4-3). For System Mode (only) both the delay and the sample period can be changed with the DELAY command.

DELAY *trig_delay* sets the delay time (0 to 0.01638375 sec) from the trigger to the start of the first measurement on each channel. DELAY *sample_period* sets the time (0 to 1073.741823 sec) from the start of a measurement to the start of the next measurement on the channel.

For example, DELAY 0.01,1 sets a 10 msec delay from the trigger to the first measurement, and sets a 1 second period from the start of a measurement to the start of the next measurement on the channel (such as m_1 to m_2 in Figure 4-3).

Setting Voltmeter Range (RANGE) At power-on, after a reset (RST), or when CONF is executed, the voltmeter is set for autorange mode. RANGE [*range*] [USE *ch*] can be used to set the voltmeter range or to set autorange. To determine the specific voltmeter range, you must specify the maximum expected signal amplitude or the maximum expected resistance. The voltmeter then automatically selects the correct range. Autorange is selected by entering the word AUTO or the number 0 for the RANGE [*range*] parameter.

Table 4-7 shows the voltmeter range selected by the RANGE *range* command for DC voltage and 4-wire ohms ranges. In Table 4-7, any value between the ranges shown selects the range shown. For example, if the voltmeter is configured for DC voltage by CONF DCV any value of RANGE [*range*] >0.32 through 2.56 sets the voltmeter to the 2.56V range.

Table 4-7. RANGE [range] Parameter Values

DCV		OHMF10K	
range	Selects Range	range	Selects Range
0 or AUTO	Autorange	0 or AUTO	Autorange
>0 - .040	40 mV	>0 - 40	40 Ω
>.04 - .32	320 mV	>40 - 320	320 Ω
>.32 - 2.56	2.56V	>320 - 2560	2.56 kΩ
>2.56 - 10.24	10.24V	>2560 - 10240	10.24 kΩ
OHMF100K		OHMF1M	
range	Selects Range	range	Selects Range
0 or AUTO	Autorange	0 or AUTO	Autorange
>0 - 400	400 Ω	>0 - 4000	4 kΩ
>400 - 3200	3.2 kΩ	>4000 - 32,000	32 kΩ
>3200 - 25600	25.6 kΩ	>32,000 - 256,000	256 kΩ
>25600 - 102400	102.4 kΩ	>256,000 - 1,024,000	1.024 MΩ
* = DCV, OHMF10K, OHMF100K, and OHMF1M are voltmeter measurement functions as set by CONF or FUNC, at power-on, or by a reset (RST)			

Setting Autorange Mode (ARMODE)

The ARMODE command can be used to set the autorange mode when autoranging is enabled. With ARMODE AFTER (power-on setting) and autoranging enabled, the voltmeter autoranges after the trigger is received and then takes the measurement. ARMODE AFTER is used in all examples in this chapter. Refer to Chapter 5 - Scanner Mode Programming for a discussion of the ARMODE command.

Example: Setting Voltmeter Operation

The following example program shows a way to change voltmeter operating parameters using NRDGS, DELAY, and RANGE for DC voltage measurements on channels 500 through 504 of an HP 44705A multiplexer. See Figure 3-2 for typical connections to the multiplexer.

Example: Setting Voltmeter Operation (NRDGS/DELAY/RANGE)

This program uses the NRDGS, DELAY, and RANGE commands to modify the settings made with CONF (refer to Table 4-5). NRDGS 5 changes the number of readings/trigger to 5; DELAY .01, 1 changes the trigger delay to 10 msec and the sample period to 1 sec; and RANGE 9 sets the voltmeter to the 10.24V range for each channel measured. The program assumes that the maximum expected amplitude for channels 500 through 504 is 9 volts. From Table 4-7, setting RANGE 9 selects the 10.24V range.

```

10 DIM Volts(0:24)                               ! Dimension controller array
20 OUTPUT 709;"USE 600"                           ! Use voltmeter in mainframe slot 6
30 OUTPUT 709;"RST 600"                           ! Reset voltmeter
40 OUTPUT 709;"CONF DCV"                          ! Set DC volts
50 OUTPUT 709;"RANGE 9"                           ! Set 10.24V range
60 OUTPUT 709;"NRDGS 5"                           ! Set 5 readings/trigger
70 OUTPUT 709;"DELAY .01,1"                       ! Set 10 msec delay/1 sec period
80 OUTPUT 709;"MEAS DCV,500-504"                  ! Measure channels 500-504
90 ENTER 709;Volts(*)                             ! Enter 25 readings
100 PRINT USING "K,/";Volts(*)                    ! Display 25 readings
110 END

```

For a set of 5V 5% sources, typical return values (in volts) are:

```

4.9975
5.0025
.
.
5.0013

```

Setting Voltmeter Triggering

When CONFMEAS (or CONF followed by MEAS) is used, the voltmeter is automatically triggered as required by a trigger from the mainframe. However, you can use the TRIG command to trigger the voltmeter from one of eight sources. This subsection describes the TRIG command parameters and shows an example use of TRIG.

Setting Trigger Source/ Mode (TRIG)

TRIG [*source*] [USE *ch*] sets the source or mode to trigger the voltmeter, as shown in Table 4-8. Power-on *source* is HOLD (no trigger) and default *source* is SGL (single trigger). For System Mode, CONF (or the CONF phase of CONFMEAS) sets TRIG HOLD, while MEAS (or the MEAS phase of CONFMEAS) changes TRIG HOLD or TRIG INT to TRIG SCAN. A description of each TRIG *source* follows.

Table 4-8. TRIG source Parameters

Source	Definition
HOLD	No triggering. Triggering is held off.
SCAN	Trigger when multiplexer channel is closed.
SGL	Single trigger when TRIG SGL is executed, then set TRIG HOLD.*
INT	Voltmeter internal triggering (internal pacer).
SYS	System trigger pulse (used with TRG command).
EXT0	Trigger on input to the EXT0 port.
EXT1	Trigger on input to the EXT1 port.
MEAS	Trigger when input crosses threshold level.
GPIO	Trigger on input to GPIO port.

* = Cannot be used with MEAS, since MEAS sets TRIG HOLD to TRIG SCAN.

TRIG HOLD

When TRIG HOLD is set, triggering is held off (no trigger).

TRIG SCAN

With TRIG SCAN, the voltmeter is single triggered when a multiplexer channel is closed. TRIG SCAN is set by MEAS or the MEAS phase of CONFMEAS.

TRIG SGL

Use TRIG SGL for a single internal trigger which occurs when the command is executed.

TRIG INT

You can use TRIG INT, TRIG SGL, or TRIG MEAS to internally trigger the voltmeter. With TRIG INT, the pacer in the voltmeter generates internal triggers as required during the measurement scan.

TRIG SYS

TRIG SYS is used with the TRG command. The TRG command has four modes: HOLD, GET, EXT, and SGL. Note that TRIG SYS must be set for the voltmeter to respond to any trigger from the TRG source. Also, note that TRIG SYS/TRG SGL is not viable with MEAS. Refer to the HP 3852A Mainframe Configuration and Programming Manual for details on TRG.

TRIG EXT0/EXT1

You can also trigger the voltmeter with an external input to the EXTERNAL TRIGGER BNC port 0 (EXT0) or port 1 (EXT1) or to the GPIO port. With TRIG EXT0 or TRIG EXT1, a TTL-compatible pulse into the EXT0 or EXT1 port, respectively, triggers the voltmeter. For TRIG MEAS, EXT0, EXT1, or GPIO, the SLOPE command sets the direction (LH or HL) of the input which will trigger the voltmeter.

NOTE

For the EXT0 port (only), TRIGOUT OFF must be set to enable EXT0 to receive a trigger. If TRIGOUT ON is set, the EXT0 port outputs trigger signals and no TRIG source can be set to EXT0. Refer to Chapter 5 - Scanner Mode Measurements for examples using TRIGOUT.

TRIG MEAS

TRIG MEAS generates an internal trigger when the input to the voltmeter crosses a threshold level (percent of full-scale value) as set with the PERC command in the direction (HL or LH) set by the SLOPE command. Refer to "Measurements Not Using MEAS" for an example program using TRIG MEAS, PERC, and SLOPE.

TRIG GPIO

When TRIG GPIO is set, voltmeter triggering is via the GPIO port on the voltmeter rear panel. Refer to Chapter 7 - GPIO Operation for details on TRIG GPIO.

Setting Input Slope (SLOPE) For TRIG MEAS, TRIG EXT0, TRIG EXT1, or TRIG GPIO, the SLOPE *slope* [USE *ch*] command sets the edge (direction) of the input (LH or HL) which will generate the trigger. SLOPE LH sets low-to-high transitions (positive slope) while SLOPE HL sets high-to-low (negative slope) transitions.

Example: Setting Voltmeter Triggering This program enables EXT0 as the voltmeter trigger source and measures the voltage on channel 500 of an HP 44705A multiplexer in slot 5 of the mainframe. See Figure 3-2 for a typical connection diagram.

Example: Setting Voltmeter Triggering (TRIG/SLOPE)

In this program, SLOPE HL and TRIG EXT0 set the voltmeter to be triggered by a high-to-low pulse input to EXT0. (Note that TRIGOUT OFF is set at power-on or by a reset.)

```
10 OUTPUT 709;"USE 600"           ! Use voltmeter in mainframe slot 6
20 OUTPUT 709;"RST 600"           ! Reset the voltmeter
30 OUTPUT 709;"CONF DCV"         ! Configure for DC volts
40 OUTPUT 709;"SLOPE HL"         ! Trigger on high-to-low input to EXT0
50 OUTPUT 709;"TRIG EXT0"        ! Select EXT0 as input source
60 OUTPUT 709;"MEAS DCV,500"     ! Measure voltage on ch 500
70 ENTER 709;A                   ! Enter reading
80 PRINT A                       ! Display reading
90 END
```

For a 5V 5% source, a typical return (value in volts) is:

4.9925

Setting Scan Triggering

When MEAS is used, you can use the STRIG and SADV commands to set the source to start and advance the scan, respectively. Note that STRIG and SADV act to open and/or close multiplexer channels and are not voltmeter commands.

Setting Scan Trigger Source (STRIG)

When MEAS is used, STRIG source sets the trigger source which directs the mainframe to close the first channel in the channel list. Note that the source set by STRIG starts the scan sequence but the source set by SADV advances the scan sequence. Also note that STRIG is a mainframe command and is NOT a voltmeter command. Refer to Table 4-9 for STRIG source parameter descriptions. Power-on and reset source is STRIG SCAN.

Table 4-9. Mainframe Scan Trigger (STRIG) Sources

SCAN	Close first channel automatically at beginning of scan.
CHADV	Rear panel CHANNEL ADVANCE BNC pulse starts scan.
KEY	Front panel SADV KEY key (scan advance key) starts scan.
PACER	Pulse output from PACER OUT BNC starts scan.

Setting Scan Advance Source (SADV)

When MEAS is used, SADV source sets the trigger source to advance the scan sequence from channel to channel. Note that the source set by STRIG starts the scan sequence but the source selected by SADV advances the channel advance. Also note that SADV is a mainframe command and is NOT a voltmeter command. Refer to Table 4-10 for SADV source parameter descriptions. Power-on and reset source is SADV SCAN.

Table 4-10. Scan Advance (SADV) Sources

SCAN	Advance scan automatically as soon as number of readings set by CONF, CONFMEAS, or NRDGS have been taken and readings transferred. (CONF and CONFMEAS set one reading/trigger.)
CHADV	Advance scan when the number of readings set by CONF, CONFMEAS, or NRDGS have been taken and readings transferred and an input to the CHANNEL ADVANCE BNC port occurs.
KEY	Advance scan when the number of readings set by CONF, CONFMEAS, or NRDGS have been taken and readings transferred and the front panel SADV KEY key is pressed.
PACER	Advance scan when the number of readings set by CONF, CONFMEAS, or NRDGS have been taken and readings transferred and a pacer pulse occurs.

Example: Setting Scan Triggering

This example uses the system pacer and the STRIG and SADV commands to control scan start and scan advance for DC voltage measurements on channels 500 through 504 of an HP 44705A multiplexer. See Figure 3-2 for typical connections to the multiplexer.

Example: Setting Scan Triggering (STRIG/SADV)

This program scans channels 500 through 504 and makes three passes through the channel list (15 measurements total). To start the scan, press the front panel SADV KEY key. After a 1 second delay, the voltmeter measures channels 500 through 504 and halts. Press the SADV KEY key again to start the second pass and press the key a third time to start the third pass.

In the program, PACER 0.1 (line 70) sets the system pacer to continuously output pulses at 0.1 second intervals and PDELAY 1 (line 80) delays the first pulse 1 second after PTRIG SGL (line 90) activates the system pacer.

Note that although MEAS NSCAN 3 (line 100) sets three passes through the channel list, the SADV KEY key must be pressed to start the scan for EACH pass (of 5 readings).

```
10 DIM Volts(0:14)                ! Dimension controller array
20 OUTPUT 709;"USE 600"           ! Use voltmeter in slot 6
30 OUTPUT 709;"RST 600"          ! Reset the voltmeter
40 OUTPUT 709;"CONF DCV"         ! Set DC volts set SADV SCAN
50 OUTPUT 709;"STRIG KEY"        ! Start when SADV KEY key pressed
60 OUTPUT 709;"SADV PACER"       ! Set pacer pulses as ch adv source
70 OUTPUT 709;"PACER 0.1"        ! Set pacer pulses at .1 sec apart
80 OUTPUT 709;"PDELAY 1"         ! Delay 1st pacer pulse 1 sec
90 OUTPUT 709;"PTRIG SGL"        ! Send pacer trigger pulse
100 OUTPUT 709;"MEAS DCV,500-504,NSCAN 3"! Meas ch 500-504; make 3 passes
110 ENTER 709;Volts(*)           ! Enter 15 readings
120 PRINT USING "K, ";Volts(*)    ! Display 15 readings
130 END
```

For a set of 5V 5% sources, typical return (values in volts) are:

```
4.9975
4.9925
.
.
5.005
```

Measurements Not Using MEAS

All previous examples in this chapter have used the MEAS command to make the measurement and transfer the data. However, MEAS cannot be used for some applications.

When MEAS is not used, STRIG and SADV are not valid, temperature and strain conversions are not done, CLOSE and OPEN must be used to close and open multiplexer channels, and CHREAD or XRDGS must be used to read the data from the voltmeter buffer.

This section shows some ways to use System Mode low-level commands when MEAS is not used. Three measurement areas are discussed: low-level multiplexer measurements, rear panel measurements, and enabling interrupts.

Low-Level Multiplexer Measurements

Controlling Multiplexer Channels (CLOSE/OPEN)

This subsection shows how to use the OPEN, CLOSE, TRIG, and CHREAD commands to make low-level multiplexer measurements.

When MEAS is not used, you can use the CLOSE *ch_list* command to close channels in the channel list and use the OPEN *ch_list* command to open the channels in the channel list. Note that CLOSE and OPEN do NOT automatically set the tree switches and isolation relays, so these channels must also be specified. Refer to the appropriate multiplexer configuration and programming manual for channel definitions.

CAUTION

The CLOSE command does not close channels in a break-before-make fashion. Therefore, the command can and will cause damage to the multiplexer accessory (relay or FET) and external system if it is used to force one channel open by closing another. This applies to channels in the same bank, in separate banks tied together by the tree relays, and to the relays themselves.

Before a channel is closed with the CLOSE command, use the OPEN command to open the channel that is currently closed. This prevents any two channels from being closed at the same time and reduces the risk of damaging your equipment.

NOTE

CLOSE is a low-level command intended for individual switch control in special signal-routing applications. It is not the easiest way to do routine measurements since the tree switches and isolation relays are not automatically configured as with the high-level commands.

Transferring Readings (CHREAD)

When MEAS is not used, readings stored in the voltmeter buffer can be transferred to the mainframe memory or the output buffer and/or display one at a time with CHREAD *ch* [INTO *name*] or [*fmt*]. CHREAD with INTO *name* transfers data to mainframe memory into a variable or array previously defined with DIM, REAL, INTEGER, or PACKED. (Use VREAD to transfer data stored in mainframe memory to the output buffer and/or display.)

Use CHREAD *ch* [*fmt*] to transfer one reading from the voltmeter buffer to the output buffer/display in the format specified by *fmt*. If neither INTO *name* or *fmt* is used, data is returned in default format to where the command originated.

To transfer a reading, data must be stored in the voltmeter buffer and data must be available (as defined by RDGSMODE *mode*). If a reading is not available when CHREAD is executed, CHREAD waits until the reading is available and the mainframe remains busy.

NOTE

1. When CONFMEAS or MEAS is used, CHREAD is not required (and will not work) since these commands automatically transfer the data to the mainframe memory or output buffer/display as part of the command.
 2. Any programming commands except ENABLE INTR or DISABLE INTR clears the voltmeter buffer. This guarantees that any data returned by CHREAD (or XRDGS) reflects the current programmed state.
-

Example: Low-Level Multiplexer Measurements

This example shows how to use CLOSE and OPEN to control multiplexer channels and how to use CHREAD to transfer the data from channel measurements for an HP 44705A multiplexer. See Figure 3-2 for typical connections to the multiplexer.

Example: Low-Level Multiplexer Measurements (CLOSE/CHREAD)

This program measures the voltage on channels 500 and 501 of an HP 44705A multiplexer. Channel 500 is closed with CLOSE, the voltmeter is triggered with TRIG SGL, and the reading transferred to the controller and displayed. Then, channel 500 is opened with OPEN and the sequence is repeated for channel 501.

```

10 OUTPUT 709;"USE 600"           ! Use voltmeter in mainframe slot 6
20 OUTPUT 709;"RST 600"           ! Reset voltmeter
30 OUTPUT 709;"CONF DCV"         ! Select DC volts
40 OUTPUT 709;"CLOSE 500,591"    ! Close ch 500, sense bus
50 OUTPUT 709;"TRIG SGL"         ! Trigger the voltmeter
60 OUTPUT 709;"CHREAD 600"       ! Read ch 500
70 ENTER 709;A                    ! Enter ch 500 reading
80 PRINT A                        ! Display ch 500 reading
90 OUTPUT 709;"OPEN 500"         ! Open ch 500
100 OUTPUT 709;"CLOSE 501"       ! Close ch 501
110 OUTPUT 709;"TRIG SGL"        ! Trigger the voltmeter
120 OUTPUT 709;"CHREAD 600"     ! Read ch 501
130 ENTER 709;B                   ! Enter ch 501 reading
140 PRINT B                        ! Display ch 501 reading
150 OUTPUT 709;"OPEN 501"       ! Open ch 501
160 END

```

If 5V 5% sources are connected, typical return (values in volts) are:

```

5.0125
4.9975

```

Rear Panel Measurements

This subsection shows how to use the CONF and some low-level commands to make rear panel measurements for System Mode operation. (Only DC volts and 4-wire ohms are allowed for rear panel measurements).

Setting Input Terminals (TERM)

The TERM *terminal* command sets the input source to the voltmeter. TERM EXT sets the rear panel terminals. Note that the power-on mode is TERM EXT. However, if CONF is used with rear panel measurements, set TERM EXT since CONF sets TERM INT (Table 4-5).

Setting Input Threshold (PERC)

For TRIG MEAS, the voltmeter is triggered when the input signal reaches the percent of full-scale voltage set by PERC in the direction set by SLOPE. The range of PERC is -128% to +127% of the full-scale range (resolution 1%) when autoranging is not used. The power-on PERC *threshold* value is 0% of full-scale range.

If autoranging is used, the absolute trigger threshold value will change, based on the current range. Although the same percentage is used, since the full scale value is different for each range, a different absolute value results.

For example, with TRIG MEAS if the voltmeter is set for DC volts and the 10.24V range, PERC 67 sets $10.24 \times 0.67 = 6.86$ volts as the input signal level which will generate a trigger. SLOPE LH sets low-to-high transitions (positive slope) while SLOPE HL sets high-to-low transitions (negative slope).

Table 4-11 lists the minimum (-128%) and maximum (+127%) trigger thresholds allowable for the four voltmeter voltage ranges when autoranging is not used.

Table 4-11. PERC Threshold Levels

Range	Trigger Threshold	
	min(-128%)	max (+127%)
40 mV	-0.0512 V	+0.0508 V
320 mV	-0.41 V	+0.406 V
2.56 V	-3.28 V	+3.25 V
10.24 V	-13.1 V	+13.0 V

Setting Measurement Function (FUNC) *FUNC function [range] [USE ch]* selects a measurement function and a measurement range, where *function* selects the measurement function and *range* selects a measurement range or the autorange mode. Only DCV, OHMF10K, OHMF100K, or OHMF1M can be used for *function*.

To select the FUNC measurement range, specify the expected maximum signal amplitude or maximum resistance. The voltmeter then selects the correct range. To set autorange, use the word AUTO or the number 0 for *range*. Values for the FUNC [*range*] parameter are the same as for the RANGE [*range*] parameter shown in Table 4-7.

Setting Autozero Mode (AZERO) When CONF (or the CONF phase of CONFMEAS) is used, the voltmeter makes a single autozero measurement at the beginning of the measurement sequence. However, as required, you can also use AZERO ONCE to autozero the voltmeter.

Transferring Multiple Readings (XRDGS) When CONFMEAS or MEAS is not used, use XRDGS *ch [number] [INTO name]* or [*fmt*] to transfer multiple readings to the mainframe memory or to the output buffer/display. XRDGS with INTO *name* transfers data to the mainframe memory, while XRDGS without INTO *name* transfers data to the output buffer and/or display. (Use VREAD to read data from mainframe memory to the output buffer and/or display.)

XRDGS *ch [number] [fmt]* transfers multiple readings to the output buffer/display in the format specified by *fmt*, where *number* is the number of readings to be transferred. The range of *number* is 1 to 2147483647.

If *number* is specified, XRDGS transfers any reading which is available until the specified number of readings have been transferred. If *number* is not specified, the mainframe waits until all readings after a trigger are taken, determines how many readings are stored, and then transfers all readings.

For example, XRDGS 600,100 transfers 100 readings from a voltmeter in slot 6 of the mainframe to the output buffer/display (one at a time) as the readings become available. However, XRDGS 600 (*number* not specified) waits until all readings are available, determines the number of readings, and then transfers all readings.

NOTE

1. When CONFMEAS or MEAS is used, XRDGS is not required (and will not work) to transfer data from the voltmeter buffer to mainframe memory or output buffer/display since these commands automatically do this as part of the command sequence.
2. Any Programming command except ENABLE INTR or DISABLE INTR clears the voltmeter buffer. This guarantees that any data returned by XRDGS (or CHREAD) reflects the current programmed state.
3. Potential Mainframe/Controller Deadlock. With INBUF OFF, the controller and the HP 3852A may deadlock if multiple commands are sent in a single command line and a command generates enough data to fill the output buffer (XRDGS can fill the output buffer).

The best way to avoid potential deadlock is to send a single command per command line and read the results as soon as possible after the data-generating command is sent. Refer to Chapter 5 in the HP 3852A Mainframe Configuration and Programming Manual for details on potential deadlock.

Example: Rear Panel Measurements

The following example program makes 10 measurements of a ramp-type input to the voltmeter rear panel terminals when the input crosses 5.12 V in the high-to-low (negative) direction. See Figure 3-4 for typical connections to the rear panel terminals.

Example: Rear Panel Measurements (FUNC/PERC/XRDGS)

In this program, RANGE DCV, 10 sets DC voltage measurements on the 10.24V range so PERC 50 sets 50% of 10.24 = 5.12 V as the threshold which will trigger the voltmeter. The voltmeter will be triggered when the input crosses 5.12 V in the high-to-low (negative) direction and will take 10 measurements at 0.1 sec intervals. Since XRDGS *number* is not specified, all 10 readings are stored and then transferred by the XRDGS command.

10 DIM Volts(0:9)	<i>! Dimension controller array</i>
20 OUTPUT 709;"USE 600"	<i>! Use voltmeter in mainframe slot 6</i>
30 OUTPUT 709;"RST 600"	<i>! test the voltmeter"</i>
40 OUTPUT 709;"FUNC DCV, 10"	<i>! Set DCV, 10,24V range</i>
50 OUTPUT 709;"TERM EXT"	<i>! Set rear terminals as input</i>
60 OUTPUT 709;"NRDGS 10"	<i>! Take 10 readings</i>
70 OUTPUT 709;"DELAY 0,.1"	<i>! Take readings @ 0.1 sec intervals</i>
80 OUTPUT 709;"AZERO ONCE"	<i>! Make autozero measurement</i>
90 OUTPUT 709;"PERC 50"	<i>! Trigger when input is 5.12V</i>
100 OUTPUT 709;"SLOPE HL"	<i>! Trigger on high-to-low transition</i>
110 OUTPUT 709;"TRIG MEAS"	<i>! Trigger when threshold reached</i>
120 OUTPUT 709;"XRDGS 600"	<i>! Transfer 10 readings to output buffer</i>
130 ENTER 709;Volts(*)	<i>! Enter 10 readings</i>
140 PRINT USING "K,/";Volts(*)	<i>! Display 10 readings</i>
150 END	

A typical return for a decreasing ramp input (values in volts) follows.

```

5.1125
5.1075
4.99
.
.
3.98

```

Enabling Interrupts

This subsection shows how to enable the voltmeter to interrupt on data available and shows example ways to service the interrupt in an HP Series 200/300 controller. It describes the commands to set readings destination, (RDGS), to set the readings storage mode (RDGSMODE), and to enable interrupts (ENABLE INTR).

Setting Readings Destination (RDGS)

The destination for readings stored in the voltmeter buffer and for voltmeter interrupts is set with RDGS *dest* [USE *ch*]. SYS sets the mainframe as the destination, while RDGS GPIO sets the GPIO port. Power-on and default mode is RDGS SYS.

With RDGS SYS, measurement data is sent to mainframe memory or to the output buffer/display as specified by a read command (CHREAD, CONFMEAS, MEAS, or XRDGS). Note that with RDGS GPIO, CHREAD and XRDGS are not allowed and that interrupts are sent ONLY to the destination set by RDGS. Refer to Chapter 7 - GPIO Operation for details on RDGS GPIO.

Setting Readings Storage Mode (RDGSMODE) All measurements made by the voltmeter are first stored in the voltmeter buffer (memory) and remain in the buffer until read by a CONFMEAS, MEAS, CHREAD, or XRDGS command (when RDGS SYS is set) or when destroyed by most other commands. Data stored in the voltmeter buffer can be read only on a "data available" condition, as defined by the RDGSMODE command.

RDGSMODE has four modes (DAV, BURST, END, and COMPLETE) and sets both data and interrupt conditions for the voltmeter, as described in the following paragraphs and summarized in Table 4-12.

RDGSMODE DAV

Measurements are available when any reading is in the buffer and measurement data is not overwritten. If the buffer fills, the scan is aborted but data in the buffer when it fills remains valid and is readable.

If an interrupt is enabled with ENABLE INTR, an interrupt is generated whenever there are any measurements in the buffer. DISABLE INTR disables and may clear the interrupt. (DISABLE INTR is done implicitly by the mainframe as part of the servicing routine).

RDGSMODE BURST

Measurements are available when the data buffer has room for only 4096 more readings or at the end of the scan. Measurement data is not overwritten and the scan sequence is aborted if the buffer fills. However, data already in the buffer when it fills remains valid and is readable.

If enabled, an interrupt is generated when the buffer has room for only 4096 more readings or at the end of NRDGS readings. DISABLE INTR disables the interrupt. If the scan sequence is still in progress and the buffer has room for more than 4096 readings (due to a read by CHREAD or XRDGS), DISABLE INTR will also clear the interrupt. (DISABLE INTR is done implicitly by the mainframe as part of the interrupt service).

RDGSMODE END

Measurements are available immediately (when any reading is in the buffer) and data is not overwritten. The scan sequence is aborted if the buffer fills but data in the buffer when it fills remains valid and is readable.

An interrupt, if enabled, is generated ONLY at the end of NRDGS readings after a trigger. DISABLE INTR disables and clears the interrupt. (DISABLE INTR is done implicitly by the mainframe as part of the interrupt service).

RDGSMODE COMPLETE

Data is available ONLY at the end of the scan and data will be overwritten. Interrupts, when enabled, are generated ONLY at the end of NRDGS readings after a trigger. DISABLE INTR disables and clears the interrupt. (DISABLE INTR is done implicitly by the mainframe as part of the interrupt service).

NOTE

For an HP 44702A voltmeter, setting NRDGS 8192 with RDGSMODE COMPLETE results in having only the last 8192 readings available.

Table 4-12. RDGSMODE Data/Interrupt Conditions

Mode	Measurement Data			Interrupts [1]	
	Data Available	Data Over-write?	Scan Aborts?	When Generated	Intr Cleared by DISABLE INTR? [2]
DAV	When any reading is in the buffer	No	Yes - when buffer fills	When any reading is in buffer	May [3]
BURST	Buffer is 4096 rdgs from full -or- scan ends	No	Yes - when buffer fills	Buffer is 4096 rdgs from full -or- NRDGS rdgs after trig	May [4]
END	When any reading is in buffer	No	Yes - when buffer fills	At end of NRDGS rdgs after trig	Yes
COMPLETE	At end of scan ONLY	Yes	No	At end of NRDGS rdgs after trig	Yes

Notes:
 [1] = Assumes interrupt enabled by ENABLE INTR.
 [2] = DISABLE INTR done by mainframe as part of interrupt service.
 [3] = If no readings are left in the buffer.
 [4] = If scan still in progress or if buffer has room for more than 4096 readings (due to read by CHREAD or XRDGS)

Setting Interrupts (ENABLE INTR)

At power-on or when MEAS or CONFMEAS is used, voltmeter interrupts are disabled. However, you can enable interrupts by using the ENABLE INTR command. When enabled, the voltmeter generates an interrupt when data is available (as defined by RDGSMODE).

NOTE

1. Voltmeter interrupts are always serviced by the mainframe, but can be handled by the mainframe or by the controller. Use `DISABLE INTR` to disable the voltmeter from interrupting
 2. The `RDGSMODE` command must be set before the interrupt is enabled. You can use the `INTR?` command to query the status of interrupts. `INTER?` returns the address of the last channel whose interrupt was serviced. If no interrupt has been serviced since power-on or following a system reset, -1 is returned.
-

Handle Interrupt in Mainframe (ENABLE INTR)

To service and handle a voltmeter interrupt in the mainframe, use `ON INTR CALL name` where *name* is the name of the servicing subroutine. When `ON INTR CALL name` is executed (as a result of the interrupt), the interrupt is disabled. Table 4-13 shows a typical sequence of commands to service and handle a voltmeter interrupt in the mainframe.

Table 4-13. Mainframe Interrupt Handling Commands

Command	Description
SUB name	Set up servicing subroutine name in mainframe.
sub commands	Define subroutine servicing action.
SUBEND	End subroutine.
USE ch	Set which voltmeter is to interrupt.
ON INTR CALL name	call servicing subroutine name on interrupt.
ENABLE INTR SYS	Enable mainframe to recognize voltmeter interrupt.
ENABLE INTR	Enable voltmeter to interrupt.

Handle Interrupt in Controller (ENABLE INTR)

Interrupts can also be serviced in the mainframe but handled by the controller. Table 4-14 shows a typical set of commands to service a voltmeter interrupt in the mainframe and handle the interrupt in an HP Series 200/300 or equivalent controller.

Table 4-14. Controller Interrupt Handling Commands

Command	Description
Controller Commands	
ON INTR 7 GOSUB Name -or- CALL Name -or- GOTO Name	Call servicing subroutine name on interrupt.
ENABLE INTR 7;2	Enable interface
Name: I	Start controller subroutine
subroutine commands*	Define subroutine actions
SROLL(709)	Serial Poll - clears SRQ bit
RETURN	End controller subroutine
HP 3852A Commands	
USE ch	Set which voltmeter is to interrupt.
RQS INTR (or RQS 512)	Enable RQS Mask Register INTR bit.
RQS ON	Set RQS Mode ON.
ENABLE INTR SYS	Enable mainframe to recognize voltmeter interrupt.
ENABLE INTR	Enable voltmeter to interrupt on data available.
STA?	Clear Status Register FPS, LCL, INTR, LMT, ALRM bits,
CLROUT	Clear output buffer.
Configuration commands	Set voltmeter configuration for measurement.

Example:Enabling Interrupts

This program samples an input waveform and enables a voltmeter in slot 6 of the mainframe to interrupt when the voltage input to channel 500 of an HP 44705A multiplexer crosses 3.072 V in the positive (low-to-high) direction. The resulting data can be used to digitize the input waveform.

Example: Digitizing a Waveform (ENABLE INTR)

In the following program, when the interrupt occurs, the voltmeter makes 10 measurements at 0.5 second intervals and returns the result to the controller. The interrupt is serviced in controller subroutine Results. See Figure 3-4 for typical connections to the multiplexer.

In the program, CONF sets RDGSMODE DAV which makes measurements available immediately. The STA? command reads the Status Register and clears the FPS, LCL, INTR, LMT, and ALRM bits and CLROUT clears the output buffer. The SROLL command clears the Status Register service request bit (SRQ bit).

10 DIM B(0:9)	<i>! Dimension controller array</i>
20 ON INTR 7 GOTO Results	<i>! Call sub Results on interrupt</i>
30 ENABLE INTR 7;2	<i>! Enable controller intr on SRQ</i>
40 OUTPUT 709;"USE 600"	<i>! Use voltmeter in mainframe slot 6</i>
50 OUTPUT 709;"RST 600"	<i>! Reset the voltmeter</i>
60 OUTPUT 709;"RQS ON"	<i>! Set RQS mode ON</i>
70 OUTPUT 709;"RQS INTR"	<i>! Enable RQS Mask Reg INTR bit</i>
80 OUTPUT 709;"STA?"	<i>! Clear FPS, LCL, INTR, LMT, ALRM bits</i>
90 OUTPUT 709;"CLROUT"	<i>! Clear output buffer</i>
100 OUTPUT 709;"CONF DCV"	<i>! Configure for DC volts</i>
110 OUTPUT 709;"CLOSE 500,591"	<i>! Close ch 500, sense bus</i>
120 OUTPUT 709;"RANGE 9"	<i>! Set 10.24V range</i>
130 OUTPUT 709;"NRDGS 10"	<i>! Take 10 readings after interrupt</i>
140 OUTPUT 709;"DELAY 0,,5"	<i>! Take readings at 0.5 sec intervals</i>
150 OUTPUT 709;"PERC 30"	<i>! Trigger when input crosses 3.072V</i>
160 OUTPUT 709;"ENABLE INTR"	<i>! Enable voltmeter intr capability</i>
170 OUTPUT 709;"ENABLE INTR SYS"	<i>! Enable mainframe intr capability</i>
180 OUTPUT 709;"TRIG MEAS"	<i>! Trigger on input threshold</i>
190 GOTO 190	<i>! Loop until interrupt occurs</i>
200 Results: I	<i>! Start controller subroutine</i>
210 OUTPUT 709;"TIME"	<i>! Query time of day</i>
220 ENTER 709;T	<i>! Enter time of day</i>
230 PRINT "Ch 500 Intr @ ";TIMES(T)	<i>! Print interrupt time/message</i>
240 OUTPUT 709;"XRDGS 600,10"	<i>! Read ch 500 voltages</i>
250 ENTER 709;B(*)	<i>! Enter voltages</i>
260 PRINT "Ch 500 Voltages"	<i>! Display header</i>
270 PRINT USING "K,/";B(*)	<i>! Display voltages</i>
280 A = SPOLL 1709)	<i>! Read/Clear SRQ bit</i>
290 OUTPUT 709;"OPEN 500"	<i>! Open ch 500</i>
300 STOP	<i>! End controller subroutine</i>
310 END	

When the interrupt occurs (input voltage $\geq 3.072V$), the voltmeter takes 10 measurements separated by 0.5 sec intervals. These measurements can be used to digitize the waveform for the 5 second interval following the interrupt. A typical return for an increasing ramp-type function (voltage value in volts) follows.

Ch 500 Intr @ 02:46:50

Ch 500 Voltages

3.2375, 3.8725, 4.4, 4.88, 5.34, 5.675, 6.175, 6.64, 6.87, 6.95

System Mode Command Summary

Table 4- 15 summarizes System Mode commands alphabetically, divided by high-level and low-level commands. High-level commands (CONF, CONFMEAS, MEAS and MONMEAS) perform a series of operations and (when scanning) provide additional measurement functions such as temperature or strain conversions. Low-level commands perform single operations such as changing ranges or transferring readings.

Table 4-15. System Mode Command Summary

High-Level Commands

CONF *function* [USE *ch*]

Configure the voltmeter measurement function (DCV, OHMF, etc.) and preset values for other functions (autozero, range, etc).

CONFMEAS *function ch-list* [NSCAN *number*] [USE *ch*] [INTO *name*] or [*fmt*]

Configure the voltmeter function, scan, and measure. CONFMEAS is equivalent to CONF followed immediately by MEAS. CONFMEAS is used for multiplexer measurements. NSCAN *number* is valid only for mainframe firmware revision 2.2 and greater.

MEAS *function ch_list* [NSCAN *number*] [USE *ch*] [INTO *name*] or [*fmt*]

Set the voltmeter measurement function and initiate a scan and measurement of multiplexer channels specified by *ch_list*. NSCAN *number* is valid only for mainframe firmware revision 2.2 and greater.

MONMEAS *function ch_list* [USE *ch*]

Select voltmeter measurement function, measure, and display. MONMEAS selects the voltmeter function, then causes the voltmeter to measure the first channel in the channel list and display the results on the display. The measurement sequence is advanced to the next channel in the list when the front panel SADV KEY key is pressed.

Low-Level Commands

ARMODE *mode* [USE *ch*]

Sets the autorange mode (BEFORE or AFTER). For ARMODE AFTER (power-on) when autoranging is enabled the voltmeter autoranges after a trigger is received and then takes the reading for each measurement.

AZERO [*mode*] [USE *ch*]

Autozero the voltmeter. AZERO ONCE is the only available mode for the voltmeter.

CAL

Service-related command. Refer to the HP 3852A Assembly Level Service Manual.

Table 4-15. System Mode Command Summary

CHREAD *ch* [INTO *name*] or [*fmt*]

Transfer a single reading stored in the voltmeter buffer to the mainframe memory or to the output buffer and/or display. The voltmeter must have been triggered and data must be available before CHREAD will return a reading.

DELAY *trig_delay* [*sample_period*] [USE *ch*]

Sets the delay between the voltmeter trigger and the start of the channel measurement (trigger delay) and sets the delay between the start of measurements (sample period) when the voltmeter is in System Mode. DELAY *trig_delay* sets the trigger delay (0 to 0.01638375 sec) and DELAY *sample_period* (0 to 1073,741823 sec) sets the sample period.

DISABLE INTR [USE *ch*]

Prevents the voltmeter from generating an interrupt when data is available (as defined by RDGSMODE).

ENABLE INTR [USE *ch*]

Enables the voltmeter to generate an interrupt when data is available (as defined by RDGSMODE). The interrupt can be serviced and handled by the mainframe or serviced by the mainframe and handled by the controller.

FILTER *mode* [USE *ch*] (HP 44704A only)

Enables (*mode* ON), or disables (*mode* OFF) the HP 44704A's low-pass input filter.

FUNC *function* [*range*] [USE *ch*]

Sets the measurement function and range. The *function* parameter can be set only for DC voltage or 4-wire ohms measurements. The *range* parameter can be set to one of four ranges or to autorange (AUTO). See Chapter 6 for controlling range while in 16 bit resolution mode (HP 44704A only).

ID? [*slot*]

Returns the identity of the accessory in the slot addressed by *slot*. An HP 44702A returns 44702A

INTR? [INTO *name*] or [*fmt*]

Returns the address of the last channel whose interrupt was serviced. If no interrupt has been serviced since power-on or following a system reset, -1 is returned.

NRDGS *number* [USE *ch*]

Sets the number of readings/trigger for each channel in the channel list. The range of *number* is 1 to 65535. For the HP 44702A, setting NRDGS 8192 can cause a variable number of readings to be taken with no error given.

PERC *threshold* [USE *ch*]

For TRIG MEAS only, PERC sets the level of the input (in the direction set by SLOPE) which will cause the voltmeter to be triggered.

RANGE [*range*] [USE *ch*]

Sets the voltmeter measurement range or enables the autorange mode. See Chapter 6 for controlling range while in 16 bit resolution mode (HP 44704A only).

Table 4-15. System Mode Command Summary

RDGS *dest* [USE *ch*]

Sets the mainframe or the GPIO port as the destination for readings stored in the voltmeter buffer memory. RDGS SYS sets the mainframe, RDGS GPIO sets the GPIO port.

RDGSMODE *mode* [USE *ch*]

Sets the voltmeter reading storage mode and specifies when data can be read from the voltmeter buffer (data available). Also specifies whether or not data in the memory will be overwritten by new data. Valid *modes* are DAV, BURST, END, and COMPLETE.

RESOL *resolution* (HP 44704A only)

Sets HP 44704A resolution. *resolution* can be 13, 14, or 16. For RESOL 16, the voltmeter must not be in autorange mode or an error will be generated. See Chapter 6 for details on 16 bit resolution mode.

SADV *source*

When MEAS is used, sets the source to advance the scan sequence as defined by *source*.

SCANMODE *mode* [USE *ch*]

Sets the voltmeter operating mode. SCANMODE OFF, power-on, reset (RST or RST slot), CONF, or CONFMEAS sets System Mode operation. The SCANMODE setting is not changed by the high-level commands.

SLOPE *mode* [USE *ch*]

For TRIG EXT0, TRIG EXT1, TRIG MEAS, or TRIG GPIO, SLOPE sets the edge (LH or HL) of the input which will generate a voltmeter trigger. For TRIG MEAS only, SLOPE sets the edge of the input which will trigger the voltmeter when the input crossed the threshold set by PERC.

STRIG *source*

When MEAS is used, sets the source to start the scan sequence as defined by *source*. Valid *source* parameters are SCAN, CHADV, KEY, and PACER.

TERM *terminal* [USE *ch*]

Selects the voltmeter input terminals. TERM INT selects the mainframe backplane and TERM EXT selects the rear panel terminals.

TRIG [*source*] [USE *ch*]

For System Mode (only), TRIG sets the source or mode for the trigger. The power-on *source* is HOLD (no trigger) and the default *source* is SGL (single trigger from source).

TRIGOUT [*mode*] [USE *ch*]

Sets whether EXT0 will output triggers or be enabled to receive triggers. With TRIGOUT OFF, EXT0 can receive triggers. With TRIGOUT ON, EXT0 outputs measurement triggers (not triggers as defined by TRIG).

USE *ch*

Specifies the slot to be used for voltmeter commands.

USE? [INTO *name*] or [*fmt*]

Returns the current USED channel (or slot) address last set by the USE command.

Table 4-15. System Mode Command Summary

XRDGS *ch* [*number*] [INTO *name*] or [*fmt*]

Transfers the number of readings specified by *number* from the voltmeter buffer to the mainframe memory or to the output buffer and/or display. Default *number* = 1.



Chapter 5

Scanner Mode Programming

Contents

Introduction	5-1	Number of Prescans (PRESCAN)	5-49
Chapter Contents	5-1	Number of Postscans (POSTSCAN)	5-50
Scanner Mode Measurements	5-2	Number of Readings (NRDGS)	5-50
Getting Started	5-4	Example: Setting Number of Readings	5-51
Measurements Using CONFMEAS	5-6	Selecting Voltmeter Triggering	5-52
CONFMEAS Programming	5-6	Triggering Overview	5-53
CONFMEAS Command	5-6	Voltmeter Trigger Operation	5-53
CONFMEAS Operation	5-10	Voltmeter Trigger Sources	5-55
CONFMEAS Programming Sequence	5-10	Setting Scan Triggering	5-56
CONFMEAS Measurement Examples	5-11	Scan Trigger Source (SCTRIG)	5-56
Example: DC Voltage Measurements	5-12	Scan Trigger Slope (SCSLOPE)	5-59
Example: Resistance Measurements	5-12	Scan Trigger Threshold (PERC)	5-59
Example: Temperature Measurements	5-12	Scan Trigger Delay (SCDELAY)	5-60
Example: Reference Temperature Measurement	5-13	Autoscan Mode (ASCAN)	5-61
Measurements Using CONF and MEAS	5-13	Example: Setting Scan Triggering	5-63
Programming Overview	5-14	Setting Measure Triggering	5-64
CONF and MEAS Overview	5-16	Measure Trigger Source (TRIG)	5-65
CONF and MEAS Operation	5-16	Measure Trigger Slope (SLOPE)	5-66
CONF and MEAS Commands	5-18	Measure Trigger Timing (SPER)	5-66
Low-Level Commands	5-21	EXT0 Port Triggering (TRIGOUT)	5-68
Selecting Voltmeter Configuration	5-22	Example: Setting Measure Trigger	5-70
Setting Known State	5-23	Setting Stop Triggering	5-71
Setting Function/Range	5-23	Stop Trigger Source (STTRIG)	5-71
Setting Readings	5-24	Stop Trigger Slope (STSLOPE)	5-73
Example: Setting Voltmeter Configuration	5-25	Stop Trigger Threshold (PERC)	5-73
Selecting Voltmeter Triggering	5-26	Example: Setting Stop Trigger	5-75
Setting Scan Trigger	5-27	Selecting Data Transfers/ Interrupts	5-77
Setting Measure Trigger	5-29	Setting Data Destination/Storage	5-78
Example: Setting Voltmeter Triggering	5-30	Readings Destination (RDGS)	5-78
Measurements Using CONF and Low-Level Commands	5-31	Readings Storage Mode (RDGSMODE)	5-78
Programming Overview	5-32	Transferring Readings	5-80
Scanner Mode Overview	5-34	Transfer Single Reading (CHREAD)	5-81
Voltmeter Architecture	5-34	Transfer Multiple Readings (XRDGS)	5-81
Voltmeter Operation	5-36	Setting Interrupts	5-82
CONF Preset Values	5-39	Enabling Interrupts (ENABLE INTR)	5-82
Low-Level Commands	5-40	Disabling Interrupts (DISABLE INTR)	5-84
Selecting Voltmeter Configurations	5-41	Example: Setting Voltmeter Interrupts	5-84
Setting Known state	5-41	Measurement Examples	5-86
Voltmeter Slot (USE)	5-41	Digitizing Waveforms	5-86
Set Scanner Mode (SCANMODE)	5-41	Example: Capture of a "Window" of Data	5-87
Configure Voltmeter (CONF)	5-42	Example: Digitize a Waveform	5-83
Setting Operating Parameter	5-42	Example: Graphing a Waveform	5-90
Input Terminals (TERM)	5-42	High-Speed Data Transfers	5-91
Autozero (AZERO)	5-42	Example: Transfer Data to Mainframe	5-91
Voltmeter Function (FUNC)	5-42	Example: Transfer Data to Controller	5-92
Setting Range/ Channel Lists	5-43	Example: Rear Panel Measurements	5-94
Voltmeter Range (RANGE)	5-43	Special Applications	5-96
Autorange Mode (ARMODE)	5-43	Example: Continuous Data Acquisition	5-96
Channel/Range Lists (CLWRITE)	5-46	Example: Synchronize Multiple Voltmeters	5-101
Example: Setting Channel/Range Lists	5-48	Example: 60 Hz Noise Rejection	5-104
Setting Number of Readings	5-49	Scanner Mode Command Summary	5-107

Scanner Mode Programming

Introduction

This chapter shows how to program the voltmeter for Scanner Mode (SCANMODE ON) ribbon cable measurements. Refer to Chapter 4 - System Mode Programming for System Mode (SCANMODE OFF) measurements. The chapter does not include GPIO operation (RDGS GPIO is set). Refer to Chapter 7 - GPIO Operation for GPIO measurements.

NOTE

This chapter applies directly to the HP 44702A/B, and HP 44704A in 13 and 14 bit resolution modes. The fundamentals covered here also apply to the HP 44704A in 16 bit resolution mode, but some differences exist. These are covered in Chapter 6 - The HP 44704A in 16 Bit Mode.

Chapter Contents

This chapter has six sections:

- **Introduction** lists the chapter contents, summarizes types of Scanner Mode measurements, and shows a suggested getting started sequence.
- **Measurements Using CONFMEAS** shows how to make Scanner Mode ribbon cable measurements using the CONFMEAS command. CONFMEAS configures the voltmeter and takes the measurement with a single command, so this is the easiest way to make Scanner Mode ribbon cable measurements. However, CONFMEAS presets the voltmeter so there is no programming flexibility. In addition, CONFMEAS cannot be used for high-speed measurements.
- **Measurements Using CONF and MEAS** shows how to make Scanner Mode ribbon cable measurements using the CONF and MEAS commands along with some low-level commands. Using CONF and MEAS along with low-level commands allows increased programming flexibility, but does not offer the capabilities of using CONF and low-level commands.

- **Measurements Using CONF and Low-Level Commands** shows how to use CONF and low-level commands to make Scanner Mode ribbon cable measurements. With low-level commands, you can make full use of the voltmeter capabilities and can make measurements at rates up to 100,000 readings per second.
- **Measurement Examples** contains typical measurement applications for the voltmeter, including digitizing waveforms, high-speed data transfers, and special applications. You may want to refer to this section when reading the "Measurements Using CONF and Low-Level Commands" section.
- **Scanner Mode Command Summary** is an alphabetical summary of Scanner Mode low-level commands.

Scanner Mode Measurements

With Scanner Mode operation you can program the voltmeter for ribbon cable, backplane, or rear panel measurements or you can make field wiring checks. Figure 5-1 summarizes Scanner Mode measurements and shows the programming methods which can be used to program the voltmeter.

For example, for Scanner Mode ribbon cable measurements the voltmeter can be programmed using the CONFMEAS command; using CONF, low-level, and MEAS commands; or using CONF, low-level, and CHREAD or XRDGS commands.

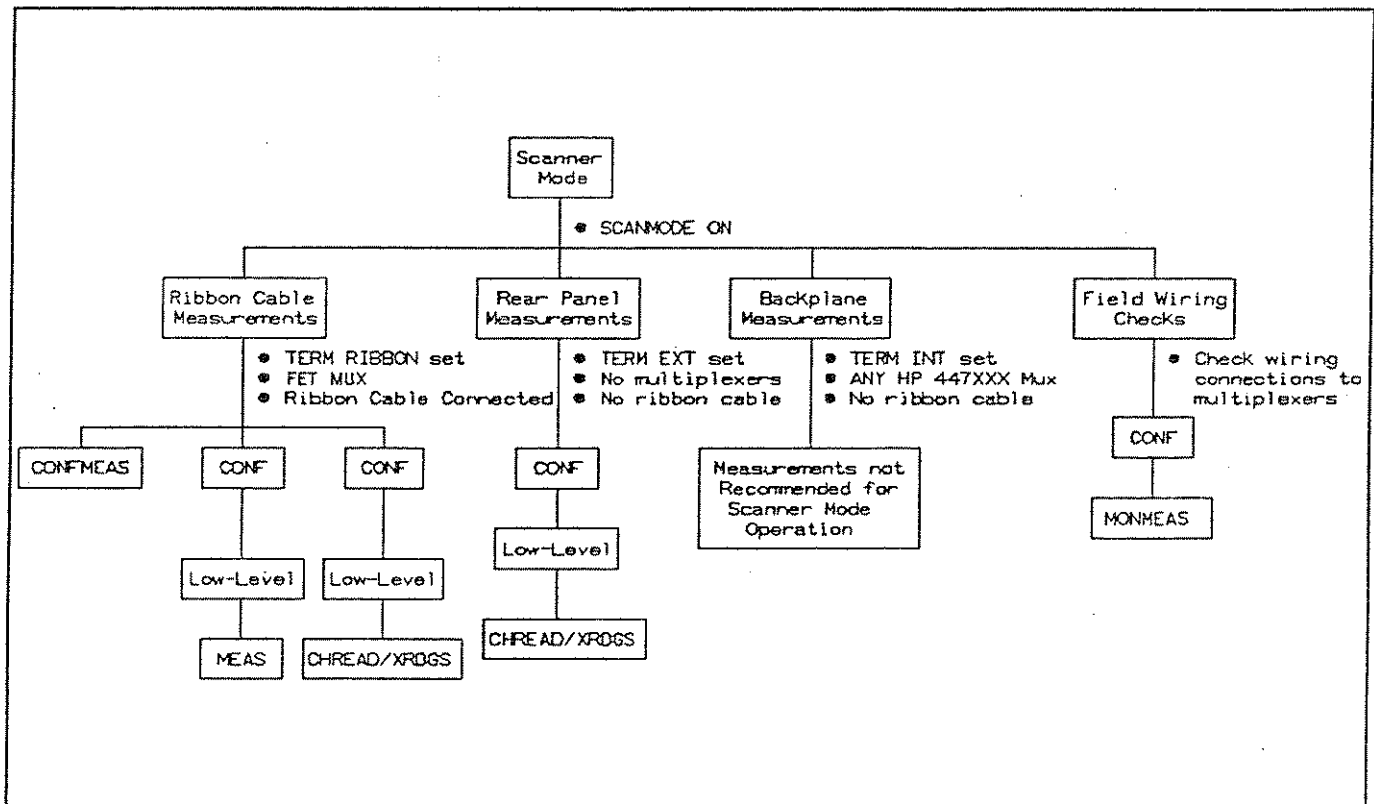

Figure 5-1. Scanner Mode Measurements

NOTE

Although backplane measurements can be made for Scanner Mode operation, backplane measurements are not recommended and are not discussed in this chapter. Unless otherwise indicated, all discussion and measurement examples are for ribbon cable (TERM RIBBON) operation.

Ribbon Cable Measurements

In Scanner Mode, all features of the voltmeter are available to the user. In addition, with ribbon cable measurements the voltmeter is capable of "stand-alone" scanning over the dedicated ribbon cable and measurement speeds up to 100,000 readings/second (single-channel and channel-to-channel) are Possible.

Measurement results can be transferred to the mainframe at rates up to 90,000 readings/second, to an HP Series 200/300 controller via HP-IB at rates up to about 35,000 readings/sec or to an HP Series 200/300 controller via GPIO at rates up to 100,000 readings/second. Thus, ribbon cable measurements are ideal for applications such as capturing a "window" of data or digitizing a waveform.

To make ribbon cable measurements HP 44711A/B, 44712A, or 44713A/B multiplexer(s) must be used, the dedicated ribbon cable must be connected between the multiplexer(s) and the voltmeter, and the ribbon cable must be specified as the voltmeter input (with TERM RIBBON).

As noted, three programming methods are available for ribbon cable measurements: (1) use the CONFMEAS command; (2) use CONF, low-level commands, and MEAS; or (3) use CONF, low-level commands, and CHREAD/XRDGS. The method to use depends on your measurement requirements.

Rear Panel Measurements

For rear panel measurements, the input is to the voltmeter rear panel terminals, so TERM EXT must be set. You can make Scanner Mode rear panel measurements using CONF and/or low-level commands.

Backplane Measurements

For backplane measurements, the user signal is input to any HP 447XXX multiplexer and is sent to the voltmeter via the mainframe backplane. For Scanner Mode backplane measurements, TERM INT must be set and ribbon cable(s) must NOT be connected between HP 44711A/B, HP 44712A, or HP 44713A/B multiplexers and the voltmeter.

You can make backplane measurements using CONF and MEAS along with low-level commands or use CONF and/or low-level commands (not using MEAS). However, as noted, backplane measurements are not recommended and will not be discussed in this chapter.

Field Wiring Checks

You can also use MONMEAS to make field wiring checks of inputs connected to multiplexers. To make field wiring checks, first refer to the MONMEAS command in the HP 3852A Command Reference Manual for MONMEAS operation. Then, refer to Chapter 3 - Installation and Checkout for an example program.

Getting Started

As noted, this chapter shows how to make Scanner Mode ribbon cable measurements with one of three programming methods: using CONFMEAS; using CONF and MEAS; or using CONF and low-level commands. The chapter contains three sections which correspond to these programming methods: "Measurements Using CONFMEAS", "Measurements Using CONF and MEAS", and "Measurements Using CONF and Low-Level Commands".

To get started programming the voltmeter for your measurement, first determine your measurement requirements (refer to Chapter 2 - Defining Your Measurement for guidelines). Then, use the guidelines shown in Table 5-1 to find the chapter section to use to program the voltmeter for your measurement.

If your measurement can be made using CONFMEAS, refer to "Measurements Using CONFMEAS". If your measurement can be made using CONF and MEAS, first refer to "Measurements Using CONFMEAS" and then to "Measurements Using CONF and MEAS". If your measurement requires using low-level commands, first refer to "Measurements Using CONFMEAS" and then to "Measurements Using CONF and Low-Level Commands". A summary of the three programming methods follows.

NOTE

Even if your measurement cannot be made with CONFMEAS, we recommend you first read "Measurements Using CONFMEAS" to become familiar with general Scanner Mode operation before reading "Measurements Using CONF and MEAS" or "Measurements Using CONF and Low-Level Commands".

Table 5-1. Scanner Mode Programming Guidelines

<p>Measurements Using CONFMEAS</p> <ul style="list-style-type: none">Easiest programmingPreset operationOne reading per channelLow-Speed (≤ 1000 readings/sec)No interruptsHP-IB operation/mainframe memory onlyRibbon cable mode
<p>Measurements Using CONF and MEAS</p> <ul style="list-style-type: none">Increased programming flexibilityCan change some presetsMultiple readings per channelHigh-speed measurements [1]No interrupts [2]Mainframe HP-IB or GPIO operationRibbon cable or backplane measurements
<p>Measurements Using CONF and Low-Level Commands</p> <ul style="list-style-type: none">Maximum programming flexibilityCan change all presetsMultiple readings per channelMultiple passes through channel listHigh-speed measurementsInterrupts capabilityMainframe HP-IB or GPIO operationAll measurement types
<p>Notes:</p> <p>[1] = The measurement sequence may abort if a large number of readings are taken at high speed.</p> <p>[2] = Interrupts are allowed with MEAS in GPIO operation.</p>

Measurements Using CONFMEAS

The easiest way to program the voltmeter for Scanner Mode ribbon cable measurements is to use the CONFMEAS command. CONFMEAS sets the voltmeter to a known state, takes the measurement, and reads the result all with a single command.

“Measurements Using CONFMEAS” describes the CONFMEAS command and operation and shows example programs using CONFMEAS. Even if your measurement cannot be made using CONFMEAS, you should first read this section to become familiar with basic Scanner Mode operation.

Measurements Using CONF and MEAS

“Measurements Using CONF and MEAS” shows how CONF and MEAS can be used with some low-level commands for Scanner Mode ribbon cable measurements. This programming method allows you to select some voltmeter parameters and has increased programming flexibility. However, since MEAS presets some parameters, full programming flexibility is not available.

Measurements Using CONF and Low-Level Commands

“Measurements Using CONF and Low-Level Commands” shows how to use the CONF command and low-level commands to make Scanner Mode ribbon cable measurements. This programming method offers maximum flexibility to configure and trigger the voltmeter for specific measurement requirements, especially for high-speed requirements.

Measurements Using CONFMEAS

This section shows how to make Scanner Mode ribbon cable measurements using the CONFMEAS command. It includes a summary of the CONFMEAS command, describes Scanner Mode operation with CONFMEAS, shows a recommended sequence to program the voltmeter with CONFMEAS, and lists measurement examples using CONFMEAS.

If your measurement can be made with CONFMEAS, refer to “CONFMEAS Measurement Examples” at the end of this section for DC voltage, resistance, and temperature measurement examples using CONFMEAS. If your measurement cannot be made with CONFMEAS, refer to “Measurements Using CONF and MEAS” or to “Measurements Using CONF and Low-Level Commands” as required.

NOTE

To more easily program the voltmeter for Scanner Mode operation, we suggest that you first read this section and run the example measurements using CONFMEAS, even if your measurement cannot be made with CONFMEAS.

CONFMEAS Programming

A description of the CONFMEAS command, CONFMEAS operation, and CONFMEAS programming sequence follows.

CONFMEAS Command

CONFMEAS can be used with the HP 44702A/B or HP 44704A voltmeter to make DC voltage, DC current (when a user-supplied shunt is installed), strain, resistance (2-wire or 4-wire ohms), and temperature (thermocouples, thermistors, or RTDs) measurements. The advantage of using CONFMEAS is that it allows you to quickly and easily configure the voltmeter for a wide variety of measurements with a single command. The CONFMEAS syntax is :

CONFMEAS *function ch_list* [NSCAN *number*] [USE *ch*] [INTO *name*] or [*fmt*]

NOTE

1. The NSCAN number parameter applies only to instruments which have firmware revision 2.2 or greater.
 2. For the HP 44717A, 44718A, 44719A, and 44720A strain gage multiplexers, CONFMEAS includes additional optional and/or required parameters. Refer to the HP 44717A, 44718A, 44719A, and 44720A Strain Gage Accessories Configuration and Programming Manual for details.
-

CONFMEAS configures the voltmeter for a specific measurement function, scans, measures, and transfers data. In Scanner Mode, CONFMEAS can be used only for ribbon cable measurements. CONFMEAS does the following:

- Configures the voltmeter to a function appropriate to the specified measurement function (DCV, OHM, etc.) and sets the voltmeter to a known programmed state. The measurement function is specified by the *function* parameter.
- Causes specified multiplexer channel(s) to be scanned and measured and associated data conversion (voltage to temperature in °C or voltage to strain) to be performed (as required) on the results. The channels to be scanned are defined by the *ch_list* parameter. (The optional NSCAN *number* parameter sets the number of times the channels in the *ch_list* will be scanned.)
- As part of thermocouple measurements, measures the isothermal block reference thermistor on the terminal module to provide a reference value for temperature conversions. CONFMEAS can also be used to measure the isothermal block reference temperature only.
- Transfers measurement data to the mainframe memory (when INTO *name* is used) or to the output buffer and/or display (when INTO *name* is not used).

Table 5-2 shows CONFMEAS *function* parameters and data returns for Scanner Mode ribbon cable operation. Note that CONFMEAS is actually two commands in one: CONF and MEAS. The configuration phase of CONFMEAS is equivalent to the CONF command, while the measurement phase of CONFMEAS is equivalent to the MEAS command. That is, CONFMEAS is equivalent to a CONF command followed immediately by a MEAS command.

Table 5-2. CONFMEAS Functions/Data Returns

function:	Configure for:	Data Returned:
DC Voltage		
DCV	DC voltage	DC voltage on chs in ch_list
Resistance		
OHM	2-wire ohms (same as OHM100K)	Resistance on chs in ch_list
OHM10K	2-wire ohms up to 10 k Ω	Resistance on chs in ch_list
OHM100K	2-wire ohms up to 100 k Ω	Resistance on chs in ch_list
OHM1M	2-wire ohms up to 1 M Ω	Resistance on chs in ch_list
OHMF	4-wire ohms (same as OHMF100K) [1]	Resistance on chs in ch_list
OHMF10K	4-wire ohms up to 10 k Ω [1]	Resistance on chs in ch_list
OHMF100K	4-wire ohms up to 100 k Ω [1]	Resistance on chs in ch_list
OHMF1M	4-wire ohms up to 1 M Ω [1]	Resistance on chs in ch_list
Temperature		
TEMPtype	Reference temperature and thermocouple voltage measurements type = B, E, J, K, N14 [N (AWG 14)], N28 [N (AWG 28)], R, S, and T	Thermocouple temp ($^{\circ}$ C) on chs in ch_list, compensated to 0 $^{\circ}$ reference
REFT	Reference temperature measurement of isothermal block	Reference temp ($^{\circ}$ C) of isothermal block in slot addressed
THMtype	2-wire ohms measurement of thermistor type = 2252 (2252 Ω thermistor) = 5K (5 k Ω thermistor) = 10K (10 k Ω thermistor)	Thermistor temp ($^{\circ}$ C) on ch in ch_list
THMFtype	4-wire ohms measurement of thermistor [1] type = Same type as THMtype	Thermistor temp ($^{\circ}$ C) on ch in ch_list
RTDtype	2-wire ohms measurement of RTD type = 85 (RTDs with a = 0.00385 Ω/Ω°) = 92 (RTDs with a = 0.003916 Ω/Ω°)	RTD temp ($^{\circ}$ C) on ch in ch_list
RTDFtype	4-wire ohms measurement of RTD [1] type = same as RTDtype	RTD temp ($^{\circ}$ C) on ch in ch_list
Strain [2]		
STRVEX	Bridge excitation voltage (\pm VS)	Bridge excitation voltage
STRUN	Bridge output which is ref for corresponding strain measurement	Bridge output voltage
STRQ	1/4 bridge strain	Strain or microstrain [3]
STRFB	Bending full bridge strain	Strain or microstrain [3]
STRHB	Bending half bridge strain	Strain or microstrain [3]
STRQTEN	Shunt verification (tension shunt) diagnostic (HP 44717A or 44718A only)	Strain or microstrain [3]
STRQCOMP	Shunt verification (compression shunt) diagnostic (HP 44717A or 44718A only)	Microstrain
STRHP	1/2 bridge Poisson strain	Strain or microstrain [3]
STRFBP	Bending full bridge Poisson strain	Strain or microstrain [3]
STRFP	Full bridge Poisson strain	Strain or microstrain [3]
Notes:		
[1] = For 4-wire ohms functions		
[2] = Refer to the CONFMEAS command in the HP 3852A Command Reference Manual for definitions.		
[3] = Depends on Gage factor (GF factor).		

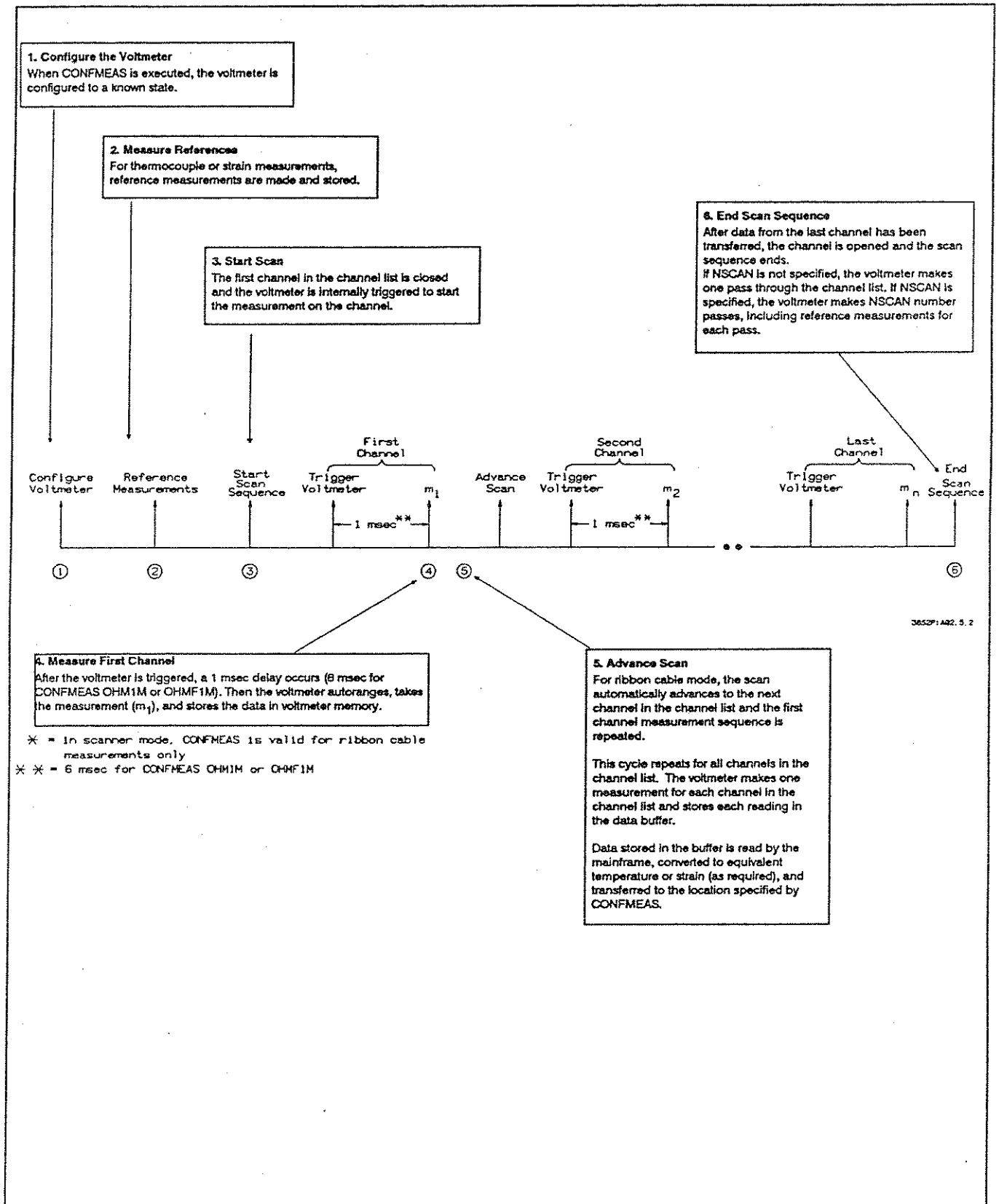

Figure 5-2. CONFMEAS Operation (Scanner Mode)

CONFMEAS Operation Figure 5-2 shows simplified voltmeter operation for CONFMEAS with Scanner Mode ribbon cable measurements. When CONFMEAS is executed the voltmeter is configured (1), any required thermocouple or strain references are measured (2), and the scan sequence is started (3).

When the scan sequence is started, the first channel in the channel list is closed and the voltmeter is triggered. After a 1 msec delay (6 msec if the CONFMEAS *function* is OHM1M or OHMF1M), a measurement (m_1) is made on the first channel in the channel list (4).

When the first channel is measured, the scan is automatically advanced to the second channel in the channel list (5), and a measurement is taken on the second channel. This sequence repeats for each channel in the channel list. When the last channel is measured, the channel is opened and the scan ends (6).

As measurements are taken, they are stored in the voltmeter data buffer and then transferred to the mainframe or to the output buffer and/or display by the MEAS phase of CONFMEAS. For ribbon cable operation, the voltmeter does not wait for readings to be transferred from the data buffer before advancing to the next channel.

If the CONFMEAS NSCAN parameter (valid only for firmware revision 2.2 and greater) is not specified, the scan sequence ends at (6). If NSCAN *number* is specified, the scan sequence is repeated *number* times. For example, with NSCAN 3 and 10 channels in the channel list, 30 measurements are taken.

To summarize, CONFMEAS sets the voltmeter for one reading per channel and limits measurement speed to about 1000 readings per second or less. For Scanner Mode operation, CONFMEAS can only be used for ribbon cable measurements. Also, unless the NSCAN *number* parameter is > 1, the voltmeter is limited to a single pass through the channel list.

CONFMEAS Programming Sequence Figure 5-3 shows the recommended command sequence to program the voltmeter for Scanner Mode measurements using CONFMEAS. In Figure 5-3, the solid line path indicates required commands while the dotted line shows optional commands. Thus, USE *ch*, SCANMODE ON, and CONFMEAS are required commands for Scanner Mode ribbon cable measurements with CONFMEAS, while RST *slot* and TEST *slot* are optional commands.

CONFMEAS Measurement Examples

Four example programs using CONFMEAS for Scanner Mode ribbon cable measurements follow. Table 5-3 shows the example titles. The first three examples use an HP 44711A/B 24-Channel High-Speed FET Multiplexer in slot 5 of the mainframe and an HP 44702A/B or HP 44704A voltmeter in slots 6 and 7 of the mainframe (programming slot 6). The fourth example uses an HP 44713A/B in slot 5 of the mainframe and an HP 44702A/B or HP 44704A in slots 6 and 7.

See Figure 3-3 for typical connections to the multiplexers. Connect the ribbon cable from the multiplexer to the voltmeter as shown in Figure 3-6. You should also refer to the appropriate multiplexer configuration and programming manual for additional details.

Table 5-3. CONFMEAS Measurement Examples

Title	Description
DC Voltage Measurements	Measure DC voltage on 10 channels of an HP 44711A/B multiplexer.
Resistance Measurements	Measure the resistance on an HP 44711A/B multiplexer channel using 4-wire ohms.
Temperature Measurements	Measure the temperature of a 10 k Ω thermistor on an HP 44711A/B channel.
Reference Temperature Measurements	Measure the reference temperature of an HP 44713A/B multiplexer

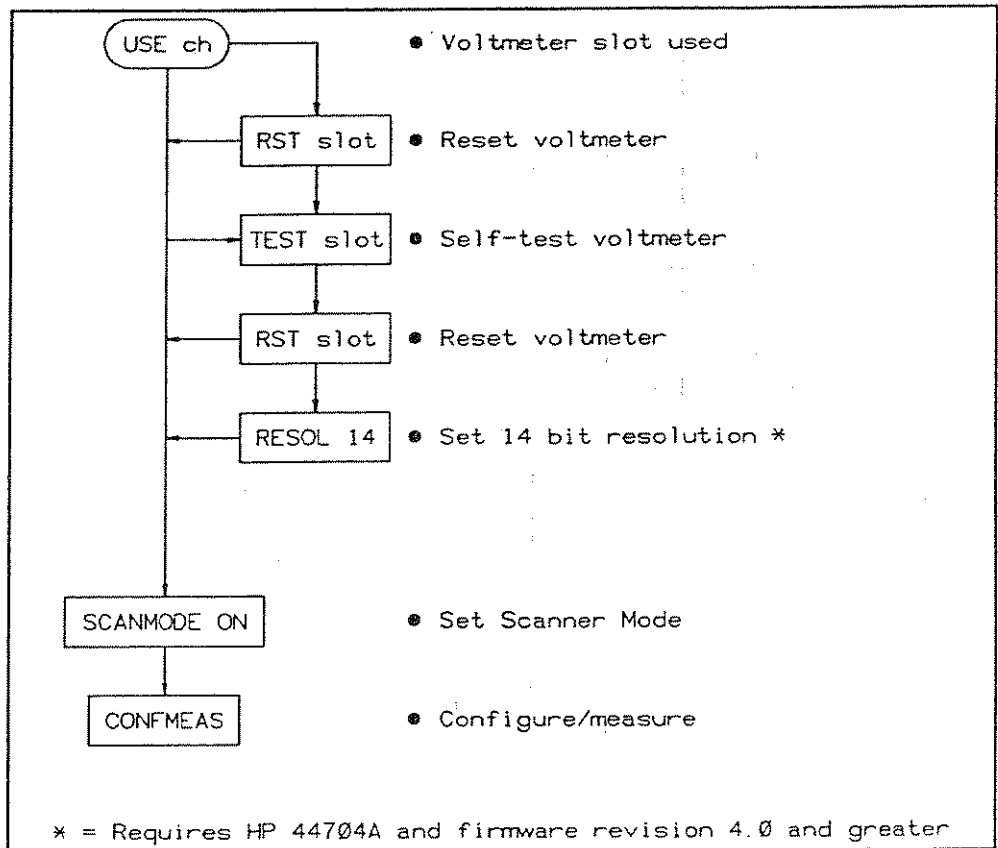

Figure 5-3. CONFMEAS Programming Sequence

Example: DC Voltage Measurements

This program uses CONFMEAS to measure DC voltages connected to channels 500 through 509 of an HP 44711A/B multiplexer. Since NSCAN number is not specified, the voltmeter makes a single pass through the channel list.

```
10 DIM Volts(0:9)                ! Dimension controller array
20 OUTPUT 709;"USE 600"          ! Use voltmeter in mainframe slot 6
30 OUTPUT 709;"SCANMODE ON"     ! Set Scanner Mode
40 OUTPUT 709;"CONFMEAS DCV,500-509" ! Conf/meas DC volts, ch 500-509
50 ENTER 709;Volts(*)           ! Enter 10 readings
60 PRINT USING "K,/";Volts(*)   ! Display 10 readings
70 END
```

For a set of 5V 5% sources, a typical return (values in volts) is:

4.9975, 5.0025, ... 4.9875

Example: Resistance Measurements

CONFMEAS can also be used for 2-wire or 4-wire ohms resistance measurements (refer to Table 5-2). This program measures resistance using 4-wire ohms on channel 500 of an HP 44711A/B multiplexer.

Note that only the Sense channel (channel 500) is specified in the CONFMEAS *ch_list* parameter, since CONFMEAS automatically assigns the correct channel (channel 512 in this case) as the Source channel. Also, note that CONFMEAS OHMF configures the voltmeter for 4-wire ohms measurements up to 100 k Ω (assumed for this program) and measurement results are returned in Ω .

```
10 OUTPUT 709;"USE 600"          ! Use voltmeter in mainframe slot 6
20 OUTPUT 709;"SCANMODE ON"     ! Set Scanner Mode
30 OUTPUT 709;"CONFMEAS OHMF,500" ! Conf/meas resistance on ch 500
40 ENTER 709;A                  ! Enter results
50 PRINT A                      ! Display results
60 END
```

A typical return for a 10 k Ω 5% resistor (value in Ω) is:

9993.75

Example: Temperature Measurements

CONFMEAS can be used for a wide variety of temperature measurements, including RTDs, thermistors, and thermocouples. This program uses CONFMEAS to measure the temperature of a 10 k Ω thermistor connected to channel 500 of an HP 44711A/B multiplexer.

```

10 OUTPUT 709;"USE 600"           ! Use voltmeter in mainframe slot 6
20 OUTPUT 709;"SCANMODE ON"       ! Set Scanner Mode
30 OUTPUT 709;"CONFMEAS THMF10K,500" ! Conf/meas Type 10K thermistor
40 ENTER 709;A                     ! Enter temperature
50 PRINT A                          ! Display temperature
60 END

```

For a 10 k Ω thermistor at room temperature, a typical return (value in $^{\circ}\text{C}$) is:

24.312

**Example: Reference
Temperature
Measurement**

As noted, the HP 3852A supports Type B, E, J, K, N14 [N (AWG 14)], N28 [N (AWG 28)], R, S, and T thermocouples. However, to measure other thermocouples, you will need to measure the reference temperature to use in your own linearization program. This program uses CONFMEAS to measure the reference temperature of an HP 44713A/B multiplexer in slot 5 of the mainframe.

```

10 OUTPUT 709;"USE 600"           ! Use voltmeter in mainframe slot 6
20 OUTPUT 709;"SCANMODE ON"       ! Set Scanner Mode
30 OUTPUT 709;"CONFMEAS REFT,500" ! Measure reference temperature
40 ENTER 709;A                     ! Enter reference temperature
50 PRINT A                          ! Display reference temperature
60 END

```

A typical return at room temperature (value in $^{\circ}\text{C}$) is:

24.312

Measurements Using CONF and MEAS

This section shows how to use CONF and MEAS along with some low-level commands for Scanner Mode ribbon cable measurements. The programming method in this section will be to use CONF and MEAS to set certain voltmeter parameters to a known state (preset values), modify the preset values as required with low-level commands, and use MEAS to read and transfer the results.

NOTE

1. Although using *CONF* and *MEAS* allows increased programming flexibility over using *CONFMEAS*, the *MEAS* command presets some voltmeter operating and triggering parameters and thus does not offer the full programming flexibility of using *CONF* and low level commands.
 2. Scanner Mode backplane measurements can be made with *MEAS* but are not recommended. Voltmeter operation and commands in this section assume Scanner Mode ribbon cable (*TERM RIBBON*) operation.
 3. Commands are not discussed in detail in this section. Refer to the *HP 3852A Command Reference Manual* and/or to the next section "Measurements Using *CONF* and Low-Level Commands" as required for command details.
-

Programming Overview

To program the voltmeter using *CONF* and *MEAS* along with low-level commands, first read "CONF and MEAS Overview" for an overview of voltmeter operation with *CONF* and *MEAS*, a discussion of *CONF* and *MEAS* preset values, and the low-level commands which apply to *CONF* and *MEAS* ribbon cable operation.

Next, refer to "Selecting Voltmeter Configuration" and/or to "Selecting Voltmeter Triggering" to select voltmeter configuration and triggering parameters required for your measurement. When you have selected required measurement parameters, program the voltmeter using the command sequence shown in Figure 5-4.

NOTE

For CONF and MEAS Scanner Mode ribbon cable operation, USE, SCANMODE, CONF, and MEAS are the only commands required to program the voltmeter. The other commands are optional and can be used as needed. Also, commands are not always presented in the order shown in Figure 5-4. When using CONF and MEAS, always program the voltmeter in the sequence shown in Figure 5-4.

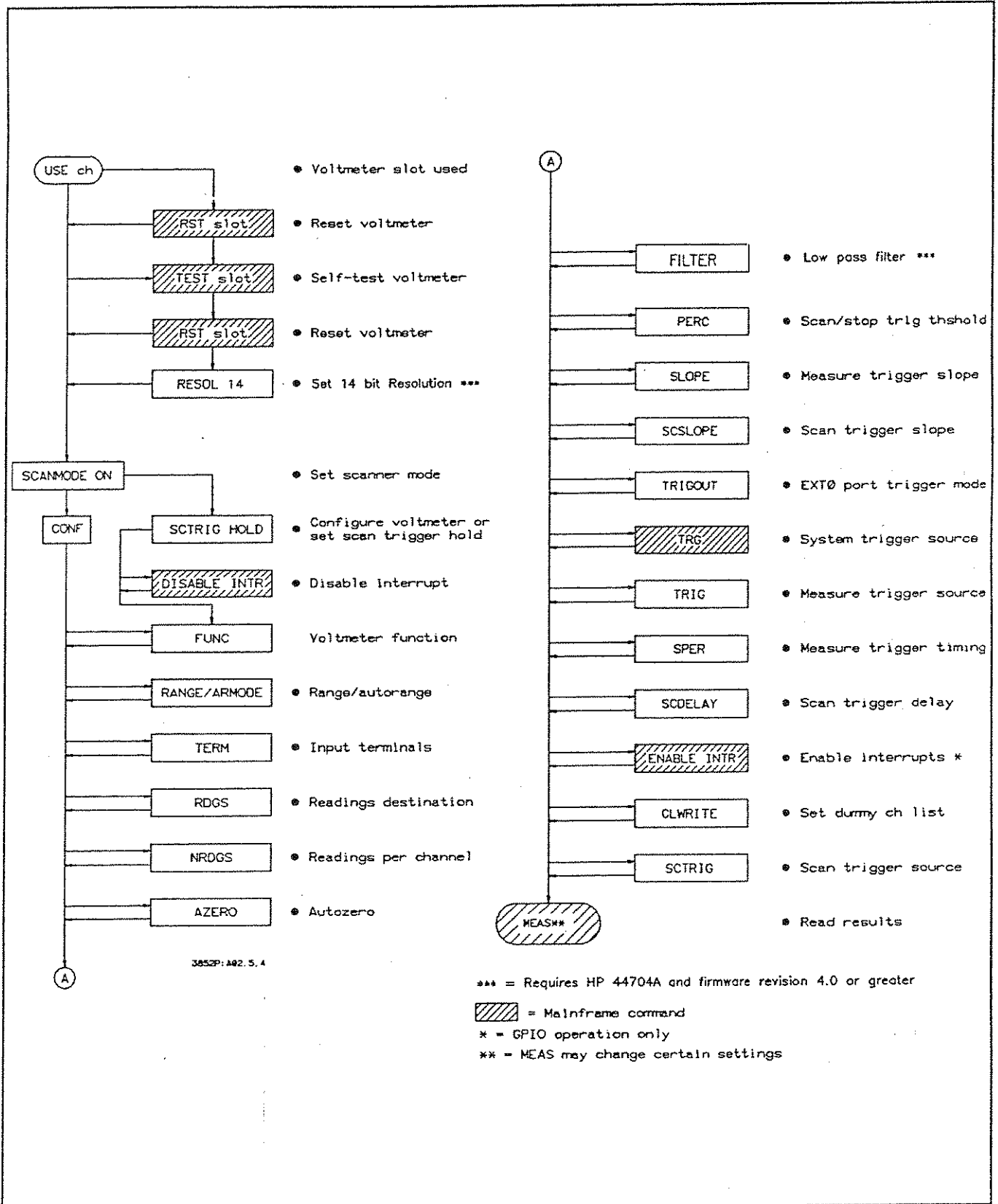

Figure 5-4. CONF and MEAS Programming Sequence

Example: Getting Started

Suppose the CONF and MEAS preset values shown in “CONF and MEAS Commands” (Tables 5-4 and 5-5) are acceptable for your measurement except for the number of readings per channel (set with the NRDGS command) and the scan trigger source (set with the SCTRIG command).

In this case, refer to “Selecting Voltmeter Configuration” to select the NRDGS parameter and to “Selecting Voltmeter Triggering” to select the SCTRIG parameter. Then, program the voltmeter using the command sequence in Figure 5-4.

CONF and MEAS Overview

This section summarizes voltmeter operation for Scanner Mode ribbon cable measurements when CONF and MEAS are used; lists Scanner Mode low-level commands which apply when CONF and MEAS are used; and lists preset values for CONF and MEAS.

CONF and MEAS Operation

Figure 5-5 shows voltmeter operation when CONF and MEAS are used for Scanner Mode ribbon cable measurements and summarizes applicable commands by function. A summary of voltmeter operation and related commands follows. Refer to “Low-Level Commands” for a list of the commands.

Configure Voltmeter

CONF configures certain voltmeter parameters to a known state and MEAS ensures that the voltmeter is properly set for the specified measurement (1). For strain or temperature measurements, the voltmeter automatically takes and stores the reference measurements (2).

Start Scan Sequence

For Scanner Mode operation, a “scan sequence” consists of all voltmeter actions from the time the scan trigger starts the sequence (3) until the last channel has been measured and the sequence ends (6).

For measurements with MEAS, two types of triggers affect the voltmeter operation: the scan trigger and the measure trigger. The scan trigger starts the scan sequence, but does not trigger the voltmeter to take measurements. After the scan trigger is received, each measurement is initiated by a separate measure trigger (m_i).

The scan sequence started by a scan trigger from the source set by the SCTRIG command (3). For SCTRIG MEAS, EXT0, EXT1, or GPIO, the SCSLOPE command sets the input edge (LH or HL) which will generate the scan trigger. For SCTRIG MEAS only, PERC sets the input threshold which will generate a scan trigger.

Voltmeter Configuration

Known State

- USE sets voltmeter slot to be used.
- SCANMODE ON sets Scanner Mode operation.
- CONF configure's the voltmeter.
- MEAS makes measurements and transfers data.

Operating Parameters

- FUNC sets measurement function.
- RANGE sets voltmeter range.
- ARMODE sets autorange mode.
- TERM sets input terminals.
- RDGS sets readings destination.
- NRDGS sets number of readings per channel.
- AZERO autozeroes the voltmeter.
- CLWRITE sets channel and range list.

Voltmeter Triggering

Scan Trigger

- SCTRIG sets scan trigger source.
- SCSLOPE sets scan trigger edge.
- PERC sets scan trigger input threshold
- SCDELAY trig_delay sets time to first measure trigger.

Measure Trigger

- TRIG sets measure trigger source.
- TRGOUT sets scan trigger input threshold
- SLOPE sets measure trigger edge.
- SPER sets time between measure triggers.
- TRGOUT sets EXTO port trigger output mode.

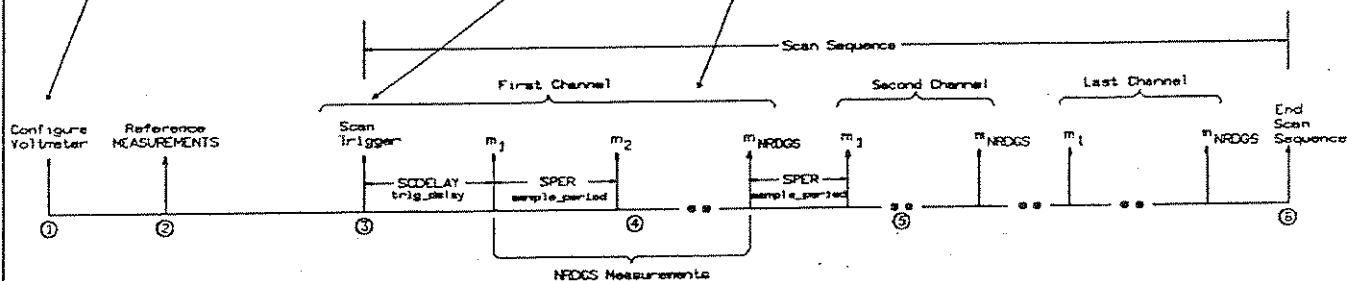

Figure 5-5. CONF and MEAS Operation (Ribbon Cable)

Measure First Channel

Following the scan trigger, a delay set by the *SCDELAY trig_delay* parameter occurs before the first measure trigger is enabled. If TRIG INT (internal measure trigger) is set, the first measurement (m_1) is then made. The voltmeter takes NRDGS readings on the first channel (4) as set by the *NRDGS number* parameter. If TRIG INT is set, the time between the start of each measurement (m_1 to m_2 , etc.) is set by *SPER sample_period*.

Each measurement is initiated by a measure trigger from the source set by the TRIG command. For TRIG EXT0, EXT1, or GPIO, the SLOPE command sets the input edge (LH or HL) which generates the measure trigger. TRIGOUT sets whether the EXT0 port can generate or receive triggers. As each measurement is taken, data is stored in the voltmeter data buffer. Stored readings are transferred to the destination specified by MEAS.

Measure Second Through Last Channels

After the first channel readings have been made, the scan is automatically advanced to the second channel and NRDGS measurements are taken on the second channel (5). The scan advances through each of the channels in the channel list and the second channel measurement sequence is repeated for each remaining channel. When the data from the last channel has been read, the last channel is opened and the scan pass ends (6).

End Scan Sequence

If MEAS [*NSCAN number*] is not specified, the voltmeter executes one scan sequence and the measurement sequence ends. Otherwise, the voltmeter executes the number of scan sequences set by *NSCAN number* (1 to 65,535). (The MEAS NSCAN parameter is valid only for mainframe firmware revision 2.2 and greater.)

For example, with NSCAN 3, ten channels in the scan list, and ten readings per channel the voltmeter makes 300 measurements. Note that a separate scan trigger is required to start each scan sequence.

CONF and MEAS Commands Since the CONF and MEAS commands form the starting point for measurements in this section, CONF and MEAS preset values follow.

The CONF Command

Table 5-4 shows the command parameters set by the CONF command (called preset values) for Scanner Mode operation. That is, executing the CONF command is equivalent to setting the command parameters in Table 5-4 in the order shown. Note that SCANMODE ON must be set prior to the CONF command to obtain the settings in Table 5-4.

Some commands in Table 5-4 (such as SADV and STRIG) do not apply to Scanner Mode ribbon cable operation when MEAS is used. In addition, other commands, such as PRESCAN and POSTSCAN are set to a specific value by the MEAS command. Thus, the commands discussed in this section are those listed in "Low-Level Commands" (refer to Table 5-6).

Table 5-4. CONF Scanner Mode Preset Values

Command/Parameter	Definition
SADV SCAN	Advance scan when readings are available. [1]
STRIG SCAN	Start scan immediately. [1]
SCTRIG HOLD	Scan trigger is disabled. [2]
TRIG INT	Internal measure trigger source.
STTRIG INT	Internal stop trigger source.
FUNC DCV or OHMxx	As appropriate for CONF function parameter.
RANGE AUTO	Autorange mode. [3]
TERM RIBBON	Ribbon cable is the input source.
NRDGS 1	One reading per channel.
RDGS SYS	Readings are returned to the mainframe.
RDGSMODE DAV	Reading is available when any reading stored.
ARMODE AFTER	Autorange after measure trigger is received.
ASCAN OFF	Autoscan off.
SCDELAY .001, .001	1 msec scan trig_delay, 1 msec scan_pace. [4]
SPER .001	1 msec between measurement triggers,
PRESCAN 1	1 prescan before stop trigger accepted.
POSTSCAN 0	0 postscans after stop trigger accepted.
AZERO ONCE	Autozero once.
Notes:	
[1] = Does not apply to ribbon cable operation when MEAS is used.	
[2] = If TERM RIBBON is set, MEAS changes SCTRIG HOLD to SCTRIG INT, if TERM INT or TERM EXT is set, MEAS changes SCTRIG HOLD to SCTRIG SCAN.	
[3] = For CONF TEMPxx, mainframe firmware revisions before revision 2.2 set the 320 mV range for xx = E, J, K, and N14 LN(AWG 14)] and set the 40 mV range for xx = B, R, S, T, and N28 [N(AWG)].	
[4] = CONF OHM1M and CONF OHMF1M set 6 msec trig-delay and 6 msec scan-pace.	

The MEAS Command

MEAS *function ch_list* [NSCAN *number*] [USE *ch*] [INTO *name*] or [*fmt*] sets the measurement function appropriate for the *function* parameter, initiates a scan and measurement of the multiplexer channels specified by *ch_list*, and executes the number of scan sequences set by the NSCAN *number* parameter (see Figure 5-5).

When measurements have been taken, MEAS automatically transfers the readings to the mainframe memory (when INTO *name* is used) or to the output buffer and/or display (when INTO *name* is not used). For temperature or strain measurements, MEAS also causes associated conversions to be performed on the results.

NOTE

MEAS can also be used for GPIO operation (RDGS GPIO), but no conversion is done for strain or temperature measurements. Refer to Chapter 7 - GPIO operation for details on GPIO operation.

For thermocouple and strain measurements, all reference measurements are first made (automatically) and then all channel measurements are made. A reference measurement is made each time a slot is crossed in the channel list. For example, MEAS TEMPJ,100-223 makes two reference measurements: one for slot 100 and the second for slot 200. However, MEAS TEMPJ, 100,200, 101,201 makes four reference measurements: slot 100, slot 200, slot 100 again, and slot 200 again.

MEAS disables all voltmeter interrupts on the voltmeter unless RDGS GPIO (readings destination is the GPIO port) is set. If MEAS detects that the voltmeter function set is not compatible with the MEAS *function* specified, the voltmeter is reconfigured and autorange is set. In addition, for Scanner Mode operation, MEAS checks and changes (as necessary) the commands in Table 5-5.

Since the STTRIG, PRESCAN, POSTSCAN, DISABLE INTR, ASCAN, and RDGSMODE commands are set by MEAS, they will not be discussed in this section. Refer to the next section "Measurements Using CONF and Low-Level Commands" for details on these commands.

NOTE

If an HP-IB device clear or CLEAR key is received during MEAS execution, the voltmeter may be left in an undefined programmed state, since MEAS temporarily reprograms several features which cannot be restored after a clear.

Table 5-5. Scanner Mode Commands Changed by MEAS

Command	Setting
FUNC	Changed to function set by MEAS function.
TERM	TERM ZERO changed to TERM INT.
SCTRIG	SCTRIG HOLD or SCTRIG SCAN is changed to SCTRIG INT if TERM RIBBON is set. [2]
TRIG	TRIG HOLD is changed to TRIG INT.
STTRIG	STTRIG INT is set.
PRESCAN	PRESCAN 1 is set.
POSTSCAN	POSTSCAN 0 is set.
DISABLE INTR	DISABLE INTR is set if RDGS SYS is set.
ASCAN	ASCAN OFF is set.
RDGSMODE	RDGSMODE BURST is changed to RDGSMODE DAV and RDGSMODE COMPLETE is changed to RDGSMODE END during MEAS and restored after MEAS is executed.
Notes:	
[1] = Service-related command. Refer to the HP 3852A Assembly Level Service Manual.	
[2] = SCTRIG HOLD or SCTRIG INT is changed to SCTRIG SCAN if TERM INT or TERM EXT is set.	

Low-Level Commands Table 5-6 is an alphabetical list of Scanner Mode low-level commands which apply when CONF and MEAS are used. If a command (such as FUNC) has two parameters, the command is listed twice, once for each parameter. Refer to the HP 3852A Command Reference Manual and/or to "Scanner Mode Command Summary" at the end of this chapter for details on the commands.

Table 5-6. Scanner Mode Low-Level Commands - Using MEAS

Command	Description	Power-On	Default	Note
ARMODE mode	Autorange mode	AFTER	--	
AZERO [mode]	Autozero mode	ONCE	ONCE	
CAL	Service cmd	--	--	[1]
FUNC function	Meas function	DCV	--	
FUNC [range]	Meas range	AUTO	AUTO	
NRDGS number	Rdgs/channel	1	--	
PERC threshold	Trigger threshold	0%	--	
RANGE [range]	Voltmeter range	AUTO	AUTO	
RDGS dest	Readings dest	SYS	--	
SCANMODE [mode]	Operating mode	OFF	ON	
SCDELAY trig-delay	Scan trigger delay	0 sec	--	
SCSLOPE mode	Scan trigger slope	LH	--	[2]
SCTRIG [source]	Scan trigger source	HOLD	HOLD	
SLOPE mode	Meas trigger slope	LH	--	[3]
SPER sample-period	Meas trigger timing	10 μ sec	--	
TERM terminal	Input terminals	EXT	--	
TRIG [source]	Meas trigger source	INT	SGL	
TRIGOUT [mode]	EXT0 mode	OFF	ON	
USE ch	Slot or chan used	Low valid ch/slot	--	[4]

Notes:
 [1] = Refer to HP 3852A Assembly Level Service Manual.
 [2] = Used only when SCTRIG EXT0, EXT1, MEAS, or GPIO is set.
 [3] = Used only when TRIG EXT0, EXT1, or GPIO is set.
 [4] = Low valid ch/slot (may or may not be the voltmeter slot).

Selecting Voltmeter Configuration

Table 5-7 shows suggested actions and related commands to select voltmeter configuration parameters for Scanner Mode ribbon cable measurements when MEAS is used. If required, also refer to "Selecting Voltmeter Triggering" to select voltmeter triggering parameters needed.

Table 5-7. Voltmeter Configuration Parameters

Action	Commands	Definition
Set Known State	USE ch SCANMODE ON CONF MEAS	Voltmeter slot used Set Scanner Mode Configure voltmeter
Set Function/Range	FUNC RANGE TERM ARMODE AZERO	Voltmeter function Voltmeter range Input terminals Autorange mode Autozero
Set Readings	RDGS NRDGS CLWRITE	Readings destination Readings per channel Channel/range lists

Setting Known State To begin programming the voltmeter for Scanner Mode measurements with CONF and MEAS, set the voltmeter slot used with USE *ch* and set Scanner Mode with SCANMODE ON. Then, use CONF to preset the voltmeter to the state shown in Table 5-4. Also, refer to Table 5-5 for the MEAS preset values since the voltmeter will be set to this state when MEAS is executed.

Setting Function/Range Voltmeter function/range parameters which can be selected for Scanner Mode CONF and MEAS ribbon cable operation include FUNC, RANGE, TERM, ARMODE, and AZERO.

Voltmeter Function (FUNC)

Use FUNC *function* [*range*] [USE *ch*] to set the voltmeter to a specified function and range. FUNC *function* can be set for DCV, OHMF10K, OHMF100K, or OHMF1M only. Refer to the HP 3852A Command Reference Manual for FUNC [*range*] values.

Use FUNC [*range*] [USE *ch*] to set a measurement range or to set autorange (CONF sets autorange). Use the word AUTO or the value 0 for the FUNC [*range*] parameter to set autorange. To specify a fixed range, you specify the maximum expected voltage amplitude or maximum expected resistance on any channel in the channel list. The voltmeter then selects the correct range.

Note that any value within the range specified sets the voltmeter to that range. For example, with FUNC DCV, any [*range*] value >2.56 and ≤ 10.24 sets the voltmeter to the 10.24V DC voltage range.

Voltmeter Range (RANGE)

Use RANGE [*range*] [USE *ch*] to set a measurement range or to set autorange (CONF sets autorange). Use the word AUTO or the value 0 for the RANGE [*range*] parameter to set autorange. To specify a fixed range, you specify the maximum expected voltage amplitude or maximum expected resistance on any channel in the channel list. The voltmeter then selects the correct range.

The RANGE [*range*] values are the same as the FUNC [*range*] values. Note that any value within the range specified sets the voltmeter to that range. For example, if DC voltage measurements are set (with CONF or FUNC), any [*range*] value >2.56 and ≤ 10.24 sets the voltmeter to the 10.24V DC voltage range.

Input Terminals (TERM)

Use TERM *terminal* [USE *ch*] to set the voltmeter input terminals. For Scanner Mode ribbon cable measurements use TERM RIBBON (as set by CONF).

Autorange Mode (ARMODE)

When a fixed range is not used, the voltmeter uses the autorange mode. When autorange is enabled, *ARMODE mode* [USE *ch*] sets the voltmeter autorange mode. *ARMODE BEFORE* samples the input when the measure trigger is received. *ARMODE AFTER* samples the input 10 μ sec after the measure trigger is received.

ARMODE AFTER (as set by *CONF*) is typically used with *MEAS* operation. If your measurement application requires *ARMODE BEFORE*, refer to the next section "Measurements Using *CONF* and Low-Level Commands" for details on *ARMODE*.

Autozero (AZERO)

When *CONF* is executed, the voltmeter makes a single autozero measurement. However, as required, you can also use *AZERO ONCE* to autozero the voltmeter. When *AZERO ONCE* is executed, the voltmeter nulls out its internal circuitry offset. Thus, executing *AZERO ONCE* does not generate a time penalty during the scan.

Setting Readings Voltmeter commands which can be set to specify the voltmeter measurement readings method for *CONF* and *MEAS* ribbon cable operation include *RDGS*, *NRDGS*, and *CLWRITE*.

Readings Destination (RDGS)

The destination for readings stored in the voltmeter data buffer is set with *RDGS dest* [USE *ch*]. *RDGS SYS* sets the mainframe as the destination, while *RDGS GPIO* sets the GPIO port. Power-on and default mode and mode set by *CONF* is *RDGS SYS*.

For *MEAS* operation and *RDGS SYS*, measurement data is sent to mainframe memory or to the output buffer and/or display as specified by the *MEAS* command. All examples in this chapter assume *RDGS SYS*. Refer to Chapter 7 - GPIO Operation for details on *RDGS GPIO*.

Number of Readings (NRDGS)

Use *NRDGS number* [USE *ch*] to set the number of readings per channel, where the number range is 1 to 65,535. For ribbon cable operation, [*NRDGS number*] times [number of channels - 1] must be <4,095 (for *NRDGS number* > 1). With *NRDGS number* = 1, the maximum number of readings = 65,535. Or, for example, with 10 channels in the channel list, the maximum number of readings/channel = $4,094 / (10 - 1) = 454$ readings/channel.

NOTE

1. For the HP 44702A voltmeter, NRDGS should be $\leq 8,192$ or the scan sequence may abort if the voltmeter data buffer fills.
 2. For ribbon cable operation when MEAS is used [NRDGS number] times [number of channels] times [NSCAN number] must be $\leq 67,108,863$ readings. (The NSCAN parameter applies only to mainframe firmware revision 2.2 and greater.)
-

Channel/Range Lists (CLWRITE)

For CONF and MEAS operation the MEAS command specifies the channel list to be measured and sets the scan trigger to SCTRIG INT (Table 5-5). Thus, if you want the scan trigger source to be other than SCTRIG INT, you must set up a “dummy” channel list before the SCTRIG command can be executed.

One way to set up the dummy channel list is to use CLWRITE. For Scanner Mode ribbon cable operation, CLWRITE [ribbon_bus] ch_list [RANGE range_list] [USE ch] sets a channel list and an associated range list. Refer to the HP 3852A Command Reference Manual for details on CLWRITE.

As noted, for CONF and MEAS ribbon cable operation, CONF sets the scan trigger to hold (SCTRIG HOLD) while MEAS changes SCTRIG HOLD to SCTRIG INT (internal trigger). To specify a scan trigger source other than SCTRIG INT, you must first use the CLWRITE command to set up a dummy channel list.

Then, when MEAS is executed, the actual channel list to be measured is set by the MEAS command. Refer to “Example: Setting Voltmeter Triggering” for an example program using CLWRITE.

Example: Setting Voltmeter Configuration

This example measures DC voltage on channels 500 through 502 and assumes that the CONF preset values (Table 5-4) are acceptable except for number of readings and range. This program uses the NRDGS and RANGE commands to modify the CONF settings for these parameters.

In the program, NRDGS 3 sets the number of readings per channel to 3 and RANGE 9 sets the 10.24V range. (Maximum expected amplitude is 9 volts on all channels.) MEAS NSCAN 2 is used to make two scan passes, so 18 readings are taken.

10 DIM Volts(0:17)	<i>! Dimension controller array</i>
20 OUTPUT 709;"USE 600"	<i>! Use voltmeter in MF slot 6</i>
30 OUTPUT 709;"SCANMODE ON"	<i>! Set Scanner Mode</i>
40 OUTPUT 709;"CONF DCV"	<i>! Set DC volts</i>
50 OUTPUT 709;"RANGE 9"	<i>! Set 10.24V range</i>
60 OUTPUT 709;"NRDGS 3"	<i>! Set 3 readings/channel</i>
70 OUTPUT 709;"MEAS DCV,500-502,NSCAN 2"	<i>! Meas ch 500-502, make 2 scans</i>
80 ENTER 709;Volts(*)	<i>! Enter 18 readings</i>
90 PRINT USING "K,/";Volts(*)	<i>! Display 18 readings</i>
100 END	

For a set of 9V 5% sources, a typical return (values in volts) is:

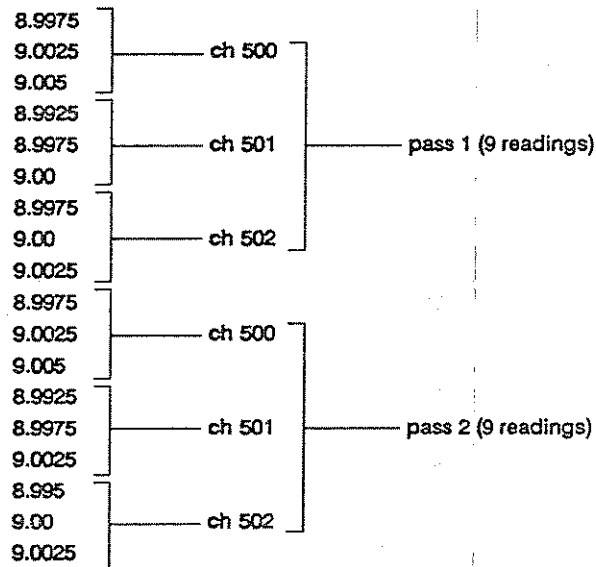

Selecting Voltmeter Triggering

As noted, when MEAS is used you can select parameters for the scan trigger and measure triggers. Table 5-8 shows voltmeter scan and measure trigger parameters which can be selected for MEAS operation.

Table 5-8. Voltmeter Triggering Parameters

Action	Commands	Definition
Set Scan Trigger	SCTRIG SCSLOPE PERC SCDELAY	Scan trigger source Scan trigger slope Scan trigger threshold Scan trigger delay
Set Measure Trigger	TRIG SLOPE SPER TRIGOUT	Measure trigger source Measure trigger slope Measure trigger timing EXT0 port trigger mode

Setting Scan Trigger Guidelines follow to select scan trigger parameters when MEAS is used, including the scan trigger source (SCTRIG), scan trigger slope (SCSLOPE), scan trigger threshold (PERC), and scan trigger delay (SCDELAY).

Scan Trigger Source (SCTRIG)

As shown in Figure 5-5, the scan sequence is started when a scan trigger from the source set by SCTRIG is received. For SCTRIG MEAS, EXT0, EXT1, or GPIO, the SCSLOPE command sets the edge (LH or HL) of the input which will generate the scan trigger. For SCTRIG MEAS, the PERC command sets the input level (threshold) which will generate a scan trigger when the input crosses the threshold in the direction set by SCSLOPE.

Table 5-9 summarizes SCTRIG *sources* for ribbon cable operation when MEAS is used. Although there are nine SCTRIG *sources*, SCTRIG SCAN is not normally used for ribbon cable operation. Also, when MEAS is used, SCTRIG SGL or SCTRIG HOLD are not compatible for ribbon cable operation since MEAS changes SCTRIG SGL or SCTRIG HOLD to SCTRIG INT. Refer to the HP 3852A Mainframe Configuration and Programming Manual for details on the TRG command.

NOTE

For Scanner Mode ribbon cable operation with CONF and MEAS, the CONF command sets SCTRIG HOLD while MEAS changes SCTRIG HOLD (or SCTRIG SCAN) to SCTRIG INT. To set SCTRIG to a source other than INT when MEAS is used, a "dummy" channel list must be set-up with the CLWRITE command. Refer to "Example: Setting Voltmeter Triggering" for an example program.

Table 5-9. Scan Trigger (SCTRIG) Sources - Using MEAS

Source/mode	Description
SYS	System trigger (used with TRG command)
INT	Voltmeter generates internal scan trigger
MEAS	Generate scan trigger on input threshold
EXT0	Input to EXT0 port generates scan trigger
EXT1	Input to EXT1 port generates scan trigger
GPIO	Input to GPIO port generates scan trigger

Scan Trigger Slope (SCSLOPE)

For SCTRIG MEAS, EXT0, EXT1, or GPIO, the SCSLOPE *mode* [USE *ch*] command sets the direction (edge) of the input (LH or HL) which will generate the scan trigger. SCSLOPE LH sets low-to-high transitions (positive slope) while SCSLOPE HL sets high-to-low (negative slope) transitions. The power-on *mode* = LH. Note that CONF does not change the previous setting of SCSLOPE.

Scan Trigger Threshold (PERC)

For SCTRIG MEAS, a scan trigger is generated when the input signal reaches the percent of full-scale voltage set by PERC in the direction set by SCSLOPE. When autoranging is not used, the range of PERC is -128% to +127% of the full-scale range (as set with RANGE or FUNC). Power-on PERC *threshold* value is 0% of full-scale range.

For example, with SCTRIG MEAS and the voltmeter set for DC volts on the 10.24V range (by RANGE 9 for example), PERC 67 sets $(10.24 \text{ v}) * (0.67) = 6.86$ volts as the input signal level which will generate a scan trigger. SCSLOPE LH sets low-to-high transitions (positive slope) while SCSLOPE HL sets high-to-low transitions (negative slope).

NOTE

If autoranging is used, the absolute trigger threshold value will change, based on the current range. Although the same percentage is used, since the full scale value is different for each range, a different absolute value results. Refer to "Measurements Using CONF and Low-Level Commands" for details.

Scan Trigger Delay (SCDELAY)

As shown in Figure 5-5, a delay time set by the SCDELAY *trig_delay* parameter occurs between the scan trigger and the first measure trigger on the first channel in the channel list. The SCDELAY *trig_delay* range is 0 to 0.01638375 sec with 0.25 μ sec resolution. At power-on, SCTRIG *trig_delay* = 0 sec. CONF sets 0.001 sec SCDELAY *trig_delay* (0.006 sec for OHM1M and OHMF1M).

Measure triggers which occur during the SCDELAY *trig_delay* period are ignored. The first reading is taken by the first measure trigger after the SCDELAY *trig_delay* time expires. For MEAS operation (with MEAS NSCAN *number* > 1), a scan trigger is required to start each scan sequence. Also, note that only one scan trigger occurs during each scan sequence.

Setting Measure Trigger Guidelines follow to set voltmeter measure trigger parameters for CONF and MEAS ribbon cable operation, including measure trigger sources (TRIG), measure trigger slope (SLOPE), measure trigger timing (SPER), and EXT0 port triggering (TRIGOUT).

As shown in Figure 5-5, each measurement is initiated with a measure trigger (*mt*). For NRDGS 1, the voltmeter makes one reading per channel in the channel list. For NRDGS > 1, the voltmeter makes NRDGS readings for each channel in the scan list. If TRIG INT (internal measure trigger) is set, SPER *sample_period* sets the time between measurements.

Measure Trigger Source (TRIG)

TRIG [*source*] [USE *ch*] sets the source or mode for the measure trigger. Power-on *source* is INT (internal trigger) and default *source* is SGL (single trigger). For Scanner Mode ribbon cable operation, CONF sets TRIG INT.

Although there are nine TRIG *source* parameters, TRIG MEAS is not valid for Scanner Mode and TRIG SCAN is not normally used for ribbon cable measurements. Also, when MEAS is used TRIG SGL, TRIG SCAN, and TRIG HOLD are not compatible for ribbon cable measurements since MEAS changes TRIG SGL, TRIG SCAN, and TRIG HOLD to TRIG INT. Table 5-10 summarizes TRIG *sources* for ribbon cable operation when MEAS is used. Refer to the HP 3852A Mainframe Configuration and Programming Manual for details on the TRG command.

Table 5-10. Measure Trigger (TRIG) Sources - Using MEAS

Source/mode	Description
SYS	System trigger (used with TRG command)
INT	Voltmeter generates internal measure triggers
EXT0	Input to EXT0 port generates measure triggers
EXT1	Input to EXT1 port generates measure triggers
GPIO	Input to GPIO port generates measure triggers

Measure Trigger Slope (SLOPE)

For TRIG EXT0, TRIG EXT1, or TRIG GPIO, the SLOPE *mode* [USE *ch*] command sets the edge (direction) of the input (LH or HL) which will generate the measure trigger. SLOPE LH sets low-to-high transitions (positive slope) while SLOPE HL sets high-to-low (negative slope) transitions. The power-on *mode* = LH. Note that the CONF command does not change the previous SLOPE setting.

Measure Trigger Timing (SPER)

As shown in Figure 5-5, when TRIG INT (internal trigger) is set the SPER *sample_period* [USE *ch*] command sets the time in seconds between the start of successive measure triggers (mt_1 to mt_2 , etc.). The SPER *sample_period* range is 0 to 1073.74182375 sec with 0.25 μ sec resolution. SPER *sample_period* settings from 0 to 10 μ sec are rounded to 10 μ sec. At power-on, SPER *sample_period* = 10 μ sec.

EXT0 Port Triggering (TRIGOUT)

The TRIGOUT [*mode*] [USE *ch*] command specifies whether or not the EXT0 port on the voltmeter rear panel will function as a measure trigger source. When enabled (TRIGOUT ON) the EXT0 port outputs a trigger signal that can be used to trigger other HP 44702A/B or HP 44704A voltmeters. When disabled (TRIGOUT OFF) the EXT0 port is set to receive trigger signals.

NOTE

When TRIGOUT ON is set, no trigger source (TRIG, SCTRIG, or STTRIG) can be set to EXT0.

Example: Setting Voltmeter Triggering

This program generates a scan trigger to start the scan pass when the input to channel 501 crosses 3.072 V in the negative (high-to-low) direction. No delay occurs from the scan trigger to the first measure trigger and each of the ten measurements is separated by 0.1 sec.

Since RANGE 9 sets the 10.24V range, PERC 30 and SCSLOPE HL set the voltmeter to generate a scan trigger when the input crosses 3.072 V ($10.24 \text{ V} \times .30 = 3.072 \text{ V}$) in the negative direction. SCDELAY 0 sets a 0 sec delay from the scan trigger to the first measure trigger on channel 501 and SPER . 1 sets 0.1 second between each measurement.

Note that CLWRITE 500 is used to set a "dummy" channel number so that SCTRIG MEAS can be set. This "dummy" channel is replaced by actual channel 501 when MEAS is executed.

10 DIM Volts(0:9)	<i>! Dimension controller array</i>
20 OUTPUT 709;"USE 600"	<i>! Use voltmeter in mainframe slot 6</i>
30 OUTPUT 709;"SCANMODE ON"	<i>! Set Scanner Mode</i>
40 OUTPUT 709;"CONF DCV"	<i>! Set DC volts</i>
50 OUTPUT 709;"RANGE 9"	<i>! Set 10.24V range</i>
60 OUTPUT 709;"NRDGS 10"	<i>! Set 10 readings/channel</i>
70 OUTPUT 709;"PERC 30"	<i>! Set 3.072 V as threshold</i>
80 OUTPUT 709;"SCSLOPE HL"	<i>! Trigger on negative slope</i>
90 OUTPUT 709;"SPER .1"	<i>! Set .1 sec between meas triggers</i>
100 OUTPUT 709;"SCDELAY 0"	<i>! Set 0 sec scan trigger delay</i>
110 OUTPUT 709;"CLWRITE 500"	<i>! Set dummy ch 500 as scan list</i>
120 OUTPUT 709;"SCTRIG MEAS"	<i>! Scan trigger on threshold</i>
130 OUTPUT 709;"MEAS DCV,501"	<i>! Measure channel 501</i>
140 ENTER 709;Volts(*)	<i>! Enter 10 readings</i>
150 PRINT USING "K,/,Volts(*)"	<i>! Display 10 readings</i>
160 END	

For a decreasing ramp-type input to channel 501, a typical return (values in volts) is:

3.0725, 3.005, ... 0.0725

Measurements Using CONF and Low-Level Commands

This section shows how to use CONF and low-level commands for Scanner Mode ribbon cable measurements. The programming method will be to use CONF to set certain voltmeter parameters to a known state (preset values), modify the preset values as required with low-level commands, and use CHREAD or XRDGS to read and transfer the results. Using CONF and MEAS provides maximum programming flexibility and allows the voltmeter to be programmed for high-speed measurements.

NOTE

1. *Scanner Mode backplane measurements can be made but are not recommended. Voltmeter operation and commands in this section assume Scanner Mode ribbon cable (TERM RIBBON) operation.*
 2. *Commands and examples in this section assume HP-IB operation (RDGS SYS). Therefore, maximum data transfer speed is 90,000 readings/second to the mainframe memory or about 35,000 readings/second to an HP series 200/300 controller. GPIO operation (RDGS GPIO) is required for data transfer at 100,000 readings/second. Refer to Chapter 7 - GPIO Operation for details on GPIO.*
-

Programming Overview

To program the voltmeter using CONF and low-level commands, first read "Scanner Mode Overview" for an overview of voltmeter architecture, Scanner Mode ribbon cable operation, CONF command preset values, and Scanner Mode low-level commands.

Then, refer to "Selecting Voltmeter Configuration", "Selecting Voltmeter Triggering" and/or to "Selecting Data Transfers/Interrupts" to select the specific parameters required for your measurement. When you have selected required parameters, program the voltmeter using the command sequence shown in Figure 5-6.

NOTE

For Scanner Mode ribbon cable operation using CONF, only the USE, SCANMODE ON, CONF, SCTRIG, and CHREAD or XRDGS commands are required to program the voltmeter. The other commands are optional and can be used as needed. Also, commands are not necessarily presented in the order shown in Figure 5-6. When using CONF and low-level commands, always program the voltmeter in the sequence shown in Figure 5-6.

Example: Getting Started

For example, suppose the CONF preset values are acceptable for your measurement except for the number of readings per channel (set with the NRDGS command), the scan trigger source (set with the SCTRIG command), and the reading storage mode (set with the RDGSMODE command).

In this case, refer to "Selecting Voltmeter Configuration" to select the NRDGS parameter; to "Selecting Voltmeter Triggering" to select the SCTRIG parameter; and to "Selecting Data Transfers/Interrupts" to select the RDGSMODE parameter. Then, program the voltmeter using the command sequence in Figure 5-6.

Scanner Mode Overview

This overview shows simplified voltmeter command and data paths, describes voltmeter operation for Scanner Mode ribbon cable operation, summarizes Scanner Mode low-level commands, and lists the parameter values set by the CONF command (preset values).

Voltmeter Architecture

Figure 5-7 is a simplified block diagram of the voltmeter architecture for Scanner Mode ribbon cable operation showing the command and data paths.

Data Path

For ribbon cable operation, the voltmeter is connected to one or more HP 44711A/B, 44712A, or 44713A/B multiplexers via the ribbon cable. Multiple user inputs are sent via the multiplexers and the ribbon cable to the voltmeter. When a measure trigger occurs, the input is sampled and A/D conversion occurs (A/D conversion requires 10 μ sec).

When A/D conversion occurs, the result is transferred via the 16-bit data bus to the data buffer. Stored measurement data can then be transferred to the mainframe or to the GPIO port. The data buffer stores readings in 16-bit integer form. The HP 44702A data buffer can hold up to 8,192 (8k) readings, while the HP 44702B and HP 44704A data buffer can hold up to 65,536 (64k) readings. The data buffer has three main "data available" modes, as shown in Figure 5-7. Refer to "Readings Storage Mode (RDGSMODE)" for details on reading storage modes.

Command Path

The voltmeter has an on-board microprocessor which accepts commands from the mainframe. With ribbon cable operation the voltmeter is capable of independent operation. That is, the voltmeter is configured by commands issued from the mainframe and can then operate independently via the ribbon cable to take and store measurements.

An important part of the command path is the Scan RAM. The microprocessor downloads a channel list for measurements and a range list for the voltmeter into the Scan RAM which can hold up to 4,096 16-bit words. For ribbon cable operation, the Scan RAM acts to open and close the appropriate multiplexer channels for measurements. (The Scan Control is used with triggering and will be discussed in "Selecting Voltmeter Triggering".)

DAV and END

Data is available when any reading is stored. If the buffer fills, no more readings are entered and scan sequence stops.

BURST

Data is available when the buffer has room for only 4096 more readings. If the buffer fills, no more readings are entered and the scan sequence does not stop.

COMPLETE

Data is available when any reading is stored. If the buffer and the scan sequence does not stop.

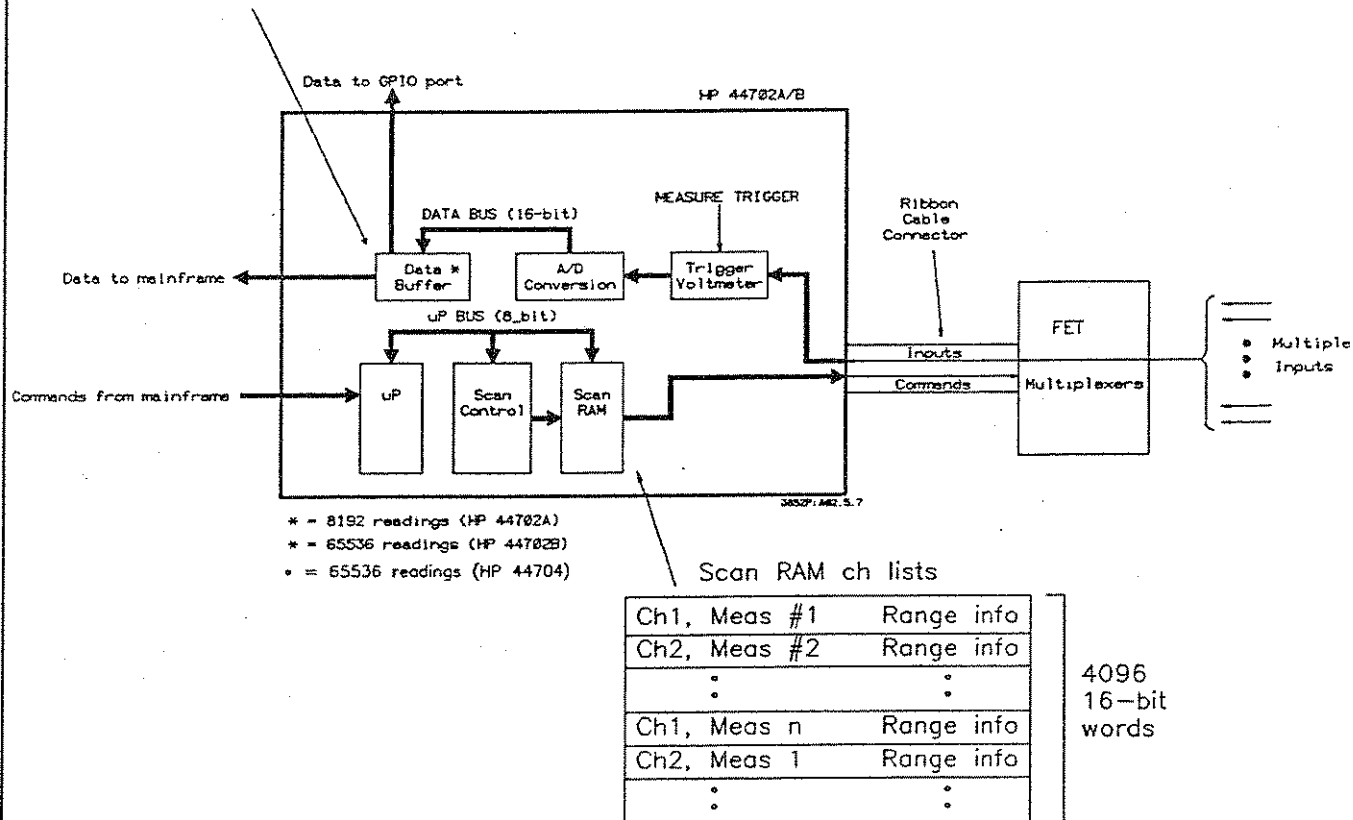

Figure 5-7. Voltmeter Command and Data Paths

For example, if two channels are to be measured with five measurements on each channel, the Scan RAM contents are as shown in Table 5-11.

Table 5-11. Typical Scan RAM Contents

ch 1, measurement 1	range, ch 1
ch 1, measurement 2	range, ch 1
:	:
ch 1, measurement 5	range, ch 1
ch 2, measurement 1	range, ch 2
:	:
ch 2, measurement 5	range, ch 2
:	:

Voltmeter Operation Figure 5-8 shows the voltmeter scan sequence and summarizes applicable commands for Scanner Mode ribbon cable operation. The scan sequence does not include voltmeter configuration and reference measurements made by CONF.

The commands in Figure 5-8 are grouped into the three categories discussed in this section: voltmeter configuration, voltmeter triggering, and data transfers and interrupts. Refer to "Low-Level Commands" (Table 5-13) for further information on the commands. A description of the scan sequence follows.

Scan Sequence

A "scan sequence" consists of all voltmeter actions which occur after the scan trigger is enabled to start the scan until the scan sequence ends. A scan sequence consists of at least n prescan passes (as set with PRESCAN) plus m postscan passes as set with POSTSCAN).

A "scan pass", in turn, consists of NRDGS measurements (as set with NRDGS) on each channel in the scan list. There are three types of triggers which control the operation: the scan trigger, the measure trigger, and the stop trigger.

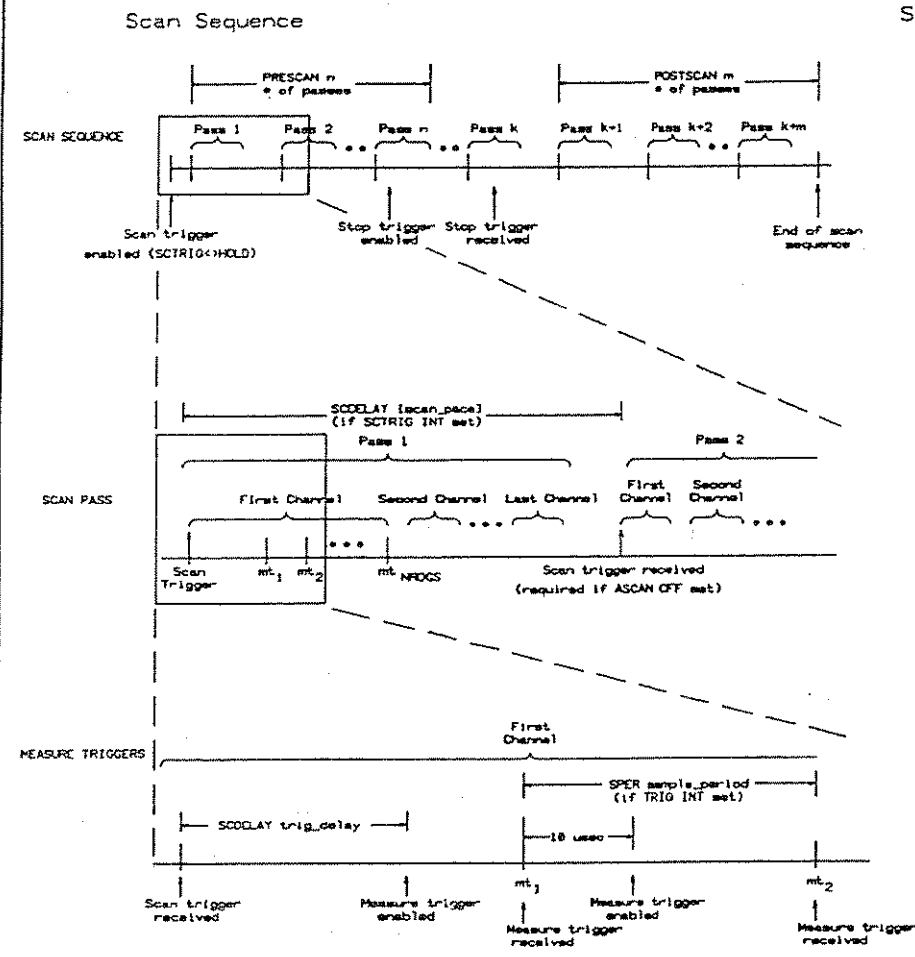

Scanner Mode Commands

Voltmeter Configuration

Known State

- USE sets voltmeter slot to be use.
- SCANMODE ON sets Scanner Mode operation.
- CONF configures the voltmeter.

Operating Parameters

- TERM sets input terminals.
- AZERO autozeroes voltmeter.
- FUNC sets channel and range list.

Range/Channel Lists

- RANGE sets scan trigger source.
- ARMODE sets autorange mode.
- CLWRITE sets channel and range lists.

Number of Readings

- PRESCAN sets scan trigger source.
- POSTSCAN sets number of postscans.
- NROGS sets number of readings per channel.

Voltmeter Triggering

Scan Trigger

- SCTRIG sets scan trigger source.
- SCSLOPE sets scan trigger edge.
- PERC sets scan trigger input threshold.
- SCDELAY trig_delay sets time to first measure trigger.
- SCDELAY [scan_pace] sets time between scan trigger.
- ASCAN sets autoscan mode.

Measure Trigger

- TRIG sets measure trigger source.
- SLOPE sets measure trigger edge.
- SPER sets time between internally generated mass triggers.
- TRIGOUT sets EXTO port trigger output mode.

Stop Trigger

- STTRIG sets stop trigger source.
- STSLOPE sets stop trigger edge.
- PERC sets stop trigger input threshold.

Data Transfers and Interrupts

Data Destination/Storage

- RDGS sets data destination.
- RDGSMODE sets reading storage and interrupt modes.

Transferring Readings

- CHREAD transfers single reading.
- XRDGS transfers multiple readings.

Settings Interrupts

- ENABLE INTR enables voltmeter to interrupt.
- DISABLE INT disables voltmeter from interrupting.

Figure 5-8. Voltmeter Scan Sequence

The scan sequence is started with a scan trigger. When the scan trigger is enabled (SCTRIG is set to other than HOLD), the voltmeter makes *n* prescan passes. The stop trigger is enabled on the *n*th pass. When the stop trigger is received from the source set by STTRIG (on the *k*th pass), the voltmeter completes the *k*th pass and makes *m* postscan passes through the scan list.

For example, with PRESCAN 3 and POSTSCAN 4 the voltmeter makes at least seven passes through the scan list. The stop trigger is enabled on the third prescan pass. If the stop trigger is also received on the third prescan pass, the voltmeter makes seven passes (three prescan + four postscan). However, if the stop trigger is received during the tenth pass, the voltmeter makes 14 passes (ten prescan + four postscan).

Scan Pass

As noted, a scan pass consists of NRDGS measurements on each channel in the scan list as defined with CLWRITE. Each measurement is initiated by a measure trigger (*mt*₁, etc. in Figure 5-8). If NRDGS 1 is set, one measurement is made on each channel. For NRDGS 1, NRDGS measurements are made on each channel.

For example, with NRDGS 1 and five channels in the scan list, five measurements (one for each channel) are made in each pass. With NRDGS 5 and five channels in the scan list, 25 measurements are made.

Two commands affect the time between passes: ASCAN and SCDELAY. If ASCAN ON is set, a single scan trigger is required to start the first pass, all subsequent passes are started automatically, and the SCDELAY *trig_delay* delay time occurs only for the first pass.

With ASCAN OFF, a separate scan trigger is required to start each pass and the SCDELAY *trig_delay* delay time applies to all passes. When TRIG INT is set, the SCDELAY [*scan_pace*] parameter sets the time between the start of successive passes.

Measure Triggers

There is a measure trigger for each measurement. The SCDELAY *trig_delay* parameter sets the delay from the time the scan trigger is received until the measure trigger is enabled (not the delay time to the first measurement).

When the measure trigger is received (*mt*₁), the first measurement is made. Each measurement requires 10 μ sec, after which the measure trigger is re-enabled. If TRIG INT is set, the SPER *sample_period* parameter sets the time between measure triggers.

Stop Trigger

The stop trigger is enabled after the start of the *n*th prescan pass and is accepted on the *k*th pass ($k \geq n$). For example, if PRESCAN 3 is set (three prescan passes), the stop trigger is enabled on the third prescan pass. If the stop trigger is received during the third or subsequent passes, the trigger will be accepted. Stop triggers received before the third pass are ignored.

CONF Preset Values Since the CONF command is the starting point for voltmeter configuration, the values set by the CONF command (preset values) for Scanner Mode operation are listed here. Use the CONF preset values to determine which (if any) voltmeter configuration, triggering, or data transfer and interrupt parameters need to be modified.

CONF *function* [USE *ch*] configures the voltmeter parameters shown to a known state. That is, setting CONF is equivalent to setting the commands shown in Table 5-12 in the order shown. SCANMODE ON must be set prior to CONF to obtain the settings in Table 5-12. (Note that SADV and STRIG do not apply to Scanner mode ribbon cable operation.)

Table 5-12. CONF Preset Values - Scanner Mode Operation

Command/Parameter	Definition
SADV SCAN	Advance scan when readings are available [1]
STRIG SCAN	Start scan immediately [1]
SCTRIG HOLD	Scan trigger is disabled[2]
TRIG INT	Internal measure trigger source.
STTRIG INT	Internal stop trigger source,
FUNC DCV or OHMxx	As appropriate for CONF function parameter.
RANGE AUTO	Autorange mode. [3]
TERM RIBBON	Ribbon cable is the input source.
NRDGS 1	One reading per channel.
RDGS SYS	Readings are returned to the mainframe.
RDGSMODE DAV	Reading is available when any reading stored.
ARMODE AFTER	Autorange after measure trigger is received.
ASCAN OFF	Autoscan off.
SCDELAY .001, .001	1 msec scan trig-delay
SPER .001	1 msec between measurement triggers,
PRESCAN 1	1 prescan before stop trigger accepted.
POSTSCAN 0	0 postscans after stop trigger accepted.
AZERO ONCE	1 Autozero once.
<p>Notes:</p> <p>[1] = Does not apply to Scanner Mode ribbon cable operation.</p> <p>[2] = For CONF TEMPxx, mainframe firmware revisions before revision 2.2 set the 320 mV range for xx = E, J, K, and N14 [N(AWG 14)] and set the 40 mV range for xx = B, R, S, T, and N28[N(AWG 28)].</p> <p>[3] = CONF OHM1M and CONF OHMF1M set 6 msec trigger-delay and 6 msec scan-pace.</p>	

Low-Level Commands Table 5-13 is an alphabetical summary of Scanner Mode low-level commands with power-on and default parameters (as applicable). If a command (such as SCDELAY or FUNC) has two parameters, the command is listed twice, once for each parameter. Refer to the HP 3852A Command Reference Manual and/or to “Scanner Mode Command Summary” at the end of this chapter for details on the commands.

Table 5-13. Scanner Mode Low-Level Commands

Command	Description	Power-On	Default	Note
ARMODE mode	Autorange mode	AFTER	-	
ASCAN [mode]	Autoscan mode	OFF	ON	
AZERO [mode]	Autozero mode	ONCE	ONCE	
CAL	Service cmd	-	-	[1]
CHREAD ch	Make single rdg	-	-	
CLWRITE ch_list	Channel list	-	-	
CLWRITE [ribbon_bus]	Ribbon cable conn	-	SENSE	
CLWRITE [RANGE range_list]	Range list	-	AUTO	
DISABLE INTR	Disable intr	disabled	-	[2]
ENABLE INTR	Enable intr	disabled	-	
FUNC function	Meas function	DCV	-	
FUNC (range)	Meas range	AUTO	AUTO	
NRDGS number	Rdgs/channel	1	-	
PERC threshold	Trigger threshold	0%	-	
POSTSCAN number	Number postscans	0	-	
PRESCAN number	Number prescans	1	-	
RANGE [range]	Voltmeter range	AUTO	AUTO	
RDGS dest	Readings dest	SYS	-	
RDGSMODE mode	Rdgs storage	DAV	-	
SCANMODE [mode]	Operating mode	OFF	ON	
SCDELAY trig_delay	Scan trigger delay	0 msec	-	
SCDELAY [scan_pace]	Time between scan triggers	2 ms	unchgd	[3]
SCSLOPE mode	Scan trigger slope	LH	-	[4]
SCTRIG [source]	Scan trigger source	HOLD	HOLD	
SLOPE mode	Meas trigger slope	LH	-	[5]
SPER sample_period	Meas trigger timing	10 μ sec	-	
STSLOPE mode	Stop trigger slope	LH	-	[6]
STTRIG [source]	Stop trigger source	INT	SGL	
TERM terminal	Input terminals	EXT	-	
TRIG [source]	Meas trigger source	INT	SGL	
TRIGOUT [mode]	EXT0 mode	OFF	ON	
USE ch	Slot or chan used	Low valid ch/slot	-	[7]
XRDGS ch	Voltmeter slot	-	-	
XRDGS [number]	Number of readings	1	1	

Notes:

- [1] = Refer to HP 3852A Assembly Level Service Manual.
- [2] = Interrupts disabled at power-on.
- [3] = SCDELAY [scan_pace] used only when SCTRIG INT is set.
- [4] = Used only when SCTRIG EXT0, EXT1, MEAS, or GPIO is set.
- [5] = Used only when TRIG EXT0, EXT1, or GPIO is set.
- [6] = Used only when STTRIG EXT0, EXT1, MEAS, or GPIO is set.
- [7] = Low valid ch/slot (may or may not be the voltmeter slot).

Selecting Voltmeter Configurations

Guidelines to select voltmeter configuration parameters for Scanner Mode ribbon cable measurements follow. Table 5-14 shows a suggested sequence to select the parameters, refer to "Selecting Voltmeter Triggering" and/or to "Selecting Data Transfers/Interrupts", as required. Then, program the voltmeter for your measurement using the sequence in Figure 5-6.

NOTE

The commands in Table 5-14 are not necessarily described in the order shown in Figure 5-6. Always program the voltmeter as shown in Figure 5-6.

Table 5-14. Voltmeter Configuration Parameters

Action	Commands	Definition
Set Known State	USE ch SCANMODE ON CONF	Voltmeter slot used Set Scanner Mode Configure voltmeter
Set Operating Parameters	FUNC AZERO TERM	Voltmeter function Autozero Input terminals
Set Range/Channel Lists	RANGE ARMODE CLWRITE	Voltmeter range Autorange mode Channel/range lists
Set Number of Readings	PRESCAN POSTSCAN NRDGS	Number of prescans Number of postscans Readings per channel

Setting Known state To begin programming the voltmeter, first set the system to a known State with the USE, SCANMODE, and CONF commands.

Voltmeter Slot (USE) Set the voltmeter slot to be used with USE *ch*. (Recall that the voltmeter uses two slots and the lowest slot is used for programming.)

NOTE

The DISP command turns the mainframe display on or off. Turning the display off greatly improves system performance by speeding up command execution and is highly recommended for high-speed measurements.

Set Scanner Mode (SCANMODE) At power-on or after a reset, the voltmeter is set for System Mode operation (SCANMODE OFF). For Scanner Mode measurements, set the voltmeter to Scanner Mode with SCANMODE ON.

Configure Voltmeter (CONF) When the USE *ch* and SCANMODE ON have been set, configure the voltmeter to a specified state with CONF (refer to Table 5-12). If CONF is not used, set SCTRIG HOLD as the first command after SCANMODE ON. Note that no commands except RST, ENABLE INTR, DISABLE INTR, and SCTRIG are allowed unless SCTRIG HOLD is set.

Setting Operating Parameter Voltmeter operating parameters which can be set include the input terminals (TERM) and autoscan mode (ASCAN). You can also set the autozero control mode with AZERO.

Input Terminals (TERM) TERM *terminal* [USE *ch*] sets the input source to the voltmeter. For scanner Mode, TERM RIBBON sets the ribbon cable as the input, TERM INT sets the backplane bus, and TERM EXT selects the rear panel terminals.

Note that power-on TERM *terminal* = EXT, but CONF sets TERM RIBBON. (TERM ZERO can also be selected - refer to the HP 3852A Assembly Level Service Manual for details on TERM ZERO). Unless noted, all examples use ribbon cable (TERM RIBBON) operation.

Autozero (AZERO) When CONF is executed, the voltmeter makes a single autozero measurement at the beginning of the measurement sequence. However, as required, you can also use AZERO ONCE to autozero the voltmeter. When AZERO ONCE is executed, the voltmeter nulls out its internal circuitry offsets. Using AZERO ONCE does not impose a time penalty during scanning.

Voltmeter Function (FUNC) FUNC *function* [*name*] [USE *ch*] selects a measurement function and a measurement range, where *function* selects the measurement function and [*range*] selects a measurement range or the autorange mode. Only DCV, OHMF10K, OHMF100K, or OHMF1M can be used for FUNC *function*.

To select the FUNC measurement range, you must specify the expected maximum signal amplitude or maximum resistance. The voltmeter then selects the correct range. To set autorange, use the word AUTO or the number 0 for [*range*]. Power-on and default FUNC [*range*] = AUTO.

Table 5-15 shows the voltmeter range selected by FUNC [*range*] for DC voltage and 4-wire ohms ranges. In Table 5-15, any value between the ranges shown selects the range shown. For example, if the voltmeter is configured for DC voltage, any value of FUNC [*range*] >0.32 through 2.56 sets the voltmeter to the 2.56V range.

Table 5-15. FUNC [range] Values*

DCV		OHMF10K	
range	Selects Range	range	Selects Range
0 or AUTO	Autorange	0 or AUTO	Autorange
>0 - .040	40 mV	>0 - 40	40 Ω
>.04 - .32	320 mV	>40 - 320	320 Ω
>.32 - 2.56	2.56V	>320 - 2560	2.56 kΩ
>2.56 - 10.24	10.24V	>2560 - 10240	10.24 kΩ
OHMF100K		OHMF1M	
range	Selects Range	range	Selects Range
0 or AUTO	Autorange	0 or AUTO	Autorange
>0 - 400	400 Ω	>0 - 4000	4 kΩ
>400 - 3200	3.2 kΩ	>4000 - 32,000	32 kΩ
>3200 - 25600	25.6 kΩ	>32,000 - 256,000	256 kΩ
>25600 - 102400	102.4 kΩ	>256,000 - 1,024,000	1.024 MΩ

* = DCV, OHMF10K, OHMF100K, and OHMF1M are voltmeter measurement functions as set by CONF or FUNC, at power-on, or by a reset (RST)

Setting Range/ Channel Lists Voltmeter range/channel list parameters which can be set include the voltmeter range (RANGE), autorange mode (ARMODE), and channel/range lists (CLWRITE).

Voltmeter Range (RANGE) At power-on, after a reset (RST or RST slot), or when CONF is executed, the voltmeter is set for autorange mode. RANGE [range] [USE ch] sets the voltmeter range or sets autorange. To determine the voltmeter range, you must specify the maximum expected signal amplitude or the maximum expected resistance. The voltmeter then automatically selects the correct range.

Autorange is selected by entering the word AUTO or the number 0 for the RANGE [range] parameter. Values for RANGE [range] are the same as those for FUNC [range] in Table 5-15 (refer to "Voltmeter Function (FUNC)").

Autorange Mode (ARMODE) When autoranging is enabled (with CONF, FUNC, RANGE, etc.), ARMODE mode [USE ch] sets the autorange mode. ARMODE has two modes: Immediate Mode (ARMODE BEFORE) and Delayed Mode (ARMODE AFTER) which is the power-on mode. As shown in Figure 5-9, each measurement is initiated by a measure trigger and requires 10 μsec to complete.

When a measurement completes, the measure trigger is re-enabled for the next measurement. Actual time between the start of successive measurements (between measure triggers) depends on several factors, such as the CONF setting, TRIG source, etc.

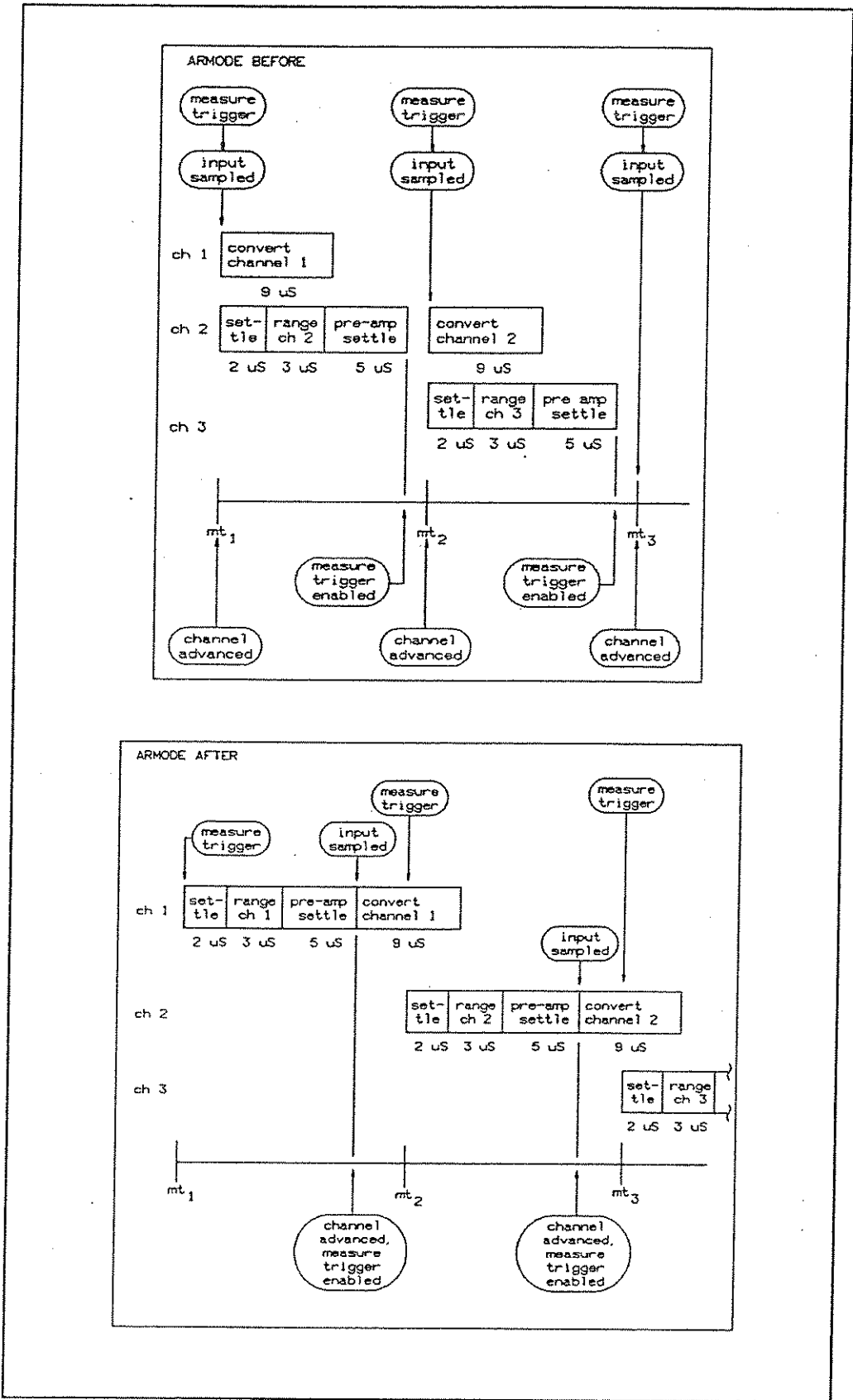

Figure 5-9. Autorange Modes

Immediate Mode (ARMODE BEFORE)

With ARMODE BEFORE, the input is sampled immediately when the measure trigger is received. For ribbon cable operation, the voltmeter advances to the next channel and autoranges on that channel during the A/D conversion time of the current channel.

As shown in Figure 5-9, with ARMODE BEFORE and autoranging enabled, the channel 1 input is immediately sampled when measure trigger mt_1 is received and the multiplexer is advanced to channel 2. During the time the channel 1 measurement is being converted, the voltmeter autoranges on channel 2. After $10 \mu\text{sec}$, the measure trigger is re-enabled.

When the next measure trigger (mt_2) is received, the channel 2 input is immediately sampled, the multiplexer is advanced to channel 3, and the voltmeter autoranges on channel 3, etc.

The advantage of using ARMODE BEFORE is that the input is sampled immediately when the measure trigger is received (necessary for FFT-type applications). However, with ARMODE BEFORE, since the autorange for the next channel is made at the same time as the data conversion for the current channel, an incorrect range may be used for the next channel if a long delay occurs until the next trigger.

In addition, when the measurement sequence is first started, if the multiplexer is set to an unknown state, the voltmeter immediately samples the preamplifier output and advances the scan to the first channel (channel 1).

For these conditions, the first measurement may not contain valid data and should be disregarded. Thus, you should carefully check the first reading when ARMODE BEFORE is set and the multiplexer is in an unknown state when the measurement sequence begins.

Delayed Mode (ARMODE AFTER)

With ARMODE AFTER, when a measure trigger is received the voltmeter first autoranges on the channel, then samples the input, and then does the A/D conversion. For example, as shown in Figure 5-9 when the measure trigger for channel 1 (mt_1) is received, the voltmeter autoranges on channel 1 and (after a $5 \mu\text{sec}$ delay) samples the channel 1 input. When the measure trigger for channel 2 (mt_2) is received, the sequence is repeated for channel 2, etc.

Since only 5 μ sec elapses between autoranging and input sampling, the range selected is valid unless the signal rate of change is greater than about 1000 volts/second.

Channel/Range Lists (CLWRITE) For Scanner Mode ribbon cable measurements, CLWRITE [*ribbon_bus*] *ch_list* [RANGE *range_list*] [USE *ch*] is used to set a channel list and an associated range list.

NOTE

For ribbon cable operation, a scan list must be defined with CLWRITE before the scan trigger (SCTRIG) can be set to a source other than HOLD. Refer to "Scan Trigger Source (SCTRIG)" for details on the SCTRIG command.

Specify Ribbon Cable Connections

CLWRITE [*ribbon_bus*] specifies the ribbon cable hardware connections: SENSE (default), COM, SEP, REFT, or STRVEX as defined in Table 5-16. SENSE is used for DC voltage measurements, COM for 2-wire ohms measurements, and SEP for 4-wire ohms measurements. REFT allows thermocouple reference temperatures to be scanned. STRVEX allows the excitation voltage on strain gage multiplexers to be scanned. (REFT and STRVEX are valid only for mainframe firmware revision 2.2 and greater.)

Table 5-16. CLWRITE [*ribbon_bus*] Parameters

Ribbon_bus	Description
SENSE	Sets the ribbon cable for voltmeter Sense bus only. Voltmeter current source is disconnected. Used for DC voltage measurements only.
COM	Both the voltmeter Sense bus and the current Source bus are connected in the multiplexer accessory. Used for 2-wire ohms measurements only.
SEP	Both the voltmeter Sense bus and the current Source bus are available to the user. The voltage Sense connects to Bank A and the current Source connects to Bank B. Specify only the Bank A channels in the ch-list, since the respective channels in Bank B will close automatically. Used for 4-wire ohms measurements only.
REFT*	Scan the reference (thermistor) temperature on thermocouple channels in the scan list.
STRVEX*	Scan excitation voltage for strain gage multiplexer channels in the scan list.
Notes:	
* = Applies only to mainframe revisions 2.2 and greater	

Specify Channel List

CLWRITE *ch_list* specifies the channel list. Since CLWRITE is valid only for ribbon cable measurements, all channels in the *ch_list* must be connected by ribbon cable to the voltmeter.

With two exceptions, [NRDGS *number*] times [number of channels - 1] must be <4095. For NRDGS 1, the maximum number of readings per channel is 4,096. For one channel in the scan list, you can use NRDGS 65535 (NRDGS 8192 for the HP 44702A). Refer to "Number of Readings (NRDGS)" for details on channel list length.

• Channel List vs. Range List:

Each item in the [RANGE *range_list*] parameter is associated with a corresponding channel or channel sequence (*ch_list*). If the number of items in [RANGE *range_list*] is less than the number of channels or channel sequences, the current range as set by the RANGE command is used for the remaining channels.

If the number of items in [RANGE *range_list*] is greater than the number of channels or channel sequences, ERROR 21 - TOO MANY ARGS is generated. For example, CLWRITE 500-519,RANGE 2, 10 generates an error since there are two range list entries (2 and 10), but only one channel list sequence (500-519).

• Channel List Greater Than 10 Items:

To use a channel list of more than 10 items with CLWRITE, use an INTEGER array to store the channel numbers and then specify the array name for the *ch_list* parameter. When the array is declared, a valid channel address must be in each element of the array. There can be no empty or "extra" array elements.

NOTE

Multiple CLWRITE commands cannot be used to specify a continuous channel list. Each CLWRITE command will overwrite the previous channel list. Thus, the channel list actually used for the measurement is that specified by the last CLWRITE command.

Specify Range List

As noted, the [RANGE *range_list*] parameter specifies the list of voltmeter ranges which correspond to the channels to be scanned. Entries in [RANGE *range_list*] apply to corresponding entries in *ch_list*. One range can be used for the entire *ch_list* or separate ranges can be used for the corresponding channels and/or channel sequences.

The value(s) you specify for [RANGE *range_list*] should be the maximum signal amplitude expected on each channel (for voltage measurements) or the maximum resistance expected on each channel (for resistance measurements). The voltmeter then selects the correct range.

To select autorange for a channel and/or channel sequence, specify the word AUTO or the value 0 for [RANGE *range_list*]. In autorange mode, the voltmeter samples the input signal and selects the appropriate range before each measurement. Default setting is the last programmed RANGE command value.

If [RANGE *range_list*] is not specified, the last programmed RANGE command value is used for all channels specified by CLWRITE. If the RANGE command is executed after CLWRITE, the range set by RANGE is used for all channels specified by CLWRITE and the range values which were specified by CLWRITE are cancelled.

NOTE

Changing NRDGS after sending CLWRITE will not affect the old ch_list.

To use a range list of more than 10 items with CLWRITE, use a REAL array to store the range numbers and then specify the array name for the [RANGE *range_list*] parameter. When the array is declared, a valid range must be in each element of the array. There can be no empty or "extra" array elements.

Example: Setting Channel/Range Lists

CLWRITE sets channel lists, voltmeter ranges and ribbon cable connections for Scanner Mode ribbon cable measurements. This program uses CLWRITE to set channels 500 through 509 as the scan list and set the 10.24V range for measurement on each channel. The program takes one measurement on each channel for a total of ten measurements.

Since CONF DCV sets DC voltage measurements, the optional CLWRITE [*ribbon_bus*] parameter is not used and the ribbon cable is configured for DC volts (since SENSE is the default parameter). The CLWRITE [*RANGE range_list*] parameter is set for RANGE 9 which sets the 10.24V range for each channel.

```

10 DIM A(0:9)                                / Define controller array
20 OUTPUT 709;"USE 600"                       / Use voltmeter in mainframe slot 6
30 OUTPUT 709;"SCANMODE ON"                 / Set Scanner Mode
40 OUTPUT 709;"CONF DCV"                    / Configure for DC volts
50 OUTPUT 709;"CLWRITE 500-509,RANGE 9" / Set scan list and range
60 OUTPUT 709;"SCTRIG INT"                  / Trigger the voltmeter
70 OUTPUT 709;"XRDGS 600"                   / Read 10 readings
80 ENTER 709;A(*)                             / Enter 10 readings
90 PRINT USING "K,/";A(*)                     / Display 10 readings
100 END

```

For a set of 9 V 5% sources connected to channels 500 through 509, a typical return (values in volts) is:

8.99, 9.015, ... 8.925

Setting Number of Readings As shown in Figure 5-8, after the scan trigger is enabled the voltmeter makes at least *n* prescan passes (set with PRESCAN) and *m* postscan passes (set with POSTSCAN). For each channel in the scan list, the voltmeter makes NRDGS readings (as set with NRDGS). Guidelines follow to use NRDGS, POSTSCAN, and PRESCAN to set the number of readings taken by the voltmeter.

Number of Prescans (PRESCAN) PRESCAN *number* [USE *ch*] sets the number of passes the voltmeter makes through the scan list before a stop trigger is accepted. The range of *number* is 0 to 65,535 with power-on *number* = 1. CONF sets PRESCAN 1.

Prescan Operation

As shown in Figure 5-8, after the scan trigger is enabled the voltmeter makes *n* prescan passes through the scan list and the stop trigger is enabled on the *n*th pass. When the stop trigger is received (on the *k*th pass), the voltmeter completes the *k*th pass and makes *m* postscan passes.

For example, with PRESCAN 3 the stop trigger is enabled on the third pass. If the stop trigger is also received on the third pass, the voltmeter makes three prescan passes. However, if the stop trigger is received on the sixth pass, the voltmeter makes six prescan passes.

Interaction With Stop Trigger

If both PRESCAN and POSTSCAN are set to 0, the scan sequence may return no results. If STTRIG INT (internal stop trigger) is set, one pass will always be done (even if POSTSCAN 0 is set) since STTRIG INT will generate a stop trigger at the end of each pass. With STTRIG MEAS, at least two passes will be made. For other STTRIG sources, zero passes of the scan list may occur. Refer to "Stop Trigger Source (STTRIG)" for details on the STTRIG command.

Interaction with Readings Storage Mode

When RDGSMODE COMPLETE is set, data in the buffer is trimmed to exactly (PRESCANS + POSTSCANS) scan passes if the data will all fit in the buffer. If the data will not all fit, the last buffer load of data taken is stored (the last 8,192 readings for an HP 44702A or the last 65,536 readings for an HP 44702B or HP 44704A).

For example, with PRESCAN 3 and POSTSCAN 4 and RDGSMODE COMPLETE set, the resultant data in the buffer is from the last three prescans before the stop trigger and the four postscans after the stop trigger (assuming the buffer can hold the data from the seven scans). Refer to "Readings Storage Mode (RDGSMODE)" for details on the RDGSMODE command.

Number of Postscans (POSTSCAN) POSTSCAN *number* [USE *ch*] sets the number of postscan passes the voltmeter will make after the stop trigger is accepted. The range of *number* is from 0 to 65,535 with power-on *number* = 0. CONF sets POSTSCAN 0.

As shown in Figure 5-8, when the stop trigger is received the voltmeter makes *m* postscan passes where *m* is set with POSTSCAN *number*. For example, with POSTSCAN 4, the voltmeter makes four passes after completing the pass in which the stop trigger is accepted.

Number of Readings (NRDGS) NRDGS *number* [USE *ch*] sets the number of readings per channel for each channel in the scan list. The range for *number* is 1 to 65,535 with power-on *number* = 1. As shown in Figure 5-8, a measurement is taken for each measure trigger and NRDGS *number* readings are taken on each channel.

For NRDGS *number* >1, and more than one channel in the scan list, the range of NRDGS *number* is set by [number of channels - 1] times [NRDGS *number*] With one channel in the channel list, the maximum value of NRDGS *number* is 65,535 for an HP 44702B or HP 44704A (8,192 for an HP 44702A). Also, for NRDGS 1, the maximum number of channels is 4,096.

For two channels and NRDGS 1, the maximum number of readings per channel is 4,094. That is, since [2 channels - 1] times [NRDGS *number*] must be , the voltmeter can make a maximum of 4,094 readings per channel (NRDGS 4,094). For three channels, maximum number of readings per channel = $4,094/(3-1) = 2,047$, etc.

NOTE

Changing NRDGS after sending CLWRITE does not affect the old channel list.

Example: Setting Number of Readings

This example uses PRESCAN, POSTSCAN, and NRDGS to set the number of measurements on channels 500 through 504 of an HP 44711A/B multiplexer. The program uses internal stop triggering (as set with CONF), PRESCAN 2, POSTSCAN 1, and NRDGS 2, so the voltmeter makes 2 prescan passes and 1 postscan pass and takes 2 readings on each channel in the scan list. The total number of readings = [2 readings/channel] times [5 channels] times [3 passes] = 30 readings.

```

10 DIM A(0:29)                                ! Define controller array
20 OUTPUT 709;"USE 600"                       ! Use voltmeter in MF slot 6+
30 OUTPUT 709;"SCANMODE ON"                 ! Set Scanner Mode
40 OUTPUT 709;"CONF DCV"                    ! Configure for DC volts
50 OUTPUT 709;"NRDGS 2"                     ! Set 2 readings/channel
60 OUTPUT 709;"PRESCAN 2"                   ! Set 2 prescans
70 OUTPUT 709;"POSTSCAN 1"                  ! Set 1 postscan
80 OUTPUT 709;"CLWRITE 500-504,RANGE 9" ! Set scan list and range
90 OUTPUT 709;"SCTRIG INT"                  ! Trigger the voltmeter
100 OUTPUT 709;"XRDGS 600"                  ! Read 30 readings
110 ENTER 709;A(*)                           ! Enter 30 readings"
120 PRINT USING "K,/";A(*)                  ! Display 30 readings
130 END

```

For a set of 9 V 5% sources connected to channels 500 through 504, a typical return (values in volts) is:

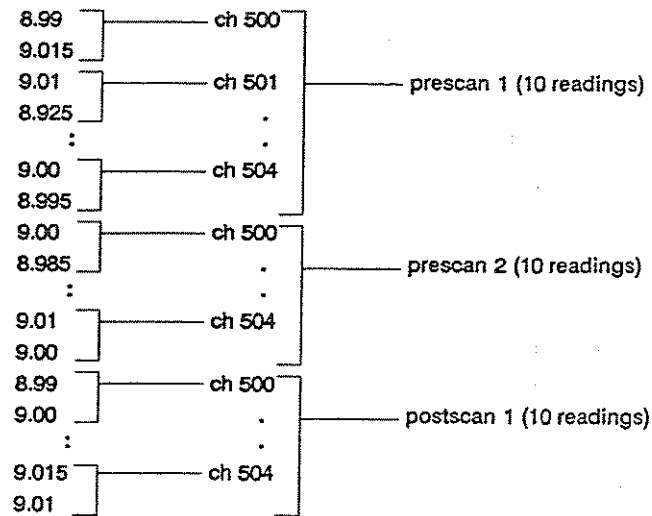

Selecting Voltmeter Triggering

As noted, there are three triggers which affect voltmeter operation: scan trigger measure trigger and stop trigger. This section gives guidelines to select parameters for these three triggers. The section also provides an overview of voltmeter triggering, including the voltmeter trigger operation and trigger sources.

To select voltmeter triggering parameters, first refer to “Triggering Overview” for a discussion of voltmeter trigger operation and the sources for voltmeter triggers. Then, refer to “Selecting Scan Triggering”, “Selecting Measure Triggering”, or “Selecting Stop Triggering” to select the trigger parameters for your measurement. Table 5-17 shows the parameters which can be selected for each of the three triggers.

When you have selected voltmeter triggering parameters, refer to “Data Transfers and Interrupts”. Then, program the voltmeter using the sequence in Figure 5-6.

NOTE

The voltmeter triggering commands in Table 5-17 are not necessarily in the same order as shown in Figure 5-6. Always program the voltmeter in the sequence in Figure 5-6.

Table 5-17. Voltmeter Triggering Parameters

Action	Commands	Definition
Set Scan Trigger	SCTRIG SCSLOPE PERC* SCDELAY ASCAN	Scan trigger source Scan trigger slope Scan trigger threshold Scan trigger delay Autoscan mode
Set Measure Trigger	TRIG SLOPE SPER TRIGOUT	Measure trigger source Measure trigger slope Measure trigger timing EXT0 port triggering
Set Stop Trigger	STTRIG STSLOPE PERC*	Stop trigger source Stop trigger slope Stop trigger threshold
Notes: * = PERC simultaneously sets scan and stop trigger thresholds.		

Triggering Overview An overview of voltmeter triggering operation and trigger sources follows. You may want to refer to Figures 5-7 and 5-8 as you read this section.

Voltmeter Trigger Operation Figure 5-10 shows simplified voltmeter trigger operation. The measure trigger triggers the voltmeter to make a measurement. Each measurement is then converted and sent to the voltmeter data buffer. There are three main sources for the scan, measure, and stop trigger: mainframe backplane, voltmeter internal, and voltmeter port triggering. These sources are discussed in the next subsection “Voltmeter Trigger Sources”.

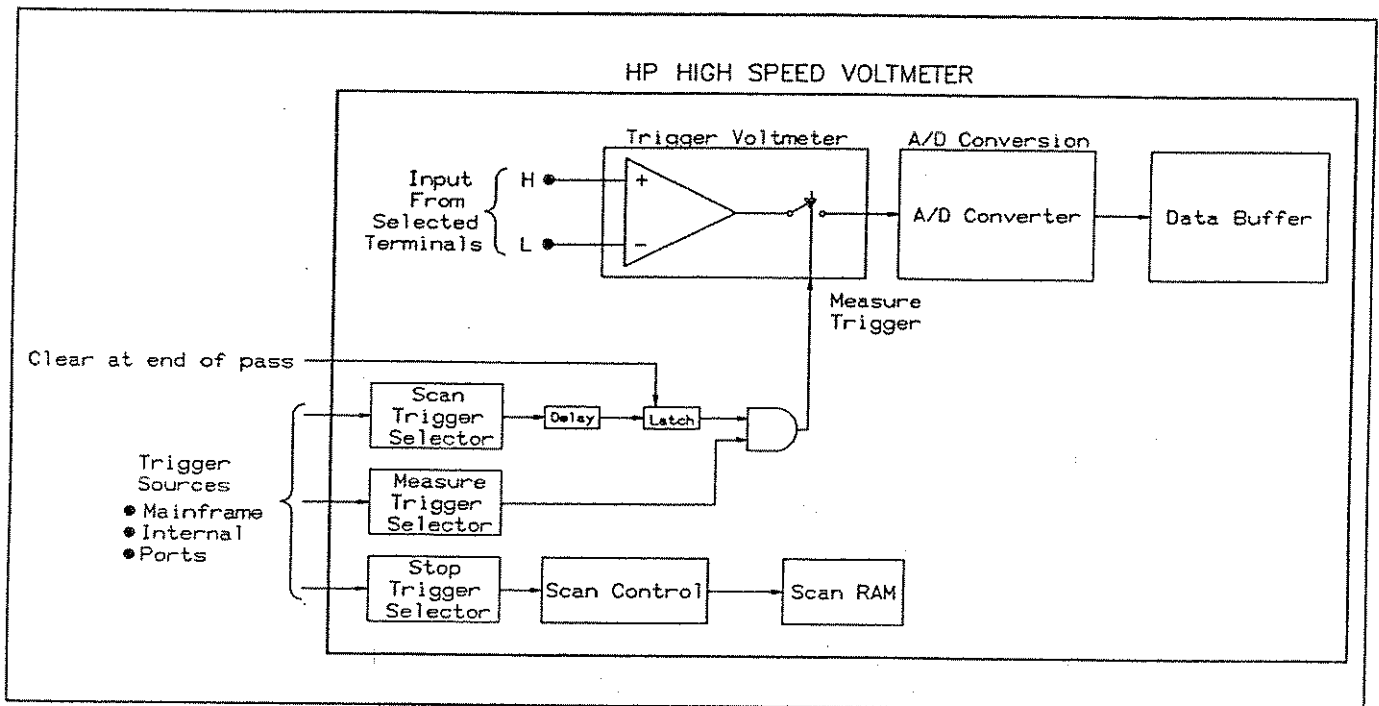

Figure 5-10. Voltmeter Trigger Operation

When a trigger is input to the scan trigger selector, after a delay a latch is set which enables the scan sequence to start. When a trigger is received by the measure trigger selector, a measure trigger is generated which causes the voltmeter to make a measurement. The latch remains set (and measure triggers can be generated) until the first pass ends. At the end of the pass, the latch is cleared if ASCAN OFF is set.

If ASCAN OFF is set, a scan trigger is required to start the second (and subsequent) passes. Thus, for ASCAN OFF, the scan trigger latch must be re-enabled to start each subsequent pass. For ASCAN ON, only a single scan trigger is required and the latch is not re-enabled for the second and subsequent passes.

When a trigger is input to the stop trigger selector, the voltmeter shifts from the prescan operation to the postscan operation (assuming the PRESCAN requirement is met). The stop trigger selector then sets the Scan RAM (via the Scan Control) to generate m postscan passes. Note that the stop trigger does NOT stop the scan sequence (unless POSTSCAN 0 is set).

Voltmeter Trigger Sources Figure 5-11 summarizes the parameters for the scan trigger source (SCTRIG), the measure trigger source (TRIG), and the stop trigger source (STTRIG) normally used for ribbon cable operation. There are three types of trigger sources: mainframe backplane triggers (SGL and SYS), voltmeter internal triggers (INT and MEAS), and voltmeter port triggers (EXT0, EXT1, and GPIO).

Although there are nine trigger sources, the SCAN parameter is not normally used for ribbon cable operation and the MEAS parameter does not apply to the measure trigger (TRIG). The following sections describe the sources for the scan, measure, and stop triggers.

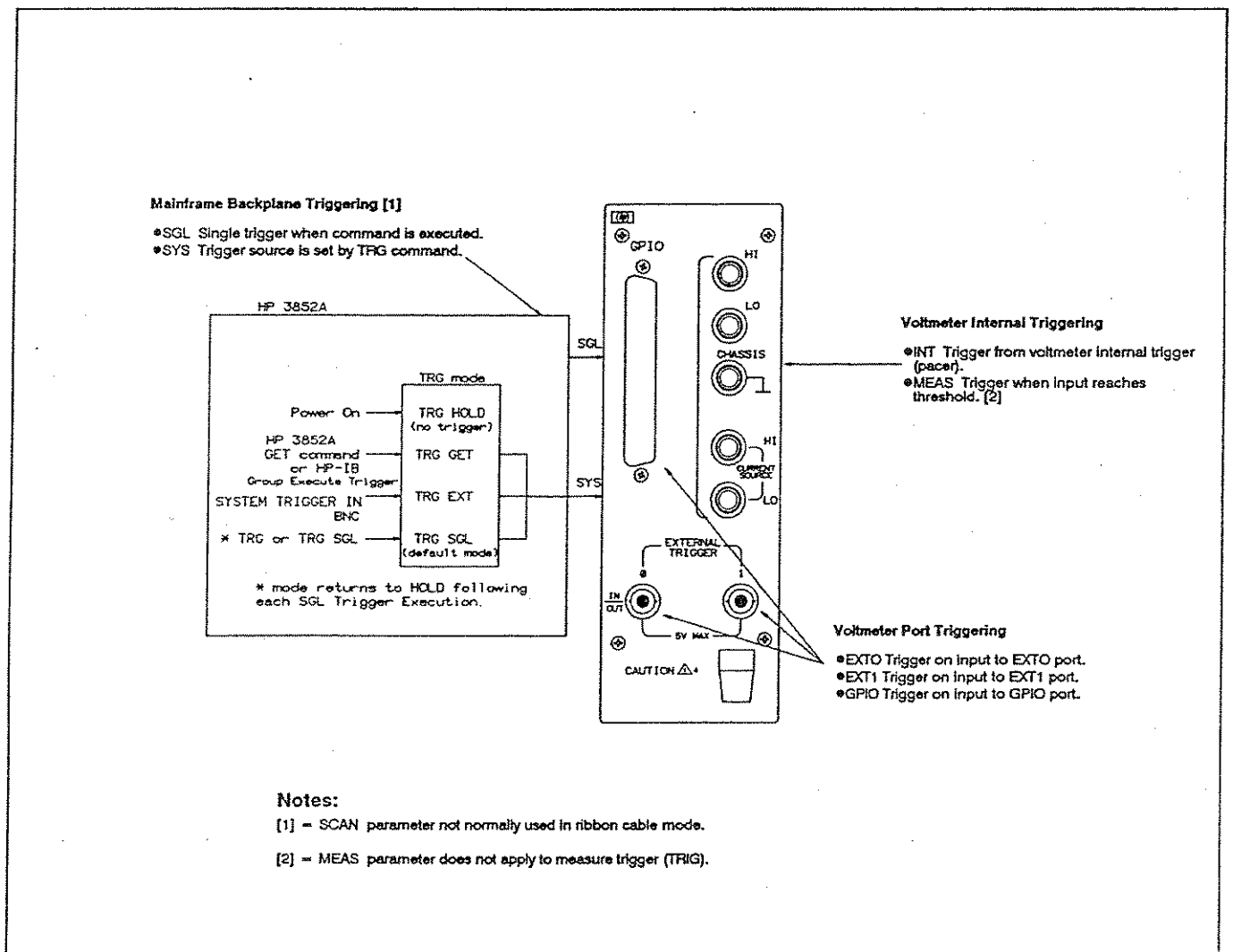

Figure 5-11. Voltmeter Trigger Sources

Setting Scan Triggering Guidelines to select scan trigger parameters follow, including scan trigger sources (SCTRIG), scan trigger slope (SCSLOPE), scan trigger threshold (PERC), scan trigger delay (SCDELAY), and autoscan mode (ASCAN).

As shown in Figure 5-8, the scan sequence starts when the scan trigger is enabled. Depending on the autoscan mode, a scan trigger is required only for the first pass (ASCAN ON) or a separate scan trigger is required for each pass through the scan list (ASCAN OFF).

Scan triggers are disabled from the time the scan trigger is received until the end of the scan pass. For example, in Figure 5-8 the scan trigger is disabled from the time the scan trigger starts pass 1 until the end of the SCDELAY [*scan_pace*] time (when SCTRIG INT is set) or until the last channel is measured (SCTRIG INT not set). Scan triggers received during this time are ignored.

Scan Trigger Source (SCTRIG) SCTRIG [*source*] [USE *ch*] sets the source or mode for the scan trigger. Power-on *source* is HOLD (no trigger) and default *source* is SGL (single trigger). For Scanner Mode measurements CONF sets SCTRIG HOLD. Table 5-18 summarizes SCTRIG sources for ribbon cable operation. A description of each source follows.

NOTE

For ribbon cable operation not using MEAS, a scan list must be defined with CLWRITE before SCTRIG is set to any source other than HOLD. Also, SCTRIG SCAN is not normally used in ribbon cable mode.

Table 5-18. Scan Trigger (SCTRIG) Sources - Ribbon Cable

Source	Description
HOLD	No triggering. Triggering is held off and scanning halted.
SGL	Single trigger from mainframe when command executed.
SYS	System trigger pulse (used with TRG).
INT	Voltmeter internal trigger.
MEAS	Trigger when input crosses threshold (used with PERC).
EXT0	Trigger voltmeter from EXT0 port.
EXT1	Trigger voltmeter from EXT1 port.
GPIO	GPIO trigger.
Notes:	
* = SCAN not normally used in ribbon cable mode.	

SCTRIG HOLD

When programming the voltmeter for Scanner Mode operation, SCTRIG HOLD or CONF (which sets SCTRIG HOLD) must be the first command after SCANMODE ON (see Figure 5-6). SCTRIG HOLD either completes or aborts a scan sequence.

When the scan sequence has been enabled by setting SCTRIG to a source other than HOLD, no programming commands except ENABLE INTR or DISABLE INTR can be sent until the scan sequence completes or is aborted by setting SCTRIG HOLD.

When the scan sequence has been completed or aborted by SCTRIG HOLD, any subsequent programming commands except ENABLE INTR or DISABLE INTR will cause the data buffer to be cleared and will destroy all remaining measurements. Therefore, all measurement data must be read (with CHREAD or XRDGS if MEAS is not used) before reprogramming the voltmeter. (Note that CHREAD and XRDGS are not programming commands.)

SCTRIG SGL

Use SCTRIG SGL for a single trigger from the mainframe which occurs when the command is executed. SCTRIG SGL can only be sent during a scan if SCTRIG SGL was used to enable the scan sequence. Note that SCTRIG SGL causes a single trigger.

SCTRIG SYS

SCTRIG SYS is used along with the TRG (mainframe) command. As shown in Figure 5-11, TRG has four sources/modes: HOLD, GET, EXT, and SGL. Note that SCTRIG SYS must be set for the voltmeter to accept a scan trigger from the TRG source. Refer to the HP 3852A Mainframe Configuration and Programming Manual for details on the TRG command.

SCTRIG INT

With SCTRIG INT, the voltmeter internal pacer generates scan triggers as required. Scan triggers received when scan triggering is disabled are ignored.

With SCTRIG INT set, if the SCDELAY [*scan_pace*] interval is shorter than the time required to make a scan pass the voltmeter will ignore the too-fast scan triggers and will wait for the next generated scan trigger after the current pass completes. Therefore, the scan pass pacing rate will not be as desired.

For example, assume each scan pass requires 1 second to complete and SCTRIG INT is set. If SCDELAY [*scan_pace*] = 0.6 seconds, pass 1 starts at $t = 0$. However, the scan trigger which occurs at $t = 0.6$ seconds is ignored and pass 2 starts at $t = 1.2$ seconds, etc.

SCTRIG MEAS

SCTRIG MEAS generates a scan trigger when the input to the voltmeter crosses a threshold level (percent of full-scale value) as set with the PERC command in the direction (HL or LH) set by the SCSLOPE command.

When SCTRIG MEAS is set, at the start of each pass the voltmeter connects the first channel and continuously monitors the input. When this level crosses the threshold in the proper direction, a scan trigger is generated. Refer to "Scan Trigger Threshold (PERC)" for an example using SCTRIG MEAS. For ASCAN OFF, monitoring is done for the first pass only.

SCTRIG EXT0/EXT1

For SCTRIG EXT0 or SCTRIG EXT1, a TTL-compatible pulse into the EXT0 or EXT 1 port, respectively, generates the scan trigger. For SCTRIG MEAS, EXT0, EXT1, or GPIO, the SCSLOPE command sets the direction (LH or HL) of the input which will generate the scan trigger. Refer to "Scan Trigger Slope (SCSLOPE)" for details on SCSLOPE.

NOTE

For the EXT0 port (only), TRIGOUT OFF must be set to enable EXT0 to receive a trigger. If TRIGOUT ON is set, the EXT0 port outputs trigger signals and no trigger source can be set to EXT0, Refer to "EXT0 Port Triggering (TRIGOUT)" for details.

SCTRIG GPIO

When SCTRIG GPIO is set, the scan trigger source is the GPIO port on the voltmeter rear panel. Refer to Chapter 7 - GPIO Operation for details on SCTRIG GPIO.

Scan Trigger Slope (SCSLOPE) For SCTRIG MEAS, SCTRIG EXT0, SCTRIG EXT1, or SCTRIG GPIO, the SCSLOPE *mode* [USE *ch*] command sets the edge (direction) of the input (LH or HL) which will generate a scan trigger. SCSLOPE LH sets low-to-high transitions (positive slope) while SCSLOPE HL sets high-to-low (negative slope) transitions. The power-on *mode* = LH. Note that CONF does not change the existing setting of SCSLOPE.

Scan Trigger Threshold (PERC) For SCTRIG MEAS, the voltmeter is triggered when the input signal on the first channel in the scan list reaches the percent of full-scale voltage set by PERC in the direction set by SCSLOPE.

NOTE

The PERC command sets both the scan trigger and stop trigger to the same threshold, so you cannot separate thresholds for these two triggers.

Threshold When Autoranging Not Used

The range of PERC is -128% to +127% of the full-scale range (resolution 1%) when autoranging is not used. Power-on PERC *threshold* value is 0% of full-scale range.

For example, with SCTRIG MEAS if the voltmeter is set for DC volts and the 10.24V range, PERC 67 sets $10.24 \times 0.67 = 6.86$ volts as the input signal level which will generate a trigger. SCSLOPE LH sets low-to-high transitions (positive slope) while SCSLOPE HL sets high-to-low transitions (negative slope).

Table 5-19 lists the minimum (-128%) and maximum (+127%) trigger thresholds allowable for the four voltmeter voltage ranges when autoranging is not used.

Table 5-19. Scan Trigger Threshold Levels (PERC)

Range	Trigger Threshold	
	min(-128%)	max (+127%)
40 mV	-0.0512 V	+0.0508 V
320 mV	-0.41 V	+0.406 V
2.56 V	-3.28 V	+3.25 V
10.24 V	-13.1 V	+13.0 V

Scan Trigger Threshold Sequence

When SCTRIG MEAS is executed, the first channel in the scan list is connected. When the input to the first channel in the scan list crosses the threshold in the proper direction, the scan trigger is generated. At the start of the second (and subsequent) passes through the scan list, the first channel is again connected and a 50 μ sec delay occurs before threshold monitoring begins.

Threshold When Autorange Is Used

If autoranging is used, the absolute trigger threshold value will change, based on the current range. Although the same percentage is used, since the full scale value is different for each range, a different absolute value results. Autoranging is not recommended for the first channel when SCTRIG MEAS is used. Therefore, the first channel in CLWRITE *ch_list* should use a fixed range or RANGE should be used.

If autoranging is selected, the voltmeter is triggered several times as part of the SCTRIG execution and selects the range for threshold triggering. This sets the range for the first channel in the scan list and is acceptable for the first pass. However, for subsequent passes the range that is used is the range of the last channel in the channel list. With autoranging, this can cause the voltmeter to generate a scan trigger for the second (and subsequent) passes with the wrong level of input.

For example, with (fixed) 10.24V range, SCTRIG MEAS, SCSLOPE LH, and PERC 30 set, the scan trigger is generated for each pass when the input to the first channel crosses 3.072 V in the positive direction. But, with autorange set the range selected for the last channel in the scan list might be the 2.56V range. In this case, the scan trigger for the second pass will be generated when the input to the first channel crosses 0.768 V ($2.56 \text{ v} \times 0.30$), rather than the desired 3.072 V.

Scan Trigger Delay (SCDELAY) SCDELAY *trig_delay* [*scan_pace*] [USE *ch*] sets the delay time between the scan trigger and enabling the first measurement in the scan list and sets the time between successive scan triggers.

NOTE

Due to hardware constraints, actual scan trigger timing may be slightly different than programmed time. Refer to "Measure Trigger Timing (SPER)" for details.

Set Scan Trigger Delay

As shown in Figure 5-8, when a scan trigger is generated SCDELAY *trig_delay* sets the time from the receipt of the scan trigger to when the first measure trigger is enabled on the first channel. (The measurement will be taken by the first measure trigger received after the measure trigger is enabled.) The SCDELAY *trig_delay* range is 0 to 0.01638375 sec with 0.25 μ sec resolution. At power-on, SCDELAY *trig_delay* = 0 sec. CONF sets 0.001 sec (0.006 sec for OHM1M or OHMF1M).

When ASCAN OFF is set, the SCDELAY *trig_delay* delay time occurs between the scan trigger and the first measurement for every pass through the scan list. With ASCAN ON, the delay is included between the scan trigger and the first measurement of the first pass only. Refer to "Autoscan Mode (ASCAN)" for an example.

Set Time Between Scan Triggers

When SCTRIG INT is set, SCDELAY [*scan_pace*] sets the time between scan passes. The SCDELAY [*scan_pace*] range is 0 to 1073.74182375 seconds with 0.25 μ sec resolution. At power-on, SCDELAY [*scan_pace*] = 2 msec.

For ASCAN OFF, a scan trigger is required to start each pass. For ASCAN ON, only a single scan trigger is required for the first pass and subsequent passes start automatically. For ASCAN OFF and SCTRIG INT, SCDELAY [*scan_pace*] sets the time between scan triggers (between scan passes).

NOTE

Due to hardware constraints, actual scan delay times may be slightly different than programmed times. Refer to "Measure Trigger Timing (SPER)" for details.

Autoscan Mode (ASCAN) ASCAN [*mode*] [USE *ch*] sets the voltmeter autoscan mode. As shown in Figure 5-8, a scan trigger starts the first scan pass. For ASCAN ON, a scan trigger is required for the first scan pass only and subsequent passes start automatically. With ASCAN OFF, a separate scan trigger is required for each pass. Power-on [*mode*] = OFF and default [*mode*] = ON. CONF sets ASCAN OFF.

Scan Trigger Delays vs. Autoscan

ASCAN can affect the delays set by the SCDELAY (scan trigger delay) command. Figure 5-12 shows example timing considerations for autoscan off (ASCAN OFF) and for autoscan on (ASCAN ON).

For this example, SCTRIG INT, TRIG INT, STTRIG EXT0, NRDGS 1, and three channels in the scan list are assumed, so the voltmeter makes three measurements on each pass (mt₁, mt₂, and mt₃). Since STTRIG EXT0 is set, the voltmeter makes continuous passes until a stop trigger (from the EXT0 port) is received.

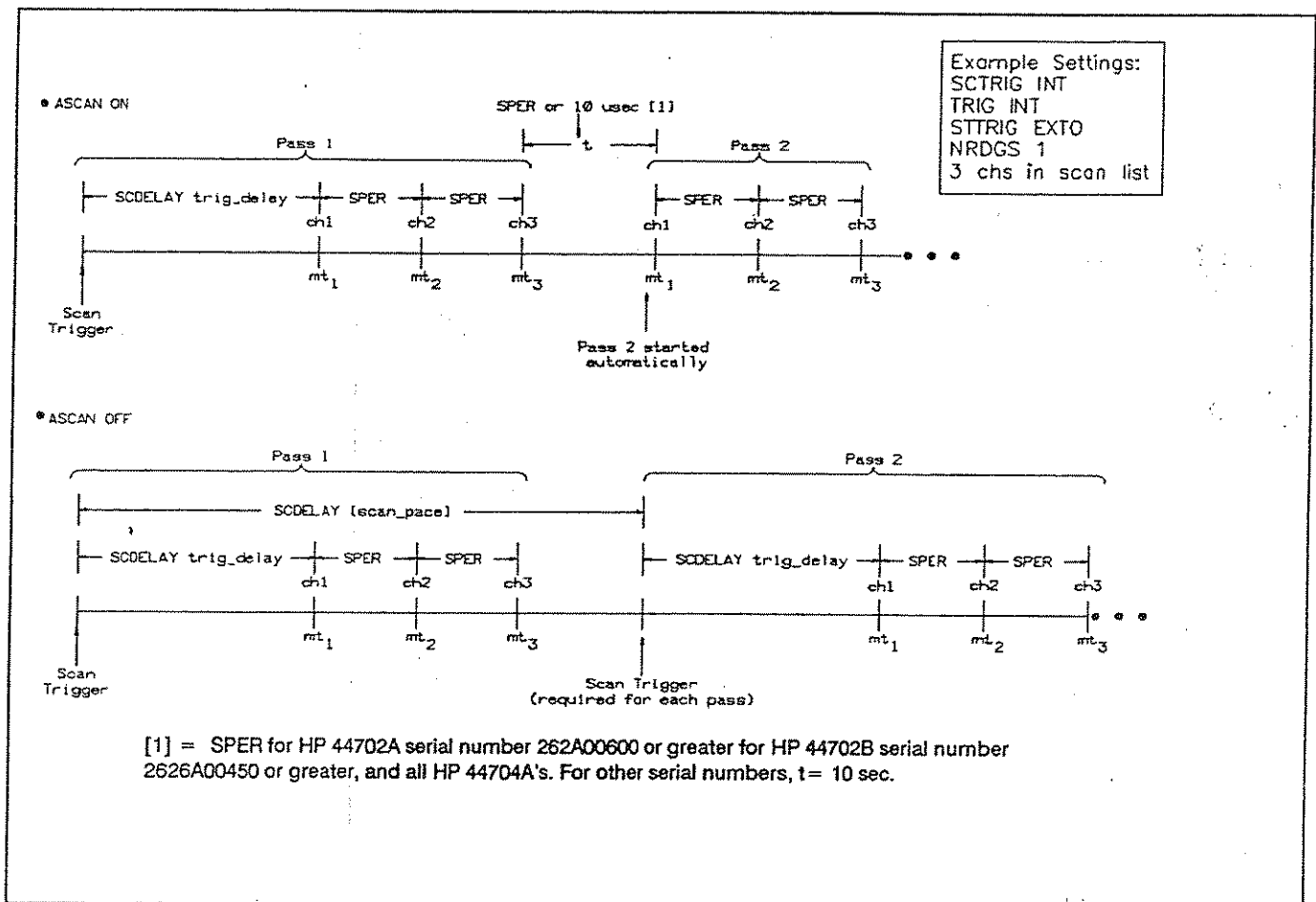

Figure 5-12. Scan Triggering vs. Autoscan Mode

● **ASCAN ON:**

With ASCAN ON, the delay time set by SCDELAY *trig_delay* occurs only on pass 1 between the start of the pass and the first measurement (mt_1). Since TRIG INT is set, SPER *sample_period* sets the time between measurements (mt_1 to mt_2 , etc.).

With ASCAN ON pass 2 and all subsequent passes start automatically. The time (t) between passes (from mt_3 in pass 1 to mt_1 in pass 2) is either 10 μ sec or is set by SPER *sample_period*, depending on the voltmeter serial number.

With ASCAN ON, for HP 44702As serial number 2626A00600 and higher, HP 44702Bs serial number 2626A00450 and higher, and all HP 44704As, the time is set by SPER. For earlier HP 44702A/B serial numbers, the time is fixed at 10 μ sec.

● **ASCAN OFF:**

With ASCAN OFF and SCTRIG INT set, SCDELAY [*scan_pace*] sets the time from the start of a pass to the start of the next pass. A scan trigger is required to start each pass when ASCAN OFF is set.

Also, the SCDELAY *trig_delay* time is inserted in each pass between the scan trigger and the first measurement (mt_1). As with ASCAN ON, the time between measurements is set with SPER *sample_period* since TRIG INT is set.

Example: Setting Scan Triggering

This example shows one way the SCTRIG, SCSLOPE, PERC and SCDELAY commands can be used to set scan triggering for the voltmeter. The program sets the scan trigger source to SCTRIG MEAS and generates a scan trigger when the input to channel 500 of an HP 44711A/B multiplexer crosses 3.072 V in the negative (high-to-low) direction.

The voltmeter is configured (by CONF) for one prescan pass and zero postscan passes. A single channel (channel 500) is to be measured, with 10 readings per channel. Maximum expected amplitude for channel 500 is 9 volts so RANGE 9 will be used to select the 10.24V range.

SPER .001 sets 1 msec between measurements (between measure triggers). SCDELAY 0 sets a zero time delay from the time the scan trigger is received until the first measure trigger is enabled.

Since SCTRIG MEAS and the 10.24V range are set, PERC 30 sets the voltmeter to generate a scan trigger at 3.072 V ($0.30 \times 10.24 \text{ V} = 3.072 \text{ V}$). SCSLOPE HL sets high-to-low slope, so the scan trigger is generated when the input to channel 500 crosses 3.072 V in the negative direction.

10 DIM Volts(0:9)	<i>! Dimension controller array</i>
20 OUTPUT 709;"USE 600"	<i>! Use voltmeter in slot 6</i>
30 OUTPUT 709;"SCANMODE ON"	<i>! Set Scanner Mode</i>
40 OUTPUT 709;"CONF DCV"	<i>! Set DC volts</i>
50 OUTPUT 709;"RANGE 9"	<i>! Set 10.24V range</i>
60 OUTPUT 709;"NRDGS 10"	<i>! Set 10 readings/channel</i>
70 OUTPUT 709;"PERC 30"	<i>! Set 3.072 V as threshold</i>
80 OUTPUT 709;"SCSLOPE HL"	<i>! Trigger on negative slope</i>
90 OUTPUT 709;"SPER .001"	<i>! Set 1 msec between meas triggers</i>
100 OUTPUT 709;"SCDELAY 0"	<i>! Set 0 msec scan trigger delay</i>
110 OUTPUT 709;"CLWRITE 500"	<i>! Set ch 500 as scan list</i>
120 OUTPUT 709;"SCTRIG MEAS"	<i>! Gen scan trigger on threshold</i>
130 OUTPUT 709;"XRDGS 600"	<i>! Read 10 readings</i>
140 ENTER 709;Volts(*)	<i>! Enter 10 readings</i>
150 PRINT USING "K,/";Volts(*)	<i>! Display 10 readings</i>
160 END	

For a decreasing ramp-type input connected to channel 500, a typical return (values in volts) is:

3.07
2.7725
2.4175
2.065
1.89
1.7125
1.5375
1.3
1.0075
.77

Setting Measure Triggering Guidelines to set measure trigger parameters follow, including measure trigger sources (TRIG), measure trigger slope (SLOPE), measure trigger timing (SPER), and EXT0 port trigger mode (TRIGOUT).

As shown in Figure 5-8, each measurement is initiated with a measure trigger (mt;). For NRDGS 1, the voltmeter makes one reading per channel for each channel in the channel list. For NRDGS >1, the voltmeter makes NRDGS readings for each channel in the channel list. If TRIG INT is set, SPER *sample_period* sets the time between measure triggers.

Measure triggers are disabled from the time a valid scan trigger is received until the time set by SCDELAY *trig_delay* expires and for 10 μ sec following the start of each measurement.

With ASCAN OFF, measure triggers are disabled from the end of a pass until the time set by SCDELAY *trig_delay* following the scan trigger expires. For example, in Figure 5-12, if ASCAN OFF is set the measure trigger is disabled from the time *mt₃* in pass 1 is generated until the SCDELAY *trig_delay* time for pass 1 expires.

Measure Trigger Source (TRIG) TRIG [*source*] [USE *ch*] sets the source or mode for the measure trigger. Power-on *source* is INT (internal trigger) and default *source* is SGL (single trigger). For Scanner Mode, CONF sets TRIG INT.

Although there are nine TRIG *source* parameters, TRIG MEAS is not valid for Scanner Mode measurements and TRIG SCAN is not normally used with ribbon cable mode. Table 5-20 summarizes TRIG *source* parameters normally used for ribbon cable operation.

Table 5-20. Measure Trigger (TRIG) Sources - Ribbon Cable

Source	Description
HOLD	No triggering. Triggering is disabled.
SGL	Single trigger from mainframe when command executed.
SYS	System trigger pulse (used with TRG).
INT	Voltmeter internal trigger.
EXT0	Trigger voltmeter from EXT0 port.
EXT1	Trigger voltmeter from EXT1 port.
GPIO	GPIO trigger.
Notes:	
* = TRIG SCAN not normally used in ribbon cable mode.	

TRIG HOLD

TRIG HOLD sets measure trigger hold (no triggering).

TRIG SGL

Use TRIG SGL for a single trigger from the mainframe which occurs when the command is executed. For TRIG SGL to be used during a scan sequence, TRIG SGL or TRIG HOLD must be set before setting SCTRIG to a source other than HOLD.

TRIG INT

With TRIG INT, the voltmeter pacer generates internal measure triggers as required. The internal pace time is set by SPER *sample_period*.

TRIG SYS

TRIG SYS is used along with the TRG command. As shown in Figure 5-11, TRG has four sources/modes: HOLD, GET, EXT, and SGL. Note that TRIG SYS must be set for the voltmeter to accept measure triggers from the TRG source. Refer to the HP 3852A Mainframe Configuration and Programming Manual for details on TRG.

TRIG EXT0/EXT1

With TRIG EXT0 or TRIG EXT1, a TTL-compatible pulse into the EXT0 or EXT 1 port, respectively, generates a measure trigger. SLOPE sets the direction (LH or HL) of the input which will generate the measure trigger. Refer to "Measure Trigger Slope (SLOPE)" for details on SLOPE.

NOTE

For the EXT0 port (only), TRIGOUT OFF must be set to enable EXT0 to receive a trigger. If TRIGOUT ON is set, the EXT0 port outputs trigger signals and no trigger source can be set to EXT0, Refer to "EXT0 Port Triggering (TRIGOUT)" for details.

TRIG GPIO

When TRIG GPIO is set, the measure trigger source is the GPIO port on the voltmeter rear panel. Refer to Chapter 7 - GPIO Operation for details on TRIG GPIO.

Measure Trigger Slope (SLOPE) For TRIG EXT0, TRIG EXT1, or TRIG GPIO, the SLOPE *mode* [USE *ch*] command sets the edge (direction) of the input (LH or HL) which will generate a measure trigger. SLOPE LH sets low-to-high transitions (positive slope) while SLOPE HL sets high-to-low (negative slope) transitions. The power-on *mode* = LH. Note that CONF does not affect the current setting of SLOPE.

Measure Trigger Timing (SPER) As shown in Figure 5-8, when TRIG INT is set, SPER *sample_period* [USE *ch*] sets the time in seconds between the start of successive measure triggers (mt_1 to mt_2 etc.). SPER *sample_period* range is 0 to 1073.74182375 sec, with resolution = 0.25 μ sec. SPER *sample_period* settings from 0 to 10 μ sec are rounded to 10 μ sec. CONF sets 0.001 sec SPER *sample_period* (0.006 sec for OHM1M or OHMF1M).

With ASCAN OFF, the time between scan passes is set by SPER for HP 44702As with serial number 2626A00600 and higher, HP 44702Bs with serial number 2626A00450 and higher, and for all HP 44704As. For HP 44702A/Bs with earlier serial numbers, the time is fixed at 10 μ sec.

Measure Trigger Timing Accuracy

Due to inherent hardware delays, actual measurement times may be different than programmed times. Although inaccuracies can apply to the scan, measure, and stop triggers, measurement trigger timing accuracy will be discussed here. You can then apply the same criteria for the scan and stop trigger as required.

- Net Measurement Delay:

As shown in Figure 5-13, the voltmeter has hardware delays for both front end and triggering circuitry. The Front End delay (Δ_A) caused by the voltmeter front end circuitry shifts the output from the input.

In addition, there is a Trigger delay (Δ_T) caused by the hardware which generates the trigger. The result is that the actual measurement can occur at a point on the input before or after the desired measurement point. The Net Delay (in nsec) = $\Delta_T - \Delta_A$.

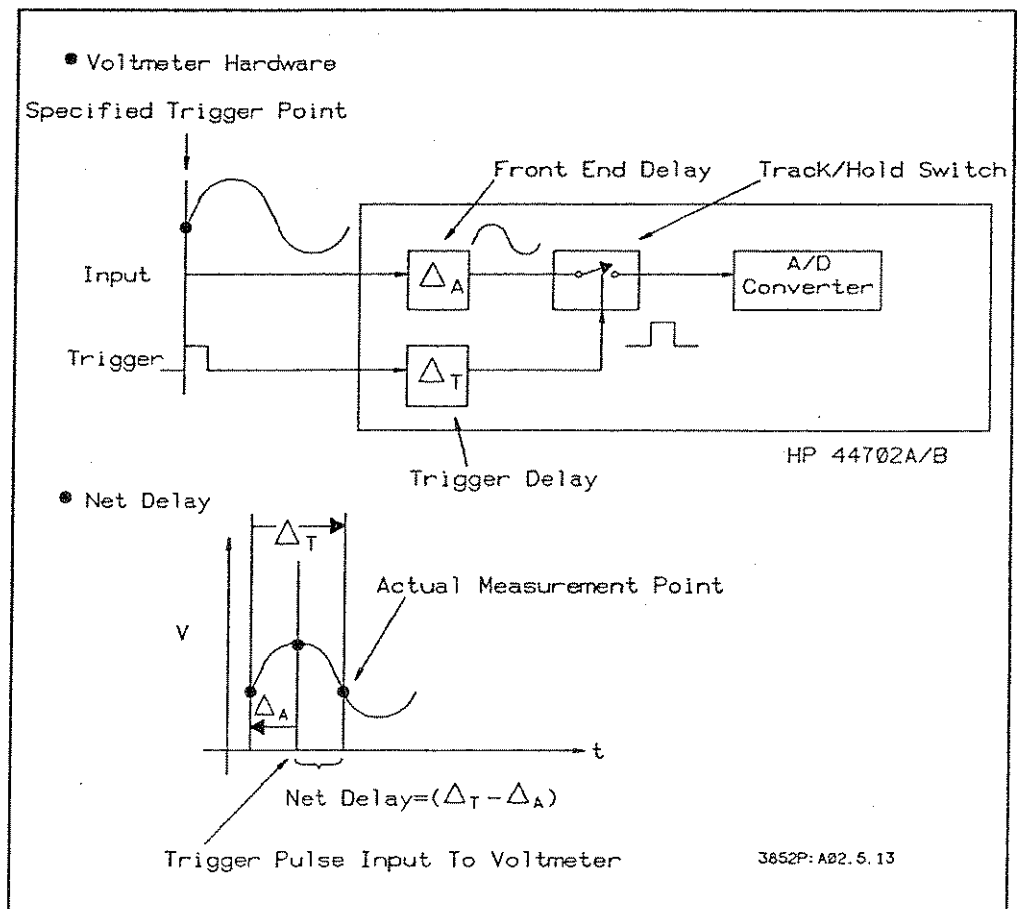

Figure 5-13. Front End and Trigger Delays

● Front End Delay:

The Front End delay (Δ_A) depends on the ARMODE setting and the voltmeter range as shown in Table 5-21.

Table 5-21. Front End Delays vs. Range/Autorange Mode

Range	Front End Delay (nsec)	
	ARMODE BEFORE	ARMODE AFTER
40 mV	500 \pm 2	498 to 585
320 mV	400 \pm 2	393 to 485
2.56 V	200 \pm 2	198 to 235
10.24 V	200 \pm 2	198 to 235

● Trigger delay:

To determine the trigger delay (Δ_T) for a set of input/trigger conditions, see Figure 5-14 which shows the range of delay times with various conditions set for the scan trigger, measure trigger, and stop trigger.

For example, assume SCTRIG MEAS, TRIG INT, STTRIG EXT0, the 2.56V range, ARMODE BEFORE, SPER .001 and SCDELAY 0, 0 are set. From Table 5-21 with ARMODE BEFORE and the 2.56V range, the Front End delay = (Δ_A) = 200 nsec \pm 2 nsec.

For these settings, the trigger delay path in Figure 5-14 is from H to K, K to C, C to D, D to E, and E to F. Since SCDELAY is 0 and SCTRIG INT is not set, the delay path bypasses the Scan Delay. Since SPER is not 0 and TRIG INT is set, the path is via the Measurement Pacer which adds 510 to 760 nsec.

Adding the delay times for these path segments gives the Trigger delay (Δ_T) range as 510 nsec to 915 nsec. Since the Front End Delay (Δ_A) = 200 \pm 2 nsec, the Net Delay range = 308 to 717 nsec. That is, for the settings in this example the first measure trigger can occur from 308 to 717 nsec after the scan trigger is received.

EXT0 Port Triggering
(TRIGOUT)

TRIGOUT [mode] [USE ch] sets whether or not the EXT0 port on the voltmeter rear panel will function as a trigger source. When enabled (TRIGOUT ON), the EXT0 port outputs a trigger signal that can be used to trigger other HP 44702A/B or HP 44704A voltmeters. When disabled (TRIGOUT OFF), the EXT0 port is set to receive trigger signals. When TRIGOUT ON is set, no trigger source (TRIG, SCTRIG, or STTRIG) can be set to EXT0 and vice versa.

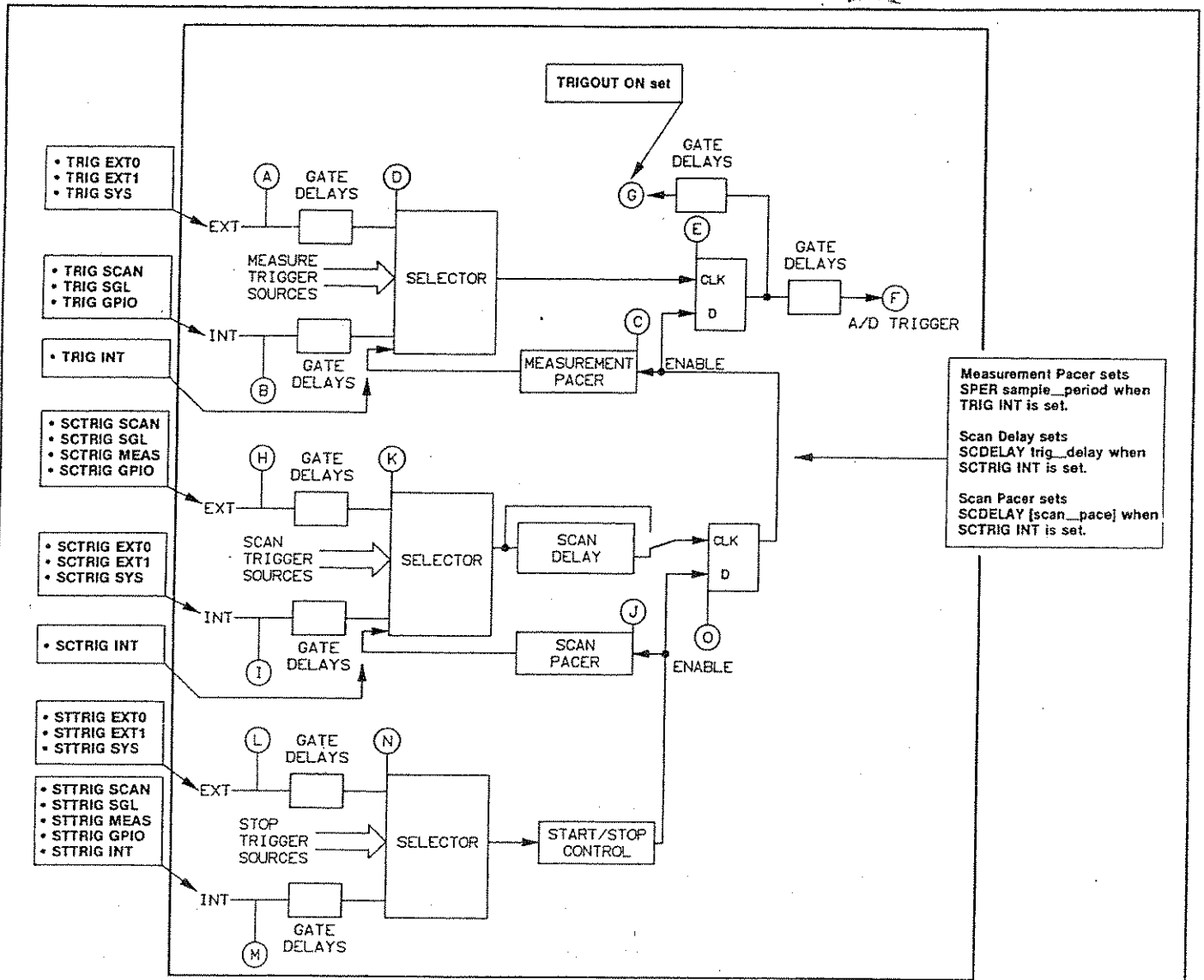

TRIGGER DELAY TIMES: (Δ_p)

(A) TO (D), (H) TO (K), (L) TO (N)	= 0 to 30 nsec
(B) TO (D), (I) TO (K), (M) TO (N)	= 0 to 20 nsec
(D) TO (E)	= 0 to 25 nsec
(E) TO (G)	= 0 to 27 nsec
(E) TO (F), (N) TO (J), (N) TO (O)	= 0 to 50 nsec
(C) TO (D), (J) TO (K)	= 510 to 760 nsec
(K) TO (C), (K) TO (E)	= 0 to 50 nsec or -45 ± 125 nsec [1]

[1] = 0 to 50 nsec for SCDelay trig_delay = 0 or
= -45 nsec ± 125 nsec for SCDelay trig_delay ≠ 0.

3852P: A02.5.14

Figure 5-14. Voltmeter Trigger Timing

When TRIGOUT ON is set, the trigger signal output from EXT0 is the same measure trigger the voltmeter received. The signal is a negative-going pulse and is a valid measure trigger so any other HP 44702A/B or HP 44704A voltmeter which receives the signal can be triggered to make a measurement, depending on the second voltmeter configuration.

A typical application for the TRIGOUT command is to synchronize the operation of two or more high-speed voltmeters. Refer to "Example: Synchronize Multiple Voltmeters" in "Measurement Examples" for one way to use TRIGOUT.

Example: Setting Measure Trigger

This example shows one way SCDELAY and SPER can be used to set measure trigger timing. The voltmeter is configured for ASCAN OFF (set with CONF), PRESCAN 1, POSTSCAN 1, and NRDGS 2. Channels 500-504 are to be measured, so a total of 20 readings will be made (one prescan and one postscan).

With ASCAN OFF a separate scan trigger is required for each pass and a 10 msec scan trigger delay (as set with SCDELAY *trig_delay*) is inserted into the start of each pass. SPER 0.001 sets 1 msec between measure triggers.

Thus, with NRDGS 2 and 5 channels, the time for pass 1 = 10 msec (scan trigger delay) + 9 msec (to make measurements 1 through 10) + 19 μ sec (to complete last channel measurement with ARMODE AFTER set) = 0.019019 seconds.

Since SCDELAY [*scan_pace*] sets 1 second between scan passes, the total measurement time = 1 sec (start of pass 1 to start of pass 2) + 0.019019 sec (to complete pass 2) = 1.019019 seconds (plus some time for the voltmeter microprocessor to signal end of scan).

10 DIM Volts(0:19)	<i>! Dimension controller array</i>
20 OUTPUT 709;"USE 600"	<i>! Use voltmeter in mainframe slot 6</i>
30 OUTPUT 709;"SCANMODE ON"	<i>! Set Scanner Mode</i>
40 OUTPUT 709;"CONF DCV"	<i>! Set DC volts</i>
50 OUTPUT 709;"RANGE 9"	<i>! Set 10.24V range</i>
60 OUTPUT 709;"NRDGS 2"	<i>! Set 2 readings/channel</i>
70 OUTPUT 709;"SPER .001"	<i>! Set 1 msec between triggers</i>
80 OUTPUT 709;"SCDELAY .01,1"	<i>! 10 msec trig delay, 1 sec pace</i>
90 OUTPUT 709;"PRESCAN 1"	<i>! Make 1 prescan pass</i>
100 OUTPUT 709;"POSTSCAN 1"	<i>! Make 1 postscan pass</i>
110 OUTPUT 709;"CLWRITE 500-504"	<i>! Set ch 500-504 as scan list</i>
120 OUTPUT 709;"SCTRIG INT"	<i>! Internal scan trigger source</i>
130 OUTPUT 709;"XRDGS 600"	<i>! Read 20 readings</i>
140 ENTER 709;Volts(*)	<i>! Enter 20 readings</i>
150 PRINT USING "K,/";Volts(*)	<i>! Display 20 readings</i>
160 END	

For a set of 9V 5% sources connected to channels 500-504, a typical return (value in volts) is:

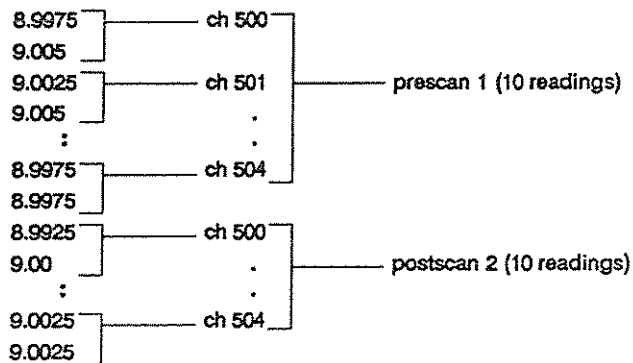

Setting Stop Triggering Guidelines to set stop trigger parameters follow, including stop trigger sources (STTRIG), stop trigger slope (STSLOPE), and stop trigger threshold (PERC).

NOTE

If PRESCAN 0 is set, the stop trigger is enabled when the scan is enabled. Thus, if the stop trigger is received before the scan trigger is received, the voltmeter starts the postscan operation. If POSTSCAN 0 is also set, it is possible for no measurements to be taken, even of SCTRIG INT or SCTRIG SGL is set.

Stop Trigger Source (STTRIG) STTRIG [source] [USE ch] sets the source or mode for the stop trigger. When the stop trigger is received the voltmeter completes the pass in progress and then makes m postscan passes (as set with POSTSCAN) to end the scan sequence. Note that any stop triggers which occur before the nth prescan pass (as set with PRESCAN) are ignored.

Although there are nine STTRIG source parameters, STTRIG SCAN is not normally used for ribbon cable mode. Table 5-22 summarizes STTRIG source parameters normally used for ribbon cable operation.

Table 5-22. Stop Trigger (STTRIG) Sources - Ribbon Cable

Source*	Description
HOLD	No triggering. Triggering is held off.
SGL	Single trigger from mainframe when command executed.
SYS	System trigger pulse (used with TRG).
INT	Voltmeter internal trigger.
MEAS	Trigger when input crosses threshold (used with PERC).
EXT0	Trigger voltmeter from EXT0 port.
EXT1	Trigger voltmeter from EXT1 port.
GPIO	GPIO trigger.
Notes:	
* = SCAN not normally used with ribbon cable mode.	

STTRIG HOLD

STTRIG HOLD set stop triggering to hold (no stop trigger) and is useful for applications such as continuous data acquisition. Refer to "Example: Continuous Data Acquisition" in "Measurement Example" for an example program.

STTRIG SGL

Use STTRIG SGL for a single trigger from the mainframe which occurs when the command is executed. STTRIG SGL or STTRIG HOLD must be set prior to setting SCTRIG to a source other than HOLD for STTRIG SGL to be used during the scan sequence.

STTRIG SYS

STTRIG SYS is used along with the TRG command. As shown in Figure 5-11, TRG has four sources/modes: HOLD, GET, EXT, and SGL. Note that STTRIG SYS must be set for the voltmeter to accept a stop trigger from the TRG source. Refer to the HP 3852A Mainframe Configuration and Programming Manual for details on TRG.

STTRIG INT

With STTRIG INT, the voltmeter internal pacer generates a stop trigger as required at the end of the nth prescan pass. Thus, with PRESCAN 0 set, one pass must be made for a stop trigger to be generated. (If RDGSMODE COMPLETE is set, the data from this pass is discarded.)

STTRIG EXT0/EXT1

For STTRIG EXT0 or STTRIG EXT 1, a TTL-compatible pulse into the EXT0 or EXT1 port, respectively, generates a stop trigger. For STTRIG MEAS, EXT0, EXT1, or GPIO, the STSLOPE command sets the direction (LH or HL) of the input which will generate a stop trigger. Refer to "Stop Trigger Slope (STSLOPE)" for details on the STSLOPE command.

NOTE

For the EXT0 port (only), TRIGOUT OFF must be set to enable EXT0 to receive a trigger. If TRIGOUT ON is set, the EXT0 port outputs trigger signals and no trigger source can be set to EXT0, Refer to "EXT0 Port Triggering (TRIGOUT)" for details.

STTRIG MEAS

STTRIG MEAS generates a stop trigger when the input to the voltmeter crosses a threshold level (percent of full-scale value) as set with the PERC command in the direction (HL or LH) set by the STSLOPE command.

When STTRIG MEAS is set, a minimum of two passes through the scan list is required to generate a stop trigger. Each time the measure trigger for the first channel in the scan list is received, the state of an internal analog comparator is latched. When the output of the comparator makes the transition set by STSLOPE, a stop trigger is generated.

Since the latch is preset high for STSLOPE LH and low for STSLOPE HL, a minimum of two passes through the scan list is required to generate a stop trigger when STTRIG MEAS is set. For example, the first pass could set the latch low and the second pass could set the latch back high to generate the LH transition.

STTRIG GPIO

When STTRIG GPIO is set, the stop trigger source is the GPIO port on the voltmeter rear panel. Refer to Chapter 7 - GPIO Operation for details on STTRIG GPIO.

- Stop Trigger Slope (STSLOPE)** For STTRIG MEAS, STTRIG EXT0, STTRIG EXT1, or STTRIG GPIO, the STSLOPE *mode* [USE *ch*] command sets the edge (direction) of the input (LH or HL) which will generate the stop trigger. STSLOPE LH sets low-to-high transitions (positive slope) while STSLOPE HL sets high-to-low (negative slope) transitions. The power-on *mode* = LH.
- Stop Trigger Threshold (PERC)** For STTRIG MEAS, the voltmeter is triggered when the input signal on the first channel in the scan list reaches the percent of full-scale voltage set by PERC in the direction set by STSLOPE.

NOTE

1. The PERC command sets both the scan trigger and stop trigger to the same threshold, so you cannot set separate thresholds for these two triggers.
 2. When STTRIG MEAS is set, a minimum of two passes through the scan list is required to generate a stop trigger. Refer to "Stop Trigger Source (STTRIG)" for details.
-

Threshold When Autoranging Not Used

The range of the PERC *threshold* parameter is -128% to +127% of the full-scale range (resolution 1%) when autoranging is not used. Power-on PERC *threshold* value is 0% of full-scale range.

For example, with STTRIG MEAS if the voltmeter is set for DC volts and the 10.24V range, PERC 67 sets $10.24 \times 0.67 = 6.86$ volts as the input signal level which will generate a trigger. STSLOPE LH sets low-to-high transitions (positive slope) while STSLOPE HL sets high-to-low transitions (negative slope).

Table 5-23 lists the minimum (-128%) and maximum (+127%) trigger thresholds allowable for the four voltmeter voltage ranges when autoranging is not used.

Table 5-23. Stop Trigger Threshold Levels (PERC)

Range	Trigger Threshold	
	min(-128%)	max (+127%)
40 mV	-0.0512 V	+0.0508 V
320 mV	-0.41 V	+0.406 V
2.56 V	-3.28 V	+3.25 V
10.24 V	-13.1 V	+13.0 V

Stop Trigger Threshold Sequence

As noted (see STTRIG MEAS), each time the measure trigger is received on the first channel in the scan list, the state of an analog comparator is latched. When the output of the latch makes the transition (LH or HL) specified by STSLOPE, the stop trigger is generated. Since the latch is preset high for STSLOPE LH and low for STSLOPE HL, a minimum of two passes through the scan list is required to generate a stop trigger when STTRIG MEAS is used.

For example, with STSLOPE LH the first pass could set the latch from high to low and the second pass could set the latch back high, thus generating the stop trigger on the LH transition. Because the input is sampled and not continuously monitored, if the input crosses the threshold and returns to its original value between samples, no stop trigger will be generated. Therefore, for proper stop trigger operation when threshold triggering is used, the period of the input signal must be greater than the time required for one pass through the scan list.

Threshold When Autorange Is Used

If autoranging is used, the absolute trigger threshold value will change, based on the current range. Although the same percentage is used, since the full scale value is different for each range, a different absolute value results. Autoranging is not recommended for the first channel when STTRIG MEAS is used. Therefore, the first channel in the CLWRITE *ch_list* should use a fixed range or RANGE should be used.

If autorange is used, the stop trigger may be generated on an undesired input threshold. With autorange, the range selected for the first channel in the scan list may or may not be the desired range. For example, suppose you want the stop trigger to be generated when the input crosses 30% of the 10.24 V range (3.072 V).

With autoranging selected the voltmeter may select any of the four ranges, depending on the input signal level. For example, if the 2.56V range is selected and PERC 30 is set the stop trigger will be generated when the input level reaches 0.768 V rather than the 3.072 V desired. To avoid this problem, use a fixed range for the first channel in CLWRITE *ch_list* or use the RANGE command.

Example: Setting Stop Trigger

For this example, we want to measure the data from the last two prescans before the stop trigger is accepted. To do this, the stop trigger source will be set to STTRIG EXT0. The voltmeter is set for PRESCAN 2 and POSTSCAN 0. Channels 500-509 are to be measured with one reading per channel and SCDELAY [*scan_pace*] is set for 1 second. That is, the time between the start of each scan pass is 1 second.

With these settings, the voltmeter continuously makes prescan passes until the stop trigger is accepted. For PRESCAN 2, the stop trigger will not be enabled until the second prescan pass. Since RDGSMODE COMPLETE is set, the data stored in the voltmeter data buffer will be trimmed to that received from the last two prescans before the stop trigger. Refer to "Readings Storage Mode (RDGSMODE)" for details on the RDGSMODE command.

For this program, a stop trigger received before the second prescan pass will be ignored, a stop trigger received on the second pass will be accepted at the end of the second pass, and a stop trigger received after the third pass will be accepted at the end of that pass.

For example, a stop trigger received at $t = 1$ second (at the end of the first prescan pass) will be ignored and the voltmeter will continue to make scan passes until another stop trigger is received and accepted. For a trigger received at $1 < t \leq 2$ seconds (during the second prescan pass), the program returns the data from the first two prescans. Or, for a trigger received at $99 < t \leq 100$ seconds, the program returns the data from the 99th and 100th prescan passes.

10 DIM Volts(0:19)	<i>! Dimension controller array</i>
20 OUTPUT 709;"USE 600"	<i>! Use voltmeter in MF slot 6</i>
30 OUTPUT 709;"SCANMODE ON"	<i>! Set Scanner Mode</i>
40 OUTPUT 709;"CONF DCV"	<i>! Set DC volts</i>
50 OUTPUT 709;"RANGE 9"	<i>! Set 10.24V range</i>
60 OUTPUT 709;"RDGSMODE COMPLETE"	<i>! Trim data to (PRESCAN + POSTSCAN) passes</i>
70 OUTPUT 709;"SCDELAY 0,1"	<i>! 0 msec scan trig delay, 1 sec scan pace</i>
80 OUTPUT 709;"PRESCAN 2"	<i>! Make 2 prescan passes</i>
90 OUTPUT 709;"POSTSCAN 0"	<i>! Make 0 postscan passes</i>
100 OUTPUT 709;"CLWRITE 500-509"	<i>! Set ch 500-509 as scan list</i>
110 OUTPUT 709;"STTRIG EXT0"	<i>! Set EXT0 port as stop trigger source</i>
120 OUTPUT 709;"SCTRIG INT"	<i>! Internal scan trigger</i>
130 OUTPUT 709;"XRDGS 600"	<i>! Read last 2 prescans before stop trig</i>
140 INTER 709;Volts(*)	<i>! Enter last 2 prescans</i>
150 PRINT USING "K, /";Volts(*)	<i>! Display last 2 prescans</i>
160 END	

If the stop trigger is received at $t = 4.5$ seconds (during prescan pass 5), the data from prescans 4 and 5 is returned. A typical return for a set of 9V 5% sources on channels 500-509 (values in volts) is:

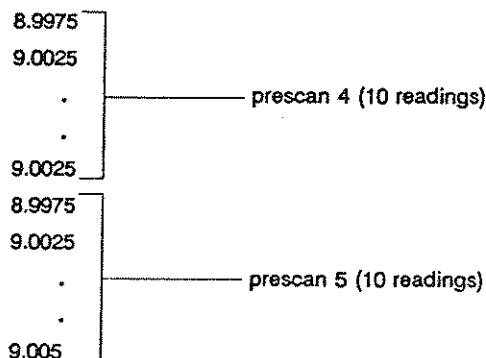

Selecting Data Transfers/Interrupts

Guidelines follow to select data destination and storage modes, to transfer readings, and to enable voltmeter interrupts. Refer to the HP 3852A Mainframe Configuration and Programming Manual for additional details on data transfers and interrupt handling.

As shown in Figure 5-15, readings stored in the voltmeter data buffer can be transferred to the controller, to mainframe memory, or to the GPIO port. Maximum transfer rate to an HP Series 200/300 controller is about 35,000 readings/second when the transfer is over HP-IB (via the mainframe memory). Maximum transfer rate to the mainframe memory is 90,000 readings/second while maximum transfer rate to the controller via the GPIO port is 100,000 readings/second.

NOTE

This chapter does not discuss GPIO transfers. Refer to Chapter 7 - GPIO Operation for details on GPIO transfers.

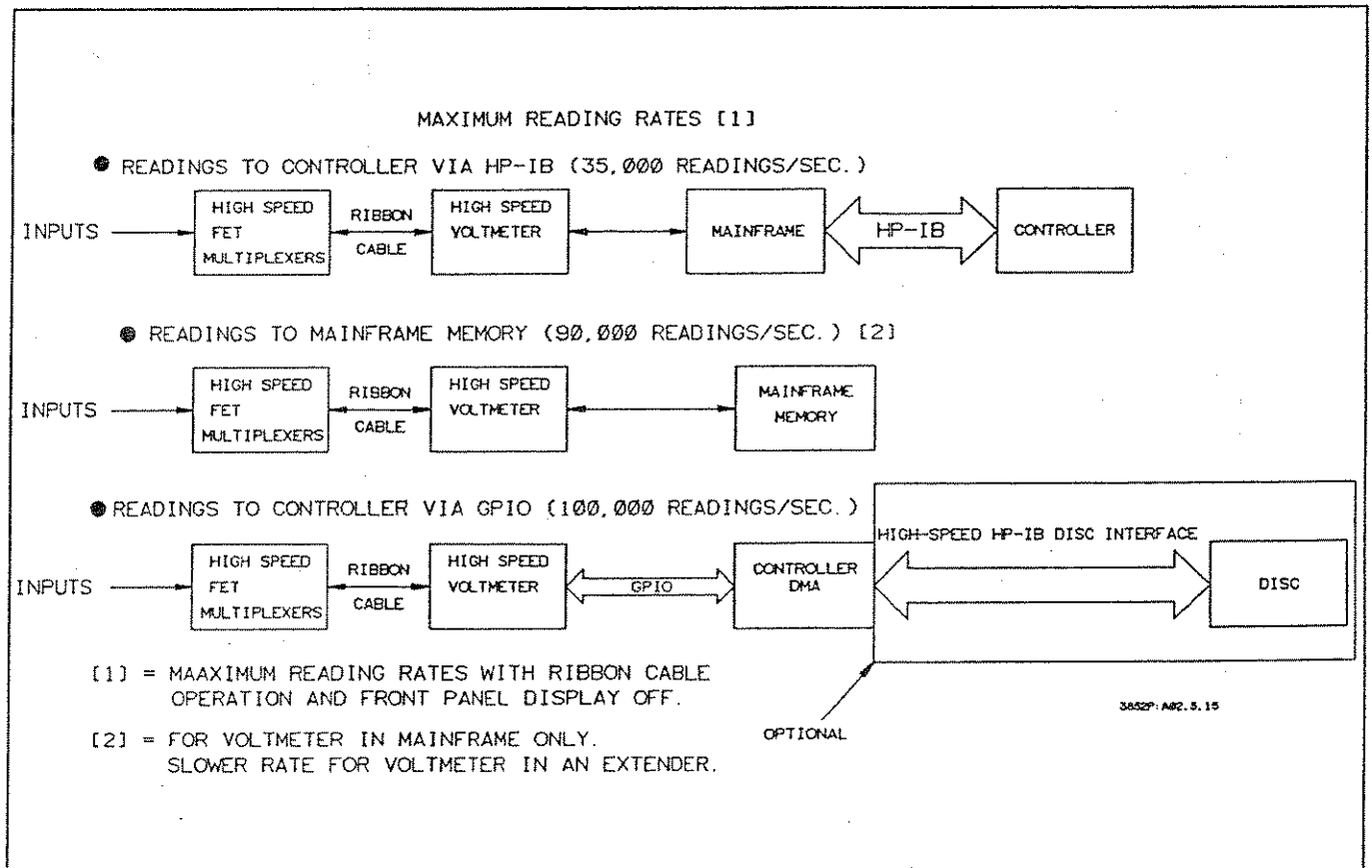

Figure 5-15. Maximum Data Transfer Rates

Readings Destination (RDGS) *RDGS dest [USE ch]* sets the destination for readings stored in the voltmeter data buffer and for voltmeter interrupt signals. *RDGS SYS* sets the mainframe as the destination, while *RDGS GPIO* sets the GPIO port. Power-on and default mode is *RDGS SYS*.

With *RDGS SYS*, measurement data is sent to mainframe memory or to the output buffer/display as specified by a read command (*CHREAD*, *CONFMEAS*, *MEAS*, or *XRDGS*). With *RDGS GPIO*, *CHREAD* and *XRDGS* are not allowed and voltmeter interrupts are sent **ONLY** to the GPIO port.

NOTE

1. *RDGS SYS* is set for all examples in this chapter. Refer to Chapter 7 - GPIO Operation for operation with *RDGS GPIO*.
2. Since changing *RDGS* disables all voltmeter interrupts, voltmeter interrupts must be enabled (with *ENABLE INTR*) after setting *RDGS*.

Readings Storage Mode (RDGSMODE) All measurements made by the voltmeter are first stored in the voltmeter data buffer and remain in the buffer until read by a *CONFMEAS*, *MEAS*, *CHREAD*, or *XRDGS* command (when *RDGS SYS* is set) or when destroyed by most other voltmeter commands. Data stored in the voltmeter buffer can be read only when a "data is available" condition exists, as defined by *RDGSMODE*. The *RDGSMODE* command affects three areas of voltmeter operation:

- When measurement data becomes available.
- If measurement data overwrites in the data buffer.
- When an interrupt (if enabled) is generated.

RDGSMODE has four modes (*DAV*, *BURST*, *END*, and *COMPLETE*) and sets both data and interrupt conditions for the voltmeter, as described in the following paragraphs and summarized in Table 5-24 (also see Figure 5-7).

NOTE

Since changing *RDGSMODE* disables all voltmeter interrupts, set *RDGSMODE* before enabling interrupts with *ENABLE INTR*.

RDGSMODE DAV

Data is available when any reading is stored in the voltmeter data buffer. If the buffer fills, the scan sequence is aborted. However, data in the buffer when it

fills (8,192 readings for an HP 44702A or 65,536 readings for an HP 44702B or HP 44704A) remains valid and is readable.

If an interrupt is enabled with **ENABLE INTR**, an interrupt is generated whenever there are any measurements in the buffer. **DISABLE INTR** disables but does not clear the interrupt. (**DISABLE INTR** is done implicitly by the mainframe as part of the servicing routine).

RDGSMODE BURST

Data is available when the voltmeter data buffer has room for only 4,096 more readings or at the end of a scan sequence. The scan sequence is aborted if the buffer fills. However, data already in the buffer when it fills remains valid and is readable.

If enabled, an interrupt is generated when the buffer has room for only 4,096 more readings or at the end of a scan sequence. **DISABLE INTR** disables the interrupt. If the scan sequence is still in progress and the buffer has room for more than 4,096 readings (due to some measurements having been read by **CHREAD** or **XRDGS**), **DISABLE INTR** will also clear the interrupt. (**DISABLE INTR** is done implicitly by the mainframe as part of the interrupt service).

RDGSMODE END

Data is available when any reading is stored in the voltmeter data buffer. The scan sequence is aborted if the buffer fills but data in the buffer when it fills remains valid and is readable.

An interrupt, if enabled, is generated **ONLY** at the end of a scan sequence. **DISABLE INTR** disables and clears the interrupt. (**DISABLE INTR** is done implicitly by the mainframe as part of the interrupt service).

RDGSMODE COMPLETE

Data is available **ONLY** at the end of the scan sequence. In contrast to the other three modes, the scan sequence does not stop if the voltmeter data buffer fills (data is overwritten). For example, with an HP 44702B or HP 44704A if the scan sequence generates 65,537 readings and **RDGSMODE COMPLETE** is set, data from reading 65,537 overwrites the previously stored data from reading 1.

For RDGSMODE COMPLETE, data in the buffer is trimmed to exactly (PRESCAN + POSTSCAN) scan passes if the data will all fit in the buffer. If the data will not all fit, the last buffer load of data taken is stored (the last 8,192 readings for an HP 44702A or the last 65,536 readings for the HP 44702B or HP 44704A).

Interrupts, when enabled, are generated ONLY at the end of the scan sequence. DISABLE INTR disables and clears the interrupt. (DISABLE INTR is done implicitly by the mainframe as part of the interrupt service.)

Table 5-24. RDGSMODE Data/Interrupt Conditions

Mode	Measurement Data			Interrupts [1]	
	Data Available	Data Over-write?	Scan Aborts?	When Generated	Intr Cleared by DISABLE INTR? [2]
DAV	When any reading is in the buffer	No	Yes - when buffer fills	When any reading is in buffer	May [3]
BURST,	Buffer is 4,096 rdgs from full -or- scan ends	No	Yes - when buffer fills	Buffer is 4,096 rdgs from full -or- NRDGS rdgs after trig	May [4]
END	When any reading is in buffer	No	Yes - when buffer fills	At end of NRDGS rdgs after trig	Yes
COMPLETE	At end of scan ONLY	Yes	No	At end of NRDGS rdgs after trig	Yes

Notes:
 [1] = Assumes interrupt enabled by ENABLE INTR.
 [2] = DISABLE INTR done by mainframe as part of interrupt service.
 [3] = If no readings are left in the buffer.
 [4] = If scan still in progress or if buffer has room for more than 4,096 readings (due to read by CHREAD or XRDGS)

Transferring Readings Guidelines to transfer readings from the voltmeter data buffer to the mainframe or to the controller follow. Refer to the HP 3852A Mainframe Configuration and Programming Manual for additional details on data transfer methods.

Transfer Single Reading (CHREAD)

When MEAS (or CONFMEAS) is not used, readings stored in the voltmeter data buffer can be transferred to the mainframe memory or the output buffer and/or display one at a time with CHREAD *ch* [INTO *name*] or [*fmt*]. CHREAD with INTO *name* transfers data to mainframe memory into a variable or array previously defined with DIM, REAL, INTEGER, or PACKED. (Use VREAD to transfer data stored in mainframe memory to the output buffer and/or display.)

CHREAD *ch* [*fmt*] transfers one reading from the voltmeter buffer to the output buffer/display in the format specified by *fmt*. If neither INTO *name* or *fmt* is used, data is returned in default format to where the command originated.

To transfer a reading, data must be stored in the voltmeter buffer and data must be available (as defined by RDGSMODE). If a reading is not available when CHREAD is executed, CHREAD waits until the reading is available and the mainframe remains busy.

NOTE

1. When CONFMEAS or MEAS is used, CHREAD is not required (and will not work) since these commands automatically transfer the data to the mainframe memory or output buffer/display as part of the command sequence.
2. Any programming command except ENABLE INTR or DISABLE INTR clears the voltmeter buffer. This guarantees that any data returned by CHREAD (or XRDGS) reflects the current programmed state.

Transfer Multiple Readings (XRDGS)

When CONFMEAS or MEAS is not used, use XRDGS *ch* [*number*] [INTO *name*] or [*fmt*] to transfer multiple readings to the mainframe memory or to the output buffer/display. XRDGS with INTO *name* transfers data to the mainframe memory, while XRDGS without INTO *name* transfers data to the output buffer and/or display. (Use VREAD to read data from mainframe memory to the output buffer and/or display.)

XRDGS *ch* [*number*] [*fmt*] transfers multiple readings to the output buffer/display in the format specified by *fmt*, where *number* is the number of readings to be transferred. The range of *number* is 1 to 2,147,483,647.

If *number* is specified, XRDGS transfers any reading which is available until the specified number of readings have been transferred. If *number* is not specified, the mainframe waits until the scan sequence completes, determines how many readings are stored, and then transfers all readings.

For example, XRDGS 600,100 transfers 100 readings from a voltmeter in slot 6 of the mainframe to the output buffer/display (one at a time) as the readings become available. However, XRDGS 600 (*number not specified*) waits until all readings are available, determines the number of readings, and then transfers all readings.

NOTE

1. When CONFMEAS or MEAS is used, CHREAD is not required (and will not work) since these commands automatically transfer the data to the mainframe memory or output buffer/display as part of the command sequence.

2. Any programming command except ENABLE INTR or DISABLE INTR clears the voltmeter buffer. This guarantees that any data returned by CHREAD (or XRDGS) reflects the current programmed state.

3. Potential Mainframe/Controller Deadlock. With INBUF OFF, the controller and the HP 3852A may deadlock if multiple commands are sent in a single command line and a command generates enough data to fill the output buffer (XRDGS can fill the output buffer).

The best way to avoid potential deadlock is to send a single command per command line and read the results as soon as possible after the data-generating command is sent. Refer to Chapter 5 in the HP 3852A Mainframe Configuration and Programming Manual for details on potential deadlock.

Setting Interrupts Guidelines to enable voltmeter interrupts follow. Refer to the HP 3852A Mainframe Configuration and Programming Manual for additional details on interrupt handling.

Enabling Interrupts (ENABLE INTR) At power-on or when MEAS or CONFMEAS is used, voltmeter interrupts are disabled. However, you can enable interrupts by using the ENABLE INTR command. When enabled, the voltmeter generates an interrupt when data is available (as defined by RDGSMODE).

NOTE

1. Voltmeter interrupts are always serviced by the mainframe, but can be handled by the mainframe or by the controller. Use *DISABLE INTR* to disable the voltmeter from interrupting

2. The *RDGSMODE* command must be set before the interrupt is enabled. You can use the *INTR?* command to query the status of interrupts. *INTER?* returns the address of the last channel whose interrupt was serviced. If no interrupt has been serviced since power-on or following a system reset, -1 is returned.

Table 5-25. Mainframe Interrupt Handling Commands

Command	Description
SUB name	Set up servicing subroutine name in mainframe.
sub commands	Define subroutine servicing action.
SUBEND	End subroutine.
USE ch	Set which voltmeter is to interrupt.
ON INTR CALL name	call servicing subroutine name on interrupt.
ENABLE INTR SYS	Enable mainframe to recognize voltmeter interrupt.
ENABLE INTR	Enable voltmeter to interrupt.

Handle Interrupt in Mainframe (ENABLE INTR)

To service and handle a voltmeter interrupt in the mainframe, use *ON INTR CALL name* where *name* is the name of the servicing subroutine. When *ON INTR CALL name* is executed (as a result of the interrupt), the interrupt is disabled. Table 5-25 shows a typical sequence of commands to service and handle a voltmeter interrupt in the mainframe.

Handle Interrupt in Controller (ENABLE INTR)

Interrupts can also be serviced in the mainframe but handled by the controller. Table 5-26 shows a typical set of commands to service a voltmeter interrupt in the mainframe and handle the interrupt in an HP Series 200/300 or equivalent controller.

Table 5-26. Controller Interrupt Handling Commands

Command	Description
Controller Commands	
ON INTR 7 GOSUB Name -or- CALL Name -or- GOTO Name	Call servicing subroutine name on interrupt.
ENABLE INTR 7;2	Enable interface to interrupt on SRQ
Name: I	Start controller subroutine
subroutine commands*	Define subroutine actions
SROLL(709)	Serial Poll - clears SRQ bit
RETURN	End controller subroutine
HP 3852A Commands	
USE ch	Set which voltmeter is to interrupt.
RQS INTR (or RQS 512)	Enable RQS Mask Register INTR bit.
RQS ON	Set RQS Mode ON.
ENABLE INTR SYS	Enable mainframe to recognize voltmeter interrupt.
ENABLE INTR	Enable voltmeter to interrupt on data available.
STA?	Clear Status Register FPS, LCL, INTR, LMT, ALRM bits,
CLROUT	Clear output buffer.
Configuration commands	Set voltmeter configuration for measurement.

**Disabling Interrupts
(DISABLE INTR)**

DISABLE INTR [USE *ch*] prevents the voltmeter from generating an interrupt when a reading becomes available (as defined by the RDGSMODE command). When an interrupt occurs on an enabled channel, the interrupt is disabled when it is serviced and is cleared when all measurements have been read from the voltmeter. Note that CONF clears and disables voltmeter interrupts.

**Example: Setting
Voltmeter Interrupts**

This program enables an HP 44702A/B or HP 44704A voltmeter in slots 6 and 7 of the mainframe to interrupt when DC voltage measurements on channels 500 through 509 have been made.

The scan sequence is started by an external trigger into the EXT0 port on the voltmeter rear panel (set by SCTRIG EXT0). The program loops until the scan sequence completes (all ten readings taken) and then generates the interrupt. The interrupt is serviced in controller subroutine Results. When the program completes, the time of the interrupt and the ten readings are displayed. Note that RDGSMODE END does not allow an interrupt to occur until all ten readings have been taken.

When the interrupt occurs, the HP-IB SRQ line is set TRUE and the interrupt is sent to the controller. Also, the INTR bit (bit 9) and the service request bit (bit 6) in the status register are set. Because the interrupt is handled by the controller, both bits must be cleared (STA? clears bit 9, SROLL clears bit 6) before the controller can respond to the next channel interrupt that occurs.

10 DIM B(0:9)	<i>! Dimension controller array</i>
20 ON INTR 7 GOTO Results	<i>! Call sub on interrupt</i>
30 ENABLE INTR 7;2	<i>! Enable controller intr on SRQ</i>
40 OUTPUT 709;"USE 600"	<i>! Use voltmeter in MF slot 6</i>
50 OUTPUT 709;"RQS ON"	<i>! Set RQS mode ON</i>
60 OUTPUT 709;"RQS INTR"	<i>! Unmask RQS Mask Reg INTR bit</i>
70 OUTPUT 709;"STA?"	<i>! Clear FPS,LCL,INTR,LMT, ALRM bits</i>
80 OUTPUT 709;"CLROUT"	<i>! Clear STA? data from output buffer</i>
90 OUTPUT 709;"SCANMODE ON"	<i>! Set Scanner Mode</i>
100 OUTPUT 709;"CONF DCV"	<i>! Configure for DC voltage measurements</i>
110 OUTPUT 709;"RDGSMODE END"	<i>! Interrupt when scan completes</i>
120 OUTPUT 709;"ENABLE INTR"	<i>! Enable voltmeter to interrupt</i>
130 OUTPUT 709;"ENABLE INTR SYS"	<i>! Enable mainframe to sense interrupt</i>
140 OUTPUT 709;"CLWRITE 500-509"	<i>! Set ch 500-509 as scan list</i>
150 OUTPUT 709;"SCTRIG EXT0"	<i>! Trigger voltmeter from EXT0 port</i>
160 GOTO 160	<i>! Loop until interrupt occurs</i>
170 Results:	<i>! Start controller subroutine</i>
180 OUTPUT 709;"TIME"	<i>! Query time of day</i>
190 ENTER 709;T	<i>! Enter time of day</i>
200 PRINT "Intr @ ";TIME\$(T)	<i>! Display interrupt time/message</i>
210 OUTPUT 709;"XRDGS 600,10"	<i>! Read ch 500-509 voltages</i>
220 ENTER 709;B(*)	<i>! Enter ch 500-509 voltages</i>
230 PRINT USING "K,/";B(*)	<i>! Display ch 500-509 voltages</i>
240 A = SPOLL(709)	<i>! Read/clear SRQ bit</i>
250 STOP	<i>! End controller subroutine</i>
260 END	

When the interrupt occurs, the controller queries the time of day and enters the ten readings. For a set of 9V 5% sources connected to channels 500-509, a typical return (voltage value in volts) is:

```

Intr @ 02:46:50
8.995
8.99
.
.
9.01
  
```

} 10 readings

Measurement Examples

Typical measurement examples for the voltmeter follow, divided into three general categories as shown in Table 5-27. Except as noted, the voltmeter is in mainframe slots 6 and 7 and is connected via the ribbon cable to an HP 44711A/B multiplexer in slot 5 of the mainframe. Scanner Mode ribbon cable operation with RDGS SYS is also assumed. See Figure 3-3 for typical connections to the HP 44711A/B multiplexer.

NOTE

The examples do not include GPIO transfers or GPIO operation. Refer to Chapter 7 - GPIO Operation for examples using GPIO.

Table 5-27. Measurement Examples

Title	Description
Digitizing Waveforms	
Capture a "Window" of Data	Measure voltage values within a specified time frame before and after an event.
Digitize a Waveform	Sample a signal at specified intervals to digitize the waveform.
Graphing a Waveform	Sample a signal at specified intervals and graphically display the result.
High-Speed Data Transfers	
Transfer Data to Mainframe	Take measurements at 80,000 readings per second and transfer data to mainframe memory.
Transfer Data to Controller	Take measurements at 80,000 readings per second and transfer data to controller (via mainframe) at 35,000 readings per second.
Rear Panel Measurements	Take measurements at 80,000 readings per second for an input to the rear panel terminals and transfer data to mainframe memory.
Special Applications,	
Continuous Data Acquisition	Take measurements continuously and transfer the data to the controller when an interrupt occurs.
Synchronize Multiple Voltmeters	Control a slave voltmeter with a master voltmeter to make synchronized measurements.
60 Hz Noise Rejection	Set voltmeter timing parameters and use the STAT (statistics) command to average out 60 Hz line noise.

Digitizing Waveforms

Three examples follow to show some ways the voltmeter can be used to digitize input waveforms. They include capturing a "window" of data around an event, sampling a signal to digitize a waveform, and graphically displaying an input waveform.

Example: Capture of a "Window" of Data

An application for the high-speed voltmeter is to capture a "window" of data centered around an event. One way to do this is to set the voltmeter to continuously make measurements until the event occurs, use the stop trigger to signal the event, and take data as required after the event.

This program sets the voltmeter for two prescans and one postscan. An "event" is signaled by a high-to-low input on the EXT0 port which generates the stop trigger. The measurement consists of DC voltage measurements on channel 500 of an HP 44711A/B multiplexer, with 10 readings per channel.

Readings are made continuously until the stop trigger is received. When the stop trigger is received (high-to-low input to EXT0), the voltmeter completes the current prescan and makes one postscan. Since RDGSMODE COMPLETE is set, when the program completes the data in the buffer will be the last 20 readings before the event plus the 10 readings after the event.

STTRIG EXT0 sets the stop trigger source to the EXT0 port and SCTRIG SGL starts the scan sequence. When SCTRIG SGL is executed, the voltmeter makes continuous scan passes on channel 500 until a low-going pulse is input to the EXT0 port and the stop trigger occurs. The voltmeter then completes the current scan pass, makes one postscan pass and halts.

XRDGS transfers 30 readings (2 prescans + 1 postscan pass of 10 readings each). As noted, since RDGSMODE COMPLETE is set the readings transferred are from the last two prescans before the stop trigger occurs plus the readings from the single postscan. For example, if the stop trigger occurred on the 8th prescan, XRDGS transfers the 20 readings from prescans 7 and 8 plus the 10 readings from postscan 1.

10 DIM Volts(0:29)	<i>! Dim controller array</i>
20 OUTPUT 709;"USE 600"	<i>! Use voltmeter in MF slot 6</i>
30 OUTPUT 709;"SCANMODE ON"	<i>! Set Scanner Mode</i>
40 OUTPUT 709;"CONF DCV"	<i>! Set DC volts</i>
50 OUTPUT 709;"RDGSMODE COMPLETE"	<i>! Trim to 2 prescans + 1 postscan</i>
60 OUTPUT 709;"NRDGS 10"	<i>! Set 10 readings/channel</i>
70 OUTPUT 709;"SPER 10E-6"	<i>! Set 10 μsec between meas triggers</i>
80 OUTPUT 709;"SCDELAY 0"	<i>! Set 0 msec scan trigger delay</i>
90 OUTPUT 709;"PRESCAN 2"	<i>! Set 2 prescans</i>
100 OUTPUT 709;"POSTSCAN 1"	<i>! Set 1 postscan</i>
110 OUTPUT 709;"ASCAN ON"	<i>! Set autoscan mode on</i>
120 OUTPUT 709;"CLWRITE 500"	<i>! Set ch 500 as scan list</i>
130 OUTPUT 709;"STTRIG EXT0"	<i>! Set EXT0 as stop trigger source</i>
140 OUTPUT 709;"STSLOPE HL"	<i>! Set HL slope for stop trigger</i>
150 OUTPUT 709;"SCTRIG SGL"	<i>! Set single scan trigger source</i>
160 OUTPUT 709;"XRDGS 600,30"	<i>! Transfer 30 readings</i>
170 ENTER 709;Volts(*)	<i>! Enter 30 readings</i>

180 PRINT USING "K,":Volts(*)
190 END

! Display 30 readings

For a 9V 5% voltage source connected to channel 500 a typical return (values in volts) follows if the stop trigger occurs on the 100th prescan pass.

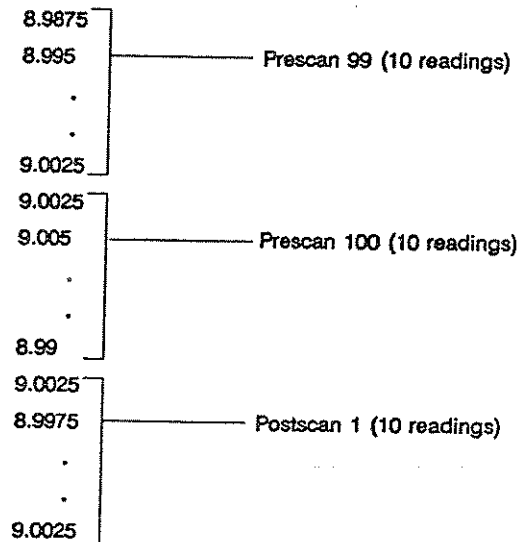

Example: Digitize a Waveform

This program triggers a voltmeter in slot 6 of the mainframe when the voltage input to channel 500 of an HP 44711A/B multiplexer crosses 3.072 V in the negative (high-to-low) direction. When the trigger occurs the voltmeter makes 10 measurements at 0.5 second intervals. Since RDGSMODE DAV is set, an interrupt also occurs with the first reading. The resulting data is a digitized version of the input waveform.

NOTE

The 0.5 second intervals in this example are much longer than typical digitizing applications. The longer interval is used primarily to illustrate the measurement concept. You can, of course, set the interval as small as 10 μ sec, if required.

CONF sets RDGSMODE DAV which makes measurements available immediately. The STA? command reads the Status Register and clears the FPS, LCL, INTR, LMT, and ALRM bits and CLROUT clears the output buffer. The SPOLL command clears the Status Register service request bit (SRQ bit).

10 DIM B(0:9)
20 ON INTR 7 GOTO Results
30 ENABLE INTR 7:2
40 OUTPUT 709;"USE 600"
50 OUTPUT 709;"RQS ON"

*! Dimension controller array
! Call sub Results on interrupt
! Enable controller intr on SRQ
! Use voltmeter in mainframe slot 6
! Set RQS mode ON*

60 OUTPUT 709;"RQS INTR"	<i>! Enable RQS Mask Reg INTR bit</i>
70 OUTPUT 709;"STA?"	<i>! Clear FPS,LCL,INTR,LMT, ALRM bits</i>
80 OUTPUT 709;"CLROUT"	<i>! Clear output buffer</i>
90 OUTPUT 709;"SCANMODE ON"	<i>! Set Scanner Mode</i>
100 OUTPUT 709;"CONF DCV"	<i>! Set DC volts</i>
110 OUTPUT 709;"RANGE 9"	<i>! Set 10.24 V range</i>
120 OUTPUT 709;"NRDGS 10"	<i>! Make 10 readings</i>
130 OUTPUT 709;"PERC 30"	<i>! Set 3.072V threshold</i>
140 OUTPUT 709;"SCSLOPE HL"	<i>! Set HL slope for scan trigger</i>
150 OUTPUT 709;"SPER 0.5"	<i>! Measure @ 0.5 sec intervals</i>
160 OUTPUT 709;"SDELAY 0"	<i>! Set 0 sec scan trigger delay</i>
170 OUTPUT 709;"ENABLE INTR"	<i>! Enable voltmeter intr capability</i>
180 OUTPUT 709;"ENABLE INTR SYS"	<i>! Enable mainframe intr capability</i>
190 OUTPUT 709;"CLWRITE 500"	<i>! Set ch 500 as scan list</i>
200 OUTPUT 709;"SCTRIG MEAS"	<i>! Scan trigger on input threshold</i>
210 GOTO 210	<i>! Loop until interrupt occurs</i>
220 Results:	<i>! Start controller subroutine</i>
230 OUTPUT 709;"TIME"	<i>! Query time of day</i>
240 ENTER 709;T	<i>! Enter time of day</i>
250 PRINT "Ch 500 Intr @ ";TIMES(T)	<i>! Print interrupt time/message</i>
260 OUTPUT 709;"XRDGS 600,10"	<i>! Read ch 500 voltages</i>
270 ENTER 709;B(*)	<i>! Enter voltages</i>
280 PRINT "Ch 500 Voltages"	<i>! Display header</i>
290 PRINT USING "K";B(*)	<i>! Display voltages</i>
300 A = SPOLL (709)	<i>! Read/clear SRQ bit</i>
310 STOP	<i>! End controller subroutine</i>
320 END	

When the trigger occurs (input voltage $\leq 3.072V$), the voltmeter takes 10 measurements separated by 0.5 sec intervals. These measurements can be used to digitize the waveform for the 5 second interval following the trigger. A typical return for a decreasing ramp-type function (voltage value in volts) follows.

```
Ch 500 Intr @ 02:46:50
Ch 500 Voltages
3.0375 2.8725 2.4 1.88 1.34 0.675 0.575 0.44 0.37 0.275
```

Example: Graphing a Waveform This program samples the voltage of the input connected to channel 500 of an HP 44711A/B multiplexer and displays the results in graphical form. The voltmeter is set for 2 prescans and 2 postscans. The stop trigger threshold is set for 4.096 volts (10.24V range x 40% as set with PERC).

When the input reaches 4.096 volts, the stop trigger is generated. Since RDGSMODE COMPLETE is set, readings from the last two prescans before the stop trigger plus the two postscans after the stop trigger (40 readings total at 0.1 sec intervals) are transferred to the controller by XRDGS and displayed.

```

10 DIM Volts(0:39)                / Dimension controller array
20                                /
30                                / Set up voltmeter
40                                /
50 OUTPUT 709;"USE 600"           / Use voltmeter in mainframe slot 6
60 OUTPUT 709;"SCANMODE ON"       / Set Scanner Mode
70 OUTPUT 709;"CONF DCV"          / Configure for DC volts
80 OUTPUT 709;"RANGE 9"           / Set 10.24V range
90 OUTPUT 709;"RDGSMODE COMPLETE" / Trim to (prescans + postscans)
100 OUTPUT 709;"NRDGS 10"         / Set 10 readings/channel
110 OUTPUT 709;"PERC 40"          / Gen stop trigger at 4.096 V
120 OUTPUT 709;"SPER .1"          / Measure trigger @ .1 sec intervals
130 OUTPUT 709;"SCDELAY 0"        / Set 0 msec scan trigger delay
140 OUTPUT 709;"PRESCAN 2"        / Set 2 prescans
150 OUTPUT 709;"POSTSCAN 2"       / Set 2 postscans
160 OUTPUT 709;"ASCAN ON"         / Only one scan trigger required
170 OUTPUT 709;"CLWRITE 500"      / Set ch 500 as scan list
180 OUTPUT 709;"STSLOPE LH"       / Set LH slope for stop trigger
190 OUTPUT 709;"STTRIG MEAS"     / Stop trigger on threshold
200 OUTPUT 709;"SCTRIG SGL"       / Single scan trigger
210 OUTPUT 709;"XRDGS 600,40"     / Transfer 40 readings
220 ENTER 709;Volts(*)            / Enter 40 readings
230                                /
240                                / Graph results
250                                /
260 GINIT
270 PLOTTER IS 3,"INTERNAL"
280 OUTPUT KBD;CHR$(255)&CHR$(75);
290 GRAPHICS ON
300 VIEWPORT 0,135,25,95
310 WINDOW 0,4,0,9
320 MOVE 0,0
330 AXES,1,,5,0,0,10,2,8
340 MOVE 0,0
350 FOR I=0 TO 39

```



```
360 DRAW .1*I,Volts(I)
```

```
370 NEXT I
```

```
380 END
```

A typical return for this program is shown in Figure 5-16 where the x-axis is time in seconds and the y-axis is voltage in Volts.

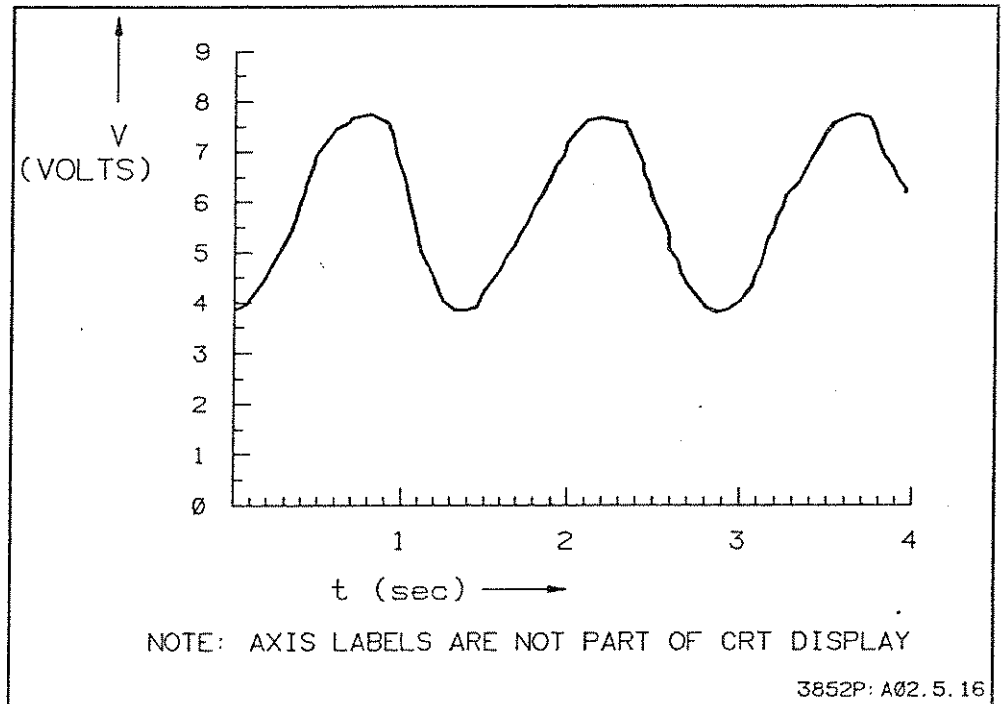

Figure 5-16. Example: Graphing a Waveform

High-Speed Data Transfers

Three examples follow to show some ways that data can be acquired and transferred at high speeds, including transfers to the mainframe memory and to the controller (via the mainframe memory).

Example: Transfer Data to Mainframe

This program shows how to make high-speed measurements at 80,000 readings/second and transfer the readings to the mainframe memory. The program makes 5,000 measurements on a single channel (channel 500) and stores them in mainframe array PARR (in PACKED format) for eventual transfer and unpacking by the controller.

Since SPER is set for 12.5 μ sec, measurements are taken at 12.5 μ sec intervals. SCDELAY 0, 1.25E-3 sets 0 msec scan trigger delay and 1.25 msec between scans. For DC voltage measurements with the high-speed voltmeter, PACKED data is returned with two bytes/reading. Thus, PARR must be dimensioned for 10,000 bytes to store 5000 PACKED readings.

Note that the front panel display is turned off with DISP OFF. This is very important for high-speed scans as it greatly improves high-speed performance.

```

10 ASSIGN @Dac to 709           ! Assign Dac as I/O path
20 OUTPUT @Dac;"PACKED PARR(9999)" ! Dim PACKED mainframe array
30 OUTPUT @Dac;"USE 600"       ! Use voltmeter in MF slot 6"
40 OUTPUT @Dac;"DISP OFF"     ! Mainframe display off
50 OUTPUT @Dac;"SCANMODE ON"  ! Set Scanner Mode
60 OUTPUT @Dac;"CONF DCV"     ! Configure for DC volts
70 OUTPUT @Dac;"RANGE 9"     ! Set 10.24V range
80 OUTPUT @Dac;"NRDGS 100"    ! Set 100 readings/channel
90 OUTPUT @Dac;"SPER 12.5E-6" ! 12.5  $\mu$ sec between meas
100 OUTPUT @Dac;"SCDELAY 0,1.25E-3" ! 1.25 msec between scans
110 OUTPUT @Dac;"PRESCAN 50"  ! Set 50 prescans
120 OUTPUT @Dac;"POSTSCAN 0"  ! Set 0 postscans
130 OUTPUT @Dac;"CLWRITE 500" ! Set ch 500 as scan list
140 OUTPUT @Dac;"SCTRIG INT"  ! Internal scan triggers
150 OUTPUT @Dac;"XRDGS 600,5000 INTO PARR"! Xfer 5,000 rdgs to PARR
160 END

```

Example:Transfer Data to Controller

This program makes measurements at 80,000 readings/second, transfers the readings to the controller at approximately 35,000 readings per second, and unpacks the readings in the controller. The example includes unpacking functions for 13 bit (HP 44702A/B, and HP 44704A after RST) and 14 bit (HP 44704A after RESOL 14 command) modes. Call the appropriate one by editing line 310.

The program makes 25 measurements (5 readings on each of 5 channels) and stores them in mainframe array PARR in PACKED format. The readings are transferred to the output buffer with the VREAD command and then transferred to the controller with the TRANSFER statement. The packed readings are then unpacked by the controller. Since packed DC voltage readings have a 2 bytes/reading format, PARR must be defined for 50 bytes.

Since SPER is set for 12.5 μ sec, measurements are taken at 12.5 μ sec intervals. SCDELAY 0 sets 0 sec scan trigger delay. Note that the front panel display is turned off with DISP OFF. This is very important for high-speed scans as it greatly improves system performance.

NOTE

It may appear that transferring PACKED readings directly from the voltmeter to the controller is faster than transferring the readings to the mainframe memory and then to the controller. However, this is not the case.

For an HP Series 200/300 controller, maximum transfer rate over HP-IB is about 3,000 readings/sec, while transfer rate via the mainframe memory is about 35,000 readings/sec. The transfer rate for the small number of readings

in this program will not be 35,000 readings/sec, but should approach this value for a large number of readings.

```
30 / Define I/O paths, buffer, array
40 OPTION BASE 0                               / Set option base 0
50 INTEGER Bdata(1:25) BUFFER                 / Define controller buffer
60 ASSIGN @Dac to 709                          / HP 3852A I/O address
70 ASSIGN @Hp_3852 to 709;FORMAT OFF          / Set up HP-IB path
80 ASSIGN @Bdata to BUFFER Bdata(*);FORMAT OFF / Controller buffer path
90 OUTPUT @Dac;"PACKED PARR(49)"             / HP 3852A packed array
100                                           /
110 / Set up voltmeter and transfer data
130 OUTPUT @Dac;"USE 600"                     / Use voltmeter in MF slot 6
140 OUTPUT @Dac;"DISP OFF"                   / Mainframe display off
150 OUTPUT @Dac;"SCANMODE ON"               / Set Scanner Mode
160 OUTPUT @Dac;"CONF DCV"                  / Configure for DC volts
170 OUTPUT @Dac;"RANGE 9"                   / Set 10.24V range
180 OUTPUT @Dac;"NRDGS 5"                   / Set 5 readings/channel
190 OUTPUT @Dac;"SPER 12.5E-6"              / Set 12.5 µsec between meas
200 OUTPUT @Dac;"SCDELAY 0"                 / Set 0 msec scan trig delay
210 OUTPUT @Dac;"CLWRITE 500-504"          / Set ch 500-504 as scan list
220 OUTPUT @Dac;"ASCAN ON"                  / Single scan trigger required
230 OUTPUT @Dac;"SCTRIG SGL"                / Single scan trigger
240 OUTPUT @Dac;"XRDGS 600,25 INTO PARR"    / Transfer rdgs to mainframe
250 OUTPUT @Dac;"VREAD PARR,PACK"          / Transfer rdgs to output buffer
260 TRANSFER @Hp_3852 TO @Bdata;END,WAIT    / Transfer rdgs to controller
280
290 / Unpack PACKED data
300 FOR I = 1 TO 25
310 PRINT FNUnpk13(Bdata(I))                / Print readings
320 NEXT I
330 END
340 DEF FNUnpk13(INTEGER Bdata)              / Define 13 bit unpack function
350 REAL R(0:3)
360 DATA 256.,32.,4.,1.
370 READ R(*)
380 M = BINAND(Bdata,4095)
390 IF Bdata > 0 OR M = 4095 THEN
400 RETURN 1.E + 38
410 ELSE
420 V = M*.0025/R(BINAND(SHIFT(Bdata,13),3))
430 IF BIT(Bdata,12) THEN V = -V
440 RETURN V
```

```

450 END IF
460 FNEND
470 DEF FNUnpk14(INTEGER Pack)
480 REAL R(0:3)
490 DATA 256.,32.,4.,1.
500 READ R(*)
510 ! Convert A/D bits and range bits to volt reading
520 V = SHIFT(BINAND(16383, Pack), -2)/4*.00125/R(BINAND(SHIFT(Pack, 14), 3))
530 RETURN V
540 FNEND

```

! End 13 bit unpack function
! Define 14 bit unpack function
! Alloc. range factor array
! Range function data
! Fill array with range factors
! End 14 bit unpack function

For a set of 9V 5% sources connected to channels 500-504, a typical return is:

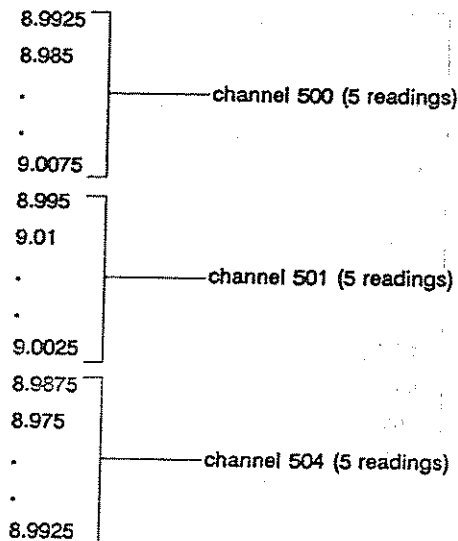

Example: Rear Panel Measurements

Typically, high-speed scanning is accomplished using the voltmeter with an HP 44711A/B, 44712A, or 44713A/B multiplexer and ribbon cable operation. However, you can make high-speed measurements (up to 90,000 readings per second) of a single "channel" by sending the input signal to the voltmeter rear panel terminals.

This program makes 25 measurements of an input to the rear panel terminals at 80,000 readings/second, stores the readings in mainframe array PARR (in PACKED format), then transfers and unpacks the readings in the controller. The example includes unpacking functions for 13 bit (HP 44702A/B, and HP 44704A after RST) and 14 bit (HP 44704A after RESOL 14 command) modes. Call the appropriate one by editing line 310. Since SPER is set for 12.5 μ sec, measurements are taken at 12.5 μ sec intervals. SCDELAY 0 sets 0 msec scan trigger delay.

Note that CLWRITE is not used, since there are no multiplexer channels to be measured. Instead, the voltmeter sets up a "dummy" channel in the scan list for each reading and takes the readings from the source specified by TERM (TERM EXT in this program). Also, note that the front panel display is turned off with DISP OFF. This is very important for high-speed scans as it greatly improves system performance.

```

30 / Define I/O paths, buffer, array           /
40 OPTION BASE 0                               / Set option base 0
50 INTEGER Bdata(1:25) BUFFER                 / Define controller buffer
60 ASSIGN @Dac to 709                          / HP 3852A I/O address
70 ASSIGN @Hp_3852 to 709;FORMAT OFF          / Set up HP-IB path
80 ASSIGN @Bdata to BUFFER Bdata(*);FORMAT OFF / Controller buffer path
90 OUTPUT @Dac;"PACKED PARR(49)"              / HP 3852A packed array
100                                           /
120 / Set up voltmeter and transfer data       /
130 OUTPUT @Dac;"USE 600"                     / Use voltmeter in MF slot 6
140 OUTPUT @Dac;"DISP OFF"                    / Mainframe display off
150 OUTPUT @Dac;"SCANMODE ON"                 / Set Scanner Mode
160 OUTPUT @Dac;"CONF DCV"                    / Configure for DC volts
170 OUTPUT @Dac;"TERM EXT"                    / Rear terminals are input
180 OUTPUT @Dac;"RANGE 9"                     / Set 10.24V range
190 OUTPUT @Dac;"NRDGS 25"                    / Set voltmeter for 25 rdgs
200 OUTPUT @Dac;"SPER 12.5E-6"                / Set 12,5 µsec between meas
210 OUTPUT @Dac;"SCDELAY 0"                   / Set 0 msec scan trig delay
220 OUTPUT @Dac;"ASCAN ON"                    / Single scan trigger required
230 OUTPUT @Dac;"SCTRIG SGL"                  / Single scan trigger
240 OUTPUT @Dac;"XRDGS 600,25 INTO PARR" / Transfer rdgs to mainframe
250 OUTPUT @Dac;"VREAD PARR,PACK"            / Transfer rdgs to output buffer
260 TRANSFER @Hp_3852 TO @Bdata;END,WAIT / Transfer rdgs to controller
270                                           /
290 / Unpack PACKED data                       /
300 FOR I = 1 TO 25                            / Begin unpacking function
310 PRINT FNUUnpk13(Bdata(I))                 / Print readings
320 NEXT I
330 END
340 DEF FNUUnpk13(INTEGER Bdata)
350 REAL R(0:3)
360 DATA 256.,32.,4.,1.
370 READ R(*)
380 M = BINAND(Bdata,4095)
390 IF Bdata > 0 OR M = 4095 THEN
400 RETURN 1.E + 38
410 ELSE
420 V = M *.0025/R(BINAND(SHIFT(Bdata,13),3))/I

```

```

430 IF BIT(Bdata,12) THEN V=-V
440 RETURN V
450 END IF
460 FNEND ! End 13 bit unpack function
470 DEF FNUnpk14(INTEGER Pack) ! Define 14 bit unpack function
480 REAL R(0:3) ! Alloc. range factor array
490 DATA 256.,32.,4.,1. ! Range function data
500 READ R(*) ! Fill array with range factors
510 ! Convert A/D bits and range bits to volt reading
520 V=SHIFT(BINAND(16383,Pack),-2)/4*.00125/R(BINAND(SHIFT(Pack,14),3))
530 RETURN V
540 FNEND ! End 14 bit unpack function

```

Special Applications

These three examples show some special applications for the voltmeter, including continuous data acquisition, synchronizing multiple voltmeters, and 60 Hz noise rejection.

Example: Continuous Data Acquisition

This program shows one way to do continuous data acquisition with the voltmeter. The program uses an HP Series 200/300 controller with a DMA card, an HP 44702B or HP 44704A in slot 6 of the mainframe, an HP 44711A/B multiplexer in slot 5 of the mainframe, and an HP 44721A digital input accessory in slot 2 of the mainframe. The input to the HP 44721A (used for interrupt) is to channel 200. The accessory debounce jumper is set for 10 Hz and the channel 200 attenuator jumper is set for 5V.

For this program, the voltmeter makes continuous measurements on channel 500 of the multiplexer. Data is continuously transferred from the voltmeter to the controller via the mainframe memory. When a low-to-high transition (LH edge) occurs on channel 200 of the HP 44721A digital input, an interrupt is generated to the controller. After the interrupt occurs, the voltmeter takes readings for an additional 1/2 second and the program ends.

NOTE

Since the readings stored in the controller are in PACKED format, the readings must be unpacked to be readable. Refer to "Example: Transfer Data to Controller" for an example unpacking function.

Define Variables and Buffer

Lines 40 - 60 define the variable and buffer names for the program. S300_buff is an INTEGER buffer in the controller.

Assign I/O Paths

Lines 100 - 120 assign the mainframe I/O address and the I/O transfer paths from the mainframe to the controller buffer S300_buff.

Configure the Voltmeter

Lines 160 - 330 configure the voltmeter for DC voltage measurements on channel 500. Measurements are made at 27.5 μ sec intervals (approximately 36 kHz). Note that STTRIG HOLD (line 330) is set. Thus, the stop trigger is not enabled (and the voltmeter continuously make measurements) until an interrupt from the digital input accessory occurs.

Enable Interrupts

Lines 370 - 400 enable controller interrupts and keep the data transfer operation going. In line 370, if a TRANSFER is completed and an interrupt has not occurred, subroutine Xfer_done is called and the transfer process is restarted.

If an interrupt has occurred (LH edge on the digital input), line 380 branches to Terminate which ends the program 0.5 seconds after the interrupt occurs. Lines 390 and 400 enable controller interrupt capability. Note, however, that Xfer_done is always performed since it has a higher priority (priority 5 in line 370) than the interrupt.

Subroutine INTROUT

Subroutine INTROUT is called when the voltmeter has room for only 4,096 more readings (since RDGSMODE BURST is set). This subroutine transfers 4,096 PACKED readings to mainframe array A and then to the output buffer for transfer to the controller buffer S300_buff. Voltmeter interrupt capability is then re-enabled.

Subroutine XIT

Subroutine XIT is called when an interrupt (LH edge) occurs on the HP 44721A digital input accessory. This subroutine generates the stop trigger for the voltmeter and transfers 4,096 readings from the voltmeter to mainframe array A and then to the output buffer. A service request is sent to the controller and a single "BEEP" is generated to advise of the interrupt. When the subroutine completes, the program branches to Terminate (line 1030).

In line 560, STA? INTO X clears the status register bits shown and the status register state is stored in variable X. This ensures that the status register information is not included in any data transfer operation.

Call Subroutines

Lines 630 - 640 call subroutines on interrupt. An LH edge on the digital input calls subroutine XIT. When the voltmeter data buffer has room for only 4,096 more readings, subroutine INTROUT is called.

Enable Accessory Interrupts

Lines 680 - 730 enable the voltmeter and digital inputs to interrupt and enable the mainframe to recognize the interrupt. RQS FPS and RQS ON enable service request operation.

Trigger the Voltmeter

Line 770 issues a single scan trigger to start the scan sequence. Since ASCAN ON is set (line 310), only a single scan trigger is required for continuous passes.

Start Data Transfers

Line 810 transfers data from the output buffer to the controller buffer.

Read Buffer Status

While the transfers are in progress, lines 850 - 920 read the status of buffer S300_buff and provide a continuous display of the fill pointer position, input/output status, and index number.

Restart Transfers

When a transfer completes, line 370 calls the Xfer_done subroutine which resets the buffer fill pointer and restarts the transfer operation. The buffer index counter is also incremented.

End Program

When an LH edge on the digital input occurs, the program goes to Terminate (line 1030). After the interrupt occurs, the voltmeter takes another $\frac{1}{2}$ second of data, the I/O path is closed, and the program ends. A typical display after an interrupt occurs follows the program listing.

```
30 ! Define variables and buffer
40 OPTION BASE 0
50 INTEGER Cntr,Done,In_stat_byt,Out_stat_byt,Mask ! Define variables
60 INTEGER S300_buff(1:24576) BUFFER ! Define buffer
70 !
80 Iopath_setup: ! Define I/O paths
90
100 ASSIGN @Comp TO 709 ! HP 3852A I/O address
110 ASSIGN @Path_3852 TO 709;FORMAT OFF! HP-IB I/O path
120 ASSIGN @S300_buff TO BUFFER S300_buff(*);FORMAT OFF! Buffer I/O path
130 !
140 Dvm_setup: ! Configure the voltmeter
```



```

150
160 CLEAR @Comp                ! clear 709
170 OUTPUT @Comp;"RST"         ! Reset HP 3852A
180 OUTPUT @Comp;"OUTBUF ON"   ! Turn output buffer on
190 OUTPUT @Comp;"INBUF ON"    ! Turn input buffer on
200 OUTPUT @Comp;"PACKED A(8191)" ! Define PACKED array
210 OUTPUT @Comp;"INTEGER X"   ! Define INTEGER variable
220 OUTPUT @Comp;"DISP OFF"    ! Turn front panel display off
230 OUTPUT @Comp;"USE 600"     ! Use voltmeter in MF slot 6
240 OUTPUT @Comp;"SCANMODE ON" ! Set Scanner Mode on
250 OUTPUT @Comp;"CONF DCV"    ! Configure for DC volts
260 OUTPUT @Comp;"RANGE 2.5"  ! Set 2.56V range
270 OUTPUT @Comp;"RDGSMODE BURST" ! Enter when room for 4096 rdgs
280 OUTPUT @Comp;"SPER 27.5E-6" ! Set 27  $\mu$ sec between rdgs
290 OUTPUT @Comp;"SCDELAY 16E-3" ! Set 16 msec scan trig delay
300 OUTPUT @Comp;"POSTSCAN 4096" ! Set 4,096 postscans
310 OUTPUT @Comp;"ASCAN ON"    ! Set autoscan on
320 OUTPUT @Comp;"CLWRITE 500" ! Set ch 500 as scan list
330 OUTPUT @Comp;"STTRIG HOLD" ! Set stop trigger to HOLD
340
350 Intr_setup:                ! Set up interrupts
370 ON EOT @Path_3852,5 GOSUB Xfer_done ! When transfer stops, restart
380 ON INTR 7 GOTO Terminate    ! Stop on dig input intr
390 Mask = 2                    ! Set SRQ interrupt mask,
400 ENABLE INTR 7;Mask         ! Enable cont intr capability
410
430 ! subroutine INTROUT
440 OUTPUT @Comp;"SUB INTROUT" ! Start INTROUT subroutine
450 OUTPUT @Comp;"XRDGS 600,4096 INTO A"! Trans 4,096 rdgs to array A
460 OUTPUT @Comp;"VREAD A,PACK" ! Trans rdgs to output buffer
470 OUTPUT @Comp;"ENABLE INTR USE 600"! Re-enable VM to interrupt
480 OUTPUT @Comp;"SUBEND"      ! End INTROUT subroutine
490
510 ! Subroutine XIT
520 OUTPUT @Comp;"SUB XIT"     ! Start XIT subroutine
530 OUTPUT @Comp;"STTRIG SGL USE 600" ! Single trigger voltmeter
540 OUTPUT @Comp;"XRDGS 600,4096 INTO A"! Trans 4,096 rdgs to array A
550 OUTPUT @Comp;"VREAD A,PACK" ! Trans rdgs to output buffer
560 OUTPUT @Comp;"STA? INTO X" ! Ctr FPS,LCL,INTR,LMT bits
570 OUTPUT @Comp;"SRQ"        ! SRQ message to controller
580 OUTPUT @Comp;"BEEP"       ! BEEP once
590 OUTPUT @Comp;"SUBEND"     ! End XIT subroutine
600
620 ! Call subroutines on interrupt

```

```

630 OUTPUT @Comp;"ON INTR USE 216 CALL XIT"! Call XIT on dig in intr
640 OUTPUT @Comp;"ON INTR USE 600 CALL INTROUT"! Call INTROUT
650
670 ! Enable voltmeter and digital input interrupts
680 OUTPUT @Comp;"RQS FPS"           ! Unmask Service Request bit
690 OUTPUT @Comp;"RQS ON"           ! Enable Service Request mode
700 OUTPUT @Comp;"ENABLE INTR USE 600"! Enable voltmeter interrupt
710 OUTPUT @Comp;"EDGE LH USE 216"   ! Set digital input edge
720 OUTPUT @Comp;"ENABLE INTR USE 216"! Enable digital input intr
730 OUTPUT @Comp;"ENABLE INTR SYS"   ! Enable mainframe intr
740
760 ! Trigger the voltmeter
770 OUTPUT @Comp;"SCTRIG SGL"       ! Single scan trigger
780
800 ! Start data transfers
810 Start:TRANSFER @Path_3852 TO @S300_buff;COUNT 49152,EOR (END)
820
840 ! Read S300_buff status while transfers run
850 Cntr = 0
860 LOOP
870 STATUS @S300_buff,3;Fill_ptr
880 PRINT TABXY(10,5);"Fill Pointer is";Fill_ptr
890 STATUS @S300_buff, 10;In_stat_byt,Out_stat_byt
900 PRINT TABXY(10,8);"Status In/Out ";In_stat_byt;" ";Out_stat_byt
910 PRINTTABXY(10,11);"Index = ";Cntr
920 END LOOP
930
950 ! Reset S300_buff fill pointer and restart transfers
960 Xfer_done:RESET @S300_buff       ! Reset fill pointer to start
970 TRANSFER @Path_3852 TO @S300_buff;COUNT 49152,EOR (END) ! Restart
xfer
980 Cntr=Cntr + 1                    ! Increment INDEX counter
990 RETURN                            ! Return
1000
1020 ! End program 0.5 sec after digital input interrupt occurs
1030 Terminate:WAIT .50              ! Take more data after intr
1040 OFF EOT @Path_3852              ! Cancel inbound EOT
1050 ABORTIO @path_3852              ! Clean up HP-IB path
1060 ASSIGN @path_3852 TO *         ! Close I/O path
1070 STATUS @S300_buff,3;Fill_ptr
1080 PRINT TABXY(10,20);"Ending Fill Pointer is";Fill_ptr
1090 END

```

As noted, the voltmeter continuously makes measurements on channel 500 and measurements are transferred via the mainframe memory (array A) to the controller (BUFFER S300_buff. When an interrupt (LH edge on the HP 44721A digital input), the voltmeter takes measurements for 0.5 seconds after the interrupt and the program ends. A typical return when an interrupt occurs follows.

Fill Pointer is 4,0961

Status In/Out 64, 0

Index = 4

Ending Fill Pointer is 8193

Example: Another application is to synchronize the operation of two or more HP 44702A/B or HP 44704A High-Speed Voltmeters. One of the voltmeters is designated as the master, the other voltmeters as slaves. Each voltmeter must connect to its own high-speed FET multiplexers and each should have identical channel lists.

The TRIGOUT ON command sets the master voltmeter to output measure triggers from its EXT0 port. The measure triggers are sent via BNC connectors to the EXT0 or EXT1 port (as programmed) of the slave voltmeters. See Figure 5-17 for typical BNC connections.

The preferred programming method is to set up all voltmeters and use SCTRIG SGL to start the scan for all slaves. Then, trigger the master to generate measure triggers which will simultaneously trigger measurements on all channels. This method ensures that a race condition will not develop which could cause the slaves to miss a measure trigger.

NOTE

Due to hardware constraints, measure trigger times may be slightly different between master and slave voltmeters. Refer to "Measure Trigger Timing (SPER)" for details.

For this program, the voltmeter in slot 6 of the mainframe is designated as the master voltmeter which synchronizes the operation of a single slave voltmeter in slot 1 of the mainframe. An HP 44711A/B multiplexer is connected to each voltmeter via its individual ribbon cable.

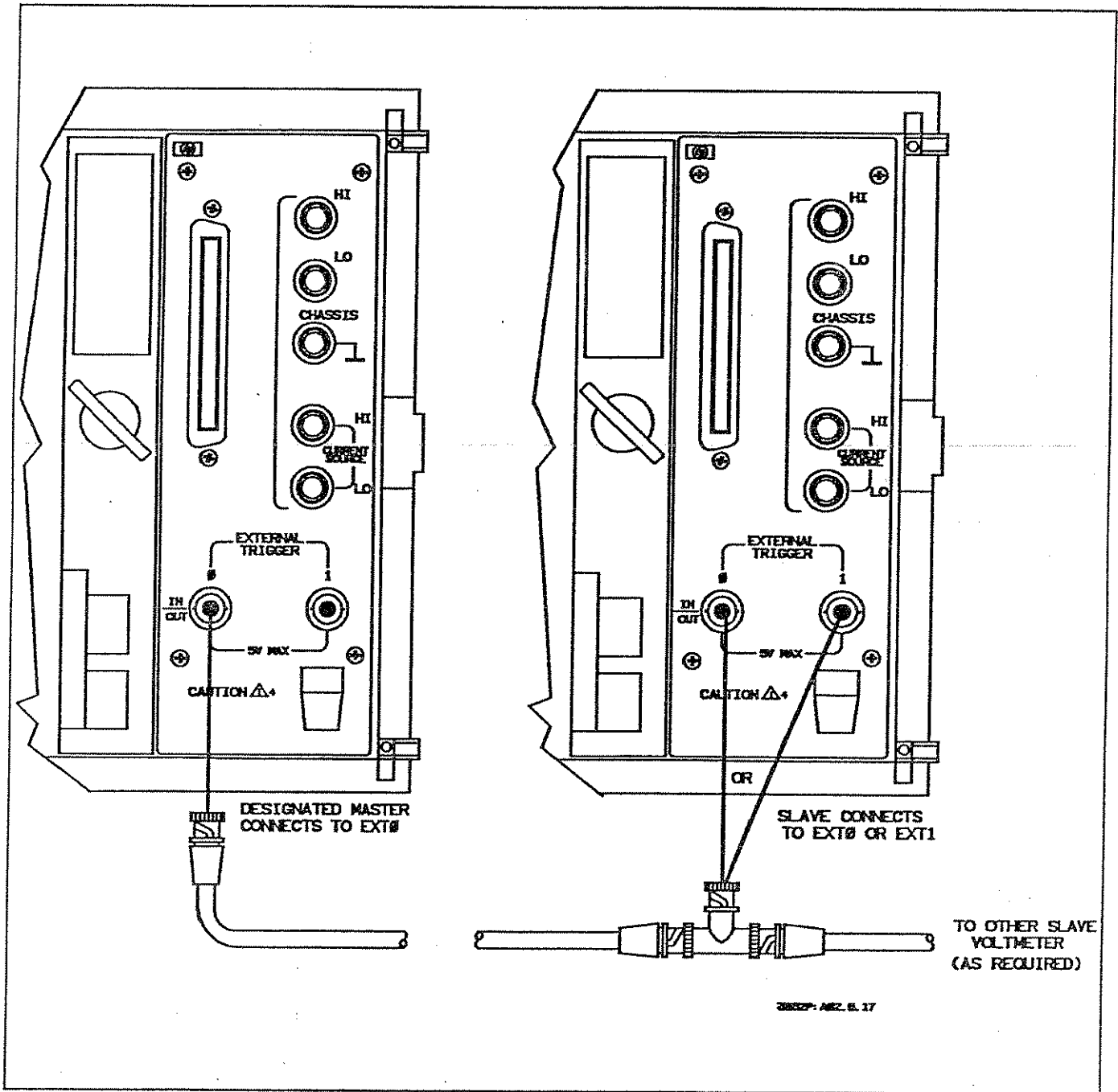

Figure 5-17. Example: Synchronize Multiple Voltmeters

A BNC cable is connected between the master voltmeter EXT0 port and the slave voltmeter EXT0 port as shown in Figure 5-17 to route measure triggers from the master to the slave. Three passes are made through each multiplexer channel list and a total of 9 readings are returned by each voltmeter.

The master voltmeter is set up and configured first, followed by the slave voltmeter. The slave voltmeter is then enabled to respond to the measure trigger from the master and the master voltmeter is triggered.

Lines 80 through 150 set up the master voltmeter. Three passes will be made through the channel list specified by CLWRITE. ASCAN ON sets the master voltmeter so that only one scan trigger is required for the three passes through the scan list.

Lines 190 through 270 set up and enable the slave voltmeter. Since the TRIGOUT signal from the master voltmeter is a negative-going pulse, the SLOPE command sets the slave voltmeter to trigger on the high-to-low transition of the signal. TRIG EXT0 sets the EXT0 port on the slave voltmeter as the measure trigger source.

The slave voltmeter also makes three passes through the channel list specified by CLWRITE. Again, ASCAN ON sets the slave so that only one scan trigger is required to make three passes through the list. SCTRIG SGL starts the scan sequence for the slave voltmeter ONLY. Then, when the measure trigger is received from the master voltmeter, both voltmeters make simultaneous measurements.

SCTRIG SYS and TRG GET set the scan trigger source for the master voltmeter as the HP-IB Group Execute Trigger (GET). When the scan trigger is issued, the master voltmeter outputs measure triggers to the slave so both measurements are synchronized.

```
30 ! Set up controller arrays
40 DIM Rgs1(0:8),Rgs2(0:8)                ! Dim readings arrays
50                                         !
70 ! Set up master voltmeter
80 OUTPUT 709;"RST"                       ! Reset HP 3852A and voltmeters
90 OUTPUT 709;"USE 600"                   ! Use VM in MF slot 6 (master)
100 OUTPUT 709;"SCANMODE ON"              ! Enable Scanner Mode
110 OUTPUT 709;"CONF DCV"                 ! Configure for DC volts
120 OUTPUT 709;"TRIGOUT ON"               ! Output trig signal to BNC 0
130 OUTPUT 709;"PRESCAN 3"                ! Make 3 passes through scan list
140 OUTPUT 709;"ASCAN ON"                 ! Turn autoscan on
150 OUTPUT 709;"CLWRITE 500-502"          ! Ch list/ribbon cable connections
160                                         !
180 ! Set up and scan trigger slave voltmeter
190 OUTPUT 709;"USE 100"                  ! Use VM in MF slot 1
200 OUTPUT 709;"SCANMODE ON"              ! Enable Scanner Mode
210 OUTPUT 709;"CONF DCV"                 ! Configure for DC volts
220 OUTPUT 709;"SLOPE HL"                 ! Trigger on negative-going signal
230 OUTPUT 709;"TRIG EXT0"                ! Set slave BNC 0 to receive trigger
```

```

240 OUTPUT 709;"PRESCAN 3"           ! Make 3 passes through scan list
250 OUTPUT 709;"ASCAN ON"            ! Turn autoscan on
260 OUTPUT 709;"CLWRITE 0-2"        ! Ch list/ribbon cable connections
270 OUTPUT 709;"SCTRIG SGL"         ! Send scan trigger to slave
280                                  !
300 ! Enable and trigger master voltmeter
310 OUTPUT 709;"SCTRIG SYS,USE 600" ! System trigger master voltmeter
320 OUTPUT 709;"TRG GET"            ! Set system trigger source
330 WHILE NOT BIT(SPOLL(709),4)     ! Wait until MF ready before GET
340 END WHILE                        !
350 TRIGGER 709                      ! Trigger the master voltmeter
360                                  !
380 ! Transfer and display readings
390 OUTPUT 709;"XRDGS 600"          ! Trans readings from master
400 ENTER 709;Rgs1(*)               ! Enter master readings
410 PRINT "Slot 5 Readings"
420 PRINT USING "K,/";Rgs1(*)
430 OUTPUT 709;"XRDGS 100"         ! Trans readings from slave
440 ENTER 709;Rgs2(*)              ! Enter slave readings
450 PRINT "Slot 0 Readings"
460 PRINT USING "K,/";Rgs2(*)
470 END

```

For a set of 9V 5% sources connected to channels 0 through 2 and 500 through 502, a typical return (values in volts) is:

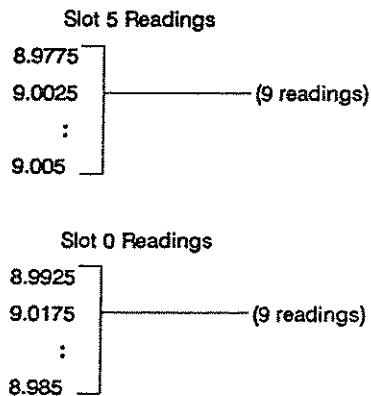

Example: 60 Hz Noise Rejection

This program uses the high-speed voltmeter and the mainframe STAT command to reject 60 Hz noise across 10 multiplexer channels within the period of one cycle of noise. The voltmeter scans the channel list 10 times during the period. SPER is set so that a measurement is taken on each channel within each scan. As measurements are taken, they are stored in a mainframe array. The STAT command then averages out the noise on each channel.

The voltmeter is set for 10 prescans of 10 channels with one reading per channel. When the readings have been made, HP 3852A subroutine CONVERT is called, the noise is averaged out of each reading, and the converted readings are returned to the controller and displayed.

For this program, SCDELAY and SPER parameters are based on the period of the noise (16.7 msec for 60 Hz), the number of measurements (scans) to be taken, and number of channels (10). The following equations show how to calculate the SPER and SCDELAY parameters so that noise rejection can occur on several channels within one cycle of the noise signal.

To determine the SCDELAY [*scan_pace*] and SPER values required to reject noise, use equation (1) to find the SCDELAY [*scan_pace*] parameter and then use equation (2) to find the SPER *sample_period* parameter.

$$SCDELAY [scan_pace] = \frac{Noise\ period}{Number\ of\ scan\ passes} \quad (1)$$

$$SPER\ sample_period = \frac{SCDELAY [scan_pace]}{Number\ of\ measurements} \quad (2)$$

For this program, the noise signal is assumed to be 60 Hz (period = 16.7 msec). The voltmeter is set for 10 prescans of 10 channels with 1 reading per channel. From equation (1), SCDELAY [*scan_pace*] = 16.7 msec/10 = 1.67 msec. Since 10 measurements are made per prescan, from equation (2) SPER = 1.67 msec/10 = 167 μ sec.

```

10                                     !
20                                     ! Clear interface and reset HP 3852A
30                                     !
40 CLEAR 709                           ! Clear interface
50 OUTPUT 709;"RST"                     ! Reset HP 3852A
60                                     !
70                                     ! Declare variables and arrays
80                                     !
90 DIM Average(0:9)                     ! Declare controller array
100 OUTPUT 709;"INTEGER I,J,K"          ! Declare For..Next variables
110 OUTPUT 709;"REAL SAMRDGS(99)"       ! Declare mainframe array
120 OUTPUT 709;"REAL MIN,MAX,STD,MEAN"  ! Declare STAT variables
130 OUTPUT 709;"REAL STAT_ARY(9),AVG(9)"! Declare STAT arrays
140                                     !
150                                     ! Set up voltmeter, transfer readings
160                                     !

```

```

170 OUTPUT 709;"USE 600"           / Use voltmeter in MF slot 6
180 OUTPUT 709;"RST 600"           / Reset voltmeter
190 OUTPUT 709;"SCANMODE ON"       / Set Scanner Mode
200 OUTPUT 709;"CONF DCV"          / Configure for DC voltage
210 OUTPUT 709;"SPER .000167"      / 167 μsec between meas triggers
220 OUTPUT 709;"SCDELAY 0,.00167"  / 1.67 msec between scans
230 OUTPUT 709;"PRESCAN 10"        / Set 10 prescans
240 OUTPUT 709;"CLWRITE 500-509"   / Set ch 500-509 as scan list
250 OUTPUT 709;"SCTRIG INT"        / Set internal scan trigger
260 OUTPUT 709;"XRDGS 600 INTO SAMRDGS" / Transfer rdgs to MF memory
270                                /
290 / Averaging subroutine
300 OUTPUT 709;"SUB CONVERT"        / Begin averaging subroutine
310 OUTPUT 709;" FOR J=0 TO 9"      / Extract channel readings,
320 OUTPUT 709;" K=J"              / average out noise on each ch
330 OUTPUT 709;" FOR I=0 TO 9"
340 OUTPUT 709;"STAT_ARRAY(I) = SAMRDGS(K)"
350 OUTPUT 709;"K=K+10"
360 OUTPUT 709;"NEXT I"
370 OUTPUT 709;"STAT MIN,MAX,MEAN,STD,STAT_ARY"
380 OUTPUT 709;"AVG(J) = MEAN"
390 OUTPUT 709;"NEXT J"
400 OUTPUT 709;"SUBEND"             / End averaging subroutine
410 OUTPUT 709;"CALL CONVERT"       / Call sub when rdgs available
420                                /
440 / Transfer and display readings
450 OUTPUT 709;"VREAD AVG"          / Return readings (without noise)
460 ENTER 709;Average(*)           / Enter readings
470 PRINT Using "K, /";Average(*)   / Display readings
480 END

```

For a set of 9V 5% sources connected to channels 500 - 509, a typical return (values in volts) is:

8.9725	} 10 readings
9.005	
.	
.	
8.9925	

Scanner Mode Command Summary

Table 5-28 summarizes Scanner Mode commands alphabetically, divided by high-level and low-level commands. High-Level commands (CONF, CONFMEAS, MEAS and MONMEAS) perform a series of operations and (when scanning) provide additional measurement functions such as temperature or strain conversions. Low-level commands perform only simple operations such as changing ranges or transferring readings.

Table 5-28. Scanner Mode Command Summary

High-Level Commands

CONF *function* [USE *ch*]

Configure the voltmeter measurement function (DCV, OHMF, etc.) and preset values for other functions (autozero, range, etc.).

CONFMEAS *function ch_list* [NSCAN *number*][USE *ch*] [INTO *name*] or [*fmt*]

Configure the voltmeter function, scan, and measure. CONFMEAS is equivalent to CONF followed immediately by MEAS. CONFMEAS can only be used for multiplexer measurements. NSCAN *number* is valid only for mainframe firmware revision 2.2 and greater. For Scanner Mode, CONFMEAS is valid for ribbon cable (TERM RIBBON) operation only.

MEAS *function ch_list* [NSCAN *number*] [USE *ch*] [INTO *name*] or [*fmt*]

Set the voltmeter measurement function and initiate a scan and measurement of multiplexer channels specified by *ch_list*. NSCAN *number* is valid only for mainframe firmware revision 2.2 and greater.

MONMEAS *function ch_list* [USE *ch*]

Select voltmeter measurement function, scan, measure, and display. MONMEAS selects the voltmeter function, then causes the voltmeter to measure the first channel in the channel list and display the results on the display. The measurement sequence is advanced to the next channel in the list when the front panel SADV KEY key is pressed.

Low-Level Commands

ARMODE *mode* [USE *ch*]

When autoranging is set, ARMODE sets the autorange mode (BEFORE or AFTER). For ARMODE AFTER (power-on) the voltmeter autoranges after a trigger is received and then takes the reading for each measurement. For ARMODE BEFORE, the voltmeter makes the measurement when the trigger is received and autoranges on the next channel.

ASCAN [*mode*] [USE *ch*]

Sets autoscan function. ASCAN OFF requires a separate scan trigger for each pass through the scan list. ASCAN ON requires only an initial scan trigger for the first pass and subsequent passes start automatically.

AZERO [*mode*] [USE *ch*]

Autozero the voltmeter. AZERO ONCE is the only available mode for the voltmeter.

Table 5-28. Scanner Mode Command Summary

CAL

Service-related command. Refer to the HP 3852A Assembly Level Service Manual.

CHREAD *ch* [INTO *name*] or [*fmt*]

Transfer a single reading stored in the voltmeter data buffer to the mainframe memory or to the output buffer and/or display. The voltmeter must have been triggered and data must be available before CHREAD will return a reading.

CLWRITE [*ribbon_bus*] *ch_list* [RANGE *range_list*] [USE *ch*]

Sets channel and range lists to be scanned and used by the voltmeter. The *ribbon_bus* parameter specifies the ribbon cable connections: SENSE (default), COM, SEP, REFT, and STRVEX. (REFT and STRVEX are valid for mainframe firmware revision 2.2 and greater.)

RANGE *range_list* specifies the list of voltmeter ranges which correspond to the channels specified by *ch_list*. CLWRITE is valid only when Scanner Mode (SCANMODE ON) and ribbon cable (TERM RIBBON) operation are set. See Chapter 6 for details on CLWRITE when an HP 44704A is in 16 bit resolution mode.

DISABLE INTR [USE *ch*]

Prevents the voltmeter from generating an interrupt when data is available (as defined by RDGSMODE).

ENABLE INTR [USE *ch*]

Enables the voltmeter to generate an interrupt when data is available (as defined by RDGSMODE). The interrupt can be serviced and handled by the mainframe or serviced by the mainframe and handled by the controller.

FILTER *mode* [USE *ch*] (HP 44704A only)

Enables (*mode* ON), or disables (*mode* OFF) the HP 44704A's low-pass input filter.

FUNC *function* [*range*] [USE *ch*]

Sets the measurement function and range. The *function* parameter can be set only for DC voltage or 4-wire ohms measurements. The range parameter can be set to one of four ranges or to autorange (AUTO). See Chapter 6 for controlling range while in 16 bit resolution mode (HP 44704A only).

ID? [*slot*]

Returns the identity of the accessory in the slot addressed by *slot*. An HP 44702A returns 44702A, an HP 44702B returns 44702B, and an hp 44704A returns 44704A.

INTR? [INTO *name*] or [*fmt*]

Returns the address of the last channel whose interrupt was serviced. If no interrupt has been serviced since power-on or following a system reset, -1 is returned.

Table 5-28. Scanner Mode Command Summary

NRDGS *number* [USE *ch*]

Sets the number of readings per channel for each channel in the channel list. The range of *number* is 1 to 65,535. For the HP 44702A, setting NRDGS 8192 can cause a variable number of readings to be taken with no error given. For ribbon cable operation (TERM RIBBON), range for *number* = (number of channels - 1) times (NRDGS *number*)

PERC *threshold* [USE *ch*]

For SCTRIG MEAS, PERC sets the threshold level for the scan trigger and for STTRIG MEAS, PERC sets the threshold level for the stop trigger (separate levels cannot be set for the scan and stop triggers). The threshold parameter range is -128% to +127% of the voltmeter full-scale range.

POSTSCAN *number* [USE *ch*]

Sets the number of passes the voltmeter will make through the scan list after the stop trigger is accepted. Range of *number* = 0 to 65,535. At power-on, *number* = 0.

PRESCAN *number* [USE *ch*]

Sets the minimum number of passes the voltmeter will make through the scan list before a stop trigger is accepted. Range of *number* = 0 to 65,535. At power-on, *number* = 0.

RANGE [*range*] [USE *ch*]

Sets the voltmeter measurement range or enables the autorange mode. Select autorange by entering the word AUTO or the value 0 for *range*. Power-on and default range = AUTO. See Chapter 6 for controlling range while in 16 bit resolution mode (HP 44704A only).

RDGS *dest* [USE *ch*]

Sets the mainframe or the GPIO port as the destination for readings stored in the voltmeter buffer memory. RDGS SYS sets the mainframe, RDGS GPIO sets the GPIO port.

RDGSMODE *mode* [USE *ch*]

Sets the voltmeter reading storage mode and specifies when data can be read from the voltmeter buffer (data available). Also specifies whether or not data in the memory will be overwritten by new data. *modes* are DAV, BURST, END, and COMPLETE.

RESOL *resolution* (HP 44704A only)

Sets HP 44704A resolution. *resolution* can be 13, 14, or 16. For RESOL 16, the voltmeter must not be in autorange mode or an error will be generated. See Chapter 6 for details on 16 bit resolution mode.

SADV *source*

When MEAS is used, sets the source to advance the scan sequence as defined by *source*. Valid sources are SCAN, CHADV, KEY, and PACER.

Table 5-28. Scanner Mode Command Summary

SCANMODE *mode* [USE *ch*]

Sets the voltmeter operating mode. SCANMODE ON sets Scanner Mode operation. The SCANMODE setting is not changed by the high-level commands. For Scanner Mode, when TERM RIBBON is set scanning is under control of the voltmeter through the dedicated ribbon cable. When TERM INT, EXT, or ZERO is set, scanning is under control of the mainframe.

SCDELAY *trig_delay* [*scan_pace*] [USE *ch*]

Sets the delay time between the scan trigger and when the first measurement can be triggered and sets the time between successive scan triggers. SCDELAY *trig_delay* sets the delay time between the scan trigger and when the first measurement can be triggered. Range of *trig_delay* = 0 to 0.01638375 seconds, with power-on value = 0 sec.

SCDELAY [*scan_pace*] is valid only when SCTRIG INT is set. *scan_pace* sets the time between successive scan triggers. Range of *scan_pace* = 0 to 1073.74182375 seconds, with power-on value = 0.002 seconds.

SCSLOPE *mode* [USE *ch*]

When SCTRIG EXT0, EXT1, MEAS, or GPIO is set, SCSLOPE sets the edge of the scan trigger (LH or HL) which will trigger the voltmeter. Power-on *mode* = LH.

SCTRIG [*source*] [USE *ch*]

Specifies the source for the scan trigger. Power-on *source* = HOLD and default *source* = SGL.

SLOPE *mode* [USE *ch*]

For TRIG EXT0, EXT1, MEAS, or GPIO, SLOPE sets the edge (LH or HL) of the input which will generate a measure trigger.

SPER *sample_period* [USE *ch*]

When TRIG INT is set, SPER sets the time between successive measure triggers (sample period). Range for *sample_period* = 0 to 1073.74182375 seconds. (*sample_period* settings from 0 to 10 μ sec are rounded to 10 μ sec.) At power-on, *sample_period* = 10 μ sec.

STRIG *source*

When MEAS is used, sets the source to start the scan sequence as defined by *source*. Valid sources are SCAN, CHADV, KEY, and PACER.

STSLOPE *mode* [USE *ch*]

For STTRIG EXT0, EXT1, MEAS, and GPIO, sets the edge (LH or HL) of the input which will generate a stop trigger. Power-on *mode* = LH.

STTRIG [*source*] [USE *ch*]

Specifies the stop trigger source. Power-on *source* = INT and default *source* = SGL.

TERM *terminal* [USE *ch*]

Selects the voltmeter input terminals. TERM INT selects the mainframe backplane, TERM EXT selects the rear panel terminals, TERM RIBBON selects the ribbon cable, and TERM ZERO selects an internal zero volt reference.

Table 5-28. Scanner Mode Command Summary

TRIG [source] [USE ch]

Sets the source or mode for the measure trigger. The power-on source is HOLD (no trigger) and the default source is SGL (single trigger from source). TRIG MEAS is not valid for Scanner Mode.

TRIGOUT [mode] [USE ch]

Sets whether EXT0 will output triggers or be enabled to receive triggers. With TRIGOUT OFF, EXT0 can receive triggers. With TRIGOUT ON, EXT0 outputs measurement triggers.

USE ch

Specifies the slot to be used for voltmeter commands.

USE? [INTO name] or [fmt]

Returns the current USED channel (or slot) address last set by the USE command.

XRDGS ch [number] [INTO name] or [fmt]

Transfers the number of readings specified by *number* from the voltmeter buffer to the mainframe memory (if INTO name is specified), or to the output buffer and/or display (if INTO name is not specified). Default *number* = 1.



The HP 44704A in 16 Bit Mode

Introduction

This chapter explains how the HP 44704A's 16 bit resolution mode differs from operations explained in Chapters 4 and 5. You should be familiar with subjects covered in Chapters 4 and 5 before reading this chapter.

Chapter Contents

This chapter has four sections:

- **Introduction** provides a chapter overview and summarizes chapter contents.
- **The 16 Bit Data Format** shows why the measurement data format in the voltmeter buffer forces the use of manual range control.
- **Controlling Voltmeter Ranges** explains how voltmeter ranges are set in the absence of auto-ranging.
- **Managing Range Information** shows when and how the voltmeter can determine reading range status, and when and how your program will have to keep track of measurement range.

The 16 Bit Data Format

The HP 44704A has 16 bit wide reading storage memory (Data Buffer). In 13 or 14 bit resolution modes, the 16 bit data width provides room in each reading for two bits of range information. These bits indicate which range was used to make the reading. In 16 bit resolution mode (RESOL 16), all bits are used to store the A/D converter's output value. No space is available to store range information. To be able to keep track of the range at which multiple, buffered readings were made, the voltmeter must not auto-range. Because of this, the HP 44704A's 16 bit resolution mode operates in manual range only (set with RANGE). See Figure 6-1 for the three measurement data formats.

Controlling Voltmeter Ranges

Since the 16 bit resolution mode doesn't use auto-ranging, the high level voltmeter configuration commands CONF, CONFMEAS, and MONMEAS

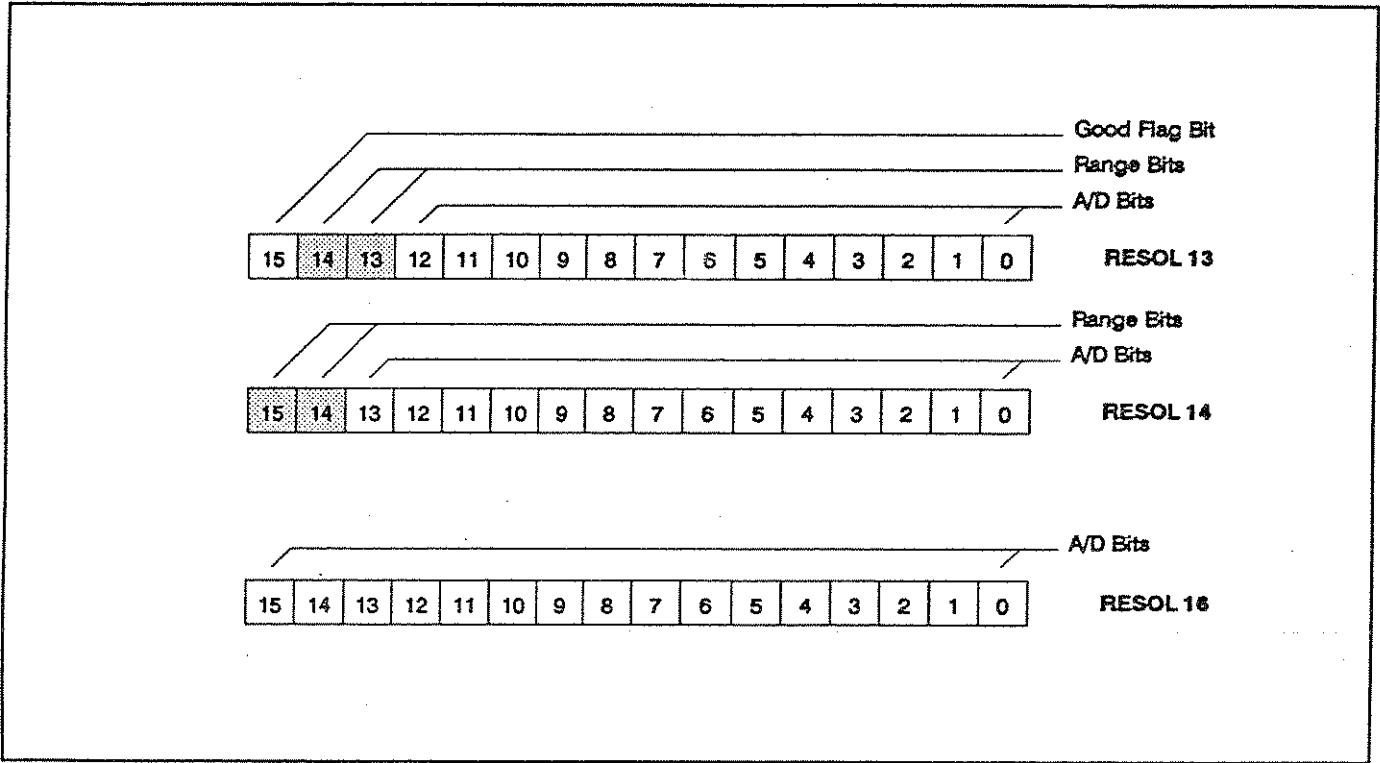

Figure 6-1. The Three Measurement Data Formats

select preset ranges based on the voltmeter function chosen. Table 6-1 shows the function/range relationship.

Table 6-1. CONF, CONFMEAS, and MONMEAS Range Presets

Function:	Measure:	Configure for:	Preset Range:
DCV	Voltage	DC Voltage	10.24V
OHM(F)	Resistance	2 or 4-Wire Ohms	100 K Ω
OHM(F)10K	"	"	10.24 K Ω
OHM(F)100K	"	"	102.4 K Ω
OHM(F)1M	"	"	1.024 M Ω
TEMPtype	Thermocouples	DC Voltage	320 mV
REFT	Reference Temperature	Ohms	25.6 K Ω
THM(F)type	Thermistors (2252 & 5K)	2 or 4-Wire Ohms	10.24 K Ω [1]
"	Thermistors (10K)	"	102.4 K Ω [1]
RTD(F)type	RTDs	"	320 Ω
STRVEX	Strain Bridge Excitation	DC Voltage	10.24 V
STRUN	Bridge Unstrained	"	320 mV
STRQ	Quarter Bridge	"	"
STRFB	Full Bridge	"	"
STRHB	Half Bridge	"	"
STRQTEN	Quarter Bridge in Tension	"	"
STRQCOMP	Quarter Bridge in Compression	"	"
STRHP	Half Bridge Poisson	"	"
STRFBP	Full Bridge Bending Poisson	"	"
STRFP	Full Bridge Poisson	"	"
Notes:			
[1] = For thermistor measurements, the default range chosen gives good resolution at moderate temperatures. For temperatures nearer the thermistor's limits, you may need to change to a more appropriate range (use CONF then RANGE then MEAS).			

Changing Ranges

Since CONFMEAS, and MONMEAS perform voltmeter configuration *and* initiate the measurement cycle, there is no opportunity to change the preset range. See "Measurements Using CONFMEAS" in Chapters 4 and 5 for more information.

CONF selects the same preset ranges as CONFMEAS, and MONMEAS but since CONF *doesn't* initiate a measurement cycle, you can use the RANGE command to change the preset range before executing the MEAS command. See "Measurements Using CONF and MEAS" in Chapters 4 and 5 for more information.

Managing Range Information

All measurements made with the HP High Speed Voltmeters result in integer binary (packed) values being created in the voltmeter's reading buffer. Except when PACKED format is specified, values transferred to the Mainframe's output buffer, or to a Mainframe array (using CONFMEAS, MEAS, CHREAD, or XRDGS) are "unpacked" or converted into a voltage, resistance, temperature, or strain value. When measurements are made in the 13 bit (HP 44702A/B and HP 44704A) or 14 bit resolution mode (HP 44704A

only), the range information is imbedded in the packed readings. The Mainframe uses this information when unpacking these readings. When measurements are made in the 16 bit resolution mode, as mentioned above, range information is *not* part of the packed reading. In this case, the mainframe will use methods discussed in the next two sections to determine the range for unpacking these readings.

The same is true when you unpack readings in your controller which are transferred in PACKED format. The 16 bit resolution readings *do not* contain range information so your application program will have to keep track of the range setting used when the readings were taken.

The following sections discuss managing 16 bit resolution range information for both System Mode measurements (fundamentals in Chapter 4), and Scanner Mode measurements (fundamentals in Chapter 5).

System Mode and Range

When measurements are made in System Mode (SCANMODE OFF), all measurements are made on a fixed range. This is true whether a single reading, multiple readings of a single input (back panel or single multiplexer channel), or readings from several multiplexer channels are made. Once the measurement cycle begins, the range used is that set by RANGE, or the preset selected by CONF or CONFMEAS.

Readings Unpacked in the Mainframe

As the readings are transferred to the Mainframe (except when using PACKED format), they are unpacked using the currently set range. Other than having to control the voltmeter range manually (using the RANGE command), System Mode measurements at 16 bit resolution are executed exactly as they are explained in Chapter 4.

Example: Changing Preset Voltmeter Ranges (RANGE)

This program uses the RANGE command to modify the preset range set by CONF (refer to Table 4-5). RANGE 2 sets the voltmeter to the 2.56V range for each voltage channel measured. RANGE 1000 sets the voltmeter to the 2.56 K Ω range for each resistance channel.

10 DIM Volts(0:4), Ohms(0:7)	<i>! Dimension controller array</i>
20 OUTPUT 709;"USE 600"	<i>! Use voltmeter in mainframe slot 6</i>
30 OUTPUT 709;"RST 600"	<i>! Reset voltmeter</i>
40 OUTPUT 709;"RANGE 10"	<i>! Set manual range so can set</i>
50 OUTPUT 709;"RESOL 16"	<i>! the 16 bit resolution mode</i>
60 OUTPUT 709;"CONF DCV"	<i>! Set DC volts</i>
70 OUTPUT 709;"RANGE 1"	<i>! Change to 2.56V range</i>
80 OUTPUT 709;"MEAS DCV,500-504"	<i>! Measure channels 500-504</i>
90 ENTER 709;Volts(*)	<i>! Enter 5 voltage readings</i>
100 OUTPUT 709;"CONF OHMF10K"	<i>! Presets ohms 10K range</i>
110 OUTPUT 709;"RANGE 1000"	<i>! Change to 2.56K range</i>
120 OUTPUT 709;"MEAS OHM10K,505-512"	<i>! Measure channels 505-512</i>

```

130 ENTER 709;Ohms(*)           ! Enter 8 resistance readings
140 PRINT USING "K,/";Volts(*),Ohms(*) ! Display 13 readings
150 END

```

For a set of 5, 1V and 8, 1KΩ measurements, typical return values are:

```

.9975375
.
.
.
1.001375
993.8125
.
.
.
1003.125

```

5 voltage readings

8 resistance readings

Scanner Mode and Range

In Scanner Mode (SCANMODE ON), you can specify a channel list using the CONFMEAS, MEAS, and MONMEAS commands. All channels specified by these commands will be measured using a single range (whether preset, or set by RANGE). When transferred, the readings will be unpacked using the current RANGE setting. So far, this is the same as in System Mode. But in Scanner Mode there is an additional way to specify a channel list. By using the "channel list write" command:

```
CLWRITE [ribbon_bus] ch_list [RANGE range_list] [USE ch]
```

you can specify a range (RANGE *range_list*) to be used for each channel in the channel list (*ch_list*). In fact, if you execute the CLWRITE *ch_list* command, a range list is created even if you don't specify one. This default range has an entry for each channel specified by *ch_list* and each entry is set to the current RANGE setting.

Correcting Readings made with CLWRITE

To allow high speed reading rates, the CLWRITE's *ch_list* and *range_list* values are stored within the voltmeter's memory rather than the Mainframe's memory. Since the Mainframe can't access this memory, and since 16 bit resolution readings do not contain range information, the mainframe always unpacks 16 bit resolution readings made with CLWRITE as if they were made on the highest range. For the DCV and OHM functions the assumed ranges are:

Function:	Assumed Range
DCV	10.24 V
OHM(F)	102.4 KΩ
OHM(F)10K	10.24 KΩ
OHM(F)100K	102.4 KΩ
OHM(F)1M	1.024 MΩ

This means that each measurement taken on a channel whose range list entry is set to other than the highest range will need to be corrected. For example, if we execute CLWRITE with the range entry for channel 1 set to the 2.56 volt range, apply 1 volt to channel 1 and initiate a measurement cycle. The returned value will be 4 volts because the actual range setting was 2.56 while the Mainframe unpacked the reading assuming the 10.24 volt range, a factor of four higher. The returned value in this example needs to be multiplied by a factor of 1/4.

Table 6-2 lists the correction factors for each function and range combination. Your application program will have to maintain the range values it sends with CLWRITE in order to select the correction factor to apply to the returned readings.

Table 6-2. Correction Factors for CLWRITE

⁽¹⁾ For This Function	⁽²⁾ If CLWRITE Range_list Entry Selects This Range:			
DCV	10.24 V	2.56 V	320 mV	40 mV
OHM(F)10K	10.24 KΩ	2.56 KΩ	320 W	40 Ω
OHM(F) and OHM(F)100K	102.4 KΩ	25.6 KΩ	3.2 KΩ	400 W
OHM(F)1M	1.024 MΩ	256 KΩ	32 KΩ	4 KΩ
⁽³⁾ Use Correction Factor	(none)	1/4	1/32	1/256

NOTE

Strain and temperature measurements should not be performed using CLWRITE in 16 bit resolution mode. Their measurement conversions involve non-linear functions. Simply trying to apply a correction factor to these returned values will introduce significant errors.

Instead, make voltage or resistance measurements of these transducers. Transfer the readings to a mainframe array. Apply the correction factor(s) to the array values. Then convert the corrected values to strain or temperature using the COMPEN command (mainframe firmware revision 3.5 and greater).

Example: Correcting Readings Made With CLWRITE

CLWRITE sets channel lists, voltmeter ranges and ribbon cable connections for Scanner Mode ribbon cable measurements. This program uses CLWRITE to set channels 500 through 509 as the scan list and set the 2.56V range for measurement on each channel. The program takes one measurement on each channel for a total of ten measurements.

After the measurements have been made and returned to the controller, they are corrected for display.

```
10 DIM A(0:9) ! Define controller array
20 OUTPUT 709;"USE 600" ! Use voltmeter in mainframe slot 6
30 OUTPUT 709;"RST 600" ! Reset voltmeter
40 OUTPUT 709;"RANGE 2" ! Set manual range for RESOL 16
50 OUTPUT 709;"RESOL 16" ! Set 16 bit resolution
60 OUTPUT 709;"SCANMODE ON" ! Set Scanner Mode
70 OUTPUT 709;"CONF DCV" ! Configure for DC volts
80 OUTPUT 709;"CLWRITE 500-509,RANGE 2" ! Set scan list and range
90 OUTPUT 709;"SCTRIG INT" ! Trigger the voltmeter
100 OUTPUT 709;"XRDGS 600" ! Read 10 readings
110 ENTER 709;A(*) ! Enter 10 readings
120 MAT A = A/(4) ! Correct each reading in array A
130 PRINT USING "K, /";A(*) ! Display 10 corrected readings
100 END
```

For a set of 2 V 5% sources connected to channels 500 through 509, a typical return (values in volts) is:

1.98945325, 2.02265625, ... 1.98253476

Unpacking Readings in Your Controller

When you transfer PACKED readings to your controller for unpacking, no correction factor needs to be applied to these values, but your application program will have to maintain the CLWRITE range list values to use while unpacking the readings.

Example: Unpacking Readings in the Controller Made With CLWRITE

This program makes measurements at 80,000 readings/second, transfers the readings to the controller at approximately 35,000 readings per second, and unpacks the readings in the controller. The example includes the unpacking function for 16 bit resolution (RESOL 16) readings.

The program makes 25 measurements (5 readings on each of 5 channels) and stores them in mainframe array PARR in PACKED format. The readings are transferred to the output buffer with the VREAD command and then

transferred to the controller with the TRANSFER statement. The packed readings are then unpacked by the controller. Since packed DC voltage readings have a 2 bytes/reading format, PARR must be defined for 50 bytes.

Since SPER is set for 12.5 μ sec, measurements are taken at 12.5 μ sec intervals. SCDELAY 0 sets 0 sec scan trigger delay. Note that the front panel display is turned off with DISP OFF. This is very important for high-speed scans as it greatly improves system performance.

```

30 ! Define I/O paths, buffer, array
40 OPTION BASE 0                ! Set option base 0
50 INTEGER Bdata(1:25) BUFFER   ! Define controller buffer
60 ASSIGN @Dac to 709          ! HP 3852A I/O address
70 ASSIGN @Hp_3852 TO 709;FORMAT OFF ! Set up HP-IB path
80 ASSIGN @Bdata to BUFFER Bdata(*);FORMAT OFF! Controller buffer path
90 OUTPUT @Dac;"PACKED PARR(49)" ! HP 3852A packed array
100                             !
110 ! Set up voltmeter and transfer data
120 OUTPUT @Dac;"USE 600"       ! Use voltmeter in MF slot 6
130 OUTPUT @Dac;"RANGE 2"      ! Set man range for RESOL cmd
140 OUTPUT @Dac;"RESOL 16"     ! Set 16 bit resolution mode
150 OUTPUT @Dac;"DISP OFF"     ! Mainframe display off
160 OUTPUT @Dac;"SCANMODE ON"  ! Set Scanner Mode
170 OUTPUT @Dac;"CONF DCV"     ! Configure for DC volts
180 OUTPUT @Dac;"NRDGS 5"      ! Set 5 readings/channel
190 OUTPUT @Dac;"SPER 12.5E-6" ! Set 12.5  $\mu$ sec between meas
200 OUTPUT @Dac;"SCDELAY 0"    ! Set 0 msec scan trig delay
210 OUTPUT @Dac;"CLWRITE 500-504,RANGE 2"! Set ch 500-504 as scan list, 2.56 V
                                     range
220 OUTPUT @Dac;"ASCAN ON"     ! Single scan trigger required
230 OUTPUT @Dac;"SCTRIG SGL"   ! Single scan trigger
240 OUTPUT @Dac;"XRDGS 600,25 INTO PARR"! Transfer rdgs to mainframe
250 OUTPUT @Dac;"VREAD PARR,PACK" ! Transfer rdgs to output buffer
260 TRANSFER @Hp_3852 TO @Bdata;END,WAIT! Transfer rdgs to controller
270                             !
280 ! Unpack PACKED data
290 FOR I = 1 TO 25
300 PRINT FNUnpk16(Bdata(I),0,2) ! Unpack rdgs (pass DCV func code,
                                     2.56V range code)
310 NEXT I
320 END

```

The following example describes the 16 bit unpacking function for this example.

16 Bit Unpacking Function The following example shows an HP BASIC function which unpacks 16 bit resolution readings, given the reading, a function code, and a range code. This example can be used as part of the previous example. The formula used in this example program is:

$$\frac{16 \text{ bit two's compliment } A \text{ to } D \text{ Value}}{3200 * (f_range)} * (f_func)$$

Where: f_range, and f_func are:

Functions	Func_code	f_func	Ranges			
DCV	0	1	40 mV	320 mV	2.56 V	10.24 V
OHM(F)10K	1	1E3	40 W	320 W	2.56 KΩ	10.24 KW
OHM(F)100K	2	1E4	400 W	3.2 KW	25.6 KW	102.4 KΩ
OHM(F)1M	3	1E5	4 KW	32 KW	256 KW	1.024 MΩ
f_range			256	32	4	1
Range_code			0	1	2	3

Example: 16 Bit Unpacking Function

Choose Func_code, and Range code from the table above

```

330 DEF FNUnpk16(INTEGER Bdata,Func_code,Range_code)
340 REAL R(0:3) ! Array holds "f_range"
350 DATA 256.,32.,4.,1. ! Code: 0=40mV, 1=320mV,
2=2.56V, 3=10.24V

360 READ R(*)
370 REAL F(0:3) ! Array holds "f_func"
380 DATA 1.,1.E3,1.E4,1.E5 ! Code: 0=DCV, 1=OHM10K,
2=OHM100K, 3=OHM1M

390 READ F(*)
400 IF Bdata = 32767 OR Bdata = -32768 THEN ! If max + or max - then
410 Result = 1.E+38 ! Return overload indication
420 ELSE
430 Result = Bdata/(3200*R(Range_code))*F(Func_code),  $\frac{A \text{ to } D \text{ Value}}{3200 (f\_range)} (f\_func)$ 
440 END IF
450 RETURN Result
460 FNEND ! End 16 bit unpack function

```

Entering 16 Bit Resolution Mode

The HP 44704A can not be in auto-range mode when entering the 16 bit resolution mode. If a manual range has not been selected since a RST command was executed, the RESOL 16 command will generate an error. To properly enter the 16 bit resolution mode, execute RANGE range, then execute RESOL 16.

Example: Entering 16 Bit Resolution Mode

```
.  
. .  
20 OUTPUT 709;"USE 600"           / Use voltmeter in mainframe slot 6  
30 OUTPUT 709;"RST 600"           / Reset voltmeter (sets 13 Bit Mode)  
40 OUTPUT 709;"RANGE 10"         / Set any manual range to  
50 OUTPUT 709;"RESOL 16"         / allow RESOL 16 to work  
60 OUTPUT 709;"CONF DCV"         / Set DC volts (presets 10.24V range)  
70 OUTPUT 709;"RANGE 1"         / Select measurement range  
80 OUTPUT 709;"MEAS DCV,500-504" / Measure channels 500-504  
. . .
```

GPIO Operation

Introduction

This chapter shows how to use the HP 98622A General-Purpose Input/Output Interface (GPIO Interface) with an HP Series 200/300 controller for data transfer and operation with the HP 44702A/B or HP 44704A voltmeter. The voltmeter is set for Scanner Mode ribbon cable operation with RDGS GPIO set.

NOTE

You should be familiar with the HP High-Speed voltmeter in Scanner Mode operation before using GPIO operation. Refer to Chapter 5 - Scanner Mode Programming for details on Scanner Mode operation.

The chapter contains three sections:

- **The GPIO Interface** summarizes GPIO signals, shows how to set the Option Select Switches and Data In Clock Source Switches, and summarizes input/output timing requirements for GPIO operation.
- **GPIO Programming** summarizes programming the voltmeter over GPIO for data transfers, triggering, and interrupts.
- **Programming Examples** shows example programs to use the GPIO Interface for data transfers, triggering, and interrupts.

The GPIO Interface

This section describes GPIO interface signals for the HP 44702A/B and HP 44704A voltmeter, shows how to set the Option Select and Data In Clock Source switches, and summarizes input/output timing diagrams for GPIO operation. The descriptions assume an HP Series 200/300 controller (called the GPIO controller) or equivalent is used.

GPIO Interface Signals

Figure 7-1 shows the GPIO signals which apply to the voltmeter and Table 7-1 defines the signals. It is assumed that the HP High-Speed voltmeter is the peripheral and the GPIO controller is at the other end of the bus. Signals and the direction of propagation are defined relative to the controller.

Table 7-1. GPIO Signal Definitions

Conn	Name	Description
DO00 - DO15	Data Output Bus	16 lines driven by the GPIO controller which contain valid data during WRITE operations.
DI00 - DI15	Data Input Bus	16 lines driven by the voltmeter which contain valid data during READ operations.
$\overline{\text{PCTL}}$	Peripheral Control	Driven by the GPIO controller and initiates a transfer on its falling edge. Acknowledges the peripheral's response by returning high.
PFLG	Peripheral Flag	Driven by the voltmeter. Indicates when data is valid during READ operations and when data is accepted during WRITE operations.
$\overline{\text{VO}}$	Input/Output Control	Driven by the GPIO controller and indicates data direction relative to the controller. A high indicates the GPIO controller is ready to receive data.
$\overline{\text{PSTS}}$	Peripheral Status	Driven by the voltmeter. Indicates to the GPIO controller that the GPIO cable is connected and the voltmeter is powered up.
$\overline{\text{PRST}}$	Peripheral Reset	Forces an unconditional reset to power-on conditions in the voltmeter. Since HP Series 200/300 controllers generate a Peripheral Reset on power-on (and other times), the voltmeter has a jumper installed to disable the Peripheral Reset. As desired, the user can remove this jumper to enable the reset (see Figure 7-2 for JMO location).
$\overline{\text{EIR}}$	External Interrupt	Driven by the voltmeter. Can be used to interrupt the GPIO controller when user defined conditions occur. This signal can be disabled. Also, for operation with an HP 1000 or equivalent, the EIR line can be inverted by removing jumper JM07 (see Figure 7-2 for JM07 location).
$\overline{\text{CTL0}}$	Control (Data/Address)	Driven by the GPIO controller and used by the voltmeter to determine if information being sent is address or data. Logical "1" (low voltage level) indicates the information is an address, logical "0" indicates the information is data.
$\overline{\text{CTL1}}$	Control (Trigger)	Driven by the GPIO controller and is used as a trigger source to the voltmeter.
$\overline{\text{STI0}}$ and $\overline{\text{STI1}}$	Status	Driven by the voltmeter. Both lines are always active. A logical "1" on the $\overline{\text{STI0}}$ line indicates an End of Scan service request. A logical "1" on the $\overline{\text{STI1}}$ line indicates a Measurement Available service request [1]. The user may read these lines at any time to determine their status or may wait for the EIR (external interrupt) signal and then determine the cause of the interrupt by checking the status of these lines.
<p>Notes:</p> <p>[1] = An End of Scan service request is generated when RDGSMODE END or RDGSMODE COMPLETE is set and the scan sequence ends. A Measurement Available service request is generated when RDGSMODE DAV or RDGSMODE BURST is set and a measurement is available.</p>		

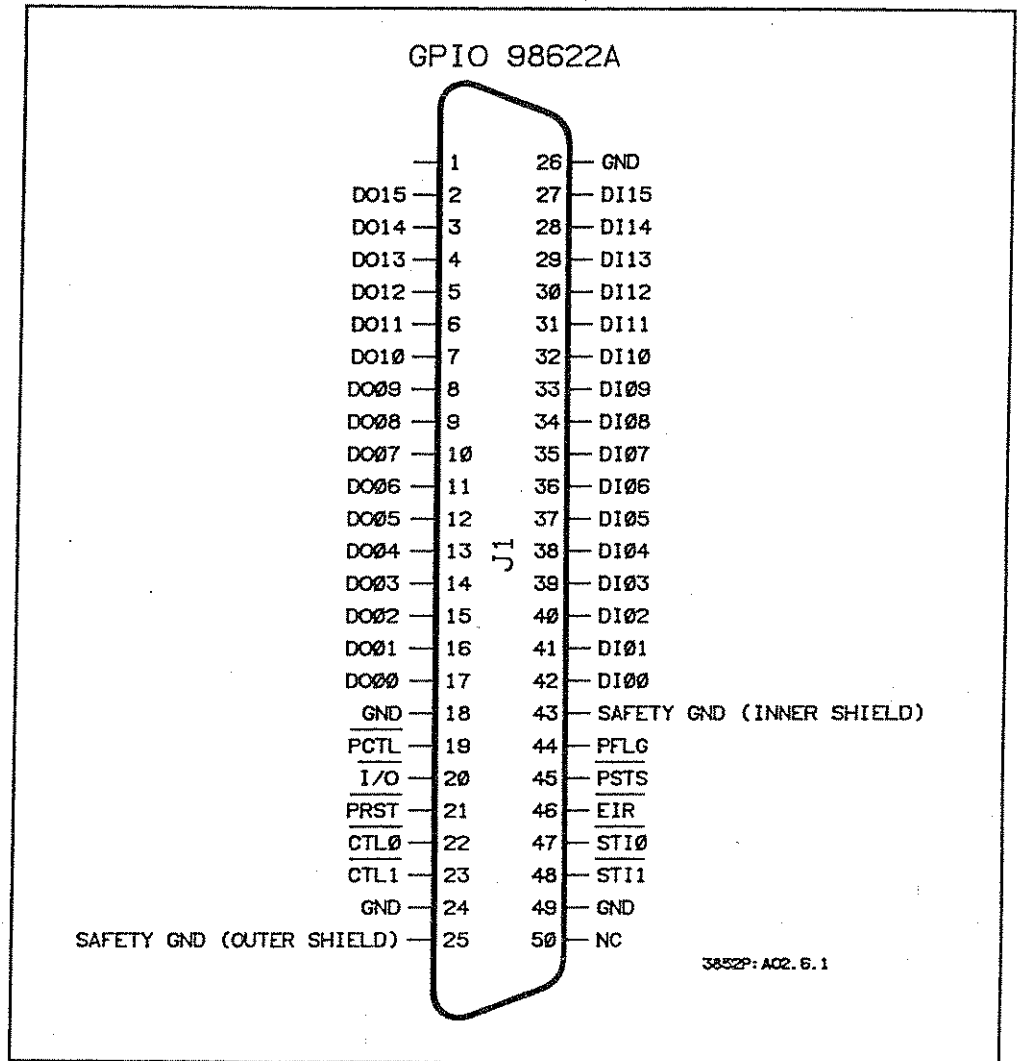

Figure 7-1. GPIO Signals

GPIO Signal Timing

Figure 7-3 shows GPIO signal timing for input and output signals when Full Mode Handshake Mode is set.

GPIO Interface Switches

The HP 98622A (GPIO) Interface Card has four switches which can be set for desired operation: Interface Select Code, Interrupt Level, Data-In Clock Source, and Option Select. Figure 7-4 shows switch locations and shows the Options Select and Data In Clock Source Switch settings required for GPIO operation with the HP 44702A/B or HP 44704A voltmeter.

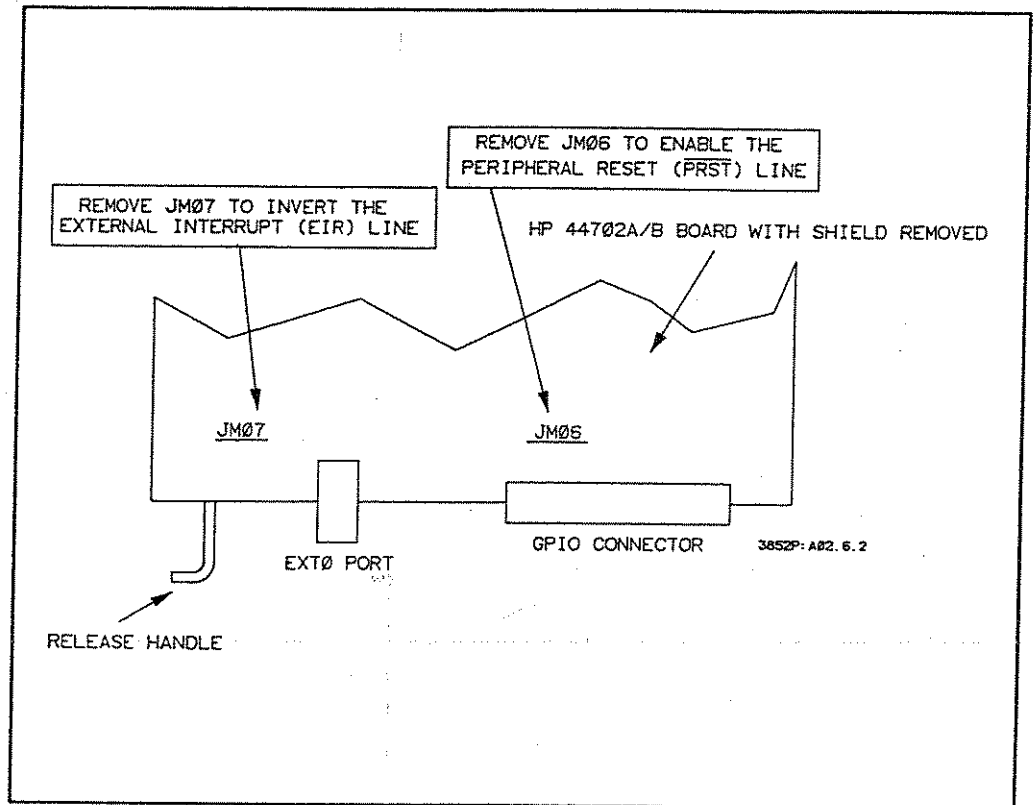

Figure 7-2. Peripheral Reset Jumper Location

When you have configured the GPIO Interface Card, install the card in the controller and connect the GPIO Interface cable to the card. Then, connect the other (male) end of the cable to the standard 50-pin female connector on the voltmeter rear panel.

GPIO Programming

This section gives guidelines to program the voltmeter for GPIO operation, including data transfers, voltmeter triggering, and enabling interrupts. Refer to Chapter 8 - Using Read/Write Registers as required for definitions of voltmeter registers. For convenience, Figure 7-5 shows the HP Series 200/300 Control and Interrupt Registers used with the HP 44702A/B or HP 44704A voltmeter.

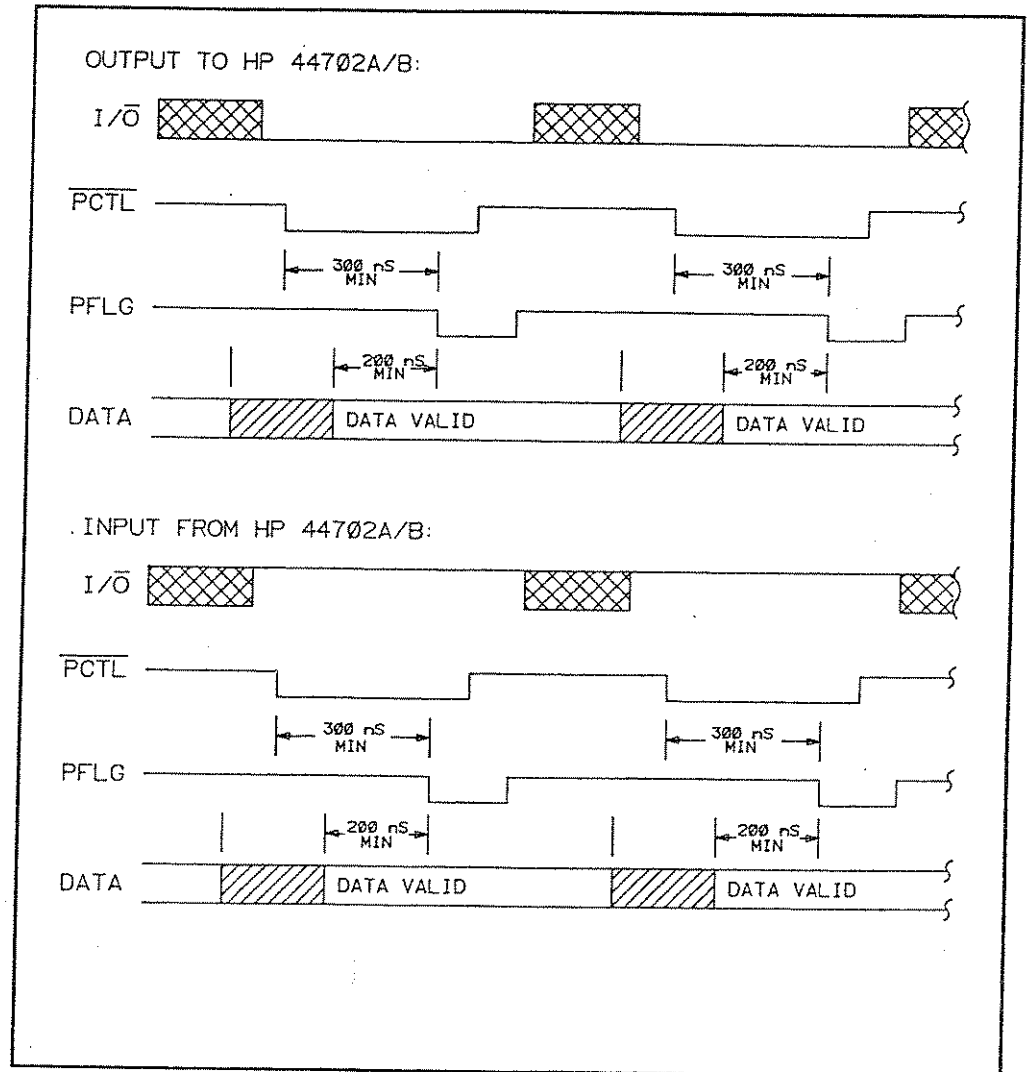
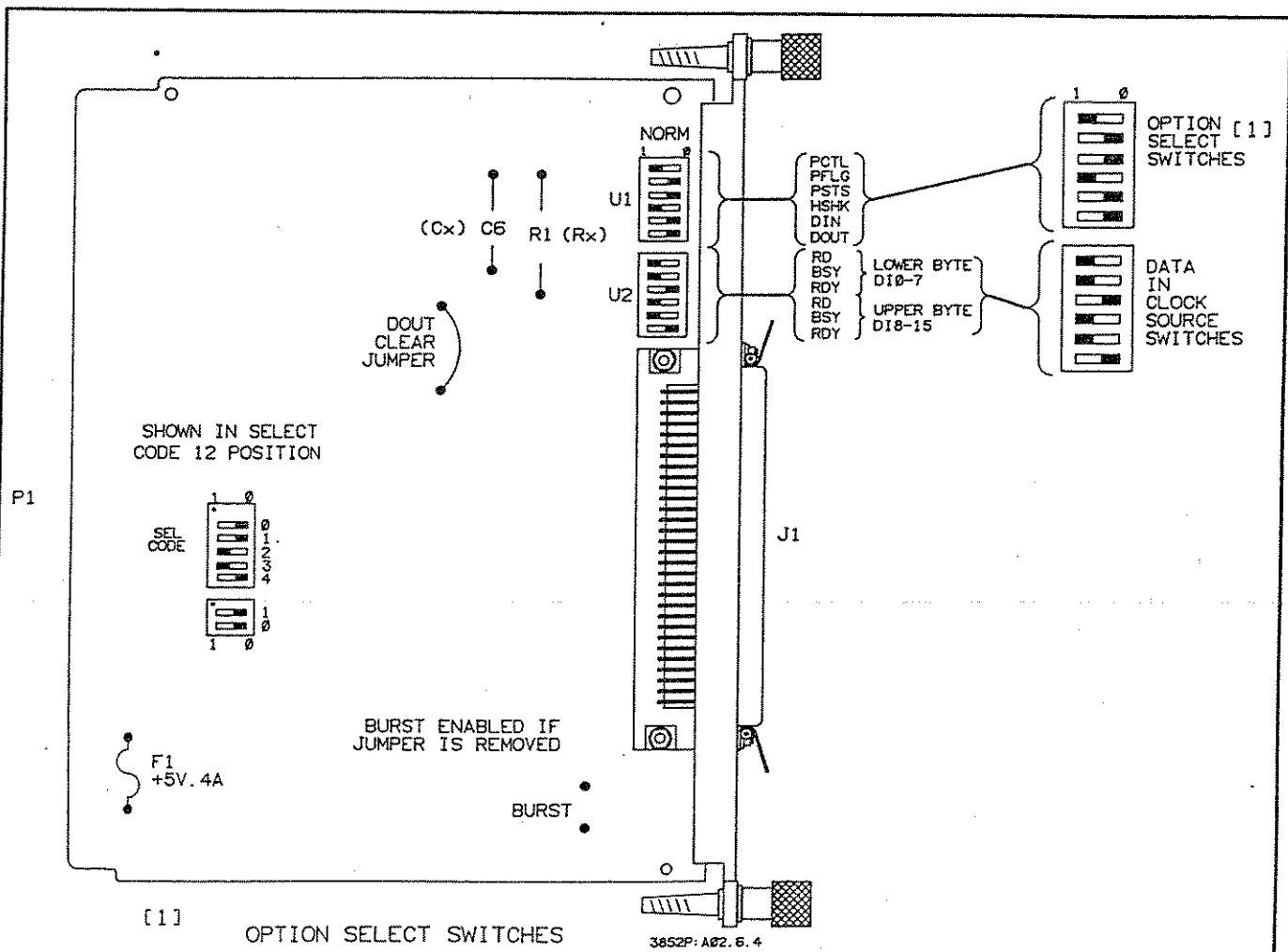

Figure 7-3. GPIO Signal Timing

GPIO Data Transfers

With GPIO operations, you can transfer readings directly from the voltmeter data buffer to the controller at rates up to 100,000 readings per second. Figure 7-6 shows typical physical configuration required for 100,000 readings per second transfer rates. (The Disc Interface and Disc Drives shown are not required unless you want to store data on hard disc.)



Switch Position Name	DOUT	DIN	HSHK	PSTS	PFLG	PCTL
Function	Invert Data Out	Invert Data In	Full/Pulse Handshake	Invert PSTS	Invert PFLG	Invert PCTL
Logic 1 (Switch Open)	Low = 1 High = 0	Low = 1 High = 0	Fail	Low = $\overline{\text{OK}}$ High = OK	Low = Rdy High = Bsy	Low = Set High = Clr
Logic 0 (Switch Closed)	Low = 0 High = 1	Low = 0 High = 1	Pulse	Low = OK High = $\overline{\text{OK}}$	Low = Bsy High = Rdy	Low = Clr High = Set

Shaded block shows settings for operation with HP 44702A/B

Figure 7-4. HP 98622A GPIO Interface Card Switches

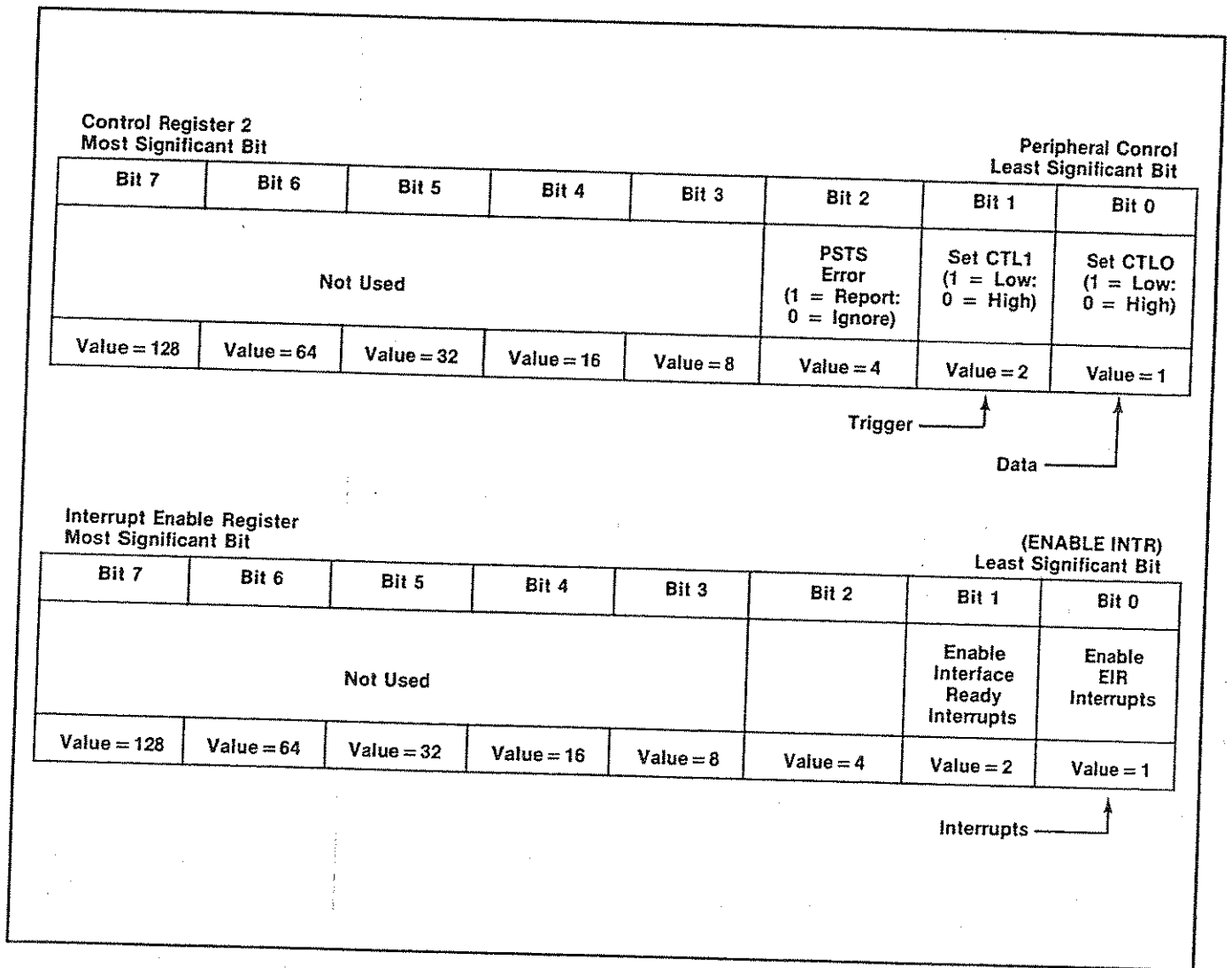

Figure 7-5. GPIO Control and Interrupt Registers

To transfer data via GPIO, RDGS GPIO must be set and CONTROL and ENTER statements from an HP Series 200/300 controller are used to transfer the data over GPIO.

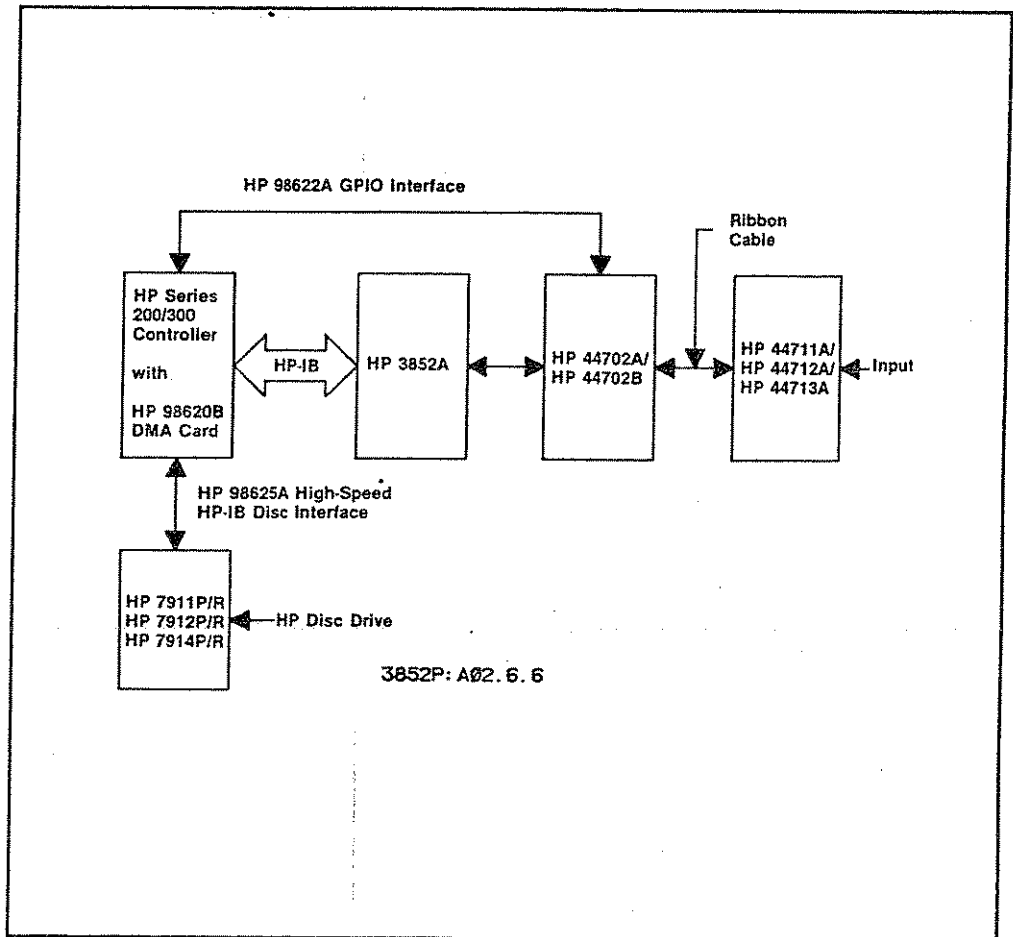

Figure 7-6. GPIO Data Transfer Configuration

NOTE

Data transfers within the digital section of the voltmeter share a common bus. Therefore, any data transfer request must wait until the internal bus is not busy. When measurements are being taken and sent to the GPIO controller at the maximum A/D conversion rate, the bus is about 40% utilized. Excessive access to voltmeter registers, such as repeated status checks can dominate the bus and may cause the data to be lost.

NOTE

Data is transferred over GPIO in unconverted (PACKED) format and must be unpacked in the controller to be readable. Refer to "Programming Examples" for typical unpacking routines.

Example: Transferring Data (GPIO)

In this example, line 10 assigns an I/O path to a GPIO interface with Interface Select Code = 12. Line 100 sets Control Register 2 PSTS Error bit (bit 2) high and sets CTL0 (bit 0) low. Setting CTL0 low tells the voltmeter that the next piece of data is a register address.

Line 110 addresses the voltmeter Data Buffer register (address 4) to provide access to the data stored in the voltmeter data buffer. Line 120 then sets CTL0 high to allow data transfer from the voltmeter data buffer to the controller and keeps the PSTS Error bit set. Line 130 enters the data from the data buffer to the controller.

```
10 ASSIGN @Gpio TO 12;FORMAT OFF,WORD ! Assign I/O path to GPIO
```

```
.  
. 100 CONTROL 12,2;5 ! Set PSTS bit and set CTL0 low  
110 OUTPUT @Gpio;4 ! Address Data Buffer register  
120 CONTROL 12,2;4 ! Set PSTS bit and set CTL0 high  
130 ENTER @Gpio;A(*) ! Enter Data Buffer register values  
.  .
```

GPIO Triggering

The voltmeter can be triggered over GPIO by toggling bit 1 (the CTL1 bit) on Control Register 2 (recall that CTL0 controls data transfers). Depending on the SCTRIG, SCSLOPE, TRIG, STTRIG, and STSLOPE settings, changing CTL1 from low to high or high to low generates a scan, measure, or stop trigger. For example, with SCTRIG GPIO and SCSLOPE HL, changing CTL1 from high to low generates a scan trigger.

Example: Generate GPIO Scan Trigger

A typical sequence to send a scan trigger over GPIO follows, assuming SCTRIG GPIO and SCSLOPE HL are set. Line 100, sets the PSTS Error bit and sets the CTL1 bit high. Then, line 110 sets the PSTS Error bit and sets CTL1 low which generates a scan trigger on the high-to-low transition.

```

.
.
100 CONTROL 12,2;4           / Set PSTS Error bit and set CTL1 high
110 CONTROL 12,2;6           / Set PSTS Error bit and set CTL1 low
.
.
.
.

```

GPIO Interrupts Interrupts to the GPIO controller can be enabled by setting bit 0 (Enable EIR Interrupts) in the Interrupt Enable Register. For the HP 44702A/B or HP 44704A voltmeter, setting the EIR line = 1 sets the interrupt line.

Example: Setting GPIO Interrupts

A typical sequence to set EIR interrupts follows.

```

.
.
30 ASSIGN @Hp_3852A TO 709     / Assign I/O path to HP 3852A
40 OUTPUT @Hp_3852A;"RDGS GPIO" / GPIO is readings destination
50 OUTPUT @Hp_3852A;"ENABLE INTR" / Enable interrupt capability
.
.
110 ASSIGN @Gpio TO 12;FORMAT OFF,WORD / Assign GPIO I/O path
120 INTEGER A(0:9)             / Define array
130 ON INTR SC(@Gpio) GOSUB Rdgs / Branch on interrupt
140 ENABLE INTR SC(@Gpio);1     / Enable interface
.
.
350 Rdgs:ENTER @Gpio;A(*)      / Enter readings
.
.

```

Programming Examples

This section shows two programs for GPIO operation, including data transfers, voltmeter triggering, and interrupts. For each example, the voltmeter is in mainframe slots 6 and 7 and is connected via ribbon cable to an HP 44711A/B multiplexer in slot 5 of the mainframe. The GPIO interface select code is 12.

The first example "GPIO Operations" shows basic methods to transfer data, generate voltmeter triggers, and generate voltmeter interrupts using GPIO. The second example "Transfer Data @ 100 kHz" shows a way to transfer data from the voltmeter to a mass storage unit at 100,000 readings per second.

Example: GPIO Operations

This program demonstrates GPIO data transfers, triggering, and interrupts. The voltmeter is configured over HP-IB and then triggered over GPIO. When all readings have been taken and stored in the voltmeter data buffer, an interrupt is generated over GPIO. The readings are then transferred via GPIO to the controller and unpacked.

NOTE

Lines 500 - 560 are not required for the program. They are listed to show that the controller can do other tasks (counting to 1000 for this example) while waiting for the measurements to complete (interrupt to occur).

Assign I/O Paths, Define Array

Lines 40-70 assign I/O paths for GPIO and the HP 3852A, using GPIO Interface Select Code = 12 and HP-IB Interface Select Code = 9. Line 50 assigns an I/O path for GPIO, line 60 defines the GPIO Interface Select Code as 12, and line 70 defines an INTEGER array in the controller.

Set Up Voltmeter

The voltmeter is configured for Scanner Mode ribbon cable operation to take 10 readings on a single channel (channel 500) at 0.1 second intervals. The scan trigger source is set for GPIO and the scan trigger slope is high-to-low.

Wait for Mainframe Ready

The controller monitors bit 4 of the mainframe status register (the RDY bit). When the mainframe is ready to accept inputs from GPIO (not BSY), the WHILE .. ENDWHILE loop ends.

Enable GPIO Interrupt

Lines 330 - 350 enable the GPIO interface for an interrupt from the voltmeter. Line 340 sets bit 0 of the Interrupt Enable Register (see Figure 7-5) which enables EIR interrupts. Since RDGSMODE END is set (line 180), an interrupt is generated only when all readings are stored (at the end of the scan sequence).

Set Data Buffer Register

Lines 390 - 460 set access to the voltmeter data buffer or set scan triggering. For the CONTROL statements in these lines, the PSTS Error bit (bit 2) is always set in addition to the settings described for CTL0 and CTL1.

Lines 390 - 410 access the Data Buffer register. The Data Buffer "register" is not actually a register, but provides an access path to the voltmeter data buffer. Line 390 sets Control Register 2 CTL1 bit (bit 1) high and sets CTL0 bit (bit 0) low.

For the voltmeter, the CTL1 bit is used for GPIO triggering while the CTL0 bit is used with the Data Buffer register. Setting CTL0 low (line 390) tells the voltmeter that the next piece of information is data. Line 400 accesses the Data Buffer register (register address 4) and line 410 resets CTL0 to high.

Trigger the Voltmeter

Lines 450 and 460 generate the scan trigger for the voltmeter via GPIO. Since SCTRIG GPIO (line 240) and SCSLOPE HL (line 200) are set, a high-to-low pulse input to the GPIO port will generate a scan trigger. Note that CONTROL Gpio,2;4 (line 410) set CTL1 high. Since CONTROL Gpio,2;6 (line 450) sets CTL1 low, a high-to-low pulse is generated which initiates the voltmeter scan trigger. Line 460 sets CTL1 back to high.

Transfer and Unpack Data

When the 10 readings are taken, a voltmeter interrupt is generated and the readings are transferred via GPIO to the controller. Since readings are transferred in PACKED (16-bit) format, they are unpacked in the controller. Unpacking functions for both 13 bit and 14 bit modes are included in this example. Call the appropriate one by editing line 620.

```

10 /
20 / Assign I/O paths, define array
30 /
40 ASSIGN @Comp TO 709 / Assign I/O path to HP 3852A
50 ASSIGN @Gpio TO 12;FORMAT OFF,WORD / Assign I/O path to GPIO
60 Gpio = 12 / GPIO Interface Select Code
70 INTEGER A(1:10) / Define controller array
90 /
100 / Set up voltmeter
110 CLEAR @Comp / Clear HP-IB
120 OUTPUT @Comp;"RST" / Reset HP 3852A
130 OUTPUT @Comp;"USE 600" / Use voltmeter in mainframe slot 6
140 OUTPUT @Comp;"SCANMODE ON" / Set Scanner Mode
150 OUTPUT @Comp;"CONF DCV" / Configure for DC volts
160 OUTPUT @Comp;"RANGE 9" / Set 10.24V range
170 OUTPUT @Comp;"RDGS GPIO" / GPIO port is destination
180 OUTPUT @Comp;"RDGSMODE END" / Interrupt when scan seq completes
190 OUTPUT @Comp;"NRDGS 10" / Set 10 readings per channel
200 OUTPUT @Comp;"SCSLOPE HL" / Scan trigger on HL slope
210 OUTPUT @Comp;"SPER .1" / 0.1 sec between measurements
220 OUTPUT @Comp;"ENABLE INTR" / Enable voltmeter interrupts
230 OUTPUT @Comp;"CLWRITE 500" / Set ch 500 as scan list
240 OUTPUT @Comp;"SCTRIG GPIO" / GPIO is scan trigger source
250 /
260 / Wait until mainframe is ready
270 /
280 WHILE NOT BIT(SPOLL(@Comp),4) / Wait until ready
290 END WHILE
300 /
310 / Enable GPIO interrupt
320 /
330 ON INTR Gpio GOSUB Get_rdgs / Go to subroutine on interrupt
340 Eir = 1 / Set Enable Intr Reg bit 0
350 ENABLE INTR Gpio;Eir / Enable GPIO interface
360 /
370 / Set Data Buffer Register
380 /
390 CONTROL Gpio,2;5 / Set CTL1 high and CTL0 Low
400 OUTPUT @Gpio;4 / Address Data Buffer register
410 CONTROL Gpio,2;4 / Set CTL1 high and CTL0 high
420 /
430 / Trigger the voltmeter
440 /
450 CONTROL Gpio,2;6 / Set CTL1 low and CTL0 high

```

```

460 CONTROL Gpio,2;4           / Set CTL1 high and CTL0 high
470 /
480 / Display count while readings are taken
490 /
500 INTEGER Cnt               / Define INTEGER variable
510 Cnt=0
520 WHILE (Cnt < 1000)        / Begin count sequence
530 Cnt = Cnt + 1             / Increment count
540 DISP Cnt                  / Display count
550 END WHILE                 / End count sequence
560 STOP
570 /
580 / Transfer data from voltmeter to controller
590 /
600 Get_rdg5; ENTER @Gpio;A(*) / Enter readings via GPIO
610 FOR I = 1 TO 10
620 PRINT USING "K,/";FNUUnpk13(A(I)) / Display readings
630 NEXT I
640 END
650 /
660 / Unpacking functions
670 /
680 DEF FNUUnpk13(INTEGER Pack) / Define 13 bit unpack function
690 REAL R(0:3)
700 DATA 256.,32.,4.,1.
710 READ R(*)
720 M = BINAND(Pack,4095)
730 IF Pack > 0 OR M = 4095 THEN
740 RETURN 1.E + 38
750 ELSE
760 V = M*.0025/R(BINAND(SHIFT(Pack,13),3))
770 IF BIT(Pack,12) THEN V = -V
780 RETURN V
790 END IF
800 FNEND                     / End 13 bit unpack function
810 DEF FNUUnpk14(INTEGER Pack) / Define 14 bit unpack function
820 REAL R(0:3)               / Alloc. range factor array
830 DATA 256.,32.,4.,1.     / Range function data
840 READ R(*)                 / Fill array with range factors
850 / Convert A/D bits and range bits to volt reading
860 V = SHIFT(BINAND(16383,Pack),-2)/4*.00125/R(BINAND(SHIFT(Pack,14),3))
870 RETURN V
880 FNEND                     / End 14 bit unpack function

```

For a 9 volt 5% source connected to channel 500, a typical return follows. If, for example, 161 counts occurred before the readings are displayed, 161 also appears on the display.

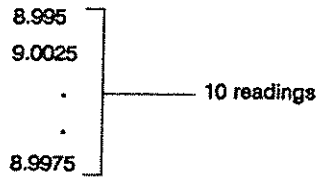

Example: This example shows how to transfer readings from an HP 44702A/B or HP 44704A (in 13 bit mode) voltmeter to an HP 7912P/R (CS80) mass storage unit via an HP 98622A GPIO Interface at 100,000 readings per second.
Transfer Data @ 100 kHz

The program requires an HP 200/300 Series controller with an HP 98620B DMA card and requires an HP 98625A High-Speed HP-IB Disc Interface between the controller and the HP 7912P/R disc. Figure 7-7 summarizes the I/O path assignments and file names for this program. A program summary follows.

Define Arrays, Variables, and Buffers

Lines 40 - 90 define arrays, variables, and buffers used and define the default msus. Two buffers are defined for the HP Series 200/300 controller. *Packed* is a 10240 element (20 kbyte) INTEGER array/buffer for temporary storage of packed readings. *Unpacked* is a 10240 element (80 Kbyte) REAL array/buffer for temporary storage of unpacked readings.

NOTE

The Packed and Unpacked arrays/buffers must contain the same number of elements.

Tot_rdgs specifies the total number of readings desired, *Pre_scan* sets the number of prescans, and *Post_scan* sets the number of postscans. Select the number of readings, prescans, and postscans required as long as;

$$\frac{Tot_rdgs}{(Pre_scan + Post_scan)} \leq 65,535 .$$

The MASS STORAGE IS specifier sets the HP 7912P/R disc (via the HP 98625A High-Speed HP-IB Disc Interface) as the default msus.

Error Trap 1

Pack_rdgs is a BDAT file in the HP 7912P/R (created on line 190). This error trap applies if *Pack_rdgs* has been previously created by running this program

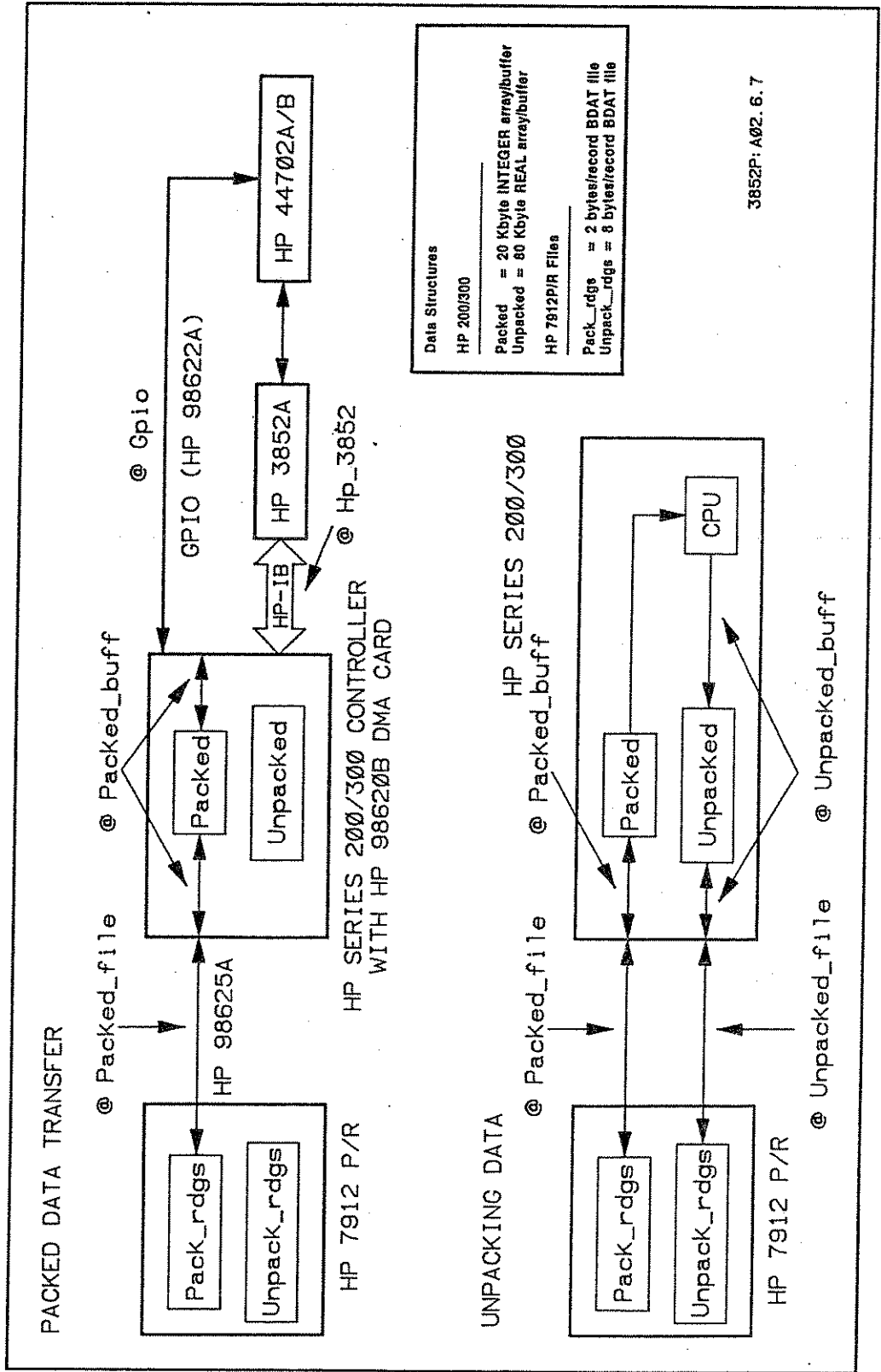

Figure 7-7. Example I/O Paths and File Names

or by another program. If *Pack_rdgs* exists, it is purged. If not, the program continues execution.

Create I/O Paths and Data File

Lines 190 - 230 create a data file and assign I/O paths. *Pack_rdgs* is a BDAT file in the HP 7912P/R with 2 bytes/record and a capacity of *Tot_rdgs*. *@Hp_3852* is the I/O path for the HP 3852A and *@Gpio* is the I/O path for GPIO (ISC = 12). *@Packed_file* is the path from the controller to *Pack_rdgs* and *@Packed_buff* is the I/O path for the Packed buffer.

Configure the Voltmeter

The voltmeter is configured for Scanner Mode DC voltage measurements on the 10.24V range. The readings destination is the GPIO port and readings are taken at 10 μ sec intervals (100,000 readings/second). For this program, the voltmeter is set for 10 prescans, 10 postscans, and 100,000 readings on channel 500. (Note the space between NRDGS, PRESCAN, and POSTSCAN and the " mark in lines 350, 380, and 390 is required.)

Set Data Buffer Register

To transfer data via GPIO, set CTL0 low (line 450) then address the Data Buffer register (line 460), then set CTL0 high (line 470) for data.

Trigger the Voltmeter

Trigger the voltmeter with a scan trigger from the mainframe (SCTRIG SGL). Since ASCAN ON is set, only a single scan trigger is required.

Transfer Packed Data

Lines 560 and 570 transfer packed data from the voltmeter to the controller and then to the HP 7912P/R. If the transfer stops before all data is transferred, the program jumps to the GPIO timeout subroutine (lines 1090 - 1130). TRANSFER *@Gpio* TO *@Packed_buff* (line 560) transfers packed data to the Packed buffer. TRANSFER *@Packed_buff* TO *@Packed_file*, (line 570) transfers the data to *Packed_rdgs* in the HP 7912P/R.

NOTE

While data is being transferred, the controller can do other tasks. The task statements can be inserted at lines 580 - 600. However, to maintain the 100,000 readings/sec rate, these "other tasks" should not include I/O operations over the HP 98625A interface.

Close I/O Paths

Lines 610 - 640 close I/O paths *@Gpio*, *@Packed_file*, and checks the status of *@Packed_buff*. Line 650 prints the number of (packed) readings transferred to *Packed_rdgs*.

Error Trap 2

Unpk_rdgs is a BDAT file in the HP 7912P/R (created on line 750). This error trap applies if *Unpk_rdgs* has been previously created by running this program or by another program. If *Unpk_rdgs* exists, it is purged. If not, the program continues execution.

Assign I/O Paths and Create Unpacked Readings File

Lines 750 - 790 create a file and assign I/O paths for unpacked readings. *Unpk_rdgs* is a BDAT file with 8 bytes/record to store the unpacked readings on the HP 7912P/R. *@Packed_file* is the I/O path to transfer packed readings from *Pack_rdgs* to the Packed array/buffer in the controller. *@Unpacked_file* is the I/O path to transfer unpacked readings from the Unpacked array/buffer in the controller to *Unpk_rdgs* in the HP 7912P/R. *@Packed_buff* and *@Unpacked_buff* are internal I/O paths in the controller.

Unpack Readings and Store on Disc

Lines 830 - 940 unpack the readings and display each reading value. Line 970 then prints the number of readings unpacked and stored. For this program, readings are transferred 1024 at a time from *Pack_rdgs* to the Packed buffer in the controller and unpacked using the unpacking function (lines 1180 - 1300).

As the 1024 readings are unpacked, they are temporarily stored in the Unpacked array/buffer. When the buffer fills, the readings are then transferred to *Unpk_rdgs* in the HP 7912P/R. This process repeats until all readings stored in *Pack_rdgs* have been unpacked and stored in *Unpk_rdgs*. As noted, the *Packed* and *Unpacked* buffers must contain the same number of elements.

Close I/O Paths

Lines 1010 - 1040 close I/O paths *@Packed_file*, *@Unpacked_file*, *@packed_buff*, and *@Unpacked_buff*.

GPIO Timeout Subroutine

If, for any reason, the transfer from the voltmeter to the controller fails to complete (GPIO timeout), this subroutine aborts the GPIO connection and the *@Packed_file* I/O path and updates the EOF pointer.

Unpacking Functions

This example includes unpacking functions for the 13 bit and 14 bit modes. Call the appropriate one by editing line 890.

Program to Transfer Readings @ 100,000 Readings/Second

```
10 /
20 ! Define arrays, variables and buffers
30 /
40 INTEGER Packed(1:10240) BUFFER           ! 20 Kbyte array/buffer
50 REAL Unpacked(1:10240) BUFFER           ! 80 Kbyte array/buffer
60 Tot_rdgs = 100000                         ! Define total rdgs variable
70 Pre_scan = 10                            ! Define prescans variable
80 Post_scan = 10                          ! Define postscans variable
90 MASS STORAGE IS ".,1400,0,0"           ! Define default msus
100 /
110 ! Error trap 1
120 /
130 ON ERROR GOTO Cont1                     ! Define error event/branch
140 PURGE "Pack_rdgs"                      ! Purge file at default msus
150 Cont1 :OFF ERROR                       ! Turn off error event
160 /
170 ! Create I/O paths, data file
180 /
190 CREATE BDAT "Pack_rdgs",Tot_rdgs,2     ! Data file in default msus
200 ASSIGN @Hp_3852 TO 709                 ! Assign I/O path to HP 3852A
210 ASSIGN @Packed_file TO "Pack_rdgs"    ! Assign I/O path to msus file
220 ASSIGN @Gpio TO 12;WORD,FORMAT OFF ! Assign I/O path to GPIO
230 ASSIGN @Packed_buff TO BUFFER Packed(*);WORD,FORMAT OFF ! Cont
    I/O path
240 /
250 ! Configure voltmeter
260 /
270 CLEAR @Hp_3852                         ! Clear HP-IB
280 OUTPUT @Hp_3852;"RST"                 ! Reset HP 3852A
290 OUTPUT @Hp_3852;"USE 600"             ! Use vm in mainframe slot 6
300 OUTPUT @Hp_3852;"DISP OFF"           ! Turn display off
310 OUTPUT @Hp_3852;"SCANMODE ON"        ! Set Scanner Mode
320 OUTPUT @Hp_3852;"CONF DCV"           ! Configure for DC volts
330 OUTPUT @Hp_3852;"RANGE 9"            ! Set 10.24V range
340 OUTPUT @Hp_3852;"RDGS GPIO"          ! GPIO is readings destination
350 OUTPUT @Hp_3852;"NRDGS ";Tot.rdgs/(Pre_scan + Post_scan) ! Number rdgs
360 OUTPUT @Hp_3852;"SPER 10E-6"         ! 10 µsec between readings
370 OUTPUT @Hp_3852;"SCDELAY 0"          ! 0 sec scan trigger delay
380 OUTPUT @Hp_3852;"PRESCAN ";Pre_scan ! Set prescans
390 OUTPUT @Hp_3852;"POSTSCAN ";Post_scan ! Set postscans
400 OUTPUT @Hp_3852;"ASCAN ON"           ! Autoscan on
410 OUTPUT @Hp_3852;"CLWRITE 500"        ! Set ch 500 as scan list
420 /
```

```

430 ! Set Data Buffer Register
440 !
450 CONTROL SC(@Gpio),2;5 ! Set CTL0 low
460 OUTPUT @Gpio USING "#,W";4 ! Address data buffer register
470 CONTROL SC(@Gpio),2;4 ! Set CTL0 high
480 !
490 ! Trigger voltmeter
500 !
510 OUTPUT @Hp_3852;"SCTRIG SGL" ! Send scan trigger
520 !
530 ! Transfer data to controller and then to disc
540 !
550 ON TIMEOUT SC(@Gpio),1 GOSUB Abort_transfer
560 TRANSFER @Gpio TO @Packed_buff;COUNT Tot_rdgs,2,CONT
570 TRANSFER @Packed_buff TO @Packed_file;COUNT Tot_rdgs*2,END,CONT
580 !
590 ! Close I/O paths
600 !
610 ASSIGN @Gpio TO *
620 ASSIGN @Packed_file TO *
630 STATUS @Packed_buff,13;Bytes_trans
640 ASSIGN @Packed_buff TO *
650 PRINT Bytes_trans/2;" readings transferred."
660 !
670 ! Error trap 2
680 !
690 ON ERROR GOTO Cont2
700 PURGE "Unpk_rdgs"
710 Cont2:OFF ERROR
720 !
730 ! Create file for unpacked readings and assign I/O paths
740 !
750 CREATE BDAT "Unpk_rdgs",Bytes_trans/2,8 ! Create unpacked rdgs file
760 ASSIGN @Packed_file TO "Pack_rdgs"
770 ASSIGN @Unpacked_file TO "Unpk_rdgs"
780 ASSIGN @Packed_buff TO BUFFER Packed(*);FORMAT OFF
790 ASSIGN @Unpacked_buff TO BUFFER Unpacked(*);FORMAT OFF
800 !
810 ! Read packed file, unpack rdgs, store on disc in unpacked file.
820 !
830 REPEAT
840 RESET @Packed_buff
850 TRANSFER @Packed_file TO @Packed_buff;END,WAIT ! Buffer of pkd rdgs
860 STATUS @Packed_buff,12;Bytes_trans ! No. of bytes entered

```

```

870 IF Bytes_trans > 0 THEN
880 FOR I = 1 TO Bytes_trans/2
890 OUTPUT @Unpacked_buff; FNUnpk13(Packed(I));
900 PRINT Unpacked(I);
910 NEXT I
920 TRANSFER @Unpacked_buff TO @Unpacked_file; END, WAIT
930 END IF
940 UNTIL NOT Bytes_trans
950 STATUS @Unpacked_file, 7; I           ! Find end of file pointer
960 PRINT
970 PRINT I-1; " readings unpacked and stored"
980 !
990 ! Close I/O paths
1000 !
1010 ASSIGN @Packed_file TO *
1020 ASSIGN @Unpacked_file TO *
1030 ASSIGN @Packed_buff TO *
1040 ASSIGN @Unpacked_buff TO *
1050 STOP
1060 !
1070 ! GPIO timeout subroutine
1080 !
1090 Abort_transfer:                       ! Execute subroutine if timeout occurs
                                           on GPIO

1100 ABORTIO @Gpio
1110 ABORTIO @Packed_file
1120 OUTPUT @Packed_file; END             ! Update EOF ptr for premature
                                           transfer abort

1130 RETURN
1140 END
1150 !
1160 ! Unpacking functions
1170 !
1180 DEF FNUnpk13(INTEGER Pack)           ! Define 13 bit unpack function
1190 REAL R(0:3)
1200 DATA 256., 32., 4., 1.
1210 READ R(*)
1220 M = BINAND(Pack, 4095)
1230 IF Pack > 0 OR M = 4095 THEN
1240 RETURN 1.E + 38
1250 ELSE
1260 V = M*.0025/R(BINAND(SHIFT(Pack, 13), 3))
1270 IF BIT(Pack, 12) THEN V = -V
1280 RETURN V

```

```

1280 RETURN V
1290 END IF
1300 FNEND ! End 13 bit unpack function
1310 DEF FNUnpk14(INTEGER Pack) ! Define 14 bit unpack function
1320 REAL R(0:3) ! Alloc. range factor array
1330 DATA 256.,32.,4.,1. ! Range function data
1340 READ R(*) ! Fill array with range factors
1350 ! Convert A/D bits and range bits to volt reading
1360 V=SHIFT(BINAND(16383,Pack),-2)/4*.00125/R(BINAND(SHIFT(Pack,14),3))
1370 RETURN V
1380 FNEND ! End 14 bit unpack function

```

Since 100,000 readings were specified, a typical return for a 9V 5% source connected to channel 500 follows. Note that the unpacked readings are also stored in Unpk_rdg on the HP 7912P/R.

NOTE

Although the 100,000 unpacked readings are transferred in one second, it requires about 28 minutes to unpack the readings using an HP Series 217 controller and the unpack function in this program.

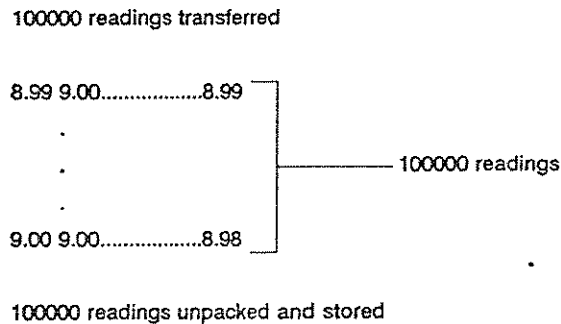

Chapter 8

Using Read/Write Registers

Contents

Introduction	8-1
Register Definitions	8-1
Reading the Registers	8-2
Reading the Data Buffer Register	8-3
Reading the Identity Register	8-7
Reading the Status Register	8-9
Writing to the Trigger Register	8-10

Using Read/Write Registers

Introduction

This chapter shows how to access some read and write registers on the HP 44702A/B and HP 44704A voltmeter. You can access these registers via HP-IB with SREAD or SWRITE commands or can access registers via GPIO with CONTROL statements. Refer to Chapter 7 - GPIO operation for further details on GPIO operation.

Register Definitions

The voltmeter contains its own microprocessor which allows the voltmeter to operate independently of the mainframe. This processor allows access to the internal registers which control the voltmeter and monitor the status.

Although the voltmeter contains several registers, the user can access only four of the registers: Status, Identity, Data Buffer, and Trigger. The Status, Identity, and Data Buffer registers are read only (READ) registers while the Trigger register is a write only (WRITE) registers. Table 8-1 summarizes the registers and shows register addresses.

NOTE

Although other registers exist in the voltmeter, do not attempt to read from or write to any registers other than the Identity, Status, Data Buffer, or Trigger registers as this may cause the voltmeter to enter an unknown state, invalidate all measurements, or "lock-up".

Table 8-1. Register Definitions/Addresses

Register	Address	Description
Read Only (READ) Registers		
Identity	0	Identifies the HP 44702A/B and indicates if the 56K memory expansion is installed (HP 44702B) or not (HP 44702A). For the HP 44704A
Status	1	Provides status information without interrupting the microprocessor operation. Information includes availability of data, data or command readiness, task completion, or error occurrence.
Data Buffer	4	Supplies the mainframe or GPIO controller with measurement data from the voltmeter data buffer. It is not actually a register, but provides access to the data buffer.
Write Only (WRITE) Register		
Trigger	1	Generates scan, measure, or stop triggers. All other trigger controls are generated by the voltmeter microprocessor or are controlled by the mainframe or system controller via GPIO.

Reading the Registers

As noted, there are two methods of reading the Identity, Status, and Data Buffer registers: HP-IB and GPIO.

HP-IB Reads

Use `SREAD slot register_number [INTO name] or [fmt]` to read the register contents over HP-IB where *slot* is the voltmeter slot and *register_number* is the register address as defined in Table 8-1.

For example, to read the value of a register on a high-speed voltmeter in mainframe slot 6 via HP-IB, use the following lines where *Reg_addr* is the address of the register (0, 1, or 4).

```

:  

100 OUTPUT 709;"SREAD 600,Reg_addr"      ! Read register @ Reg_addr  

110 ENTER 709;A                          ! Enter register value  

:
```

GPIO Reads

To read register contents over GPIO, first, set Control Register 2 bit 0 (CTL0) low (logical 1) to tell the voltmeter the next piece of data is a register address. Next, send the register address (as defined in Table 8-1). Then, set CTL0 high (logical 0) again for data and enter the register value.

This example demonstrates these steps for GPIO interface select code 12. *Reg_addr* is the register address (0, 1, or 4) and *Reg_value* is the value returned by the register. For this, and all GPIO examples in the chapter, the PSTS Error bit (bit 2) is always set.

```

10 ASSIGN @Gpio to 12;WORD,FORMAT OFF!Assign I/O path to GPIO
:
100 CONTROL 12,2;5           / Set CTL0 low
110 OUTPUT @Gpio;Reg_addr    / Output register address
120 CONTROL 12,2;4           / Set CTL0 high
130 ENTER @Gpio;Reg_value    / Enter register value
:

```

Reading the Data Buffer Register

The voltmeters first stores all measurement data as a 16-bit integer in their internal data storage buffers. Figure 8-1 shows the measurement data format for the HP 44702A/B, and HP 44704A in 13 bit resolution mode (default after RST). Figure 8-2 shows the measurement data format for the HP 44704A in 14 bit resolution mode. Figure 8-3 shows the measurement data format for the HP 44704A in 16 bit resolution mode. To read the measurement data over HP-IB, access the Data Buffer register with SREAD slot,4. To read the data over GPIO, access the Data Buffer register with OUTPUT, ENTER, and CONTROL statements.

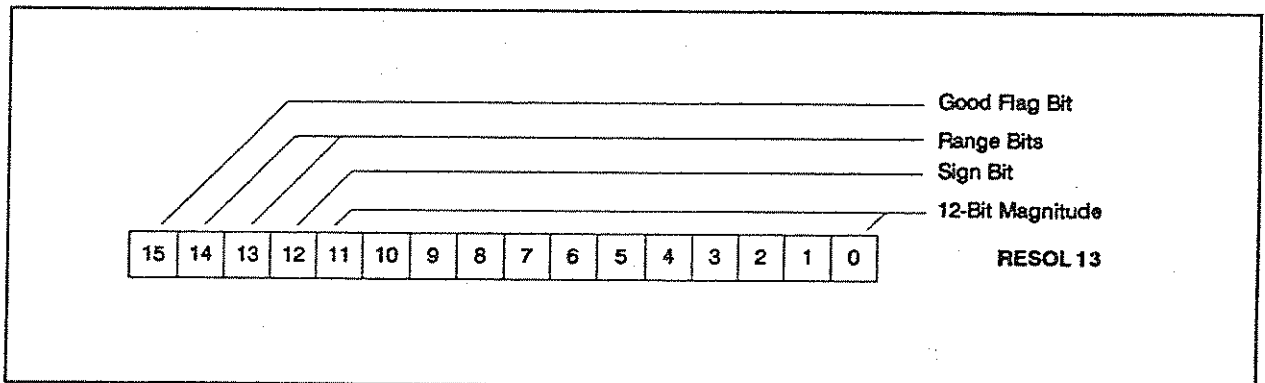

Figure 8-1. 13 Bit Resolution Measurement Data Format

In Figure 8-1, the Good Flag bit (bit 15) indicates whether the reading is valid. A high (logic 1) bit indicates a valid reading while a low (logic 0) bit indicates an invalid reading. The most likely cause for an invalid reading is that the input amplifier is saturated by common mode voltage greater than ± 10.5 volts.

Bits 14 and 13 indicate the voltmeter measurement range, where 00_2 = the ± 40 mv range; 01_2 = the ± 320 mv range; 10_2 = the ± 2.56 V range; and 11_2 = ± 10.24 V range. Bit 12 high (logic 1) indicates a positive value and bit 12 low (logic 0) indicates a negative value.

Bits 11 through 0 indicate the number of counts for the measurement. (If bits 11 through 0 = FFF (Hex) an overload condition exists.) The following program segment shows the 14 bit unpacking function for voltage.

```

:
100 ENTER @Gpio;A(*)           ! Enter readings
110 FOR I=0 TO n-1             ! Begin print loop
120 PRINT FNUnpk13(A(I))      ! Print readings
130 NEXT I

:
200 DEF FNUnpk13(INTEGER Bdata) ! Define 13 bit unpack function
210 REAL R(0:3)
220 DATA 256.,32.,4.,1.
230 READ R(*)
240 M=BINAND(Bdata,4095)
250 IF Bdata > 0 OR M=4095 THEN
260 RETURN 1.E+38
270 ELSE
280 V=M*.0025/R(BINAND(SHIFT(Bdata,13),3))
290 IF BIT(Bdata,12) THEN V=-V
300 RETURN V
310 END IF
320 FNEND                       ! End 13 bit unpacking function

```

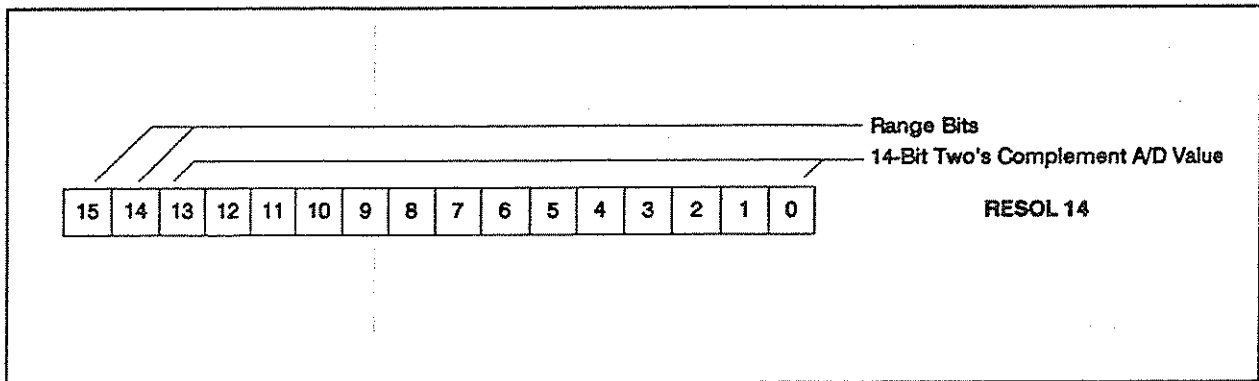

Figure 8-2. 14 Bit Resolution Measurement Data Format

In Figure 8-2, bits 15 and 14 indicate the voltmeter measurement range, where 00_2 = the ± 40 mv range; 01_2 = the ± 320 mv range; 10_2 = the ± 2.56 V range; and 11_2 = ± 10.24 V range. Bits 13 through 0 specify a two's complement value of the measurement. (If bits 13 through 0 = 8191 a positive overload condition exists, if bits 13 through 0 = -8192 a negative overload condition exists.) The following program segment shows the 14 bit unpacking function for voltage.

```

:
100 ENTER @Gpio;A(*)           ! Enter readings
110 FOR I=0 TO n-1             ! Begin print loop
120 PRINT FNUnpk14(A(I))      ! Print readings
130 NEXT I

:
200 DEF FNUnpk14(INTEGER Pack) ! Define 14 bit unpack function
210 REAL R(0:3)                ! Alloc. range factor array
220 DATA 256.,32.,4.,1.       ! Range function data
230 READ R(*)                  ! Fill array with range factors
:
240 ! Convert A/D bits and range bits to volt reading
250 M=BINAND(Pack,16383)
260 IF M=8191 OR M=8192 THEN
270 V=1.E+38
280 ELSE
290 V=SHIFT(M,-2)/(3200.*R(BINAND(SHIFT(Pack,14),3)))
300 ENDIF
310 RETURN V
320 FNEND                       ! End 14 bit unpack function

```

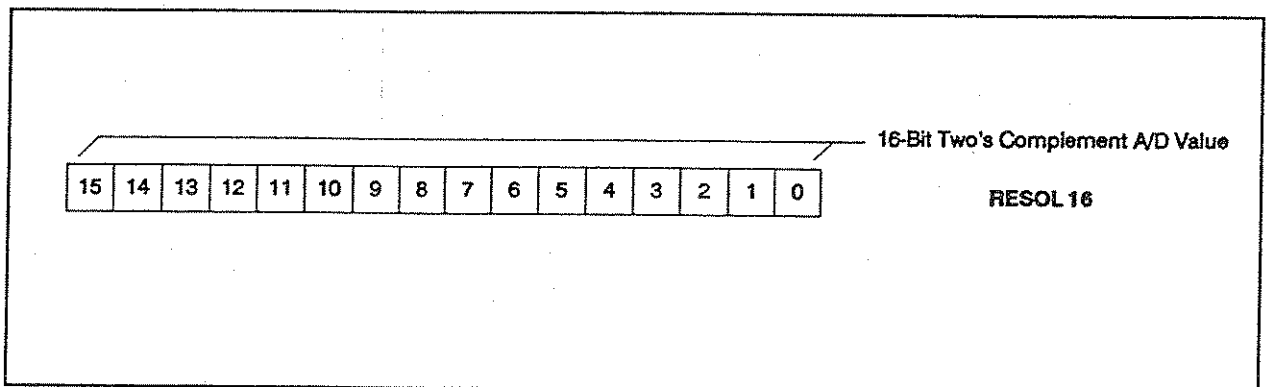

Figure 8-3. 16 Bit Resolution Measurement Data Format

In Figure 8-3, bits 15 through 0 form a 16 bit two's complement measurement value. If the value equals 32767, a positive overload condition exists - if the value is -32768, a negative overload condition exists. No range information is contained in the 16 bit packed data format. Current range status (as set by the RANGE command) is available in bits 8 and 9 of the Status Register. See Chapter 6 for more information about managing range information in 16 bit resolution mode. The following program segment shows the 16 bit unpacking function.

```

:
100 ENTER @Gpio;A(*)           / Enter readings
110 OUTPUT 709;"SREAD 600,1"   / Read status register
120 ENTER 709;S                / Enter status value
130 Range = BINAND(SHIFT(S,8),3) / Isolate range info
140 FOR I = 0 TO n-1           / Begin print loop
150 PRINT FNUnpk16(A*),Range)  / Print readings
160 NEXT I

:
200 DEF FNUnpk16(INTEGER Pack,Range) / Define 16 bit unpack function
210 REAL R(0:3)                / Alloc. range factor array
220 DATA 256.,32.,4.,1.       / Range function data
230 READ R(*)                  / Fill array with range factors
240 / Convert A/D bits and range value to volt reading
250 IF Pack = 32767 OR Pack = -32768 THEN
260 V = 1.E + 38
270 ELSE
280 V = Pack/(3200*R(Range))
290 RETURN V
300 FNEND                       / End 16 bit unpack function

```

Unpacking Resistance Measurements

To determine the measurement value for a resistance measurement, first determine V and then use $R = V/I$ where I = 1 mA for the 10 k Ω range; 0.1 mA for the 100 k Ω range; or 0.01 mA for the 1 m Ω range.

Data returned either over HP-IB or over GPIO must be unpacked. Refer to Chapter 5 - Scanner Mode Programming for example unpacking routines. Refer to Chapter 7 - GPIO Operation for examples on returning data over GPIO.

Example: Reading the Data Buffer Register (HP-IB)

This program shows how to enter the Data Buffer register contents over HP-IB. The Data Buffer register is not actually a register but provides access to the data in the voltmeter data buffer. Thus, the value returned by the Data Buffer register is the data in the data buffer. This program uses SREAD to enter a single DC voltage reading which is unpacked by line 100. (Since the 10.24V range is used, RF = 1.)

NOTE

If there is no data in the Data Buffer register, the program will "hang" at the SREAD command until the data arrives from the voltmeter.

```
10 OUTPUT 709;"USE 600"           / Use voltmeter in mainframe slot 6
20 OUTPUT 709;"RST 600"           / Reset voltmeter
30 OUTPUT 709;"SCANMODE ON"       / Set Scanner Mode
40 OUTPUT 709;"CONF DCV"          / Configure for DC volts
50 OUTPUT 709;"RANGE 9"           / Set 10.24V range
60 OUTPUT 709;"CLWRITE 500"       / Set ch 500 as scan list
70 OUTPUT 709;"SCTRIG INT"        / Internal scan trigger
80 OUTPUT 709;"SREAD 600,4"       / Read Data Buffer register
90 ENTER 709;A                     / Enter register contents
100 PRINT BINAND(4095,A)*.0025     / Display reading
110 END
```

Example: Reading the Data Buffer Register (GPIO)

This program segment shows how to enter the Data Buffer register contents over GPIO. The controller is set for GPIO interface select code 12, the voltmeter is in mainframe slot 6, and the PSTS error bit (bit 2) is set for Report (1). Again, the data must be unpacked.

```
10 ASSIGN @Gpio TO 12;WORD,FORMAT OFF /Assign I/O path to GPIO
:
100 CONTROL 12,2;5                  / Set CTL0 low
110 OUTPUT @Gpio;4                  / Output Data Buffer register addr
120 CONTROL 12,2;4                  / Set CTL0 high
130 ENTER @Gpio;A                   / Enter Data Buffer register value
:
```

Reading the Identity Register

The Identity register provides the HP 44702A/B voltmeter identity. Figure 8-4 shows the Identity register bit format. This register may be accessed at any time, but the GPIO handshake may be delayed up to 750 μ sec immediately after reset.

The high-speed voltmeter has identity code 01000 as indicated by bits 3 through 7. The Option bit (bit 0) indicates if the Extended Memory Card is installed. Option bit 0 = 0 indicates an HP 44702A (8k reading storage memory), while option bit 0 = 1 indicates an HP 44702A/B (64k reading storage memory (Extended Memory Card installed)).

For the HP 44704A voltmeter, the identity register bits indicate an HP 44702B.

The Scanmode Flag (bit 1) is used by the mainframe to determine if Scanner Mode is set (SCANMODE ON = 1 and SCANMODE OFF = 0). Thus, you can read this bit to determine if Scanner Mode is set. Bit 2 is always 0 after a reset. However, the bit may be 0 or 1 during a MEAS operation on the backplane.

Example: Reading the Identity Register (HP-IB)

This example shows how to read the Identity register over HP-IB.

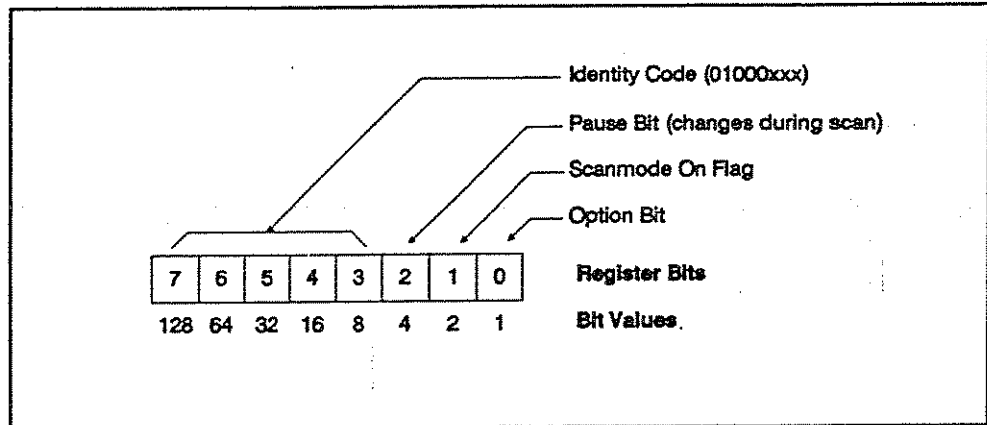

Figure 8-4. Identity Register

```

10 OUTPUT 709; "SREAD 600,0"           / Read Identity register
20 ENTER 709;A                          / Enter register contents
30 PRINT A                              / Display register contents
40 END

```

For an HP 44702B or HP 44704A voltmeter in slot 6 of the mainframe, 65 is returned, since bit 6 is always set (1000001) and bit 0 is set for an HP 44702B or HP 44704A (64k reading storage memory).

Example: Reading the Identity Register (GPIO)

This example shows how to read the Identity register over GPIO. The controller GPIO interface select code is 12.

```

10 ASSIGN @Gpio TO 12;WORD,FORMAT OFF / Assign I/O path to GPIO
20 INTEGER A
30 CONTROL 12,2;5                       / Set CTL0 low
40 OUTPUT @Gpio;0                       / Output Identity register address
50 CONTROL 12,2;4                       / Set CTL0 high
60 ENTER @Gpio;A                        / Enter Identity register value
70 PRINT A                              / Display register value
80 END

```

For an HP 44702B or HP 44704A voltmeter in slot 6 of the mainframe, 65 is returned, since bit 6 is always set (1000001) and bit 0 is set for an HP 44702B (64k reading storage memory).

Reading the Status Register

The Status register provides the mainframe or GPIO controller information on high-speed voltmeter status. This register may be accessed at any time, but the GPIO handshake may be delayed up to 750 μ sec immediately after reset. Figure 8-5 shows the Status register bit format and Table 8-2 describes each bit. Note that bits 4 through 0 provide only protocol information between the mainframe and the voltmeter microprocessor and will not be discussed.

Table 8-2. Status Register Bit Descriptions

Bit	Name	Description
0-4	Protocol Bits	Protocol information between the HP 3852A mainframe and the voltmeter microprocessor.
5	Almost Full Flag	When RDGSMODE BURST is set, bit 5 is set when the data buffer has room for only 4096 (or less) additional readings.
6	Measurement Data Available Flag	Set when measurement data is available in the voltmeter data buffer.
7	Service Request Flag	Indicates interrupt status and can be used to indicate available data. For RDGSMODE END or RDGSMODE COMPLETE, indicates the end of the scan sequence.
HP 44704A Only		
8-9	Resolution Bits	Indicate current mode as set by RESOL command. The bit value/resolution relationship is: 00 = 13-bit 01 = 14-bit 10 = 16-bit

Example: Reading the Status Register (HP-IB)

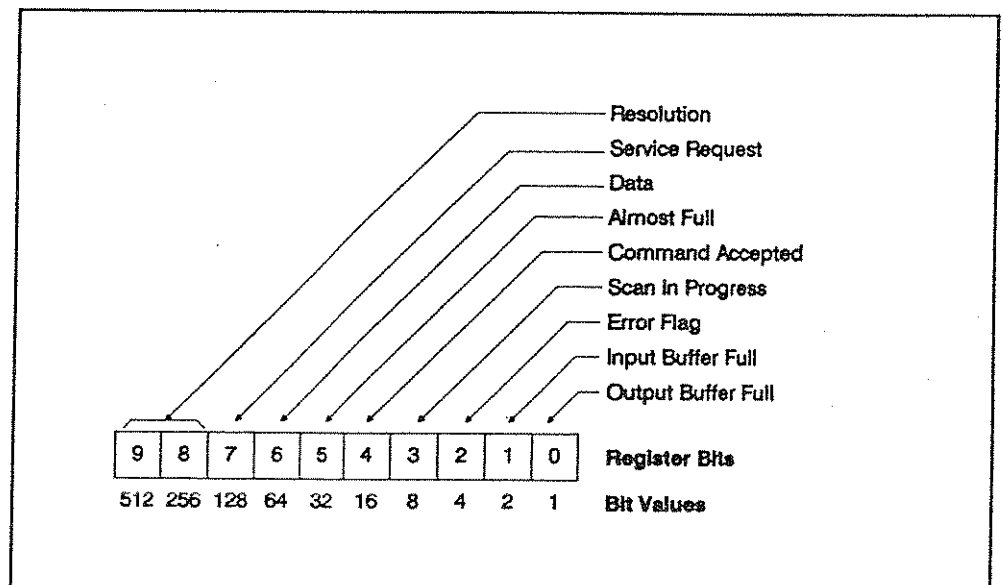

Figure 8-5. Status Register

Example: Writing to the Trigger Register (GPIO)

This example shows how to write to the Trigger register to generate a single scan trigger over GPIO with interface select code 12. Note that the PSTS Error bit is also set.

```
10 ASSIGN @Gpio TO 12;WORD,FORMAT OFF ! Assign I/O path to GPIO
:
100 CONTROL 12,2;5 ! Set CTL0 low
110 OUTPUT @Gpio;1 ! Send Trigger register address
120 CONTROL 12,2;4 ! Set CTL0 high
130 OUTPUT @Gpio;2 ! Generate single scan trigger
:
```

Free Manuals Download Website

<http://myh66.com>

<http://usermanuals.us>

<http://www.somanuals.com>

<http://www.4manuals.cc>

<http://www.manual-lib.com>

<http://www.404manual.com>

<http://www.luxmanual.com>

<http://aubethermostatmanual.com>

Golf course search by state

<http://golfingnear.com>

Email search by domain

<http://emailbydomain.com>

Auto manuals search

<http://auto.somanuals.com>

TV manuals search

<http://tv.somanuals.com>