

**CQ1859, CQ1859e, and CQ1859s LCD  
Monitors  
User Guide**

© 2009 Hewlett-Packard Development  
Company, L.P.

Microsoft, Windows, and Windows Vista are either trademarks or registered trademarks of Microsoft Corporation in the United States and/or other countries.

All other product names mentioned herein may be trademarks of their respective companies.

Hewlett-Packard Company shall not be liable for technical or editorial errors or omissions contained herein or for incidental or consequential damages in connection with the furnishing, performance, or use of this material. The information in this document is provided "as is" without warranty of any kind, including, but not limited to, the implied warranties of merchantability and fitness for a particular purpose, and is subject to change without notice. The warranties for Hewlett-Packard products are set forth in the express limited warranty statements accompanying such products. Nothing herein should be construed as constituting an additional warranty.

This document contains proprietary information that is protected by copyright. No part of this document may be photocopied, reproduced, or translated to another language without the prior written consent of Hewlett-Packard Company.

First Edition (October 2009)

Document Part Number: 576125-001

## About This Guide

This guide provides information on setting up the monitor, installing drivers, using the on-screen display menu, troubleshooting and technical specifications.

- ⚠ **WARNING!** Text set off in this manner indicates that failure to follow directions could result in bodily harm or loss of life.
- ⚠ **CAUTION:** Text set off in this manner indicates that failure to follow directions could result in damage to equipment or loss of information.
- 📝 **NOTE:** Text set off in this manner provides important supplemental information.



---

# Table of contents

## 1 Product Features

CQ1859, CQ1859e, and CQ1859s LCD Monitors .....	1
---	---

## 2 Safety and Maintenance Guidelines

Important Safety Information .....	2
Maintenance Guidelines .....	3
Cleaning the Monitor .....	3
Shipping the Monitor .....	3

## 3 Setting Up the Monitor

Installing the Monitor Stand .....	4
Rear Components .....	5
Connecting the Cables .....	6
Adjusting the Monitor Stand .....	7
Turning on the Monitor .....	7
Locating the Rating Labels .....	8
Installing a Cable Lock .....	8

## 4 Operating the Monitor

Software and Utilities .....	9
The Information File .....	9
The Image Color Matching File .....	9
Installing the .INF and .ICM Files .....	10
Installing from the CD .....	10
Downloading from the Worldwide Web .....	10
Using the Auto-Adjustment Function .....	11
Side Panel Controls .....	12
Adjusting the Monitor Settings .....	13
Using the On-Screen Display Menu .....	13
OSD Menu Selections .....	14
Optimizing Digital Conversion .....	17
Identifying Monitor Conditions .....	17
Sleep Timer Mode .....	18

sRGB Support .....	19
Changing the Color Temperature .....	19
Installing the sRGB ICM File for Microsoft Windows 2000 and Windows XP .....	19
Installing the sRGB ICM File for Microsoft Windows Vista .....	20

## Appendix A Troubleshooting

Solving Common Problems .....	21
Online Technical Support .....	22
Preparing to Call Technical Support .....	22

## Appendix B Technical Specifications

CQ1859, CQ1859e, and CQ1859s Models .....	23
Recognizing Preset Display Resolutions .....	24
CQ1859, CQ1859e, and CQ1859s Models .....	24
Entering User Modes .....	24
Energy Saver Feature .....	24

## Appendix C Agency Regulatory Notices

Federal Communications Commission Notice .....	26
Modifications .....	26
Cables .....	26
Declaration of Conformity for Products Marked with the FCC Logo (United States Only) .....	26
Canadian Notice .....	27
Avis Canadien .....	27
European Union Regulatory Notice .....	27
German Ergonomics Notice .....	28
Japanese Notice .....	28
Korean Notice .....	28
Power Cord Set Requirements .....	28
Japanese Power Cord Requirements .....	28
Product Environmental Notices .....	29
Materials Disposal .....	29
Disposal of Waste Equipment by Users in Private Household in the European Union .....	29
Chemical Substances .....	29
HP Recycling Program .....	29
Restriction of Hazardous Substances (RoHS) .....	29
Turkey EEE Regulation .....	30

## Appendix D LCD Monitor Quality and Pixel Policy

---

# 1 Product Features

## CQ1859, CQ1859e, and CQ1859s LCD Monitors

The LCD (liquid crystal display) monitors have an active matrix, thin-film transistor (TFT) panel. The monitor features include:

- 47 cm (18.5-inch) diagonal viewable area display with 1366 × 768 resolution, plus full-screen support for lower resolutions; includes custom scaling for maximum image size while preserving original aspect ratio
- Wide viewing angle to allow viewing from a sitting or standing position, or moving side-to-side
- Tilt capability
- Video signal input to support VGA analog with VGA signal cable provided
- Internal speakers with audio cable included
- Plug and play capability if supported by the system
- Security slot provision on rear of monitor for optional cable lock
- Cable management feature for placement of cables and cords
- On-Screen Display (OSD) adjustments in several languages for easy setup and screen optimization
- Software and documentation CD that includes monitor drivers and product documentation
- Energy saver feature to meet requirements for reduced power consumption
- Intelligent Management AssetControl
- Compliant with European Union CE Directives

---

## 2 Safety and Maintenance Guidelines

### Important Safety Information

A power cord is included with the monitor. If another cord is used, use only a power source and connection appropriate for this monitor. For information on the correct power cord set to use with the monitor, refer to the [Power Cord Set Requirements on page 28](#) in Appendix C.

---

⚠ **WARNING!** To reduce the risk of electric shock or damage to the equipment:

- Do not disable the power cord grounding feature. The grounding plug is an important safety feature.
- Plug the power cord in a grounded (earthed) outlet that is easily accessible at all times.
- Disconnect power from the product by unplugging the power cord from the electrical outlet.

For your safety, do not place anything on power cords or cables. Arrange them so that no one may accidentally step on or trip over them. Do not pull on a cord or cable. When unplugging from the electrical outlet, grasp the cord by the plug.

To reduce the risk of serious injury, read the *Safety and Comfort Guide*. It describes proper workstation, setup, posture, and health and work habits for computer users, and provides important electrical and mechanical safety information. This guide is located on the Web at <http://www.hp.com/ergo> and/or on the documentation CD, if one is included with the monitor.

⚠ **CAUTION:** For the protection of the monitor, as well as the computer, connect all power cords for the computer and its peripheral devices (such as a monitor, printer, scanner) to some form of surge protection device such as a power strip or Uninterruptible Power Supply (UPS). Not all power strips provide surge protection; the power strips must be specifically labeled as having this ability. Use a power strip whose manufacturer offers a Damage Replacement Policy so you can replace the equipment, if surge protection fails.

---



# Maintenance Guidelines

To enhance the performance and extend the life of the monitor:

- Do not open the monitor cabinet or attempt to service this product yourself. Adjust only those controls that are covered in the operating instructions. If the monitor is not operating properly or has been dropped or damaged, contact an authorized HP dealer, reseller, or service provider.
- Use only a power source and connection appropriate for this monitor, as indicated on the label/back plate of the monitor.
- Be sure the total ampere rating of the products connected to the outlet does not exceed the current rating of the electrical outlet, and the total ampere rating of the products connected to the cord does not exceed the rating of the cord. Look on the power label to determine the ampere rating (AMPS or A) for each device.
- Install the monitor near an outlet that you can easily reach. Disconnect the monitor by grasping the plug firmly and pulling it from the outlet. Never disconnect the monitor by pulling the cord.
- Turn the monitor off when not in use. You can substantially increase the life expectancy of the monitor by using a screen saver program and turning off the monitor when not in use.

---

 **NOTE:** Monitors with a “burned-in image” are not covered under the HP warranty.

---

- Slots and openings in the cabinet are provided for ventilation. These openings must not be blocked or covered. Never push objects of any kind into cabinet slots or other openings.
- Do not drop the monitor or place it on an unstable surface.
- Do not allow anything to rest on the power cord. Do not walk on the cord.
- Keep the monitor in a well-ventilated area, away from excessive light, heat or moisture.
- When removing the monitor stand, you must lay the monitor face down on a soft area to prevent it from getting scratched, defaced, or broken.

## Cleaning the Monitor

1. Turn off the monitor and unplug the power cord from the back of the unit.
2. Dust the monitor by wiping the screen and the cabinet with a soft, clean antistatic cloth.
3. For more difficult cleaning situations, use a 50/50 mix of water and Isopropyl alcohol.

△ **CAUTION:** Spray the cleaner onto a cloth and use the damp cloth to gently wipe the screen surface. Never spray the cleaner directly on the screen surface. It may run behind the bezel and damage the electronics.

**CAUTION:** Do not use cleaners that contain any petroleum based materials such as benzene, thinner, or any volatile substance to clean the monitor screen or cabinet. These chemicals may damage the monitor.

---

## Shipping the Monitor

Keep the original packing box in a storage area. You may need it later if you move or ship the monitor.

---

## 3 Setting Up the Monitor

To set up the monitor, ensure that the power is turned off to the monitor, computer system, and other attached devices, then follow the instructions below.

### Installing the Monitor Stand

△ **CAUTION:** Do not touch the surface of the LCD panel. Pressure on the panel may cause non-uniformity of color or disorientation of the liquid crystals. If this occurs the screen will not recover to its normal condition.

1. Lift the monitor panel from its box and place it face down on a flat surface covered by a dry, clean cloth.
2. Assemble the monitor stand by snapping the top of the backplate into the cylindrical portion of the stand.

**Figure 3-1** Assembling the Monitor Stand

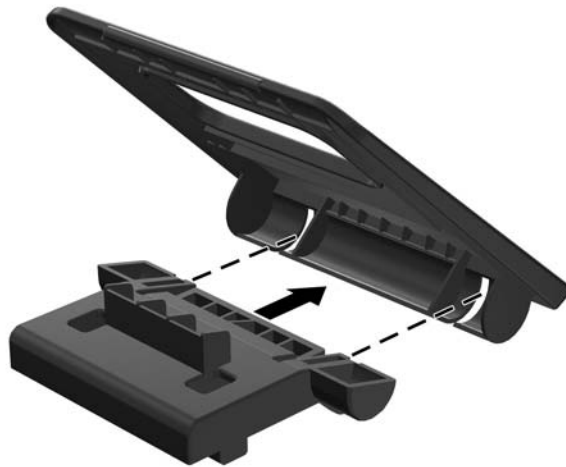

- Slide the hooks at the top of the stand into the slots on the rear of the monitor panel (1) then snap the latches on the stand into the latch holes on the monitor (2).

**Figure 3-2** Installing the Monitor Stand



## Rear Components

**Figure 3-3** Rear Components

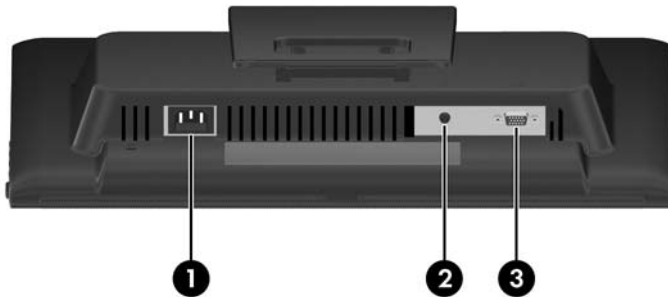

Component	Function
1 AC Power Connector	Connects the AC power cord to the monitor.
2 Audio	Connects the audio cable to the monitor.
3 VGA	Connects the VGA cable to the monitor.

## Connecting the Cables

1. Place the monitor in a convenient, well-ventilated location near the computer.

 **NOTE:** Before connecting the cables, route them through the opening on the monitor's stand, if desired.

2. Connect one end of the VGA signal cable to the VGA connector on the monitor and connect the other end of the cable to the VGA connector on the computer.
3. Connect one end of the provided audio cable to the audio connector on the monitor and connect the other end of the cable to an audio output connector on the rear panel of the computer.
4. Connect one end of the power cable to the AC power connector on the monitor and connect the other end of the cable to an electrical wall outlet.

**Figure 3-4** Connecting the Cables

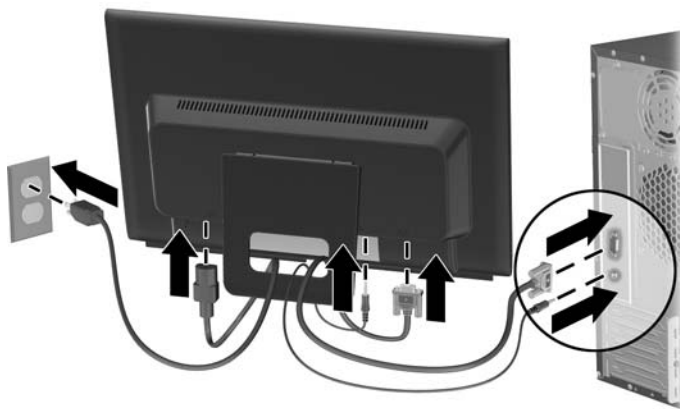

 **WARNING!** To reduce the risk of electric shock or damage to the equipment:

Do not disable the power cord grounding plug. The grounding plug is an important safety feature.

Plug the power cord into a grounded (earthed) electrical outlet that is easily accessible at all times.

Disconnect power from the equipment by unplugging the power cord from the electrical outlet.

For your safety, do not place anything on power cords or cables. Arrange them so that no one may accidentally step on or trip over them. Do not pull on a cord or cable. When unplugging from the electrical outlet, grasp the cord by the plug.

## Adjusting the Monitor Stand

You can adjust the monitor's tilt back position from 10 degrees to 30 degrees.

**Figure 3-5** Tilting the Monitor



## Turning on the Monitor

1. Press the power button on the computer to turn it on.
2. Press the power button on the side of the monitor to turn it on.

△ **CAUTION:** Burn-in image damage may occur on monitors that display the same static image on screen for a prolonged period of time.\* To avoid burn-in image damage on the monitor screen, you should always activate a screen saver application or turn off the monitor when it is not in use for a prolonged period of time. Image retention is a condition that may occur on all LCD screens. Monitors with a “burned-in image” are not covered under the HP warranty.

\* A prolonged period of time is 12 consecutive hours of non-use.

📄 **NOTE:** You can disable the power LED in the OSD menu. Press the Menu button on the side of the monitor, then select **Management > Bezel Power LED > Off**.

When the monitor is powered on, a Monitor Status message is displayed for five seconds. The message shows the current active input signal, the current preset display resolution, and the recommended preset display resolution.

## Locating the Rating Labels

The rating labels on the monitor provide the spare part number, product number, and serial number. You may need these numbers when contacting HP about the monitor model. The rating labels are located on the rear panel of the monitor display head.

**Figure 3-6** Locating the Rating Labels

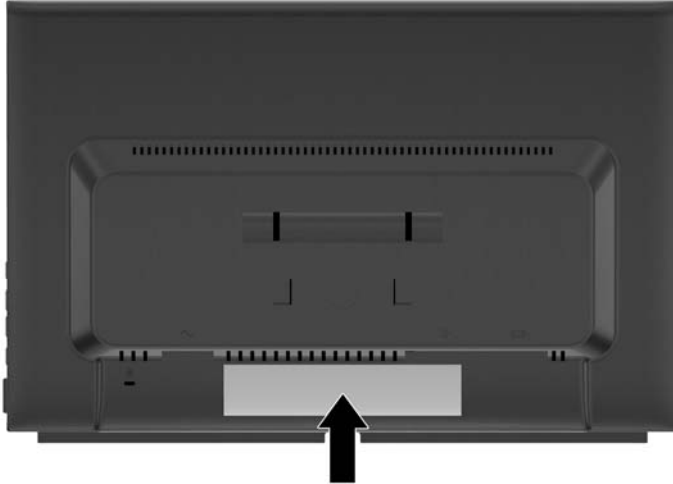

## Installing a Cable Lock

You can secure the monitor to a fixed object with an optional cable lock available from HP.

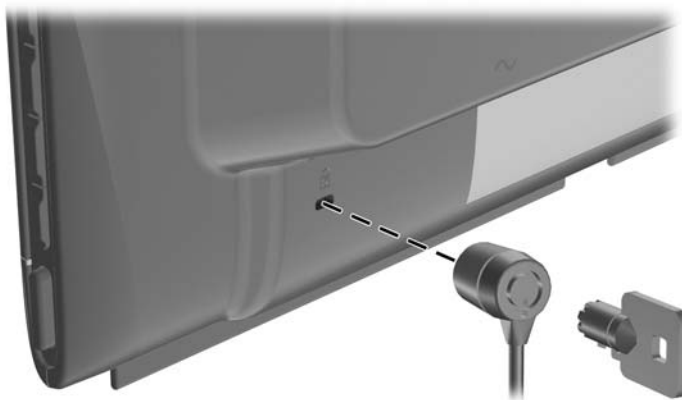

 **NOTE:** For more information on HP accessories, go to <http://www.hp.com/go/options>.

---

# 4 Operating the Monitor

## Software and Utilities

The CD that comes with the monitor contains files you can install on the computer:

- an .INF (Information) file
- an .ICM (Image Color Matching) file
- auto-adjustment pattern utility
- additional software for the monitor model

 **NOTE:** If the monitor does not include a CD, the .INF and .ICM files can be downloaded from the HP monitors support Web site. See [Downloading from the Worldwide Web on page 10](#) in this chapter.

### The Information File

The .INF file defines monitor resources used by Microsoft Windows operating systems to ensure monitor compatibility with the computer's graphics adapter.

This monitor is Microsoft Windows Plug and Play compatible and the monitor will work correctly without installing the .INF file. Monitor Plug and Play compatibility requires that the computer's graphic card is VESA DDC2-compliant and that the monitor connects directly to the graphics card. Plug and Play does not work through separate BNC type connectors or through distribution buffers/boxes.

### The Image Color Matching File

The .ICM files are data files that are used in conjunction with graphics programs to provide consistent color matching from monitor screen to printer, or from scanner to monitor screen. This file is activated from within graphics programs that support this feature.

 **NOTE:** The ICM color profile is written in accordance with the International Color Consortium (ICC) Profile Format specification.

## Installing the .INF and .ICM Files

After you determine that you need to update, you can install the .INF and .ICM files from the CD or download them.

### Installing from the CD

To install the .INF and .ICM files on the computer from the CD:

1. Insert the CD in the computer CD-ROM drive. The CD menu is displayed.
2. View the **Monitor Driver Software Readme** file.
3. Select **Install Monitor Driver Software**.
4. Follow the on-screen instructions.
5. Ensure that the proper resolution and refresh rates appear in the Windows Display control panel.

 **NOTE:** You may need to install the digitally signed monitor .INF and .ICM files manually from the CD in the event of an installation error. Refer to the Monitor Driver Software Readme file on the CD.

### Downloading from the Worldwide Web

To download the latest version of .INF and .ICM files from the HP monitors support Web site:

1. Refer to <http://www.hp.com/support> and select the country region.
2. Follow the links for the monitor to the support page and download page.
3. Ensure the system meets the requirements.
4. Download the software by following the instructions.



# Using the Auto-Adjustment Function

You can optimize the screen performance for the VGA (analog) input by using the [Auto/OK](#) button on the monitor and the auto-adjustment pattern software utility on the CD provided.

This procedure can correct the following image quality conditions:

- Fuzzy or unclear focus
- Ghosting, streaking or shadowing effects
- Faint vertical bars
- Thin, horizontal scrolling lines
- An off-center picture



To use the auto-adjustment feature:

1. Allow the monitor to warm up for 20 minutes before adjusting.
2. Press the [Auto/OK](#) button on the monitor side panel.
  - You can also press the [Menu](#) button, then select **Image Control > Auto-Adjustment** from the OSD Main Menu. Refer to [Adjusting the Monitor Settings on page 13](#) in this chapter.
  - If the result is not satisfactory, continue with the procedure.
3. Insert the CD in the disc drive. The CD menu is displayed.
4. Select **Open Auto-Adjustment Software**. The setup test pattern is displayed.
5. Press the [Auto/OK](#) button on the monitor side panel to produce a stable, centered image.
6. Press the [ESC](#) key or any other key on the keyboard to exit the test pattern.

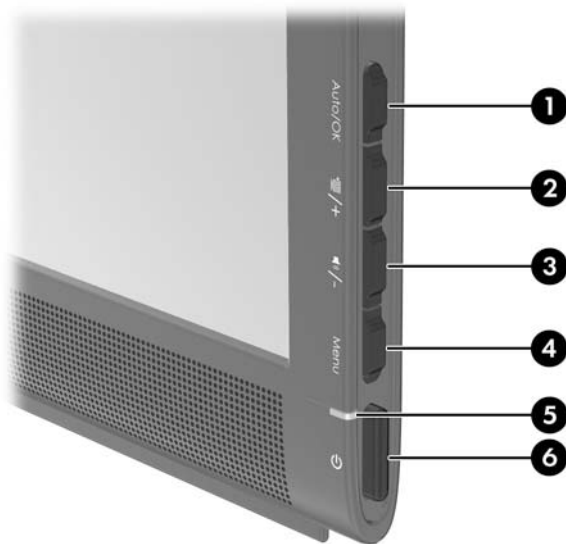
## Side Panel Controls



**Table 4-1 Monitor Side Panel Controls**

Control			Function
1	Auto/OK	Auto/OK	<p>If the OSD menu is inactive, press to activate the auto adjustment feature to optimize the screen image.</p> <p>If the OSD menu is on, press to select the highlighted menu item.</p>
2	 / +	Quick View/Plus	<p>If the OSD menu is inactive, press to open the Quick View OSD sub-menu.</p> <p>If the OSD menu is on, press to navigate forward through the OSD menu and increase adjustment levels.</p>
3	 / -	Volume/Minus	<p>If the OSD menu is inactive, press to open the Volume adjustment OSD sub-menu.</p> <p>If the OSD menu is on, press to navigate backward through the OSD menu and decrease adjustment levels.</p>
4	Menu	Menu	Opens, selects or exits the OSD menu.
5		Power LED	<p>Green = Fully powered.</p> <p>Amber = Sleep mode.</p> <p>Flashing Amber = Sleep Timer mode.</p>
6		Power	Turns the monitor on or off.

# Adjusting the Monitor Settings

The monitor settings can be adjusted from the On-Screen Display (OSD) menu.

 **NOTE:** If there is a problem with the display settings, try resetting the settings to the factory defaults by opening the OSD and selecting **Factory Reset** from the OSD menu.

---

## Using the On-Screen Display Menu

Use the On-Screen Display (OSD) to adjust the screen image based on your viewing preferences. To access the OSD, do the following:

1. If the monitor is not already on, press the **Power** button to turn on the monitor.
2. To access the OSD Menu, press the **Menu** button on the monitor's side panel.

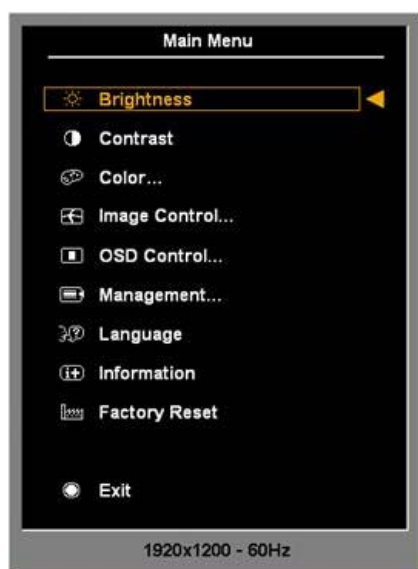

3. To navigate through the OSD Menu, press the **+** (Plus) button on the monitor's side panel to scroll up, or the **-** (Minus) button to scroll in reverse.
4. To select an item from the OSD Menu, use the **+** or **-** buttons to scroll to and highlight your selection, then press the **OK** button to select that function.
5. Adjust the item using the **+** or **-** buttons on the side panel to adjust the scale.
6. After adjusting the function, select **Save and Return**, or **Cancel** if you don't want to save the setting, then select **Exit** from the Main Menu.

 **NOTE:** If the buttons remain untouched for 10 seconds while displaying a menu, new adjustments will be discarded and the settings will revert to previous settings and exit the menu.









---

## OSD Menu Selections













The following table lists the On-Screen Display (OSD) menu selections and their functional descriptions. After changing an OSD menu item, and if the menu screen has these options, you may choose to:

- **Cancel**—to return to the previous menu level.
- **Save and Return**—to save all changes and return to the OSD Main Menu screen. This Save and Return option is only active if you change a menu item.









**Table 4-2 OSD Menu**

Icon	Main Menu	Submenu	Description
	Brightness	Adjustable scale	Adjusts the brightness level of the screen. The factory default range is 90.
	Contrast	Adjustable scale	Adjusts the contrast level of the screen. The factory default range is 80.
	Color		Selects the screen color. The factory default is 6500K or Custom Color, depending on the model.
		9300 K	Changes to slightly blueish white.
		6500 K	Changes to slightly reddish white.
		sRGB	<del>Sets your screen colors to adapt to the color standards used in the image technology industry.</del>
		Quick View	Select from the following viewing modes: <ul style="list-style-type: none"> <li>• Movie</li> <li>• Photo</li> <li>• Gaming</li> <li>• Text</li> <li>• Custom (settings saved when you adjust the Brightness, Contrast, or Color in one of the other Quick View options)</li> </ul>
		Custom Color	Selects and adjusts your own color scales: <ul style="list-style-type: none"> <li>• R—sets your own red color levels</li> <li>• G—sets your own green color levels</li> <li>• B—sets your own blue color levels</li> </ul>
		Reset	Resets the Color menu to the Factory default 6500K setting, and resets Quick View to the default Text option. It will not reset or affect Custom Color RGB settings.
	Image Control		Adjusts the screen image.
		Auto Adjustment	Automatically adjusts the screen image.
		Clock	Minimizes any vertical bars or strips visible on the screen background. Adjusting the Clock will also change the horizontal screen image.



**Table 4-2 OSD Menu (continued)**

Icon	Main Menu	Submenu	Description
		Clock Phase	Adjusts the focus of the display. This adjustment allows you to remove any horizontal noise and clear or sharpen the image of characters.
		Horizontal Position	Adjusts the position of the screen image left and right.
		Vertical Position	Adjusts the position of the screen image up and down.
		Custom Scaling	<p>Selects the method on how displayed information on the monitor will be formatted. Select:</p> <ul style="list-style-type: none"> <li>• Fill to Screen - image fills the entire screen and may look distorted or elongated because of non-proportional scaling of height and width</li> <li>• Fill to Aspect Ratio - image is sized to fit the screen and maintains proportional image</li> </ul>
		Sharpness (non-native modes)	Adjusts the screen image to look sharper or soft.
	OSD Control		Provides a menu for adjusting the on-screen display (OSD) controls.
		Horizontal OSD Position	Changes the viewing position of the OSD menu to the left or right area of the screen. The factory default range is 50.
		Vertical OSD Position	Changes the viewing position of the OSD menu to the top or bottom area of the screen. The factory default range is 50.
		OSD Transparency	Adjust to view the background information through the OSD.
		OSD Timeout	Sets the time duration in seconds that the OSD is visible after the last button is pressed. The range is 5 – 60 seconds. The factory default is 30 seconds.
	Management		Selects the OSD and power management features of the monitor.
		Power Saver	<p>Enables the power saving feature. Select:</p> <ul style="list-style-type: none"> <li>• On</li> <li>• Off</li> </ul> <p>The factory default is On.</p>
		Power On Recall	<p>Restores power to the monitor following an unexpected removal of power. Select:</p> <ul style="list-style-type: none"> <li>• On</li> <li>• Off</li> </ul> <p>The factory default is On.</p>

**Table 4-2 OSD Menu (continued)**

Icon	Main Menu	Submenu	Description
		Mode Display	<p>Displays the resolution, refresh rate and frequency information on the screen each time the OSD Main Menu is accessed. Select:</p> <ul style="list-style-type: none"> <li>• On</li> <li>• Off</li> </ul> <p>The factory default is On.</p>
		Monitor Status	<p>Displays the operating status of the monitor each time the monitor is powered on. Select the location to display the status to:</p> <ul style="list-style-type: none"> <li>• Top</li> <li>• Middle</li> <li>• Bottom</li> <li>• Off</li> </ul> <p>The factory default is Top.</p>
		DDC/CI Support	<p>Allows the computer to control some OSD menu features such as brightness, contrast and color temperature. Set to:</p> <ul style="list-style-type: none"> <li>• On</li> <li>• Off</li> </ul> <p>The factory default is On.</p>
		Bezel Power LED	<p>Turns off the power LED on the side panel of the monitor. The factory default is On.</p>
		Volume	<p>Adjusts the volume of the monitor speakers. The ranges is 0 – 100. The factory default setting is 90.</p>
		Sleep Timer	<p>Provides the timer adjustment menu options:</p> <ul style="list-style-type: none"> <li>• Set Current Time—sets the current time in hours and minutes</li> <li>• Set Sleep Time—sets the time you want to place the monitor in sleep mode</li> <li>• Set on Time—sets the time you want the monitor to wake up from sleep mode</li> <li>• Timer—sets the Sleep Timer feature On or Off. The default setting is Off.</li> <li>• Sleep Now—immediately sets the monitor to enter sleep mode</li> </ul>
	Language		<p>Selects the language in which the OSD menu is displayed. The factory default is English.</p>
	Information		<p>Selects and displays important information about the monitor.</p>
		Current Settings	<p>Provides the current input video mode.</p>

**Table 4-2 OSD Menu (continued)**

Icon	Main Menu	Submenu	Description
		Recommended Settings	Provides the recommended resolution mode and refresh rate for the monitor.
		Serial Number	Reports the serial number of the monitor. The serial number is needed if contacting HP technical support.
		FW Version	Reports the firmware version of the monitor.
		Backlight Hours	Reports the total hours of backlight operation.
		Service Support	<a href="http://www.hp.com/support">http://www.hp.com/support</a>
	Factory Reset		Returns all OSD menu settings and DDC/CI controls to the factory default settings, except the Language.
	Exit		Exits the OSD menu screen.

## Optimizing Digital Conversion

Two controls in the on-screen display can be adjusted to improve image performance: Clock and Clock Phase.

 **NOTE:** The Clock and Clock Phase controls are adjustable only when using an analog input. These controls are not adjustable for digital inputs.

The Clock must first be set correctly since the Clock Phase settings are dependent on the main Clock setting. Use these controls only when the auto-adjustment function does not provide a satisfactory image.

- **Clock**—Increases/decreases the value to minimize any vertical bars or stripes visible on the screen background.
- **Clock Phase**—Increases/decreases the value to minimize video distortion or video jitter.

 **NOTE:** When using the controls, you will obtain the best results by using the auto-adjustment pattern software utility provided on the CD.

When adjusting the Clock and Clock Phase values, if the monitor images become distorted, continue adjusting the values until the distortion disappears. To restore the factory settings, select Yes from the Factory Reset menu in the on-screen display.

## Identifying Monitor Conditions

Special messages will appear on the monitor screen when identifying the following monitor conditions:

- **Monitor Status**—When the monitor is powered on, a Monitor Status message is displayed for five seconds. The message shows the current active input signal, the current preset display resolution, and the recommended preset display resolution.
- **Input Signal Out of Range—Change resolution setting to 1366 x 768 – 60Hz**—Indicates the monitor does not support the input signal because the resolution and/or refresh rate are set higher than the monitor supports.

- **No Source Signal**—Indicates the monitor is not receiving a video signal from the PC on the monitor video input connector. Check to determine if the PC or input signal source is off or in the power saving mode.
- **Auto Adjustment in Progress**—Indicates the auto-adjustment function is active.
- **Monitor Going to Sleep**—Indicates the screen display is entering a sleep mode.
- **Check Video Cable**—Indicates the video cable is not properly connected to the computer.
- ~~**Dynamic Contrast Ratio On**—Indicates that Dynamic Contrast Ratio has been turned on. This only occurs if Movie mode is selected from the Quick View sub-menu in the OSD.~~
- ~~**Dynamic Contrast Ratio Off**—Indicates that Dynamic Contrast Ratio has been turned off. This only occurs if Movie mode is changed to another viewing mode in the Quick View OSD sub-menu.~~
- ~~**Speaker Self Test In Progress**—Indicates the monitor is testing the left and right speakers.~~
- **Settings Saved as Custom**—Indicates that a Custom setting has been saved in the Quick View sub-menu. This occurs if a preset is selected in the Quick View menu then the Brightness, Contrast, or Color is also changed in the OSD.

## Sleep Timer Mode

The Sleep Timer mode is an energy-saving feature that enables you to set a time for the monitor to power on and off at the same time every day. This also extends the life of the backlight bulbs in the monitor. The Sleep Timer has five settings:

- Set Current Time
- Set Sleep Time
- Set On Time
- Timer: On/Off
- Sleep Now

To set the timer:

1. Press the **Menu** button on the monitor side panel to display the **OSD Menu**.
2. Scroll down and highlight **Management**.
3. Press the **OK** button to select **Management**.
4. Scroll down and highlight and select **Sleep Timer > Set Current Time**.

 **NOTE:** You must set the current local time before you reset the time for **Sleep Time** or **On Time**. Note that the time is displayed in a 24-hour clock format. For example, 1:15 p.m. is displayed as 13 hours 15 minutes.

A power failure or loss of power to the monitor will cause the timer to reset to 00:00. If this occurs, you will need to reset the sleep timer mode.

5. Press the **OK** button once to enter the adjustment mode for hours.
6. Press the **-** (Minus) or **+** (Plus) button to adjust the hour.



7. Press the **OK** button again to enter the time for minutes.
8. Press the **-** (Minus) or **+** (Plus) button to adjust the minutes.
9. Press the **OK** button to lock in the time chosen.
10. After setting the current time, the highlight automatically skips to **Set Sleep Time**. Repeat steps 6 through 9 to set **Sleep Time**.
11. If you do not want to set **Sleep Time**, press the **OK** button twice, then select **Save and Return** to exit the menu.
12. After setting **Sleep Time**, the highlight automatically skips to **Set On Time**. Repeat steps 6 through 9 to set **On Time**.
13. Set the **Timer mode** to **On** to activate the **Sleep Timer** settings.
14. When you are finished, select **Save and Return** to exit the menu.

The fifth selection, **Sleep Now**, turns the monitor backlights off immediately and stays in sleep mode until the next **On Time** activates or a monitor button is pressed.

## sRGB Support

The monitor is designed to support sRGB for color management, which adapts to the color standards used in the image technology industry.

To take advantage of the sRGB support, you will need to change the monitor's color temperature to sRGB and install the sRGB color profile (ICM) file.

 **NOTE:** The sRGB color temperature preset will improve the color accuracy of sRGB images on the computer monitor, but some color variation may still occur.

## Changing the Color Temperature

1. Press the **Menu** button on the side panel of the monitor to launch the **Main Menu** of the OSD.
2. Select **Color**.
3. Select **sRGB**.
4. Select **Save and Return** to exit the menu.

## Installing the sRGB ICM File for Microsoft Windows 2000 and Windows XP

 **NOTE:** To complete the following procedure, you must be logged in as an administrator or a member of the administrator's group. If the computer is connected to a network, network policy settings may prevent you from completing this procedure. The sRGB ICM file does not support Windows 95 and Windows NT operating systems.

1. Click the **Display** icon in the Control Panel.
2. In the **Display Properties** windows, select the **Settings** tab, then click the **Advanced** button.
3. Select the **Color Management** tab, then click the **Add** button to open the **Add Profile Association** dialog box.
4. Select the **sRGB Color Space Profile.icm** file, then click the **Add** button.

- ~~5. To activate a color profile for the monitor, you must set it as the Default Monitor Profile. Select **sRGB Color Space Profile**, then click **Set as Default** button.~~
- ~~6. Click **Apply** or **OK**.~~

## ~~Installing the sRGB ICM File for Microsoft Windows Vista~~

- ~~1. Click **Appearance and Personalization** icon in the Control Panel.~~
- ~~2. Click **Personalization**.~~
- ~~3. Click **Display Settings**.~~
- ~~4. Click the **Advanced Settings** button.~~
- ~~5. Click the **Color Management** tab, then click the **Color Management** button.~~
- ~~6. Click the **Advanced** tab, then click the **Change System Defaults** button.~~
- ~~7. On the **Devices** tab, click the **Add** button.~~
- ~~8. Select the **RGB Color Space Profile.icm** file, then click the **OK** button.~~
- ~~9. To activate a color profile for the monitor, you must set it as the Default Monitor Profile. Select **sRGB Color Space Profile**, then click the **Set as Default** button.~~

# A Troubleshooting

## Solving Common Problems

The following table lists possible problems, the possible cause of each problem, and the recommended solutions.

Problem	Possible Cause	Solution
Screen is blank.	Power cord is disconnected.	Connect the power cord.
	Power button on side panel of the monitor is turned off.	Press the side panel power button.
	Video cable is improperly connected.	Connect the video cable properly. Refer to Chapter 3, <a href="#">Setting Up the Monitor on page 4</a> for more information.
	Screen blanking is active.	Press any key on the keyboard or move the mouse to inactivate the screen blanking utility.
Screen image appears distorted; text is fuzzy or blurred; image quality is degraded.	The computer's graphics card resolution is set lower or higher than the monitor's native resolution.	Set the computer's display resolution to the same mode as the monitor's recommended native screen resolution to provide the best picture quality.
Image appears blurred, indistinct, or too dark.	Brightness and contrast are too low.	Press the <a href="#">Auto/OK</a> button on the side panel. If this does not correct the image, press the <a href="#">Menu</a> button to open the OSD Menu, and adjust the brightness and contrast scales as needed.
Image is not centered	Position may need adjustment.	Press the <a href="#">Menu</a> button to access the OSD menu. Select <a href="#">Image Control/Horizontal Position</a> or <a href="#">Vertical Position</a> to adjust the horizontal or vertical position of the image.
<b>Check Video Cable</b> is displayed on screen.	Monitor video cable is disconnected.	Connect the video cable between the computer and monitor. Be sure that the computer power is off while connecting the video cable.
<b>Input Signal Out of Range. Change Settings to 1366 x 768 @ 60Hz</b> is displayed on screen.	Video resolution and/or refresh rate are set higher than what the monitor supports.	Restart the computer and enter Safe Mode. Change the settings to a supported setting (see <a href="#">Recognizing Preset Display Resolutions on page 24</a> ). Restart the computer so that the new settings take effect.
The monitor is off but it did not seem to enter into a low-power sleep mode.	The monitor's power saving control is disabled.	In the monitor's OSD menu, select <b>Management &gt; Power Saver</b> . The control should be set to <b>On</b> to allow the monitor to enter into low-power modes.

## Online Technical Support

For the online access to technical support information, self-solve tools, online assistance, community forums of IT experts, broad multivendor knowledge base, monitoring and diagnostic tools, go to <http://www.hp.com/support>

## Preparing to Call Technical Support

If you cannot solve a problem using the troubleshooting tips in this section, you may need to call technical support. Have the following information available when you call:

- Monitor model number
- Monitor serial number
- Purchase date on invoice
- Conditions under which the problem occurred
- Error messages received
- Hardware configuration
- Name and version of the hardware and software you are using

## B Technical Specifications

 **NOTE:** All performance specifications are provided by the component manufacturers. Performance specifications represent the highest specification of all HP's component manufacturers' typical level specifications for performance and actual performance may vary either higher or lower.

### CQ1859, CQ1859e, and CQ1859s Models

**Table B-1 Specifications**

Display	47 cm wide screen	18.5 inches wide screen
Type	TFT LCD	
Viewable Image Size	47 cm diagonal	18.5 inch diagonal
Speakers	1 watt per channel	
Tilt	10° to 30°	
Maximum Weight (Unpacked)	2.9 kg	6.39 lbs.
Dimensions (includes base at 10° tilt)		
Height	30.24 cm	11.91 inches
Depth	13.09 cm	5.15 inches
Width	45.25 cm	17.81 inches
Maximum Graphic Resolution	1366 x 768 (60 Hz) analog input	
Optimum Graphic Resolution	1366 x 768 (60 Hz) analog input	
Text Mode	720 x 400	
Dot Pitch	0.10 (H) x 0.30 (W) mm	
Pixels Per Inch	85 PPI	
Horizontal Frequency	24 to 83 kHz	
Vertical Refresh Rate	50 to 76 Hz	
Environmental Requirements Temperature		
Operating Temperature	5 to 35° C	41 to 95° F
Storage Temperature	-20 to 60° C	-4 to 140° F
Relative Humidity	20 to 80%	
Power Source	100 – 240 VAC 50/60 Hz	

**Table B-1 Specifications (continued)**

Altitude:		
Operating	0 to 3657.6 m	0 to 12,000 feet
Storage	0 to 12192 m	0 to 40,000 feet
Power Consumption (maximum)	30 watts	
Input Terminal	One VGA connector with cable included	

## Recognizing Preset Display Resolutions

The display resolutions listed below are the most commonly used modes and are set as factory defaults. This monitor automatically recognizes these preset modes and they will appear properly sized and centered on the screen.

### CQ1859, CQ1859e, and CQ1859s Models

**Table B-2 Factory Preset Modes**

Preset	Pixel Format	Horz Freq (kHz)	Vert Freq (Hz)
1	640 × 480	31.469	59.940
2	720 × 400	31.469	70.087
3	800 × 600	37.879	60.317
4	1024 × 768	48.363	60.004
5	1280 × 960	60.00	60.00
6	1280 × 1024	63.98	60.02
7	1366 × 768	47.712	59.79

## Entering User Modes

The video controller signal may occasionally call for a mode that is not preset if:

- You are not using a standard graphics adapter.
- You are not using a preset mode.

If this occurs, you may need to readjust the parameters of the monitor screen by using the on-screen display. Your changes can be made to any or all of these modes and saved in memory. The monitor automatically stores the new setting, then recognizes the new mode just as it does a preset mode. In addition to the factory preset modes, there are 10 user modes that can be entered and stored.

## Energy Saver Feature

When the monitor is in its normal operating mode, the monitor uses less than 28 watts.

The monitor also supports a reduced power state. The reduced power state will be entered into if the monitor detects the absence of either the horizontal sync signal and/or the vertical sync signal. Upon detecting the absence of these signals, the monitor screen is blanked, the backlight is turned off, and the power light is turned amber. When the monitor is in the reduced power state, the monitor will utilize

less than 2 watts of power. There is a brief warm up period before the monitor will return to its normal operating mode.

Refer to the computer manual for instructions on setting energy saver features (sometimes called power management features).

---

 **NOTE:** The above power saver feature only works when connected to computers that have energy saver features.

---

By selecting the settings in the monitor's Energy Saver utility, you can also program the monitor to enter into the reduced power state at a predetermined time. When the monitor's Energy Saver utility causes the monitor to enter the reduced power state, the power light blinks amber.

---

# C Agency Regulatory Notices

## Federal Communications Commission Notice

This equipment has been tested and found to comply with the limits for a Class B digital device, pursuant to Part 15 of the FCC Rules. These limits are designed to provide reasonable protection against harmful interference in a residential installation. This equipment generates, uses, and can radiate radio frequency energy and, if not installed and used in accordance with the instructions, may cause harmful interference to radio communications. However, there is no guarantee that interference will not occur in a particular installation. If this equipment does cause harmful interference to radio or television reception, which can be determined by turning the equipment off and on, the user is encouraged to try to correct the interference by one or more of the following measures:

- Reorient or relocate the receiving antenna.
- Increase the separation between the equipment and the receiver.
- Connect the equipment into an outlet on a circuit different from that to which the receiver is connected.
- Consult the dealer or an experienced radio or television technician for help.

## Modifications

The FCC requires the user to be notified that any changes or modifications made to this device that are not expressly approved by Hewlett Packard Company may void the user's authority to operate the equipment.

## Cables

Connections to this device must be made with shielded cables with metallic RFI/EMI connector hoods to maintain compliance with FCC Rules and Regulations.

## Declaration of Conformity for Products Marked with the FCC Logo (United States Only)

This device complies with Part 15 of the FCC Rules. Operation is subject to the following two conditions:

1. This device may not cause harmful interference.
2. This device must accept any interference received, including interference that may cause undesired operation.

For questions regarding the product, contact:



Hewlett Packard Company  
P. O. Box 692000, Mail Stop 530113  
Houston, Texas 77269-2000  
Or, call 1-800-HP-INVENT (1-800 474-6836)

For questions regarding this FCC declaration, contact:

Hewlett Packard Company  
P. O. Box 692000, Mail Stop 510101  
Houston, Texas 77269-2000  
Or, call (281) 514-3333

To identify this product, refer to the Part, Series, or Model number found on the product.

## Canadian Notice

This Class B digital apparatus meets all requirements of the Canadian Interference-Causing Equipment Regulations.

## Avis Canadien

Cet appareil numérique de la classe B respecte toutes les exigences du Règlement sur le matériel brouilleur du Canada.

## European Union Regulatory Notice

This product complies with the following EU Directives:

- Low Voltage Directive 2006/95/EC
- EMC Directive 2004/108/EC

Compliance with these directives implies conformity to applicable harmonized European standards (European Norms) which are listed on the EU Declaration of Conformity issued by Hewlett-Packard for this product or product family.

This compliance is indicated by the following conformity marking placed on the product:

---

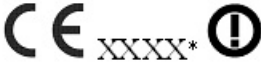
 <small>This marking is valid for non-Telecom products and EU harmonized Telecom products (e.g. Bluetooth).</small>	 <small>This marking is valid for EU non-harmonized Telecom products. *Notified body number (used only if applicable - refer to the product label).</small>
This marking is valid for non-Telecom products and EU harmonized Telecom products (e.g. Bluetooth)	This marking is valid for EU non-harmonized Telecom products.  *Notified body number (used only if applicable — refer to the product label).

---

## German Ergonomics Notice

HP products which bear the “GS” approval mark, when forming part of a system comprising HP brand computers, keyboards and monitors that bear the “GS” approval mark, meet the applicable ergonomic requirements. The installation guides included with the products provide configuration information.

## Japanese Notice

この装置は、クラスB情報技術装置です。この装置は、家庭環境で使用することを目的としていますが、この装置がラジオやテレビジョン受信機に近接して使用されると、受信障害を引き起こすことがあります。取扱説明書に従って正しい取り扱いをして下さい。

VCCI-B

## Korean Notice

B급 기기

(가정용 방송통신기기)

이 기기는 가정용(B급)으로 전자파적합등록을 한 기기로서 주로 가정에서 사용하는 것을 목적으로 하며, 모든 지역에서 사용할 수 있습니다.

## Power Cord Set Requirements

The monitor power supply is provided with Automatic Line Switching (ALS). This feature allows the monitor to operate on input voltages between 100–120V or 200–240V.

The power cord set (flexible cord or wall plug) received with the monitor meets the requirements for use in the country where you purchased the equipment.

If you need to obtain a power cord for a different country, you should purchase a power cord that is approved for use in that country.

The power cord must be rated for the product and for the voltage and current marked on the product's electrical ratings label. The voltage and current rating of the cord should be greater than the voltage and current rating marked on the product. In addition, the cross-sectional area of the wire must be a minimum of 0.75 mm<sup>2</sup> or 18 AWG, and the length of the cord must be between 6 feet (1.8 m) and 12 feet (3.6 m). If you have questions about the type of power cord to use, contact an authorized HP service provider.

A power cord should be routed so that it is not likely to be walked on or pinched by items placed upon it or against it. Particular attention should be paid to the plug, electrical outlet, and the point where the cord exits from the product.

## Japanese Power Cord Requirements

For use in Japan, use only the power cord received with this product.

△ **CAUTION:** Do not use the power cord received with this product on any other products.

# Product Environmental Notices

## Materials Disposal

This HP product contains mercury in the fluorescent lamp in the display LCD that might require special handling at end-of-life.

Disposal of this material can be regulated because of environmental considerations. For disposal or recycling information, contact the local authorities or the Electronic Industries Alliance (EIA) <http://www.eiae.org>.

## Disposal of Waste Equipment by Users in Private Household in the European Union



This symbol on the product or on its packaging indicates that this product must not be disposed of with your household waste. Instead, it is your responsibility to dispose of your waste equipment by handing it over to a designated collection point for the recycling or waste electrical and electronic equipment. The separate collection and recycling of your waste equipment at the time of disposal will help to conserve natural resources and ensure that it is recycled in a manner that protects human health and the environment. For more information about where you can drop off your waste equipment for recycling, please contact the local city office, the household waste disposal service or the shop where you purchased the product.

## Chemical Substances

HP is committed to providing our customers with information about the chemical substances in our products as needed to comply with legal requirements such as REACH (Regulation EC No 1907/2006 of the European Parliament and Council). A chemical information report for this product can be found at <http://www.hp.com/go/reach>.

## HP Recycling Program

HP encourages customers to recycle used electronic hardware, HP original print cartridges, and rechargeable batteries. For more information about recycling programs, go to <http://www.hp.com/recycle>.

## Restriction of Hazardous Substances (RoHS)

A Japanese regulatory requirement, defined by specification JIS C 0950, 2005, mandates that manufacturers provide Material Content Declarations for certain categories of electronic products offered for sale after July 1, 2006. To view the JIS C 0950 material declaration for this product, visit <http://www.hp.com/go/jisc0950>.

2008年、日本における製品含有表示方法、JISC0950が公示されました。製造事業者は、2006年7月1日以降に販売される電気・電子機器の特定化学物質の含有につきまして情報提供を義務付けられました。製品の部材表示につきましては、[www.hp.com/go/jisc0950](http://www.hp.com/go/jisc0950)を参照してください。

## 有毒有害物质/元素的名称及含量表

根据中国  
《电子信息产品污染控制管理办法》

### 液晶显示器

部件名称	有毒有害物质和元素					
	铅 (Pb)	汞 (Hg)	镉 (Cd)	六价铬 (Cr(VI))	多溴联苯 (PBB)	多溴二苯醚 (PBDE)
液晶显示器显示面板	X	X	○	○	○	○
机箱/其它	X	○	○	○	○	○

### CRT 显示器

部件名称	有毒有害物质和元素					
	铅 (Pb)	汞 (Hg)	镉 (Cd)	六价铬 (Cr(VI))	多溴联苯 (PBB)	多溴二苯醚 (PBDE)
阴极射线管	X	○	○	○	○	○
机箱/其它	X	○	○	○	○	○

O: 表示该有毒或有害物质在该部件所有均质材料中的含量均在 SJ/T11363-2006 标准规定的限量要求以下。

X: 表示该有毒或有害物质至少在该部件所用的某一均质材料中的含量超出 SJ/T11363-2006 标准规定的限量要求。

表中标有“X”的所有部件都符合欧盟 RoHS 法规 — “欧洲议会和欧盟理事会 2003 年 1 月 27 日关于电子电器设备中限制使用某些有害物质的 2002/95/EC 号指令”。

注: 环保使用期限的参考标识取决于产品正常工作的温度和湿度等条件。

## Turkey EEE Regulation

In Conformity with the EEE Regulation

EEE Yönetmeliğine Uygundur

---

## D LCD Monitor Quality and Pixel Policy

The TFT monitor uses high-precision technology, manufactured according to HP standards, to guarantee trouble-free performance. Nevertheless, the display may have cosmetic imperfections that appear as small bright or dark spots. This is common to all LCD displays used in products supplied by all vendors and is not specific to the HP LCD. These imperfections are caused by one or more defective pixels or sub-pixels.

- A pixel consists of one red, one green, and one blue sub-pixel.
- A defective whole pixel is always turned on (a bright spot on a dark background), or it is always off (a dark spot on a bright background). The first is the more visible of the two.
- A defective sub-pixel (dot defect) is less visible than a defective whole pixel and is small and only visible on a specific background.

To locate defective pixels, the monitor should be viewed under normal operating conditions, in normal operating mode at a supported resolution and refresh rate, from a distance of approximately 50 cm (20 in).

HP expects that, over time, the industry will continue to improve its ability to produce LCDs with fewer cosmetic imperfections and HP will adjust guidelines as improvements are made.

## Free Manuals Download Website

<http://myh66.com>

<http://usermanuals.us>

<http://www.somanuals.com>

<http://www.4manuals.cc>

<http://www.manual-lib.com>

<http://www.404manual.com>

<http://www.luxmanual.com>

<http://aubethermostatmanual.com>

Golf course search by state

<http://golfingnear.com>

Email search by domain

<http://emailbydomain.com>

Auto manuals search

<http://auto.somanuals.com>

TV manuals search

<http://tv.somanuals.com>