



**HP EliteBook 820 G4 Notebook PC**  
**HP EliteBook 828 G4 Notebook PC**

**Maintenance and Service Guide**

© Copyright 2016 HP Development Company, L.P.

AMD is a trademark of Advanced Micro Devices, Inc. Bluetooth is a trademark owned by its proprietor and used by HP Inc. under license. Intel is a trademark of Intel Corporation in the U.S. and other countries. Linux® is the registered trademark of Linus Torvalds in the U.S. and other countries. Microsoft and Windows are either registered trademarks or trademarks of Microsoft Corporation in the United States and/or other countries. Qualcomm is a trademark of Qualcomm Incorporated, registered in the United States and other countries, used with permission.

The information contained herein is subject to change without notice. The only warranties for HP products and services are set forth in the express warranty statements accompanying such products and services. Nothing herein should be construed as constituting an additional warranty. HP shall not be liable for technical or editorial errors or omissions contained herein.

First Edition: December 2016

Document Part Number: 913445-001

### **Product notice**

This user guide describes features that are common to most models. Some features may not be available on your computer.

Not all features are available in all editions of Windows. This computer may require upgraded and/or separately purchased hardware, drivers and/or software to take full advantage of Windows functionality. Go to <http://www.microsoft.com> for details.

### **Your product does not support Windows 8 or Windows 7**

In accordance with Microsoft's support policy, HP does not support the Windows 8 or Windows 7 operating system on this product or provide any Windows 8 or Windows 7 drivers on <http://support.hp.com>.

### **Software terms**

By installing, copying, downloading, or otherwise using any software product preinstalled on this computer, you agree to be bound by the terms of the HP End User License Agreement (EULA). If you do not accept these license terms, your sole remedy is to return the entire unused product (hardware and software) within 14 days for a full refund subject to the refund policy of your seller.

For any further information or to request a full refund of the price of the computer, please contact your seller.

## Important Notice about Customer Self-Repair Parts

---

 **CAUTION:** Your computer includes Customer Self-Repair parts and parts that should only be accessed by an authorized service provider. See Chapter 5, "Removal and replacement procedures for Customer Self-Repair parts," for details. Accessing parts described in Chapter 6, "Removal and replacement procedures for Authorized Service Provider only parts," can damage the computer or void your warranty.

---



## Safety warning notice

---

 **WARNING!** To reduce the possibility of heat-related injuries or of overheating the device, do not place the device directly on your lap or obstruct the device air vents. Use the device only on a hard, flat surface. Do not allow another hard surface, such as an adjoining optional printer, or a soft surface, such as pillows or rugs or clothing, to block airflow. Also, do not allow the AC adapter to contact the skin or a soft surface, such as pillows or rugs or clothing, during operation. The device and the AC adapter comply with the user-accessible surface temperature limits defined by the International Standard for Safety of Information Technology Equipment (IEC 60950-1).

---



---

# Table of contents

<b>1 Product description .....</b>	<b>1</b>
<b>2 External component identification .....</b>	<b>5</b>
Right .....	5
Left .....	6
Display .....	7
Top .....	8
TouchPad .....	8
Lights .....	9
Buttons, speakers, and fingerprint reader .....	10
Keys .....	11
Using the hot keys .....	12
Bottom .....	13
Front .....	14
Labels .....	15
<b>3 Illustrated parts catalog .....</b>	<b>16</b>
Computer major components .....	16
Display assembly subcomponents .....	19
Cable Kit .....	20
Plastics Kit .....	21
Mass storage devices .....	22
Miscellaneous parts .....	23
<b>4 Removal and replacement procedures preliminary requirements .....</b>	<b>25</b>
Tools required .....	25
Service considerations .....	25
Plastic parts .....	25
Cables and connectors .....	26
Drive handling .....	26
Grounding guidelines .....	27
Electrostatic discharge damage .....	27
Packaging and transporting guidelines .....	28
Workstation guidelines .....	28
Equipment guidelines .....	29

<b>5 Removal and replacement procedures for Customer Self-Repair parts .....</b>	<b>30</b>
Component replacement procedures .....	30
Bottom cover .....	30
Battery .....	35
Hard drive .....	36
Solid-state drive .....	38
Memory modules .....	40
WLAN/Bluetooth combo card .....	42
WWAN module .....	44
Keyboard .....	46
<b>6 Removal and replacement procedures for Authorized Service Provider parts .....</b>	<b>49</b>
Component replacement procedures .....	49
Display assembly .....	50
Heat sink/fan assembly .....	56
Smart card reader board .....	58
Touchpad board .....	59
NFC module .....	60
System board .....	61
RTC battery .....	65
Fingerprint reader assembly .....	66
Speaker assembly .....	67
Top cover .....	68
<b>7 Interpreting system validation diagnostic front panel LEDs and audible codes .....</b>	<b>69</b>
<b>8 Computer Setup (BIOS), TPM, and HP Sure Start .....</b>	<b>71</b>
Using Computer Setup .....	71
Starting Computer Setup .....	71
Navigating and selecting in Computer Setup .....	71
Restoring factory settings in Computer Setup .....	71
Updating the BIOS .....	72
Determining the BIOS version .....	72
Downloading a BIOS update .....	73
Changing the boot order using the f9 prompt .....	73
TPM BIOS settings (select products only) .....	74
Using HP Sure Start (select products only) .....	74
<b>9 Using HP PC Hardware Diagnostics (UEFI) .....</b>	<b>75</b>
Downloading HP PC Hardware Diagnostics (UEFI) to a USB device .....	75



<b>10 Backup and recovery</b> .....	<b>77</b>
Creating recovery media and backups .....	77
Creating HP Recovery media (select products only) .....	77
Using Windows tools .....	78
Restore and recovery .....	79
Recovering using HP Recovery Manager .....	79
What you need to know before you get started .....	79
Using the HP Recovery partition (select products only) .....	80
Using HP Recovery media to recover .....	80
Changing the computer boot order .....	81
Removing the HP Recovery partition (select products only) .....	82
<b>11 Specifications</b> .....	<b>83</b>
Input power .....	83
Operating environment .....	83
<b>12 Power cord set requirements</b> .....	<b>84</b>
Requirements for all countries .....	84
Requirements for specific countries and regions .....	84
<b>13 Statement of memory volatility</b> .....	<b>86</b>
Nonvolatile memory usage .....	88
Questions and answers .....	90
Using HP Sure Start (select models only) .....	91
<b>14 Recycling</b> .....	<b>92</b>
<b>Index</b> .....	<b>93</b>



# 1 Product description

Category	Description
<b>Product Name</b>	HP EliteBook 820 G4 Notebook PC HP EliteBook 828 G4 Notebook PC
<b>Processors</b>	7th-generation Intel® Core™ processors: <ul style="list-style-type: none"><li>• Intel Core i7-7600U</li><li>• Intel Core i7-7500U</li><li>• Intel Core i5-7300U</li><li>• Intel Core i5-7200U</li><li>• Intel Core i3-7100U</li></ul>
<b>Chipset</b>	Integrated with processor
<b>Graphics</b>	UMA graphics with shared video memory Intel HD Graphics 620 Up to three independent displays supported with the 2013 Ultrastim Docking Station
<b>Panel</b>	<b>12.5 in (31.75 cm), LED backlight</b> High-definition (HD), Slim eDP (1366×768), SVA AG, typical brightness: 220 nits with and without webcam Full high-definition (FHD), UltraSlim eDP (1920×1080), UWVA AG, typical brightness: 300 nits with and without webcam Full high-definition (FHD), UltraSlim eDP (1920×1080) UWVA, typical brightness: 300 nits with touch and webcam; chemically strengthened Gorilla Glass, air gap bonded
<b>Memory</b>	Two SODIMM customer-accessible/upgradable memory module slots Supports up to 32 GB of system RAM DDR4 PC4-17000 (2133 MHz) dual channel support Supports the following configurations: <ul style="list-style-type: none"><li>• 32768 MB (16384 MB×2)</li><li>• 16384 MB (16384 MB×1 or 8192 MB×2)</li><li>• 8192 MB (8192 MB×1 or 4096 MB×2)</li><li>• 4096 MB (4096 MB×1)</li></ul>
<b>Mass storage</b>	Supports one mass storage device (M.2 solid-state drive or 2.5-inch hard drive) <b>Hard drives:</b> Supports the following serial ATA <b>6.35 cm</b> (2.5 in) hard drives in <b>7.0 mm</b> (.28 in) thicknesses (all hard drives use the same bracket): <ul style="list-style-type: none"><li>• 1 TB, 5400 rpm</li><li>• 500 GB, 7200 rpm, self-encrypting (FIPS-140-2; Opal 2)</li><li>• 500 GB, 7200 rpm</li></ul>

Category	Description
	<ul style="list-style-type: none"> <li>500 GB, hybrid, 8 GB cache</li> </ul> <hr/> <p><b>Solid-state drives:</b></p> <p>Supports the following M.2 (HGFF) 2280 solid-state drives:</p> <ul style="list-style-type: none"> <li>512 GB, PCIe Gen3×4 NVMe SS TLC (Opal 2)</li> <li>512 GB, PCIe Gen3×4 NVMe SS/DS MLC</li> <li>512 GB, PCIe Gen3×4 NVMe TLC</li> <li>512 GB, SATA-3 FIPS-140-2, TLC</li> <li>360 GB, PCIe Gen3×4 SS TLC</li> <li>256 GB, PCIe Gen3×4 NVMe TLC</li> <li>256 GB, SATA-3 SS TLC (Opal 2)</li> <li>128 GB SATA-3 SS value</li> </ul>
<b>Audio and video</b>	<p>HP Bang &amp; Olufsen Audio</p> <p>Dual-array microphone</p> <p>Premium stereo speakers (2)</p> <p>Webcam, 720p (optional)</p> <p>Supports “no camera” option</p>
<b>Ethernet</b>	<p>Intel WGI219V 10/100/1000 Ethernet, for use with computer models with i7-7500U, i5-7200U, or i3-7100U processors</p> <p>Intel WGI219LM 10/100/1000 Ethernet, for use with computer models with i7-7600U or i5-7300U processors</p> <p>S3/S4/S5 Wake-on-LAN</p>
<b>Wireless</b>	<p><b>WPAN:</b></p> <p>Integrated wireless personal area network (PAN) supported by Bluetooth® 4.2 combo card</p> <hr/> <p><b>WLAN:</b></p> <p>Integrated wireless local area network (WLAN) options by way of wireless module</p> <p>Two WLAN antennas built into display assembly</p> <p>Compatible with Miracast-certified devices</p> <p>Bluetooth Disabled IOPT</p> <p>Support for the following WLAN formats:</p> <ul style="list-style-type: none"> <li>Intel Dual band wireless-AC 8265 802.11AC 2x2 WiFi + BT 4.2 Combo Adaptor (vPro)</li> <li>Intel Dual band wireless-AC 8265 802.11AC 2x2 WiFi + BT 4.2 Combo Adaptor (non-vPro)</li> <li>Intel Dual band wireless-AC 3168 802.11AC 1x1 WiFi + BT 4.2 Combo Adaptor (non-vPro)</li> </ul> <p>Supports no WLAN option</p> <hr/> <p><b>NFC:</b></p> <p>Integrated NFC Galapagos NXP NPC100 I2C NCI 10 mm x 25 mm module</p> <p>NFC antenna</p> <p>Supports no NFC option</p> <hr/> <p><b>WWAN:</b></p>





Category	Description
	<p>Integrated wireless wide area network (WWAN) options by way of wireless module</p> <p>Two WWAN antennas built into display assembly</p> <p>Supports the following WWAN formats:</p> <ul style="list-style-type: none"> <li>• Foxconn HP It4120 LTE/EVDO/HSPA+ with GPS M.2</li> <li>• Huawei HP It4132, LTE/HSPA+ with GPS M.2</li> <li>• Fibocom HP hs3210 WW HSPA+ without GPS</li> </ul> <p>Supports “no WWAN” option</p>
<b>External media cards</b>	Memory card reader (SD, SDHC, SDXC)
<b>Ports</b>	<p>VGA (Dsub 15 pin) supporting 1920 x 1200 external resolution @ 60Hz, hot plug/unplug, and auto detect</p> <p>USB 3.1 Gen 1 charging port</p> <p>USB 3.1 Gen 1 port</p> <p>USB Type-C (basic)</p> <p>DisplayPort</p> <p>RJ-45/ethermet connector</p> <p>Docking connector</p> <p>Audio-out (headphone)/audio-in (microphone) combo jack</p> <p>AC port</p>
<b>Keyboard/pointing devices</b>	<p><b>Keyboard:</b></p> <p>Dual point, spill resistant with drain</p> <p>Dual point, DuraKeys, backlit, spill resistant with drain</p> <hr/> <p><b>TouchPad:</b></p> <p>Gestures enabled by default: two-finger scrolling, two-finger pinch-zoom</p> <p>Taps enabled by default</p> <p>On/off button</p> <p>Glass</p>
<b>Power requirements</b>	<p><b>Battery:</b></p> <p>3-cell HP Long Life Li-Ion battery, 49 WHr, 4.25 Ahr</p> <hr/> <p><b>AC adapter:</b></p> <p>65 W HP Smart AC adapter (supports HP Fast Charging)</p> <p>45 W HP Smart AC adapter</p> <p>45 W, 2-prong AC adapter</p> <hr/> <p><b>Power cord:</b></p> <p>2-wire plug, 1 m</p> <p>3-wire plug, 1.8 m</p> <p>3-wire plug, 1 m</p>
<b>Security</b>	Security lock



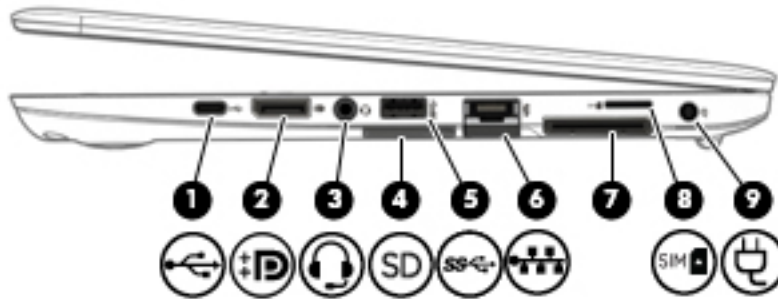

Category	Description
	<p>Fingerprint reader</p> <p>Supports “no fingerprint reader” option</p> <p>Supports Trusted Platform Module (TPM) 2.0 (Infineon, soldered down)</p> <p>Integrated Smart Card reader (active)</p> <p>Preboot authentication (password, smart card)</p>
<b>Operating system</b>	<p><b>Preinstalled:</b></p> <p>Windows 10 Home 64</p> <p>Windows 10 Professional 64</p> <p>NeoKylin Linux 64-bit</p> <p>FreeDOS 2.0</p> <hr/> <p><b>Restore Media—DR/SR-DVD</b></p> <p>Windows 10</p> <p>NeoKylin Linux</p> <hr/> <p><b>Certified:</b></p> <p>Microsoft WHQL</p> <p><b>Web-only support:</b></p> <p>Windows 10 Enterprise 64</p> <p>Windows 10 Enterprise 64 LTSB 1507</p>
<b>Serviceability</b>	<p><b>End user replaceable parts:</b></p> <p>AC adapter</p> <p>Battery</p> <p>Hard drive/SSD</p> <p>Memory module</p> <p>WLAN</p> <p>WWAN</p> <p>Keyboard</p>

## 2 External component identification

### Right





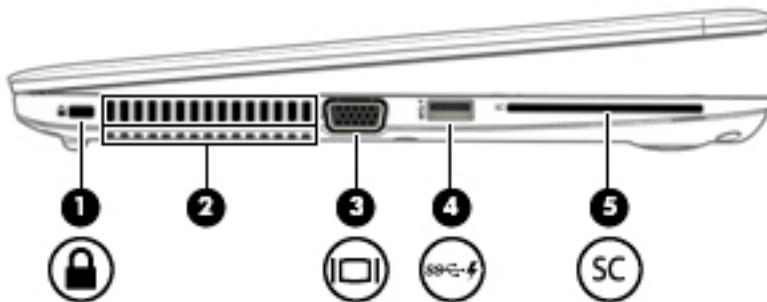

Component	Description
(1) 	<p>USB Type-C basic port</p> <p>When the computer is on, connects and charges a USB device that has a Type-C connector, such as a cell phone, camera, activity tracker, or smartwatch, and provides data transfer.</p>
(2) 	<p>Dual-Mode DisplayPort</p> <p>Connects an optional digital display device, such as a high-performance monitor or projector.</p>
(3) 	<p>Audio-out (headphone)/Audio-in (microphone) combo jack</p> <p>Connects optional powered stereo speakers, headphones, earbuds, a headset, or a television audio cable. Also connects an optional headset microphone. This jack does not support optional microphone-only devices.</p> <p><b>WARNING!</b> To reduce the risk of personal injury, adjust the volume before putting on headphones, earbuds, or a headset. For additional safety information, refer to the <i>Regulatory, Safety, and Environmental Notices</i>.</p> <p>To access this guide:</p> <ol style="list-style-type: none"> <li>Type <b>support</b> in the taskbar search box, and then select the <b>HP Support Assistant</b> app.</li> <li>– or –</li> <li>Click the question mark icon in the taskbar.</li> <li>Select <b>My PC</b>, select the <b>Specifications</b> tab, and then select <b>User Guides</b>.</li> </ol> <p><b>NOTE:</b> When a device is connected to the jack, the computer speakers are disabled.</p>
(4) 	<p>Memory card reader</p> <p>Reads optional memory cards that enable you to store, manage, share, or access information.</p> <p>To insert a card:</p> <ol style="list-style-type: none"> <li>Hold the card label-side up, with connectors facing the computer.</li> <li>Insert the card into the memory card reader, and then press in on the card until it is firmly seated.</li> </ol> <p>To remove a card:</p>

Component	Description
	▲ Press in on the card, and then remove it from the memory card reader.
(5)  USB 3.x port	Connects a USB device, such as a cell phone, camera, activity tracker, or smartwatch, and provides data transfer.
(6)  RJ-45 (network) jack/status lights	Connects a network cable. <ul style="list-style-type: none"> <li>• Green (left): The network is connected.</li> <li>• Amber (right): Activity is occurring on the network.</li> </ul>
(7) Docking connector	Connects an optional docking device.
(8)  SIM card slot	Supports a wireless subscriber identity module (SIM) card.
(9)  Power connector	Connects an AC adapter.

## Left



Component	Description
(1)  Security cable slot	Attaches an optional security cable to the computer. <b>NOTE:</b> The security cable is designed to act as a deterrent, but it may not prevent the computer from being mishandled or stolen.
(2) Vents (2)	Enable airflow to cool internal components. <b>NOTE:</b> The computer fan starts up automatically to cool internal components and prevent overheating. It is normal for the internal fan to cycle on and off during routine operation.
(3)  External monitor port	Connects an external VGA monitor or projector.
(4)  USB 3.x charging port	When the computer is on, connects and charges a USB device, such as a cell phone, camera, activity tracker, or smartwatch, and provides high-speed data transfer.
(5)  Smart card reader	Supports optional smart cards.



# Display



Component	Description
(1) WLAN antennas* (2)	Send and receive wireless signals to communicate with wireless local area networks (WLANs).
(2) WWAN antennas* (2)	Send and receive wireless signals to communicate with wireless wide area networks (WWANs).
(3) Internal microphones (2)	Record sound.
(4) Webcam light (select products only)	On: The webcam is in use.
(5) Webcam (select products only)	Records video and captures photographs. Some models allow you to video conference and chat online using streaming video.  To use the webcam:  ▲ Type <code>camera</code> in the taskbar search box, and then select <b>Camera</b> .

\*The antennas are not visible from the outside of the computer. For optimal transmission, keep the areas immediately around the antennas free from obstructions.

For wireless regulatory notices, see the section of the *Regulatory, Safety, and Environmental Notices* that applies to your country or region.

To access this guide:

1. Type `support` in the taskbar search box, and then select the **HP Support Assistant** app.

– or –

Click the question mark icon in the taskbar.

2. Select **My PC**, select the **Specifications** tab, and then select **User Guides**.

# Top



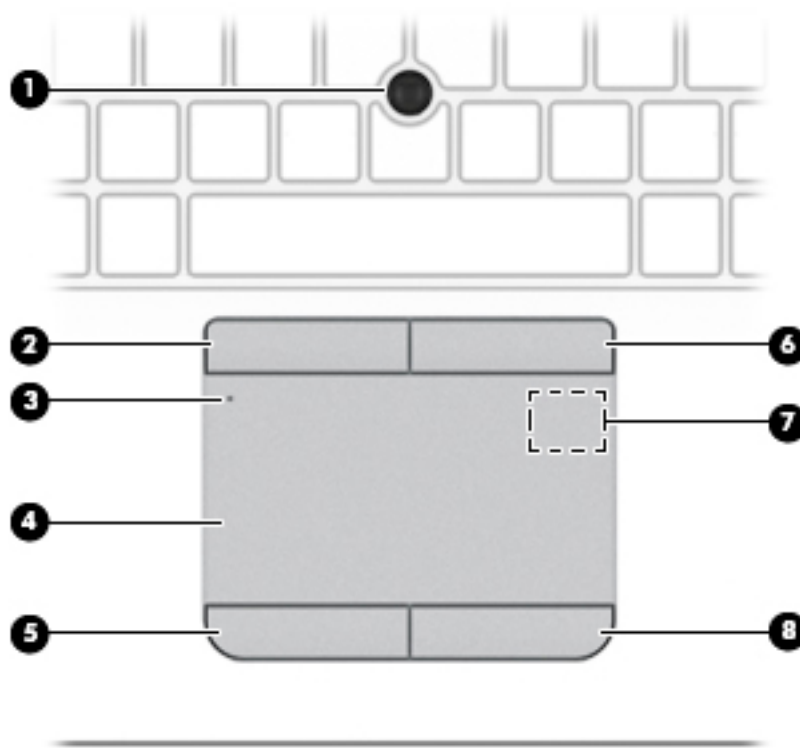

## TouchPad

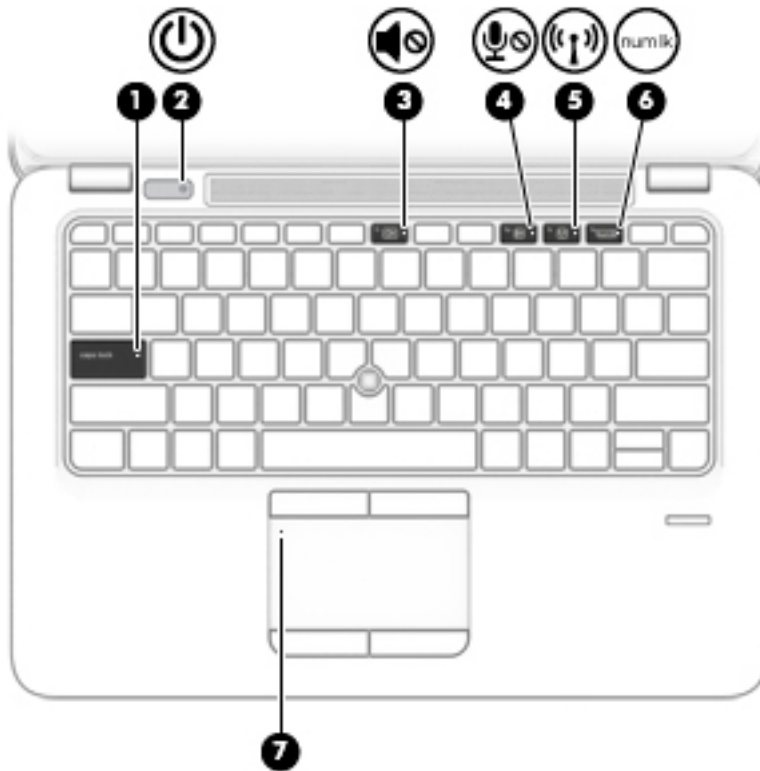

Component	Description
(1) Pointing stick	Moves the pointer on the screen.
(2) Left pointing stick button	Functions like the left button on an external mouse.
(3) TouchPad on/off button/TouchPad light	Turns the TouchPad on and off. <ul style="list-style-type: none"><li>• On: The TouchPad is off.</li><li>• Off: The TouchPad is on.</li></ul>
(4) TouchPad zone	Reads your finger gestures to move the pointer or activate items on the screen.
(5) Left TouchPad button	Functions like the left button on an external mouse.
(6) Right pointing stick button	Functions like the right button on an external mouse.
(7) Near Field Communications (NFC) tapping area (select products only)	Allows you to touch an NFC-compatible device to this area to wirelessly connect and communicate with the computer and transfer data back and forth.
(8) Right TouchPad button	Functions like the right button on an external mouse.

## Lights



Component	Description
(1) Caps lock light	On: Caps lock is on, which switches the key input to all capital letters.
(2)  Power light	<ul style="list-style-type: none"> <li>On: The computer is on.</li> <li>Blinking: The computer is in the Sleep state, a power-saving state. The computer shuts off power to the display and other unneeded components.</li> <li>Off: The computer is off or in Hibernation. Hibernation is a power-saving state that uses the least amount of power.</li> </ul>
(3)  Mute light	<ul style="list-style-type: none"> <li>Amber: Computer sound is off.</li> <li>Off: Computer sound is on.</li> </ul>
(4)  Microphone mute light	<ul style="list-style-type: none"> <li>Amber: microphone sound is off.</li> <li>Off: microphone sound is on.</li> </ul>
(5)  Wireless light	<p>On: An integrated wireless device, such as a wireless local area network (WLAN) device and/or a Bluetooth® device, is on.</p> <p><b>NOTE:</b> On some models, the wireless light is amber when all wireless devices are off.</p>
(6)  Num lk light	On: Num lock is on.
(7) TouchPad light	<ul style="list-style-type: none"> <li>On: The TouchPad is off.</li> <li>Off: The TouchPad is on.</li> </ul>

## Buttons, speakers, and fingerprint reader

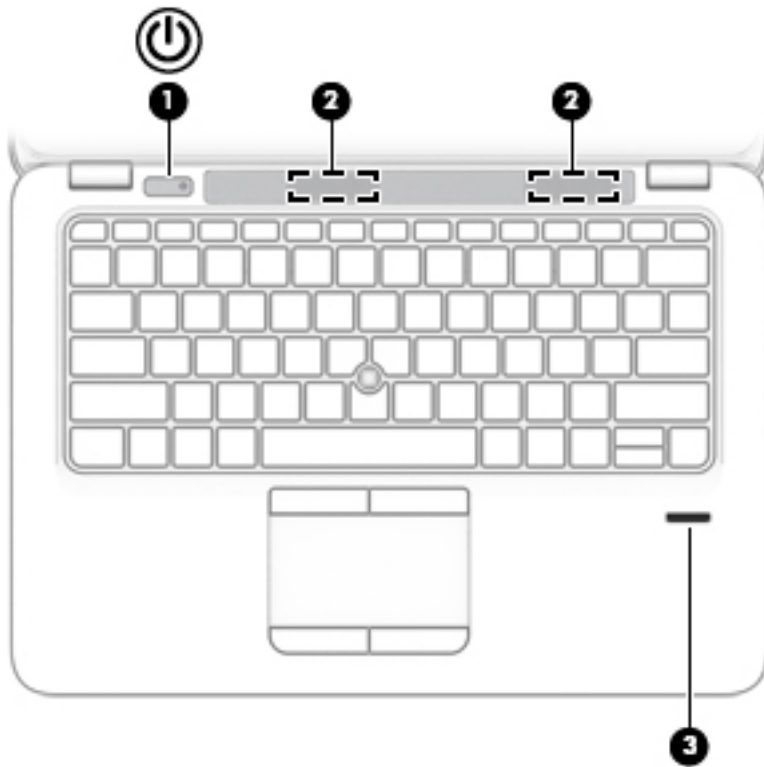

Component	Description
<p>(1)  Power button</p>	<ul style="list-style-type: none"> <li>• When the computer is off, press the button to turn on the computer.</li> <li>• When the computer is on, press the button briefly to initiate Sleep.</li> <li>• When the computer is in the Sleep state, press the button briefly to exit Sleep.</li> <li>• When the computer is in Hibernation, press the button briefly to exit Hibernation.</li> </ul> <p><b>CAUTION:</b> Pressing and holding down the power button results in the loss of unsaved information.</p> <p>If the computer has stopped responding and shutdown procedures are ineffective, press and hold the power button for at least 5 seconds to turn off the computer.</p> <p>To learn more about your power settings, see your power options.</p> <p>▲ Type <code>power options</code> in the taskbar search box, and then select <b>Power Options</b>.</p> <p>– or –</p> <p>Right-click the <b>Power meter</b> icon, and then select <b>Power Options</b>.</p>
<p>(2) Speakers (2)</p>	<p>Produce sound.</p>
<p>(3) Fingerprint reader (select products only)</p>	<p>Allows a fingerprint logon to Windows, instead of a password logon.</p>

## Keys

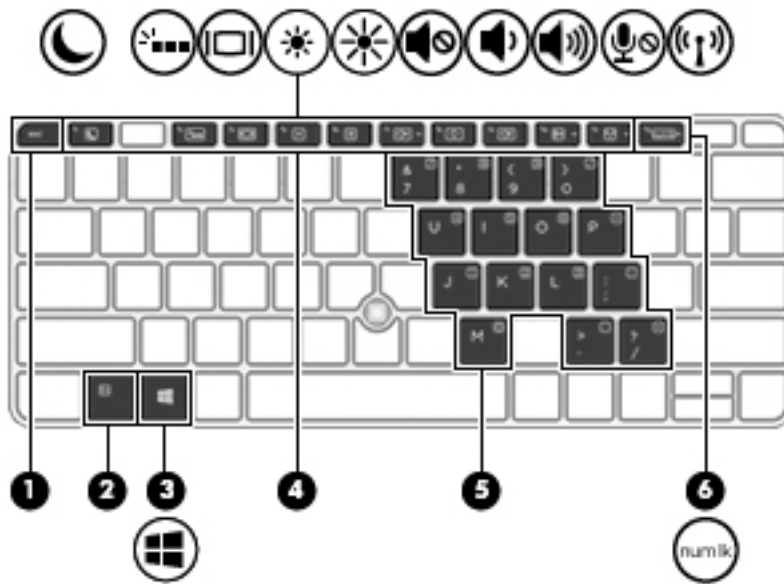











Component	Description
(1) <code>esc</code> key	Displays system information when pressed in combination with the <code>fn</code> key.
(2) <code>fn</code> key	Executes frequently used system functions when pressed in combination with a function key, the <code>num lk</code> key, the <code>esc</code> key, or other key.  See <a href="#">Using the hot keys on page 12</a>
(3)  Windows key	Opens the <b>Start</b> menu.  <b>NOTE:</b> Pressing the Windows key again will close the <b>Start</b> menu.
(4) Function keys	Executes frequently used system functions when pressed in combination with the <code>fn</code> key.  See <a href="#">Using the hot keys on page 12</a>
(5) Embedded numeric keypad	A numeric keypad superimposed over the keyboard alphabet keys that enables you to add, subtract, and perform other numeric tasks. When <code>num lk</code> is on, the keypad can be used like an external numeric keypad.  <b>NOTE:</b> If the keypad function is active when the computer is turned off, that function is reinstated when the computer is turned back on.
(6) <code>num lk</code> <code>num lk</code> key	Turns the embedded numeric keypad on and off when pressed in combination with the <code>fn</code> key.

## Using the hot keys

To use a hot key:

- ▲ Press the **fn** key, and then press one of the keys listed in the following table.

Press <b>fn</b> +function key	Description
	<p>Initiates Sleep, which saves your information in system memory. The display and other system components turn off and power is conserved.</p> <p>To exit Sleep, briefly press the power button.</p> <p><b>CAUTION:</b> To reduce the risk of information loss, save your work before initiating Sleep.</p>
	<p>Turns the backlight keyboard off or on.</p> <p><b>NOTE:</b> To conserve battery power, turn off this feature.</p>
	<p>Switches the screen image among display devices connected to the system. For example, if a monitor is connected to the computer, repeatedly pressing <b>fn+f4</b> alternates the screen image from computer display to monitor display to simultaneous display on both the computer and the monitor.</p> <p>Most external monitors receive video information on the computer using the external VGA video standard. The <b>fn+f4</b> hot key can also alternate images among other devices that are receiving video information on the computer.</p>
	<p>Decreases the screen brightness incrementally as long as you hold down the key.</p>
	<p>Increases the screen brightness incrementally as long as you hold down the key.</p>
	<p>Mutes or restores speaker sound.</p>
	<p>Decreases speaker volume incrementally while you hold down the key.</p>
	<p>Increases speaker volume incrementally while you hold down the key.</p>
	<p>Mutes the microphone.</p>
	<p>Turns the wireless feature on or off.</p> <p><b>NOTE:</b> A wireless network must be set up before a wireless connection is possible.</p>
<b>R</b>	<p>Pauses or breaks an operation. This replaces the break key.</p>
<b>C</b>	<p>Locks cell. This replaces the scroll lock key.</p>
<b>S</b>	<p>Sends a programming query. This replaces the sys rq key.</p>



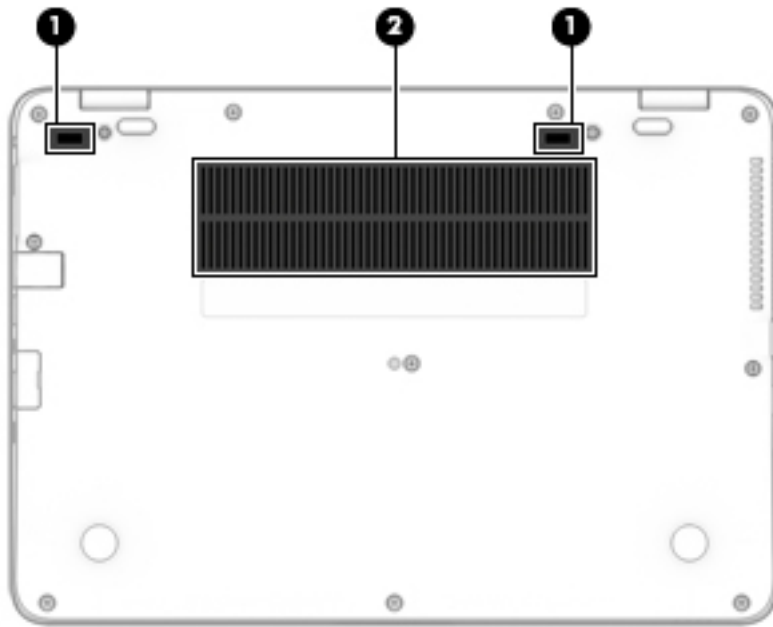

## Bottom



Component		Description
(1)	Docking connectors (2)	Connect an optional docking device.
(2)	Vents (2)	Enable airflow to cool internal components. <b>NOTE:</b> The computer fan starts up automatically to cool internal components and prevent overheating. It is normal for the internal fan to cycle on and off during routine operation.

## Front



Component	Description
(1)  Wireless light	<p>On: An integrated wireless device, such as a wireless local area network (WLAN) device and/or a Bluetooth® device, is on.</p> <p><b>NOTE:</b> On some models, the wireless light is amber when all wireless devices are off.</p>
(2)  Power light	<ul style="list-style-type: none"> <li>On: The computer is on.</li> <li>Blinking: The computer is in the Sleep state, a power-saving state. The computer shuts off power to the display and other unneeded components.</li> <li>Off: The computer is off or in Hibernation. Hibernation is a power-saving state that uses the least amount of power.</li> </ul>
(3)  Battery light	<p>When AC power is connected:</p> <ul style="list-style-type: none"> <li>White: The battery charge is greater than 90 percent.</li> <li>Amber: The battery charge is from 0 to 90 percent.</li> <li>Off: The battery is not charging.</li> </ul> <p>When AC power is disconnected (battery not charging):</p> <ul style="list-style-type: none"> <li>Blinking amber: The battery has reached a low battery level. When the battery has reached a critical battery level, the battery light begins blinking rapidly.</li> <li>Off: The battery is not charging.</li> </ul>
(4)  Drive light	<ul style="list-style-type: none"> <li>Blinking white: The hard drive is being accessed.</li> <li>Amber: HP 3D DriveGuard has temporarily parked the hard drive.</li> </ul>



# Labels

The labels laser etched on the computer provide information you may need when you troubleshoot system problems or travel internationally with the computer.

 **IMPORTANT:** Check the following locations for the labels described in this section: the bottom of the computer, inside the battery bay, under the service door, or on the back of the display.

- Service label—Provides important information to identify your computer. When contacting support, you will probably be asked for the serial number, and possibly for the product number or the model number. Locate these numbers before you contact support.

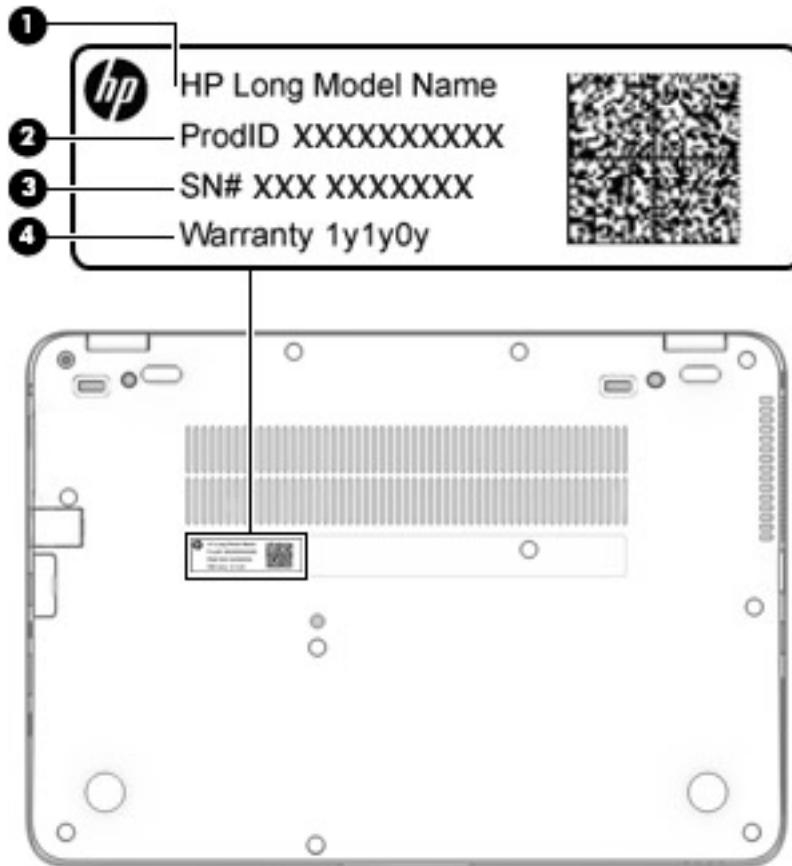

---

## Component

---

- (1) Model name (select products only)
  - (2) Product number
  - (3) Serial number
  - (4) Warranty period
- 

- Regulatory label(s)—Provide(s) regulatory information about the computer.
- Wireless certification label(s)—Provide(s) information about optional wireless devices and the approval markings for the countries or regions in which the devices have been approved for use.

# 3 Illustrated parts catalog

## Computer major components

 **NOTE:** HP continually improves and changes product parts. For complete and current information on supported parts for your computer, go to <http://partsurfer.hp.com>, select your country or region, and then follow the on-screen instructions.

 **NOTE:** Details about your computer, including model, serial number, product key, and length of warranty, are on the service tag at the bottom of your computer. See [Labels on page 15](#) for details.

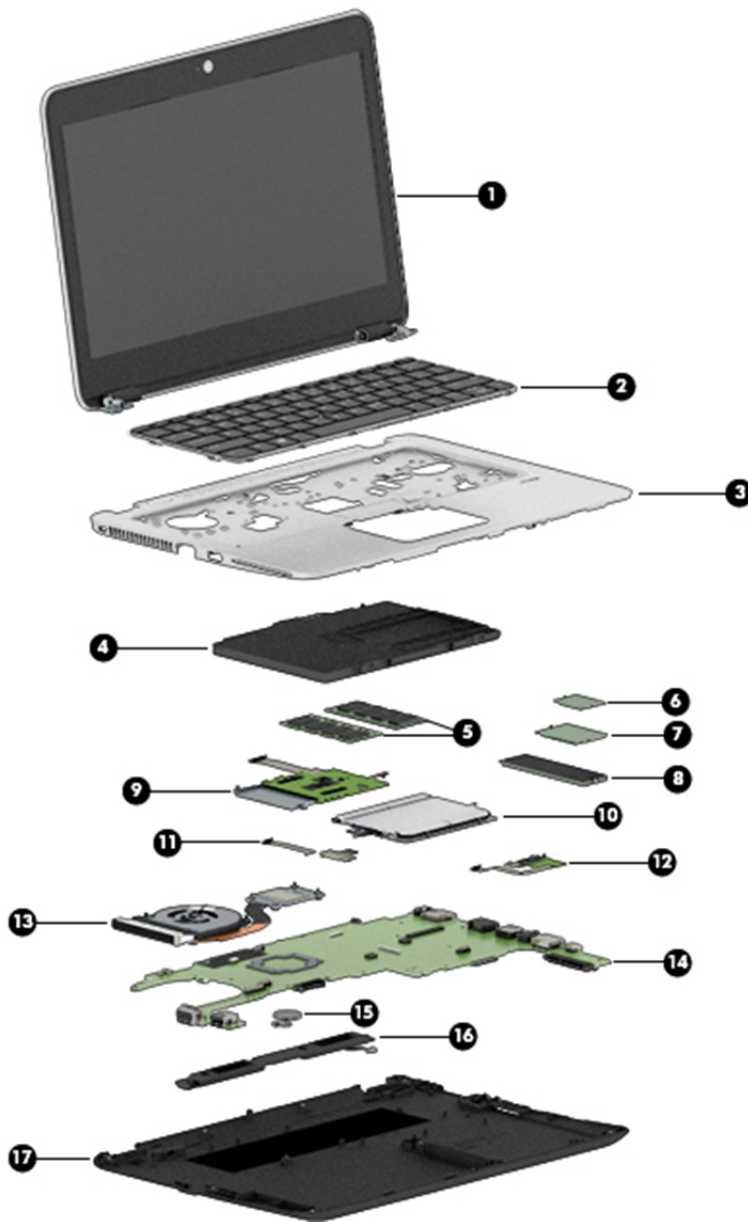

Item	Component	Spare part number
<b>(1)</b>	<b>Display assembly, touch</b>	920050-001
	<b>NOTE:</b> Non-touch display assemblies are spared at the subcomponent level only. For more non-touch display assembly spare part information, see <a href="#">Display assembly subcomponents on page 19</a> .	
	<b>NOTE:</b> Touch display assemblies are only spared as whole units.	
<b>(2)</b>	<b>Keyboard</b>	
	<b>NOTE:</b> Pointing stick covers are included in the Rubber Kit, spare part number 828884-001.	
	<b>NOTE:</b> For a detailed list of keyboard country codes, see <a href="#">Keyboard on page 46</a> .	
	Backlit	826630-xx1
	No backlight	826631-xx1
<b>(3)</b>	<b>Top cover</b>	821692-001
<b>(4)</b>	<b>Battery</b>	
	3 cell, 49 KWh, 4.25 Ah	854109-850
<b>(5)</b>	<b>Memory modules</b>	
	4-GB (2400-MHz, DDR4)	862397-850
	8-GB (2400-MHz, DDR4)	862398-850
	16-GB (2400-MHz, DDR4)	862396-850
<b>(6)</b>	<b>WLAN/Bluetooth combo card</b>	
	Intel Dual band wireless-AC 8265 802.11AC 2x2 WiFi + BT 4.2 Combo Adaptor (vPro)	851592-001
	Intel Dual band wireless-AC 8265 802.11AC 2x2 WiFi + BT 4.2 Combo Adaptor (non-vPro)	851594-001
	Intel Dual band wireless-AC 3168 802.11AC 1x1 WiFi + BT 4.2 Combo Adaptor (non-vPro)	852511-001
<b>(7)</b>	<b>WWAN module</b>	
	HP lt4120 LTE/EVDO/HSPA+ SnapdragonT X5 LTE Mobile Broadband Module	800870-001
	Huawei HP lt4132, LTE/HSPA+ without GPS M.2	845710-001
	Fibocom HP hs3210 WW HSPA+ without GPS	860726-001
<b>(8)</b>	<b>M.2 Solid-state drive (SSD)</b>	
	512 GB, PCIe Gen3x4 NVMe SS/DS MLC	915952-001
	512 GB, PCIe Gen3x4 NVMe TLC	915954-001
	512 GB, PCIe, Gen3x4, self-encrypting (SED), Opal 2, TLC	915953-001
	512 GB, SATA-3, FIPS-140-2, TLC	915955-001
	360 GB, PCIe Gen3x4 SS TLC	915951-001
	256 GB, PCIe NVMe TLC	915950-001
	256 GB, SATA-3 SS TLC (Opal 2)	915949-001
	128 GB, SATA-3, SS value	915948-001
<b>(9)</b>	<b>Smart card reader board</b> (includes cable)	914963-001

<b>Item</b>	<b>Component</b>	<b>Spare part number</b>
<b>(10)</b>	<b>Touchpad</b>	
	Touchpad board	821668-001
	Touchpad board with NFC antenna	821667-001
<b>(11)</b>	<b>NFC module</b> (includes NFC cable and NFC antenna)	821666-001
<b>(12)</b>	<b>Fingerprint reader board</b> (includes cable)	821693-001
	<b>NOTE:</b> The fingerprint reader bracket is included in the Plastics Kit, spare part number 821675-001.	
<b>(13)</b>	<b>Heat sink/fan assembly</b>	821691-001
<b>(14)</b>	<b>System board</b> (includes processor and replacement thermal material, see <a href="#">System board on page 61</a> )	
	Includes Intel i7-7600U processor	914274-xxx
	Includes Intel i7-7500U processor	914273-xxx
	Includes Intel i5-7300U processor	914272-xxx
	Includes Intel i5-7200U processor	914271-xxx
	Includes Intel i3-7100U processor	914270-xxx
<b>(15)</b>	<b>RTC battery</b>	702853-001
<b>(16)</b>	<b>Speaker assembly</b> (includes cable)	821684-001
<b>(17)</b>	<b>Bottom cover</b>	821662-001

## Display assembly subcomponents

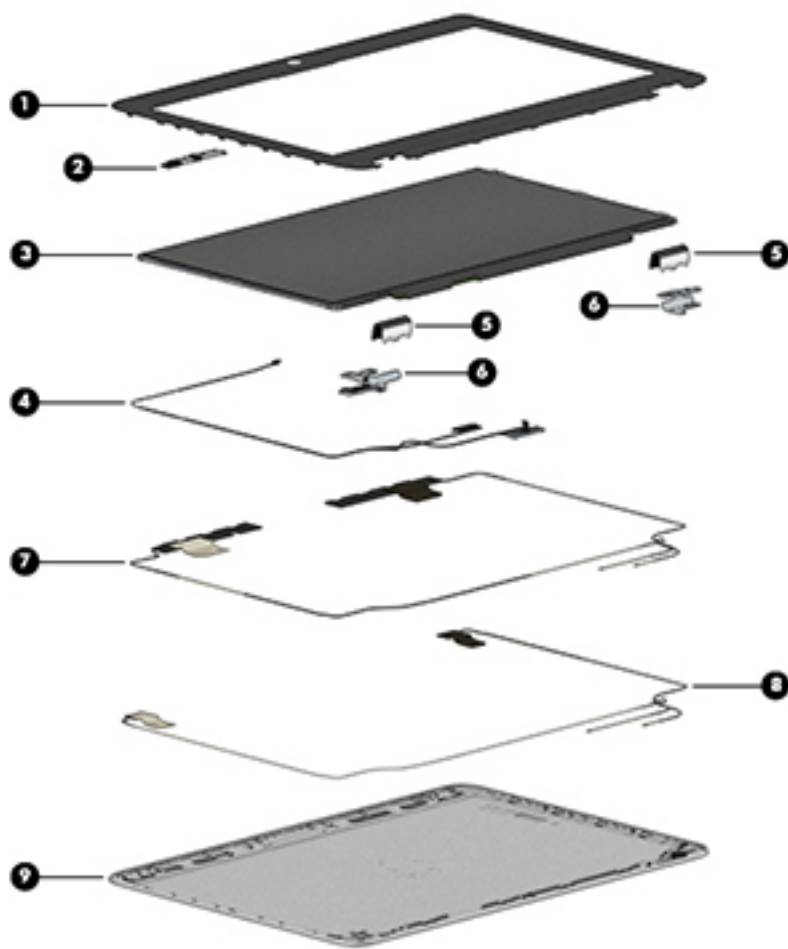

Item	Component	Spare part number
(1)	<b>Bezel</b>	821658-001
(2)	<b>Webcam module</b> (includes microphone and cable)	800575-020
	<b>Microphone module</b> (not illustrated)	920579-001
(3)	<b>Raw panel</b>	
	HD	804085-004
	FHD	832199-006
(4)	<b>Display cable</b> (spared with the Cable Kit, spare part number 912091-001)	
(5)	<b>Hinge covers</b> (spared with the Plastics Kit, spare part number 821675-001)	
(6)	<b>Hinges</b>	821674-001
(7)	<b>WWAN antenna</b> (spared with display enclosure)	
(8)	<b>WLAN antenna</b> (spared with display enclosure)	
(9)	<b>Display enclosure</b> (includes antennas)	862350-001

## Cable Kit

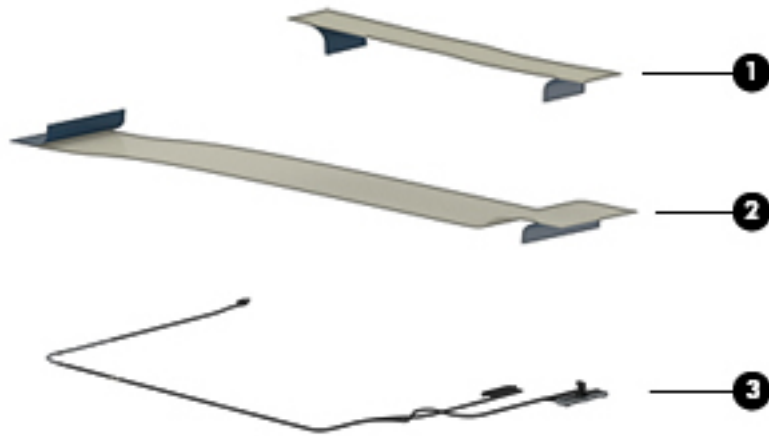

Item	Component	Spare part number
	<b>Cable Kit</b>	912091-001
(1)	NFC module cable	
(2)	Pointing stick cable	
(3)	Display cable	

## Plastics Kit

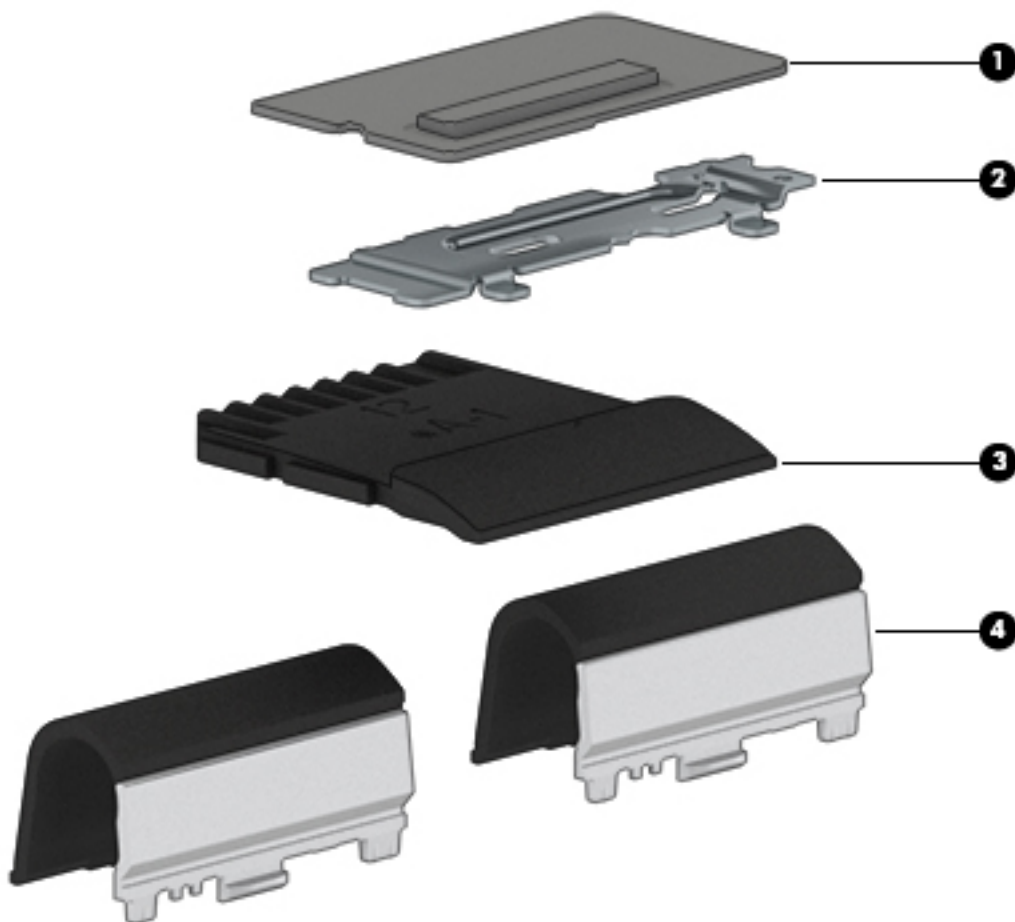

Item	Component	Spare part number
	<b>Plastics Kit</b>	821675-001
(1)	Fingerprint reader blank	
(2)	Fingerprint reader bracket	
(3)	SD card blank	
(4)	Hinge covers	
	Silicone rubber display bumpers (not shown)	
	Rubber screw covers (not shown)	

## Mass storage devices

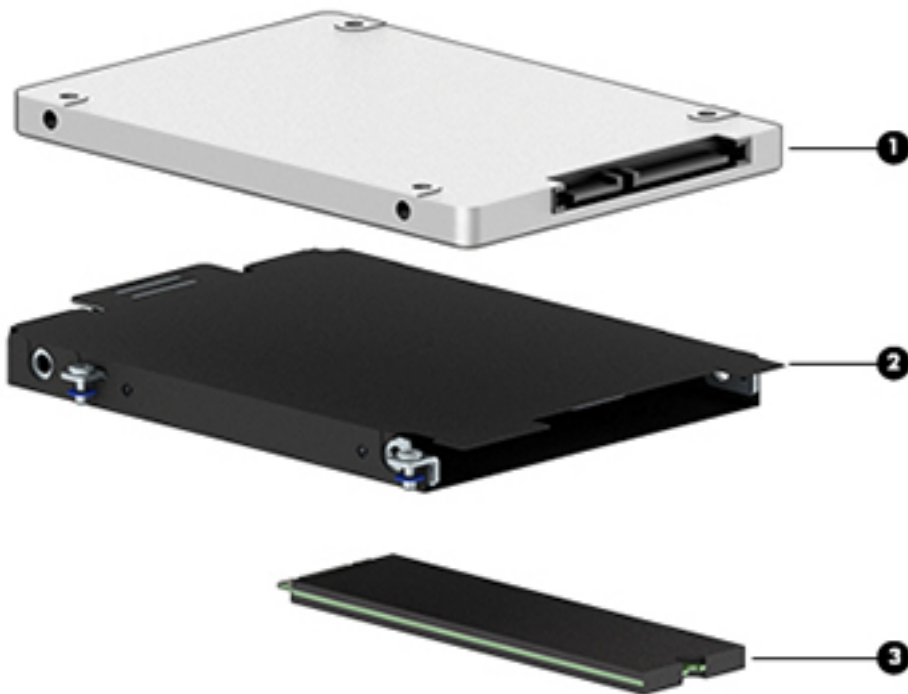

Item	Component	Spare part number
<b>(1)</b>	<b>Hard drive (7 mm)</b>	
	1 TB, 5400 rpm, 7 mm	832077-001
	500 GB, 7200 rpm, 7 mm, FIPS	820572-001
	500 GB, 7200 rpm, 7 mm, Opal-2	820573-001
	500 GB, 7200 rpm, 7 mm	703267-001
	500 GB, 5400 rpm, 7 mm, hybrid, 8 GB cache	732000-001
	Hard Drive Hardware Kit (includes cover and screws)	821665-001
<b>(2)</b>	<b>Hard Drive Hardware Kit (includes cover and screws)</b>	821665-001
<b>(3)</b>	<b>M.2 solid-state drive</b>	
	512 GB, PCIe Gen3×4 NVMe SS/DS MLC	915952-001
	512 GB, PCIe NVMe TLC	915954-001
	512 GB, PCIe, Gen3x4, self-encrypting (SED), Opal 2, TLC	915953-001
	512 GB, SATA-3, FIPS-140-2, TLC	915955-001
	360 GB, PCIe Gen3×4 SS TLC	915951-001
	256 GB, PCIe NVMe TLC	915950-001
	256 GB, SATA-3 SS TLC (Opal 2)	915949-001
	128 GB, SATA-3, SS value	915948-001



## Miscellaneous parts

Component	Spare part number
<b>AC adapter:</b>	
65 W Smart Adapter, non-PFC, EM	714635-850
65 W Smart Adapter non-PFC	693711-001
65 W Adapter non-PFC S-3P	710412-001
65 W Smart Adapter non-PFC, for use in Argentina	710340-850
65 W Smart Adapter, non-PFC, EM, RC/V	693710-001
45 W Smart Adapter non-PFC nSlim	741727-001
45 W Smart Adapter non-PFC 2-prong	742436-001
<b>HP Smart AC Adapter 4.5 mm to 7.4 mm adapter</b>	734734-001
<b>HP DisplayPort to HDMI 1.4 Adapter</b>	749288-001
<b>HP Essential Top Load Case</b>	679921-001
<b>HP Business Top Load Case</b>	718550-001
<b>HP Slim Ultrabook Top Load Case</b>	747078-001
<b>HP Elite USB-C Docking Station</b>	844550-001
<b>HP USB Travel Dock</b>	844551-001
<b>Cable lock docking station</b>	575921-001
<b>HP Ultraslim Keyed Cable Lock</b>	703372-001
<b>HP USB Laser Mouse</b>	674318-001
<b>HP Comfort Grip Wireless Mouse</b>	691922-001
<b>HP USB Travel Mouse</b>	757770-001
<b>HP Mobile Connect</b>	714749-001
<b>Power cord (3-pin, black, 1.0 m):</b>	
Argentina	401300-001
Australia	213356-001
Brazil	438722-001
Denmark	213353-001
Europe (Austria, Belgium, Finland, France, Germany, the Netherlands, Norway and Sweden)	213350-001
India	404827-001
Israel	398063-001
Italy	213352-001
Japan	349756-001
North America	213349-001
People's Republic of China	286497-001

<b>Component</b>	<b>Spare part number</b>
South Africa	361240-001
South Korea	267836-001
Switzerland	213354-001
Taiwan	393313-001
Thailand	285096-001
United Kingdom and Singapore	213351-001
<b>Power cord (3-pin, black, 1.83 m):</b>	
Argentina	401300-007
Australia	213356-008
Brazil	438722-004
Denmark	213353-008
Europe (Austria, Belgium, Finland, France, Germany, the Netherlands, Norway and Sweden)	213350-009
India	404827-003
Israel	398063-003
Italy	213352-008
Japan	349756-002
North America	213349-009
People's Republic of China	286497-008
South Africa	361240-002
South Korea	267836-008
Switzerland	213354-008
Taiwan	393313-003
Thailand	285096-006
United Kingdom and Singapore	213351-008
<b>Power cord (2-pin, black, 1.0 m):</b>	
For use in Japan	190548-003
<b>Rubber Kit (includes pointing stick cover)</b>	828884-001
<b>Screw kit</b>	821664-001

---

## 4 Removal and replacement procedures preliminary requirements

### Tools required

You will need the following tools to complete the removal and replacement procedures:

- Flat-bladed screwdriver
- Magnetic screwdriver
- Phillips P0 and P1 screwdrivers

### Service considerations

The following sections include some of the considerations that you must keep in mind during disassembly and assembly procedures.

---

 **NOTE:** As you remove each subassembly from the computer, place the subassembly (and all accompanying screws) away from the work area to prevent damage.

---

### Plastic parts

---

 **CAUTION:** Using excessive force during disassembly and reassembly can damage plastic parts. Use care when handling the plastic

---

## Cables and connectors

---

**⚠ CAUTION:** When servicing the computer, be sure that cables are placed in their proper locations during the reassembly process. Improper cable placement can damage the computer.

---

Cables must be handled with extreme care to avoid damage. Apply only the tension required to unseat or seat the cables during removal and insertion. Handle cables by the connector whenever possible. In all cases, avoid bending, twisting, or tearing cables. Be sure that cables are routed in such a way that they cannot be caught or snagged by parts being removed or replaced. Handle flex cables with extreme care; these cables tear easily.

## Drive handling

---

**⚠ CAUTION:** Drives are fragile components that must be handled with care. To prevent damage to the computer, damage to a drive, or loss of information, observe these precautions:

Before removing or inserting a hard drive, shut down the computer. If you are unsure whether the computer is off or in Hibernation, turn the computer on, and then shut it down through the operating system.

Before handling a drive, be sure that you are discharged of static electricity. While handling a drive, avoid touching the connector.

Before removing a diskette drive or optical drive, be sure that a diskette or disc is not in the drive and be sure that the optical drive tray is closed.

Handle drives on surfaces covered with at least one inch of shock-proof foam.

Avoid dropping drives from any height onto any surface.

Avoid exposing an internal hard drive to products that have magnetic fields, such as monitors or speakers.

Avoid exposing an internal hard drive to products that have magnetic fields, such as monitors or speakers.

Avoid exposing a drive to temperature extremes or liquids.

If a drive must be mailed, place the drive in a bubble pack mailer or other suitable form of protective packaging and label the package "FRAGILE."

---

# Grounding guidelines

## Electrostatic discharge damage

Electronic components are sensitive to electrostatic discharge (ESD). Circuitry design and structure determine the degree of sensitivity. Networks built into many integrated circuits provide some protection, but in many cases, ESD contains enough power to alter device parameters or melt silicon junctions.

A discharge of static electricity from a finger or other conductor can destroy static-sensitive devices or microcircuitry. Even if the spark is neither felt nor heard, damage may have occurred.

An electronic device exposed to ESD may not be affected at all and can work perfectly throughout a normal cycle. Or the device may function normally for a while, then degrade in the internal layers, reducing its life expectancy.

**CAUTION:** To prevent damage to the computer when you are removing or installing internal components, observe these precautions:

Keep components in their electrostatic-safe containers until you are ready to install them.

Before touching an electronic component, discharge static electricity by using the guidelines described in this section.

Avoid touching pins, leads, and circuitry. Handle electronic components as little as possible.

If you remove a component, place it in an electrostatic-safe container.

The following table shows how humidity affects the electrostatic voltage levels generated by different activities.

**CAUTION:** A product can be degraded by as little as 700 V.

Typical electrostatic voltage levels			
Event	Relative humidity		
	10%	40%	55%
Walking across carpet	35,000 V	15,000 V	7,500 V
Walking across vinyl floor	12,000 V	5,000 V	3,000 V
Motions of bench worker	6,000 V	800 V	400 V
Removing DIPS from plastic tube	2,000 V	700 V	400 V
Removing DIPS from vinyl tray	11,500 V	4,000 V	2,000 V
Removing DIPS from Styrofoam	14,500 V	5,000 V	3,500 V
Removing bubble pack from PCB	26,500 V	20,000 V	7,000 V
Packing PCBs in foam-lined box	21,000 V	11,000 V	5,000 V

## Packaging and transporting guidelines

Follow these grounding guidelines when packaging and transporting equipment:

- To avoid hand contact, transport products in static-safe tubes, bags, or boxes.
- Protect ESD-sensitive parts and assemblies with conductive or approved containers or packaging.
- Keep ESD-sensitive parts in their containers until the parts arrive at static-free workstations.
- Place items on a grounded surface before removing items from their containers.
- Always be properly grounded when touching a component or assembly.
- Store reusable ESD-sensitive parts from assemblies in protective packaging or nonconductive foam.
- Use transporters and conveyors made of antistatic belts and roller bushings. Be sure that mechanized equipment used for moving materials is wired to ground and that proper materials are selected to avoid static charging. When grounding is not possible, use an ionizer to dissipate electric charges.

## Workstation guidelines

Follow these grounding workstation guidelines:

- Cover the workstation with approved static-shielding material.
- Use a wrist strap connected to a properly grounded work surface and use properly grounded tools and equipment.
- Use conductive field service tools, such as cutters, screwdrivers, and vacuums.
- When fixtures must directly contact dissipative surfaces, use fixtures made only of static safe materials.
- Keep the work area free of nonconductive materials, such as ordinary plastic assembly aids and Styrofoam.
- Handle ESD-sensitive components, parts, and assemblies by the case or PCM laminate. Handle these items only at static-free workstations.
- Avoid contact with pins, leads, or circuitry.
- Turn off power and input signals before inserting or removing connectors or test equipment.

## Equipment guidelines

Grounding equipment must include either a wrist strap or a foot strap at a grounded workstation.

- When seated, wear a wrist strap connected to a grounded system. Wrist straps are flexible straps with a minimum of one megohm  $\pm 10\%$  resistance in the ground cords. To provide proper ground, wear a strap snugly against the skin at all times. On grounded mats with banana-plug connectors, use alligator clips to connect a wrist strap.
- When standing, use foot straps and a grounded floor mat. Foot straps (heel, toe, or boot straps) can be used at standing workstations and are compatible with most types of shoes or boots. On conductive floors or dissipative floor mats, use foot straps on both feet with a minimum of one megohm resistance between the operator and ground. To be effective, the conductive must be worn in contact with the skin.

The following grounding equipment is recommended to prevent electrostatic damage:

- Antistatic tape
- Antistatic smocks, aprons, and sleeve protectors
- Conductive bins and other assembly or soldering aids
- Nonconductive foam
- Conductive tabletop workstations with ground cords of one megohm resistance
- Static-dissipative tables or floor mats with hard ties to the ground
- Field service kits
- Static awareness labels
- Material-handling packages
- Nonconductive plastic bags, tubes, or boxes
- Metal tote boxes
- Electrostatic voltage levels and protective materials

The following table lists the shielding protection provided by antistatic bags and floor mats.

Material	Use	Voltage protection level
Antistatic plastics	Bags	1,500 V
Carbon-loaded plastic	Floor mats	7,500 V
Metallized laminate	Floor mats	5,000 V

---

# 5 Removal and replacement procedures for Customer Self-Repair parts

This chapter provides removal and replacement procedures for Customer Self-Repair parts.

There are as many as 26 screws that must be removed, replaced, and/or loosened when servicing Customer Self-Repair parts. Make special note of each screw size and location during removal and replacement.

 **NOTE:** The Customer Self-Repair program is not available in all locations. Installing a part not supported by the Customer Self-Repair program may void your warranty. Check your warranty to determine if Customer Self-Repair is supported in your location.

---

## Component replacement procedures

 **NOTE:** Details about your computer, including model, serial number, product key, and length of warranty, are on the service tag at the bottom of your computer. See [Labels on page 15](#) for details.

 **NOTE:** HP continually improves and changes product parts. For complete and current information on supported parts for your computer, go to <http://partsurfer.hp.com>, select your country or region, and then follow the on-screen instructions.

---

There are as many as xx screws that must be removed, replaced, and/or loosened when servicing Customer Self-Repair parts. Make special note of each screw size and location during removal and replacement.

### Bottom cover

---

Description	Spare part number
Bottom cover	821662-001

**NOTE:** Bottom rubber screw covers are available in the Plastics Kit, spare part number 821675-001.

---

Before removing the bottom cover, follow these steps:

1. Turn off the computer. If you are unsure whether the computer is off or in Hibernation, turn the computer on, and then shut it down through the operating system.
2. Disconnect the power from the computer by unplugging the power cord from the computer.
3. Disconnect all external devices from the computer.

Remove the bottom cover:

1. Turn the computer upside down on a flat surface.
2. In necessary, remove the SD card blank or SD card from the card reader.



3. Remove the 11 rubber screw covers from the bottom cover.

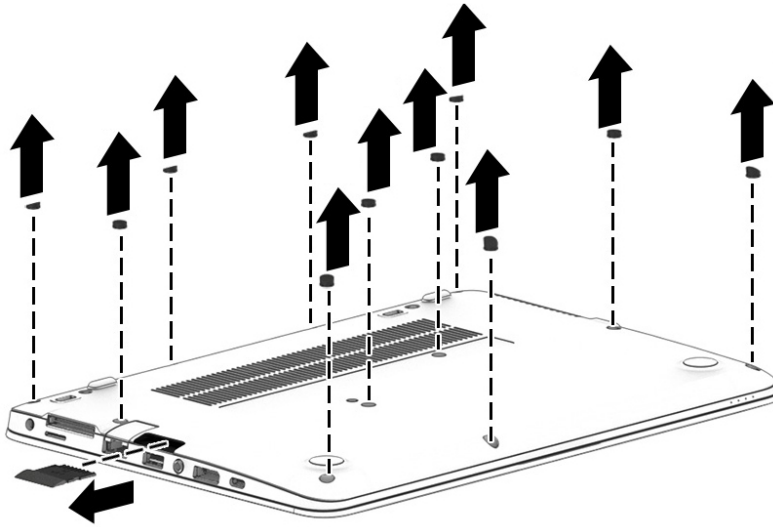

4. In the order indicated in the following image, remove the 12 Phillips M2.5x5.0 screws from the bottom cover.

 **IMPORTANT:** To make sure you can correctly reinstall the bottom cover, be sure to remove the screws in the order shown in the following image..

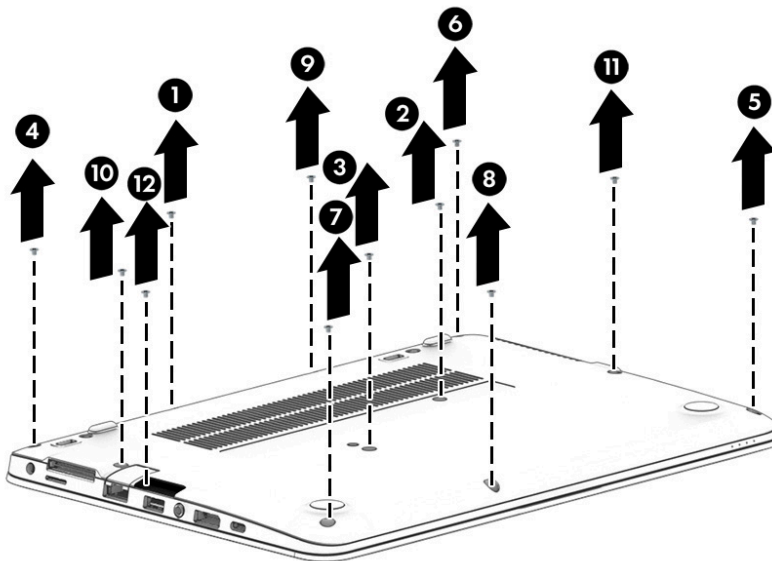

5. Pry up on the top (near the display hinge) of the bottom cover to disengage it from the computer.

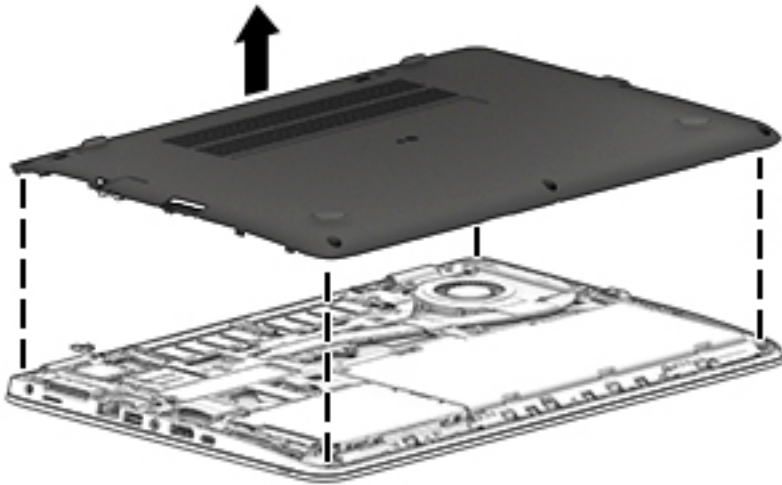

Reverse the removal procedures to install the bottom cover.

When replacing the bottom cover screws, be sure to install the screws in the order indicated in the following image:



**IMPORTANT:** Failure to install the screws in the correct order can result in uneven bottom cover placement.

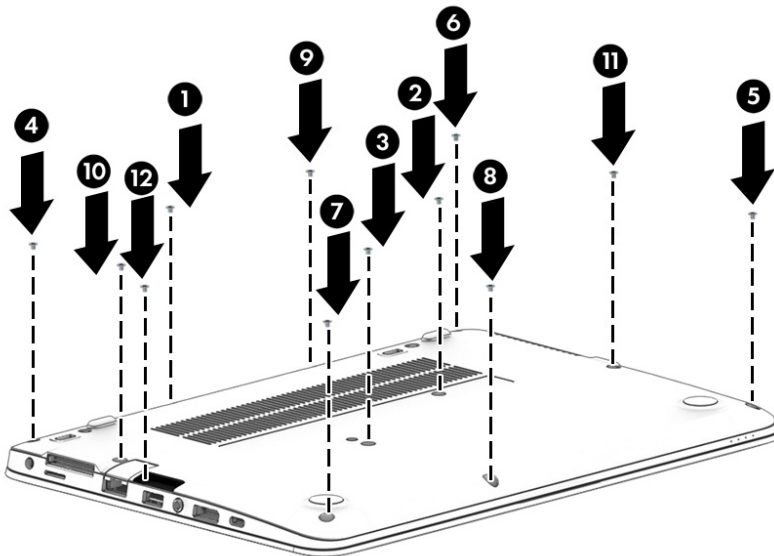

There are four different sizes of rubber screw covers. Be sure that you reinstall them over the correct screws. The rubber-screw cover sizes are as shown in the following image:



The rubber-screw cover locations are as shown in the following image:

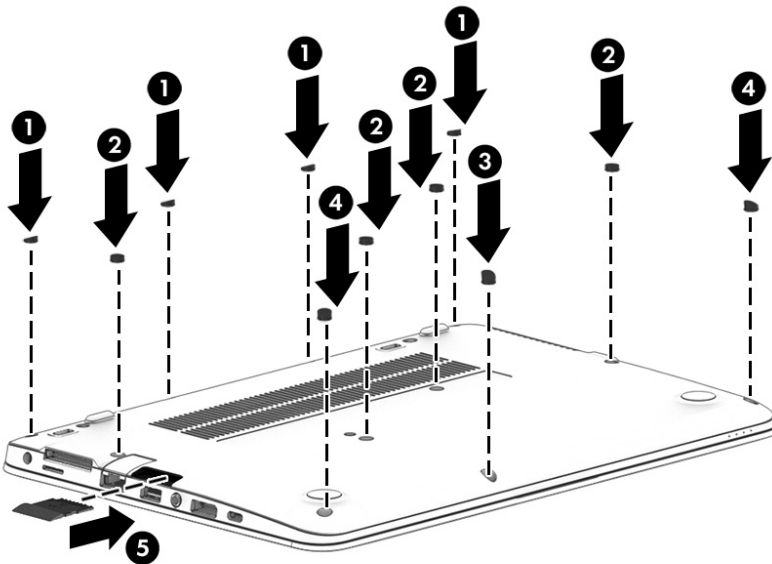

**NOTE:** If installing new rubber screw covers, carefully inspect for adhesive tape liner inside the cap and remove if present.

To properly insert the rubber covers, be sure to orient the covers in the correct direction:

1. Place the lower edge into the recess **(1)**, followed by the higher edge **(2)**.

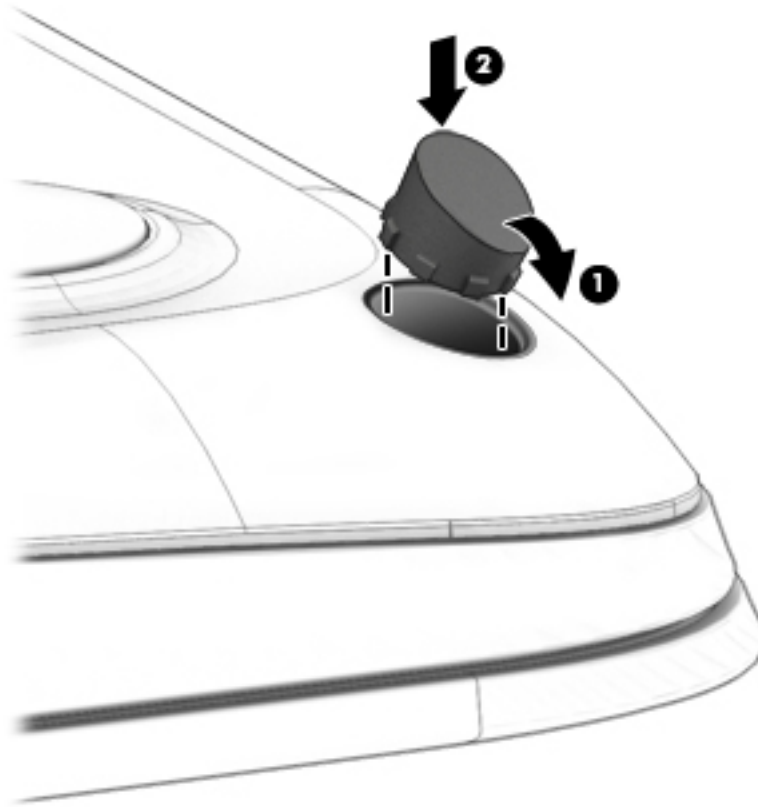

2. Use a small plastic rod or the soft part of your finger (not a fingernail) to ensure compaction into the recess.
3. Visually inspect all rubber caps to be sure that they installed in the correct locations. Run a finger over the tops of the rubber caps to ensure they are properly seated.

## Battery

Description	Spare part number
3-cell, 49 WHr, 4.25 Ah Li-ion battery	854109-850

Before removing the battery, follow these steps:

1. Turn off the computer. If you are unsure whether the computer is off or in Hibernation, turn the computer on, and then shut it down through the operating system.
2. Disconnect the power from the computer by unplugging the power cord from the computer.
3. Disconnect all external devices from the computer.
4. Remove the bottom cover (see [Bottom cover on page 30](#)).

To remove the battery:

- ⚠ **WARNING!** To reduce potential safety issues, use only the user-replaceable battery provided with the computer, a replacement battery provided by HP, or a compatible battery purchased from HP.
- ⚠ **CAUTION:** Removing a user-replaceable battery that is the sole power source for the computer can cause loss of information. To prevent loss of information, save your work or shut down the computer through Windows before removing the battery.

- ▲ Loosen the captive screw **(1)** and lift the tab **(2)** to remove the battery from the computer **(3)**.

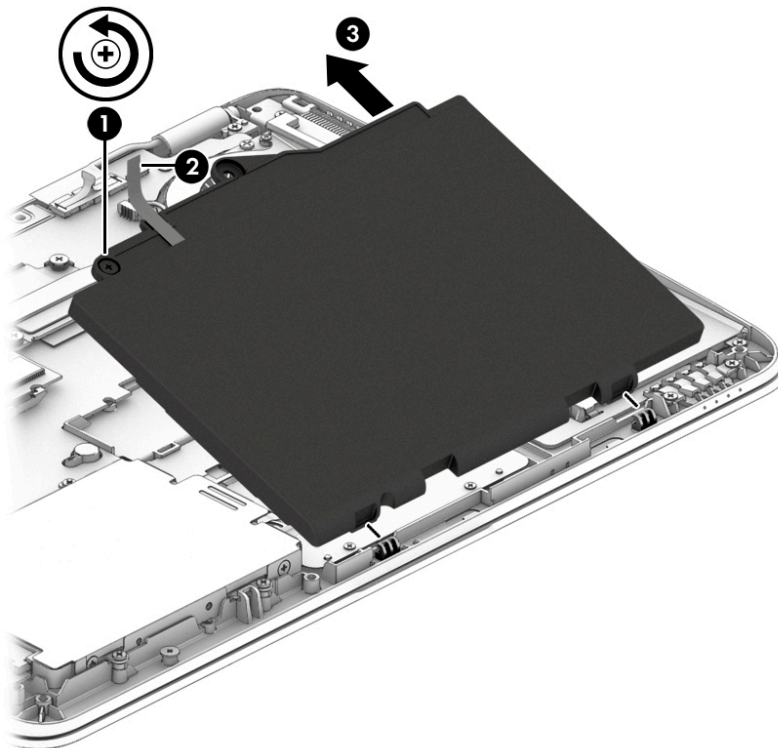

To insert the battery, reverse the removal procedures.

## Hard drive

Description	Spare part number
1 TB, 5400 rpm, 7 mm	832077-001
500 GB, 7200 rpm, 7 mm, FIPS	820572-001
500 GB, 7200 rpm, 7 mm, Opal-2	820573-001
500 GB, 7200 rpm, 7 mm	703267-001
500 GB, 5400 rpm, 7 mm, hybrid, 8 GB cache	732000-001
Hard Drive Hardware Kit (includes cover and screws)	821665-001



**NOTE:** Only one mass storage device (hard drive or a solid-state drive) can be installed.

Before removing the hard drive, follow these steps:

1. Shut down the computer. If you are unsure whether the computer is off or in Hibernation, turn the computer on, and then shut it down through the operating system.
2. Disconnect all external devices connected to the computer.
3. Disconnect the power from the computer by first unplugging the power cord from the AC outlet, and then unplugging the AC adapter from the computer.
4. Remove the bottom cover (see [Bottom cover on page 30](#)).
5. Remove the battery (see [Battery on page 35](#)).

To remove a hard drive:

1. Loosen the 4 captive screws **(1)** that secure the hard drive to the chassis.
2. Slide the hard drive **(2)** away from the connector.

3. Lift to remove the hard drive from the bay (3).

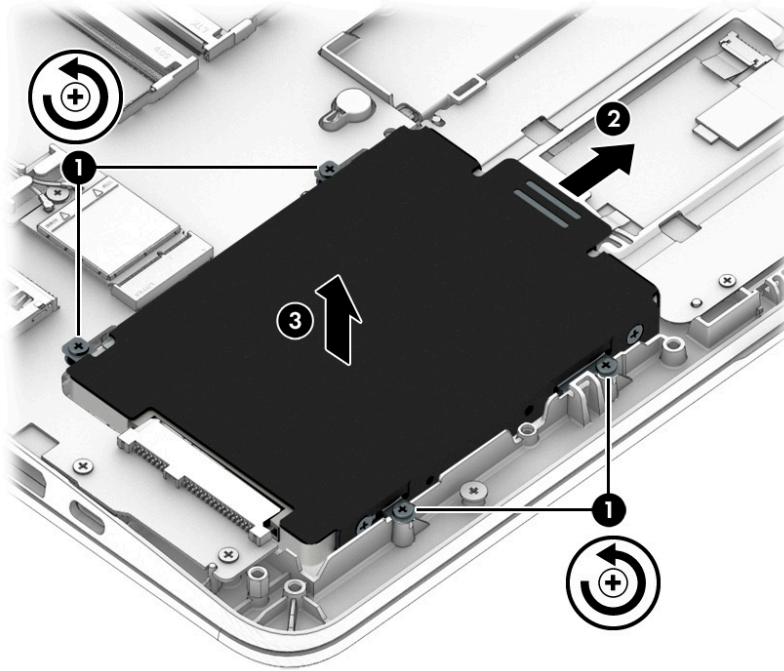

4. To remove the hard drive cover from the hard drive, remove the 4 Phillips M3.0×3.0 screws (1) that secure the bracket to the drive, and then lift the bracket up and off the hard drive (2).

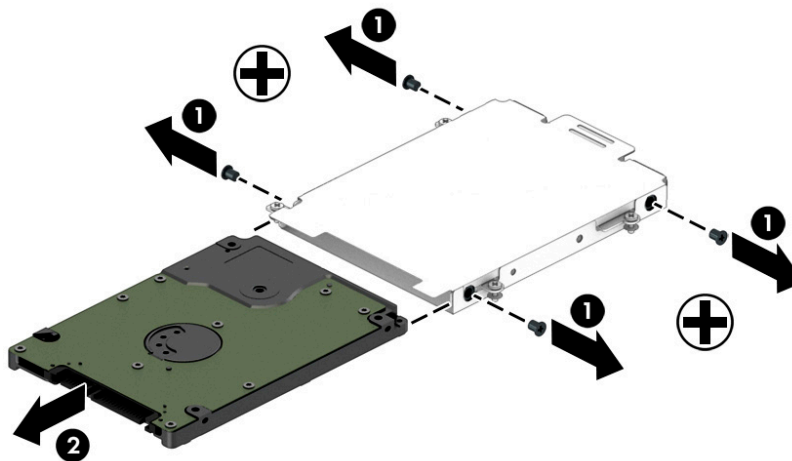

Reverse this procedure to install a hard drive.

## Solid-state drive

Description	Spare part number
512 GB, PCIe Gen3×4 NVMe SS/DS MLC	915952-001
512 GB, PCIe NVMe TLC	915954-001
512 GB, PCIe, Gen3×4, self-encrypting (SED), Opal 2, TLC	915953-001
512 GB, SATA-3, FIPS-140-2, TLC	915955-001
360 GB, PCIe Gen3×4 SS TLC	915951-001
256 GB, PCIe NVMe TLC	915950-001
256 GB, SATA-3 SS TLC (Opal 2)	915949-001
128 GB, SATA-3, SS value	915948-001



**NOTE:** Only one mass storage device (hard drive or a solid-state drive) can be installed.

Before removing the solid-state drive, follow these steps:

1. Turn off the computer. If you are unsure whether the computer is off or in Hibernation, turn the computer on, and then shut it down through the operating system.
2. Disconnect the power from the computer by unplugging the power cord from the computer.
3. Disconnect all external devices from the computer.
4. Remove the bottom cover (see [Bottom cover on page 30](#)).
5. Disconnect the battery (see [Battery on page 35](#)).

Remove the solid-state drive:

1. Remove the Phillips M2.0×3.0 screw **(1)** that secures the drive to the system board.



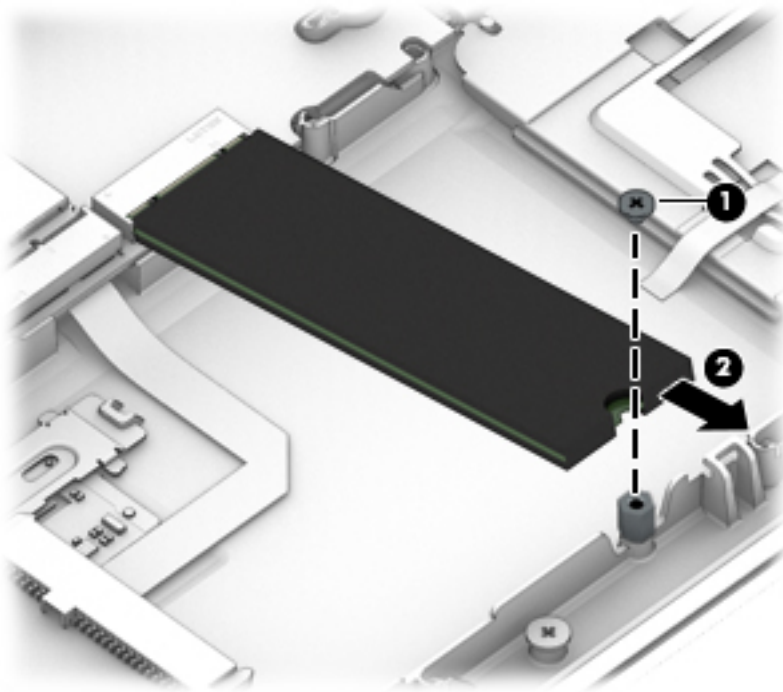

2. Remove the drive **(2)** by pulling it away from the connector.

 **NOTE:** M.2 solid-state drives are designed with notches to prevent incorrect insertion.

Reverse this procedure to reassemble and install the solid-state drive.

## Memory modules

 **NOTE:** Primary and expansion memory is installed in a side-by-side configuration in the bottom of the computer.

If only one memory module is installed, it must be installed in the socket labeled 1.

Description	Spare part number
4-GB (2400-MHz, DDR4)	862397-850
8-GB (2400-MHz, DDR4)	862398-850
16-GB (2400-MHz, DDR4)	862396-850

### Update BIOS before adding memory modules

Before adding new memory, make sure you update the computer to the latest BIOS.

 **CAUTION:** Failure to update the computer to the latest BIOS prior to installing new memory may result in various system problems.

To update BIOS:

1. Navigate to [www.hp.com](http://www.hp.com).
2. Click **Support & Drivers** > click **Drivers & Software**.
3. In the **Enter a product name/number** box, type the computer model information, and then click **Search**.
4. Click the link for the computer model.
5. Select the operating system, and then click **Next**.
6. Under **Step 2: Select a Download**, click the **BIOS** link.
7. Click the link for the most recent BIOS.
8. Click the **Download** button, and then follow the on-screen instructions.

Before removing the memory module, follow these steps:

1. Shut down the computer. If you are unsure whether the computer is off or in Hibernation, turn the computer on, and then shut it down through the operating system.
2. Disconnect all external devices connected to the computer.
3. Disconnect the power from the computer by first unplugging the power cord from the AC outlet, and then unplugging the AC adapter from the computer.
4. Remove the bottom cover (see [Bottom cover on page 30](#)).
5. Remove the battery (see [Battery on page 35](#)).

Remove the memory module:

1. Spread the retaining tabs **(1)** on each side of the memory module slot to release the memory module. (The edge of the module opposite the slot rises away from the computer.)

2. Remove the memory module (2) by pulling the module away from the slot at an angle.

 **NOTE:** Memory modules are designed with a notch to prevent incorrect insertion into the memory module slot.

 **NOTE:** The computer uses two memory sockets. The socket labeled 2 houses the expansion memory module and the socket labeled 1 houses the primary memory module. The removal procedure is the same for both memory sockets.

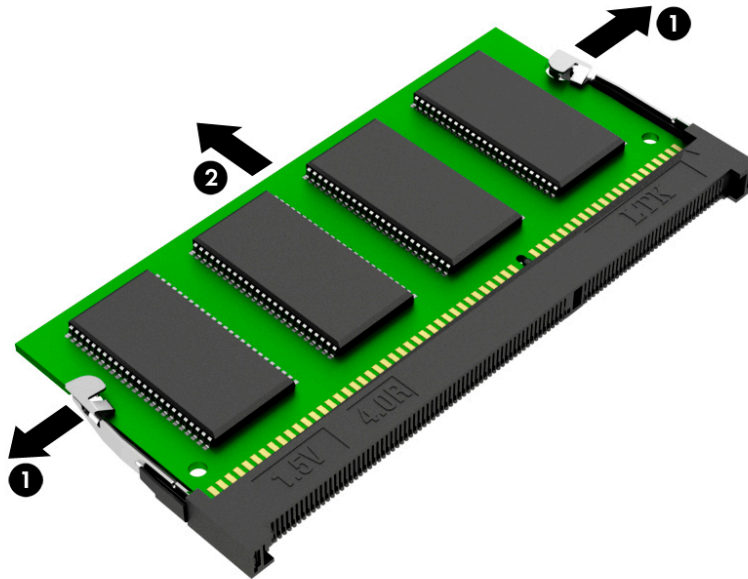

Reverse this procedure to install a memory module.

## WLAN/Bluetooth combo card

The computer uses a card that provides both WLAN and Bluetooth functionality.

The WLAN module and WWAN module are not interchangeable.

Description	Spare part number
Intel Dual band wireless-AC 8265 802.11AC 2x2 WiFi + BT 4.2 Combo Adaptor (vPro)	851592-001
Intel Dual band wireless-AC 8265 802.11AC 2x2 WiFi + BT 4.2 Combo Adaptor (non-vPro)	851594-001
Intel Dual band wireless-AC 3168 802.11AC 1x1 WiFi + BT 4.2 Combo Adaptor (non-vPro)	852511-001

Before removing the WLAN module, follow these steps:

1. Shut down the computer. If you are unsure whether the computer is off or in Hibernation, turn the computer on, and then shut it down through the operating system.
2. Disconnect all external devices connected to the computer.
3. Disconnect the power from the computer by first unplugging the power cord from the AC outlet, and then unplugging the AC adapter from the computer.
4. Remove the bottom cover (see [Bottom cover on page 30](#)).
5. Remove the battery (see [Battery on page 35](#)).

Remove the WLAN module:

1. Disconnect the WLAN antenna cables **(1)** from the terminals on the WLAN module.





**NOTE:** The WLAN antenna cable labeled “1” connects to the WLAN module “Main” terminal labeled “1”. The WLAN antenna cable labeled “2” connects to the WLAN module “Aux” terminal labeled “2”. If the computer is equipped with an 802.11a/b/g/n WLAN module, the yellow WLAN antenna cable connects to the middle terminal on the WLAN module.

2. Remove the one Phillips M2.5×3.0 screw **(2)** that secures the WLAN module to the computer. (The edge of the module opposite the slot rises away from the computer.)

3. Remove the WLAN module by pulling the module away from the slot at an angle (3).

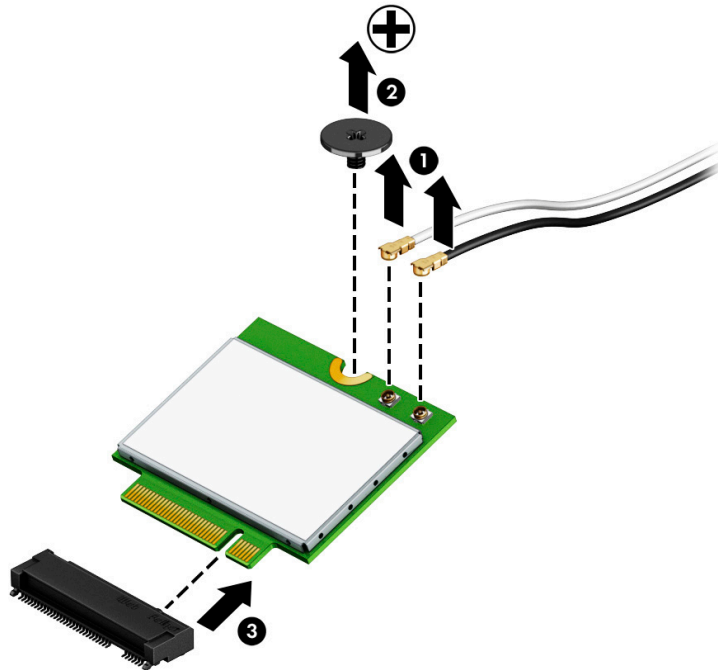
 **NOTE:** WLAN modules are designed with a notch to prevent incorrect insertion.



 **NOTE:** If the WLAN antennas are not connected to the terminals on the WLAN module, the protective sleeves must be installed on the antenna connectors, as shown in the following illustration.

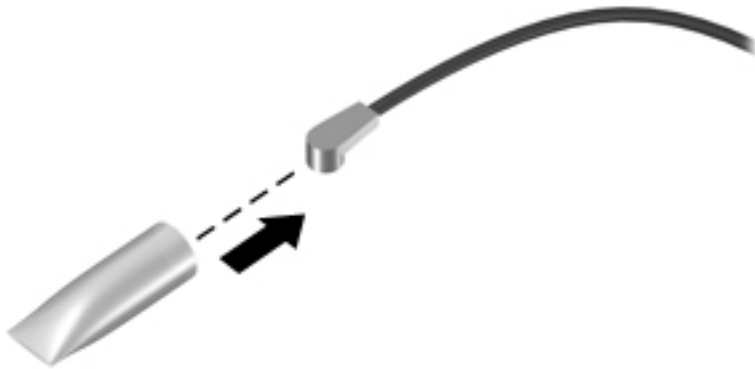

Reverse this procedure to install the WLAN module.

## WWAN module

The WLAN module and WWAN module are not interchangeable.

The WWAN module is available on select models only.

Description	Spare part number
HP It4120 LTE/EVDO/HSPA+ SnapdragonT X5 LTE Mobile Broadband Module	800870-001
Huawei HP It4132, LTE/HSPA+ with GPS M.2	845710-001
Fibocom HP hs3210 WW HSPA+ without GPS	860726-001

Before removing the WWAN module, follow these steps:

1. Shut down the computer. If you are unsure whether the computer is off or in Hibernation, turn the computer on, and then shut it down through the operating system.
2. Disconnect all external devices connected to the computer.
3. Disconnect the power from the computer by first unplugging the power cord from the AC outlet, and then unplugging the AC adapter from the computer.
4. Remove the bottom cover (see [Bottom cover on page 30](#)).
5. Remove the battery (see [Battery on page 35](#)).

Remove the WWAN module:

1. Position the computer upside-down.
2. Disconnect the WWAN antenna cables **(1)** from the terminals on the WWAN module.





**NOTE:** The red WWAN antenna cable is connected to the WWAN module “Main” terminal. The blue WWAN antenna cable is connected to the WWAN module “Aux” terminal.

3. Remove the one Phillips M2.5×3.0 screws **(2)** that secure the WWAN module to the computer. (The edge of the module opposite the slot rises away from the computer.)

4. Remove the WWAN module (3) by pulling the module away from the slot at an angle.

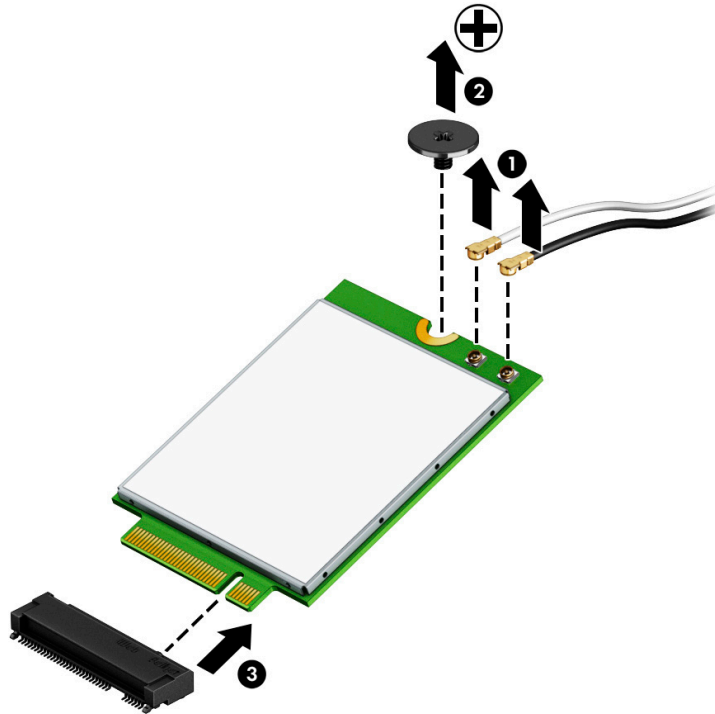
 **NOTE:** WWAN modules are designed with a notch to prevent incorrect insertion.



 **NOTE:** If the WWAN antennas are not connected to the terminals on the WWAN module, the protective sleeves must be installed on the antenna connectors, as shown in the following illustration.

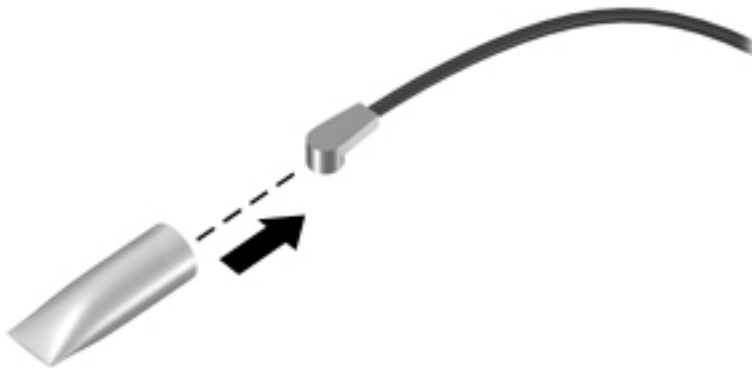

Reverse this procedure to install the WWAN module.

## Keyboard

In this section, the first table provides the main spare part number for the keyboards. The second table provides the country codes.

Description	Spare part number
Keyboard, no backlight	826631-xx1
Keyboard, backlit	826630-xx1

 **NOTE:** The pointing stick cable is included in the Cable Kit, spare part number 912091-001.

 **NOTE:** Pointing stick covers are included in the Rubber Kit, spare part number 828884-001.

For use in country or region	Spare part number	For use in country or region	Spare part number	For use in country or region	Spare part number
Belgium	-A41	India	-D61	Slovenia	-BA1
Brazil	-201	Israel	-BB1	South Korea	-AD1
Bulgaria	-261	Italy	-061	Spain	-071
Canada	-DB1	Japan	-291	Sweden and Finland	-B71
Czech Republic and Slovakia	-FL1	Latin America	-161	Switzerland	-BG1
Denmark	-081	The Netherlands	-B31	Taiwan	-AB1
Denmark, Finland, and Norway	-DH1	Northern Africa	-FP1	Thailand	-281
France	-051	Norway	-091	Turkey	-141
Germany	-041	Portugal	-131	Turkey	-541
Greece	-151	Romania	-271	United Kingdom	-031
Hungary	-211	Russia	-251	United States	-001
Iceland	-DD1	Saudi Arabia	-171		

Before removing the keyboard, follow these steps:

1. Shut down the computer. If you are unsure whether the computer is off or in Hibernation, turn the computer on, and then shut it down through the operating system.
2. Disconnect all external devices connected to the computer.
3. Disconnect the power from the computer by first unplugging the power cord from the AC outlet, and then unplugging the AC adapter from the computer.
4. Remove the bottom cover (see [Bottom cover on page 30](#)).
5. Remove the battery (see [Battery on page 35](#)).

Remove the keyboard:



1. Position the computer upside down.
2. Remove the 2 broadhead Phillips M2.5×2.5 screws that secure the keyboard to the computer **(1)**.

 **NOTE:** The screws are labeled with a keyboard symbol.

3. Position the computer on its side and partially open.
4. Insert a screwdriver or similar thin tool into the hole beside the heat sink/fan assembly, and then press on the back of the keyboard until it disengages from the computer **(2)**. Rotate the top of the keyboard upward, and then lift the keyboard up at an angle to disengage the tabs at the bottom of the keyboard.

 **NOTE:** Cables connect the bottom of the keyboard to the system board. Make sure not to prematurely pull the keyboard cables out of the system board connectors.

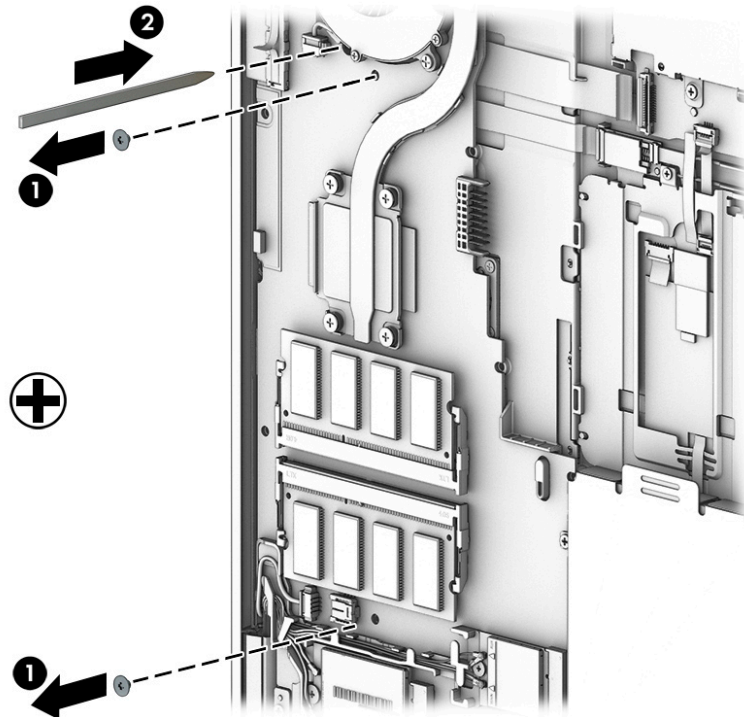

5. Position the computer upright with the front toward you.
6. Open the computer as far as possible.
7. Slide the keyboard slightly downward, and then lift and rotate the keyboard over onto the palm rest **(1)**.
8. Lift the ZIF connector **(2)** for the pointing stick cable connector, then and remove the cable from the connector **(3)**.
9. Lift the ZIF connector **(4)** for the keyboard backlight cable connector, and then remove the cable from the connector **(5)**.
10. Lift the ZIF connector **(6)** for the keyboard cable connector, and then remove the cable from the connector **(7)**.

**11. Remove the keyboard (8).**

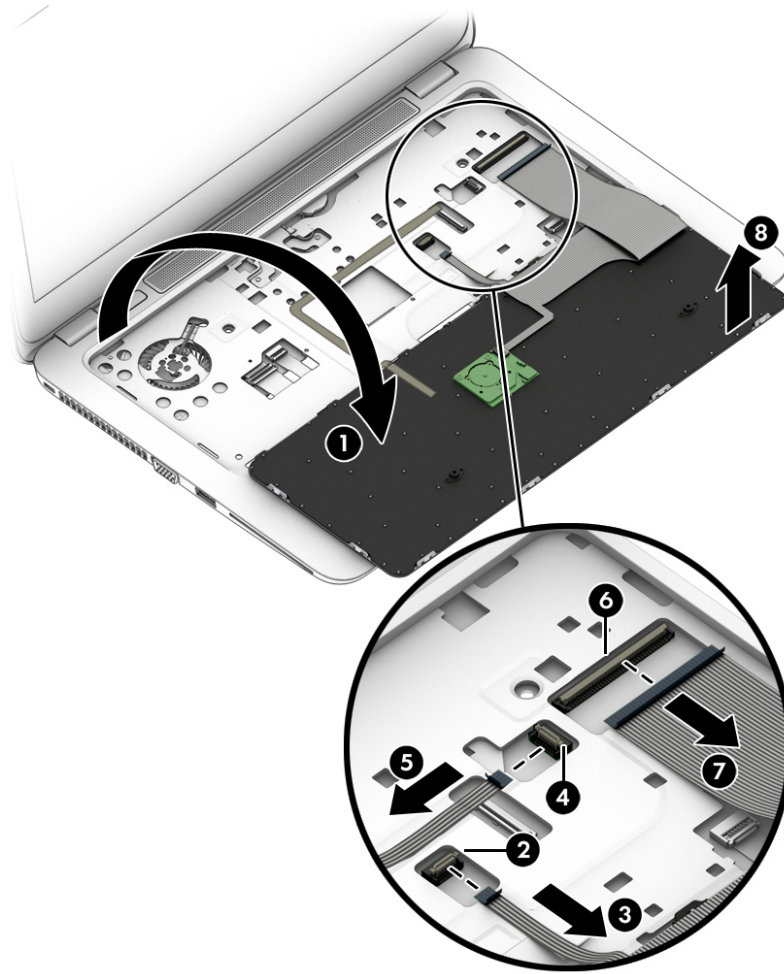

Reverse this procedure to install the keyboard.

---

## 6 Removal and replacement procedures for Authorized Service Provider parts

This chapter provides removal and replacement procedures for Authorized Service Provider only parts.

 **CAUTION:** Components described in this chapter should only be accessed by an authorized service provider. Accessing these parts can damage the computer or void the warranty.

**CAUTION:** This computer does not have user-replaceable parts. Only HP authorized service providers should perform the removal and replacement procedures described here. Accessing the internal part could damage the computer or void the warranty.

---

### Component replacement procedures

---

 **NOTE:** Details about your computer, including model, serial number, product key, and length of warranty, are on the service tag at the bottom of your computer. See [Labels on page 15](#) for details.

 **NOTE:** HP continually improves and changes product parts. For complete and current information on supported parts for your computer, go to <http://partsurfer.hp.com>, select your country or region, and then follow the on-screen instructions.

---

There are as many as 37 screws that must be removed, replaced, and/or loosened when servicing Authorized Service Provider only parts. Make special note of each screw size and location during removal and replacement.

## Display assembly

Description	Spare part number
Display panel assembly, touch screen	920050-001
<b>NOTE:</b> Non-touch display assemblies are spared at the subcomponent level only.	
<b>NOTE:</b> Touch display assemblies are only spared as whole units	

Before removing the display assembly, follow these steps:

1. Shut down the computer. If you are unsure whether the computer is off or in Hibernation, turn the computer on, and then shut it down through the operating system.
2. Disconnect all external devices connected to the computer.
3. Disconnect the power from the computer by first unplugging the power cord from the AC outlet, and then unplugging the AC adapter from the computer.
4. Remove the bottom cover (see [Bottom cover on page 30](#)).
5. Remove the battery (see [Battery on page 35](#)).

Remove the display assembly:

1. Position the computer upside down.
2. Disconnect the antennas **(1)** from the WWAN module (if equipped).
3. Disconnect the antennas **(2)** from the WLAN module (if equipped).
4. Remove the antennas cables (if equipped) from the routing path along the base of the computer **(3)**.
5. Disconnect the display cable from the system board **(4)**.

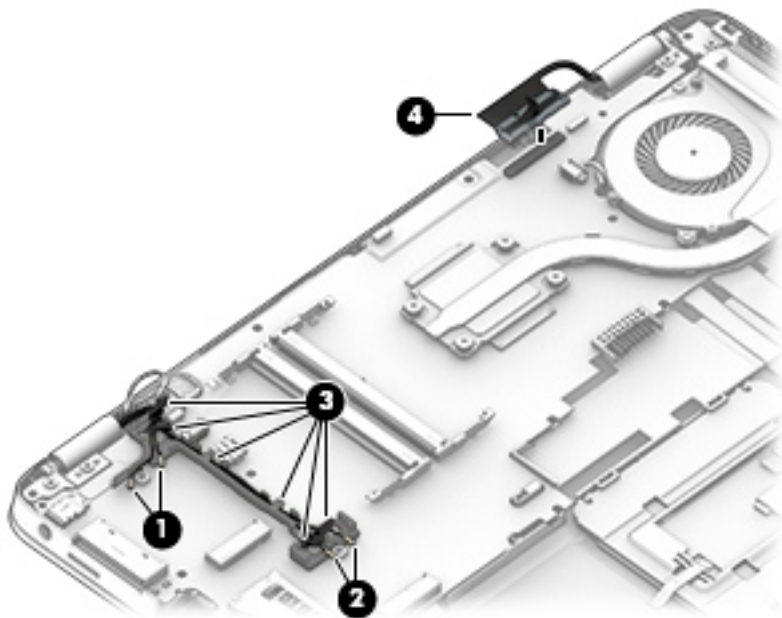

6. Remove the 4 Phillips M2.5×5.0 screws **(1)** from the display hinges.

- Lift the hinges (2) up and remove the top cover from the display assembly (3).

**CAUTION:** When installing the display assembly, be sure that the wireless antenna cables are routed and arranged properly.

Failure to properly route the antennas can result in degradation of the computer's wireless performance.

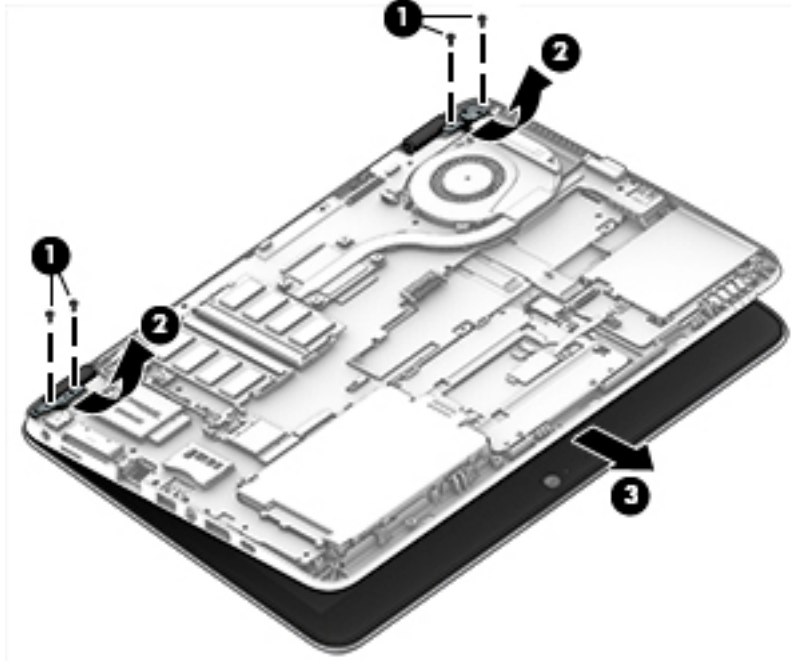

- If you need to remove the display bezel, flex the top (1) of the bezel, the inside edges of the left and right sides (2), and then the bottom (3) of the bezel until it disengages from the display enclosure.

**NOTE:** Make sure the hinges are not bent (see hinge position in following image) when you remove the bezel.

- Remove the display bezel (4).

The display bezel is available using spare part number 821658-001.

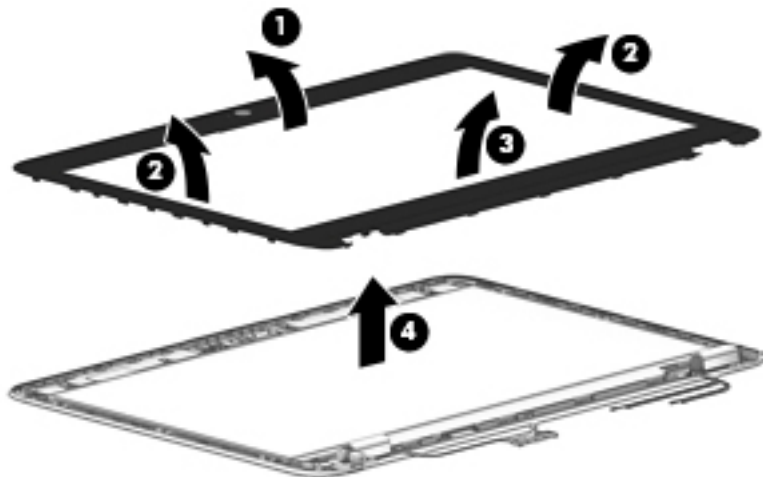

10. If it is necessary to replace the webcam or microphone module, use a tool to pry the webcam to disengage it from the adhesive that secures it to the display (1). Lift the module (2), and then disconnect the cable (3).

The webcam module is available using spare part number 800575-020. The microphone module is available using spare part number 920579-001.

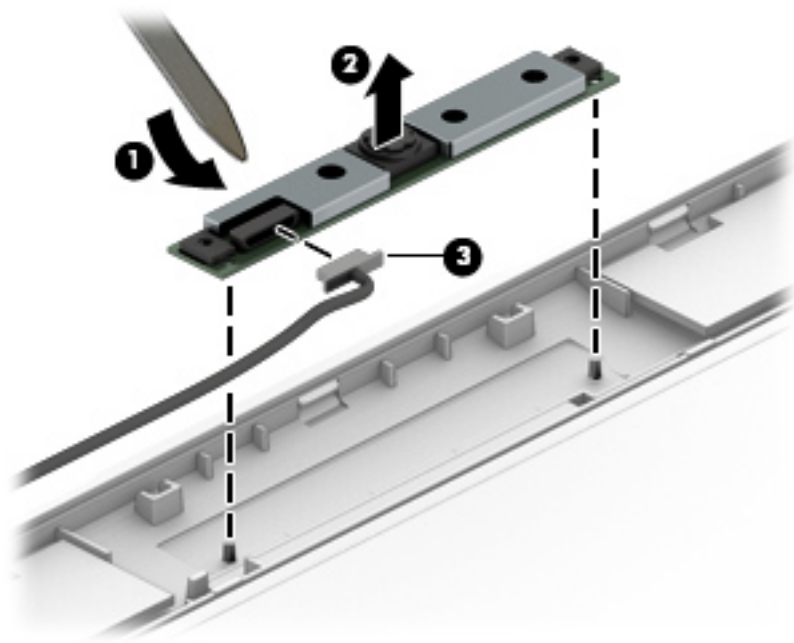

11. If it is necessary to remove the display panel from the enclosure, remove the 4 Phillips M2.0×2.0 screws that secure the panel to the display enclosure.

The raw display panel is available using spare part number 804085-004 for HD panels and 832199-006 for FHD panels.

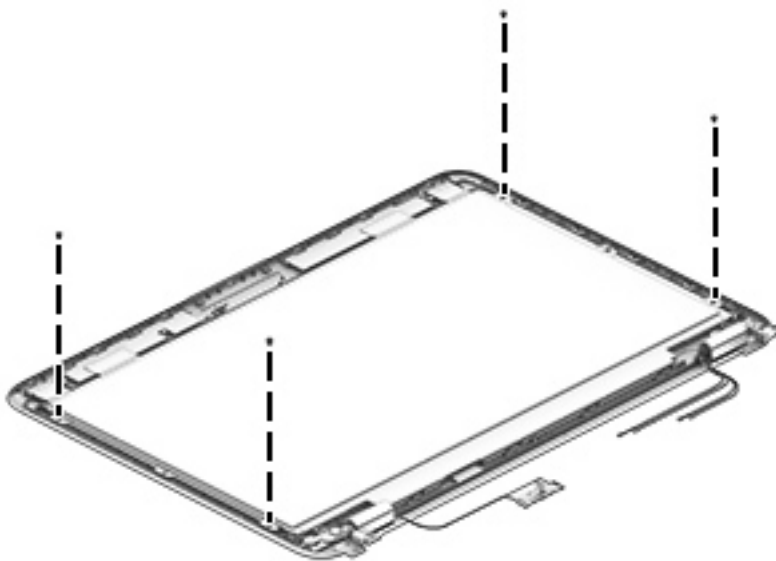

12. Rotate the display panel all the way over **(1)**, and then disconnect the display cable from the rear of the panel **(2)**.

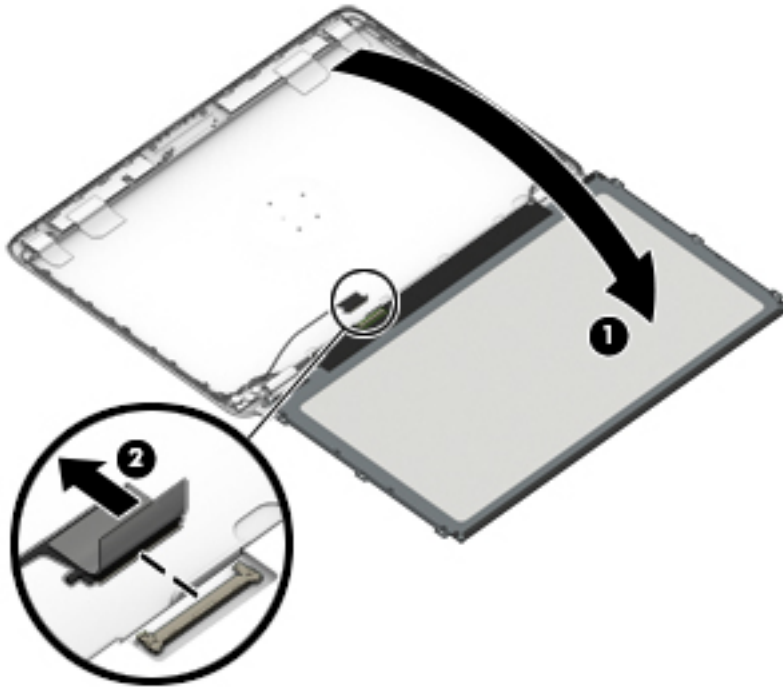

13. If it is necessary to replace the display hinge covers or display hinges, remove the Phillips broadhead M2.0×2.0 screw **(1)** that secures the hinge covers to the display enclosure, and then remove the hinge covers **(2)**.

14. Remove the 6 Phillips broadhead M2.0x2.0 screws **(3)** that secure the hinges to the display enclosure, and then remove the display hinges from the display enclosure **(4)**.

Display hinges are available in the Display Hinge Kit using spare part number 821674-001.

Display hinge covers are available in the Plastics Kit using spare part number 821675-001.

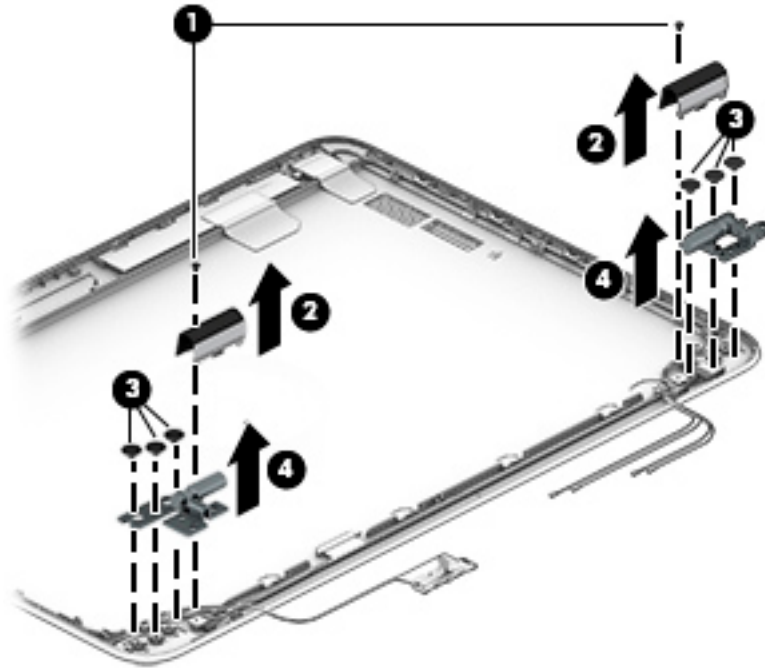

15. If it is necessary to replace the display/webcam cable, remove the display/webcam cable assembly from the routing **(1)** and then lift it from the display enclosure **(2)**.

The display cable is available in the Cable Kit using spare part number 912091-001.

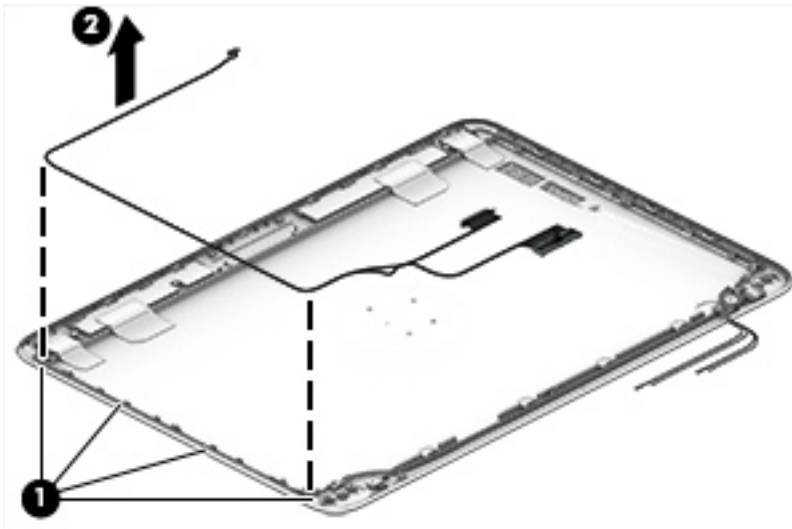



16. If it is necessary to replace the WLAN antennas, peel the transceivers off the top of the display enclosure (1), and then remove the antennas from the routing paths on the side of the display enclosure (2).

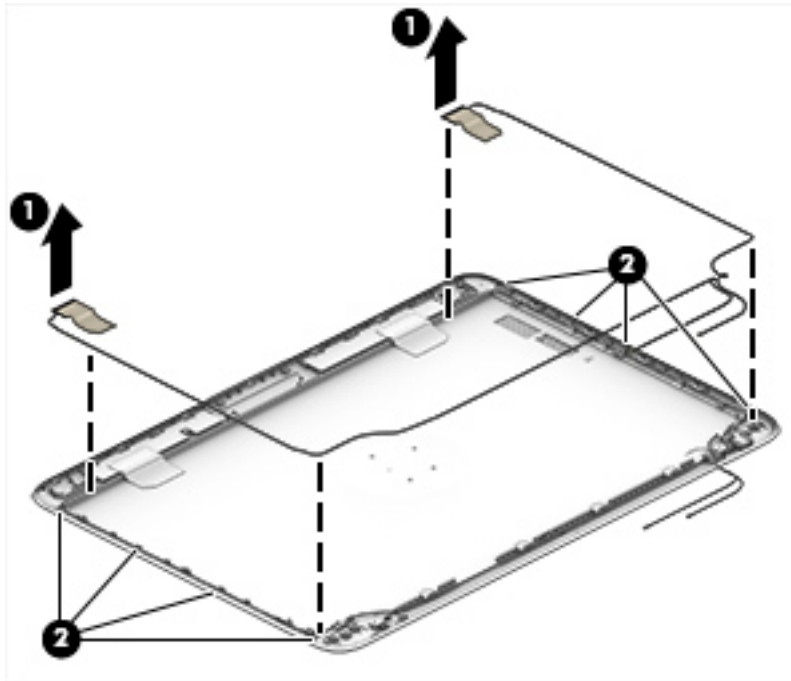

The WLAN antennas are spared with the display enclosure.

17. If it is necessary to replace the WWAN antennas, peel the transceivers off the top of the display enclosure (1), and then remove the antennas from the routing paths on the side of the display enclosure (2).

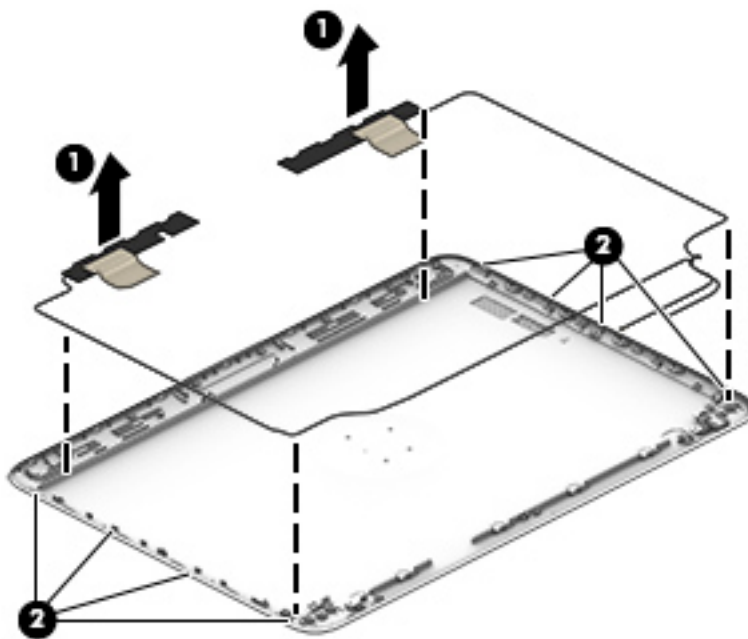

The WWAN antennas are spared with the display enclosure.

Reverse this procedure to reassemble and install the display assembly.

## Heat sink/fan assembly

 **NOTE:** The heat sink/fan assembly spare part kit includes replacement thermal material.

Description	Spare part number
Heat sink/thermal module with fans	821691-001

Before removing the heat sink/fan assembly, follow these steps:

1. Turn off the computer. If you are unsure whether the computer is off or in Hibernation, turn the computer on, and then shut it down through the operating system.
2. Disconnect the power from the computer by unplugging the power cord from the computer.
3. Disconnect all external devices from the computer.
4. Remove the bottom cover (see [Bottom cover on page 30](#)).
5. Remove the battery (see [Battery on page 35](#)).

Remove the heat sink/fan assembly:

- ▲ Disconnect the fan cable (1), loosen the six captive screws on the fan and heat sink following the sequence stamped on the fan and heat sink (2), and then remove the heat sink/fan assembly from the system board (3).

 **CAUTION:** Take extreme care when removing the heat sink and fan assembly. The heatpipe is very fragile and can be easily damaged and bent during removal.

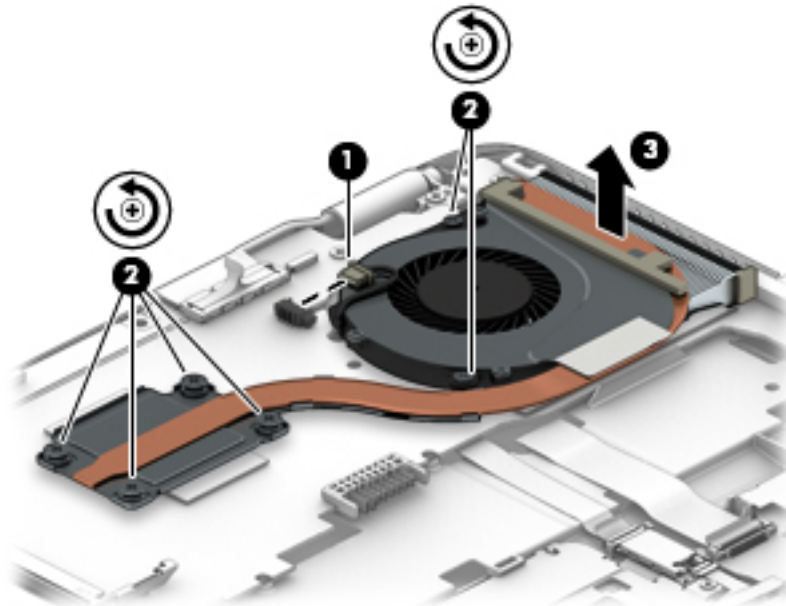

 **NOTE:** The thermal material must be thoroughly cleaned from the surfaces of the heat sink and the system board components each time the heat sink is removed. Replacement thermal material is included with the heat sink, processor, and system board spare part kits.

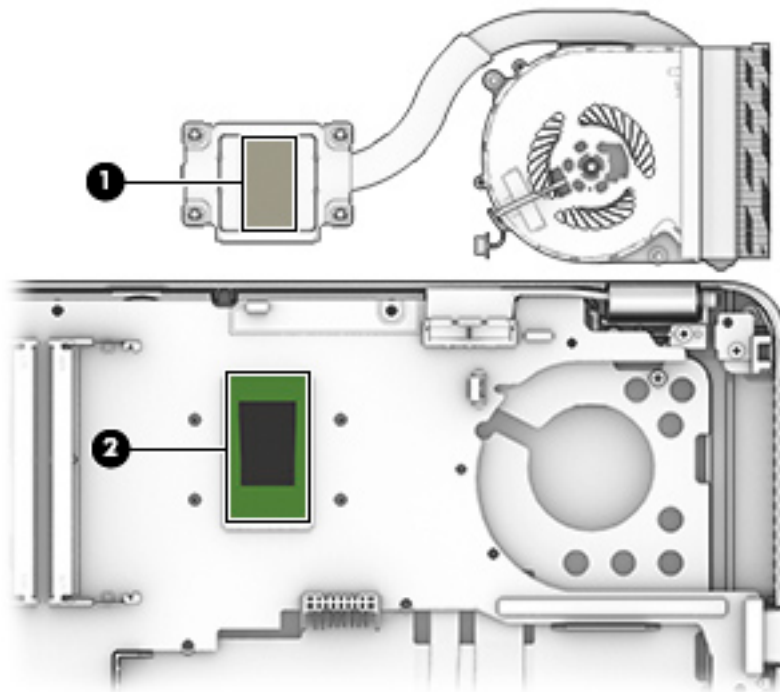

Reverse this procedure to install the heat sink/fan assembly.

## Smart card reader board

Description	Spare part number
Smart card reader board (includes cable)	914963-001

Before removing the card reader board, follow these steps:

1. Shut down the computer. If you are unsure whether the computer is off or in Hibernation, turn the computer on, and then shut it down through the operating system.
2. Disconnect all external devices connected to the computer.
3. Disconnect the power from the computer by first unplugging the power cord from the AC outlet, and then unplugging the AC adapter from the computer.
4. Remove the bottom cover (see [Bottom cover on page 30](#)).
5. Remove the battery (see [Battery on page 35](#)).

Remove the smart card reader board:



**NOTE:** Make sure nothing is installed in the card reader before removing it.

1. Disconnect the cable from the smart card reader board **(1)**.
2. Disconnect the touchpad cable from the smart card reader board **(2)**.
3. Remove the 3 Phillips M2.0x2.0 screws that secure the bracket to the top cover **(3)**, and then remove the bracket from atop the card reader board **(4)**.
4. Lift the smart card reader board from the computer **(5)**.

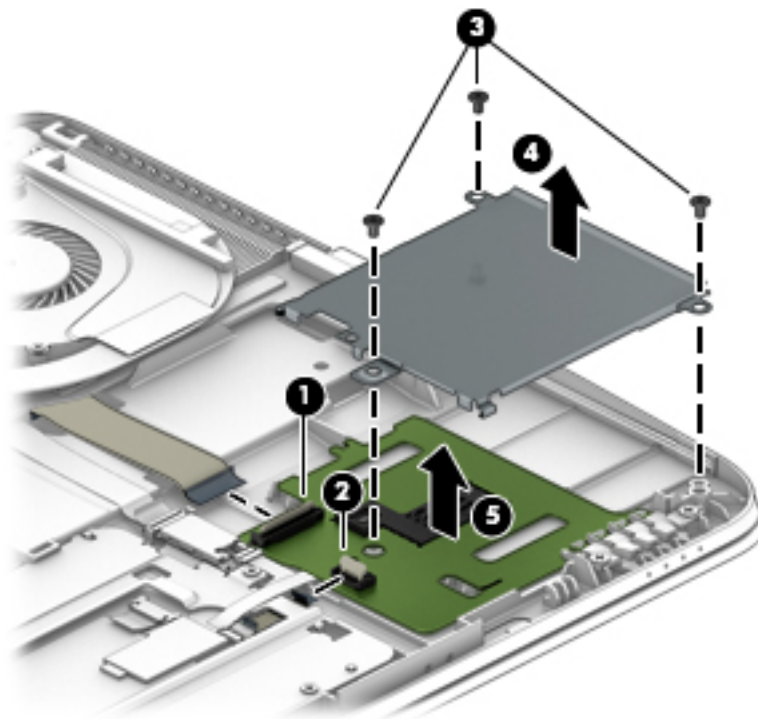

Reverse this procedure to install the smart card reader board.

## Touchpad board

Description	Spare part number
Touchpad board	821668-001
Touchpad board with NFC antenna	821667-001

Before removing the touchpad board, follow these steps:

1. Shut down the computer. If you are unsure whether the computer is off or in Hibernation, turn the computer on, and then shut it down through the operating system.
2. Disconnect all external devices connected to the computer.
3. Disconnect the power from the computer by first unplugging the power cord from the AC outlet, and then unplugging the AC adapter from the computer.
4. Remove the bottom cover (see [Bottom cover on page 30](#)).
5. Remove the battery (see [Battery on page 35](#)).

Remove the touchpad board:

1. Lift the tape **(1)** that secures the touchpad board to the computer.
2. Disconnect the cable from the smart card reader board **(2)**.
3. Disconnect the NFC antenna from the NFC module **(3)**.
4. Remove the 3 Phillips M2.0x2.0 screws **(4)** that secure the touchpad board to the computer.
5. Lift the bottom of the touchpad board up, and then pull it forward to remove it from the computer **(5)**.

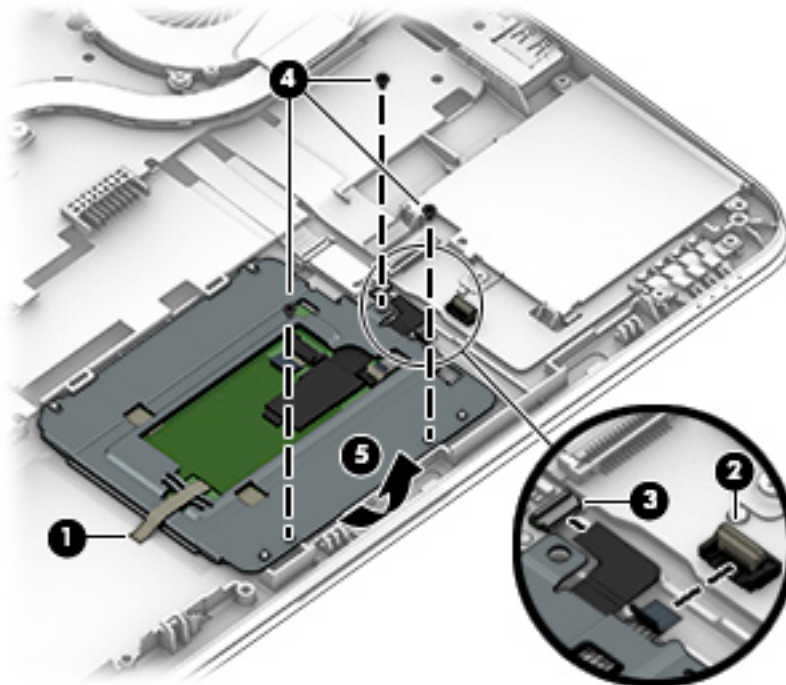

Reverse this procedure to install the touchpad board.

## NFC module

Description	Spare part number
NFC (Near Field Communication) module (includes NFC cable and NFC antenna)	821666-001
NFC cable (included in the Cable Kit)	912091-001 (Cable Kit)

Before removing the NFC module, follow these steps:

1. Turn off the computer. If you are unsure whether the computer is off or in Hibernation, turn the computer on, and then shut it down through the operating system.
2. Disconnect the power from the computer by unplugging the power cord from the computer.
3. Disconnect all external devices from the computer.
4. Remove the bottom cover (see [Bottom cover on page 30](#)).
5. Remove the battery (see [Battery on page 35](#)).
6. Remove the touchpad (see [Touchpad board on page 59](#)).

Remove the NFC module:

1. Disconnect the cable from the top of the NFC module **(1)**.
2. Lift the module from the computer **(2)**.

 **NOTE:** The NFC antenna is spared with the touchpad.

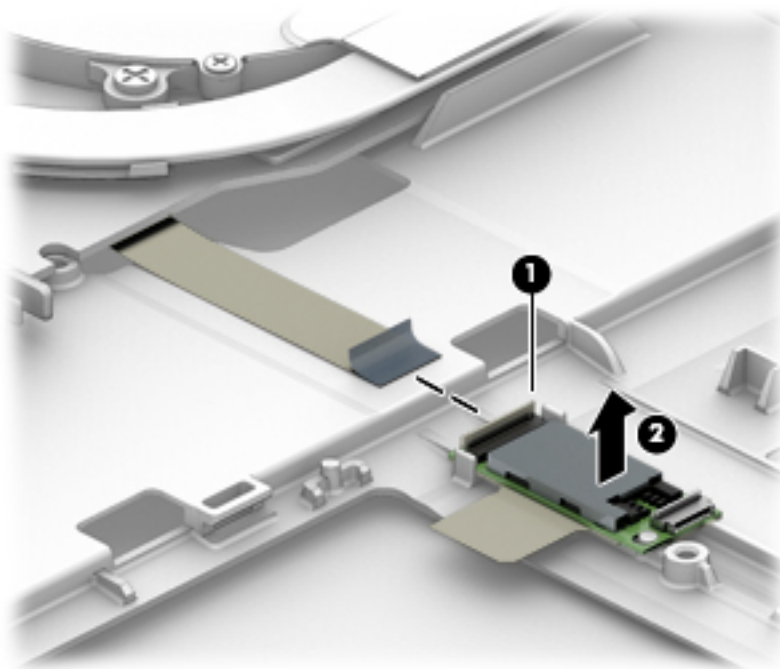

Reverse the removal procedures to install the NFC module.

## System board



**NOTE:** All system board spare part kits include replacement thermal material.

All system boards use the following part numbers:

xxxxxx-001: Non-Windows operating systems

xxxxxx-601: Windows operating system

Description	Spare part number
System board, includes Intel i7-7600U	914274-xxx
System board, includes Intel i7-7500U	914273-xxx
System board, includes Intel i5-7300U	914272-xxx
System board, includes Intel i5-7200U	914271-xxx
System board, includes Intel i3-7100U	914270-xxx

Before removing the system board, follow these steps:

1. Shut down the computer. If you are unsure whether the computer is off or in Hibernation, turn the computer on, and then shut it down through the operating system.
2. Disconnect all external devices connected to the computer.
3. Disconnect the power from the computer by first unplugging the power cord from the AC outlet, and then unplugging the AC adapter from the computer.
4. Remove the bottom cover (see [Bottom cover on page 30](#)).
5. Remove the battery (see [Battery on page 35](#)).
6. Remove the following components:
  - a. Keyboard (see [Keyboard on page 46](#))
  - b. Hard drive (see [Hard drive on page 36](#))
  - c. Solid-state drive (see [Solid-state drive on page 38](#))

When replacing the system board, be sure to remove the following components from the defective system board and install on the replacement system board:

- Memory modules (see [Memory modules on page 40](#))
- WLAN/Bluetooth module (see [WLAN/Bluetooth combo card on page 42](#))
- WWAN module (see [WWAN module on page 44](#))
- Heat sink/fan assembly (see [Heat sink/fan assembly on page 56](#))

Remove the system board:

1. Position the computer upright and open.

2. Disconnect the following cables from the system board:

(1) Card reader cable

(2) NFC cable

(3) Fingerprint reader cable

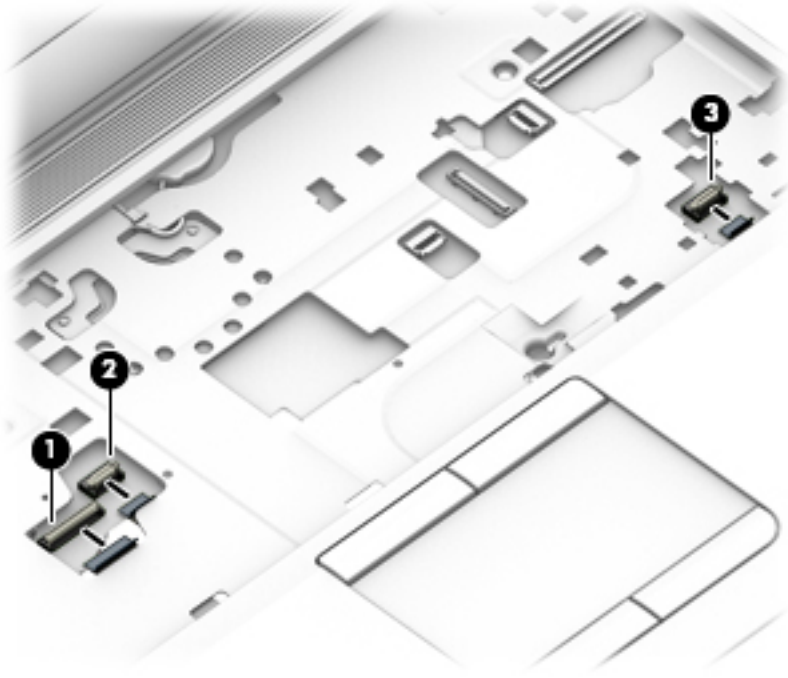

3. Position the computer upside down.



4. Disconnect the following cables from the system board:
  - (1) Speaker cable
  - (2) Speaker cable and antenna cables from clips
  - (3) Display cable

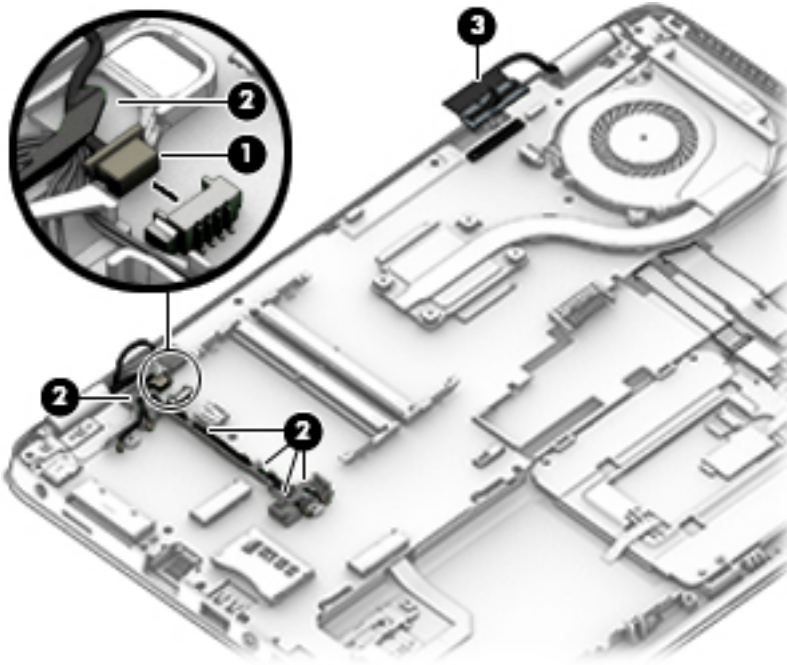

5. Remove the 4 Phillips M2.5×5.0 screws (1) that secure the system board to the computer.
6. Loosen the 2 captive Phillips screws (2) that secure the fan to the computer.
7. Lift the right side of the system board up at an angle (3).

8. Pull the system board up and toward the right to remove it from the computer (4).

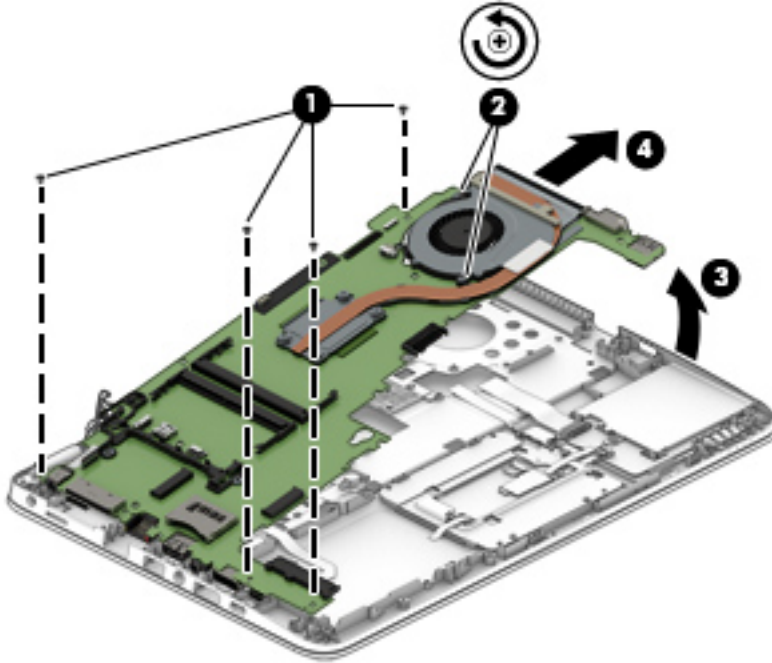

Reverse this procedure to install the system board.

## RTC battery

Description	Spare part number
RTC battery	702853-001

Before removing the RTC battery, follow these steps:

1. Shut down the computer. If you are unsure whether the computer is off or in Hibernation, turn the computer on, and then shut it down through the operating system.
2. Disconnect all external devices connected to the computer.
3. Disconnect the power from the computer by first unplugging the power cord from the AC outlet, and then unplugging the AC adapter from the computer.
4. Remove the bottom cover (see [Bottom cover on page 30](#)).
5. Remove the battery (see [Battery on page 35](#)).
6. Remove the system board (see [System board on page 61](#)).

Remove the RTC battery:

1. Remove the RTC battery cable from the system board **(1)**.
2. Lift the battery up to disengage it from the system board **(2)**.

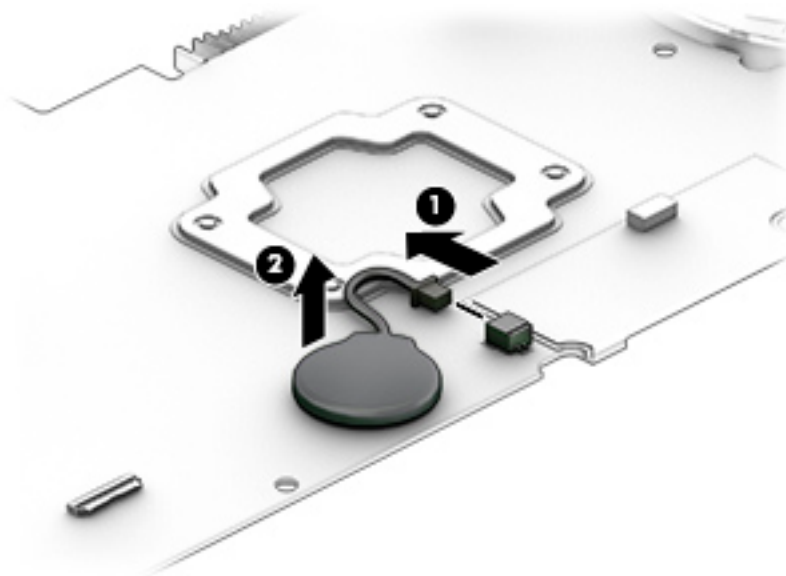

Reverse this procedure to install the RTC battery.

## Fingerprint reader assembly

Description	Spare part number
Fingerprint reader assembly (includes cable)	821693-001
Fingerprint reader bracket	821675-001 (Plastics Kit)

**NOTE:** The fingerprint reader bracket is included in the Plastics Kit.

Before removing the fingerprint reader assembly, follow these steps:

1. Shut down the computer. If you are unsure whether the computer is off or in Hibernation, turn the computer on, and then shut it down through the operating system.
2. Disconnect all external devices connected to the computer.
3. Disconnect the power from the computer by first unplugging the power cord from the AC outlet, and then unplugging the AC adapter from the computer.
4. Remove the bottom cover (see [Bottom cover on page 30](#)).
5. Remove the battery (see [Battery on page 35](#)).
6. Remove the system board (see [System board on page 61](#)).

Remove the fingerprint reader assembly:

1. Remove the Phillips M2.0x2.0 screw **(1)** that secures the bracket to the computer.
2. Lift the bracket off the fingerprint reader board **(2)**.
3. Remove the fingerprint reader board and cable assembly from the computer **(3)**.

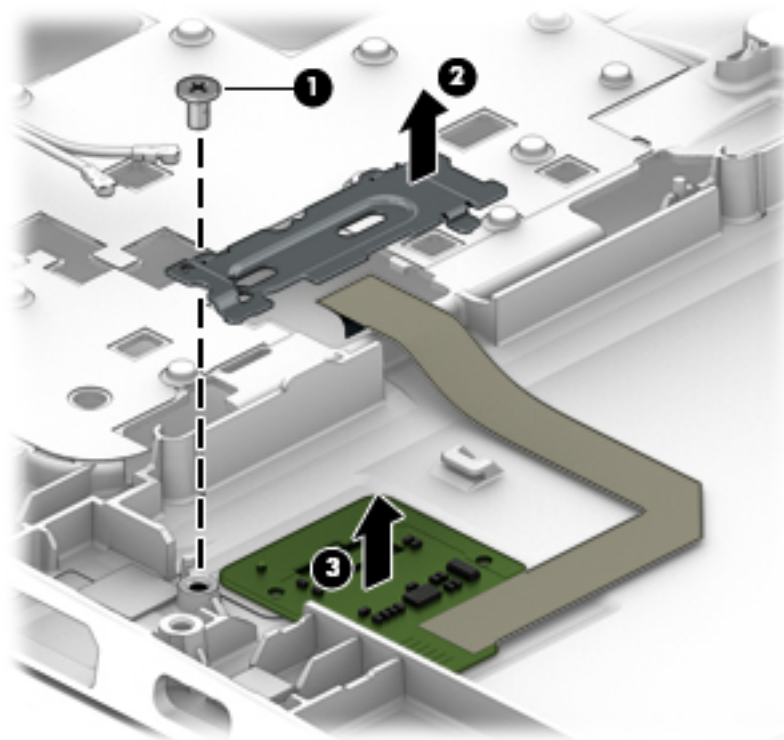

Reverse this procedure to install the fingerprint reader assembly.

## Speaker assembly

Description	Spare part number
Speaker assembly (includes cable)	821684-001

Before removing the speaker assembly, follow these steps:

1. Turn off the computer. If you are unsure whether the computer is off or in Hibernation, turn the computer on, and then shut it down through the operating system.
2. Disconnect the power from the computer by unplugging the power cord from the computer.
3. Disconnect all external devices from the computer.
4. Remove the bottom cover (see [Bottom cover on page 30](#)).
5. Remove the battery (see [Battery on page 35](#)).
6. Remove the system board (see [System board on page 61](#)).

Remove the speaker assembly:

1. Use a tool to pry the middle of the speaker assembly upward to disengage from the adhesive that secures it to the computer **(1)**.
2. Remove the speaker assembly **(2)** from the computer.

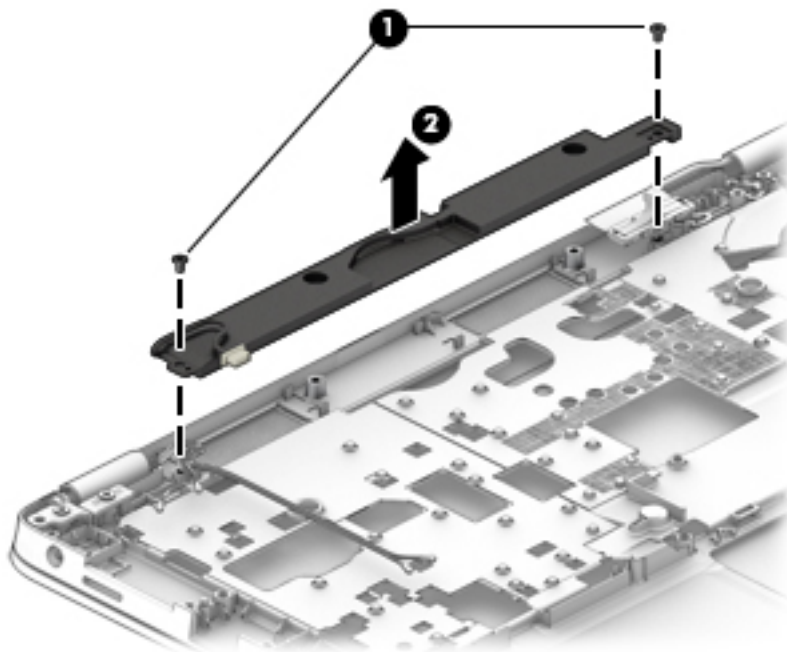

Reverse this procedure to install the speaker assembly.

## Top cover

Description	Spare part number
Top cover	821692-001

The top cover remains after removing all other spared parts from the computer.

# 7 Interpreting system validation diagnostic front panel LEDs and audible codes

During the system validation phase that occurs at system startup, the BIOS validates the functionality of the following subsystems and conditions:

- AC adapter
- System board power
- Processor failure
- BIOS corruption
- Memory failure
- Graphics failure
- System board failure
- BIOS authentication failure

If an error is detected, specific patterns of long and short blinks, accompanied by long and short beeps (where applicable) are used to identify the error. These patterns will make up a two part code:

- Major – the category of the error
- Minor – the specific error within the category

 **NOTE:** Single beep/blink codes are not used.

Number of long beeps/blinks	Error category
1	Not used
2	BIOS
3	Hardware
4	Thermal
5	System board

Patterns of blink/beep codes are determined by using the following parameters:

- 1 second pause occurs after the last major blink.
- 2 second pause occurs after the last minor blink.
- Beep error code sequences occur for the first 5 iterations of the pattern and then stop.
- Blink error code sequences continue until the computer is unplugged or the power button is pressed.

 **NOTE:** Not all diagnostic lights and audible codes are available on all models.

The red LED blinks to represent the major error category (long blinks). The white LED blinks to represent the minor error category (short blinks). For example, '3.5' indicates 3 long red blinks and 5 short white blinks to communicate the processor is not detected.

Component tested	Major/minor code	Error condition	Notebook Caps Lock/Num Lock LED	Desktop	Action
BIOS	2.2	The main area (DXE) of BIOS has become corrupted and there is no recovery binary image available	CAP/NUM Blink = 2	2.2 - Power LED (red.white)	Follow the Crisis Recovery instructions at <a href="http://support.hp.com/us-en/document/c02693833/">http://support.hp.com/us-en/document/c02693833/</a> .
	2.3	The embedded controller policy requires the user to enter a key sequence (SureStart 2.0)	CAP/NUM Blink = 8	2.3 - Power LED (red.white)	If analysis of the event that caused Sure Start recovery is desired, replace the board and send the bad board back. Otherwise, press this key combination to restore BIOS and boot: Up Arrow+ Down Arrow+ Esc.
	2.4	The embedded controller is recovering the boot block or DXE. Since it takes 10 sec. or so to load the DXE image and get video in the DXE case, this blink code is necessary. (SureStart)	Battery LED White and Amber blinking	2.4 - Power LED (red.white)	Wait for DXE recovery to complete.
Hardware	3.2	The embedded controller has timed out waiting for BIOS to return from memory initialization	CAP/NUM Blink = 3	3.2 - Power LED (red.white)	System board replacement.
	3.3	The embedded controller has timed out waiting for BIOS to return from graphics initialization ( 4/13- Graphics adaptor not found)	CAP/NUM Blink = 4	3.3 - Power LED (red.white)	If the system has an MXM module, try a different MXM module. Otherwise, the board most likely needs to be replaced.
	3.4	The system board displays a power failure (crowbar) *	CAP/NUM Blink = 5	3.4 - Power LED (red.white)	System board replacement.
System board	5.2	The embedded controller cannot find valid firmware	CAP/NUM Blink = 7 (2 BB failure) Battery LED Blinking = 1 Hz (3 B failure)	5.2 - Power LED (red.white)	System board replacement.
	5.3	The embedded controller has timed out waiting for the BIOS	CAP/NUM Blink = 1	Not implemented	System board replacement.



---

# 8 Computer Setup (BIOS), TPM, and HP Sure Start

## Using Computer Setup

Computer Setup, or Basic Input/Output System (BIOS), controls communication between all the input and output devices on the system (such as disk drives, display, keyboard, mouse, and printer). Computer Setup includes settings for the types of devices installed, the startup sequence of the computer, and the amount of system and extended memory.

---

 **NOTE:** Use extreme care when making changes in Computer Setup. Errors can prevent the computer from operating properly.

---

## Starting Computer Setup

---

 **NOTE:** An external keyboard or mouse connected to a USB port can be used with Computer Setup only if USB legacy support is enabled.

---

- ▲ Turn on or restart the computer, and when the HP logo appears, press **f10** to enter Computer Setup.

## Navigating and selecting in Computer Setup

- To select a menu or a menu item, use the **tab** key and the keyboard arrow keys and then press **enter**, or use a pointing device to select the item.
- To scroll up and down, select the up arrow or the down arrow in the upper-right corner of the screen, or use the up arrow key or the down arrow key on the keyboard.
- To close open dialog boxes and return to the main Computer Setup screen, press **esc**, and then follow the on-screen instructions.

To exit Computer Setup menus, choose one of the following methods:

- To exit Computer Setup menus without saving your changes:  
Select the **Exit** icon in the lower-right corner of the screen, and then follow the on-screen instructions.  
– or –  
Select **Main**, select **Ignore Changes and Exit**, and then press **enter**.
- To save your changes and exit Computer Setup menus:  
Select the **Save** icon in the lower-right corner of the screen, and then follow the on-screen instructions.  
– or –  
Select **Main**, select **Save Changes and Exit**, and then press **enter**.

Your changes go into effect when the computer restarts.

## Restoring factory settings in Computer Setup

---

 **NOTE:** Restoring defaults will not change the hard drive mode.

---

To return all settings in Computer Setup to the values that were set at the factory, follow these steps:

1. Start Computer Setup. See [Starting Computer Setup on page 71](#).
2. Select **Main**, and then select **Apply Factory Defaults and Exit**.



---

**NOTE:** On select products, the selections may display **Restore Defaults** instead of **Apply Factory Defaults and Exit**.

---

3. Follow the on-screen instructions.
4. To save your changes and exit, select the **Save** icon in the lower-right corner of the screen, and then follow the on-screen instructions.

– or –

Select **Main**, select **Save Changes and Exit**, and then press **enter**.

Your changes go into effect when the computer restarts.



---

**NOTE:** Your password settings and security settings are not changed when you restore the factory settings.

---

## Updating the BIOS

Updated versions of the BIOS may be available on the HP website.

Most BIOS updates on the HP website are packaged in compressed files called *SoftPaqs*.

Some download packages contain a file named *Readme.txt*, which contains information regarding installing and troubleshooting the file.

## Determining the BIOS version

To decide whether you need to update Computer Setup (BIOS), first determine the BIOS version on your computer.

BIOS version information (also known as *ROM date* and *System BIOS*) can be accessed by pressing **fn+esc** (if you are already in Windows) or by using Computer Setup.

1. Start Computer Setup. See [Starting Computer Setup on page 71](#).
2. Select **Main**, and then select **System Information**.
3. To exit Computer Setup without saving your changes, select the **Exit** icon in the lower-right corner of the screen, and then follow the on-screen instructions.

– or –

Select **Main**, select **Ignore Changes and Exit**, and then press **enter**.

To check for later BIOS versions, see [Downloading a BIOS update on page 73](#).

## Downloading a BIOS update

 **CAUTION:** To reduce the risk of damage to the computer or an unsuccessful installation, download and install a BIOS update only when the computer is connected to reliable external power using the AC adapter. Do not download or install a BIOS update while the computer is running on battery power, docked in an optional docking device, or connected to an optional power source. During the download and installation, follow these instructions:

Do not disconnect power on the computer by unplugging the power cord from the AC outlet.

Do not shut down the computer or initiate Sleep.

Do not insert, remove, connect, or disconnect any device, cable, or cord.

1. Type `support` in the taskbar search box, and then select the HP Support Assistant app.  
– or –  
Select the question mark icon in the taskbar.
2. Select **Updates**, and then select **Check for updates and messages**.
3. Follow the on-screen instructions.
4. At the download area, follow these steps:
  - a. Identify the most recent BIOS update and compare it to the BIOS version currently installed on your computer. Make a note of the date, name, or other identifier. You may need this information to locate the update later, after it has been downloaded to your hard drive.
  - b. Follow the on-screen instructions to download your selection to the hard drive.  
  
Make a note of the path to the location on your hard drive where the BIOS update is downloaded. You will need to access this path when you are ready to install the update.

 **NOTE:** If you connect your computer to a network, consult the network administrator before installing any software updates, especially system BIOS updates.

BIOS installation procedures vary. Follow any instructions that are revealed on the screen after the download is complete. If no instructions are revealed, follow these steps:

1. Type `file` in the taskbar search box, and then select **File Explorer**.
2. Select your hard drive designation. The hard drive designation is typically Local Disk (C:).
3. Using the hard drive path you recorded earlier, open the folder that contains the update.
4. Double-click the file that has an `.exe` extension (for example, `filename.exe`).  
  
The BIOS installation begins.
5. Complete the installation by following the on-screen instructions.

 **NOTE:** After a message on the screen reports a successful installation, you can delete the downloaded file from your hard drive.

## Changing the boot order using the f9 prompt

To dynamically choose a boot device for the current startup sequence, follow these steps:

1. Access the Boot Device Options menu:

- Turn on or restart the computer, and when the HP logo appears, press **f9** to enter the Boot Device Options menu.
2. Select a boot device, then press **enter**.

## TPM BIOS settings (select products only)

 **IMPORTANT:** Before enabling Trusted Platform Module (TPM) functionality on this system, you must ensure that your intended use of TPM complies with relevant local laws, regulations and policies, and approvals or licenses must be obtained if applicable. For any compliance issues arising from your operation/usage of TPM which violates the above mentioned requirement, you shall bear all the liabilities wholly and solely. HP will not be responsible for any related liabilities.

TPM provides additional security for your computer. You can modify the TPM settings in Computer Setup (BIOS).

 **NOTE:** If you change the TPM setting to Hidden, TPM is not visible in the operating system.

To access TPM settings in Computer Setup:

1. Start Computer Setup. See [Starting Computer Setup on page 71](#).
2. Select **Security**, select **TPM Embedded Security**, and then follow the on-screen instructions.

## Using HP Sure Start (select products only)

Select computer models are configured with HP Sure Start, a technology that monitors the computer's BIOS for attacks or corruption. If the BIOS becomes corrupted or is attacked, HP Sure Start automatically restores the BIOS to its previously safe state, without user intervention.

HP Sure Start is configured and already enabled so that most users can use the HP Sure Start default configuration. The default configuration can be customized by advanced users.

To access the latest documentation on HP Sure Start, go to <http://www.hp.com/support>. Select **Find your product**, and then follow the on-screen instructions.

# 9 Using HP PC Hardware Diagnostics (UEFI)

HP PC Hardware Diagnostics is a Unified Extensible Firmware Interface (UEFI) that allows you to run diagnostic tests to determine whether the computer hardware is functioning properly. The tool runs outside the operating system so that it can isolate hardware failures from issues that are caused by the operating system or other software components.

When HP PC Hardware Diagnostics (UEFI) detects a failure that requires hardware replacement, a 24-digit Failure ID code is generated. This ID code can then be provided to support to help determine how to correct the problem.

---

 **NOTE:** To start diagnostics on a convertible computer, your computer must be in notebook mode and you must use the keyboard attached.

---

To start HP PC Hardware Diagnostics (UEFI), follow these steps:

1. Turn on or restart the computer, and quickly press **esc**.
2. Press **f2**.

The BIOS searches three places for the diagnostic tools, in the following order:

- a. Connected USB drive

---

 **NOTE:** To download the HP PC Hardware Diagnostics (UEFI) tool to a USB drive, see [Downloading HP PC Hardware Diagnostics \(UEFI\) to a USB device on page 75](#).

---

- b. Hard drive
  - c. BIOS
3. When the diagnostic tool opens, select the type of diagnostic test you want to run, and then follow the on-screen instructions.

---

 **NOTE:** If you need to stop a diagnostic test, press **esc**.

---

## Downloading HP PC Hardware Diagnostics (UEFI) to a USB device

---

 **NOTE:** The HP PC Hardware Diagnostics (UEFI) download instructions are provided in English only, and you must use a Windows computer to download and create the HP UEFI support environment because only .exe files are offered.

---

There are two options to download HP PC Hardware Diagnostics to a USB device.

### Download the latest UEFI version

1. Go to <http://www.hp.com/go/techcenter/pcdiags>. The HP PC Diagnostics home page is displayed.
2. In the HP PC Hardware Diagnostics section, select the **Download** link, and then select **Run**.

### Download any version of UEFI for a specific product

1. Go to <http://www.hp.com/support>.
2. Select **Get software and drivers**.

3. Enter the product name or number.

– or –

Select **Identify now** to let HP automatically detect your product.

4. Select your computer, and then select your operating system.
5. In the **Diagnostic** section, follow the on-screen instructions to select and download the UEFI version you want.

---

# 10 Backup and recovery

This chapter provides information about the following processes. The information in the chapter is standard procedure for most products.

- Creating recovery media and backups
- Restoring and recovering your system

For additional information, refer to the HP support assistant app.

▲ Type `support` in the taskbar search box, and then select the **HP Support Assistant** app.

– or –

Click the question mark icon in the taskbar.

---

 **IMPORTANT:** If you will be performing recovery procedures on a tablet, the tablet battery must be at least 70% charged before you start the recovery process.

**IMPORTANT:** For a tablet with a detachable keyboard, connect the keyboard to the keyboard dock before beginning any recovery process.

---

## Creating recovery media and backups

The following methods of creating recovery media and backups are available on select products only. Choose the available method according to your computer model.

- Use HP Recovery Manager to create HP Recovery media after you successfully set up the computer. This step creates a backup of the HP Recovery partition on the computer. The backup can be used to reinstall the original operating system in cases where the hard drive is corrupted or has been replaced. For information on creating recovery media, see [Creating HP Recovery media \(select products only\) on page 77](#). For information on the recovery options that are available using the recovery media, see [Using Windows tools on page 78](#).
- Use Windows tools to create system restore points and create backups of personal information.

For more information, see [Recovering using HP Recovery Manager on page 79](#).

---

 **NOTE:** If storage is 32 GB or less, Microsoft System Restore is disabled by default.

---

## Creating HP Recovery media (select products only)

If possible, check for the presence of the Recovery partition and the Windows partition. From the **Start** menu, select **File Explorer**, and then select **This PC**.

- If your computer does not list the Windows partition and the Recovery partition, you can obtain recovery media for your system from support. See the *Worldwide Telephone Numbers* booklet included with the computer. You can also find contact information on the HP website. Go to <http://www.hp.com/support>, select your country or region, and follow the on-screen instructions.

You can use Windows tools to create system restore points and create backups of personal information, see [Using Windows tools on page 78](#).

- If your computer does list the Recovery partition and the Windows partition, you can use HP Recovery Manager to create recovery media after you successfully set up the computer. HP Recovery media can be used to perform system recovery if the hard drive becomes corrupted. System recovery reinstalls the original operating system and software programs that were installed at the factory and then configures the settings for the programs. HP Recovery media can also be used to customize the system or restore the factory image if you replace the hard drive.
  - Only one set of recovery media can be created. Handle these recovery tools carefully, and keep them in a safe place.
  - HP Recovery Manager examines the computer and determines the required storage capacity for the media that will be required.
  - To create recovery discs, your computer must have an optical drive with DVD writer capability, and you must use only high-quality blank DVD-R, DVD+R, DVD-R DL, or DVD+R DL discs. Do not use rewritable discs such as CD±RW, DVD±RW, double-layer DVD±RW, or BD-RE (rewritable Blu-ray) discs; they are not compatible with HP Recovery Manager software. Or, instead, you can use a high-quality blank USB flash drive.
  - If your computer does not include an integrated optical drive with DVD writer capability, but you would like to create DVD recovery media, you can use an external optical drive (purchased separately) to create recovery discs. If you use an external optical drive, it must be connected directly to a USB port on the computer; the drive cannot be connected to a USB port on an external device, such as a USB hub. If you cannot create DVD media yourself, you can obtain recovery discs for your computer from HP. See the *Worldwide Telephone Numbers* booklet included with the computer. You can also find contact information on the HP website. Go to <http://www.hp.com/support>, select your country or region, and follow the on-screen instructions.
  - Be sure that the computer is connected to AC power before you begin creating the recovery media.
  - The creation process can take an hour or more. Do not interrupt the creation process.
  - If necessary, you can exit the program before you have finished creating all of the recovery DVDs. HP Recovery Manager will finish burning the current DVD. The next time you start HP Recovery Manager, you will be prompted to continue.

To create HP Recovery media:



---

**IMPORTANT:** For a tablet with a detachable keyboard, connect the keyboard to the keyboard dock before beginning these steps.

---

1. Type `recovery` in the taskbar search box, and then select **HP Recovery Manager**.
2. Select **Create recovery media**, and then follow the on-screen instructions.

If you ever need to recover the system, see [Recovering using HP Recovery Manager on page 79](#).

## Using Windows tools

You can create recovery media, system restore points, and backups of personal information using Windows tools.



---

**NOTE:** If storage is 32 GB or less, Microsoft System Restore is disabled by default.

---

For more information and steps, see the Get started app.

- ▲ Select the **Start** button, and then select the **Get started** app.



# Restore and recovery

There are several options for recovering your system. Choose the method that best matches your situation and level of expertise:

 **IMPORTANT:** Not all methods are available on all products.

- Windows offers several options for restoring from backup, refreshing the computer, and resetting the computer to its original state. For more information see the Get started app.
  - ▲ Select the **Start** button, and then select the **Get started** app.
- If you need to correct a problem with a preinstalled application or driver, use the Reinstall drivers and/or applications option (select products only) of HP Recovery Manager to reinstall the individual application or driver.
  - ▲ Type `recovery` in the taskbar search box, select **HP Recovery Manager**, select **Reinstall drivers and/or applications**, and then follow the on-screen instructions.
- If you want to recover the Windows partition to original factory content, you can choose the System Recovery option from the HP Recovery partition (select products only) or use the HP Recovery media. For more information, see [Recovering using HP Recovery Manager on page 79](#). If you have not already created recovery media, see [Creating HP Recovery media \(select products only\) on page 77](#).
- On select products, if you want to recover the computer's original factory partition and content, or if you have replaced the hard drive, you can use the Factory Reset option of HP Recovery media. For more information, see [Recovering using HP Recovery Manager on page 79](#).
- On select products, if you want to remove the recovery partition to reclaim hard drive space, HP Recovery Manager offers the Remove Recovery Partition option.

For more information, see [Removing the HP Recovery partition \(select products only\) on page 82](#).

## Recovering using HP Recovery Manager

HP Recovery Manager software allows you to recover the computer to its original factory state by using the HP Recovery media that you either created or that you obtained from HP, or by using the HP Recovery partition (select products only). If you have not already created recovery media, see [Creating HP Recovery media \(select products only\) on page 77](#).

### What you need to know before you get started

- HP Recovery Manager recovers only software that was installed at the factory. For software not provided with this computer, you must either download the software from the manufacturer's website or reinstall the software from the media provided by the manufacturer.

 **IMPORTANT:** Recovery through HP Recovery Manager should be used as a final attempt to correct computer issues.

- HP Recovery media must be used if the computer hard drive fails. If you have not already created recovery media, see [Creating HP Recovery media \(select products only\) on page 77](#).
- To use the Factory Reset option (select products only), you must use HP Recovery media. If you have not already created recovery media, see [Creating HP Recovery media \(select products only\) on page 77](#).
- If your computer does not allow the creation of HP Recovery media or if the HP Recovery media does not work, you can obtain recovery media for your system from support. See the *Worldwide Telephone Numbers* booklet included with the computer. You can also find contact information from the HP

website. Go to <http://www.hp.com/support>, select your country or region, and follow the on-screen instructions.

---

 **IMPORTANT:** HP Recovery Manager does not automatically provide backups of your personal data. Before beginning recovery, back up any personal data you want to retain.

---

Using HP Recovery media, you can choose from one of the following recovery options:

---

 **NOTE:** Only the options available for your computer display when you start the recovery process.

---

- System Recovery—Reinstalls the original operating system, and then configures the settings for the programs that were installed at the factory.
- Factory Reset—Restores the computer to its original factory state by deleting all information from the hard drive and re-creating the partitions. Then it reinstalls the operating system and the software that was installed at the factory.

The HP Recovery partition (select products only) allows System Recovery only.

## Using the HP Recovery partition (select products only)

The HP Recovery partition allows you to perform a system recovery without the need for recovery discs or a recovery USB flash drive. This type of recovery can be used only if the hard drive is still working.

To start HP Recovery Manager from the HP Recovery partition:

---

 **IMPORTANT:** For a tablet with a detachable keyboard, connect the keyboard to the keyboard dock before beginning these steps (select products only).

---

1. Type `recovery` in the taskbar search box, select **Recovery Manager**, and then select **HP Recovery Environment**.

- or -

For computers or tablets with keyboards attached, press **f11** while the computer boots, or press and hold **f11** as you press the power button.

For tablets without keyboards:

Turn on or restart the tablet, and then quickly hold down the volume up button; then select **f11**.

- or -

Turn on or restart the tablet, and then quickly hold down the volume down button; then select **f11**.

- or -

Turn on or restart the tablet, and then quickly hold down the Windows button; then select **f11**.

2. Select **Troubleshoot** from the boot options menu.
3. Select **Recovery Manager**, and then follow the on-screen instructions.

## Using HP Recovery media to recover

You can use HP Recovery media to recover the original system. This method can be used if your system does not have an HP Recovery partition or if the hard drive is not working properly.

1. If possible, back up all personal files.
2. Insert the HP Recovery media, and then restart the computer.



---

**NOTE:** If the computer does not automatically restart in HP Recovery Manager, change the computer boot order. See [Changing the computer boot order on page 81](#).

---

3. Follow the on-screen instructions.

## Changing the computer boot order

If your computer does not restart in HP Recovery Manager, you can change the computer boot order, which is the order of devices listed in BIOS where the computer looks for startup information. You can change the selection to an optical drive or a USB flash drive.

To change the boot order:



---

**IMPORTANT:** For a tablet with a detachable keyboard, connect the keyboard to the keyboard dock before beginning these steps.

---

1. Insert the HP Recovery media.
2. Access the system **Startup** menu.

For computers or tablets with keyboards attached:

- ▲ Turn on or restart the computer or tablet, quickly press **esc**, and then press **f9** for boot options.

For tablets without keyboards:

- ▲ Turn on or restart the tablet, and then quickly hold down the volume up button; then select **f9**.

- or -

Turn on or restart the tablet, and then quickly hold down the volume down button; then select **f9**.

- or -

Turn on or restart the tablet, and then quickly hold down the Windows button; then select **f9**.

3. Select the optical drive or USB flash drive from which you want to boot.
4. Follow the on-screen instructions.

## Removing the HP Recovery partition (select products only)

HP Recovery Manager software allows you to remove the HP Recovery partition to free up hard drive space.



**IMPORTANT:** After you remove the HP Recovery partition, you will not be able to perform System Recovery or create HP recovery media from the HP Recovery partition. So before you remove the Recovery partition, create HP Recovery media; see [Creating HP Recovery media \(select products only\) on page 77](#).



**NOTE:** The Remove Recovery Partition option is only available on products that support this function.

Follow these steps to remove the HP Recovery partition:

1. Type `recovery` in the taskbar search box, and then select **HP Recovery Manager**.
2. Select **Remove Recovery Partition**, and then follow the on-screen instructions.

# 11 Specifications

## Input power

The power information in this section may be helpful if you plan to travel internationally with the computer.

The computer operates on DC power, which can be supplied by an AC or a DC power source. The AC power source must be rated at 100–240 V, 50–60 Hz. Although the computer can be powered from a standalone DC power source, it should be powered only with an AC adapter or a DC power source supplied and approved by HP for use with this computer.

The computer can operate on DC power within the following specifications.

Input Power	Rating
Operating voltage and current	19.5 V dc @ 2.31 A – 45 W
	19.5 V dc @ 3.33 A – 65 W

 **NOTE:** This product is designed for IT power systems in Norway with phase-to-phase voltage not exceeding 240 V rms.

 **NOTE:** The computer operating voltage and current can be found on the system regulatory label.

## Operating environment

Factor	Metric	U.S.
<b>Temperature</b>		
Operating (writing to optical disc)	<b>5°C to 35°C</b>	41°F to 95°F
Nonoperating	<b>-20°C to 60°C</b>	-4°F to 140°F
<b>Relative humidity</b> (noncondensing)		
Operating	<b>10% to 90%</b>	10% to 90%
Nonoperating	<b>5% to 95%</b>	5% to 95%
<b>Maximum altitude</b> (unpressurized)		
Operating	<b>-15 m to 3,048 m</b>	-50 ft to 10,000 ft
Nonoperating	<b>-15 m to 12,192 m</b>	-50 ft to 40,000 ft

# 12 Power cord set requirements

The wide-range input feature of the computer permits it to operate from any line voltage from 100 to 120 volts AC, or from 220 to 240 volts AC.

The 3-conductor power cord set included with the computer meets the requirements for use in the country or region where the equipment is purchased.

Power cord sets for use in other countries and regions must meet the requirements of the country or region where the computer is used.

## Requirements for all countries

The following requirements are applicable to all countries and regions:

- The length of the power cord set must be at least **1.0 m** (3.3 ft) and no more than **2.0 m** (6.5 ft).
- All power cord sets must be approved by an acceptable accredited agency responsible for evaluation in the country or region where the power cord set will be used.
- The power cord sets must have a minimum current capacity of 10 amps and a nominal voltage rating of 125 or 250 V AC, as required by the power system of each country or region.
- The appliance coupler must meet the mechanical configuration of an EN 60 320/IEC 320 Standard Sheet C13 connector for mating with the appliance inlet on the back of the computer.

## Requirements for specific countries and regions

Country/region	Accredited agency	Applicable note number
Australia	EANSW	1
Austria	OVE	1
Belgium	CEBC	1
Canada	CSA	2
Denmark	DEMKO	1
Finland	FIMKO	1
France	UTE	1
Germany	VDE	1
Italy	IMQ	1
Japan	METI	3
The Netherlands	KEMA	1
Norway	NEMKO	1
The People's Republic of China	COC	5
South Korea	EK	4

Country/region	Accredited agency	Applicable note number
Sweden	SEMKO	1
Switzerland	SEV	1
Taiwan	BSMI	4
The United Kingdom	BSI	1
The United States	UL	2

1. The flexible cord must be Type H05VV-F, 3-conductor, 1.0-mm<sup>2</sup> conductor size. Power cord set fittings (appliance coupler and wall plug) must bear the certification mark of the agency responsible for evaluation in the country or region where it will be used.
2. The flexible cord must be Type SPT-3 or equivalent, No. 18 AWG, 3-conductor. The wall plug must be a two-pole grounding type with a NEMA 5-15P (15 A, 125 V) or NEMA 6-15P (15 A, 250 V) configuration.
3. The appliance coupler, flexible cord, and wall plug must bear a “T” mark and registration number in accordance with the Japanese Dentori Law. The flexible cord must be Type VCT or VCTF, 3-conductor, 1.00-mm<sup>2</sup> conductor size. The wall plug must be a two-pole grounding type with a Japanese Industrial Standard C8303 (7 A, 125 V) configuration.
4. The flexible cord must be Type RVV, 3-conductor, 0.75-mm<sup>2</sup> conductor size. Power cord set fittings (appliance coupler and wall plug) must bear the certification mark of the agency responsible for evaluation in the country or region where it will be used.
5. The flexible cord must be Type VCTF, 3-conductor, 0.75-mm<sup>2</sup> conductor size. Power cord set fittings (appliance coupler and wall plug) must bear the certification mark of the agency responsible for evaluation in the country or region where it will be used.

# 13 Statement of memory volatility

The purpose of this chapter is to provide general information regarding nonvolatile memory in HP Business PCs. This chapter also provides general instructions for restoring nonvolatile memory that can contain personal data after the system has been powered off and the hard drive has been removed.

HP Business PC products that use Intel®-based or AMD®-based system boards contain volatile DDR memory. The amount of nonvolatile memory present in the system depends upon the system configuration. Intel-based and AMD-based system boards contain nonvolatile memory subcomponents as originally shipped from HP, assuming that no subsequent modifications have been made to the system and assuming that no applications, features, or functionality have been added to or installed on the system.

Following system shutdown and removal of all power sources from an HP Business PC system, personal data can remain on volatile system memory (DIMMs) for a finite period of time and will also remain in nonvolatile memory. Use the steps below to remove personal data from the PC, including the nonvolatile memory found in Intel-based and AMD-based system boards.

1. Follow steps (a) through (j) below to restore the nonvolatile memory that can contain personal data. Restoring or reprogramming nonvolatile memory that does not store personal data is neither necessary nor recommended.

- a. Turn on or restart the computer, and then press **esc** while the “Press the ESC key for Startup Menu” message is displayed at the bottom of the screen.



**NOTE:** If the system has a BIOS administrator password, enter the password at the prompt.

- b. Select **Main**, select **Restore Defaults**, and then select **Yes** to load defaults.
- c. Select the **Security** menu, select **Restore Security Level Defaults**, and then select **Yes** to restore security level defaults.
- d. If an asset or ownership tag is set, select the **Security** menu and scroll down to the **Utilities** menu. Select **System IDs**, and then select **Asset Tracking Number**. Clear the tag, and then make the selection to return to the prior menu.
- e. If a DriveLock password is set, select the **Security** menu, and scroll down to **Hard Drive Tools** under the **Utilities** menu. Select **Hard Drive Tools**, select **DriveLock**, then uncheck the checkbox for **DriveLock password on restart**. Select **OK** to proceed.
- f. If an Automatic DriveLock password is set, select the **Security** menu, scroll down to **Hard Drive Tools** under the **Utilities** menu. Select **Hard Drive Tools**, scroll down to **Automatic DriveLock**, then select the desired hard drive and disable protection. At the automatic drive lock warning screen, select **Yes** to continue. Repeat this procedure if more than one hard drive has an Automatic DriveLock password.
- g. Select the **Main** menu, and then select **Reset BIOS Security to factory default**. Click **Yes** at the warning message.
- h. Select the **Main** menu, select **Save Changes and Exit**, select **Yes** to save changes and exit, and then select **Shutdown**.



- i. Reboot the system. If the system has a Trusted Platform Module (TPM) and/or fingerprint reader, one or two prompts will appear—one to clear the TPM and the other to Reset Fingerprint Sensor; press or tap **F1** to accept or **F2** to reject.
  - j. Remove all power and system batteries for at least 24 hours.
2. Complete one of the following:
- Remove and retain the storage drive.
  - or –
  - Clear the drive contents by using a third party utility designed to erase data from an SSD.
  - or –
  - Clear the contents of the drive by using the following BIOS Setup Secure Erase command option steps:

---

 **IMPORTANT:** If you clear data using Secure Erase, it cannot be recovered.

---

- a. Turn on or restart the computer, and then press **esc** while the “Press the ESC key for Startup Menu” message is displayed at the bottom of the screen.
  - b. Select the **Security** menu and scroll down to the **Utilities** menu.
  - c. Select **Hard Drive Tools**.
  - d. Under **Utilities**, select **Secure Erase**, select the hard drive storing the data you want to clear, and then follow the on-screen instructions to continue.
- or –
- Clear the contents of the drive by using the following Disk Sanitizer command steps:

---

 **IMPORTANT:** If you clear data using Disk Sanitizer, it cannot be recovered.

---

 **NOTE:** The amount of time it takes for Disk Sanitizer to run can take several hours. Plug the computer into an AC outlet before starting.

---

- a. Turn on or restart the computer, and then press **esc** while the “Press the ESC key for Startup Menu” message is displayed at the bottom of the screen.
- b. Select the **Security** menu and scroll down to the **Utilities** menu.
- c. Select **Hard Drive Tools**.
- d. Under **Utilities**, select **Disk Sanitizer**, select the hard drive storing the data you want to clear, and then follow the on-screen instructions to continue.

## Nonvolatile memory usage

Nonvolatile Memory Type	Amount (Size)	Does this memory store customer data?	Does this memory retain data when power is removed?	What is the purpose of this memory?	How is data input into this memory?	How is this memory write-protected?
HP Sure Start flash (select models only)	2 MBytes	No	Yes	Provides protected backup of critical System BIOS code, EC firmware, and critical PC configuration data for select platforms that support HP Sure Start.  For more information, see <a href="#">Using HP Sure Start (select models only) on page 91</a> .	Data cannot be written to this device via the host processor. The content is managed solely by the HP Sure Start Embedded Controller.	This memory is protected by the HP Sure Start Embedded Controller.
Real Time Clock (RTC) battery backed-up CMOS configuration memory	256 Bytes	No	Yes	Stores system date and time and noncritical data.	RTC battery backed-up CMOS is programmed using the Computer Setup (BIOS), or changing the Microsoft Windows date & time.	This memory is not write-protected.
Controller (NIC) EEPROM	64 KBytes (not customer accessible)	No	Yes	Stores NIC configuration and NIC firmware.	NIC EEPROM is programmed using a utility from the NIC vendor that can be run from DOS.	A utility is required to write data to this memory and is available from the NIC vendor. Writing data to this ROM in an inappropriate manner will render the NIC non-functional.
DIMM Serial Presence Detect (SPD) configuration data	256 Bytes per memory module, 128 Bytes programmable (not customer accessible)	No	Yes	Stores memory module information.	DIMM SPD is programmed by the memory vendor.	Data cannot be written to this memory when the module is installed in a PC. The specific write-protection method varies by memory vendor.
System BIOS	4 MBytes to 5 MBytes	Yes	Yes	Stores system BIOS code and PC configuration data.	System BIOS code is programmed at the factory. Code is updated when the system BIOS is updated. Configuration data and settings are input using the Computer Setup (BIOS) or a custom utility.	<b>NOTE:</b> Writing data to this ROM in an inappropriate manner can render the PC non-functional.  A utility is required for writing data to this memory and is available on the HP website; go to <a href="http://www.hp.com/support">http://www.hp.com/support</a> , and select your country. Select <b>Drivers &amp;</b>

Nonvolatile Memory Type	Amount (Size)	Does this memory store customer data?	Does this memory retain data when power is removed?	What is the purpose of this memory?	How is data input into this memory?	How is this memory write-protected?
Intel Management Engine Firmware (present in only specific ZBook and EliteBook models. For more information, go to <a href="http://www.hp.com/support">http://www.hp.com/support</a> , and select your country. Select <b>Drivers &amp; Downloads</b> , and then follow the on-screen instructions.)	1.5 MBytes or 5 MBytes	Yes	Yes	Stores Management Engine Code, Settings, Provisioning Data and iAMT third-party data store.	Management Engine Code is programmed at the factory. Code is updated via Intel secure firmware update utility. Unique Provisioning Data can be entered at the factory or by an administrator using the Management Engine (MEBx) setup utility. The third party data store contents can be populated by a remote management console or local applications that have been registered by an administrator to have access to the space.	<b>Downloads</b> , and then follow the on-screen instructions.  The Intel chipset is configured to enforce hardware protection to block all direct read/write access to this area. An Intel utility is required for updating the firmware. Only firmware updates digitally signed by Intel can be applied using this utility.
Bluetooth flash	2 Mbit	No	Yes	Stores Bluetooth configuration and firmware.	Bluetooth flash is programmed at the factory. Tools for writing data to this memory are not publicly available but can be obtained from the silicon vendor.	A utility is required for writing data to this memory and is made available through newer versions of the driver whenever the flash requires an upgrade.
802.11 WLAN EEPROM	4 Kbit to 8 Kbit	No	Yes	Stores configuration and calibration data.	802.11 WLAN EEPROM is programmed at the factory. Tools for writing data to this memory are not made public.	A utility is required for writing data to this memory and is typically not made available to the public unless a firmware upgrade is necessary to address a unique issue.
Web camera	64 Kbit	No	Yes	Stores webcam configuration and firmware.	Webcam memory is programmed using a utility from the device manufacturer that can be run from Windows.	A utility is required for writing data to this memory and is typically not made available to the public unless a firmware upgrade is necessary to address a unique issue.
Fingerprint reader	512 KByte flash	Yes	Yes	Stores fingerprint templates.	Fingerprint reader memory is programmed by user enrollment in HP ProtectTools Security Manager.	Only a digitally signed application can make the call to write to the flash.

## Questions and answers

### 1. How can the BIOS settings be restored (returned to factory settings)?



**IMPORTANT:** Restore defaults does not securely erase any data on your hard drive. See question and answer 6 for steps to securely erase data.

Restore defaults does not reset the Custom Secure Boot keys. See question and answer 7 for information about resetting the keys.

- a. Turn on or restart the computer, and then press **esc** while the “Press the ESC key for Startup Menu” message is displayed at the bottom of the screen.
- b. Select **Main**, and then select **Restore defaults**.
- c. Follow the on-screen instructions.
- d. Select **Main**, select **Save Changes and Exit**, and then follow the on-screen instructions.

### 2. What is a UEFI BIOS, and how is it different from a legacy BIOS?

The Unified Extensible Firmware Interface (UEFI) BIOS is an industry-standard software interface between the platform firmware and an operating system (OS). It is a replacement for the older BIOS architecture, but supports much of the legacy BIOS functionality.

Like the legacy BIOS, the UEFI BIOS provides an interface to display the system information and configuration settings and to change the configuration of your computer before an OS is loaded. BIOS provides a secure run-time environment that supports a Graphic User Interface (GUI). In this environment, you can use either a pointing device (Touchscreen, TouchPad, pointing stick, or USB mouse) or the keyboard to navigate and make menu and configuration selections. The UEFI BIOS also contains basic system diagnostics.

The UEFI BIOS provides functionality beyond that of the legacy BIOS. In addition, the UEFI BIOS works to initialize the computer’s hardware before loading and executing the OS; the run-time environment allows the loading and execution of software programs from storage devices to provide more functionality, such as advanced hardware diagnostics (with the ability to display more detailed system information) and advanced firmware management and recovery software.

HP has provided options in Computer Setup (BIOS) to allow you to run in legacy BIOS, if required by the operating system. Examples of this requirement would be if you upgrade or downgrade the OS.

### 3. Where does the UEFI BIOS reside?

The UEFI BIOS resides on a flash memory chip. A utility is required to write to the chip.

### 4. What kind of configuration data is stored on the DIMM Serial Presence Detect (SPD) memory module? How would this data be written?

The DIMM SPD memory contains information about the memory module, such as size, serial number, data width, speed/timing, voltage, and thermal information. This information is written by the module manufacturer and stored on an EEPROM. This EEPROM cannot be written to when the memory module is installed in a PC. Third-party tools do exist that can write to the EEPROM when the memory module is not installed in a PC. Various third-party tools are available to read SPD memory.

### 5. What is meant by “Restore the nonvolatile memory found in Intel-based system boards”?

This message relates to clearing the Real Time Clock (RTC) CMOS memory that contains PC configuration data.

### 6. How can the BIOS security be reset to factory defaults and data erased?

---

 **IMPORTANT:** Resetting will result in the loss of information.

These steps will not reset Custom Secure Boot Keys. See question and answer 7 for information about resetting the keys.

---

- a. Turn on or restart the computer, and then press **esc** while the “Press the ESC key for Startup Menu” message is displayed at the bottom of the screen.
- b. Select **Main**, and then select **Reset BIOS Security to Factory Default**.
- c. Follow the on-screen instructions.
- d. Select **Main**, select **Save Changes and Exit**, and then follow the on-screen instructions.

#### 7. How can the Custom Secure Boot Keys be reset?

Secure Boot is a feature to ensure that only authenticated code can start on a platform. If you enabled Secure Boot and created Custom Secure Boot Keys, simply disabling Secure Boot will not clear the keys. You must also select to clear the Custom Secure Boot Keys. Use the same Secure Boot access procedure you used to create the Custom Secure Boot Keys, but make the selection to clear or delete all Secure Boot Keys.

- a. Turn on or restart the computer, and then press **esc** while the “Press the ESC key for Startup Menu” message is displayed at the bottom of the screen.
- b. Select the **Security** menu, select **Secure Boot Configuration**, and then follow the on-screen instructions.
- c. At the **Secure Boot Configuration** window, select **Secure Boot**, select **Clear Secure Boot Keys**, and then follow the on-screen instructions to continue.

## Using HP Sure Start (select models only)

Select computer models are configured with HP Sure Start, a technology that continuously monitors your computer's BIOS for attacks or corruption. If the BIOS becomes corrupted or is attacked, HP Sure Start restores the BIOS to its previously safe state, without user intervention. Those select computer models ship with HP Sure Start configured and enabled. HP Sure Start is configured and already enabled so that most users can use the HP Sure Start default configuration. The default configuration can be customized by advanced users.

To access the latest documentation on HP Sure Start, go to <http://www.hp.com/support>, and select your country. Select **Drivers & Downloads**, and then follow the on-screen instructions.

---

# 14 Recycling

When a non-rechargeable or rechargeable battery has reached the end of its useful life, do not dispose of the battery in general household waste. Follow the local laws and regulations in your area for battery disposal.

HP encourages customers to recycle used electronic hardware, HP original print cartridges, and rechargeable batteries. For more information about recycling programs, see the HP Web site at <http://www.hp.com/recycle>.

# Index

## A

AC adapter, spare part numbers 23  
adapter  
    spare part numbers 23  
antennas  
    disconnecting 42, 44  
audible codes 69  
audio, product description 2  
audio-out (headphone)/audio-in  
    (microphone) combo jack,  
    identifying 5

## B

backups 77  
battery  
    removal 35  
    spare part number 17, 35  
battery light 14  
beep codes 69  
bezel  
    spare part number 19  
BIOS  
    determining version 72  
    downloading an update 73  
    updating 72  
Bluetooth card  
    spare part number 42  
Bluetooth label 15  
boot order  
    changing 81  
bottom 15  
bottom cover  
    removal 30  
    spare part number 18, 30  
buttons  
    left pointing stick 8  
    left TouchPad 8  
    power 10  
    right pointing stick 8  
    right TouchPad 8

## C

cable lock docking station, spare part  
    number 23  
cable lock, spare part number 23

caps lock light, identifying 9  
case  
    spare part numbers 23  
chipset, product description 1  
components  
    bottom 13  
    display 7  
    front 14  
    left side 6  
    right side 5  
    top 8  
computer major components 16  
Computer Setup  
    navigating and selecting 71  
    restoring factory settings 71  
connector, power 6

## D

display assembly  
    removal 50  
    spare part numbers 50  
    subcomponents 19  
display bezel  
    removal 51  
display cable  
    spare part number 19  
display enclosure  
    spare part number 19  
display image, switching 12  
display panel  
    product description 1  
    removal 52  
docking connector, identifying 6, 13  
drive light 14  
Dual-Mode DisplayPort  
    identifying 5

## E

embedded numeric keypad,  
    identifying 11  
error  
    codes 69  
esc key, identifying 11  
ethernet, product description 2  
external monitor port 6

## F

fingerprint reader assembly  
    removal 66  
    spare part number 66  
fingerprint reader board  
    spare part number 18  
fingerprint reader, identifying 10  
flashing LEDs 69  
fn key, identifying 11  
function keys  
    identifying 11

## G

graphics  
    product description 1

## H

hard drive  
    product description 1  
    removing 36  
    spare part numbers 22, 36  
Hard Drive Hardware Kit  
    spare part number 22  
heat sink  
    removal 56  
    spare part numbers 56  
heat sink/fan assembly  
    spare part number 18  
hinges  
    spare part number 19  
hot keys  
    microphone mute 12  
    Sleep 12  
    switching screen image 12  
    using 12  
HP PC Hardware Diagnostics (UEFI)  
    using 75  
HP Recovery Manager  
    correcting boot problems 81  
    starting 80  
HP Recovery media  
    creating 77  
    recovery 80

HP Recovery partition  
  recovery 80  
  removing 82  
HP Sure Start 91

**I**  
input power 83  
integrated webcam light,  
  identifying 7  
internal microphones, identifying 7

**J**  
jacks  
  audio-out (headphone)/audio-in  
  (microphone) combo 5  
  network 6  
  RJ-45 (network) 6

**K**  
keyboard  
  product description 3  
  removal 46  
  spare part number 17  
  spare part numbers 46  
keypad  
  embedded numeric 11  
keys  
  esc 11  
  fn 11  
  function 11  
  Windows key 11

**L**  
labels  
  Bluetooth 15  
  regulatory 15  
  serial number 15  
  service 15  
  wireless certification 15  
  WLAN 15  
legacy support, USB 71  
lights  
  battery 14  
  caps lock 9  
  drive 14  
  microphone mute 9  
  num lk 9  
  power 9, 14  
  RJ-45 (network) 6  
  TouchPad 9

  webcam 7  
  wireless 9, 14  
**M**  
memory  
  nonvolatile 86  
  volatile 86  
memory card reader, identifying 5  
memory module  
  product description 1  
  removal 40  
  spare part number 17  
  spare part numbers 40

microphone  
  product description 2  
microphone module  
  spare part number 19  
microphone mute key, identifying  
  12  
microphone mute light, identifying  
  9  
minimized image recovery 80  
minimized image, creating 79  
model name 1  
mouse  
  spare part numbers 23

**N**  
Near Field Communications (NFC)  
  tapping area  
  identifying 8  
network jack, identifying 6  
NFC module  
  removal 60  
  spare part number 60  
  spare part numbers 18  
nonvolatile memory 86  
num lk light 9

**O**  
operating environment 83  
operating system, product  
  description 4  
original system recovery 79

**P**  
pointing device, product  
  description 3  
pointing stick 8  
ports  
  Dual-Mode DisplayPort 5

  external monitor 6  
  product description 3  
  USB 3.x 6  
  USB 3.x charging 6  
  USB Type-C charging 5  
power button, identifying 10  
power connector, identifying 6  
power cord  
  set requirements 84  
power lights 9, 14  
power requirements, product  
  description 3  
processor  
  product description 1  
product description  
  audio 2  
  chipset 1  
  display panel 1  
  ethernet 2  
  external media cards 3  
  graphics 1  
  hard drive 1  
  keyboard 3  
  memory module 1  
  microphone 2  
  operating system 4  
  pointing device 3  
  ports 3  
  power requirements 3  
  processors 1  
  product name 1  
  security 3  
  serviceability 4  
  solid-state drive 1  
  video 2  
  wireless 2  
product name 1  
product name and number,  
  computer 15

**R**  
raw panel  
  spare part number 19  
recover  
  options 79  
recovery  
  discs 78, 80  
  HP Recovery Manager 79  
  media 80  
  starting 80



- supported discs 78
- system 79
- USB flash drive 80
- using HP Recovery media 78
- recovery media
  - creating 77
  - creating using HP Recovery Manager 78
- recovery partition
  - removing 82
- regulatory information
  - regulatory label 15
  - wireless certification labels 15
- removal/replacement
  - procedures 30, 49
- removing personal data from volatile system memory 86
- RJ-45 (network) jack, identifying 6
- RJ-45 (network) lights, identifying 6
- RTC battery
  - removal 65
  - spare part number 18, 65
- Rubber Kit, spare part number 24

**S**

- screen image, switching 12
- screw kit, spare part number 24
- security cable slot, identifying 6
- security, product description 3
- serial number 15
- serial number, computer 15
- service labels, locating 15
- serviceability, product description 4
- setup utility
  - navigating and selecting 71
  - restoring factory settings 71
- SIM
  - spare part numbers 23
- SIM card slot, identifying 6
- slots
  - security cable 6
  - SIM card 6
  - smart card 6
- smart card reader
  - spare part number 17
- smart card reader board
  - removal 58
  - spare part number 58
- smart card slot 6

- solid-state drive
  - product description 1
  - removal 38
  - spare part numbers 17, 22, 38
- speaker assembly
  - removal 67
  - spare part number 18, 67
- speakers, identifying 10
- supported discs, recovery 78
- Sure Start
  - using 74
- system board
  - removal 61
  - spare part number 18
  - spare part numbers 61
- system memory, removing personal data from volatile 86
- system recovery 79
- system restore point
  - creating 78
- system restore point, creating 77

## T

- top cover
  - removal 68
  - spare part number 68
  - spare part numbers 17
- TouchPad
  - buttons 8
- touchpad board
  - removal 59
  - spare part number 18, 59
- TouchPad light, identifying 9
- TouchPad zone
  - identifying 8
- TPM settings 74
- traveling with the computer 15

## U

- USB 3.x charging port, identifying 6
- USB 3.x port, identifying 6
- USB legacy support 71
- USB Type-C charging port, identifying 5

## V

- vents, identifying 6, 13
- video, product description 2

## W

- webcam 7

- webcam light, identifying 7
- webcam module
  - removal 52
  - spare part number 19
- webcam, identifying 7
- Windows
  - system restore point 77, 78
- Windows key, identifying 11
- Windows tools
  - using 78
- wireless antennas
  - disconnecting 42, 44
- wireless antennas, identifying 7
- wireless certification label 15
- wireless light 9, 14
- wireless, product description 2
- WLAN antenna
  - spare part number 19
- WLAN antennas, identifying 7
- WLAN device 15
- WLAN label 15
- WLAN/Bluetooth combo card
  - removal 42
  - spare part number 17, 42
- WWAN antenna
  - spare part number 19
- WWAN antennas, identifying 7
- WWAN module
  - removal 44
  - spare part number 44
  - spare part numbers 17

## Free Manuals Download Website

<http://myh66.com>

<http://usermanuals.us>

<http://www.somanuals.com>

<http://www.4manuals.cc>

<http://www.manual-lib.com>

<http://www.404manual.com>

<http://www.luxmanual.com>

<http://aubethermostatmanual.com>

Golf course search by state

<http://golfingnear.com>

Email search by domain

<http://emailbydomain.com>

Auto manuals search

<http://auto.somanuals.com>

TV manuals search

<http://tv.somanuals.com>