



LaserJet Pro MFP M225, M226

User Guide



M225dn
M225rdn
M226dn



M225dw
M226dw



www.hp.com/support/ljMFPM225
www.hp.com/support/ljMFPM226



HP LaserJet Pro MFP M225, M226

User Guide

Copyright and License

© 2014 Copyright Hewlett-Packard Development Company, L.P.

Reproduction, adaptation, or translation without prior written permission is prohibited, except as allowed under the copyright laws.

The information contained herein is subject to change without notice.

The only warranties for HP products and services are set forth in the express warranty statements accompanying such products and services. Nothing herein should be construed as constituting an additional warranty. HP shall not be liable for technical or editorial errors or omissions contained herein.

Part number: CF484-90901

Edition 1, 10/2014

Trademark Credits

Adobe®, Adobe Photoshop®, Acrobat®, and PostScript® are trademarks of Adobe Systems Incorporated.

Apple and the Apple logo are trademarks of Apple Computer, Inc., registered in the U.S. and other countries. iPod is a trademark of Apple Computer, Inc. iPod is for legal or rightholder-authorized copying only. Don't steal music.

Microsoft®, Windows®, Windows® XP, and Windows Vista® are U.S. registered trademarks of Microsoft Corporation.

UNIX® is a registered trademark of The Open Group.

Table of contents

1 Product introduction	1
Product comparison	2
Power consumption, electrical specifications, and acoustic emissions	5
Operating-environment specifications	5
Product views	6
Product front view	6
Product back view	7
Control-panel views	8
M225dn, M225rdn, and M226dn control panel	8
M225dw and M226dw control panel	10
Product hardware setup and software installation	12
2 Paper trays	13
Supported paper sizes and types	14
Supported paper sizes	14
Supported paper types	16
Load the priority input tray (Tray 1)	17
Load the main input tray (Tray 2)	19
3 Parts, supplies, and accessories	23
Order parts, accessories, and supplies	24
Ordering	24
Supplies and accessories	24
Replace the toner cartridge	25
4 Print	29
Print tasks (Windows)	30
How to print (Windows)	30
Automatically print on both sides (Windows)	32
Manually print on both sides (Windows)	33
Print multiple pages per sheet (Windows)	34

Select the paper type (Windows)	35
Additional print tasks	35
Print tasks (Mac OS X)	36
How to print (OS X)	36
Automatically print on both sides (OS X)	36
Manually print on both sides (OS X)	36
Print multiple pages per sheet (OS X)	37
Select the paper type (OS X)	37
Additional print tasks	37
Set up HP Wireless Direct Printing	38
Mobile printing	39
HP ePrint via email	39
HP ePrint software	40
AirPrint	40
Use walk-up USB printing (dw models only)	41
5 Copy	43
Make a copy	44
Copy on both sides (duplex)	45
Copy on both sides automatically	45
Copy on both sides manually	45
6 Scan	47
Scan by using the HP Scan software (Windows)	48
Scan by using the HP Scan software (Mac)	49
Set up Scan to E-mail (touchscreen models only)	50
Introduction	50
Use the Scan to E-Mail Wizard (Windows)	50
Set up the Scan to Email feature via the HP Embedded Web Server (Windows)	50
Set up the Scan to Email feature via the HP Embedded Web Server (OS X)	51
Set up Scan to Network Folder (touchscreen models only)	54
Introduction	54
Use the Scan to Network Folder Setup Wizard (Windows)	54
Set up the Scan to Network Folder feature via the HP Embedded Web Server (Windows)	54
Set up the Scan to Network Folder feature via the HP Embedded Web Server (OS X)	55
Scan to a USB flash drive (touchscreen models only)	57
Scan to email (touchscreen models only)	58
Scan to a network folder (touchscreen models only)	59

7 Fax	61
Set up to send and receive faxes	62
Before starting	62
Step 1: Identify the phone connection type	62
Step 2: Set up the fax	63
Dedicated phone line	63
Shared voice/fax line	64
Shared voice/fax line with an answering machine	65
Step 3: Configure the fax time, date, and header	67
HP Fax Setup Wizard	67
Product control panel	67
HP Device Toolbox	68
HP Embedded Web Server	68
Step 4: Run a fax test	68
Step 5 (Optional): Configure settings for receiving digital faxes (Windows)	69
Send a fax	70
Fax from the flatbed scanner	70
Fax from the document feeder	70
Send a fax using the HP software (Windows)	72
8 Manage the product	73
Use HP Web Services applications (touchscreen models only)	74
Change the product connection type (Windows)	75
Advanced configuration with HP Embedded Web Server (EWS) and HP Device Toolbox (Windows)	76
Advanced configuration with HP Utility for Mac OS X	79
Open HP Utility	79
HP Utility features	79
Configure IP network settings	81
Printer sharing disclaimer	81
View or change network settings	81
Rename the product on a network	81
Manually configure IPv4 TCP/IP parameters from the control panel	82
HP Web Jetadmin	83
Product security features	84
Set or change the product password using the HP Embedded Web Server	84
Economy settings	85
Print with EconoMode	85
Configure the Sleep/Auto Off After setting	85
Update the firmware	87
Method one: Update the firmware using the control panel	87
Method two: Update the firmware using the Firmware Update Utility	88

9 Solve problems	89
Customer support	90
Control panel help system (touchscreen models only)	91
Restore the factory-set defaults	92
A Cartridge is low or Cartridge is very low message displays on the product control panel	93
Enable or disable the Very Low settings	93
Product does not pick up paper or misfeeds	95
The product does not pick up paper	95
The product picks up multiple sheets of paper	95
The document feeder jams, skews, or picks up multiple sheets of paper	95
Clean the pickup rollers and separation pad in the document feeder	96
Clear jams	98
Jam locations	98
Experiencing frequent or recurring paper jams?	98
Clear jams in the document feeder	100
Clear jams in the toner-cartridge area	102
Clear jams in the output bin	105
Clear jams in the duplexer	108
Improve print quality	110
Print from a different software program	110
Set the paper-type setting for the print job	110
Check the paper-type setting (Windows)	110
Check the paper type setting (OS X)	111
Check the toner-cartridge status	111
Clean the product	111
Print a cleaning page	111
Check the scanner glass for dirt and smudges	112
Inspect the toner cartridge for damage	112
Check the paper and printing environment	113
Use paper that meets HP specifications	113
Check the product environment	113
Check other print job settings	113
Check the EconoMode settings	113
Try a different print driver	115
Improve copy and scan quality	116
Check the scanner glass for dirt and smudges	116
Check the paper settings	116
Optimize for text or pictures	116
Edge-to-edge copying	117
Clean the pickup rollers and separation pad in the document feeder	118
Improve fax image quality	119

Check the scanner glass for dirt or smudges	119
Check the send-fax resolution setting	119
Check the lightness/darkness setting	119
Check the Error Correction setting	120
Check the Fit-to-Page setting	121
Clean the pickup rollers and separation pad in the document feeder	121
Send to a different fax machine	122
Check the sender's fax machine	122
Solve wired network problems	123
Poor physical connection	123
The computer is using the incorrect IP address for the product	123
The computer is unable to communicate with the product	123
The product is using incorrect link and duplex settings for the network	124
New software programs might be causing compatibility problems	124
The computer or workstation might be set up incorrectly	124
The product is disabled, or other network settings are incorrect	124
Solve wireless network problems	125
Wireless connectivity checklist	125
The product does not print after the wireless configuration completes	126
The product does not print, and the computer has a third-party firewall installed	126
The wireless connection does not work after moving the wireless router or product	126
Cannot connect more computers to the wireless product	126
The wireless product loses communication when connected to a VPN	126
The network does not appear in the wireless networks list	126
The wireless network is not functioning	127
Perform a wireless network diagnostic test	127
Reduce interference on a wireless network	127
Solve fax problems	128
Check the hardware setup	128
Faxes are sending slowly	129
Fax quality is poor	130
Fax cuts off or prints on two pages	130

Index	131
--------------------	------------

1 Product introduction

- [Product comparison](#)
- [Product views](#)
- [Product hardware setup and software installation](#)

For more information:

Go to www.hp.com/support/ljMFPM225, www.hp.com/support/ljMFPM226.

HP's all-inclusive help for the product includes the following information:

- Install and configure
- Learn and use
- Solve problems
- Download software updates
- Join support forums
- Find warranty and regulatory information

Product comparison

Model name		M225dn	M226dn	M225rdn	M225dw	M226dw
Product number		CF484A	C6N22A	CF486A	CF485A	C6N23A
Product dimensions	Height	371 mm (14.6 in)	371 mm (14.6 in)	371 mm (14.6 in)	371 mm (14.6 in)	371 mm (14.6 in)
	Depth	408 mm (16.1 in)	408 mm (16.1 in)	408 mm (16.1 in)	408 mm (16.1 in)	408 mm (16.1 in)
	Width	443 mm (17.4 in)	443 mm (17.4 in)	443 mm (17.4 in)	443 mm (17.4 in)	443 mm (17.4 in)
	Weight, with toner cartridge	11.0 kg (24.3 lb)	11.0 kg (24.3 lb)	11.1 kg (24.4 lb)	11.0 kg (24.3 lb)	11.0 kg (24.3 lb)
Paper handling	Priority input tray (Tray 1, 10-sheet capacity)	✓	✓	✓	✓	✓
	Main input tray (Tray 2, 250-sheet capacity)	✓	✓	✓	✓	✓
	Standard output bin (100-sheet capacity)	✓	✓	✓	✓	✓
	Automatic duplex printing	✓	✓	✓	✓	✓
Supported operating systems	Windows XP, 32-bit, SP2 and greater	✓	✓	✓	✓	✓
	Windows Vista, 32-bit and 64-bit	✓	✓	✓	✓	✓
	Windows 7, 32-bit and 64-bit	✓	✓	✓	✓	✓
	Windows 8, 32-bit and 64-bit	✓	✓	✓	✓	✓
	Windows 8.1, 32-bit and 64-bit	✓	✓	✓	✓	✓
	Windows 2003 Server 32-bit, SP1 and higher, print and scan drivers only	✓	✓	✓	✓	✓
	Windows 2003 Server 64-bit, SP1 and higher, print driver only by using Add Printer Wizard	✓	✓	✓	✓	✓
	Windows 2003 Server, Standard Edition and Enterprise Edition, print and scan drivers only	✓	✓	✓	✓	✓

Model name	M225dn	M226dn	M225rdn	M225dw	M226dw
Product number	CF484A	C6N22A	CF486A	CF485A	C6N23A
Windows 2003 R2 Server 32-bit, Standard and Enterprise editions, print and scan drivers only	✓	✓	✓	✓	✓
Windows 2003 R2 Server 64-bit, Standard and Enterprise editions, print driver only by using Add Printer Wizard	✓	✓	✓	✓	✓
Windows 2008 Server, 32-bit and 64-bit, (SP1 and higher) print and scan drivers only	✓	✓	✓	✓	✓
Windows 2008 R2 Server 64-bit, print and scan drivers only	✓	✓	✓	✓	✓
Windows 2008 R2 Server 64-bit, SP1, print and scan drivers only	✓	✓	✓	✓	✓
Windows 2008 Server, Standard and Enterprise editions, print and scan drivers only	✓	✓	✓	✓	✓
Windows 2012 R2 Server 64-bit, print driver only by using Add Printer Wizard	✓	✓	✓	✓	✓
Windows 2012 Server 64-bit, print driver only by using Add Printer Wizard	✓	✓	✓	✓	✓
Mac OS X v10.7 – v10.9	✓	✓	✓	✓	✓
Supported print and scan drivers for Windows HP PCL6 discrete print driver This driver is included on the in-box CD as the default print driver.	✓	✓	✓	✓	✓

Model name	M225dn	M226dn	M225rdn	M225dw	M226dw
Product number	CF484A	C6N22A	CF486A	CF485A	C6N23A
HP Scan driver This driver is included on the in-box CD.	✓	✓	✓	✓	✓
HP UPD PCL5c print driver Available for download	✓	✓	✓	✓	✓
HP UPD PCL6 print driver Available for download	✓	✓	✓	✓	✓
HP UPD PS print driver Available for download	✓	✓	✓	✓	✓
Connectivity					
Hi-Speed USB 2.0	✓	✓	✓	✓	✓
10/100 Ethernet LAN connection	✓	✓	✓	✓	✓
Wireless network connection				✓	✓
Walk-up USB port for printing and scanning without a computer				✓	✓
Memory					
256 MB RAM	✓	✓	✓	✓	✓
Control-panel display					
2-line LCD	✓	✓	✓		
Color graphical touchscreen				✓	✓
Print					
Prints 25 pages per minute (ppm) on A4-size paper and 26 ppm on Letter-size paper	✓	✓	✓	✓	✓
Copy					
Flatbed scanner supports paper up to A4 or Letter-size	✓	✓	✓	✓	✓
Document feeder supports paper up to Legal size (Copies up to 15 ppm)	✓	✓	✓	✓	✓

Model name	M225dn	M226dn	M225rdn	M225dw	M226dw	
Product number	CF484A	C6N22A	CF486A	CF485A	C6N23A	
	Copy resolution is 300 dots per inch (dpi)	✓	✓	✓	✓	✓
Scan	Flatbed scanner supports paper up to A4 or Letter-size	✓	✓	✓	✓	✓
	Document feeder supports paper up to Legal size	✓	✓	✓	✓	✓
	Scan resolution up to 1200 dpi	✓	✓	✓	✓	✓
	Scans in color	✓	✓	✓	✓	✓
	Integrated Optical Character Recognition (OCR) software adds support for additional OCR file types in HP Scan: Searchable PDFs (.pdf), Rich Text (.rtf), and Text (.txt)	✓	✓	✓	✓	✓
	Scan to email			✓	✓	
	Scan to network folder			✓	✓	
	Scan to USB			✓	✓	
Fax	V.34 with two RJ-11 fax ports	✓	✓	✓	✓	✓

Power consumption, electrical specifications, and acoustic emissions

See www.hp.com/support/ljMFPM225, www.hp.com/support/ljMFPM226 for current information.

CAUTION: Power requirements are based on the country/region where the product is sold. Do not convert operating voltages. This will damage the product and void the product warranty.

Operating-environment specifications

Environment	Recommended	Allowed
Temperature	17° to 25°C (62.6° to 77°F)	15° to 30°C (59° to 86°F)
Relative humidity	30% to 70% relative humidity (RH)	10% to 80% RH
Altitude	Not applicable	0 to 3048 m (0 to 10,000 ft)

Product views

- [Product front view](#)
- [Product back view](#)
- [Control-panel views](#)

Product front view

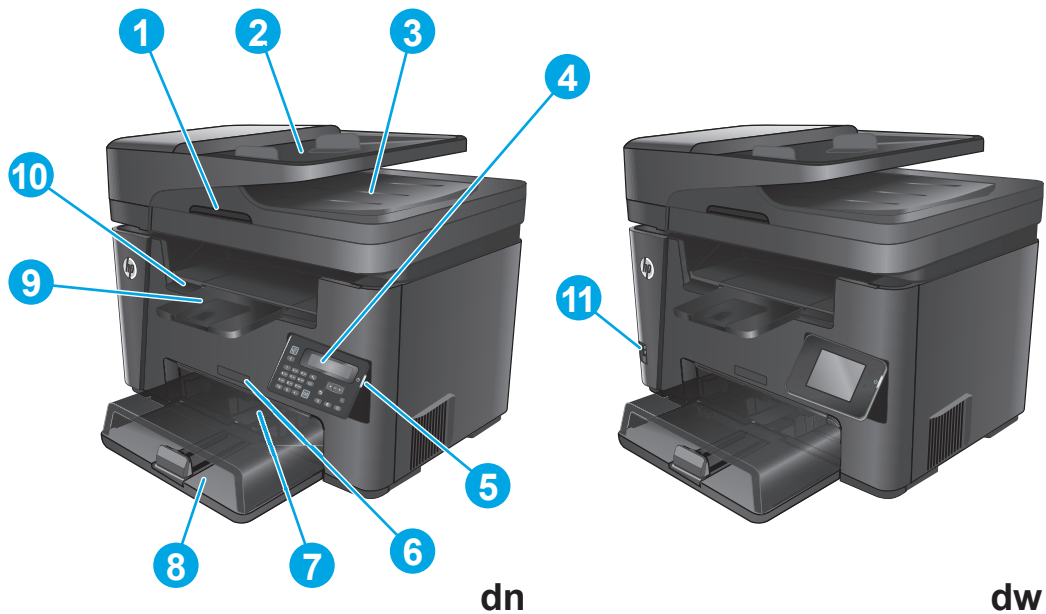

1	Handle for lifting the scanner cover
2	Document feeder input tray (lift the tray to clear jams)
3	Document feeder output bin
4	Control panel (tilts up for easier viewing) dn models: LCD control panel dw models: Graphical touchscreen control panel
5	Power on/off button
6	Model name
7	Priority input tray (Tray 1)
8	Main input tray (Tray 2)
9	Output bin
10	Handle for opening the top cover (access to the toner cartridge and for clearing jams)
11	Walk-up USB port for printing and scanning without a computer (dw models only)

Product back view

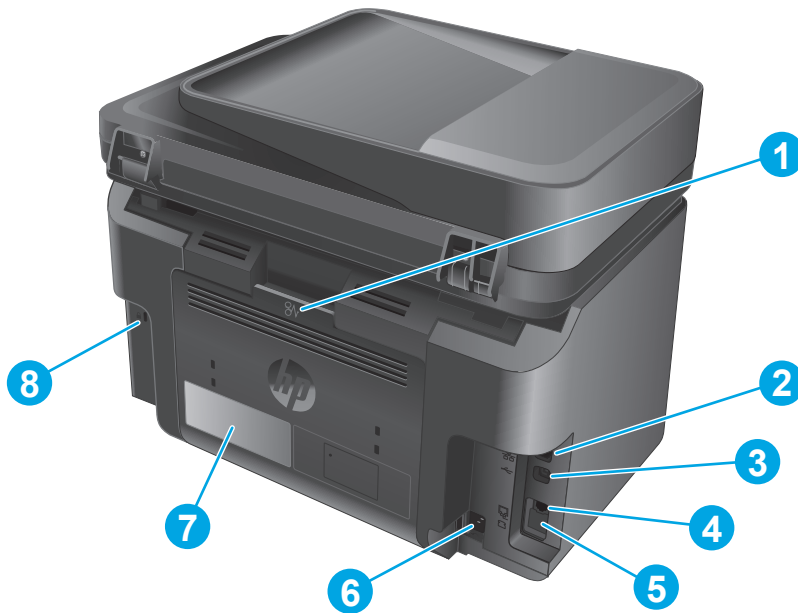

1	Rear door (access for clearing jams)
2	Ethernet port
3	Hi-Speed USB 2.0
4	Fax "line in" port for attaching the fax phone line to the product
5	Telephone "line out" port for attaching an extension phone, answering machine, or other device
	NOTE: This port is covered with a rubber cap. Pull the cap down from the top edge to access the port.
6	Power connection
7	Product number and serial number label
8	Slot for cable-type security lock

Control-panel views

M225dn, M225rdn, and M226dn control panel

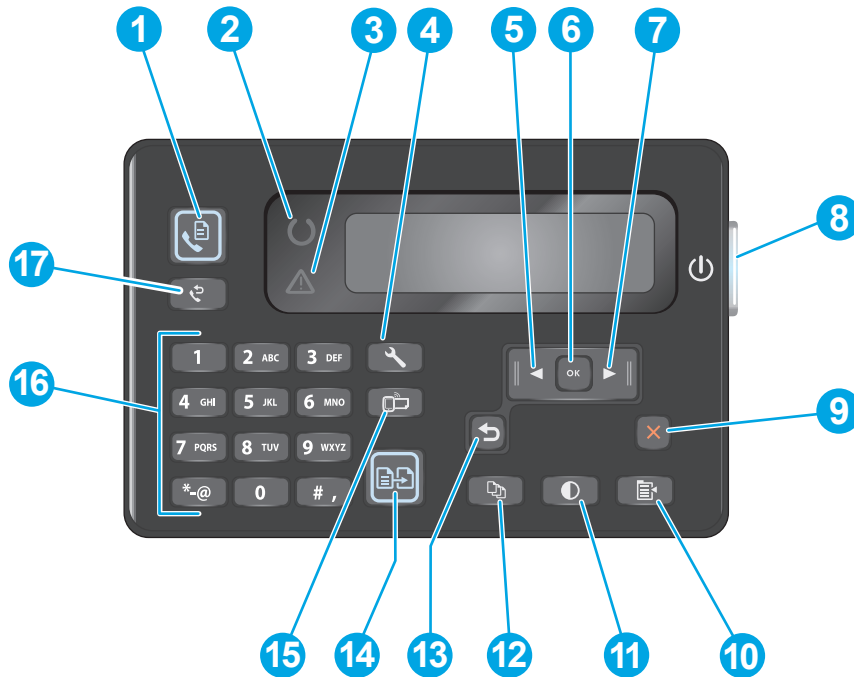

1	Start Fax button	Starts a fax job
2	Attention light	Indicates the product has an error, a tray is empty, or other condition requiring attention
3	Ready light	Indicates the product is ready
4	Setup button	Opens the Setup menu
5	Left arrow button	Moves the cursor to the left or scrolls through menu options
6	OK button	Confirms a setting or an action to proceed
7	Right arrow button	Moves the cursor to the right or scrolls through menu options
8	Power on/off button	Turns the product on or off
9	Cancel button	Clears settings, cancels the current job, or exits the current menu
10	Copy Settings button	Opens the Copy Settings menu
11	Lighter/Darker button	Adjusts the darkness setting for the current copy job
12	Number of Copies button	Sets the number of copies
13	Back button	Returns to the previous screen
14	Start Copy button	Starts a copy job
15	ePrint button	Opens the Web Services menu

16	Numeric keypad	Use the keypad to enter fax numbers or select menu options
17	Fax Redial button	Recalls the fax number used for the previous fax job

M225dw and M226dw control panel

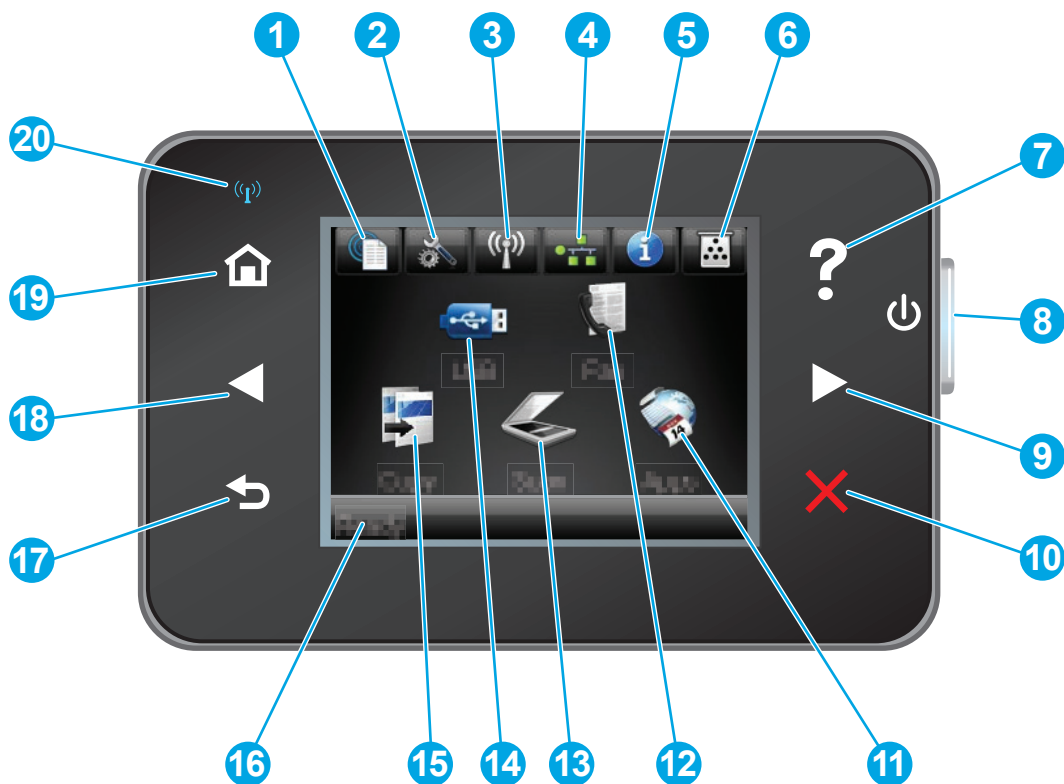

1	HP Web Services button	Provides quick access to HP Web Services features, including HP ePrint
2	Setup button	Opens the Setup menu
3	Wireless button	Provides access to the Wireless menu and wireless status information NOTE: When the product is connected to a wireless network, this icon changes to a set of signal strength bars.
4	Network button	Provides access to network settings and information NOTE: This button displays only when the product is connected to a network.
5	Information button	Provides product status information
6	Supplies button	Provides information about supplies status
7	Help button	Provides access to the control-panel help system
8	Power on/off button	Turns the product on or off
9	Right arrow button	Moves the cursor to the right or moves the display to the next screen NOTE: This button illuminates only when the current screen can use this feature.

10	Cancel button	Clears settings, cancels the current job, or exits the current screen NOTE: This button illuminates only when the current screen can use this feature.
11	Apps button	Provides access to the Apps menu to print directly from select Web applications
12	Fax button	Provides access to the fax feature
13	Scan button	Provides access to the scan features: <ul style="list-style-type: none"> • Scan to USB Drive • Scan to Network Folder • Scan to E-mail
14	USB button	Provides access to the USB Flash Drive menu
15	Copy button	Provides access to the copy feature
16	Product status	Provides information about the overall product status
17	Back button	Returns to the previous screen NOTE: This button illuminates only when the current screen can use this feature.
18	Left arrow button	Moves the cursor to the left or moves the display to the previous screen NOTE: This button illuminates only when the current screen can use this feature.
19	Home button	Provides access to the Home screen
20	Wireless light	Indicates the wireless network is enabled. The light blinks while the product is establishing a connection to the wireless network.

Product hardware setup and software installation

For basic setup instructions, see the Hardware Installation Guide that came with the product. For additional instructions, go to HP support on the Web.

Go to www.hp.com/support/ljMFPM225, www.hp.com/support/ljMFPM226 for HP's all-inclusive help for the product. Find the following support:

- Install and configure
- Learn and use
- Solve problems
- Download software updates
- Join support forums
- Find warranty and regulatory information

2 Paper trays

- [Supported paper sizes and types](#)
- [Load the priority input tray \(Tray 1\)](#)
- [Load the main input tray \(Tray 2\)](#)

For more information:

Go to www.hp.com/support/ljMFPM225, www.hp.com/support/ljMFPM226.

HP's all-inclusive help for the product includes the following information:

- Install and configure
- Learn and use
- Solve problems
- Download software updates
- Join support forums
- Find warranty and regulatory information

Supported paper sizes and types

- [Supported paper sizes](#)
- [Supported paper types](#)

Supported paper sizes



NOTE: To obtain the best results, select the correct paper size and type in the print driver before printing.

Size	Dimensions	Priority input tray (Tray 1)	Main input tray (Tray 2)	Auto duplex
Letter	216 x 279 mm (8.5 x 11 in)	✓	✓	✓
Legal	216 x 356 mm (8.5 x 14 in)	✓	✓	✓
Executive	184 x 267 mm (7.3 x 10.5 in)	✓	✓	
Oficio 8.5 x 13	216 x 330 mm (8.5 x 13 in)	✓	✓	✓
4 x 6	102 x 152 mm (4 x 6 in)	✓		
5 x 8	127 x 203 mm (5 x 8 in)	✓	✓	
A4	210 x 297 mm (8.3 x 11.7 in)	✓	✓	✓
A5	148 x 210 mm (5.8 x 8.3 in)	✓	✓	
A6	105 x 148 mm (4.1 x 5.8 in)	✓		
B5 (JIS)	182 x 257 mm (7.2 x 10.1 in)	✓	✓	
B6 (JIS)	129 x 182 mm (5.1 x 7.2 in)	✓		
10 x 15cm	102 x 152 mm (4 x 6 in)	✓		
Oficio 216 x 340 mm	216 x 340 mm (8.5 x 13.4 in)	✓	✓	
16K	195 x 270 mm (7.7 x 10.6 in)	✓	✓	
16K	184 x 260 mm (7.2 x 10.3 in)	✓	✓	
16K	197 x 273 mm (7.8 x 10.8 in)	✓	✓	
Japanese Postcard	100 x 148 mm (3.9 x 5.8 in)	✓		
Postcard (JIS)				
Double Japan Postcard Rotated	200 x 148 mm (7.9 x 5.8 in)	✓	✓	
Double Postcard (JIS)				
Envelope #10	105 x 241 mm (4.1 x 9.5 in)	✓	✓	

Size	Dimensions	Priority input tray (Tray 1)	Main input tray (Tray 2)	Auto duplex
Envelope Monarch	98 x 191 mm (3.9 x 7.5 in)	✓	✓	
Envelope B5	176 x 250 mm (6.9 x 9.8 in)	✓	✓	
Envelope C5	162 x 229 mm (6.4 x 9 in)	✓	✓	
Envelope DL	110 x 220 mm (4.3 x 8.7 in)	✓	✓	
Custom	76 x 127 mm to 216 x 356 mm (3 x 5 in to 8.5 x 14 in)	✓		

Supported paper types



NOTE: To obtain the best results, select the correct paper size and type in the print driver before printing.

Type	Single-sided or manual duplex	Auto duplex
Plain	✓	✓
HP EcoSMART Lite	✓	✓
Light 60–74g	✓	✓
Intermediate 85–95g	✓	✓
Midweight 96–110g	✓	✓
Heavy 111–130g	✓	
Extra Heavy 131–175g	✓	
Transparency	✓	
Labels	✓	
Letterhead	✓	✓
Envelope	✓	
Preprinted	✓	✓
Prepunched	✓	✓
Colored	✓	✓
Bond	✓	✓
Recycled	✓	✓
Rough	✓	
Vellum	✓	

Load the priority input tray (Tray 1)

 **NOTE:** When you add new paper, make sure that you remove all of the paper from the input tray and straighten the stack. Do not fan the paper. This reduces jams by preventing multiple sheets of paper from feeding through the product at one time. Use paper that is not wrinkled, folded, or damaged.

1. Load the paper face-up with the top forward in the input tray.

The orientation of the paper in the tray varies depending on the type of print job. For additional information, see [Table 2-1 Tray 1 paper orientation on page 17](#).



2. Adjust the paper guides until they are snug against the paper.

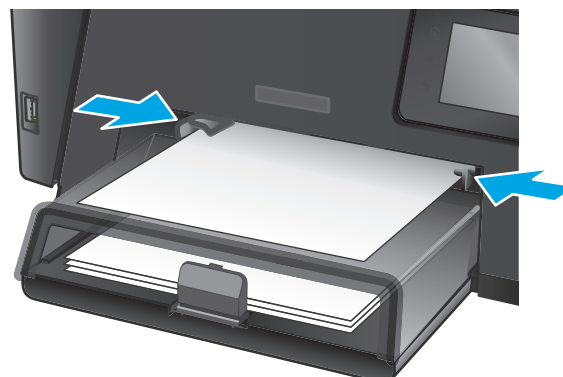

Table 2-1 Tray 1 paper orientation

Paper type	Duplex mode	How to load paper
Preprinted or letterhead	1-sided printing or manual 2-sided printing	Face-up Top edge leading into the product





A top-down view of the printer's priority input tray. A sheet of paper is loaded into the tray. The paper has the number '123' printed on it. The top edge of the paper is leading into the printer's internal rollers, demonstrating the correct loading orientation for preprinted or letterhead paper.

Table 2-1 Tray 1 paper orientation (continued)

Paper type	Duplex mode	How to load paper
Punch holes	1-sided printing or manual 2-sided printing	Face-up Holes toward the left side of the product
		
Envelopes	1-sided printing	Face-up Top edge toward the right of the tray, postage end entering the product last
		

Load the main input tray (Tray 2)

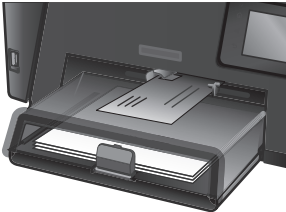
 **NOTE:** When adding new paper, make sure to remove all of the paper from the input tray and straighten the stack. Do not fan the paper. This reduces jams by preventing multiple sheets of paper from feeding through the product at one time. Use paper that is not wrinkled, folded, or damaged.

1. Open the dust cover.



2. Load the paper into the tray. Make sure that the paper fits under the tabs and below the maximum-height indicators.

The orientation of the paper in the tray varies depending on the type of print job. For additional information, see [Table 2-2 Tray 2 paper orientation on page 21](#).



3. Adjust the paper guides until they are snug against the paper.



4. Close the dust cover.

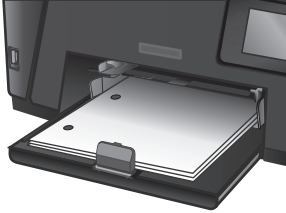

Table 2-2 Tray 2 paper orientation

Paper type	Duplex mode	How to load paper
Preprinted or letterhead	1-sided printing or 2-sided printing	Face-up Top edge leading into the product 
Prepunched	1-sided printing or 2-sided printing	Face-up Holes toward the left side of the product 

3 Parts, supplies, and accessories

- [Order parts, accessories, and supplies](#)
- [Replace the toner cartridge](#)

For more information:

Go to www.hp.com/support/ljMFPM225, www.hp.com/support/ljMFPM226.

HP's all-inclusive help for the product includes the following information:

- Install and configure
- Learn and use
- Solve problems
- Download software updates
- Join support forums
- Find warranty and regulatory information

Order parts, accessories, and supplies

Ordering

Order supplies and paper	www.hp.com/go/suresupply
Order genuine HP parts or accessories	www.hp.com/buy/parts
Order through service or support providers	Contact an HP-authorized service or support provider.
Order using the HP Embedded Web Server (EWS)	To access, in a supported Web browser on your computer, enter the product IP address or host name in the address/URL field. The EWS contains a link to the HP SureSupply Web site, which provides options for purchasing Original HP supplies.

Supplies and accessories

Item	Description	Part number
HP 83A Toner Cartridge	Replacement toner cartridge	CF283A
HP 83X Toner Cartridge	High-capacity replacement toner cartridge	CF283X
HP 88A Toner Cartridge	Replacement toner cartridge for China and India only	CC388A
USB cable	2-meter standard USB-compatible device connector	C6518A

Replace the toner cartridge

When a toner cartridge approaches the end of useful life, you are prompted to order a replacement. You can continue printing with the current cartridge until redistributing the toner no longer yields acceptable print quality.

A second message displays on the control panel when the toner cartridge reaches the “very low” state.

1. Lift the scanner assembly.

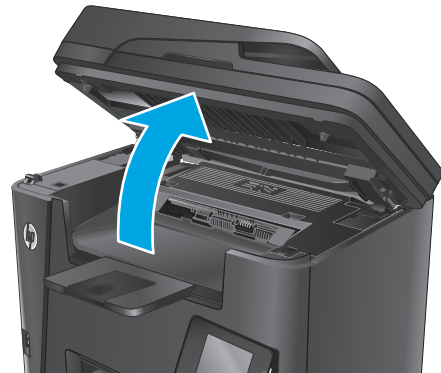

2. Open the top cover.



3. Remove the toner cartridge.

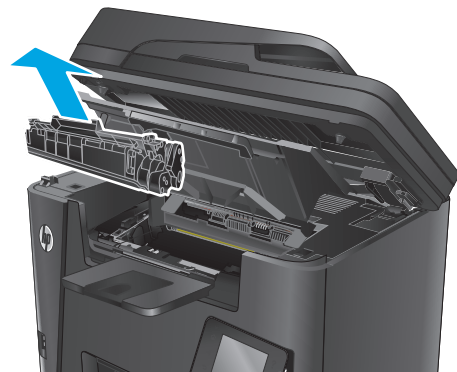

- 4. Remove the new toner cartridge from the bag. Place the used toner cartridge in the bag for recycling.

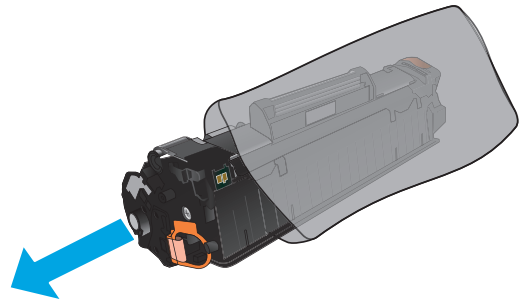

- 5. Grasp both sides of the toner cartridge and distribute the toner by gently rocking the cartridge.

CAUTION: Do not touch the shutter or the surface of the roller.

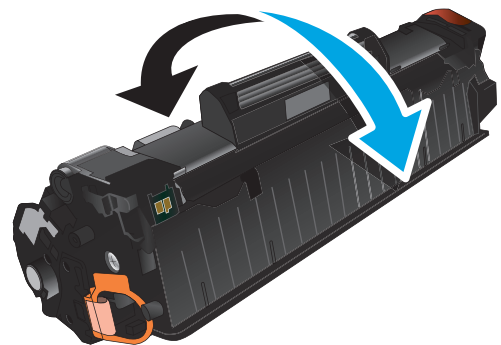

- 6. Bend the tab on the left side of the cartridge until the tab breaks loose. Pull the tab until all the tape is removed from the cartridge. Place the tab and tape in the toner cartridge box to return for recycling.

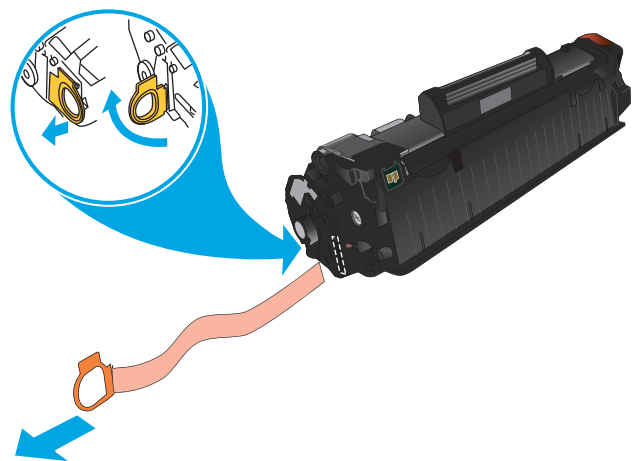

7. Align the toner cartridge with the tracks inside the product, and then insert the toner cartridge until it is firmly seated.

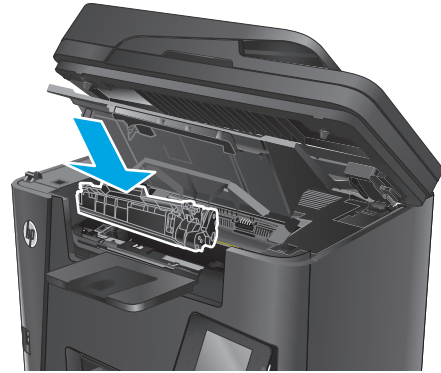

8. Close the top cover.

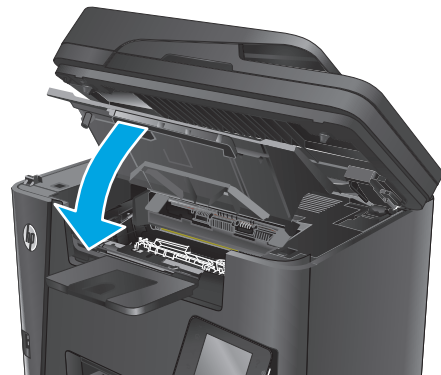

9. Lower the scanner assembly.



4 Print

- [Print tasks \(Windows\)](#)
- [Print tasks \(Mac OS X\)](#)
- [Set up HP Wireless Direct Printing](#)
- [Mobile printing](#)
- [Use walk-up USB printing \(dw models only\)](#)

For more information:

Go to www.hp.com/support/ljMFPM225, www.hp.com/support/ljMFPM226.

HP's all-inclusive help for the product includes the following information:

- Install and configure
- Learn and use
- Solve problems
- Download software updates
- Join support forums
- Find warranty and regulatory information

Print tasks (Windows)

- [How to print \(Windows\)](#)
- [Automatically print on both sides \(Windows\)](#)
- [Manually print on both sides \(Windows\)](#)
- [Print multiple pages per sheet \(Windows\)](#)
- [Select the paper type \(Windows\)](#)
- [Additional print tasks](#)

How to print (Windows)

The following procedure describes the basic printing process for Windows.

1. From the software program, select the **Print** option.
2. Select the product from the list of printers. To change settings, click or tap the **Properties** or **Preferences** button to open the print driver.



NOTE: The name of the button varies for different software programs.

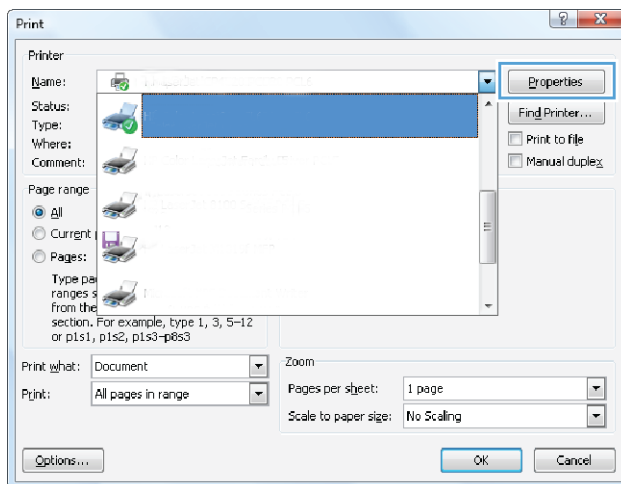

3. Click or tap the tabs in the print driver to configure the available options. For example, set the paper orientation on the **Finishing** tab, and set the paper source, paper type, paper size, and quality settings on the **Paper/Quality** tab.

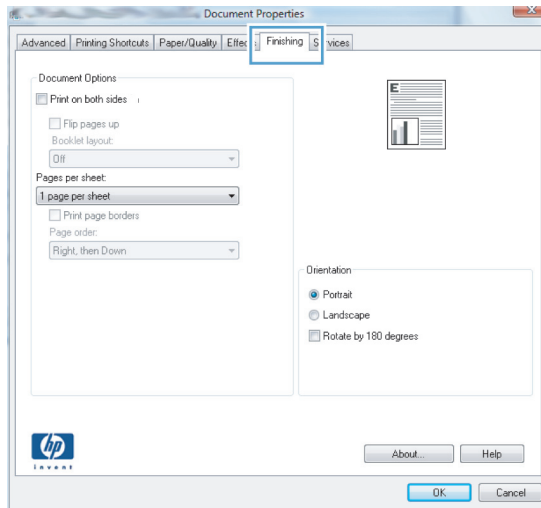

4. Click or tap the **OK** button to return to the **Print** dialog box. Select the number of copies to print from this screen.
5. Click or tap the **OK** button to print the job.

Automatically print on both sides (Windows)

Use this procedure for products that have an automatic duplexer installed. If the product does not have an automatic duplexer installed, or to print on paper types that the duplexer does not support, you can print on both sides manually.

1. From the software program, select the **Print** option.
2. Select the product from the list of printers, and then click or tap the **Properties** or **Preferences** button to open the print driver.



NOTE: The name of the button varies for different software programs.

3. Click or tap the **Finishing** tab.
4. Select the **Print on both sides** check box. Click the **OK** button to close the **Document Properties** dialog box.
5. In the **Print** dialog box, click the **OK** button to print the job.

Manually print on both sides (Windows)

Use this procedure for products that do not have an automatic duplexer installed or to print on paper that the duplexer does not support.

1. From the software program, select the **Print** option.
2. Select the product from the list of printers, and then click or tap the **Properties** or **Preferences** button to open the print driver.



NOTE: The name of the button varies for different software programs.

3. Click or tap the **Finishing** tab.
4. Select the **Print on both sides (manually)** check box. Click the **OK** button to print the first side of the job.
5. Retrieve the printed stack from the output bin, and place it in Tray 1.
6. If prompted, touch the appropriate control panel button to continue.

Print multiple pages per sheet (Windows)

1. From the software program, select the **Print** option.
2. Select the product from the list of printers, and then click or tap the **Properties** or **Preferences** button to open the print driver.



NOTE: The name of the button varies for different software programs.

3. Click or tap the **Finishing** tab.
4. Select the number of pages per sheet from the **Pages per sheet** drop-down list.
5. Select the correct **Print page borders**, **Page order**, and **Orientation** options. Click the **OK** button to close the **Document Properties** dialog box.
6. In the **Print** dialog box, click the **OK** button to print the job.

Select the paper type (Windows)

1. From the software program, select the **Print** option.
2. Select the product from the list of printers, and then click or tap the **Properties** or **Preferences** button to open the print driver.



NOTE: The name of the button varies for different software programs.

3. Click or tap the **Paper/Quality** tab.
4. From the **Paper type** drop-down list, click the **More...** option.
5. Expand the list of **Type is:** options.
6. Expand the category of paper types that best describes your paper.
7. Select the option for the type of paper you are using, and then click the **OK** button.
8. Click the **OK** button to close the **Document Properties** dialog box. In the **Print** dialog box, click the **OK** button to print the job.

Additional print tasks

Go to www.hp.com/support/ljMFPM225, www.hp.com/support/ljMFPM226.

Instructions are available for performing specific print tasks, such as the following:

- Create and use printing shortcuts or presets
- Select the paper size, or use a custom paper size
- Select the page orientation
- Create a booklet
- Scale a document to fit a specific paper size
- Print the first or last pages of the document on different paper
- Print watermarks on a document

Print tasks (Mac OS X)

- [How to print \(OS X\)](#)
- [Automatically print on both sides \(OS X\)](#)
- [Manually print on both sides \(OS X\)](#)
- [Print multiple pages per sheet \(OS X\)](#)
- [Select the paper type \(OS X\)](#)
- [Additional print tasks](#)

How to print (OS X)

The following procedure describes the basic printing process for OS X.

1. Click the **File** menu, and then click the **Print** option.
2. Select the product.
3. Click **Show Details**, and then select other menus to adjust the print settings.
4. Click the **Print** button.

Automatically print on both sides (OS X)

 **NOTE:** This information applies to products that include an automatic duplexer.

 **NOTE:** This feature is available if you install the HP print driver. It might not be available if you are using AirPrint.

1. Click the **File** menu, and then click the **Print** option.
2. Select the product.
3. Click **Show Details**, and then click the **Layout** menu.
4. Select a binding option from the **Two-Sided** drop-down list.
5. Click the **Print** button.

Manually print on both sides (OS X)

 **NOTE:** This feature is available if you install the HP print driver. It might not be available if you are using AirPrint.

1. Click the **File** menu, and then click the **Print** option.
2. Select the product.
3. Click **Show Details**, and then click the **Manual Duplex** menu.
4. Click the **Manual Duplex** box, and select a binding option.
5. Click the **Print** button.
6. Go to the product, and remove any blank paper that is in Tray 1.

7. Retrieve the printed stack from the output bin and place it with the printed-side facing down in the input tray.
8. If prompted, touch the appropriate control panel button to continue.

Print multiple pages per sheet (OS X)

1. Click the **File** menu, and then click the **Print** option.
2. Select the product.
3. Click **Show Details**, and then click the **Layout** menu.
4. From the **Pages per Sheet** drop-down list, select the number of pages that you want to print on each sheet.
5. In the **Layout Direction** area, select the order and placement of the pages on the sheet.
6. From the **Borders** menu, select the type of border to print around each page on the sheet.
7. Click the **Print** button.

Select the paper type (OS X)

1. Click the **File** menu, and then click the **Print** option.
2. Select the product.
3. Click **Show Details**, and then click the **Media & Quality** menu or the **Paper/Quality** menu.
4. Select a type from the **Media-type** drop-down list.
5. Click the **Print** button.

Additional print tasks

Go to www.hp.com/support/ljMFPM225, www.hp.com/support/ljMFPM226.

Instructions are available for performing specific print tasks, such as the following:

- Create and use printing shortcuts or presets
- Select the paper size, or use a custom paper size
- Select the page orientation
- Create a booklet
- Scale a document to fit a specific paper size
- Print the first or last pages of the document on different paper
- Print watermarks on a document

Set up HP Wireless Direct Printing



NOTE: This feature is available with wireless models only and the product might require a firmware update to use this feature.

The HP Wireless Direct Printing feature lets you print from your wireless mobile device directly to an HP Wireless Direct-enabled product without requiring connection to an established network or the Internet. Use HP Wireless Direct to print wirelessly from the following devices:

- iPhone, iPad, or iTouch using Apple AirPrint or the HP ePrint mobile app
- Mobile devices that run Android or Symbian using the HP ePrint Home & Biz application
- Any Wi-Fi capable computer with any operating system.

For more information on HP Wireless Direct, go to www.hp.com/go/wirelessprinting, and then click **HP Wireless Direct**.

To set up HP Wireless Direct from the control panel, complete the following steps:

1. From the Home screen on the product control panel, touch the Wireless  button.
2. Open the following menus:
 - [Wireless Menu](#)
 - [Wireless Direct](#)
 - [On/Off](#)
3. Touch the [On](#) menu item. The product saves the setting and then returns the control panel to the [Wireless Direct](#) menu.

Mobile printing

HP offers multiple Mobile and ePrint solutions to enable wireless printing to an HP printer from a laptop, tablet, smartphone, or other mobile device. To determine the best choice, go to www.hp.com/go/LaserJetMobilePrinting (English only).

- [HP ePrint via email](#)
- [HP ePrint software](#)
- [AirPrint](#)

HP ePrint via email

Use HP ePrint to print documents by sending them as an email attachment to the product's email address from any email enabled device.

To use HP ePrint, the product must meet these requirements:

- The product must be connected to a wired or wireless network and have Internet access.
- HP Web Services must be enabled on the product, and the product must be registered with HP Connected.

LCD control panel

1. Find the product IP address.
 - a. On the product control panel, press the Setup  button.
 - b. Open the following menus:
 - **Network Setup**
 - **Show IP Address**
2. To open the HP Embedded Web Server, enter the product IP address into the address line of a Web browser on the computer.
3. Click the **HP Web Services** tab on the HP Embedded Web Server, and then click **Enable**. The product enables Web Services, and then prints an information page.

The information page contains the printer code that you use to register your HP product at HP Connected.

4. Go to www.hpconnected.com to create an HP ePrint account and complete the setup process.

Touchscreen control panel

1. From the Home screen on the product control panel, touch the Web Services  button.
2. Touch the **Enable Web Services** button. The product enables Web Services, and then prints an information page.

The information page contains the printer code that you use to register your HP product at HP Connected.
3. Go to www.hpconnected.com to create an HP ePrint account and complete the setup process.

For more information, go to www.hp.com/support to view additional information for your product.

HP ePrint software

The HP ePrint software makes it easy to print from a Windows or Mac desktop or laptop computer to any HP ePrint-capable product. This software makes it easy to find HP ePrint-enabled products that are registered to your HP Connected account. The target HP printer can be located in the office or at locations across the globe.

- **Windows:** After installing the software, open the **Print** option from within your application, and then select **HP ePrint** from the installed printers list. Click the **Properties** button to configure print options.
- **Mac:** After installing the software, select **File, Print**, and then select the arrow next to **PDF** (in the bottom left of the driver screen). Select **HP ePrint**.

For Windows, the HP ePrint software supports TCP/IP printing to local network printers on the network (LAN or WAN) to products that support UPD PostScript®.

Windows and Mac both support IPP printing to LAN or WAN network-connected products that support ePCL.

Windows and Mac also both support printing PDF documents to public print locations and printing using HP ePrint via email through the cloud.

Go to www.hp.com/go/eprintsoftware for drivers and information.

 **NOTE:** The HP ePrint software is a PDF workflow utility for Mac, and is not technically a print driver.

 **NOTE:** HP ePrint Software does not support USB printing.

AirPrint

Direct printing using Apple's AirPrint is supported for iOS 4.2 or later. Use AirPrint to print directly to the product from an iPad, iPhone (3GS or later), or iPod touch (third generation or later) in the following applications:

- Mail
- Photos
- Safari
- iBooks
- Select third-party applications

To use AirPrint, the product must be connected to the same wireless network as the Apple device. For more information about using AirPrint and about which HP products are compatible with AirPrint, go to the support Web site for this product:

www.hp.com/support/ljMFPM225, www.hp.com/support/ljMFPM226

 **NOTE:** AirPrint does not support USB connections.

Use walk-up USB printing (dw models only)

1. Insert the USB flash drive into the walk-up USB port on the product.
2. The **USB Flash Drive** menu opens. Touch the arrow buttons to scroll through the options.
 - **Print Documents**
 - **View and Print Photos**
 - **Scan to USB Drive**
3. To print a document, touch the **Print Documents** screen, and then touch the name of the folder on the USB drive where the document is stored. When the summary screen opens, you can touch it to adjust the settings. Touch the **Print** button to print the document.
4. To print photos, touch the **View and Print Photos** screen, and then touch the preview image to select each photo that you want to print. Touch the **Done** button. When the summary screen opens, you can touch it to adjust the settings. Touch the **Print** button to print the photos.
5. Retrieve the printed job from the output bin, and remove the USB flash drive.

5 Copy

- [Make a copy](#)
- [Copy on both sides \(duplex\)](#)

For more information:



Go to www.hp.com/support/ljMFPM225, www.hp.com/support/ljMFPM226.

HP's all-inclusive help for the product includes the following information:

- Install and configure
- Learn and use
- Solve problems
- Download software updates
- Join support forums
- Find warranty and regulatory information

Make a copy

LCD control panel

1. Load the document on the scanner glass according to the indicators on the product.
2. Close the scanner.
3. On the product control panel, press the Copy Menu  button.
4. To optimize copy quality for different types of documents, open the **Optimize** menu. Use the arrow buttons to scroll through the options, and then press the **OK** button to select an option. The following copy-quality settings are available:
 - **Auto Select**: Use this setting when you are not concerned about the quality of the copy. This is the default setting.
 - **Mixed**: Use this setting for documents that contain a mixture of text and graphics.
 - **Text**: Use this setting for documents that contain mostly text.
 - **Picture**: Use this setting for documents that contain mostly graphics.
5. To adjust the number of copies, press the Number of Copies  button.
6. Select the number of copies.
7. Press the Start Copy  button to start copying.



Touchscreen control panel

1. Load the document on the scanner glass according to the indicators on the product.
2. Close the scanner.
3. From the Home screen on the product control panel, touch the **Copy** button.
4. To optimize copy quality for different types of documents, touch the **Settings** button, and then scroll to and touch the **Optimize** button. Touch the arrow buttons to scroll through the options, and then touch an option to select it. The following copy-quality settings are available:
 - **Auto Select**: Use this setting when you are not concerned about the quality of the copy. This is the default setting.
 - **Mixed**: Use this setting for documents that contain a mixture of text and graphics.
 - **Text**: Use this setting for documents that contain mostly text.
 - **Picture**: Use this setting for documents that contain mostly graphics.
5. Touch the arrows to change the number of copies, or touch the existing number and type the number of copies.
6. Touch the **Start Copy** button to start copying.



Copy on both sides (duplex)

- [Copy on both sides automatically](#)
- [Copy on both sides manually](#)

Copy on both sides automatically

1. Load the original documents into the document feeder with the first page facing up, and with the top of the page leading.
2. Adjust the paper guides to fit the size of the document.
3. Open the Copy Settings menu:
 - **LCD control panel:** On the product control panel, press the Copy Settings  button.
 - **Touchscreen control panel:** From the Home screen on the product control panel, touch the [Copy](#) button, and then touch the [Settings](#) button.
4. Select [Two-Sided](#).
5. Use the arrow buttons to scroll through the options, and then select the appropriate option.
6. Start the copy job:
 - **LCD control panel:** Press the Start Copy  button.
 - **Touchscreen control panel:** Touch [Start Copy](#).

Copy on both sides manually

1. Place the document face-down on the scanner glass with the upper-left corner of the page in the upper-left corner of the glass. Close the scanner.
2. Open the Copy Settings menu:
 - **LCD control panel:** On the product control panel, press the Copy Settings  button.
 - **Touchscreen control panel:** From the Home screen on the product control panel, touch the [Copy](#) button, and then touch the [Settings](#) button.
3. Select [Two-Sided](#).
4. Use the arrow buttons to scroll through the options, and then select the appropriate option.
5. Start the copy job:
 - **LCD control panel:** Press the Start Copy  button.
 - **Touchscreen control panel:** Touch [Start Copy](#).
6. The product prompts to load the next original document. Place it on the glass, and then press or touch the [OK](#) button.
7. Repeat this process until you have scanned the last page.

6 Scan

- [Scan by using the HP Scan software \(Windows\)](#)
- [Scan by using the HP Scan software \(Mac\)](#)
- [Set up Scan to E-mail \(touchscreen models only\)](#)
- [Set up Scan to Network Folder \(touchscreen models only\)](#)
- [Scan to a USB flash drive \(touchscreen models only\)](#)
- [Scan to email \(touchscreen models only\)](#)
- [Scan to a network folder \(touchscreen models only\)](#)

For more information:

Go to www.hp.com/support/ljMFPM225, www.hp.com/support/ljMFPM226.

HP's all-inclusive help for the product includes the following information:

- Install and configure
- Learn and use
- Solve problems
- Download software updates
- Join support forums
- Find warranty and regulatory information

Scan by using the HP Scan software (Windows)

Use the HP Scan software to initiate scanning from software on your computer. You can save the scanned image as a file or send it to another software application.

1. Load the document in the document feeder or on the scanner glass according to the indicators on the product.
2. Click **Start**, and then click **Programs** (or **All Programs** in Windows XP).
3. Click **HP**, and then select your product.
4. Click **HP Scan**, select a scanning shortcut, and then adjust the settings if necessary.
5. Click **Scan**.



NOTE: Click **Advanced Settings** to gain access to more options.

Click **Create New Shortcut** to create a customized set of settings and save it in the list of shortcuts.

Scan by using the HP Scan software (Mac)

Use the HP Scan software to initiate scanning from software on your computer.

1. Load the document in the document feeder or on the scanner glass according to the indicators on the product.
2. Open **HP Scan**, which is located in the **Hewlett-Packard** folder inside the **Applications** folder.
3. Follow the on-screen instructions to scan the document.
4. When you have scanned all the pages, click **File** and then **Save** to save them to a file.

Set up Scan to E-mail (touchscreen models only)

Introduction

To use this scan feature, the product must be connected to a network. This scan feature is not available until you configure it. To configure this feature, use the Scan to Email Setup Wizard (Windows), which is installed in the HP program group for the product as part of the full software installation. You can also use the HP Embedded Web Server to configure this feature. The following instructions describe configuring the feature by using both the Scan to Email Setup Wizard and the HP Embedded Web Server.

- [Use the Scan to E-Mail Wizard \(Windows\)](#)
- [Set up the Scan to Email feature via the HP Embedded Web Server \(Windows\)](#)
- [Set up the Scan to Email feature via the HP Embedded Web Server \(OS X\)](#)

Use the Scan to E-Mail Wizard (Windows)

Some HP products include driver installation from a software CD. At the end of this installation is an option to set up additional features. The setup wizards include the options for basic configuration. To launch the wizard, click **Scan to E-mail Wizard**.

After installation, access the setup wizard by clicking the **Start** button, selecting the **Programs** or **All Programs** item, and then clicking the **HP** item. Click the product name item, and then click the **Scan to E-mail Wizard** to start the configuration process.

1. To add a new outgoing email address, click the **New** button.
2. Enter the email address. Click the **Next** button.
3. In the **Display Name** box, type the name to display for this email address, and then click **Next**.

 **NOTE:** To secure the email profile, enter a 4-digit PIN. After a security PIN is assigned to a profile, the PIN must be entered on the product control panel before the product can send an email using that profile.

4. Enter the name or the IP address of the SMTP server and the SMTP server port number. If the outgoing SMTP server requires additional security authentication, click the check box labeled **E-mail Log-in Authentication** and enter the required User ID and Password. Click the **Next** button when finished.

 **NOTE:** If you do not know the SMTP server name, SMTP port number, or authentication information, contact the email/Internet service provider or system administrator for the information. SMTP server names and port names are typically easy to find by doing an Internet search. For example, use terms like “gmail smtp server name” or “yahoo smtp server name” to search.

5. Review the information and verify all the settings are correct. If there is an error, click the **Back** button to correct the error. When finished, click the **Save and Test** button to test the configuration and finish the setup.

 **NOTE:** Create additional outgoing email profiles to scan from more than one email account.

Set up the Scan to Email feature via the HP Embedded Web Server (Windows)

1. Open the HP Embedded Web Server (EWS):

- a. From the Home screen on the product control panel, touch the Network  button to display the IP address or host name.
- b. Open a Web browser, and in the address line, type the IP address or host name exactly as it displays on the product control panel. Press the **Enter** key on the computer keyboard. The EWS opens.

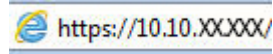

2. Click the **Scan** tab.
3. On the left navigation pane, click the **Scan to E-mail Setup** link.
4. On the **Scan to E-mail Setup** page, there is a list of settings to configure. These settings are also listed in the left navigation pane. To start, click the **Outgoing E-mail Profiles** link.
5. On the **Outgoing E-mail Profiles** page, click the **New** button.
 - In the **E-mail Address** area, enter the email address and display name.
 - In the **SMTP Server Settings** area, enter the SMTP server address and SMTP Port. The default port is already entered and in most cases does not need to be changed.

 **NOTE:** If you are using Google™ Gmail for email service, click the **Always use secure connection (SSL/TLS)** check box.

- In the **SMTP Authentication** area, click the checkbox **SMTP server requires authentication for outgoing e-mail messages** to configure the SMTP User ID and Password if required.

Ask your network administrator or your Internet service provider for the SMTP server setting information. If the SMTP server requires authentication, you also need to know the SMTP User ID and password. SMTP server names and port names are typically easy to find by doing an Internet search. For example, use terms like “gmail smtp server name” or “yahoo smtp server name”
- In the **Optional PIN** area, enter a PIN. This pin will be required every time an email is sent using the email address.
- In the **E-mail Message Preferences** area, configure the message preferences.

Review all the information, then click **Save and Test** to save the information and test the connection, or **Save Only** to save the information only.

6. To add email addresses to the address book accessible from the product, click the **E-mail Address Book** link and enter the required information. You can set up individual email addresses or email groups.
7. To configure default options, click the **E-mail options** link. Enter the default email subject, body text, and other scan settings.



Set up the Scan to Email feature via the HP Embedded Web Server (OS X)

1. Use one of the following methods to open the Embedded Web Server (EWS) interface.

Use a Web browser to open the HP Embedded Web Server (EWS)

- a. From the Home screen on the product control panel, touch the Network  button to display the IP address or host name.
- b. Open a Web browser, and in the address line, type the IP address or host name exactly as it displays on the product control panel. Press the **return** key on the computer keyboard. The EWS opens.

Use HP Utility to open the HP Embedded Web Server (EWS)

- a. Use either of these methods to open HP Utility:
 - Open **Applications**, and then open the **Hewlett-Packard** folder. Select **HP Utility**.
 - From the Apple menu, open **System Preferences**, and then select **Print & Fax**, **Print & Scan**, or **Printers & Scanners**. Select the product from the list of printers in the left pane. Click **Options & Supplies**, click the **Utility** tab, and then click **Open Printer Utility**.
 - b. In HP Utility, select **Scan to E-mail**.
 - c. Click **Begin Scan to E-mail Setup**. The EWS opens.
2. In the EWS, click the **Scan** tab.
 3. On the left navigation pane, click the **Scan to E-mail Setup** link.
 4. On the **Scan to E-mail Setup** page, there is a list of settings to configure. These settings are also listed in the left navigation pane. To start, click the **Outgoing E-mail Profiles** link.
 5. On the **Outgoing E-mail Profiles** page, click the **New** button.
 - In the **E-mail Address** area, enter the email address and display name.
 - In the **SMTP Server Settings** area, enter the SMTP server address and SMTP Port. The default port is already entered and in most cases does not need to be changed.
-
-  **NOTE:** If you are using Google™ Gmail for email service, click the **Always use secure connection (SSL/TLS)** check box.
-
- In the **SMTP Authentication** area, click the checkbox labeled **SMTP server requires authentication for outgoing e-mail messages** to configure the SMTP User ID and Password if required.
-
-  **NOTE:** Ask your network administrator or your Internet service provider for the SMTP server setting information. If the SMTP server requires authentication, you also need to know the SMTP User ID and password. SMTP server names and port names are typically easy to find by doing an Internet search. For example, use terms like “gmail smtp server name” or “yahoo smtp server name”.
-
- In the **Optional PIN** area, enter a PIN. This pin will be required every time an email is sent using the email address.
 - In the **E-mail Message Preferences** area, configure the message preferences.
6. To add email addresses to the address book accessible from the product, click the **E-mail Address Book** link and enter the required information. You can set up individual email addresses or email groups.

7. To configure default options, click the **E-mail options** link. Enter the default email subject, body text, and other scan settings.
8. Click **Save and Test** to complete the setup.



NOTE: Create additional outgoing email profiles to scan from more than one email account.

Set up Scan to Network Folder (touchscreen models only)

Introduction

To use this scan feature, the product must be connected to a network. This scan feature is not available until you configure it. To configure this feature, use the Scan to Network Folder Setup Wizard (Windows), which is installed in the HP program group for the product as part of the full software installation. You can also use the HP Embedded Web Server to configure these features. The following instructions describe configuring the feature by using both the Scan to Network Folder Wizard and the HP Embedded Web Server.

- [Use the Scan to Network Folder Setup Wizard \(Windows\)](#)
- [Set up the Scan to Network Folder feature via the HP Embedded Web Server \(Windows\)](#)
- [Set up the Scan to Network Folder feature via the HP Embedded Web Server \(OS X\)](#)

Use the Scan to Network Folder Setup Wizard (Windows)

Some HP products include driver installation from a software CD. At the end of this installation is an option to set up additional functionality. The setup wizards include the options for basic configuration. To launch the wizard, click **Scan to Network Folder Wizard**.

After installation, access the setup wizard by clicking the **Start** button, selecting the **Programs** or **All Programs** item, and then clicking the **HP** item. Click the product name item, and then click the **Scan to Network Folder Wizard** to start the configuration process.

1. To add a new network folder, click the **New** button.
2. On the **Start** screen, enter the name for the folder that will display on the product control panel in the **Display Name** field.
3. Click **Browse** to select an existing network folder, or click **Share Path** to set up a new shared network folder. If you select **Share Path**, The **Manage Network Shares** dialog opens. Use this dialog to configure the share settings, and then click **OK** to return to the **Start** screen.
4. To secure the folder, provide a 4-digit security PIN. Click **Next**.
5. On the **Authenticate** screen, provide the authentication credentials, and then click **Next**.
6. On the **Configure** screen, provide default settings for scan jobs saved to this folder. Click **Next**.
7. On the **Finish** screen, review the information and verify all the settings are correct. If there is an error, click the **Back** button to correct the error. When finished, click the **Save and Test** button to test the configuration and finish the setup.

Set up the Scan to Network Folder feature via the HP Embedded Web Server (Windows)

1. Open the HP Embedded Web Server (EWS):
 - a. From the Home screen on the product control panel, touch the Network  button to display the IP address or host name.

- b. Open a Web browser, and in the address line, type the IP address or host name exactly as it displays on the product control panel. Press the **Enter** key on the computer keyboard. The EWS opens.



2. Click the **Scan** tab.
 3. On the left navigation pane, click the **Network Folder Setup** link.
 4. On the **Network Folder Configuration** page, click the **New** button.
 - a. In the **Network Folder Information** section, enter the Display Name and Network Path. If required, enter the network Username and Password.
-  **NOTE:** The network folder must be shared for this feature to work. It can be shared for only you or for other users.
- b. Optional: To secure the folder from unauthorized access, enter a PIN in the **Secure the Folder Access with a PIN** section. This PIN will be required every time someone uses the scan to network folder feature.
 - c. In the **Scan Settings** section, adjust the scan settings.

Review all the information, then click **Save and Test** to save the information and test the connection, or **Save Only** to save the information only.

Set up the Scan to Network Folder feature via the HP Embedded Web Server (OS X)

1. Use one of the following methods to open the Embedded Web Server (EWS) interface.

Use a Web browser to open the HP Embedded Web Server (EWS)

- a. From the Home screen on the product control panel, touch the Network  button to display the IP address or host name.
- b. Open a Web browser, and in the address line, type the IP address or host name exactly as it displays on the product control panel. Press the **return** key on the computer keyboard. The EWS opens.

Use HP Utility to open the HP Embedded Web Server (EWS)

- a. Use either of these methods to open HP Utility:
 - Open **Applications**, and then open the **Hewlett-Packard** folder. Select **HP Utility**.
 - From the Apple menu, open **System Preferences**, and then select **Print & Fax**, **Print & Scan**, or **Printers & Scanners**. Select the product from the list of printers in the left pane. Click **Options & Supplies**, click the **Utility** tab, and then click **Open Printer Utility**.
- b. In HP Utility, select **Scan to Network Folder**.

- c. Follow the instructions in HP Utility to configure a shared network folder. Click the **Help Me Do This** button for detailed instructions.
 - d. Click the **Register My Shared Folder** button. The EWS opens.
 2. In the EWS, click the **Scan** tab.
 3. On the left navigation pane, click the **Network Folder Setup** link.
 4. Click the **New** button under **Network Folder Configuration**.
 - In the **Network Folder Information** section, enter the Display Name and Network Path. If required, enter the network Username and Password.
 - In the **Secure the Folder Access with a PIN** section, enter the PIN.
 5. Review all the information, then click **Save and Test** to save the information and test the connection, or **Save Only** to save the information only.



NOTE: You can assign a 4-digit security PIN to prevent unauthorized persons from saving scans to the network folder. The PIN must be entered on the product control panel each time a scan is performed.

- In the **Scan Settings** section, adjust the scan settings.



NOTE: To create additional network folders, repeat these steps for each folder.

Scan to a USB flash drive (touchscreen models only)

1. Load the document on the scanner glass according to the indicators on the product.

 **NOTE:** For best results, load small-size paper (letter, A4, or smaller) with the long edge of the paper along the left side of the scanner glass.

2. Insert a USB flash drive into the walk-up USB port.
3. From the Home screen on the product control panel, touch the [Scan](#) button.
4. Touch the [Scan to USB Drive](#) screen.
5. Touch the [Scan](#) button to scan and save the file. The product creates a folder named **HPSCANS** on the USB drive, and it saves the file in .PDF or .JPG format using an automatically generated file name.

 **NOTE:** When the summary screen opens, you can touch it to adjust settings.

You also can change the folder name.

Scan to email (touchscreen models only)

Use the product control panel to scan a file directly to an email address. The scanned file is sent to the address as an email message attachment.



NOTE: In order to use this feature, the product must be connected to a network and the Scan to Email feature must be configured by using the Scan to Email Setup Wizard (Windows) or the HP Embedded Web Server.

1. Load the document on the scanner glass according to the indicators on the product.
2. From the Home screen on the product control panel, touch the [Scan](#) button.
3. Touch the [Scan to E-mail](#) item.
4. Touch the [Send an E-mail](#) item.
5. Select the [From](#) address that you want to use. This is also known as an “outgoing email profile.”



NOTE: If the PIN feature has been set up, enter the PIN and touch the [OK](#) button. However, a PIN is not required to use this feature.

6. Touch the [To](#) button and pick the address or group to which you want to send the file. Touch the [Done](#) button when finished.
7. Touch the [Subject](#) button if you would like to add a subject line
8. Touch the [Next](#) button.
9. The control panel screen displays the scan settings.
 - If you want to change any of the settings, touch the [Settings](#) button, and then change the settings.
 - If the settings are correct, go to the next step.
10. Touch the [Scan](#) button to start the scan job.

Scan to a network folder (touchscreen models only)

Use the product control panel to scan a document and save it to a folder on the network.



NOTE: In order to use this feature, the product must be connected to a network and the Scan to Network Folder feature must be configured by using the Scan to Network Folder Setup Wizard (Windows) or the HP Embedded Web Server.

1. Load the document on the scanner glass according to the indicators on the product.
2. From the Home screen on the product control panel, touch the [Scan](#) button.
3. Touch the [Scan to Network Folder](#) item.
4. In the list of network folders, select the folder to which you want to save the document.
5. The control panel screen displays the scan settings.
 - If you want to change any of the settings, touch the [Settings](#) button, and then change the settings.
 - If the settings are correct, go to the next step.
6. Touch the [Scan](#) button to start the scan job.

7 Fax

- [Set up to send and receive faxes](#)
- [Send a fax](#)

For more information:

Go to www.hp.com/support/ljMFPM225, www.hp.com/support/ljMFPM226.

HP's all-inclusive help for the product includes the following information:

- Install and configure
- Learn and use
- Solve problems
- Download software updates
- Join support forums
- Find warranty and regulatory information

Set up to send and receive faxes

- [Before starting](#)
- [Step 1: Identify the phone connection type](#)
- [Step 2: Set up the fax](#)
- [Step 3: Configure the fax time, date, and header](#)
- [Step 4: Run a fax test](#)
- [Step 5 \(Optional\): Configure settings for receiving digital faxes \(Windows\)](#)

Before starting

Make sure that the product was fully set up before connecting the fax service.

 **NOTE:** Use the telephone cable and any adapters that shipped with the product to connect the product to the telephone jack.

 **NOTE:** In countries/regions that use serial telephone systems, an adapter is shipped with the product. Use the adapter to connect other telecom devices to the same telephone jack the product is connected to.

Complete the instructions in each of the following four steps:

1. [Step 1: Identify the phone connection type on page 62.](#)
2. [Step 2: Set up the fax on page 63.](#)
3. [Step 3: Configure the fax time, date, and header on page 67.](#)
4. [Step 4: Run a fax test on page 68.](#)

Step 1: Identify the phone connection type

Review the following equipment and service types to determine which setup method to use. The method used depends on the equipment and services already installed on the phone system.

 **NOTE:** The product is an analog device. HP recommends using the product on a dedicated analog telephone line.

- **Dedicated phone line:** The product is the only piece of equipment or service connected to the phone line
- **Voice calls:** Voice and fax calls use the same phone line
- **Answering machine:** An answering machine answers voice calls on the same phone line used for fax calls
- **Voice mail:** A voice-mail subscription service uses the same phone line as the fax
- **Distinctive ring service:** A service from the telephone company that allows several phone numbers to be associated with one phone line, and each number has a different ring pattern; the product detects the ring pattern assigned to it and answers the call
- **Computer dial-up modem:** A computer uses the phone line to connect to the Internet through a dial-up connection

- **DSL line:** A digital subscriber line (DSL) service from the telephone company; this service might be called ADSL in some countries/regions
- **PBX or ISDN phone system:** A private branch exchange (PBX) phone system or an integrated services digital network (ISDN) system
- **VoIP phone system:** Voice over Internet protocol (VoIP) through an Internet provider

Step 2: Set up the fax

Click the link below that best describes the environment in which the product will be sending and receiving faxes, and follow the setup instructions.

- [Dedicated phone line on page 63](#)
- [Shared voice/fax line on page 64](#)
- [Shared voice/fax line with an answering machine on page 65](#)

 **NOTE:** Instructions for only three of the connection types are included here. For more information about connecting the product with other connection types, go to the support Web site for this product: www.hp.com/support/ljMFPM225, www.hp.com/support/ljMFPM226

 **NOTE:** This product is an analog fax device. HP recommends using the product on a dedicated analog telephone line. For a digital environment, such as DSL, PBX, ISDN, or VoIP, make sure to use the correct filters and configure the digital settings correctly. For more information, contact the digital service provider.

 **NOTE:** Do not connect more than three devices to the telephone line.

 **NOTE:** Voice mail is not supported with this product.

Dedicated phone line

Follow these steps to set up the product on a dedicated phone line with no additional services.

1. Connect the telephone cable to the fax port on the product and to the telephone jack on the wall.

 **NOTE:** Some countries/regions might require an adapter for the telephone cable that came with the product.

 **NOTE:** On some products, the fax port might be above the phone port. Refer to the icons on the product.

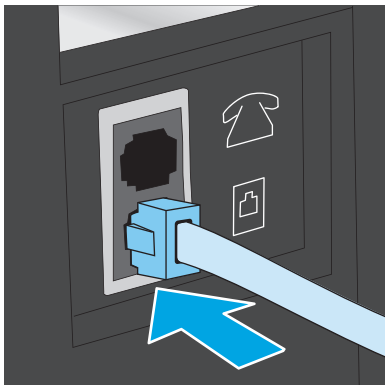

2. Set the product to answer fax calls automatically.

- a. Turn the product on.
 - b. On the product control panel, press or touch the Setup  button.
 - c. Open the **Fax Setup** menu.
 - d. Open the **Basic Setup** menu.
 - e. Select the **Answer Mode** setting.
 - f. Select the **Automatic** option.
3. Continue to [Step 3: Configure the fax time, date, and header on page 67](#).

Shared voice/fax line

Follow these steps to set up the product on a shared voice/fax line.

1. Disconnect any devices that are connected to the telephone jack.
2. Connect the telephone cable to the fax port on the product and to the telephone jack on the wall.

 **NOTE:** Some countries/regions might require an adapter to the telephone cable that came with the product.

 **NOTE:** On some products, the fax port might be above the phone port. Refer to the icons on the product.

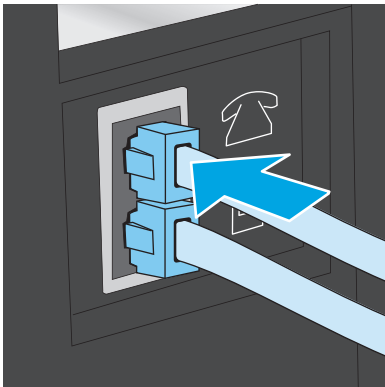

3. Remove the plug from the telephone line out port on the rear of the product, and then connect a phone to this port.
4. Set the product to answer fax calls automatically.
 - a. Turn the product on.
 - b. On the product control panel, press or touch the Setup  button.
 - c. Open the **Fax Setup** menu.
 - d. Open the **Basic Setup** menu.
 - e. Select the **Answer Mode** setting.
 - f. Select the **Automatic** option.

5. Set the product to check for a dial tone before sending a fax.

 **NOTE:** This prevents the product from sending a fax while someone is on the telephone.

- a. On the product control panel, press or touch the Setup  button.
 - b. Open the **Fax Setup** menu.
 - c. Open the **Advanced Setup** menu.
 - d. Select the **Detect Dial Tone** setting, and then select **On**.
6. Continue to [Step 3: Configure the fax time, date, and header on page 67](#).

Shared voice/fax line with an answering machine

Follow these steps to set up the product on a shared voice/fax line with an answering machine.

1. Disconnect any devices that are connected to the telephone jack.
2. Open the cover on the telephone-line-out port on the rear of the product.
3. Connect the telephone cable to the fax port on the product and to the telephone jack on the wall.

 **NOTE:** Some countries/regions might require an adapter for the telephone cable that came with the product.

 **NOTE:** On some products, the fax port might be above the phone port. Refer to the icons on the product.

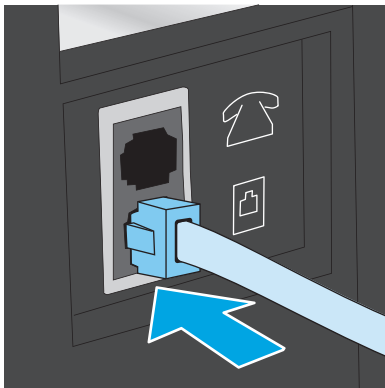



4. Connect the answering machine telephone cable to the telephone-line-out port on the rear of the product.

 **NOTE:** Connect the answering machine directly to the product, or the answering machine might record fax tones from a sending fax machine and the product might not receive faxes.

 **NOTE:** If the answering machine does not have a built-in telephone, connect a telephone to the **OUT** port on the answering machine for convenience.

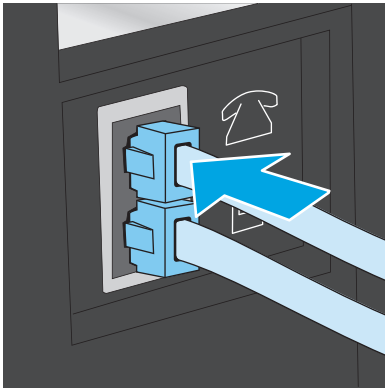
 **NOTE:** On some products, the fax port might be above the phone port. Refer to the icons on the product.



5. Configure the rings to answer setting on the product.
 - a. Turn the product on.
 - b. On the product control panel, press or touch the Setup  button.
 - c. Open the **Fax Setup** menu.
 - d. Open the **Basic Setup** menu.
 - e. Select the **Rings to Answer** option.
 - f. Use the numeric keypad on the product control panel to set the number of rings to 5 or more.

6. Set the product to answer fax calls automatically.
 - a. On the product control panel, press or touch the Setup  button.
 - b. Open the **Fax Setup** menu.
 - c. Open the **Basic Setup** menu.
 - d. Select the **Answer Mode** setting.
 - e. Select the **Automatic** option.

7. Set the product to check for a dial tone before sending a fax.

 **NOTE:** This prevents the product from sending a fax while someone is on the telephone.

- a. On the product control panel, press or touch the Setup  button.
- b. Open the **Fax Setup** menu.

- c. Open the **Advanced Setup** menu.
 - d. Select the **Detect Dial Tone** setting, and then select **On**.
8. Continue to [Step 3: Configure the fax time, date, and header on page 67](#).

Step 3: Configure the fax time, date, and header

Configure the product fax settings using one of the following methods:

- [HP Fax Setup Wizard on page 67](#) (if the software is installed)
- [Product control panel on page 67](#)
- [HP Device Toolbox on page 68](#) (if the software is installed)
- [HP Embedded Web Server on page 68](#) (if the product is connected to a network)



NOTE: In the United States and many other countries/regions, setting the time, date, and other fax header information is a legal requirement.

HP Fax Setup Wizard

Access the Fax Setup Wizard after *initial* setup and software installation by following these steps.

1. Click **Start**, and then click **Programs**.
2. Click **HP**, click the name of the product, and then click **HP Fax Setup Wizard**.
3. Follow the on-screen instructions in the HP Fax Setup Wizard to configure the fax settings.
4. Continue to [Step 4: Run a fax test on page 68](#).

Product control panel

To use the control panel to set the date, time, and header, complete the following steps.

1. On the product control panel, press or touch the Setup  button.
2. Open the **Fax Setup** menu.
3. Open the **Basic Setup** menu.
4. Scroll to and open the **Time/Date** button.
5. Select the **12-hour clock** or **24-hour clock** option.
6. Use the keypad to enter the current time.



NOTE: For touchscreen control panels, touch the **123** button to open a keypad that contains special characters, if needed.

7. Select the date format.
8. Use the keypad to enter the current date.
9. Open the **Fax Header** menu.

10. Use the keypad to enter the fax number.

 **NOTE:** The maximum number of characters for the fax number is 20.

11. Use the keypad to enter the company name or header.

 **NOTE:** The maximum number of characters for the fax header is 25.

12. Continue to [Step 4: Run a fax test on page 68](#).

HP Device Toolbox

1. Click the **Start** button, and then click the **Programs** item.
2. Click your HP product group, and then click the **HP Device Toolbox** item.
3. Click the **Fax** tab.
4. Follow the on-screen instructions to configure the fax settings.
5. Continue to [Step 4: Run a fax test on page 68](#).

HP Embedded Web Server

1. Open the HP Embedded Web Server (EWS):
 - a. LCD control panels: On the product control panel, press the Setup  button. Open the **Network Setup** menu and then select **Show IP Address** to display the IP address or host name.

Touchscreen control panels: From the Home screen on the product control panel, touch the Network  button to display the IP address or host name.
 - b. Open a Web browser, and in the address line, type the IP address or host name exactly as it displays on the product control panel. Press the **Enter** key on the computer keyboard. The EWS opens.

 <https://10.10.XX.XXX/>

2. Click the **Fax** tab.
3. Follow the on-screen instructions to configure the fax settings.
4. Continue to [Step 4: Run a fax test on page 68](#).

Step 4: Run a fax test

Run a fax test to make sure that the fax is set up correctly.

1. On the product control panel, press or touch the Setup  button.
2. Scroll to and open the **Service** menu.
3. Open the **Fax Service** menu.
4. Select the **Run Fax Test** option. The product prints a test report.
5. Review the report.

- If the report indicates the product **passed the test**, the product is ready to send and receive faxes.
- If the report indicates the product **failed the test**, review the report for more information about fixing the problem. The fax troubleshooting checklist has more information on resolving fax problems.

Step 5 (Optional): Configure settings for receiving digital faxes (Windows)

The product can save incoming digital faxes to a computer folder. Use the HP Digital Fax Setup Wizard to configure the settings. This feature is available only for Windows.

1. Click **Start**, and then click **Programs**.
2. Click **HP**, click the name of the product, and then click **Digital Fax Setup Wizard**.
3. Follow the on-screen instructions to configure the settings.

Send a fax

- [Fax from the flatbed scanner](#)
- [Fax from the document feeder](#)
- [Send a fax using the HP software \(Windows\)](#)

Fax from the flatbed scanner

LCD control panels

1. Place the document face-down on the scanner glass.
2. On the product control panel, use the keypad to enter the fax number.
3. Press the Start Fax  button. The product starts the fax job.
4. If the document contains multiple pages, follow the control panel prompts to confirm and load additional pages.

Touchscreen control panels

1. Place the document face-down on the scanner glass.
2. From the Home screen on the product control panel, touch the **Fax** button.
3. Use the keypad to enter the fax number.
4. Touch the **Start Fax** button.
5. The product prompts you to confirm that you are sending from the scanner glass. Touch the **Yes** button.
6. The product prompts you to load the first page. Touch the **OK** button.
7. The product scans the first page and then prompts you to load another page. If the document has multiple pages, touch the **Yes** button. Continue this process until you have scanned all the pages.
8. When you have scanned the last page, touch the **No** button at the prompt. The product sends the fax.

Fax from the document feeder

1. Insert the originals into the document feeder face-up.

CAUTION: To prevent damage to the product, do not use an original that contains correction tape, correction fluid, paper clips, or staples. Also, do not load photographs, small originals, or fragile originals into the document feeder.

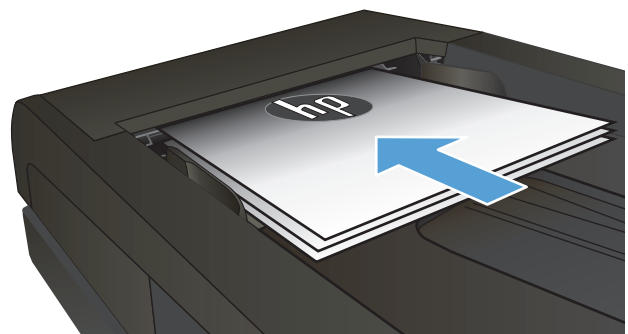

2. Adjust the paper guides until they are snug against the paper.

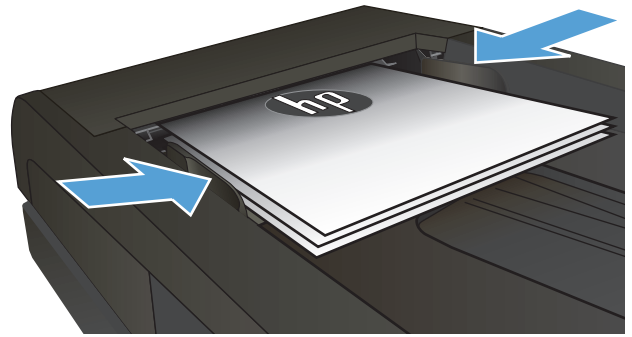

3. On the product control panel, use the keypad to enter the fax number.
4. Press the Start Fax button. The product starts the fax job.

1. Insert the originals into the document feeder face-up.

CAUTION: To prevent damage to the product, do not use an original that contains correction tape, correction fluid, paper clips, or staples. Also, do not load photographs, small originals, or fragile originals into the document feeder.

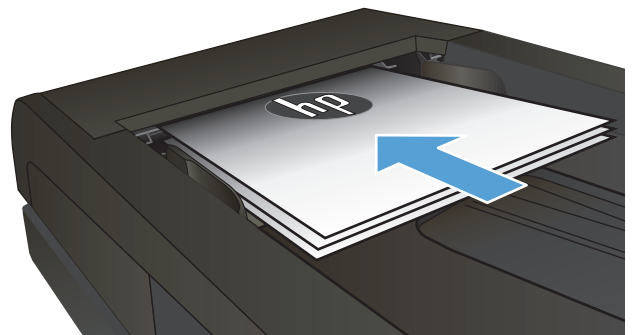

2. Adjust the paper guides until they are snug against the paper.

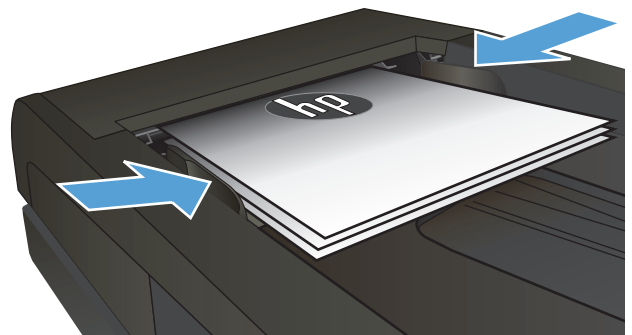

3. From the Home screen on the product control panel, touch the Fax button.
4. Use the keypad to enter the fax number.
5. Touch the Start Fax button.

Send a fax using the HP software (Windows)

1. Load the document.
 - If you are loading an original on the scanner glass, place it on the scanner glass face-down, in the left rear corner of the scanner glass.
 - If you are loading multiple pages in the document feeder, load the pages face-up, and then adjust the paper guides until they are snug against the paper.



NOTE: If documents are in the document feeder and on the scanner glass at the same time, the product processes the document in the document feeder and not the one on the scanner glass.

2. Click **Start**, click **Programs** (or **All Programs** in Windows XP), and then click **HP**.
3. Click the product name, and then click **HP Send Fax**. The fax software opens.
4. Enter the fax number of one or more recipients.
5. Click **Send Now**.

8 Manage the product

- [Use HP Web Services applications \(touchscreen models only\)](#)
- [Change the product connection type \(Windows\)](#)
- [Advanced configuration with HP Embedded Web Server \(EWS\) and HP Device Toolbox \(Windows\)](#)
- [Advanced configuration with HP Utility for Mac OS X](#)
- [Configure IP network settings](#)
- [HP Web Jetadmin](#)
- [Product security features](#)
- [Economy settings](#)
- [Update the firmware](#)

For more information:

Go to www.hp.com/support/ljMFPM225, www.hp.com/support/ljMFPM226.

HP's all-inclusive help for the product includes the following information:

- Install and configure
- Learn and use
- Solve problems
- Download software updates
- Join support forums
- Find warranty and regulatory information

Use HP Web Services applications (touchscreen models only)

Several innovative applications are available for this product that you can download directly from the Internet. For more information and to download these applications go to the HP Connected Web site at www.hpconnected.com.

To use this feature, the product must be connected to a computer or network that has an Internet connection. HP Web Services must be enabled on the product.

1. From the Home screen on the product control panel, touch the Web Services  button.
2. Touch the [Enable Web Services](#) button.

After you download an application from the HP Connected Web site, it is available in the [Apps](#) menu on the product control panel. This process enables both HP Web Services and the [Apps](#) menu.

Change the product connection type (Windows)

If you are already using the product and you wish to change the way it is connected, use the **Reconfigure your HP Device** shortcut on your computer desktop to change the connection. For example, you can reconfigure the product to use a different wireless address, to connect to a wired or wireless network, or change from a network connection to a USB connection. You can change the configuration without inserting the product CD. After you select the type of connection you wish to make, the program goes directly to the portion of the product setup procedure that needs to change.

Advanced configuration with HP Embedded Web Server (EWS) and HP Device Toolbox (Windows)

Use the HP Embedded Web Server to manage printing functions from your computer instead of the product control panel.

- View product status information
- Determine the remaining life for all supplies and order new ones
- View and change tray configurations
- View and change the product control-panel menu configuration
- View and print internal pages
- Receive notification of product and supplies events
- View and change network configuration

The HP Embedded Web Server works when the product is connected to an IP-based network. The HP Embedded Web Server does not support IPX-based product connections. You do not have to have Internet access to open and use the HP Embedded Web Server.

When the product is connected to the network, the HP Embedded Web Server is automatically available.

 **NOTE:** HP Device Toolbox is available only if you performed a full installation when you installed the product. Depending on how the product is connected, some features might not be available.

 **NOTE:** The HP Embedded Web Server is not accessible beyond the network firewall.

Open the HP Embedded Web Server (EWS) from the Start menu

1. Click the **Start** button, and then click the **Programs** item.
2. Click your HP product group, and then click the **HP Device Toolbox** item.

Open the HP Embedded Web Server (EWS) from a Web browser

1. LCD control panels: On the product control panel, press the Setup  button. Open the **Network Setup** menu and then select **Show IP Address** to display the IP address or host name.

Touchscreen control panels: From the Home screen on the product control panel, touch the Network  button to display the IP address or host name.

2. Open a Web browser, and in the address line, type the IP address or host name exactly as it displays on the product control panel. Press the **Enter** key on the computer keyboard. The EWS opens.

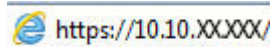
 <https://10.10.XX.XXX/>

Tab or section	Description
<p>Home tab</p> <p>Provides product, status, and configuration information.</p>	<ul style="list-style-type: none"> ● Device Status: Shows the product status and shows the approximate percent life remaining of HP supplies. ● Supplies Status: Shows the approximate percent life remaining of HP supplies. Actual supply life remaining can vary. Consider having a replacement supply available to install when print quality is no longer acceptable. The supply does not need to be replaced unless the print quality is no longer acceptable. ● Device Configuration: Shows the information found on the product configuration page. ● Network Summary: Shows the information found on the product network configuration page. ● Reports: Print the configuration and supplies status pages that the product generates. ● Event Log: Shows a list of all product events and errors.
<p>System tab</p> <p>Provides the ability to configure the product from your computer.</p>	<ul style="list-style-type: none"> ● Device Information: Provides basic product and company information. ● Paper Setup: Change the default paper-handling settings for the product. ● Print Quality: Change the default print-quality settings for the product. ● EcoSMART Console: Change the default times for entering Sleep mode or Auto Power Down mode. Configure which events cause the product to wake. ● Paper Types: Configure print modes that correspond to the paper types that the product accepts. ● System Setup: Change the system defaults for the product. ● Service: Perform the cleaning procedure on the product. ● Save and Restore: Save the current settings for the product to a file on the computer. Use this file to load the same settings onto another product or to restore these settings to this product at a later time. ● Administration: Set or change the product password. Enable or disable product features. <p>NOTE: The System tab can be password-protected. If this product is on a network, always consult with the administrator before changing settings on this tab.</p>
<p>Print tab</p> <p>Provides the ability to change default print settings from your computer.</p>	<ul style="list-style-type: none"> ● Printing: Change the default product print settings, such as number of copies and paper orientation. These are the same options that are available on the control panel. ● PCL5c: View and change the PCL5c settings. ● PostScript: Turn off or on the Print PS Errors feature.
<p>Fax tab</p> <p>(Fax products only)</p>	<ul style="list-style-type: none"> ● Receive Options: Configure how the product handles incoming faxes. ● Phone Book: Add or delete entries in the fax phone book. ● Junk Fax List: Set fax numbers to block from sending faxes to the product. ● Fax Activity Log: Review recent fax activity for the product.

Tab or section	Description
<p>Scan tab</p> <p>(touchscreen models only)</p>	<p>Configure the Scan to Network Folder and Scan to E-mail features.</p> <ul style="list-style-type: none"> • Network Folder Setup: Configure folders on the network to which the product can save a scanned file. • Scan to E-mail Setup: Begin the process to set up the Scan to E-mail feature. • Outgoing E-mail Profiles: Set an email address that will appear as the “from” address for all emails sent from the product. Configure the SMTP Server information. • E-mail Address Book: Add or delete entries in the email address book. • E-mail Options: Configure a default subject line and body text. Configure default scan settings for emails.
<p>Networking tab</p> <p>(Network-connected products only)</p> <p>Provides the ability to change network settings from your computer.</p>	<p>Network administrators can use this tab to control network-related settings for the product when it is connected to an IP-based network. It also allows the network administrator to set up Wireless Direct functionality. This tab does not appear if the product is directly connected to a computer.</p>
<p>HP Web Services tab</p>	<p>Use this tab to set up and use various Web tools with the product.</p>

Advanced configuration with HP Utility for Mac OS X

Use the HP Utility to check product status or to view or change product settings from your computer.

You can use the HP Utility when the product is connected with a USB cable or is connected to a TCP/IP-based network.

Open HP Utility

1. At the computer, open the **System Preferences** menu, and then click **Print & Fax, Print & Scan, or Printers & Scanners**.
2. Select the product in the list.
3. Click the **Options & Supplies** button.
4. Click the **Utility** tab.
5. Click the **Open Printer Utility** button.

HP Utility features

The HP Utility toolbar includes these items:

- **Devices:** Click this button to show or hide Mac products found by the HP Utility.
- **All Settings:** Click this button to return to the HP Utility main view.
- **HP Support:** Click this button to open a browser and go to the HP support Web site.
- **Supplies:** Click this button to open the HP SureSupply Web site.
- **Registration:** Click this button to open the HP registration Web site.
- **Recycling:** Click this button to open the HP Planet Partners Recycling Program Web site.

HP Utility consists of pages that you open by clicking in the **All Settings** list. The following table describes the tasks that you can perform with HP Utility.

Menu	Description
Information And Support	<ul style="list-style-type: none">• Supplies Status: Show the product supplies status and provides links for ordering supplies online.• Device Information: Show information about the currently selected product, including the product Service ID (if assigned), the firmware version (FW Version), the Serial Number, and the IP address.• File Upload: Transfer files from the computer to the product. You can upload the following types of files:<ul style="list-style-type: none">◦ HP LaserJet printer command language (.PRN)◦ Portable document format (.PDF)

Menu	Description
	<ul style="list-style-type: none"> ◦ Postscript (.PS) ◦ Text (.TXT) • HP Connected: Access the HP Connected Web site. • Upload Fonts: Upload fonts from your computer to the product.
Printer Settings	<ul style="list-style-type: none"> • Auto-off: Configure the product to automatically turn off after a period of inactivity. You can adjust the number of minutes after which the product turns off. • Network Settings: Configure the network settings, such as the IPv4 settings, IPv6 settings, Bonjour settings, and other settings. • Supplies Management: Configure how the product should behave when supplies are nearing the end of their estimated life. • Trays Configuration: Change paper size and type for each of the trays. • Additional Settings: Open the HP Embedded Web Server (EWS) for the product. <p>NOTE: USB connections are not supported.</p>
Information	Message Center: Display error events that have occurred with the product.
Fax Settings (MFP fax models only)	<ul style="list-style-type: none"> • Basic Fax Settings: Set up the fields in the fax header and configure how the product answers incoming calls. • Junk Fax Blocking: Store the fax numbers you want to block. • Fax Forwarding: Set up the product to send the incoming faxes to a different number. • Fax Logs: View the logs of all faxes. • Fax Speed Dials: Add fax numbers to the speed dial list.
Scan Settings (MFP touchscreen models only)	<ul style="list-style-type: none"> • Scan to E-mail: Open the HP Embedded Web Server (EWS) page for configuring settings for scanning to email. • Scan to Network Folder: Open the HP Embedded Web Server (EWS) page for configuring settings for scanning to a network folder. <p>NOTE: USB connections are not supported.</p>

Configure IP network settings

- [Printer sharing disclaimer](#)
- [View or change network settings](#)
- [Rename the product on a network](#)
- [Manually configure IPv4 TCP/IP parameters from the control panel](#)

Printer sharing disclaimer

HP does not support peer-to-peer networking, as the feature is a function of Microsoft operating systems and not of the HP printer drivers. Go to Microsoft at www.microsoft.com.

View or change network settings

Use the HP Embedded Web Server to view or change IP configuration settings.

1. LCD control panels: On the product control panel, press the Setup  button. Open the **Network Setup** menu and then select **Show IP Address** to display the IP address or host name.

Touchscreen control panels: From the Home screen on the product control panel, touch the Network  button to display the IP address or host name.

2. Click the **Networking** tab to obtain network information. Change settings as needed.

Rename the product on a network

If you want to rename the product on a network so that it can be uniquely identified, use the HP Embedded Web Server.

1. Open the HP Embedded Web Server (EWS):
 - a. LCD control panels: On the product control panel, press the Setup  button. Open the **Network Setup** menu and then select **Show IP Address** to display the IP address or host name.

Touchscreen control panels: From the Home screen on the product control panel, touch the Network  button to display the IP address or host name.

- b. Open a Web browser, and in the address line, type the IP address or host name exactly as it displays on the product control panel. Press the **Enter** key on the computer keyboard. The EWS opens.

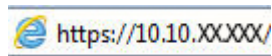

2. Open the **System** tab.
3. On the **Device Information** page, the default product name is in the **Device Status** field. You can change this name to uniquely identify this product.

 **NOTE:** Completing the other fields on this page is optional.

4. Click the **Apply** button to save the changes.

Manually configure IPv4 TCP/IP parameters from the control panel

Use the control-panel menus to manually set an IPv4 address, subnet mask, and default gateway.

1. On the product control panel, press or touch the Setup  button.
2. Scroll to and open the [Network Setup](#) menu.
3. Open the [IPv4 Config](#) menu, and then select [Manual](#).
4. Use the keypad to enter the IP address, and press or touch the [OK](#) button.
5. Use the keypad to enter the subnet mask, and press or touch the [OK](#) button.
6. Use the keypad to enter the default gateway, and press or touch the [OK](#) button.

HP Web Jetadmin

HP Web Jetadmin is an award-winning, industry-leading tool for efficiently managing a wide variety of networked HP products, including printers, multifunction products, and digital senders. This single solution allows you to remotely install, monitor, maintain, troubleshoot, and secure your printing and imaging environment — ultimately increasing business productivity by helping you save time, control costs, and protect your investment.

HP Web Jetadmin upgrades are periodically made available to provide support for specific product features. Go to www.hp.com/go/webjetadmin and click the **Self Help and Documentation** link to learn more about upgrades.

Product security features

The product supports security standards and recommended protocols that help you keep the product secure, protect critical information on your network, and simplify the way you monitor and maintain the product.

For in-depth information about HP's secure imaging and printing solutions, visit www.hp.com/go/secureprinting. The site provides links to white papers and FAQ documents about security features.

Set or change the product password using the HP Embedded Web Server

Use the HP Embedded Web Server to set a password or change an existing password for a product on a network.

1. Open the HP Embedded Web Server (EWS):
 - a. LCD control panels: On the product control panel, press the Setup  button. Open the **Network Setup** menu and then select **Show IP Address** to display the IP address or host name.

Touchscreen control panels: From the Home screen on the product control panel, touch the Network  button to display the IP address or host name.
 - b. Open a Web browser, and in the address line, type the IP address or host name exactly as it displays on the product control panel. Press the **Enter** key on the computer keyboard. The EWS opens.

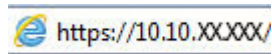

2. Click the **System** tab, and click either the **Product Security** or the **Administration** link.

 **NOTE:** If a password has previously been set, you are prompted to provide the password. Enter the password, and then click the **Apply** button.

3. Enter the new password in the **Password** box and in the **Confirm Password** box.
4. At the bottom of the window, click the **Apply** button to save the password.

 **NOTE:** For products connected with a USB cable to a Windows computer, use the HP Device Toolbox to change the product password:

1. Click the **Start** button, and then click the **Programs** item.
 2. Click your HP product group, and then click the **HP Device Toolbox** item.
 3. Click the **System** tab.
 4. Click **Administration**, and locate the area to change the password.
-

Economy settings

- [Print with EconoMode](#)
- [Configure the Sleep/Auto Off After setting](#)

Print with EconoMode

This product has an EconoMode option for printing drafts of documents. Using EconoMode can use less toner. However, using EconoMode can also reduce print quality.

HP does not recommend the full-time use of EconoMode. If EconoMode is used full-time, the toner supply might outlast the mechanical parts in the toner cartridge. If print quality begins to degrade and is no longer acceptable, consider replacing the toner cartridge.



NOTE: If this option is not available in your print driver, you can set it using the HP Embedded Web Server.

1. From the software program, select the **Print** option.
2. Select the product, and then click the **Properties** or **Preferences** button.
3. Click the **Paper/Quality** tab.
4. Click the **EconoMode** check box.

Configure the Sleep/Auto Off After setting

LCD control panel

1. On the product control panel, press the Setup button.
2. Open the following menus:
 - **System Setup**
 - **Energy Settings**
 - **Sleep/Auto Off**
 - **Sleep/Auto Off After**
3. Use the arrow keys to select the time for the Sleep/Auto Off delay, and then press the **OK** button.



NOTE: The default value is **15 Minutes**.

4. The product automatically wakes when it receives jobs or when you press a button on the product control panel. You can change which events cause the product to wake. Open the following menus:
 - **System Setup**
 - **Energy Settings**
 - **Sleep/Auto Off**
 - **Wake Events**

To turn off a wake event, select the event, and then select the **No** option.

Touchscreen control panel

1. From the Home screen on the product control panel, touch the Setup  button.
2. Open the following menus:
 - System Setup
 - Energy Settings
 - Sleep/Auto Off
 - Sleep/Auto Off After
3. Select the time for the Sleep/Auto Off delay.



NOTE: The default value is 15 Minutes.

4. The product automatically wakes when it receives jobs or when you touch the screen on the product control panel. You can change which events cause the product to wake. Open the following menus:
 - System Setup
 - Energy Settings
 - Sleep/Auto Off
 - Wake Events

Active wake events have a blue square next to the name. To turn off a wake event, touch the name of the event. The blue square changes to black. Touch the **Done** button.

Update the firmware

HP offers periodic product updates, new Web Services apps, and new features to existing Web Services apps. Follow these steps to update the product firmware for a single product. When you update the firmware, Web Service apps will update automatically.

There are two supported methods to perform a firmware update on this product. Use only one of the following methods to update the product firmware.

Method one: Update the firmware using the control panel

Use these steps to load the firmware from the control panel (for network-connected products only), and/or set the product to automatically load future firmware updates. For USB-connected products, skip to method two.

1. Make sure the product is connected to a wired (Ethernet) or wireless network with an active Internet connection.



NOTE: The product must be connected to the internet to update the firmware via a network connection.

2. From the Home screen on the product control panel, open the [Setup](#) menu.

- For touchscreen control panels, touch the Setup  button.
- For standard control panels, press the left or right arrow button.

3. Scroll to and open the [Service](#) menu, and then open the [LaserJet Update](#) menu.



NOTE: If the [LaserJet Update](#) option is not listed, use method two.

4. Check for updates.

- For touchscreen control panels, touch [Check for Updates Now](#).
- For standard control panels, select **Check for Update**.



NOTE: The product automatically checks for an update, and if a newer version is detected, the update process automatically starts.

5. Set the product to automatically update the firmware when updates become available.

From the Home screen on the product control panel, open the [Setup](#) menu.

- For touchscreen control panels, touch the Setup  button.
- For standard control panels, press the left or right arrow button.

Scroll to and open the [Service](#) menu, open the [LaserJet Update](#) menu, and then select the [Manage Updates](#) menu.

Set the product to automatically update the firmware.

- For touchscreen control panels, set the [Allow Updates](#) option to **YES**, and then set the [Check automatically](#) option to **ON**.
- For standard control panels, set the **Allow Updates** option to **YES**, and then set the **Automatic Check** option to **ON**.

Method two: Update the firmware using the Firmware Update Utility

Use these steps to manually download and install the Firmware Update Utility from HP.com.



NOTE: This method is the only firmware update option available for products connected to the computer via a USB cable. It also works for products connected to a network.

1. Go to www.hp.com/go/support, click the **Drivers & Software** link, type the product name in the search field, press the **ENTER** button, and then select the product from the list of search results.
2. Select the operating system.
3. Under the **Firmware** section, locate the **Firmware Update Utility**.
4. Click **Download**, click **Run**, and then click **Run** again.
5. When the utility launches, select the product from the drop-down list, and then click **Send Firmware**.



NOTE: To print a configuration page to verify the installed firmware version before or after the update process, click **Print Config**.

6. Follow the on-screen instructions to complete the installation, and then click the **Exit** button to close the utility.

9 Solve problems

- [Customer support](#)
- [Control panel help system \(touchscreen models only\)](#)
- [Restore the factory-set defaults](#)
- [A Cartridge is low or Cartridge is very low message displays on the product control panel](#)
- [Product does not pick up paper or misfeeds](#)
- [Clear jams](#)
- [Improve print quality](#)
- [Improve copy and scan quality](#)
- [Improve fax image quality](#)
- [Solve wired network problems](#)
- [Solve wireless network problems](#)
- [Solve fax problems](#)

For more information:

Go to www.hp.com/support/ljMFPM225, www.hp.com/support/ljMFPM226.

HP's all-inclusive help for the product includes the following information:

- Install and configure
- Learn and use
- Solve problems
- Download software updates
- Join support forums
- Find warranty and regulatory information

Customer support

Get telephone support for your country/region	Country/region phone numbers are on the flyer that was in the box with your product or at www.hp.com/support/ .
Have the product name, serial number, date of purchase, and problem description ready.	
Get 24-hour Internet support	www.hp.com/support/ljMFPM225 , www.hp.com/support/ljMFPM226
Download software utilities, drivers, and electronic information	www.hp.com/support/ljMFPM225 , www.hp.com/support/ljMFPM226
Order additional HP service or maintenance agreements	www.hp.com/go/carepack
Register your product	www.register.hp.com

Control panel help system (touchscreen models only)

The product has a built-in Help system that explains how to use each screen. To open the Help system, touch the Help ? button in the upper-right corner of the screen.

For some screens, the Help opens to a global menu where you can search for specific topics. You can browse through the menu structure by touching the buttons in the menu.

Some Help screens include animations that guide you through procedures, such as clearing jams.

For screens that contain settings for individual jobs, the Help opens to a topic that explains the options for that screen.

If the product alerts you of an error or warning, touch the Help ? button to open a message that describes the problem. The message also contains instructions to help solve the problem.

Restore the factory-set defaults

Restoring the factory-set defaults returns all of the product and network settings to the factory defaults. It will not reset the page count, tray size, or language. To restore the product to the factory-default settings, follow these steps.

 **CAUTION:** Restoring the factory-set defaults returns all of the settings to the factory defaults, and it also deletes any pages that are stored in the memory.

1. On the product control panel, press or touch the Setup  button.
2. Open the **Service** menu.
3. Select the **Restore Defaults** option, and then press or touch the **OK** button.

The product automatically restarts.

A Cartridge is low or Cartridge is very low message displays on the product control panel

A **Cartridge is low** or **Cartridge is very low** message displays on the product control panel, and the product does not print.

 **NOTE:** Toner level warnings and indicators provide estimates for planning purposes only. When an indicator shows low-toner levels, consider having a replacement cartridge available to avoid possible printing delays. You do not need to replace cartridges until print quality becomes unacceptable.

Once an HP toner cartridge has reached “very low”, HP’s Premium Protection Warranty on that toner cartridge has ended.

You can change the way the product reacts when supplies reach the Very Low state. You do not have to re-establish these settings when you install a new toner cartridge.

Enable or disable the Very Low settings

You can enable or disable the default settings at any time, and you do not have to re-enable them when you install a new toner cartridge.

LCD control panel

1. On the product control panel, press the Setup  button.
2. Open the following menus:
 - **System Setup**
 - **Supply Settings**
 - **Black Cartridge**
 - **Very Low Setting**
3. Select one of the following options, and then press the **OK** button:
 - Select the **Stop** option to set the product to stop printing until you replace the toner cartridge.
 - Select the **Prompt** option to set the product to stop printing and prompt you to replace the toner cartridge. You can acknowledge the prompt and continue printing.
 - Select the **Continue** option to set the product to alert you that the toner cartridge is very low, but to continue printing.

Touchscreen control panel

1. From the Home screen on the product control panel, touch the Setup  button.
2. Open the following menus:
 - **System Setup**
 - **Supply Settings**

- [Black Cartridge](#)
 - [Very Low Setting](#)
3. Select one of the following options:
- Select the [Stop](#) option to set the product to stop printing until you replace the toner cartridge.
 - Select the [Prompt](#) option to set the product to stop printing and prompt you to replace the toner cartridge. You can acknowledge the prompt and continue printing.
 - Select the [Continue](#) option to set the product to alert you that the toner cartridge is very low, but to continue printing.

For models with fax, when the product is set to the [Stop](#) option there is some risk that faxes will not print after the new cartridge is installed if your product has received more faxes than the memory can hold while stopped.

For models with fax, when the product is set to the [Prompt](#) option there is some risk that faxes will not print after the new cartridge is installed if your product has received more faxes than the memory can hold while the product is waiting for the prompt to be acknowledged.

Once an HP toner cartridge has reached **Very Low**, HP's Premium Protection Warranty on that toner cartridge has ended. All print defects or cartridge failures incurred when an HP toner cartridge is used in [Continue](#) at very low mode will not be considered to be defects in materials or workmanship in the toner cartridge under the HP Print Cartridge Warranty Statement.

Product does not pick up paper or misfeeds

- [The product does not pick up paper](#)
- [The product picks up multiple sheets of paper](#)
- [The document feeder jams, skews, or picks up multiple sheets of paper](#)
- [Clean the pickup rollers and separation pad in the document feeder](#)

The product does not pick up paper

If the product does not pick up paper from the tray, try these solutions.

1. Open the product and remove any jammed sheets of paper.
2. Load the tray with the correct size of paper for your job.
3. Make sure the paper size and type are set correctly on the product control panel.
4. Make sure the paper guides in the tray are adjusted correctly for the size of paper. Adjust the guides to the appropriate indentation in the tray.
5. Check the product control panel to see if the product is waiting for you to acknowledge a prompt to feed the paper manually. Load paper, and continue.
6. The rollers above the tray might be contaminated. Clean the rollers with a lint-free cloth dampened with warm water.

The product picks up multiple sheets of paper

If the product picks up multiple sheets of paper from the tray, try these solutions.

1. Remove the stack of paper from the tray and flex it, rotate it 180 degrees, and flip it over. *Do not fan the paper.* Return the stack of paper to the tray.
2. Use only paper that meets HP specifications for this product.
3. Use paper that is not wrinkled, folded, or damaged. If necessary, use paper from a different package.
4. Make sure the tray is not overfilled. If it is, remove the entire stack of paper from the tray, straighten the stack, and then return some of the paper to the tray.
5. Make sure the paper guides in the tray are adjusted correctly for the size of paper. Adjust the guides to the appropriate indentation in the tray.
6. Make sure the printing environment is within recommended specifications.

The document feeder jams, skews, or picks up multiple sheets of paper

 **NOTE:** This information applies to MFP products only.

- The original might have something on it, such as staples or self-adhesive notes, that must be removed.
- Check that all rollers are in place and that the roller-access cover inside the document feeder is closed.
- Make sure that the top document-feeder cover is closed.

- The pages might not be placed correctly. Straighten the pages and adjust the paper guides to center the stack.
- The paper guides must be touching the sides of the paper stack to work correctly. Make sure that the paper stack is straight and the guides are against the paper stack.
- The document feeder input tray or output bin might contain more than the maximum number of pages. Make sure the paper stack fits below the guides in the input tray, and remove pages from the output bin.
- Verify that there are no pieces of paper, staples, paper clips, or other debris in the paper path.
- Clean the document-feeder rollers and the separation pad. Use compressed air or a clean, lint-free cloth moistened with warm water. If misfeeds still occur, replace the rollers.
- From the Home screen on the product control panel, scroll to and touch the [Supplies](#) button. Check the status of the document-feeder kit, and replace it if necessary.

Clean the pickup rollers and separation pad in the document feeder

If the document feeder experiences paper-handling problems, such as jams or multiple-page feeds, clean the document-feeder rollers and separation pad.

1. Lift the document-feeder input tray.

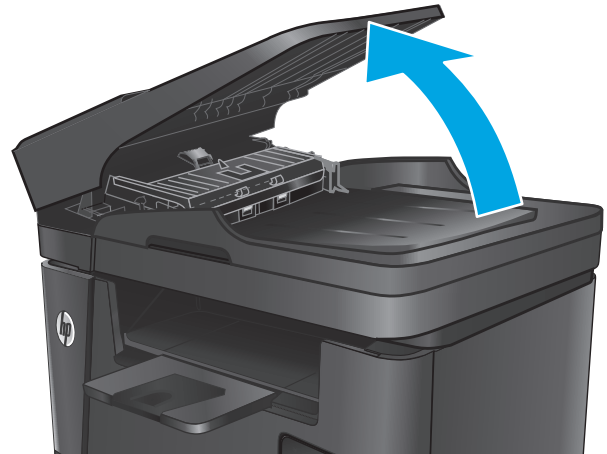

2. Use a moist, lint-free cloth to wipe both pickup rollers and the separation pad to remove dirt.

CAUTION: Do not use abrasives, acetone, benzene, ammonia, ethyl alcohol, or carbon tetrachloride on any part of the product; these can damage the product. Do not place liquids directly on the glass or platen. They might seep and damage the product.

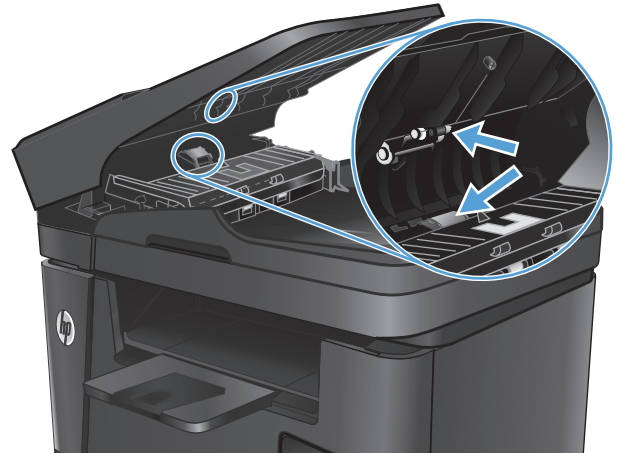

3. Close the document-feeder input tray.

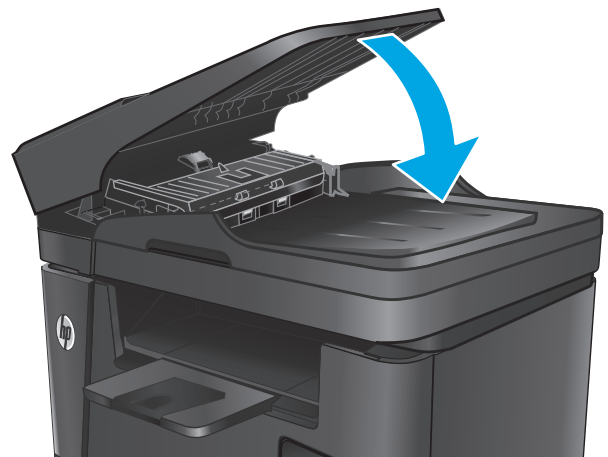

Clear jams

Jam locations

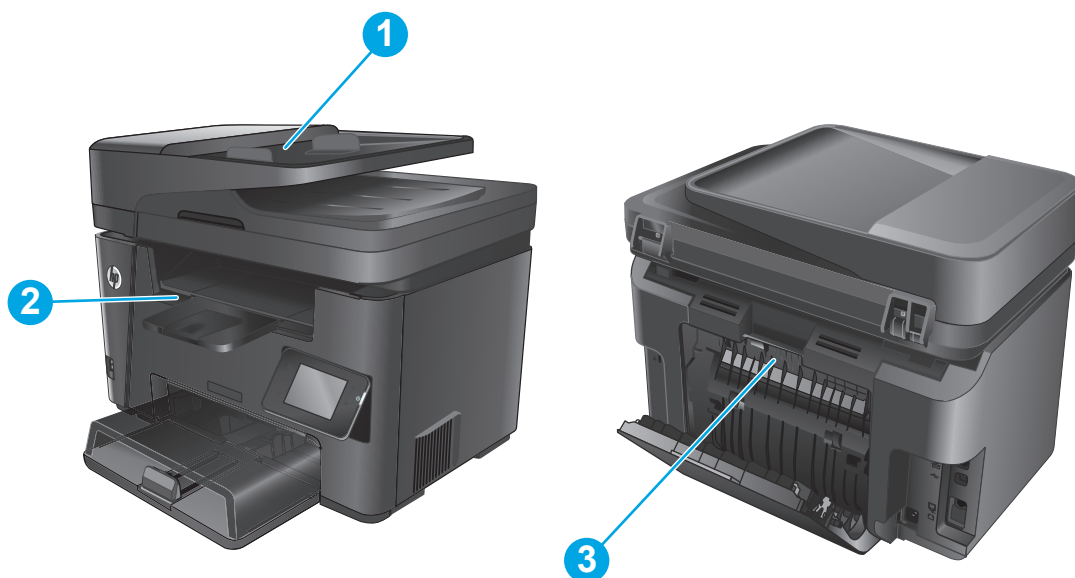

1	Document feeder	See Clear jams in the document feeder on page 100 .
2	Toner-cartridge area and output bin	See Clear jams in the toner-cartridge area on page 102 and Clear jams in the output bin on page 105 .
3	Duplex area	See Clear jams in the duplexer on page 108 .

Experiencing frequent or recurring paper jams?

Follow these steps to solve problems with frequent paper jams. If the first step does not resolve the problem continue with the next step until you have resolved the problem.

1. If paper has jammed in the product, clear the jam and then print a configuration page to test the product.
2. Check that the tray is configured for the correct paper size and type on the product control panel. Adjust paper settings if necessary.
 - a. On the product control panel, press or touch the Setup  button.
 - b. Open the [System Setup](#) menu.
 - c. Open the [Paper setup](#) menu.
 - d. Select the tray from the list.
 - e. Select [Paper Type](#) and then select the type of paper that is in the tray.
 - f. Select [Paper Size](#) and then select the size of paper that is in the tray.

3. Turn the product off, wait 30 seconds, and then turn it on again.
4. Print a cleaning page to remove excess toner from inside the product.
 - a. On the product control panel, press or touch the Setup  button.
 - b. Open the [Service](#) menu.
 - c. Select [Cleaning Page](#).
 - d. Load plain letter or A4 paper when you are prompted.
 - e. Touch the [OK](#) button to begin the cleaning process.

The product prints the first side and then prompts you to remove the page from the output bin and reload it in Tray 1, keeping the same orientation. Wait until the process is complete. Discard the page that prints.

5. Print a configuration page to test the product.
 - a. On the product control panel, press or touch the Setup  button.
 - b. Open the [Reports](#) menu.
 - c. Select [Configuration Report](#).

If none of these steps resolves the problem, the product might need service. Contact HP customer support.

Clear jams in the document feeder

A **Jam in the document feeder** message displays on the product control panel.

1. Remove any loose paper from the document feeder input tray that has not fed into the product.
2. Remove any jammed paper visible in the input tray area. Use both hands to slowly pull out the jammed paper to avoid tearing the paper.

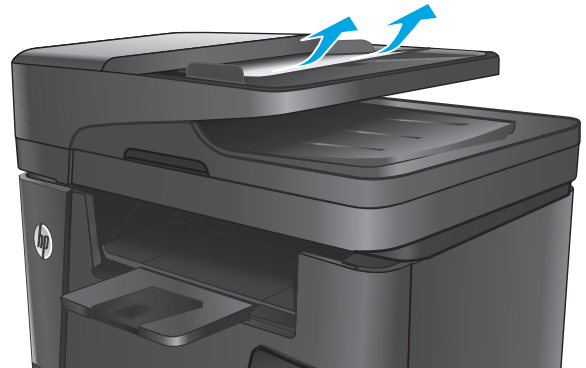

3. Lift the document-feeder input tray.

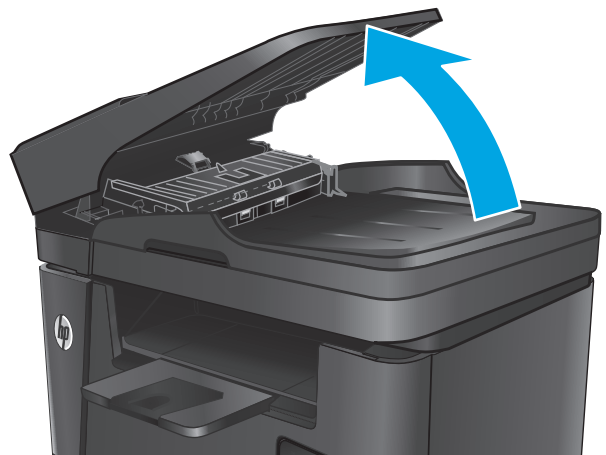

4. Lift the jam-access cover in the document feeder.

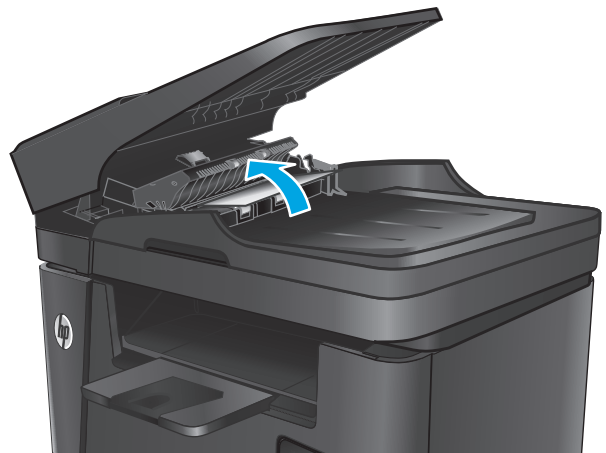

5. Remove any jammed paper from under the cover.

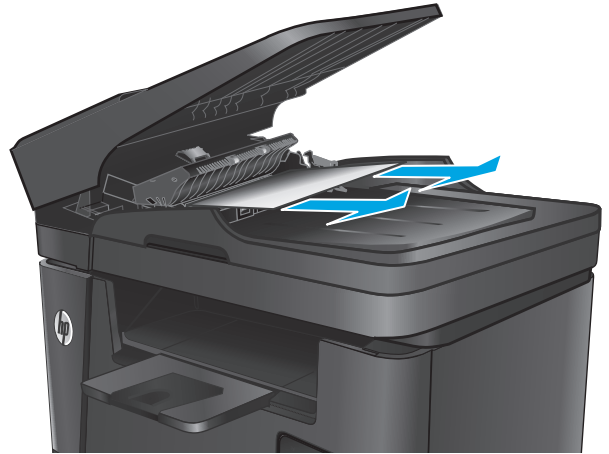

6. Close the jam-access cover.

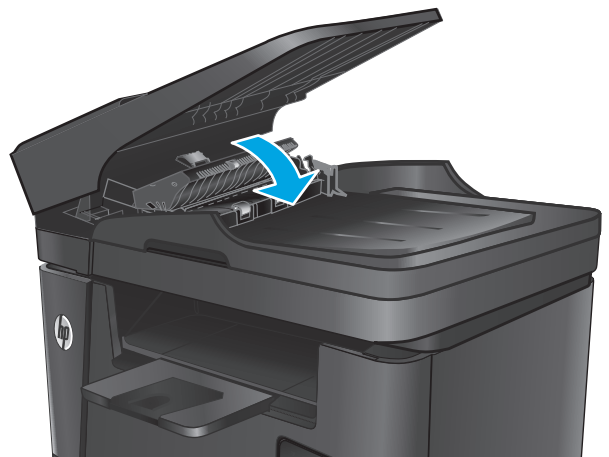

7. Close the document-feeder input tray.

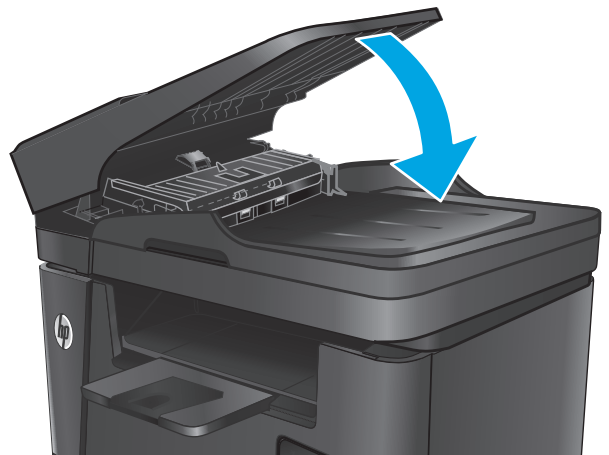

Clear jams in the toner-cartridge area

A **Jam in cartridge area** message displays on the product control panel.

 **NOTE:** For the dw models, an animation showing the jam-clearing procedure displays on the control panel.

1. Lift the scanner assembly.

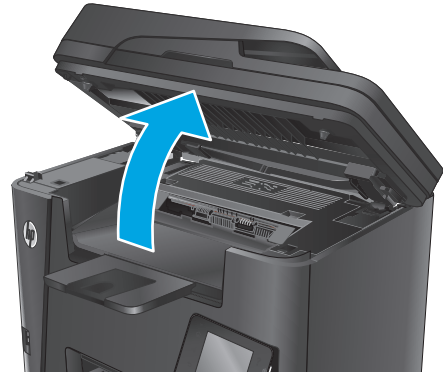

2. Open the top cover.



3. Remove the toner cartridge.

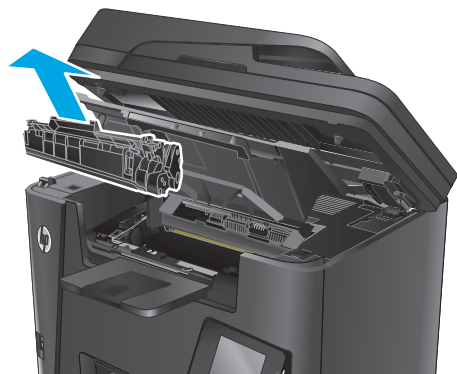

4. Remove any jammed paper from the toner-cartridge area. Use both hands to remove jammed paper to avoid tearing the paper.



5. Reinsert the toner cartridge.

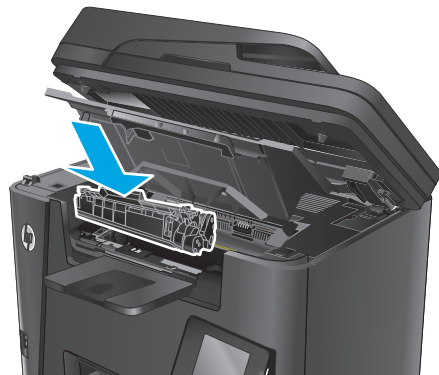

6. Close the top cover.



7. Lower the scanner assembly.



8. If the error message still displays on the control panel, press or touch **OK** to clear it.

Clear jams in the output bin

A **Jam in output bin** message displays on the product control panel.

 **NOTE:** For the dw models, an animation showing the jam-clearing procedure displays on the control panel.

1. Lift the scanner assembly.

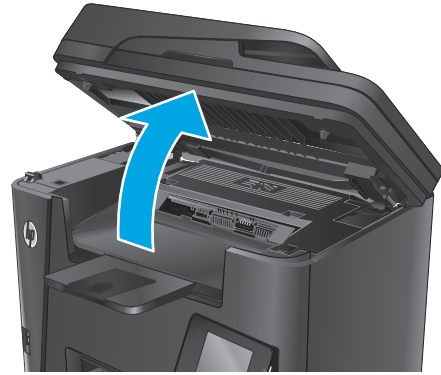

2. Open the top cover.



3. Pull out the green tab to release the jam-access cover.



4. Remove any jammed paper.



5. Close the jam-access cover.

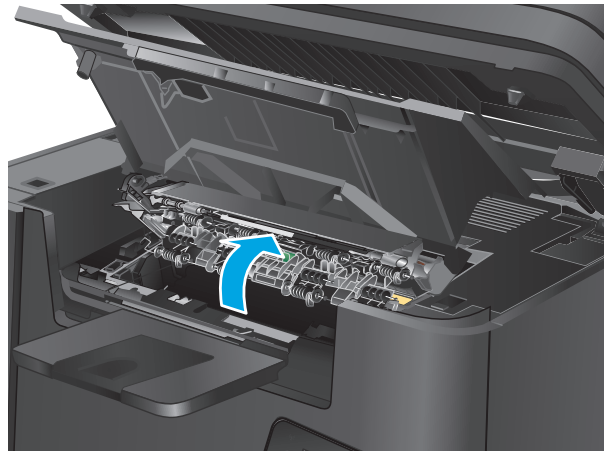

6. Close the top cover.

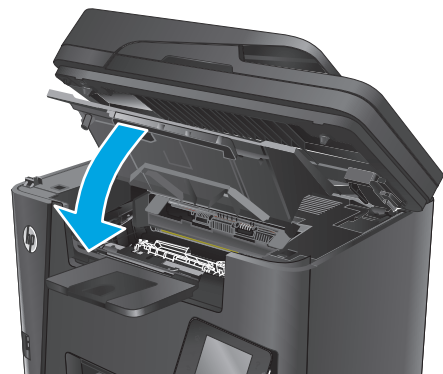

7. Lower the scanner assembly.



8. If the error message still displays on the control panel, press or touch **OK** to clear it.

Clear jams in the duplexer

A **Jam in duplex area** message displays on the product control panel.

 **NOTE:** For the dw models, an animation showing the jam-clearing procedure displays on the control panel.

1. Open the rear door.



2. Remove any jammed paper from the duplex area. Use both hands to remove jammed paper to avoid tearing the paper.



3. Close the rear door.

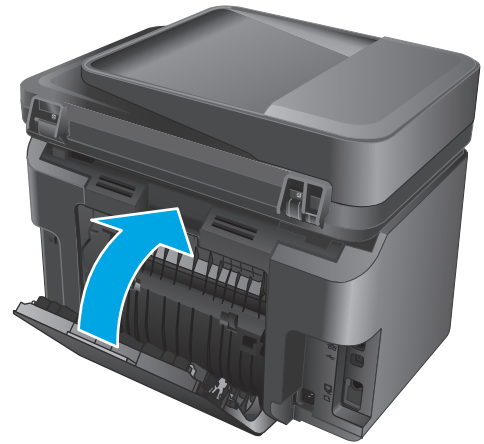

4. If the error message still displays on the control panel, press or touch **OK** to clear it.

Improve print quality

- [Print from a different software program](#)
- [Set the paper-type setting for the print job](#)
- [Check the toner-cartridge status](#)
- [Clean the product](#)
- [Inspect the toner cartridge for damage](#)
- [Check the paper and printing environment](#)
- [Check other print job settings](#)
- [Try a different print driver](#)

Print from a different software program

Try printing from a different software program. If the page prints correctly, the problem is with the software program from which you were printing.

Set the paper-type setting for the print job

Check the paper-type setting if you are printing from a software program and the pages have any of these problems:

- smeared print
- fuzzy print
- dark print
- curled paper
- scattered dots of toner
- loose toner
- small areas of missing toner

Check the paper-type setting (Windows)

1. From the software program, select the **Print** option.
2. Select the product, and then click the **Properties** or **Preferences** button.
3. Click the **Paper/Quality** tab.
4. From the **Media:** drop-down list, select the correct paper type.
5. Click the **OK** button to close the **Document Properties** dialog box. In the **Print** dialog, click the **OK** button to print the job.

Check the paper type setting (OS X)

1. Click the **File** menu, and then click the **Print** option.
2. Select the product.
3. Click **Show Details**, and then click the **Media & Quality** menu or the **Paper/Quality** menu.
4. Select a type from the **Media-type** drop-down list.
5. Click the **Print** button.

Check the toner-cartridge status

Check the supplies status page for the following information:

- Estimated percentage of cartridge life remaining
- Approximate pages remaining
- Part numbers for HP toner cartridges
- Number of pages printed

Use the following procedures to print the supplies status page:

LCD control panel

1. On the product control panel, press the Setup  button.
2. Open the following menus:
 - **Reports**
 - **Supplies status**
3. Use the arrow keys to select **Print Supplies status page**, and then press the **OK** button.

Touchscreen control panel

1. From the Home screen on the product control panel, touch the Supplies  button.
2. Touch the **Report** button to print the supplies status page.

Clean the product

Print a cleaning page

LCD control panel

1. From the product control panel, press the Setup  button.
2. Open the **Service** menu.
3. Use the arrow keys to select the **Cleaning mode** option, and then press the **OK** button.

The product prints the first side and then prompts you to remove the page from the output bin and reload it in Tray 1, keeping the same orientation. Wait until the process is complete. Discard the page that prints.

Touchscreen control panel

1. From the Home screen on the product control panel, touch the Setup  button.
2. Touch the **Service** menu.
3. Touch the **Cleaning Page** button.
4. Load plain letter or A4 paper when you are prompted.
5. Touch the **OK** button to begin the cleaning process.

The product prints the first side and then prompts you to remove the page from the output bin and reload it in Tray 1, keeping the same orientation. Wait until the process is complete. Discard the page that prints.

Check the scanner glass for dirt and smudges

Over time, specks of debris might collect on the scanner glass and white plastic backing, which can affect performance. Use the following procedure to clean the scanner.

1. Press the power button to turn the product off, and then disconnect the power cable from the electrical outlet.
2. Open the scanner lid.
3. Clean the scanner glass and the white plastic backing underneath the scanner lid with a soft cloth or sponge that has been moistened with nonabrasive glass cleaner.

 **CAUTION:** Do not use abrasives, acetone, benzene, ammonia, ethyl alcohol, or carbon tetrachloride on any part of the product; these can damage the product. Do not place liquids directly on the glass or platen. They might seep and damage the product.

4. Dry the glass and white plastic parts with a chamois or a cellulose sponge to prevent spotting.
5. Connect the power cable to an outlet, and then press the power button to turn the product on.

Inspect the toner cartridge for damage

1. Remove the toner cartridge from the product, and verify that the sealing tape has been removed.
2. Grasp both sides of the toner cartridge and distribute the toner by gently rocking the cartridge.
3. Check the memory chip for damage.
4. Examine the surface of the imaging drum on the toner cartridge.

 **CAUTION:** Do not touch the roller (imaging drum) on the cartridge. Fingerprints on the imaging drum can cause print-quality problems.

- If you see any scratches, fingerprints, or other damage on the imaging drum, replace the toner cartridge.
 - If the imaging drum does not appear to be damaged, rock the toner cartridge gently several times and reinstall it.
5. Print a few pages to see if these steps resolved the issue.

Check the paper and printing environment

Use paper that meets HP specifications

Use different paper if you are having any of the following problems:

- The printing is too light or seems faded in areas.
- Specks of toner are on the printed pages.
- Toner is smearing on the printed pages.
- Printed characters seem misformed.
- Printed pages are curled.

Always use a paper type and weight that this product supports. In addition, follow these guidelines when selecting paper:

- Use paper that is of good quality and free of cuts, nicks, tears, spots, loose particles, dust, wrinkles, voids, staples, and curled or bent edges.
- Use paper that has not been previously printed on.
- Use paper that is designed for use in laser printers. Do not use paper that is designed only for use in inkjet printers.
- Use paper that is not too rough. Using smoother paper generally results in better print quality.

Check the product environment

Verify that the product is operating within the environmental specifications listed in the product Warranty and Legal Guide.

Check other print job settings

When printing from a software program, follow these steps to try to resolve the issue by adjusting other print-driver settings.

Check the EconoMode settings

HP does not recommend the full-time use of EconoMode. If EconoMode is used full-time, the toner supply might outlast the mechanical parts in the toner cartridge. If print quality begins to degrade and is no longer acceptable, consider replacing the toner cartridge.



NOTE: This feature is available with the PCL 6 print driver for Windows. If you are not using that driver, enable the feature by using the HP Embedded Web Server.

Follow these steps if the entire page is too dark or too light.

1. From the software program, select the **Print** option.
2. Select the product, and then click the **Properties** or **Preferences** button.
3. Click the **Paper/Quality** tab, and locate the **Print Quality** area.
4. If the entire page is too dark, use these settings:

- Select the **600 dpi** option.
- Select the **EconoMode** check box to enable it.

If the entire page is too light, use these settings:

- Select the **FastRes 1200** option.
- Clear the **EconoMode** check box to disable it.

5. Click the **OK** button to close the **Document Properties** dialog box. In the **Print** dialog, click the **OK** button to print the job.

Try a different print driver

Try a different print driver when printing from a software program and the printed pages have unexpected lines in graphics, missing text, missing graphics, incorrect formatting, or substituted fonts.

Download any of the following drivers from the HP Web site: www.hp.com/support/ljMFPM225, www.hp.com/support/ljMFPM226.

HP PCL 6 driver	<ul style="list-style-type: none">• Provided as the default driver on the product CD. This driver is automatically installed unless a different one is selected.• Recommended for all Windows environments• Provides the overall best speed, print quality, and product-feature support for most users• Developed to align with the Windows Graphic Device Interface (GDI) for the best speed in Windows environments• Might not be fully compatible with third-party and custom software programs that are based on PCL 5
HP UPD PS driver	<ul style="list-style-type: none">• Recommended for printing with Adobe® software programs or with other highly graphics-intensive software programs• Provides support for printing from postscript emulation needs, or for postscript flash font support
HP UPD PCL 5	<ul style="list-style-type: none">• Recommended for general office printing in Windows environments• Compatible with previous PCL versions and older HP LaserJet products• The best choice for printing from third-party or custom software programs• The best choice when operating with mixed environments, which require the product to be set to PCL 5 (UNIX, Linux, mainframe)• Designed for use in corporate Windows environments to provide a single driver for use with multiple product models• Preferred when printing to multiple product models from a mobile Windows computer
HP UPD PCL 6	<ul style="list-style-type: none">• Recommended for printing in all Windows environments• Provides the overall best speed, print quality, and printer feature support for most users• Developed to align with Windows Graphic Device Interface (GDI) for best speed in Windows environments• Might not be fully compatible with third-party and custom software programs that are based on PCL 5

Improve copy and scan quality

Check the scanner glass for dirt and smudges

Over time, specks of debris might collect on the scanner glass and white plastic backing, which can affect performance. Use the following procedure to clean the scanner.

1. Press the power button to turn the product off, and then disconnect the power cable from the electrical outlet.
2. Open the scanner lid.
3. Clean the scanner glass and the white plastic backing underneath the scanner lid with a soft cloth or sponge that has been moistened with nonabrasive glass cleaner.

 **CAUTION:** Do not use abrasives, acetone, benzene, ammonia, ethyl alcohol, or carbon tetrachloride on any part of the product; these can damage the product. Do not place liquids directly on the glass or platen. They might seep and damage the product.

4. Dry the glass and white plastic parts with a chamois or a cellulose sponge to prevent spotting.
5. Connect the power cable to an outlet, and then press the power button to turn the product on.

Check the paper settings

1. On the product control panel, press or touch the Setup  button.
2. Open the [System Setup](#) menu.
3. Open the [Paper setup](#) menu.
4. Select the tray from the list.
5. Select [Paper Type](#) and then select the type of paper that is in the tray.
6. Select [Paper Size](#) and then select the size of paper that is in the tray.

Optimize for text or pictures

The following copy-quality settings are available:

- **Auto Select:** Use this setting when you are not concerned about the quality of the copy. This is the default setting.
- **Mixed:** Use this setting for documents that contain a mixture of text and graphics.
- **Text:** Use this setting for documents that contain mostly text.
- **Picture:** Use this setting for documents that contain mostly graphics.

LCD control panel

1. Load the document on the scanner glass according to the indicators on the product.
2. On the product control panel, press the Copy Menu  button.
3. Select the **Optimize** menu.

4. Use the arrow buttons to scroll through the options, and then press the **OK** button to select an option.
5. Touch the Start Copy  button to start copying.

Touchscreen control panel

1. Load the document on the scanner glass according to the indicators on the product.
2. From the Home screen on the product control panel, touch the **Copy** button.
3. Touch the **Settings** button, and then scroll to and touch the **Optimize** button. Touch the arrow buttons to scroll through the options, and then touch an option to select it.
4. Touch the **Start Copy** button to start copying.

Edge-to-edge copying

The product cannot print fully edge-to-edge. There is a 4 mm (0.2 inch) unprintable border around the page.

Considerations for printing or scanning documents with cropped edges:

- When the original is smaller than the output size, move the original 4 mm (0.2 inch) away from the corner indicated by the icon on the scanner. Recopy or scan in this position.
- When the original is the size of the printed output that you want, use the **Reduce/Enlarge** feature to reduce the image so the copy is not cropped.

Clean the pickup rollers and separation pad in the document feeder

If the document feeder experiences paper-handling problems, such as jams or multiple-page feeds, clean the document-feeder rollers and separation pad.

1. Lift the document-feeder input tray.

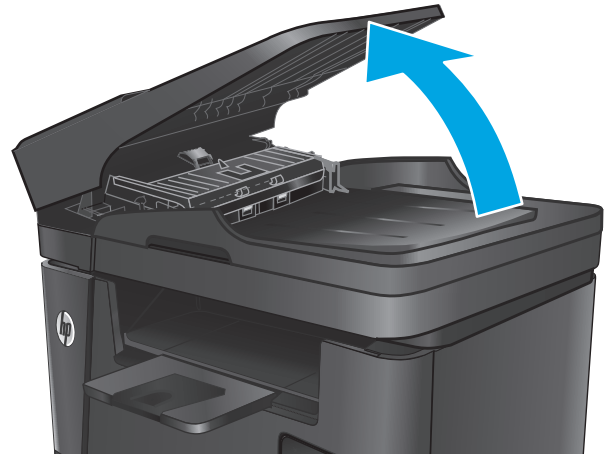

2. Use a moist, lint-free cloth to wipe both pickup rollers and the separation pad to remove dirt.

CAUTION: Do not use abrasives, acetone, benzene, ammonia, ethyl alcohol, or carbon tetrachloride on any part of the product; these can damage the product. Do not place liquids directly on the glass or platen. They might seep and damage the product.

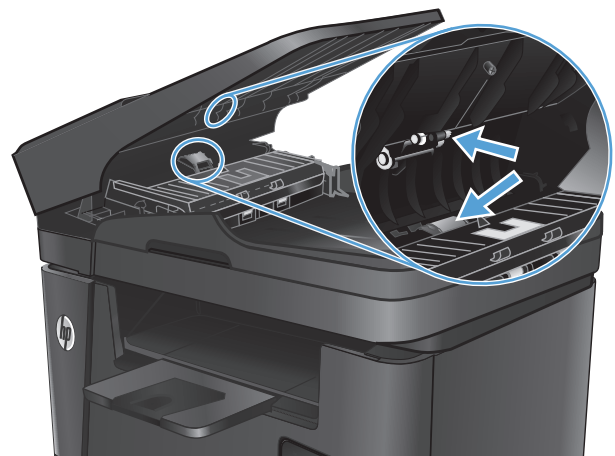

3. Close the document-feeder input tray.

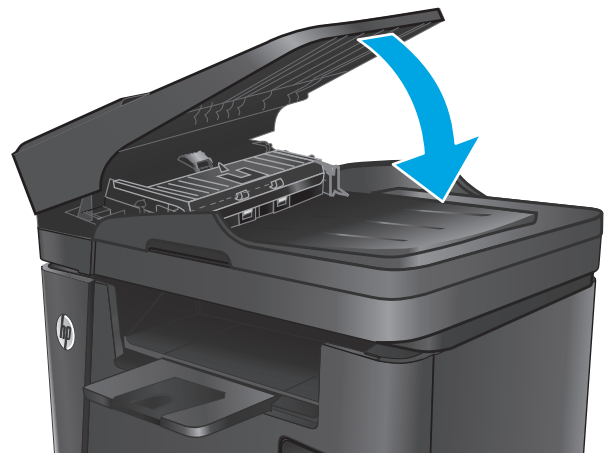

Improve fax image quality

- [Check the scanner glass for dirt or smudges](#)
- [Check the send-fax resolution setting](#)
- [Check the lightness/darkness setting](#)
- [Check the Error Correction setting](#)
- [Check the Fit-to-Page setting](#)
- [Clean the pickup rollers and separation pad in the document feeder](#)
- [Send to a different fax machine](#)
- [Check the sender's fax machine](#)

Check the scanner glass for dirt or smudges

Over time, specks of debris might collect on the scanner glass and white plastic backing, which can affect performance. Use the following procedure to clean the scanner.

1. Press the power button to turn the product off, and then disconnect the power cable from the electrical outlet.
2. Open the scanner lid.
3. Clean the scanner glass, the document feeder strips, and the white plastic backing with a soft cloth or sponge that has been moistened with nonabrasive glass cleaner.

⚠ CAUTION: Do not use abrasives, acetone, benzene, ammonia, ethyl alcohol, or carbon tetrachloride on any part of the product; these can damage the product. Do not place liquids directly on the glass or platen. They might seep and damage the product.

4. Dry the glass and white plastic parts with a chamois or a cellulose sponge to prevent spotting.
5. Close the scanner lid.
6. Connect the power cable to an outlet, and then press the power button to turn the product on.

Check the send-fax resolution setting

1. On the product control panel, press or touch the Setup  button.
2. Select **Fax Setup**.
3. Select **Advanced Setup**, and then select **Fax Resolution**.
4. Select the resolution setting, and then press or touch **OK**.

Check the lightness/darkness setting

If the fax output is too light or too dark, check the lightness/darkness setting to make sure it is appropriate for the fax job.

1. On the product control panel, press or touch the Setup  button.
2. Select **Fax Setup**, and then select **Advanced Setup**.
3. Select **Lighter/Darker**, and then adjust the setting for your fax job.

Check the Error Correction setting

Usually, the product monitors the signals on the telephone line while it is sending or receiving a fax. If the product detects an error during the transmission and the error-correction setting is **On**, the product can request that the portion of the fax be resent. The factory-set default for error correction is **On**.

You should turn off error correction only if you are having trouble sending or receiving a fax, and you are willing to accept the errors in the transmission. Turning off the setting might be useful when you are trying to send a fax overseas or receive one from overseas, or if you are using a satellite telephone connection.

1. On the product control panel, press or touch the Setup  button.
2. Select **Service**, and then select **Fax Service**.
3. Select **Error Correction**, and then select **On**.

Check the Fit-to-Page setting

If the product printed a fax job off the page, turn on the fit-to-page feature from the product control panel.

 **NOTE:** Make sure that the default paper size setting matches the size of the paper in the tray.

1. On the product control panel, press or touch the Setup  button.
2. Select [Fax Setup](#), and then select [Advanced Setup](#).
3. Select [Fit to Page](#), and then select [On](#).

Clean the pickup rollers and separation pad in the document feeder

If the document feeder experiences paper-handling problems, such as jams or multiple-page feeds, clean the document-feeder rollers and separation pad.

1. Lift the document-feeder input tray.

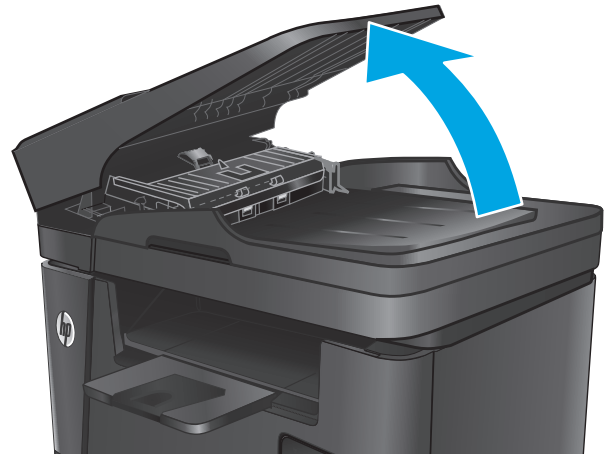

2. Use a moist, lint-free cloth to wipe both pickup rollers and the separation pad to remove dirt.

CAUTION: Do not use abrasives, acetone, benzene, ammonia, ethyl alcohol, or carbon tetrachloride on any part of the product; these can damage the product. Do not place liquids directly on the glass or platen. They might seep and damage the product.

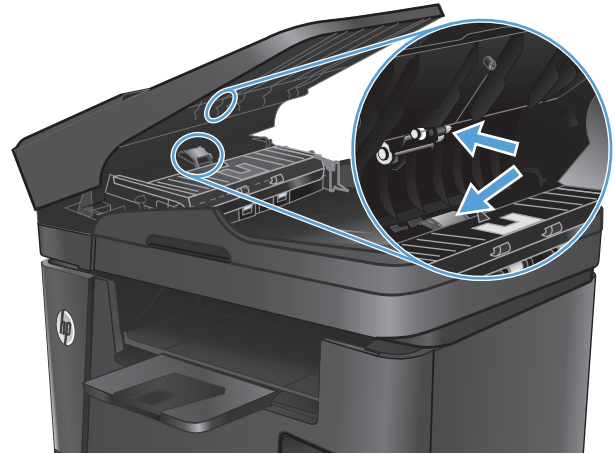

3. Close the document-feeder input tray.

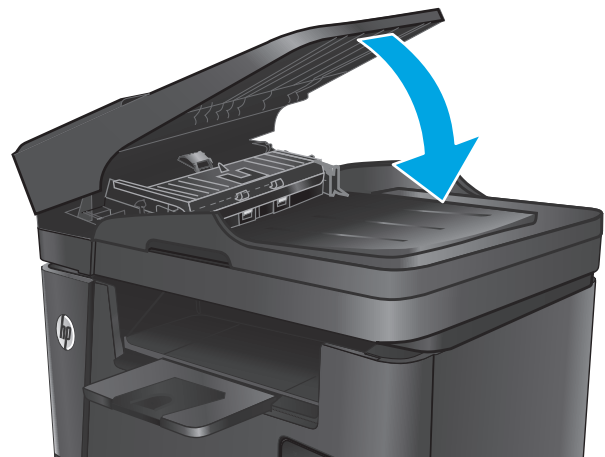

Send to a different fax machine

Send the fax job to a different fax machine to see if another machine will successfully receive the fax job.

- If another fax machine receives the fax successfully, check the connection and settings on the original receiving fax machine.
- If another fax machine does not receive the fax successfully, check the fax settings on your product. If the fax is still unsuccessful, there might be interference on the phone line. Try to resend the fax later.

Check the sender's fax machine

Ask the sender to darken the contrast setting on the sending fax machine, and then resend the fax.

If the received fax quality is still poor, check the fax settings on your product.

Solve wired network problems

Check the following items to verify that the product is communicating with the network. Before beginning, print a configuration page from the product control panel and locate the product IP address that is listed on this page.

- [Poor physical connection](#)
- [The computer is using the incorrect IP address for the product](#)
- [The computer is unable to communicate with the product](#)
- [The product is using incorrect link and duplex settings for the network](#)
- [New software programs might be causing compatibility problems](#)
- [The computer or workstation might be set up incorrectly](#)
- [The product is disabled, or other network settings are incorrect](#)



NOTE: HP does not support peer-to-peer networking, as the feature is a function of Microsoft operating systems and not of the HP print drivers. For more information, go to Microsoft at www.microsoft.com.

Poor physical connection

1. Verify that the product is attached to the correct network port using a cable of the correct length.
2. Verify that cable connections are secure.
3. Look at the network port connection on the back of the product, and verify that the amber activity light and the green link-status light are lit.
4. If the problem continues, try a different cable or port on the hub.

The computer is using the incorrect IP address for the product

1. Open the printer properties and click the **Ports** tab. Verify that the current IP address for the product is selected. The product IP address is listed on the product configuration page.
2. If you installed the product using the HP standard TCP/IP port, select the box labeled **Always print to this printer, even if its IP address changes**.
3. If you installed the product using a Microsoft standard TCP/IP port, use the hostname instead of the IP address.
4. If the IP address is correct, delete the product and then add it again.

The computer is unable to communicate with the product

1. Test network communication by pinging the network.
 - a. Open a command-line prompt on your computer.

- For Windows, click **Start**, click **Run**, type `cmd`, and then press **Enter**.
 - For OS X, go to **Applications**, then **Utilities**, and open **Terminal**.
- b. Type `ping` followed by the IP address for your product.
 - c. If the window displays round-trip times, the network is working.
2. If the ping command failed, verify that the network hubs are on, and then verify that the network settings, the product, and the computer are all configured for the same network.

The product is using incorrect link and duplex settings for the network

Hewlett-Packard recommends leaving these settings in automatic mode (the default setting). If you change these settings, you must also change them for your network.

New software programs might be causing compatibility problems

Verify that any new software programs are correctly installed and that they use the correct print driver.

The computer or workstation might be set up incorrectly

1. Check the network drivers, print drivers, and the network redirection settings.
2. Verify that the operating system is configured correctly.

The product is disabled, or other network settings are incorrect

1. Review the configuration page to check the status of the network protocol. Enable it if necessary.
2. Reconfigure the network settings if necessary.

Solve wireless network problems

- [Wireless connectivity checklist](#)
- [The product does not print after the wireless configuration completes](#)
- [The product does not print, and the computer has a third-party firewall installed](#)
- [The wireless connection does not work after moving the wireless router or product](#)
- [Cannot connect more computers to the wireless product](#)
- [The wireless product loses communication when connected to a VPN](#)
- [The network does not appear in the wireless networks list](#)
- [The wireless network is not functioning](#)
- [Perform a wireless network diagnostic test](#)
- [Reduce interference on a wireless network](#)

Wireless connectivity checklist

- Verify that the network cable is not connected.
- Verify that the product and the wireless router are turned on and have power. Also make sure that the wireless radio in the product is turned on.
- Verify that the service set identifier (SSID) is correct. Print a configuration page to determine the SSID. If you are not sure the SSID is correct, run the wireless setup again.
- With secured networks, verify that the security information is correct. If the security information is incorrect, run the wireless setup again.
- If the wireless network is working correctly, try accessing other computers on the wireless network. If the network has Internet access, try connecting to the Internet over a wireless connection.
- Verify that the encryption method (AES or TKIP) is the same for the product as it is for the wireless access point (on networks using WPA security).
- Verify that the product is within the range of the wireless network. For most networks, the product must be within 30 m (100 ft) of the wireless access point (wireless router).
- Verify that obstacles do not block the wireless signal. Remove any large metal objects between the access point and the product. Make sure poles, walls, or support columns containing metal or concrete do not separate the product and wireless access point.
- Verify that the product is located away from electronic devices that might interfere with the wireless signal. Many devices can interfere with the wireless signal including motors, cordless phones, security system cameras, other wireless networks, and some Bluetooth devices.
- Verify that the print driver is installed on the computer.
- Verify that you have selected the correct printer port.
- Verify that the computer and product connect to the same wireless network.
- For OS X, verify that the wireless router supports Bonjour.

The product does not print after the wireless configuration completes

1. Make sure that the product is turned on and in the ready state.
2. Turn off any third-party firewalls on your computer.
3. Make sure that the wireless network is working correctly.
4. Make sure that your computer is working correctly. If necessary, restart the computer.
5. Verify that you can open the product HP Embedded Web Server from a computer on the network.

The product does not print, and the computer has a third-party firewall installed

1. Update the firewall with the most recent update available from the manufacturer.
2. If programs request firewall access when you install the product or try to print, make sure you allow the programs to run.
3. Temporarily turn off the firewall, and then install the wireless product on the computer. Enable the firewall when you have completed the wireless installation.

The wireless connection does not work after moving the wireless router or product

1. Make sure that the router or product connects to the same network that your computer connects to.
2. Print a configuration page.
3. Compare the service set identifier (SSID) on the configuration page to the SSID in the printer configuration for the computer.
4. If the numbers are not the same, the devices are not connecting to the same network. Reconfigure the wireless setup for the product.

Cannot connect more computers to the wireless product

1. Make sure that the other computers are within the wireless range and that no obstacles block the signal. For most networks, the wireless range is within 30 m (100 ft) of the wireless access point.
2. Make sure that the product is turned on and in the ready state.
3. Turn off any third-party firewalls on your computer.
4. Make sure that the wireless network is working correctly.
5. Make sure that your computer is working correctly. If necessary, restart the computer.

The wireless product loses communication when connected to a VPN

- Typically, you cannot connect to a VPN and other networks at the same time.

The network does not appear in the wireless networks list

- Make sure the wireless router is turned on and has power.
- The network might be hidden. However, you can still connect to a hidden network.

The wireless network is not functioning

1. Make sure that the network cable is not connected.
2. To verify if the network has lost communication, try connecting other devices to the network.
3. Test network communication by pinging the network.
 - a. Open a command-line prompt on your computer.
 - For Windows, click **Start**, click **Run**, type `cmd`, and then press **Enter**.
 - For OS X, go to **Applications**, then **Utilities**, and open **Terminal**.
 - b. Type `ping` followed by the router IP address.
 - c. If the window displays round-trip times, the network is working.
4. Make sure that the router or product connects to the same network that the computer connects to.
 - a. Print a configuration page.
 - b. Compare the service set identifier (SSID) on the configuration report to the SSID in the printer configuration for the computer.
 - c. If the numbers are not the same, the devices are not connecting to the same network. Reconfigure the wireless setup for the product.

Perform a wireless network diagnostic test

From the product control panel, you can run a diagnostic test that provides information about the wireless network settings.

1. From the Home screen on the product control panel, touch the Setup  button.
2. Open the [Self Diagnostics](#) menu.
3. Touch the [Run Wireless Test](#) button to start the test. The product prints a test page that shows test results.

Reduce interference on a wireless network

The following tips can reduce interference in a wireless network:

- Keep the wireless devices away from large metal objects, such as filing cabinets, and other electromagnetic devices, such as microwaves and cordless telephones. These objects can disrupt radio signals.
- Keep the wireless devices away from large masonry structures and other building structures. These objects can absorb radio waves and lower signal strength.
- Position the wireless router in a central location in line of sight with the wireless products on the network.

Solve fax problems

- [Check the hardware setup](#)
- [Faxes are sending slowly](#)
- [Fax quality is poor](#)
- [Fax cuts off or prints on two pages](#)

Check the hardware setup

- Several possible fixes are available. After each recommended action, retry faxing to see if the problem is resolved.
 - For best results during fax problem solving, make sure the line from the product is connected directly to the wall phone port. Disconnect all other devices that are connected to the product.
1. Verify that the telephone cord is connected to the correct port on the back of the product.
 2. Check the phone line by using the fax test:
 - a. On the product control panel, press or touch the Setup  button.
 - b. Select [Service](#), and then select [Fax Service](#).
 - c. Select [Run Fax Test](#). The product prints a fax test report.

The report contains the following possible results:

- **Pass:** The report contains all of the current fax settings for review.
 - **Fail:** The report indicates the nature of the error and contains suggestions for how to resolve the issue.
3. Verify that the product firmware is current:
 - a. Go to www.hp.com/support.
 - b. Click **Drivers & Software**, type your product number in the window, and then click **Search**. If necessary, click your model in a list of similar products.

The **Software & Driver Downloads** page opens.
 - c. Select your operating system from the drop-down menu, and then click **Next**.
 - d. Click the plus sign next to **Firmware**, and then click **HP LaserJet Firmware Update Utility**.
 - e. Click **Download**.
 - f. When the download is complete, follow the on-screen instructions to install and run the utility.

The utility checks for firmware updates for your HP product. If updates are found, the utility installs the available update.
 - g. When firmware updates are complete, try to resend the fax.
 4. Verify that the fax was set up when the product software was installed.

From the computer, in the HP program folder, run the Fax Setup Utility.

5. Verify that the telephone service supports analog fax.



NOTE: HP products are designed specifically for use with analog phone services.

- If using ISDN or digital PBX, contact your service provider for information about configuring to an analog fax line.
 - If using a VoIP service, change the **Fax Speed** to **Slow(V.29)** from the control panel. Ask if your service provider supports fax and for the recommended fax modem speed. Some companies might require an adapter.
 - If you are using a DSL service, make sure that a filter is included on the phone-line connection to the product. Contact the DSL service provider, or purchase a DSL filter if you do not have one. If a DSL filter is installed, try another filter because filters can be defective.
6. If the error persists, find more detailed problem-solving solutions in the sections that follow this one.

Faxes are sending slowly

The product is experiencing poor phone line quality.

- Retry sending the fax when the line conditions have improved.
- Check with the phone service provider that the line supports fax.
- Use white paper for the original. Do not use colors such as gray, yellow, or pink.
- Divide large fax jobs into smaller sections, and then fax them individually.
- Turn off the **Error Correction** setting.
 1. On the product control panel, press or touch the Setup  button.
 2. Select **Service**, and then select **Fax Service**.
 3. Select **Error Correction**, and then select **Off**.



NOTE: Turning off **Error Correction** can reduce image quality.

- Increase the **Fax Speed** setting.
 1. On the product control panel, press or touch the Setup  button.
 2. Select **Fax Setup**, and then select **Advanced Setup**.
 3. Select **Fax Speed**, and then select the correct setting.
- Change the fax settings on the control panel to a lower resolution.



NOTE: Higher resolution faxes can take longer to send than lower resolution faxes.

1. On the product control panel, press or touch the Setup  button.
2. Select **Fax Setup**, and then select **Advanced Setup**.
3. Select **Fax Resolution**, and then select the correct setting.

Fax quality is poor



Fax is blurry or too light.

- Increase fax resolution when sending faxes. Resolution does not affect received faxes.
 1. On the product control panel, press or touch the Setup  button.
 2. Select **Fax Setup**, and then select **Advanced Setup**.
 3. Select **Fax Resolution**, and then select the correct setting.

 **NOTE:** Increasing resolution slows transmission speed.

- Turn on the **Error Correction** setting from the control panel.
 1. On the product control panel, press or touch the Setup  button.
 2. Select **Service**, and then select **Fax Service**.
 3. Select **Error Correction**, and then select **On**.
- Check the toner cartridge and replace the cartridge if necessary.
- Ask the sender to darken the contrast setting on the sending fax machine, and then resend the fax.

Fax cuts off or prints on two pages

- Set the **Default Paper Size** setting. Faxes print on a single size of paper based on the **Default Paper Size** settings.
 1. On the product control panel, press or touch the Setup  button.
 2. Select **System Setup**, and then select **Paper Setup**.
 3. Select **Paper Size**, and then select the correct setting.
- Set the paper type and size for the tray used for faxes.
- Turn on the **Fit to Page** setting to print longer length faxes on letter or A4 size paper.
 1. On the product control panel, press or touch the Setup  button.
 2. Select **Fax Setup**, and then select **Advanced Setup**.
 3. Select **Fit to Page**, and then select **On**.

 **NOTE:** If the **Fit to Page** setting is off and the **Default Paper Size** setting is set to Letter, a Legal-size original prints on two pages.

Index

A

- accessories
 - ordering 24
 - part numbers 24
- acoustic specifications 5
- AirPrint 40
- applications
 - downloading 74
- Apps menu 74

B

- bins, output
 - locating 6
- browser requirements
 - HP embedded Web Server 76

C

- cartridge
 - replacing 25
- checklist
 - wireless connectivity 125
- cleaning
 - glass 112, 116
 - paper path 111
- control panel
 - help 91
 - locating 6
- control panel buttons
 - locating 8
- copy quality
 - improving 116
- copying
 - edges of documents 117
 - multiple copies 44
 - optimizing for text or pictures 116
 - quality, adjusting 44
 - setting paper size and type 116

- single copies 44
- two-sided documents 45
- covers, locating 6
- customer support
 - online 90

D

- defaults, restoring 92
- dimensions, product 2
- document feeder 45
 - copying two-sided documents 45
 - faxing from 70
 - paper-feeding problems 95
- double-sided copying 45
- double-sided printing
 - Mac 36
 - Windows 33
- drivers
 - paper types 16
- duplex 45
- duplex printing
 - Mac 36
- duplex printing (double-sided)
 - settings (Windows) 32
 - Windows 33
- duplexing
 - manually (Mac) 36
 - manually (Windows) 33

E

- EconoMode setting 85, 113
- economy settings 85
- electrical specifications 5
- Embedded Web Server
 - changing password 84
 - opening 84
- Embedded Web Server (EWS)
 - features 76

- Explorer, versions supported
 - HP Embedded Web Server 76

F

- factory-set defaults, restoring 92
- fax ports
 - locating 7
- fax troubleshooting
 - hardware setup 128
- faxing
 - from the document feeder 70
 - from the flatbed scanner 70

G

- glass, cleaning 112, 116

H

- hardware setup
 - fax troubleshooting 128
- help, control panel 91
- HP Customer Care 90
- HP Device Toolbox, using 76
- HP Embedded Web Server
 - changing password 84
 - opening 84
- HP Embedded Web Server (EWS)
 - features 76
- HP ePrint 39
- HP ePrint software 40
- HP EWS, using 76
- HP Scan software (Mac) 49
- HP Scan software (Windows) 48
- HP Utility 79
- HP Utility for Mac
 - Bonjour 79
 - features 79
- HP Utility, Mac 79
- HP Web Jetadmin 83

- HP Web Services
 - applications 74
 - enabling 74
- HP Wireless Direct Printing 38
- I**
- interface ports
 - locating 7
- Internet Explorer, versions supported
 - HP Embedded Web Server 76
- J**
- jams
 - locating 98
- Jetadmin, HP Web 83
- L**
- labels
 - printing (Windows) 35
- M**
- Macintosh
 - HP Utility 79
- manual duplex
 - Mac 36
 - Windows 33
- media
 - supported sizes 14
- multiple pages per sheet
 - printing (Mac) 37
 - printing (Windows) 34
- N**
- Netscape Navigator, versions supported
 - HP embedded Web Server 76
- network
 - password, changing 84
 - password, setting 84
- network installation 75
- network port
 - locating 7
- networks
 - HP Web Jetadmin 83
 - installing the product 75
- number of copies, changing 44
- O**
- on/off button, locating 6
- online help, control panel 91
- online support 90
- ordering
 - supplies and accessories 24
- output bin
 - locating 6
- P**
- pages per minute 2
- pages per sheet
 - selecting (Mac) 37
 - selecting (Windows) 34
- paper
 - ordering 24
 - selecting 113
 - supported sizes 14
 - supported types 16
- paper pickup problems
 - solving 95
- paper type
 - selecting (Windows) 35
- paper types
 - selecting (Mac) 37
- part numbers
 - supplies 24
- power
 - consumption 5
- power connection
 - locating 7
- power switch, locating 6
- print on both sides
 - Mac 36
 - manually, Windows 33
 - Windows 33
- print quality
 - improving 110
- printing
 - from USB flash drives 41
- printing on both sides
 - settings (Windows) 32
- product and serial number label
 - locating 7
- R**
- replacing toner cartridge 25
- restoring factory-set defaults 92
- S**
- scan quality
 - improving 116
- scanner
 - faxing from 70
 - glass cleaning 112, 116
- scanning
 - from HP Scan software (Mac) 49
 - from HP Scan software (Windows) 48
- security lock slot
 - locating 7
- serial number label
 - locating 7
- settings
 - factory-set defaults, restoring 92
- sleep delay
 - setting 85
- software
 - HP Utility 79
- special paper
 - printing (Windows) 35
- specifications
 - electrical and acoustic 5
- status
 - HP Utility, Mac 79
- supplies
 - low threshold settings 93
 - ordering 24
 - part numbers 24
 - replacing toner cartridge 25
 - status, viewing with HP Utility for Mac 79
 - using when low 93
- supplies status
 - checking 111
- supplies status page
 - printing 111
- support
 - online 90
- supported media 14
- supported operating systems 2
- system requirements
 - HP Embedded Web Server 76
- T**
- technical support
 - online 90
- toner
 - amount remaining 111
- toner cartridge
 - checking for damage 112
 - low threshold settings 93
 - replacing 25
 - using when low 93

transparencies
printing (Windows) 35

Tray 1
loading 17
orientation 17

Tray 2
loading 19
orientation 21

trays
included 2
locating 6

troubleshooting
faxes 128
network problems 123
wired network 123
wireless network 125

two-sided copying 45
two-sided printing
settings (Windows) 32

U

USB flash drives
printing from 41

USB port
locating 7

W

walk-up USB port
locating 6

walk-up USB printing 41

Web browser requirements
HP Embedded Web Server 76

Web Services
applications 74
enabling 74

Web sites
customer support 90
HP Web Jetadmin, downloading
83

weight, product 2

wireless network
troubleshooting 125

wireless network interference 127



CF484-90901



Free Manuals Download Website

<http://myh66.com>

<http://usermanuals.us>

<http://www.somanuals.com>

<http://www.4manuals.cc>

<http://www.manual-lib.com>

<http://www.404manual.com>

<http://www.luxmanual.com>

<http://aubethermostatmanual.com>

Golf course search by state

<http://golfingnear.com>

Email search by domain

<http://emailbydomain.com>

Auto manuals search

<http://auto.somanuals.com>

TV manuals search

<http://tv.somanuals.com>