

HP MSR2000/3000/4000 Router Series Interface Configuration Guide (V7)

Part number: 5998-3987

Software version: CMW710-R0007P02

Document version: 6PW100-20130927



Legal and notice information

© Copyright 2013 Hewlett-Packard Development Company, L.P.

No part of this documentation may be reproduced or transmitted in any form or by any means without prior written consent of Hewlett-Packard Development Company, L.P.

The information contained herein is subject to change without notice.

HEWLETT-PACKARD COMPANY MAKES NO WARRANTY OF ANY KIND WITH REGARD TO THIS MATERIAL, INCLUDING, BUT NOT LIMITED TO, THE IMPLIED WARRANTIES OF MERCHANTABILITY AND FITNESS FOR A PARTICULAR PURPOSE. Hewlett-Packard shall not be liable for errors contained herein or for incidental or consequential damages in connection with the furnishing, performance, or use of this material.

The only warranties for HP products and services are set forth in the express warranty statements accompanying such products and services. Nothing herein should be construed as constituting an additional warranty. HP shall not be liable for technical or editorial errors or omissions contained herein.

Contents

Bulk configuring interfaces	ii
Configuration guidelines	iii
Configuration procedure	iii
Displaying and maintaining bulk interface configuration	iv
Configuring Ethernet interfaces	1
Configuring common Ethernet interface settings	1
Configuring a combo interface	1
Configuring basic settings of an Ethernet interface	2
Configuring the link mode of an Ethernet interface	3
Configuring jumbo frame support	3
Performing an internal loopback test on an Ethernet interface	4
Configuring generic flow control on an Ethernet interface	4
Setting the statistics polling interval	5
Configuring a Layer 2 Ethernet interface	5
Configuring storm suppression	5
Setting the MDIX mode of an Ethernet interface	6
Configuring a Layer 3 Ethernet interface or subinterface	6
Setting the MTU for an Ethernet interface or subinterface	6
Configuring the MAC address of an Ethernet interface or subinterface	7
Displaying and maintaining an Ethernet interface or subinterface	7
Configuring WAN interfaces	9
Configuring a serial interface	9
Overview	9
Configuring an asynchronous serial interface	9
Configuring a synchronous serial interface	10
Displaying and maintaining serial interfaces	12
Configuring an AM interface	12
Overview	12
Configuration procedure	13
Displaying and maintaining AM interfaces	14
Configuring an ISDN BRI interface	14
Overview	14
Prerequisites	15
Configuration procedure	15
Displaying and maintaining ISDN BRI interfaces	16
Configuring a CE1/PRI interface	16
Overview	16
Configuration procedure (in E1 mode)	17
Configuration procedure (in CE1 mode)	17
Configuration procedure (in PRI mode)	18
Configuring other CE1/PRI interface parameters	19
Displaying and maintaining CE1/PRI interfaces	20
Configuring a CT1/PRI interface	20
Overview	20
Configuration procedure (in CT1 mode)	20
Configuration procedure (in PRI mode)	21
Configuring other CT1/PRI interface parameters	21
Starting/terminating a BERT test on a CT1/PRI interface	23

Displaying and maintaining CT1/PRI interfaces.....	23
Configuring an E1-F interface.....	23
Overview.....	23
Configuration procedure (in framed mode).....	24
Configuration procedure (in unframed mode).....	24
Configuring other E1-F interface parameters.....	25
Displaying and maintaining E1-F interfaces.....	25
Configuring a T1-F interface.....	26
Overview.....	26
Configuration procedure.....	26
Starting/terminating a BERT test on a T1-F interface.....	28
Displaying and maintaining T1-F interfaces.....	28
Configuring a CE3 interface.....	28
Overview.....	28
Configuration procedure (in E3 mode).....	29
Configuration procedure (in CE3 mode).....	30
Displaying and maintaining CE3 interfaces.....	31
Configuring POS interfaces.....	33
Overview.....	33
SONET.....	33
SDH.....	33
POS.....	33
Configuring a POS interface or POS subinterface.....	33
Configuration prerequisites.....	33
Configuring a POS interface.....	34
Displaying and maintaining POS interfaces.....	35
Configuration example for directly connecting routers through POS interfaces.....	35
Troubleshooting POS interfaces.....	36
Configuring loopback, null, and inloopback interfaces.....	38
Configuring a loopback interface.....	38
Configuring a null interface.....	39
Configuring an inloopback interface.....	39
Displaying and maintaining loopback, null, and inloopback interfaces.....	39
Support and other resources.....	41
Contacting HP.....	41
Subscription service.....	41
Related information.....	41
Documents.....	41
Websites.....	41
Conventions.....	42
Index.....	44

Bulk configuring interfaces

You can enter interface range view to bulk configure multiple interfaces with the same feature instead of configuring them one by one. For example, you can execute the **shutdown** command in interface range view to shut down a range of interfaces.

Failure to apply a command on one member interface does not affect the application of the command on the other member interfaces. If applying a command on one member interface fails, the system displays an error message and continues with the next member interface.

Configuration guidelines

When you bulk configure interfaces in interface range view, follow these restrictions and guidelines:

- In interface range view, only the commands supported by the first interface are available. The first interface is specified with the **interface range** command.
- If you cannot enter the view of an interface by using the **interface** *interface-type* { *interface-number* | *interface-number.subnumber* } command (for example, BRI 1/1/1:1), do not configure the interface as the first interface in the interface range.
- No limit is set on the maximum number of interfaces in an interface range. The more interfaces in an interface range, the longer the command execution time.
- The maximum number of interface range names is only limited by the system resources. To guarantee bulk interface configuration performance, HP recommends that you configure fewer than 1000 interface range names.

Configuration procedure

To bulk configure interfaces:

Step	Command	Remarks
1. Enter system view.	system-view	N/A
2. Enter interface range view.	<ul style="list-style-type: none"> • interface range { <i>interface-type</i> <i>interface-number</i> [to <i>interface-type</i> <i>interface-number</i>] } &<1-5> • interface range name <i>name</i> [interface { <i>interface-type</i> <i>interface-number</i> [to <i>interface-type</i> <i>interface-number</i>] } &<1-5>] 	Use either command. By using the interface range name command, you assign a name to an interface range and can specify this name rather than the interface range to enter the interface range view.
3. (Optional.) Display commands available for the first interface in the interface range.	Enter a question mark (?) at the interface range prompt.	N/A
4. Use available commands to configure the interfaces.	Available commands vary by interface.	N/A
5. (Optional.) Verify the configuration.	display this	N/A

Displaying and maintaining bulk interface configuration

Execute the **display** command in any view.

Task	Command
Display information about the specified interface range or all existing interface ranges.	display interface range [<i>name name</i>]

Configuring Ethernet interfaces

Your device supports the following types of Ethernet interfaces:

- **Layer 2 Ethernet interfaces**—Physical Ethernet interfaces operating at the data link layer (Layer 2) to switch packets.
- **Layer 3 Ethernet interfaces**—Physical Ethernet interfaces operating at the network layer (Layer 3) to route packets. You can assign an IP address to a Layer 3 Ethernet interface.
- **Layer-configurable Ethernet interfaces**—Physical Ethernet interfaces that can be configured to operate in bridge mode as Layer 2 Ethernet interfaces or in route-mode as Layer 3 Ethernet interfaces.
- **Layer 3 Ethernet subinterfaces**—Logical interfaces operating at the network layer. You can assign an IP address to a Layer 3 Ethernet subinterface. By creating subinterfaces on a Layer 3 Ethernet interface, you enable the interface to carry packets for multiple VLANs.

Configuring common Ethernet interface settings

This section describes the settings common to Layer 2 Ethernet interfaces, Layer 3 Ethernet interfaces, and Layer 3 Ethernet subinterfaces. For more information about the settings specific to Layer 2 Ethernet interfaces, Layer 3 Ethernet interfaces, and Layer 3 Ethernet subinterfaces, see "[Configuring a Layer 2 Ethernet interface](#)" and "[Configuring a Layer 3 Ethernet interface or subinterface](#)."

Configuring a combo interface

A combo interface is a logical interface that physically comprises one fiber port and one copper port. The two ports share one forwarding channel and one interface view, so they cannot work simultaneously. When you activate one port, the other port is automatically disabled. In the interface view, you can activate the fiber or copper combo port, and configure other port attributes such as the interface rate and duplex mode.

Configuration prerequisites

Before you configure combo interfaces, complete the following tasks:

- Determine the combo interfaces on your device and identify the two physical interfaces that compose each combo interface according to the marks on the device panel.
- Use the **display interface** command to determine which port (fiber or copper) of the combo interface is active. If the current port is the copper port, the output includes "Media type is twisted pair, Port hardware type is 1000_BASE_T". If the current port is the fiber port, the output does not include this information. You can also use the **display this** command in the view of the combo interface to view the combo interface configuration. If the **combo enable fiber** command exists, the fiber port is active. If the command does not exist, the copper port is active.

Changing the active port of a combo interface

Step	Command	Remarks
1. Enter system view.	system-view	N/A

Step	Command	Remarks
2.	Enter Ethernet interface view. interface <i>interface-type</i> <i>interface-number</i>	N/A
3.	Activate the copper combo port or fiber combo port. combo enable { copper fiber }	By default, the copper combo port is active. When the loopback command is running on a combo interface, you cannot use the combo enable command on the combo interface.

Configuring basic settings of an Ethernet interface

You can set an Ethernet interface to operate in one of the following duplex modes:

- **Full-duplex mode (full)**—Interfaces can send and receive packets simultaneously.
- **Half-duplex mode (half)**—Interfaces cannot send and receive packets simultaneously.
- **Autonegotiation mode (auto)**—Interfaces negotiate a duplex mode with their peers.

You can set the speed of an Ethernet interface or enable it to automatically negotiate a speed with its peer.

To configure an Ethernet interface:

Step	Command	Remarks
1.	Enter system view. system-view	N/A
2.	Enter Ethernet interface view. interface <i>interface-type</i> <i>interface-number</i>	N/A
3.	Set the interface description. description <i>text</i>	The default setting is in the format of <i>interface-name</i> Interface . For example, Ethernet1/1 Interface .
4.	Set the duplex mode of the Ethernet interface. duplex { auto full half }	The default setting is full for 10-GE interfaces and auto for other Ethernet interfaces. Fiber ports do not support the half keyword.
5.	Set the port speed. speed { 10 100 1000 10000 auto }	By default, an Ethernet interface automatically negotiates a speed with its peer. The 10000 keyword is supported only on 10-GE interfaces of an MSR4000 router.
6.	Configure the expected bandwidth of the interface. bandwidth <i>bandwidth-value</i>	By default, the expected bandwidth (in kbps) is the interface baud rate divided by 1000.
7.	Restore the default settings for the Ethernet interface. default	N/A
8.	Bring up the Ethernet interface. undo shutdown	By default, the interface is in down state.

Configuring the link mode of an Ethernet interface

CAUTION:

After you change the link mode of an Ethernet interface, all commands (except the **shutdown** command) on the Ethernet interface are restored to their defaults in the new link mode.

Ethernet interfaces of the device can operate either as Layer 2 or Layer 3 Ethernet interfaces (you can set the link mode to bridge or route).

To change the link mode of an Ethernet interface:

Step	Command	Remarks
1. Enter system view.	system-view	N/A
2. Enter Ethernet interface view.	interface <i>interface-type</i> <i>interface-number</i>	N/A
3. Change the link mode of the Ethernet interface.	port link-mode { bridge route }	By default, only Ethernet interfaces on SIC-4FSW and DSIC-9FSW cards operate in bridge mode.

Configuring jumbo frame support

Jumbo frame support allows an interface to process jumbo frames within the specified range. Jumbo frames refer to the frames larger than the standard Ethernet frames. An Ethernet interface might receive jumbo frames during high-throughput data exchanges, such as file transfers. Without jumbo frame support enabled, the interface discards jumbo frames.

To configure jumbo frame support on an Ethernet interface:

Step	Command	Remarks
1. Enter system view.	system-view	N/A
2. Enter Ethernet interface view.	interface <i>interface-type</i> <i>interface-number</i>	N/A
3. Configure jumbo frame support.	jumboframe enable [<i>value</i>]	By default, the device allows jumbo frames within the specified length to pass through Ethernet interfaces. The length of jumbo frames that are allowed to pass depends on the interface type.

Performing an internal loopback test on an Ethernet interface

If an Ethernet interface does not work correctly, you can perform an internal loopback test on it to test all on-chip functions related to the interface. An Ethernet interface in a loopback test does not forward data traffic.

Configuration restrictions and guidelines

- On an administratively shut down interface (displayed as in **ADM** or **Administratively DOWN** state), you cannot perform an internal loopback test.
- The **speed**, **duplex**, **mdix-mode**, and **shutdown** commands are not available during a loopback test.
- During a loopback test, the Ethernet interface operates in full duplex mode. When a loopback test is complete, the port returns to its duplex setting.

Configuration procedure

To perform a loopback test on an Ethernet interface:

Step	Command	Remarks
1. Enter system view.	system-view	N/A
2. Enter Ethernet interface view.	interface <i>interface-type</i> <i>interface-number</i>	N/A
3. Perform an internal loopback test.	loopback internal	By default, no internal loopback test is performed.

Configuring generic flow control on an Ethernet interface

To avoid packet drops on a link, you can enable generic flow control at both ends of the link. When traffic congestion occurs at the receiving end, the receiving end sends a flow control (Pause) frame to ask the sending end to suspend sending packets. When the sending end receives a flow control frame from the receiving end, the sending end suspends sending packets.

To enable both ends of a link to handle traffic congestion, configure the **flow-control** command at both ends.

To enable generic flow control on an Ethernet interface:

Step	Command	Remarks
1. Enter system view.	system-view	N/A
2. Enter Ethernet interface view.	interface <i>interface-type</i> <i>interface-number</i>	N/A
3. Enable generic flow control.	flow-control	By default, generic flow control is disabled on an Ethernet interface.

Setting the statistics polling interval

Step	Command	Remarks
1. Enter system view.	system-view	N/A
2. Set the statistics polling interval.	flow-interval <i>interval</i>	By default, the interface statistics polling interval is 300 seconds.

To display the interface statistics collected in the last polling interval, use the **display interface** command.

To clear interface statistics, use the **reset counters interface** command.

Configuring a Layer 2 Ethernet interface

Configuring storm suppression

You can use the storm suppression function to limit the size of a particular type of traffic (broadcast, multicast, or unknown unicast traffic) on an interface. When the broadcast, multicast, or unknown unicast traffic on the interface exceeds this threshold, the interface discards packets until the traffic drops below this threshold.

Configuration guidelines

When you configure the suppression threshold in pps or kbps, the device might convert the configured value into a multiple of a certain step supported by the chip. As a result, the actual suppression threshold might be different from the configured one. For the suppression threshold that takes effect, see the prompt on the device.

Configuration procedure

To set storm suppression thresholds on an Ethernet interface:

Step	Command	Remarks
1. Enter system view.	system-view	N/A
2. Enter Ethernet interface view.	interface <i>interface-type</i> <i>interface-number</i>	N/A
3. Enable broadcast suppression and set the broadcast suppression threshold.	broadcast-suppression { <i>ratio</i> pps <i>max-pps</i> kbps <i>max-kbps</i> }	By default, broadcast traffic is allowed to pass through an interface.
4. Enable multicast suppression and set the multicast suppression threshold.	multicast-suppression { <i>ratio</i> pps <i>max-pps</i> kbps <i>max-kbps</i> }	By default, multicast traffic is allowed to pass through an interface.
5. Enable unknown unicast suppression and set the unknown unicast suppression threshold.	unicast-suppression { <i>ratio</i> pps <i>max-pps</i> kbps <i>max-kbps</i> }	By default, unknown unicast traffic is allowed to pass through an interface.

Setting the MDIX mode of an Ethernet interface

! **IMPORTANT:**

Fiber ports do not support the MDIX mode setting.

A physical Ethernet interface comprises eight pins, each of which plays a dedicated role. For example, pins 1 and 2 transmit signals, and pins 3 and 6 receive signals. You can use both crossover and straight-through Ethernet cables to connect copper Ethernet interfaces. To accommodate these types of cables, a copper Ethernet interface can operate in one of the following Medium Dependent Interface-Crossover (MDIX) modes:

- **MDIX mode**—Pins 1 and 2 are receive pins and pins 3 and 6 are transmit pins.
- **MDI mode**—Pins 1 and 2 are transmit pins and pins 3 and 6 are receive pins.
- **AutoMDIX mode**—The interface negotiates pin roles with its peer.

To enable the interface to communicate with its peer, set the MDIX mode of the interface mode by using the following guidelines:

- Generally, set the MDIX mode of the interface to AutoMDIX. Set the MDIX mode of the interface to MDI or MDIX only when the device cannot determine the cable type.
- When a straight-through cable is used, set the interface to operate in the MDIX mode different than its peer.
- When a crossover cable is used, set the interface to operate in the same MDIX mode as its peer, or set either end to operate in AutoMDIX mode.

To set the MDIX mode of an Ethernet interface:

Step	Command	Remarks
1. Enter system view.	system-view	N/A
2. Enter Ethernet interface view.	interface <i>interface-type</i> <i>interface-number</i>	N/A
3. Set the MDIX mode of the Ethernet interface.	mdix-mode { automdix mdi mdix }	By default, a copper Ethernet interface operates in auto mode to negotiate pin roles with its peer.

Configuring a Layer 3 Ethernet interface or subinterface

Setting the MTU for an Ethernet interface or subinterface

The value of maximum transmission unit (MTU) affects the fragmentation and reassembly of IP packets. Generally, you do not need to modify the MTU of an interface.

To set the MTU for an Ethernet interface or subinterface:

Step	Command	Remarks
1. Enter system view.	system-view	N/A
2. Enter Ethernet interface or subinterface view.	interface <i>interface-type</i> { <i>interface-number</i> <i>interface-number.subnumber</i> }	N/A
3. Set the MTU.	mtu <i>size</i>	The default setting is 1500 bytes.

Configuring the MAC address of an Ethernet interface or subinterface

In a network, when the Layer 3 Ethernet interfaces or subinterfaces of different devices have the same MAC address, the devices might fail to communicate correctly. To eliminate the MAC address conflicts, use the **mac-address** command to modify the MAC addresses of Layer 3 Ethernet interfaces or subinterfaces.

Additionally, when a Layer 3 Ethernet subinterface is created, it uses the MAC address of its main interface by default. As a result, all Layer 3 Ethernet subinterfaces of a Layer 3 Ethernet interface share the same MAC address. To configure a different MAC address for a specific Layer 3 Ethernet subinterface, use the **mac-address** command.

To configure the MAC address of an Ethernet interface or subinterface:

Step	Command	Remarks
1. Enter system view.	system-view	N/A
2. Enter Ethernet interface view.	interface <i>interface-type</i> { <i>interface-number</i> <i>interface-number.subnumber</i> }	N/A
3. Configure the MAC address of the Ethernet interface or subinterface.	mac-address <i>mac-address</i>	The default MAC address of a Layer 3 Ethernet subinterface is the same as the MAC address of its host interface. HP recommends not configuring a MAC address in the VRRP-reserved MAC address range for a Layer 3 Ethernet subinterface.

Displaying and maintaining an Ethernet interface or subinterface

Execute **display** commands in any view and **reset** commands in user view.

Task	Command
Display interface traffic statistics.	display counters { inbound outbound } interface [<i>interface-type</i> [<i>interface-number</i> <i>interface-number.subnumber</i>]]

Task	Command
Display traffic rate statistics of interfaces in up state over the last sampling interval.	display counters rate { inbound outbound } interface [<i>interface-type</i> [<i>interface-number</i> <i>interface-number.subnumber</i>]]
Display the operational and status information of the specified interface or all interfaces.	display interface [<i>interface-type</i> [<i>interface-number</i> <i>interface-number.subnumber</i>]]
Display summary information about the specified interface or all interfaces.	display interface [<i>interface-type</i> [<i>interface-number</i> <i>interface-number.subnumber</i>]] brief [description]
Display information about dropped packets on the specified interface or all interfaces.	display packet-drop { interface [<i>interface-type</i> [<i>interface-number</i>]] summary }
Display the Ethernet statistics (MSR2000/MSR3000).	display ethernet statistics
Display the Ethernet statistics (MSR4000).	display ethernet statistics slot <i>slot-number</i>
Clear the interface or subinterface statistics.	reset counters interface [<i>interface-type</i> [<i>interface-number</i> <i>interface-number.subnumber</i>]]
Clear the statistics of dropped packets on the specified interfaces.	reset packet-drop interface [<i>interface-type</i> [<i>interface-number</i>]]
Clear the Ethernet statistics.	reset ethernet statistics

Configuring WAN interfaces

This chapter describes how to configure interfaces for connecting to WAN networks, including ATM and ISDN. Available WAN interfaces include the asynchronous serial interface, synchronous serial interface, ATM interface, ISDN BRI interface, and CE1/PRI interface.

For more information about ATM interfaces, see "Configuring ATM and DSL interfaces."

Configuring a serial interface

Overview

Asynchronous serial interface

The following types of asynchronous serial interfaces are available:

- Synchronous/asynchronous serial interface operating in asynchronous mode, whose interface index begins with **Serial**.
- Dedicated asynchronous serial interface, whose interface index begins with **Async**.

An asynchronous serial interface can operate in flow mode or protocol mode. It can operate as a dialup interface when having a modem or an ISDN terminal adapter (TA) attached to it. You can encapsulate an asynchronous serial interface in protocol mode with PPP on the data link layer to provide support for network layer protocols such as IP.

Synchronous serial interface

A synchronous serial interface has the following features:

- Operates in either DTE or DCE mode. Usually, it serves as a DTE to accept the clock provided by DCE.
- Connected by various types of cables, such as V.24, V.35, X.21, RS449, and RS530. Your device can automatically detect the type of connected cables and select electrical properties. In most cases, you do not need to manually configure them.
- Supports link layer protocols such as PPP or HDLC.
- Supports network layer protocol IP.
- Provides information about the connected cable type, operating mode (DTE or DCE), and so on after you run the **display interface serial** command.

Configuring an asynchronous serial interface

Configure PPP, DDR, IP address, firewall, and interface backup for the asynchronous serial interface if the network requires.

To configure an asynchronous serial interface:

Step	Command	Remarks
1. Enter system view.	system-view	N/A

Step	Command	Remarks
2. Enter asynchronous serial interface view.	interface async <i>interface-number</i> or interface serial <i>interface-number</i>	N/A
3. (Optional.) Set the interface description.	description <i>text</i>	By default, the description of an asynchronous serial interface is <i>interface name</i> Interface, for example, Serial2/0 Interface.
4. Configure a synchronous or asynchronous serial interface to operate as an asynchronous serial interface.	physical-mode async	By default, a synchronous or asynchronous serial interface operates as a synchronous serial interface. Skip this step if the interface is an Async interface.
5. Set the link layer protocol.	link-protocol ppp	The default is PPP.
6. Set the operating mode.	async mode { flow protocol }	The default is the protocol mode.
7. (Optional.) Enable level detection.	detect dsr-dtr	By default, level detection is enabled.
8. (Optional.) Enable local loopback.	loopback	By default, local loopback is disabled.
9. Set the MTU.	mtu <i>size</i>	The default is 1500 bytes.
10. Set the keepalive transmission interval.	timer-hold <i>seconds</i>	The default is 10 seconds.
11. (Optional.) Eliminate the pulses with a width less than 3.472 μ s.	eliminate-pulse	By default, the pulses with a width less than 1.472 μ s are eliminated.
12. Set the MRU for an interface operating in flow mode.	phy-mru <i>mrusize</i>	The default MRU is 1700 bytes.
13. (Optional.) Set the intended bandwidth for the asynchronous serial interface.	bandwidth <i>bandwidth-value</i>	By default, the expected bandwidth (in kbps) is the interface baud rate divided by 1000.
14. (Optional.) Restore the default settings for the asynchronous serial interface.	default	N/A
15. Bring up the asynchronous serial interface.	undo shutdown	By default, an asynchronous serial interface is up.

Configuring a synchronous serial interface

Configure PPP, DDR, IP address, firewall, and interface backup for the synchronous serial interface if the network requires.

To configure a synchronous serial interface:

Step	Command	Remarks
1. Enter system view.	system-view	N/A
2. Enter synchronous serial interface view.	interface serial <i>interface-number</i>	N/A
3. Configure a synchronous or asynchronous serial interface to operate as a synchronous serial interface.	physical-mode sync	By default, a synchronous or asynchronous serial interface operates as a synchronous serial interface.
4. (Optional.) Set the interface description.	description <i>text</i>	By default, the description of a synchronous serial interface is <i>interface name</i> Interface, for example, Serial2/0 Interface.
5. Set the link layer protocol.	link-protocol { hdlc ppp }	The default is PPP.
6. Set the digital signal coding format.	code { nrz nrzi }	The default is non-return-to-zero (NRZ).
7. Set the baud rate.	baudrate <i>baudrate</i> virtualbaudrate <i>virtualbaudrate</i>	The default is 64000 bps. These commands are available to synchronous/asynchronous serial interface operating in asynchronous mode only.
8. Set the clock selection mode.	<ul style="list-style-type: none"> On DTE side: clock { dteclk1 dteclk2 dteclk3 dteclk4 dteclk5 dteclkauto } On DCE side: clock { dceclk1 dceclk2 dceclk3 } 	The default is dceclk1 for DCE side and dteclk1 for DTE side.
9. (Optional.) Set transmit-clock or receive-clock signal inversion on the DTE side.	invert { transmit-clock receive-clock }	By default, clock signal inversion is disabled.
10. Set the MTU.	mtu <i>size</i>	The default is 1500 bytes.
11. Set the CRC mode.	crc { 16 32 none }	The default is 16-bit CRC.
12. Set the number of interframe filling tags.	itf number <i>number</i>	The default is 4.
13. (Optional.) Enable level detection.	detect dsr-dtr	By default, level detection is enabled.
14. (Optional.) Enable data carrier detection (DCD).	detect dcd	By default, DCD is enabled.
15. (Optional.) Enable local loopback.	loopback	By default, local loopback is disabled.
16. Configure the polling interval.	timer-hold <i>seconds</i>	The default is 10 seconds.
17. Set the line idle-code.	idle-code { 7e ff }	The default is 0x7E.
18. (Optional.) Enable RTS signal reverse.	reverse-rts	By default, RTS signal reverse is disabled.

Step	Command	Remarks
19. (Optional.) Set the intended bandwidth for the synchronous serial interface.	bandwidth <i>bandwidth-value</i>	By default, the expected bandwidth (in kbps) is the interface baud rate divided by 1000.
20. (Optional.) Restore the default settings for the synchronous serial interface.	default	N/A
21. Bring up the synchronous serial interface.	undo shutdown	By default, a synchronous serial interface is up.

Displaying and maintaining serial interfaces

Execute **display** commands in any view and **reset** commands in user view.

Task	Command
Display information about the specified serial interfaces.	display interface [serial] [brief [down]]
	display interface [serial [<i>interface-number</i>]] [brief [description]]
	display interface [async] [brief [down]]
	display interface [async [<i>interface-number</i>]] [brief [description]]
Clear statistics on a specified serial interface.	reset counters interface [serial [<i>interface-number</i>]]
	reset counters interface [async [<i>interface-number</i>]]

Configuring an AM interface

Overview

Analog modem (AM) interfaces bring services provided by asynchronous serial interfaces and analog modems together. Most of the configuration commands used on asynchronous serial interfaces and modems can be directly used on AM interfaces. When you configure an AM interface, you can treat it as a special asynchronous serial interface.

AM interfaces provide dial-in and dial-out services for analog dial-up users.

Theoretically, if the peer (usually an ISP) uses a digital modem, the AM interface can establish connection with the V.90 Modem standard to provide downstream rates up to 56 kbps and upstream rates up to 33.6 kbps. If the peer (usually a common user) uses an analog modem (or an AM interface), the AM interface can establish connection with the V.34 Modem standard to provide rates (both downstream and upstream) up to 33.6 kbps.

The real rate of an AM interface, however, might deviate somewhat depending on the line quality, PBX performance, connection protocol, and other elements.

Configuration procedure

The configuration of AM interface is similar to that of asynchronous interface and modem, except that an AM interface does not support the **modem auto-answer** and the **baudrate** commands. For more information about modem configuration, see *Layer 2—WAN Configuration Guide*.

To set the baud rate for an AM interface, use the **speed** command in user line view. For more information, see *Fundamentals Configuration Guide*.

Configure PPP, DDR, IP address, firewall, and interface backup on the AM interface if the network requires.

To configure an AM interface:

Step	Command	Remarks
1. Enter system view.	system-view	N/A
2. Enter AM interface view.	interface analogmodem <i>interface-number</i>	N/A
3. Set the coding format of the modem.	country-code <i>area-name</i>	The default is united-states .
4. (Optional.) Set the interface description.	description <i>text</i>	By default, the description of an AM interface is <i>interface name</i> Interface, for example, Analogmodem6/3/0 Interface.
5. Set the operating mode.	async mode { flow protocol }	By default, an AM interface operates in flow mode. When an AM interface is operating in flow mode, no link layer protocol is available. When operating in protocol mode, it uses PPP as the link layer protocol.
6. (Optional.) Enable local loopback.	loopback	By default, local loopback is disabled.
7. Set the MTU.	mtu <i>size</i>	The default is 1500 bytes.
8. Set the keepalive transmission interval.	timer-hold <i>seconds</i>	The default is 10 seconds.
9. Set the MRU for an AM interface operating in flow mode.	phy-mru <i>mrusize</i>	The default MRU is 1700 bytes.
10. (Optional.) Set the intended bandwidth for the AM interface.	bandwidth <i>bandwidth-value</i>	By default, the expected bandwidth (in kbps) is the interface baud rate divided by 1000.
11. (Optional.) Restore the default settings for the AM interface.	default	N/A
12. Bring up the AM interface.	undo shutdown	By default, an AM interface is up.

Displaying and maintaining AM interfaces

Execute **display** commands in any view and **reset** commands in user view.

Task	Command
Display information about the specified AM interfaces.	display interface [analogmodem] [brief [down]] display interface [analogmodem [interface-number]] [brief [description]]
Clear statistics on a specified AM interface.	reset counters interface [analogmodem [interface-number]]

Configuring an ISDN BRI interface

Overview

Integrated services digital network (ISDN) provides all-digital terminal-to-terminal services and fulfills the full digitized delivery of services integrating voice, data, graphics, and video.

ISDN implements digital transmission on a user loop and provides end-to-end digitization. As a standardized digital interface, ISDN BRI interface can forward digital and analog information.

The most commonly used ISDN standards include ITU-T I.430, Q.921, and Q.931 recommendations. All devices that meet ITU-T ISDN standards can access an ISDN network.

ITU-T I.411 standardizes the ISDN user-network interface. It provides the referential ISDN user-network interface configuration as shown in [Figure 1](#) on the basis of function group (a set of functions required for accessing an ISDN network) and reference point (a concept used to differentiate function groups).

Figure 1 Referential ISDN user-network interface configuration

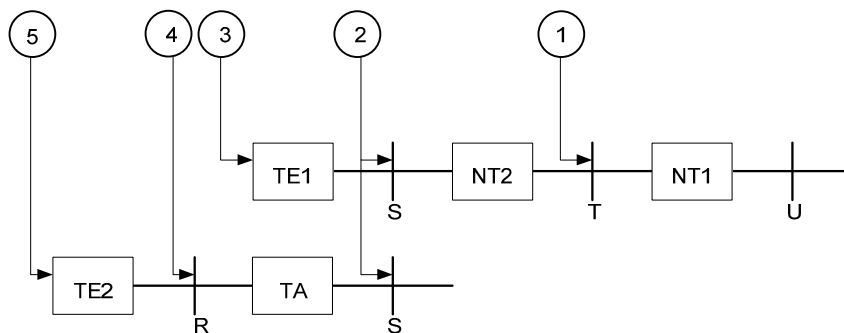

Function groups include:

- Network terminal 1 (NT1) implements the functionality of the first layer in the OSI reference model, such as subscriber-line transmission, loop test, D-channel competition.
- Network terminal 2 (NT2), or named intelligent network terminal, implements the functionality of layers 1 through 3.
- Category-1 terminal equipment (TE1), or named ISDN standard terminal, is user equipment compliant with the ISDN interface provisions. Digital phone-set is such an example.

- Category-2 terminal equipment (TE2), or named non-ISDN standard terminal equipment, refers to the user equipment incompliant with the ISDN interface provisions.
- Terminal adapter (TA) implements the adaptation function so that TE2 can access a standard ISDN interface.

Reference points include:

- R reference point between a non-ISDN equipment and TA.
- S reference point between a user terminal and NT2.
- T reference point between NT1 and NT2.
- U reference point between NT1 and line terminal.

Prerequisites

- Verify the type of the interface provided by your telecom service provider, whether it is ISDN BRI U or ISDN BRI S/T. Despite that ITU-T I.411 has provided an ISDN user-network interface reference model, there are some arguments in the position of the user-network dividing point. Some nations adopt the U interface and some adopt the S/T interface depending on their needs. Identify the interface type provided by your service provider before making a router purchase decision.
- Request for digital service. As ISDN can provide integrated services including both digital and voice, you must request for an ISDN line allowing digital call service so that your router can make digital communications.
- Select the connection type, which can be a point-to-point connection or a point-to-multipoint connection (optional). Because ISDN supports semi-permanent connection, you can use an ISDN leased line for connecting two fixed points. To connect more than two points, you must select a point-to-multipoint connection.
- Request for the delivery of Calling Line Identification (optional). This function can filter calling numbers on an ISDN line to block unauthorized users from the router.

Configuration procedure

ISDN BRI interfaces are used for dialup purpose. For more information about dial-up configuration, see *Layer 2—WAN Configuration Guide*.

To configure an ISDN BRI interface:

Step	Command	Remarks
1. Enter system view.	system-view	N/A
2. Enter ISDN BRI interface view.	interface bri <i>number</i>	N/A
3. (Optional.) Configure the interface description.	description <i>text</i>	By default, the description of an interface is <i>interface-name</i> Interface, for example, Bri1/0 Interface.
4. (Optional.) Enable external loopback on the ISDN BRI interface.	loopback { b1 b2 both }	By default, external loopback is disabled on the ISDN BRI interface.
5. Set the MTU for the BRI interface.	mtu <i>size</i>	The default is 1500 bytes.

Step	Command	Remarks
6. Set the keepalive transmission interval.	timer-hold <i>seconds</i>	The default is 10 seconds.
7. Set the intended bandwidth for the BRI interface.	bandwidth <i>bandwidth-value</i>	By default, the expected bandwidth (in kbps) is the interface baud rate divided by 1000.
8. (Optional.) Restore the default settings for the BRI interface.	default	N/A
9. (Optional.) Bring up the BRI interface.	undo shutdown	By default, a BRI interface is up.
10. (Optional.) Activate the BRI interface.	activate	By default, a BRI interface is not activated.

Displaying and maintaining ISDN BRI interfaces

Execute **display** commands in any view and **reset** commands in user view.

Task	Command
Display information about the specified ISDN BRI interfaces.	display interface [<i>bri</i>] [brief [<i>down</i>]] display interface [<i>bri</i> [<i>interface-number</i>]] [brief [<i>description</i>]]
Clear statistics on a specified ISDN BRI interface.	reset counters interface [<i>bri</i> [<i>interface-number</i>]]

Configuring a CE1/PRI interface

Overview

There are two TDM systems in the data communications system:

- **E1 system**—Recommended by ITU-T and widely used in Europe and P.R. China.
- **T1 system**—Recommended by ANSI and widely used in North American and Japan. (Japan actually uses the J1 system. It is regarded as a T1 system due to the high level of similarity between them.)

A CE1/PRI interface can operate in either E1 mode (also called non-channelized mode) or CE1/PRI mode (also called channelized mode).

- A CE1/PRI interface in E1 mode is an interface of 2.048 Mbps data bandwidth, on which no timeslots are divided. Its logical features are the same as those of a synchronous serial interface. It supports link layer protocols such as PPP, FR, LAPB, and X.25 and the network protocols such as IP and IPX.
- A CE1/PRI interface in CE1/PRI mode is physically divided into 32 timeslots numbered 0 to 31. Timeslot 0 is used to transmit synchronizing information. This interface can be used as either a CE1 interface or a PRI interface.
 - When this interface is used as a CE1 interface, all the timeslots except timeslot 0 can be randomly divided into multiple channel sets and each set can be used as an interface upon

timeslot bundling. Its logical features are the same as those of a synchronous serial interface. It supports link layer protocols such as PPP, HDLC, FR, LAPB, and X.25, and network protocols such as IP.

- When the interface is used as a PRI interface, timeslot 16 will be used as a D channel to transmit signaling. Therefore, rather than selecting among all the timeslots, you are only allowed to make a random B channel selection among the timeslot sets except timeslots 0 and 16. The selected set of timeslots can be bundled together with timeslot 16 to form a PRI set that can be used as an interface. The logical features of this interface are the same as those of an ISDN PRI interface. It supports link layer protocols such as PPP, and network protocols such as IP.

Configuration procedure (in E1 mode)

To configure a CE1/PRI interface in E1 mode:

Step	Command	Remarks
1. Enter system view.	system-view	N/A
2. Enter CE1/PRI interface view.	controller e1 <i>number</i>	N/A
3. Configure the interface to operate in E1 mode.	using e1	By default, a CE1/PRI interface operates in CE1/PRI mode.
4. (Optional.) Configure to perform AIS (alarm indication signal) test.	detect-ais	Optional. By default, AIS test is performed.
5. (Optional.) Set other interface parameters.	See " Configuring other CE1/PRI interface parameters. "	N/A

After you configure the CE1/PRI interface to operate in E1 mode, the system automatically creates a serial interface numbered **serial interface-number:0**. This interface is logically equivalent to a synchronous serial interface where you can make other configurations such as:

- Parameters of data link protocol such as PPP
- IP addressing
- Backup center settings if the interface is used as a primary or secondary interface for backup
- NAT and packet filtering if a firewall is to be set up

Configuration procedure (in CE1 mode)

To configure a CE1/PRI interface in CE1 mode:

Step	Command	Remarks
1. Enter system view.	system-view	N/A
2. Enter CE1/PRI interface view.	controller e1 <i>number</i>	N/A
3. Configure the interface to operate in CE1/PRI mode.	using ce1	The default operating mode is CE1/PRI mode.

Step	Command	Remarks
4. Bundle timeslots on the interface into a channel set.	channel-set <i>set-number</i> timeslot-list <i>list</i>	By default, no channel set is created. The timeslots on a CE1/PRI interface can be bundled into either channel sets or a PRI set, but not the both, at a time.
5. Set the framing format.	frame-format { crc4 no-crc4 }	The default is no-CRC4.
6. (Optional.) Enable RAI detection on the interface.	alarm detect rai	By default, RAI detection is enabled on the interface.
7. (Optional.) Set other interface parameters.	See " Configuring other CE1/PRI interface parameters. "	N/A

A CE1/PRI interface operating in CE1/PRI mode can be used as a CE1 interface where a serial interface is created upon creation of a channel set. You can bundle timeslots on a CE1/PRI interface into up to 31 channel sets.

For each channel set, the system automatically creates a serial interface numbered **serial interface-number: set-number**. This interface is logically equivalent to a synchronous serial interface where you can make other configurations such as:

- Data link protocol such as PPP
- IP addressing
- Backup center settings if the interface is used as a primary or secondary interface for backup
- NAT and packet filtering if a firewall is to be set up

Configuration procedure (in PRI mode)

To configure a CE1/PRI interface in PRI mode:

Step	Command	Remarks
1. Enter system view.	system-view	N/A
2. Enter CE1/PRI interface view.	controller e1 <i>number</i>	N/A
3. Configure the interface to operate in CE1/PRI mode.	using ce1	The default operating mode is CE1/PRI mode.
4. Bundle timeslots on the interface into a PRI set.	pri-set [timeslot-list <i>list</i>]	By default, no PRI set is created. The timeslots on a CE1/PRI interface can be bundled into either channel sets or a PRI set, but not both at a time.
5. (Optional.) Set other interface parameters.	See " Configuring other CE1/PRI interface parameters. "	N/A

A CE1/PRI interface in CE1/PRI mode can be used as a PRI interface where only one PRI set can be created.

For the PRI set, the system automatically creates a serial interface numbered **serial interface-number:15**. This interface is logically equivalent to an ISDN PRI interface where you can make other configurations such as:

- DCC
- PPP and PPP authentication
- IP addressing
- Backup center settings if the interface is to be used as a primary or secondary interface for backup
- Firewall

Configuring other CE1/PRI interface parameters

Step	Command	Remarks
1. Enter system view.	system-view	N/A
2. Enter CE1/PRI interface view.	controller e1 <i>number</i>	N/A
3. Configure the interface description.	description <i>text</i>	By default, the description of an interface is <i>interface-name</i> Interface.
4. Set the line code format.	code { <i>ami</i> <i>hdb3</i> }	The default is high density bipolar 3 (HDB3).
5. Set the cable type.	cable { <i>long</i> <i>short</i> }	The default cable setting is long mode.
6. Set the clock mode.	clock { <i>master</i> <i>slave</i> }	The default clock mode is slave , which is line clock.
7. Enable automatic clock mode change.	clock-change <i>auto</i>	By default, automatic clock mode change is disabled.
8. Set the line idle code type.	idlecode { <i>7e</i> <i>ff</i> }	The default is 0x7E.
9. Set the type of interframe filling tag.	itf type { <i>7e</i> <i>ff</i> }	The default is 0x7E.
10. Set the number of interframe filling tags.	itf number <i>number</i>	The default is 4.
11. Set the loopback mode.	loopback { <i>local</i> <i>payload</i> <i>remote</i> }	By default, loopback is disabled.
12. Enable user data inversion.	data-coding { <i>inverted</i> <i>normal</i> }	By default, user data inversion is disabled.
13. Restore the default settings for the CE1/PRI interface.	default	Optional.
14. Bring up the CE1/PRI interface.	undo shutdown	By default, a CE1/PRI interface is up.
15. Return to system view.	quit	N/A
16. Enter the view of the synchronous serial interface created on the CE1/PRI interface.	interface serial <i>interface-number:set-number</i> or interface serial <i>interface-number:15</i>	N/A

Step	Command	Remarks
17. Set the CRC mode	<code>crc { 16 32 none }</code>	By default, 16-bit CRC is adopted.

Displaying and maintaining CE1/PRI interfaces

Execute **display** commands in any view and **reset** commands in user view.

Task	Command
Display the status of a CE1/PRI interface.	<code>display controller e1 [interface-number]</code>
Display the status of a channel set or PRI set.	<code>display interface serial interface-number:set-number</code>
Clear the controller counter for a CE1/PRI interface.	<code>reset counters controller e1 [interface-number]</code>

Configuring a CT1/PRI interface

Overview

A CT1/PRI interface can operate only in channelized mode. It can be used in the following two ways:

- When it is operating as a CT1 interface, all the timeslots (numbered 1 to 24) can be randomly divided into groups. Each of these groups can form one channel set for which the system automatically creates an interface logically equivalent to a synchronous serial interface. This interface supports link layer protocols such as PPP, HDLC, FR, LAPB, and X.25, and network protocols such as IP and IPX.
- When it is operating as a PRI interface, timeslot 24 is used as a D channel for signaling transmission. Therefore, only a group of timeslots except timeslot 24 can be chosen as the B channel. This timeslot group is bundled together with timeslot 24 to form a PRI set. This PRI set will work as an interface logically equivalent to an ISDN PRI interface where you can configure PPP at the data link layer, IP at the network layer, DCC, and other configurations.

Configuration procedure (in CT1 mode)

To configure a CT1/PRI interface in CT1 mode:

Step	Command	Remarks
1. Enter system view.	<code>system-view</code>	N/A
2. Enter CT1/PRI interface view.	<code>controller t1 number</code>	N/A
3. Bundle timeslots on the interface into a channel set.	<code>channel-set set-number timeslot-list list [speed { 56k 64k }]</code>	By default, no channel sets are bundled. The default timeslot speed is 64 kbps.
4. (Optional.) Set other interface parameters.	See " Configuring other CT1/PRI interface parameters. "	N/A

For each channel set, the system automatically creates a serial interface numbered **serial number:set-number**. This interface is logically equivalent to a synchronous serial interface where you can make other configurations about:

- Data link protocol such as PPP.
- IP addressing.
- Backup center settings if the interface is used as a primary or secondary interface for backup.
- NAT and packet filtering if a firewall is to be set up.

Configuration procedure (in PRI mode)

To configure a CT1/PRI interface in PRI mode:

Step	Command	Remarks
1. Enter system view.	system-view	N/A
2. Enter CT1/PRI interface view.	controller t1 number	N/A
3. Bundle timeslots on the interface into a PRI set.	pri-set [timeslot-list list]	By default, no PRI set is created. Only one PRI set can be created at a time.
4. (Optional.) Set other interface parameters.	See " Configuring other CT1/PRI interface parameters. "	N/A

For the PRI set, the system automatically creates a serial interface numbered **serial number:23**. This interface is logically equivalent to an ISDN PRI interface where you can make other configurations about:

- DCC
- PPP and PPP authentication
- IP addressing
- Backup center settings if the interface is to be used as a primary or secondary interface for backup
- Firewall, if any

Configuring other CT1/PRI interface parameters

Step	Command	Remarks
1. Enter system view.	system-view	N/A
2. Enter CT1/PRI interface view.	controller t1 number	N/A
3. Configure the interface description.	description text	By default, the description of an interface is <i>interface-name</i> Interface.
4. Set the cable length and attenuation.	cable long { 0db -7.5db -15db -22.5db } cable short { 133ft 266ft 399ft 533ft 655ft }	The long 0db keyword applies by default.
5. Set the line code format.	code { ami b8zs }	The default is B8ZS.

Step	Command	Remarks
6. Set the clock mode.	clock { master slave }	The default is slave , which is line clock.
7. Set the framing format.	frame-format { sf esf }	The default is ESF.
8. Enable RAI detection on the interface.	alarm detect rai	By default, RAI detection is enabled on the interface. This command is applicable when the framing format is ESF.
9. Enable user data inversion.	data-coding { normal inverted }	By default, user data inversion is disabled.
10. Set the line idle code type.	idlecode { 7e ff }	The default is 0x7E.
11. Set the type of interframe filling tag.	itf type { 7e ff }	The default is 0x7E.
12. Set the number of interframe filling tags.	itf number <i>number</i>	The default is 4.
13. Set alarm thresholds.	alarm-threshold { ais { level-1 level-2 } lfa { level-1 level-2 level-3 level-4 } los { pulse-detection pulse-recovery } <i>value</i> }	By default: <ul style="list-style-type: none"> For LOS alarm, the threshold of pulse-detection is 176 and the threshold of pulse-recovery is 22. If the number of the pulses detected during the total length of 176 pulse detection intervals is smaller than 22, the pulse-recovery threshold, a LOS alarm occurs. Both AIS alarm threshold and LFA⁵ alarm threshold are level-1.
14. Set the behavior of the interface on the FDL in ESF framing.	fdl { ansi att both none }	The default is none, meaning that FDL is forbidden.
15. Enable loopback.	loopback { local payload remote }	By default, loopback is disabled.
16. Send remote loopback control code.	sendloopcode { fdl-ansi-llb-down fdl-ansi-llb-up fdl-ansi-plb-down fdl-ansi-plb-up fdl-att-plb-down fdl-att-plb-up inband-llb-down inband-llb-up }	By default, no remote loopback control code is sent.
17. Restore the default settings for the CT1/PRI interface.	default	N/A
18. (Optional.) Bring up the CT1/PRI interface.	undo shutdown	By default, a CT1/PRI interface is up.
19. Enter the view of the synchronous serial interface created on the CT1/PRI interface.	interface serial <i>interface-number: set-number</i> or interface serial <i>interface-number: 23</i>	N/A
20. Set the CRC mode.	crc { 16 32 none }	By default, 16-bit CRC is adopted.

Starting/terminating a BERT test on a CT1/PRI interface

Bit error rate test (BERT) operates as follows:

The local end sends out a pattern, which is to be looped over somewhere on the line and back to the local end. The local end then checks the received pattern for the bit error rate, and by so doing helps you determine whether the condition of the line is good. To this end, you must configure loopback to allow the transmitted pattern to loop back from somewhere on the line, for example, from the far-end interface by placing the interface in far-end loopback.

You can view the state and result of the BERT test with the **display controller t1** command.

To start/terminate a BERT test on a CT1/PRI interface:

Step	Command	Remarks
1. Enter system view.	system-view	N/A
2. Enter CT1/PRI interface view.	controller t1 <i>number</i>	N/A
3. Start a BERT test.	bert pattern { 2^20 2^15 } time <i>minutes</i> [unframed]	By default, no BERT test is performed.

Displaying and maintaining CT1/PRI interfaces

Execute **display** commands in any view and **reset** commands in user view.

Task	Command
Display the status of a CT1/PRI interface.	display controller t1 [<i>interface-number</i>]
Display the status of a channel set or PRI set.	display interface serial <i>interface-number: set-number</i>
Clear the controller counter for a CE1/PRI interface.	reset counters controller t1 [<i>interface-number</i>]

Configuring an E1-F interface

Overview

E1-F interfaces, which are fractional E1 interfaces, are simplified CE1/PRI interfaces. They are a cost-effective alternative to CE1/PRI interfaces where E1 access does not need multiple channel sets or ISDN PRI.

Compared with a CE1/PRI interface, an E1-F interface delivers these features:

- In framed mode, it can only bind timeslots into one channel set, but a CE1/PRI interface can group and bundle timeslots randomly into multiple channel sets.
- It does not support PRI mode.

An E1-F interface can operate in either framed (the default) or unframed mode.

When an E1-F interface is operating in unframed mode, it is a non-timeslot interface with 2048 kbps of data bandwidth. It is logically equivalent to a synchronous serial interface where you can configure PPP, HDLC, FR, LAPB or X.25 at the link layer and IP at the network layer.

When an E1-F interface is operating in framed mode, it is physically divided into 32 timeslots numbered 0 through 31. Except timeslot 0 used for transmitting synchronization information, all other timeslots can randomly form one channel set. The rate of the interface is $n \times 64$ kbps and its logical features are the same as those of a synchronous serial interface where you can configure PPP, FR, LAPB and X.25 at the data link layer and IP or IPX at the network layer.

Configuration procedure (in framed mode)

To configure an E1-F interface in framed mode:

Step	Command	Remarks
1. Enter system view.	system-view	N/A
2. Enter E1-F interface view.	interface serial <i>interface-number</i>	N/A
3. Configure the interface to operate in framed mode.	undo fe1 unframed	The default is framed mode.
4. Bundle timeslots on the interface.	fe1 timeslot-list <i>range</i>	By default, if no timeslot range is specified, all timeslots are bundled.
5. Set the framing format.	fe1 frame-format { crc4 no-crc4 }	The default is no-CRC4.
6. (Optional.) Enable RAI detection on the interface.	fe1 alarm detect rai	By default, RAI detection is enabled on the interface.
7. (Optional.) Set other interface parameters.	See " Configuring other E1-F interface parameters. "	N/A

Configuration procedure (in unframed mode)

To configure an E1-F interface in unframed mode:

Step	Command	Remarks
1. Enter system view.	system-view	N/A
2. Enter E1-F interface view.	interface serial <i>interface-number</i>	N/A
3. Configure the interface to operate in unframed mode.	fe1 unframed	The default is framed mode.
4. (Optional.) Perform AIS test.	fe1 detect-ais	By default, AIS test is performed.
5. (Optional.) Set other interface parameters.	See " Configuring other E1-F interface parameters. "	N/A

Configuring other E1-F interface parameters

Step	Command	Remarks
1. Enter system view.	system-view	N/A
2. Enter E1-F interface view.	interface serial <i>serial-number</i>	N/A
3. Configure the interface description.	description <i>text</i>	By default, the description of an interface is <i>interface-name</i> Interface.
4. Set the line code format.	fe1 code { ami hdb3 }	The default is HDB3.
5. Set the clock mode.	fe1 clock { master slave }	The default is slave , which is line clock.
6. Enable automatic clock mode change.	clock-change auto	By default, automatic clock mode change is disabled.
7. Set the cable type.	fe1 cable { long short }	By default, the cable type is long.
8. Configure the CRC mode.	crc { 16 32 none }	The default is 16-bit CRC.
9. Set the line idle code type.	fe1 idlecode { 7e ff }	The default is 0x7E.
10. Set the interframe filling tag type.	fe1 if type { 7e ff }	The default is 0x7E.
11. Set the number of interframe filling tags.	fe1 if number <i>number</i>	The default is 4.
12. Enable loopback and set the loopback mode.	fe1 loopback { local payload remote }	By default, loopback is disabled.
13. (Optional.) Enable user data reversion.	fe1 data-coding { inverted normal }	By default, user data reversion is disabled.
14. Set the MTU for the BRI interface.	mtu <i>size</i>	The default is 1500 bytes.
15. Set the keepalive transmission interval.	timer-hold <i>seconds</i>	The default is 10 seconds.
16. Set the intended bandwidth for the E1-F interface.	bandwidth <i>bandwidth-value</i>	By default, the expected bandwidth (in kbps) is the interface baud rate divided by 1000.
17. Restore the default settings for the E1-F interface.	default	N/A
18. Shut down the E1-F interface.	undo shutdown	By default, an E1-F interface is up.

Displaying and maintaining E1-F interfaces

Execute **display** commands in any view and **reset** commands in user view.

Task	Command
Display the configuration and status of a specified or all E1-F interfaces.	display fe1 [serial <i>interface-number</i>]

Task	Command
Display the status of an E1-F interface.	display interface serial <i>interface-number</i>
Clear the controller counter of a E1-F interface.	reset counters interface [serial [<i>interface-number</i>]]

Configuring a T1-F interface

Overview

T1-F interfaces, fractional T1 interfaces, are simplified CT1/PRI interfaces. They are a cost-effective alternative to CT1/PRI interfaces where T1 access does not need multiple channel sets or ISDN PRI.

Compared with a CT1/PRI interface, a T1-F interface delivers these features:

- In framed mode, it can bind timeslots into only one channel set, but a CT1/PRI interface can group and bundle timeslots randomly into multiple channel sets.
- It does not support PRI mode.

A T1 line is multiplexed from 24 channels. A T1 primary group frame DS1 (digital signal level-1) comprises 24 DS0 (64 kbps) timeslots and 1 framing bit for synchronization, with each timeslot being 8 bits. Each primary group frame has 193 bits ($24 \times 8 + 1$). As DS1 can transmit 8000 frames per second, its transmission speed is 1544 kbps (193×8 kbps).

A T1-F interface can only operate in framed mode. Timeslots 1 through 24 on it can randomly form a channel set. The rate of the interface is $n \times 64$ kbps or $n \times 56$ kbps and its logical features are the same as those of a synchronous serial interface where you can configure PPP, FR, LAPB and X.25 at the data link layer and IP at the network layer.

Configuration procedure

To configure a T1-F interface:

Step	Command	Remarks
1. Enter system view.	system-view	N/A
2. Enter T1-F interface view.	interface serial <i>interface-number</i>	N/A
3. (Optional.) Configure the interface description.	description <i>text</i>	By default, the description of an interface is <i>interface-name</i> Interface.
4. Bundle timeslots on the interface into a channel set.	ft1 timeslot-list <i>range</i> [speed { 56k 64k }]	By default, if no timeslot range is specified, all timeslots are bundled into one channel set. The default timeslot speed is 64 kbps, and the default T1-F interface speed is 1536 kbps.
5. Set the cable length and attenuation.	ft1 cable { long <i>decibel</i> short <i>length</i> }	By default, the long 0db keyword applies.

Step	Command	Remarks
6. Set the line code format.	ft1 code { ami b8zs }	The default is B8ZS.
7. Set the clock mode.	ft1 clock { master slave }	The default is slave , which is line clock.
8. Set the framing format.	ft1 frame-format { esf sf }	The default is esf .
9. (Optional.) Enable RAI detection on the interface.	ft1 alarm detect rai	By default, RAI detection is enabled on the interface. This command is applicable when the framing format is ESF.
10. (Optional.) Enable user data inversion.	ft1 data-coding { inverted normal }	By default, user data inversion is disabled.
11. Set the type of line idle code.	ft1 idlcode { 7e ff }	The default is 0x7E.
12. Set the type of interframe filling tag.	ft1 ift type { 7e ff }	The default is 0x7E.
13. Set the number of interframe filling tags.	ft1 ift number <i>number</i>	The default is 4.
14. Set alarm thresholds.	ft1 alarm-threshold { ais { level-1 level-2 } lfa { level-1 level-2 level-3 level-4 } los { pulse-detection pulse-recovery } <i>value</i> }	By default: <ul style="list-style-type: none"> For LOS alarm, the threshold of pulse-detection is 176 and the threshold of pulse-recovery is 22. If the number of the pulses detected during the total length of 176 pulse detection intervals is smaller than 22, the pulse-recovery threshold, a LOS alarm occurs. Both AIS alarm threshold and LFA alarm threshold are level-1.
15. Set the behavior of the interface on the FDL in ESF framing.	ft1 fdl { ansi att both none }	By default, FDL is disabled.
16. (Optional.) Enable loopback and set the loopback mode.	ft1 loopback { local payload remote }	By default, loopback is disabled.
17. (Optional.) Send remote control loopback code.	ft1 sendloopcode { fdl-ansi-llb-down fdl-ansi-llb-up fdl-ansi-plb-down fdl-ansi-plb-up fdl-att-plb-down fdl-att-plb-up inband-llb-down inband-llb-up }	By default, no remote control code is sent.
18. Set the CRC mode.	crc { 16 32 none }	By default, 16-bit CRC is adopted.
19. Set the MTU for the BRI interface.	mtu <i>size</i>	The default is 1500 bytes.
20. Set the keepalive transmission interval.	timer-hold <i>seconds</i>	The default is 10 seconds.
21. (Optional.) Set the intended bandwidth for the T1-F interface.	bandwidth <i>bandwidth-value</i>	By default, the expected bandwidth (in kbps) is the interface baud rate divided by 1000.

Step	Command	Remarks
22. (Optional.) Restore the default settings for the T1-F interface.	default	N/A
23. Bring up the T1-F interface.	undo shutdown	By default, a T1-F interface is up.

Starting/terminating a BERT test on a T1-F interface

BERT is operating as follows:

The local end sends out a pattern, which is to be looped over somewhere on the line and back to the local end. The local end then checks the received pattern for the bit error rate, and by so doing helps you determine whether the condition of the line is good. To this end, you must configure loopback to allow the transmitted pattern to loop back from somewhere on the line, for example, from the far-end interface by placing the interface in far-end loopback.

You can view the state and result of the BERT test with the **display ft1 serial** command.

To start/terminate a BERT test on a T1-F interface:

Step	Command	Remarks
1. Enter system view.	system-view	N/A
2. Enter T1-F interface view.	interface serial <i>interface-number</i>	N/A
3. Start a BERT test.	ft1 bert pattern { 2^{20} 2^{15} } time <i>minutes</i> [unframed]	By default, no BERT test is performed.

Displaying and maintaining T1-F interfaces

Execute **display** commands in any view and **reset** commands in user view.

Task	Command
Display information about a specified or all T1-F interfaces.	display ft1 [serial <i>interface-number</i>]
Display the status of a specified T1-F interface.	display interface serial <i>interface-number</i>
Clear the controller counter of a T1-F interface.	reset counters interface [serial [<i>interface-number</i>]]

Configuring a CE3 interface

Overview

E3 belongs to the digital carrier system of ITU-T. It transmits data at 34.368 Mbps and adopts HDB3 as the line code format.

A CE3 interface can operate in either E3 or CE3 (the default) mode.

- A CE3 interface in E3 mode is an interface with 34.368 Mbps data bandwidth, on which, no timeslots are divided. The system automatically creates a serial interface numbered **serial number/line-number:0:0** for it. This interface operates at 34.368 Mbps and is logically equivalent to a synchronous serial interface where you can make other configurations.
- A CE3 interface in CE3 mode can demultiplex 16 channels of E1 signals in compliance with ITU-T G.751 and G.742. Each E1 line can be divided into 32 timeslots numbered 0 to 31, of which timeslots 1 through 31 can be randomly bundled into $N \times 64$ kbps logical channels. (Timeslot 0 for framing signal transmission must not participate in bundling operation.) Therefore, CE3 can be channelized into E1 lines or CE1 lines.

When an E1 line is operating in unframed (E1) mode, the system automatically creates a serial interface numbered **serial number/line-number:0** for it. This interface operates at 2048 kbps and is logically equivalent to a synchronous serial interface where you can make other configurations.

When the E1 line is operating in framed (CE1) mode, you can bundle timeslots on it. The system automatically creates a serial interface numbered **serial number/line-number:set-number** for it. This interface operates at $N \times 64$ kbps and is logically equivalent to a synchronous serial interface where you can make other configurations.

CE3 interfaces support link layer protocols PPP, HDLC, FR, LAPB, and X.25 and network protocol IP.

Configuration procedure (in E3 mode)

To configure a CE3 interface in E3 mode:

Step	Command	Remarks
1. Enter system view.	system-view	N/A
2. Enter CE3 interface view.	controller e3 <i>interface-number</i>	N/A
3. (Optional.) Configure the interface to operate in E3 mode.	using e3	The default operating mode is CE3 mode.
4. (Optional.) Configure the interface to operate in FE3 mode and set the DSU mode or the substrate.	fe3 { dsu-mode { 0 1 } substrate number }	By default, DSU mode 1 (the Kentrox mode) is adopted, and the substrate is 34010 kbps.
5. (Optional.) Configure the interface description.	description <i>text</i>	By default, the description of an interface is <i>interface-name</i> Interface.
6. (Optional.) Configure the CE3 interface to perform BERT test.	bert pattern { 2^7 2^11 2^15 qrss } time number [unframed]	By default, no BERT test is performed.
7. (Optional.) Set the clock mode.	clock { master slave }	The default mode for both the CE3 interface and E1 line is slave , which is line clock.
8. (Optional.) Set the national bit.	national-bit { 0 1 }	The default is 1.
9. (Optional.) Enable loopback.	loopback { local payload remote }	By default, loopback is disabled.
10. (Optional.) Restore the default settings for the CE3 interface.	default	N/A

Step	Command	Remarks
11. (Optional.) Bring up the CE3 interface.	undo shutdown	By default, a CE3 interface is up. Use this command with caution, because once an interface is shut down, it stops operating.
12. Return to system view.	quit	N/A
13. Enter synchronous serial interface view of an interface formed by a CE3 interfaces.	<ul style="list-style-type: none"> interface serial <i>number/line-number:0</i> interface serial <i>number/line-number:set-number</i> 	N/A
14. Set the CRC mode.	crc { 16 32 none }	By default, 16-bit CRC is adopted.

Configure PPP, FR, and IP address for the CE3 interface if the network requires.

Configuration procedure (in CE3 mode)

Shutting down/bringing up a CE3 interface also shuts down/brings up the E1 lines demultiplexed from the CE3 interface, the serial interfaces formed by the E1 lines, and the serial interfaces created on E1 lines by means of timeslot bundling.

Shutting down/bringing up an E1 line also shuts down/brings up the serial interface formed by it and the serial interface created on it by means of timeslot bundling.

To shut down/bring up only a serial interface formed by E3 or E1 lines, or by timeslot bundling on an E1 line, run the **shutdown/undo shutdown** command in the view of the corresponding serial interface.

To configure a CE3 interface in CE3 mode:

Step	Command	Remarks
1. Enter system view.	system-view	N/A
2. Enter CE3 interface view.	controller e3 <i>interface-number</i>	N/A
3. Configure the interface to operate in CE3 mode.	using ce3	The default operating mode is CE3 mode.
4. (Optional.) Set the operating mode of an E1 line on the CE3 interface to unframed mode or framed mode.	<ul style="list-style-type: none"> Approach 1: Set the operating mode to unframed (E1) mode: e1 <i>line-number</i> unframed Approach 2: Set the operating mode to framed (CE1) mode and bundle timeslots on the CE1 interface: <ul style="list-style-type: none"> a. (Optional) undo e1 <i>line-number</i> unframed b. e1 <i>line-number</i> channel-set <i>set-number</i> timeslot-list <i>list</i> 	By default: <ul style="list-style-type: none"> In approach 1, the operating mode is CE1. In approach 2, the operating mode is framed, and no channel sets are created.

Step	Command	Remarks
5. (Optional.) Configure the interface description.	description <i>text</i>	By default, the description of an interface is <i>interface-name</i> Interface.
6. (Optional.) Configure the CE3 interface to perform BERT test, and configure the CE3 interface to perform BERT test on an E1 channel created on the interface.	bert pattern { 2^7 2^11 2^15 qrss } time <i>number</i> [unframed] e1 <i>line-number</i> bert pattern { 2^11 2^15 2^20 2^23 qrss } time <i>number</i> [unframed]	By default, no BERT test is performed.
7. (Optional.) Set the clock mode.	<ul style="list-style-type: none"> For the CE3 interface: clock { master slave } For an E1 line: e1 <i>line-number</i> set clock { master slave } 	The default mode for both the CE3 interface and E1 line is slave , which is line clock.
8. (Optional.) Set the national bit.	national-bit { 0 1 }	The default is 1.
9. (Optional.) Enable loopback.	<ul style="list-style-type: none"> For the CE3 interface: loopback { local payload remote } For an E1 line: e1 <i>line-number</i> set loopback { local remote payload } 	By default, loopback is disabled.
10. Set E1 framing format on an E1 line.	e1 <i>line-number</i> set frame-format { crc4 no-crc4 }	The default is no-crc4 .
11. (Optional.) Restore the default settings for the CE3 interface.	default	N/A
12. (Optional.) Bring up the CE3 interface.	undo shutdown	By default, a CE3 interface is up. Use this command with caution, because once an interface is shut down, it stops operating.
13. Return to system view.	quit	N/A
14. Enter synchronous serial interface view of an interface formed by a CE3 interfaces.	<ul style="list-style-type: none"> interface serial <i>number/line-number:0</i> interface serial <i>number/line-number:set-number</i> 	N/A
15. Set the CRC mode.	crc { 16 32 none }	By default, 16-bit CRC is adopted.

Configure PPP, FR, and IP address for the CE3 interface if the network requires.

Displaying and maintaining CE3 interfaces

Execute **display** commands in any view and **reset** commands in user view.

Task	Command
Display the state information of a CE3 interface.	display controller e3 [<i>interface-number</i>]

Task	Command
Display the configuration and state of a serial interface formed on a CE3 interface.	display interface serial <i>interface-number</i>
Clear the controller counter of a CE3 interface.	reset counters controller e3 [<i>interface-number</i>]

Configuring POS interfaces

The following matrix shows the POS interface feature and router compatibility:

Feature	MSR2000	MSR3000	MSR4000
POS interface	No	Yes	Yes

Overview

SONET

Synchronous Optical Network (SONET) adopts optical transmission. It is a synchronous transmission system defined by the ANSI and is an international standard transmission protocol.

SDH

ITU-T Synchronous Digital Hierarchy (SDH) uses a SONET rate subset. SDH adopts synchronous multiplexing and allows for flexible mapping structure. It can add or drop low-speed tributary signals to or from SDH signals without a large amount of multiplexing/demultiplexing devices. This reduces signal attenuation and decreases device investments.

POS

Packet over SONET/SDH (POS) is a technology widely used on WAN and MAN. It supports data packets such as IP packets.

POS maps length-variable packets directly to SONET synchronous payloads and uses the SONET physical layer transmission standard. It offers high-speed, reliable, and point-to-point data connectivity.

The POS interfaces on your device support PPP and HDLC at the data link layer and IP at the network layer. Depending on your device model, the transmission rate of POS interfaces can be STM-1, STM-4, and STM-16. The rate of a level is four times the nearest lower level.

Configuring a POS interface or POS subinterface

Configuration prerequisites

- Before you configure the link layer and network layer protocols on a POS interface, you must configure its physical parameters.
- (Optional.) Configure the interface backup parameters to have the interface participate in backup.
- (Optional.) Configure packet filtering rules to set up a firewall on the interface.

Configuring a POS interface

Step	Command	Remarks
1. Enter system view.	system-view	N/A
2. Enter POS interface view.	interface pos <i>interface-number</i>	N/A
3. Set the interface description.	description <i>text</i>	By default, the description of a POS interface is <i>interface name</i> Interface, for example, Pos5/0 Interface.
4. Set the polling interval.	timer-hold <i>seconds</i>	The default setting is 10 seconds.
5. Set the clock mode.	clock { master slave }	The default setting is slave.
6. Set the CRC length.	crc { 16 32 }	The default setting is 32 bits.
7. Set the loopback mode.	loopback { local remote }	By default, loopback is disabled.
8. Configure the overhead bytes.	flag c2 <i>flag-value</i>	By default, the C2 overhead byte is 0x16.
	flag { j0 j1 } { sdh sonet } <i>flag-value</i>	By default, the SDH framing applies. In SDH framing, both J0 and J1 overhead bytes are null. In SONET framing, the J0 overhead byte is 0x01 and J1 overhead byte is null.
9. Set the framing format.	frame-format { sdh sonet }	The default setting is SDH.
10. Configure scrambling.	scramble	By default, scrambling is enabled.
11. Set the link layer protocol.	link-protocol { hdlc ppp }	The default setting is PPP.
12. Set the MTU.	mtu <i>size</i>	The default setting is 1500 bytes.
13. Configure the expected bandwidth of the interface.	bandwidth <i>bandwidth-value</i>	By default, the expected bandwidth (in kbps) is the interface baud rate divided by 1000.
14. Restore the default settings for the POS interface.	default	N/A
15. Shutdown or bring up the POS interface.	<ul style="list-style-type: none"> Shut down the POS interface: undo shutdown Bring up the POS interface: undo shutdown 	<p>By default, a POS interface is up. When you modify parameters on a POS interface, execute the shutdown command and then the undo shutdown command to make your modifications take effect.</p> <p>If no cable is connected to a physical interface, shut down the interface with the shutdown command to prevent problems.</p> <p>Use the shutdown command with caution. Once an interface is shut down, the interface stops operating.</p>

Displaying and maintaining POS interfaces

Execute **display** commands in any view and **reset** commands in user view.

Task	Command
Display information about one or all POS interfaces.	display interface [pos] [brief [down]] display interface [pos [interface-number]] [brief [description]]
Clear statistics of one or all POS interfaces.	reset counters interface [pos [interface-number]]

Configuration example for directly connecting routers through POS interfaces

Network requirements

As shown in Figure 2, use a pair of single mode optic fibers (for receiving and sending data, respectively) to connect the POS interfaces on Router A and Router B.

Encapsulate the interfaces with PPP.

Figure 2 Network diagram

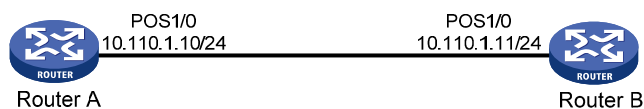

Configuration procedure

1. Configure Router A:

Configure interface POS 1/0, setting its physical parameters to defaults.

```
<RouterA> system-view
[RouterA] interface pos 1/0
[RouterA-Pos1/0] ip address 10.110.1.10 255.255.255.0
[RouterA-Pos1/0] link-protocol ppp
[RouterA-Pos1/0] mtu 1500
[RouterA-Pos1/0] shutdown
[RouterA-Pos1/0] undo shutdown
```

2. Configure Router B:

Configure interface POS 1/0.

```
<RouterB> system-view
[RouterB] interface pos 1/0
# Set the clock mode to master and other physical parameters to defaults.
[RouterB-Pos1/0] clock master
[RouterB-Pos1/0] ip address 10.110.1.11 255.255.255.0
[RouterB-Pos1/0] link-protocol ppp
[RouterB-Pos1/0] mtu 1500
```

```
[RouterB-Pos1/0] shutdown
[RouterB-Pos1/0] undo shutdown
```

Verifying the configuration

Check the interface connectivity between the POS interfaces with the **display interface pos** command and test network connectivity with the **ping** command.

Troubleshooting POS interfaces

Symptom 1

The physical state of POS interface is down.

Solution

- Check that the transmitting and receiving fibers-optic are correctly connected to the POS interface. If you connect the two ends of a fiber-optic to the transmitting end and the receiving end of the same POS interface, a "loopback detected" message is displayed on the screen even if loopback is not enabled when you execute the **display interface** command.
- If the two routers are directly connected back to back, check that the internal clock is enabled on either of the two POS interfaces.

Symptom 2

The physical layer is up but the link layer is down.

Solution

Check the following items:

- The configurations of clock mode, scrambling, and other physical parameters are consistent on the connected two POS interfaces.
- The same link layer protocol is configured on two sides.
- Both ends are assigned IP addresses.

Symptom 3

A large amount of IP packets are dropped.

Solution

Check the following items:

- The correct clock mode is configured on the POS interface. If not, a large amount of CRC errors can be generated, which might cause IP packet drop.
- The MTU configuration is appropriate.

Configuring loopback, null, and inloopback interfaces

This chapter describes how to configure a loopback interface, a null interface, and an inloopback interface.

Configuring a loopback interface

A loopback interface is a virtual interface. The physical layer state of a loopback interface is always up unless the loopback interface is manually shut down. Because of this benefit, loopback interfaces are widely used in the following scenarios:

- **Configuring a loopback interface address as the source address of the IP packets that the device generates**—Because loopback interface addresses are stable unicast addresses, they are usually used as device identifications. When you configure a rule on an authentication or security server to permit or deny packets that a device generates, you can simplify the rule by configuring it to permit or deny packets carrying the loopback interface address that identifies the device. When you use a loopback interface address as the source address of IP packets, make sure the route from the loopback interface to the peer is reachable by performing routing configuration. All data packets sent to the loopback interface are considered packets sent to the device itself, so the device does not forward these packets.
- **Using a loopback interface in dynamic routing protocols**—With no router ID configured for a dynamic routing protocol, the system selects highest loopback interface IP address selected as the router ID. In BGP, to avoid interruption of BGP sessions due to physical port failure, you can use a loopback interface as the source interface of BGP packets.

To configure a loopback interface:

Step	Command	Remarks
1. Enter system view.	system-view	N/A
2. Create a loopback interface and enter loopback interface view.	interface loopback <i>interface-number</i>	N/A
3. Set the interface description.	description <i>text</i>	The default setting is <i>interface name Interface</i> (for example, LoopBack1 Interface).
4. Configure the expected bandwidth of the loopback interface.	bandwidth <i>bandwidth-value</i>	By default, the expected bandwidth of a loopback interface is 0 kbps.
5. Restore the default settings for the loopback interface.	default	N/A
6. Bring up the loopback interface.	undo shutdown	By default, a loopback interface is up.

Configuring a null interface

A null interface is a virtual interface and is always up, but you can neither use it to forward data packets nor can you configure it with an IP address or link layer protocol. The null interface provides a simpler way to filter packets than ACL. You can filter undesired traffic by transmitting it to a null interface instead of applying an ACL. For example, if you specify a null interface as the next hop of a static route to a specific network segment, any packets routed to the network segment are dropped.

To configure a null interface:

Step	Command	Remarks
1. Enter system view.	system-view	N/A
2. Enter null interface view.	interface null 0	Interface Null 0 is the default null interface on the device and cannot be manually created or removed. Only one null interface, Null 0, is supported on the device. The null interface number is fixed at 0.
3. Set the interface description.	description text	The default setting is NULL0 Interface.
4. Restore the default settings for the null interface.	default	N/A

Configuring an inloopback interface

An inloopback interface is a virtual interface created by the system, which cannot be configured or deleted. The physical layer and link layer protocol states of an inloopback interface are always up. All IP packets sent to an inloopback interface are considered packets sent to the device itself and are not further forwarded.

Displaying and maintaining loopback, null, and inloopback interfaces

Execute **display** commands in any view and **reset** commands in user view.

Task	Command
Display information about the specified or all loopback interfaces.	display interface [loopback [interface-number]] [brief [description]]
Display information about the null interface.	display interface [null [0]] [brief [description]]
Display information about the inloopback interface.	display interface [inloopback [0]] [brief [description]]
Clear the statistics on the specified or all loopback interfaces.	reset counters interface loopback [interface-number]
Clear the statistics on the null interface.	reset counters interface [null [0]]

Task	Command
Clear the statistics on the inloopback interface.	reset counters interface

Support and other resources

Contacting HP

For worldwide technical support information, see the HP support website:

<http://www.hp.com/support>

Before contacting HP, collect the following information:

- Product model names and numbers
- Technical support registration number (if applicable)
- Product serial numbers
- Error messages
- Operating system type and revision level
- Detailed questions

Subscription service

HP recommends that you register your product at the Subscriber's Choice for Business website:

<http://www.hp.com/go/wwalerts>

After registering, you will receive email notification of product enhancements, new driver versions, firmware updates, and other product resources.

Related information

Documents

To find related documents, browse to the Manuals page of the HP Business Support Center website:

<http://www.hp.com/support/manuals>

- For related documentation, navigate to the Networking section, and select a networking category.
- For a complete list of acronyms and their definitions, see *HP FlexNetwork Technology Acronyms*.

Websites

- HP.com <http://www.hp.com>
- HP Networking <http://www.hp.com/go/networking>
- HP manuals <http://www.hp.com/support/manuals>
- HP download drivers and software <http://www.hp.com/support/downloads>
- HP software depot <http://www.software.hp.com>
- HP Education <http://www.hp.com/learn>

Conventions

This section describes the conventions used in this documentation set.





Command conventions

Convention	Description
Boldface	Bold text represents commands and keywords that you enter literally as shown.
<i>Italic</i>	<i>Italic</i> text represents arguments that you replace with actual values.
[]	Square brackets enclose syntax choices (keywords or arguments) that are optional.
{ x y ... }	Braces enclose a set of required syntax choices separated by vertical bars, from which you select one.
[x y ...]	Square brackets enclose a set of optional syntax choices separated by vertical bars, from which you select one or none.
{ x y ... } *	Asterisk-marked braces enclose a set of required syntax choices separated by vertical bars, from which you select at least one.
[x y ...] *	Asterisk-marked square brackets enclose optional syntax choices separated by vertical bars, from which you select one choice, multiple choices, or none.
&<1-n>	The argument or keyword and argument combination before the ampersand (&) sign can be entered 1 to n times.
#	A line that starts with a pound (#) sign is comments.







GUI conventions

Convention	Description
Boldface	Window names, button names, field names, and menu items are in bold text. For example, the New User window appears; click OK .
>	Multi-level menus are separated by angle brackets. For example, File > Create > Folder .

Symbols

Convention	Description
 WARNING	An alert that calls attention to important information that if not understood or followed can result in personal injury.
 CAUTION	An alert that calls attention to important information that if not understood or followed can result in data loss, data corruption, or damage to hardware or software.
 IMPORTANT	An alert that calls attention to essential information.
NOTE	An alert that contains additional or supplementary information.
 TIP	An alert that provides helpful information.

Network topology icons

	Represents a generic network device, such as a router, switch, or firewall.
	Represents a routing-capable device, such as a router or Layer 3 switch.
	Represents a generic switch, such as a Layer 2 or Layer 3 switch, or a router that supports Layer 2 forwarding and other Layer 2 features.
	Represents an access controller, a unified wired-WLAN module, or the switching engine on a unified wired-WLAN switch.
	Represents an access point.
	Represents a security product, such as a firewall, a UTM, or a load-balancing or security card that is installed in a device.
	Represents a security card, such as a firewall card, a load-balancing card, or a NetStream card.

Port numbering in examples

The port numbers in this document are for illustration only and might be unavailable on your device.

Index

C D O R I

C

- Configuration example for directly connecting routers through POS interfaces, [35](#)
- Configuration guidelines, [iii](#)
- Configuration procedure, [iii](#)
- Configuring a CE1/PRI interface, [16](#)
- Configuring a CE3 interface, [28](#)
- Configuring a CT1/PRI interface, [20](#)
- Configuring a Layer 2 Ethernet interface, [5](#)
- Configuring a Layer 3 Ethernet interface or subinterface, [6](#)
- Configuring a loopback interface, [38](#)
- Configuring a null interface, [39](#)
- Configuring a POS interface or POS subinterface, [33](#)
- Configuring a serial interface, [9](#)
- Configuring a T1-F interface, [26](#)
- Configuring an AM interface, [12](#)
- Configuring an E1-F interface, [23](#)
- Configuring an inloopback interface, [39](#)
- Configuring an ISDN BRI interface, [14](#)

- Configuring common Ethernet interface settings, [1](#)
- Contacting HP, [41](#)
- Conventions, [42](#)

D

- Displaying and maintaining an Ethernet interface or subinterface, [7](#)
- Displaying and maintaining bulk interface configuration, [iv](#)
- Displaying and maintaining loopback, null, and inloopback interfaces, [39](#)
- Displaying and maintaining POS interfaces, [35](#)

O

- Overview, [33](#)

R

- Related information, [41](#)

T

- Troubleshooting POS interfaces, [36](#)

Free Manuals Download Website

<http://myh66.com>

<http://usermanuals.us>

<http://www.somanuals.com>

<http://www.4manuals.cc>

<http://www.manual-lib.com>

<http://www.404manual.com>

<http://www.luxmanual.com>

<http://aubethermostatmanual.com>

Golf course search by state

<http://golfingnear.com>

Email search by domain

<http://emailbydomain.com>

Auto manuals search

<http://auto.somanuals.com>

TV manuals search

<http://tv.somanuals.com>