

User Guide



HP Officejet Pro 8610/8620/8630



HP Officejet Pro 8610 e-All-in-One/HP
Officejet Pro 8620 e-All-in-One/HP
Officejet Pro 8630 e-All-in-One

User Guide

Copyright information

© 2014 Copyright Hewlett-Packard Development Company, L.P.

Edition 1, 4/2014

Hewlett-Packard Company notices

The information contained in this document is subject to change without notice.

All rights reserved. Reproduction, adaptation, or translation of this material is prohibited without prior written permission of Hewlett-Packard, except as allowed under copyright laws.

The only warranties for HP products and services are set forth in the express warranty statements accompanying such products and services. Nothing herein should be construed as constituting an additional warranty. HP shall not be liable for technical or editorial errors or omissions contained herein.

Acknowledgements

Microsoft, Windows, Windows XP, Windows Vista, Windows 7, and Windows 8 are U.S. registered trademarks of Microsoft Corporation.

ENERGY STAR and the ENERGY STAR mark are registered U.S. marks.

Safety information



Always follow basic safety precautions when using this product to reduce risk of injury from fire or electric shock.

1. Read and understand all instructions in the documentation that comes with the printer.
2. Observe all warnings and instructions marked on the product.
3. Unplug this product from wall outlets before cleaning.
4. Do not install or use this product near water, or when you are wet.
5. Install the product securely on a stable surface.
6. Install the product in a protected location where no one can step on or trip over the line cord, and the line cord cannot be damaged.
7. If the product does not operate normally, see [Solve a problem on page 121](#).
8. There are no user-serviceable parts inside. Refer servicing to qualified service personnel.

Table of contents

1 How do I?	1
2 Get started	3
Accessibility	4
HP EcoSolutions (HP and the Environment)	5
Manage Power	5
Optimize Printing Supplies	5
Understand the printer parts	7
Front view	7
Printing supplies area	8
Back view	8
Use the printer control panel	9
Overview of buttons and lights	9
Control panel display icons	9
Change printer settings	10
HP Digital Solutions	12
What are HP Digital Solutions?	12
HP Digital Filing	12
HP Digital Fax	12
Requirements	12
Set up HP Digital Solutions	14
Set up HP Digital Filing	14
Set up Scan to Network Folder	14
Set up Scan to Email	15
Set up HP Digital Fax	17
Use the HP Digital Solutions	18
Use HP Scan to Network Folder	18
Use Scan to Email	18
Use HP Digital Fax	18
Near field communication (NFC)	19
Paper basics	20
Recommended papers for printing	20
Order HP paper supplies	21
Tips for selecting and using paper	22
Load paper	23

Load standard-size paper	23
Load envelopes	24
Load cards and photo paper	25
Load an original on the scanner glass	27
Load an original in the document feeder	28
Insert a USB flash drive	29
Set up and use accessories	30
Install the automatic two-sided printing accessory (duplexer)	30
Install and use second tray (Tray 2)	30
Work with trays	31
Maintain the printer	34
Clean the scanner glass	34
Clean the exterior	34
Clean the automatic document feeder	35
Update the printer	36
Open the HP printer software (Windows)	37
Turn the printer off	38
Restore defaults	39
3 Print	41
Print documents	42
Print on envelopes	43
Print photos	45
Print using the maximum dpi	47
Print on both sides (duplexing)	48
Tips for print success	49
4 Copy and scan	53
Copy	54
Scan	56
Scan an original	56
Scan to a computer	56
Scan to a memory device	57
Scan using Webscan	57
Scanning documents as editable text	58
5 Fax	61
Send a fax	62
Send a standard fax	62
Send a standard fax from the computer	63
Send a fax manually from a phone	63
Send a fax using monitor dialing	64
Send a fax from memory	65

Send a fax to multiple recipients	65
Send a fax in Error Correction Mode	66
Receive a fax	67
Receive a fax manually	67
Set up backup fax	68
Reprint received faxes from memory	68
Forward faxes to another number	69
Set the paper size for received faxes	69
Set automatic reduction for incoming faxes	70
Block unwanted fax numbers	70
Add numbers to the junk fax list	70
Remove numbers from the junk fax list	71
Print a Junk Fax Report	71
Receive faxes using HP Digital Fax	71
HP Digital Fax requirements	72
Activate HP Digital Fax	72
Modify HP Digital Fax settings	72
Set up speed-dial entries	74
Set up and change speed-dial entries	74
Set up and change group speed-dial entries	75
Delete speed-dial entries	75
Print a list of speed-dial entries	76
Change fax settings	77
Configure the fax header	77
Set the answer mode (Auto answer)	77
Set the number of rings before answering	78
Change the answer ring pattern for distinctive ring	78
Set the dial type	79
Set the redial options	79
Set the fax speed	79
Set the fax sound volume	80
Fax and digital phone services	81
Fax over Internet Protocol	82
Fax reports	83
Print fax confirmation reports	83
Print fax error reports	84
Print and view the fax log	84
Clear the fax log	84
Print the details of the last fax transaction	85
Print a Caller ID Report	85
View the Call History	85
6 Web Services	87
What are Web Services?	88

HP ePrint	88
Print apps	88
Set up Web Services	89
Set up Web Services using the printer control panel	89
Set up Web Services using the embedded web server	89
Set up Web Services using the HP printer software	90
Use Web Services	91
HP ePrint	91
Print using HP ePrint	91
Find the printer's email address	91
Turn off HP ePrint	92
Print apps	92
Use print apps	92
Manage print apps	92
Turn off print apps	92
Remove Web Services	93
7 Work with ink cartridges	95
Information on ink cartridges and the printhead	96
Check the estimated ink levels	97
Printing with black or color ink only	98
Replace the ink cartridges	99
Order ink cartridges	101
Store printing supplies	102
Anonymous usage information storage	103
8 Network setup	105
Set up the printer for wireless communication	106
Before you begin	106
Set up the printer on your wireless network	106
Change the connection type	107
Change from an Ethernet connection to a wireless connection	107
Change from a USB connection to a wireless connection	107
Test the wireless connection	108
Turn on or off the wireless capability of the printer	108
Change network settings	109
View and print network settings	109
Set link speed	109
Change IP settings	109
Change from a wireless connection to a USB or Ethernet connection	111
Use HP wireless direct	112
Turn on HP wireless direct	112
Print from a wireless-capable mobile device	113
Print from a wireless-capable computer	113

9 Printer management tools	115
Toolbox (Windows)	116
Open the Toolbox	116
HP Utility (OS X)	117
Embedded web server	118
About cookies	118
Open the embedded web server	118
10 Solve a problem	121
HP support	122
Register printer	122
Support process	122
Obtain electronic support	122
HP support by phone	123
Before you call	123
Phone support period	123
Support phone numbers	123
After the phone support period	123
Get help from the printer control panel	124
Understand printer reports	125
Printer status report	125
Network configuration page	126
Solve printer problems	129
The printer shuts down unexpectedly	129
Printhead alignment fails	129
Paper-feed problems	129
The printer cannot read the memory device	130
Solve printing problems	131
Solve copy problems	135
Copies are blank or faded	135
Size is reduced	135
Copy quality is poor	135
Solve scan problems	137
Scanner did nothing	137
Scan takes too long	137
Part of the document did not scan or text is missing	137
Text cannot be edited	138
Scanned image quality is poor	139
Unable to scan to network folder	139
Unable to scan to email	140
Solve fax problems	141
The fax test failed	141
The "Fax Hardware Test" failed	141

The "Fax Connected to Active Telephone Wall Jack" test failed	142
The "Phone Cord Connected to Correct Port on Fax" test failed	142
The "Using Correct Type of Phone Cord with Fax" test failed	143
The "Dial Tone Detection" test failed	144
The "Fax Line Condition" test failed	144
The display always shows Phone Off Hook	145
The printer is having problems sending and receiving faxes	145
The printer cannot receive faxes, but can send faxes	147
The printer cannot send faxes, but can receive faxes	148
Solve HP ePrint and HP Printables problems	149
Solve network problems	150
General network troubleshooting	150
Unable to connect the printer wirelessly	150
Step 1: Make sure the Wireless (802.11) light is turned on	150
Step 2: Make sure the computer is connected to the wireless network	151
Step 3: Run the wireless test	151
Step 4: Restart components of the wireless network	152
Solve printer management problems	153
Embedded web server cannot be opened	153
Printhead maintenance	155
Clean the printhead	155
Align the printhead	156
Calibrate the linefeed	157
Reinstall the printhead	157
Clear jams	159
Clear paper jams inside the printer	159
Clear paper jams in the automatic document feeder	160
Avoid paper jams	161
Clear the print carriage	162
Appendix A Technical information	163
Warranty information	164
Ink cartridge warranty information	164
Specifications	165
System requirements	165
Environmental specifications	165
Input tray capacity	165
Output tray capacity	166
Paper size and weights	166
Print specifications	166
Copy specifications	166
Scan specifications	166
Fax specifications	167
Cartridge yield	167

Acoustic emission specifications	167
Regulatory information	169
Regulatory Model Number	169
FCC statement	170
Notice to users in Korea	170
VCCI (Class B) compliance statement for users in Japan	170
Notice to users in Japan about the power cord	170
Noise emission statement for Germany	171
Visual display workplaces statement for Germany	171
Notice to users of the U.S. telephone network: FCC requirements	171
Notice to users of the Canadian telephone network	172
Notice to users in the European Economic Area	172
Notice to users of the German telephone network	173
Australia wired fax statement	173
European Union Regulatory Notice	173
Products with external AC Adapters	173
Products with wireless functionality	173
European telephone network declaration (Modem/Fax)	174
Declaration of conformity	174
Regulatory information for wireless products	174
Exposure to radio frequency radiation	175
Notice to users in Brazil	175
Notice to users in Canada	175
Notice to users in Taiwan	176
Notice to users in Mexico	176
Wireless notice to users in Japan	176
Environmental product stewardship program	177
Paper use	177
Plastics	177
Material safety data sheets	177
Recycling program	178
HP inkjet supplies recycling program	178
Disposal of waste equipment by users	178
Power consumption	178
Chemical substances	178
Battery disposal in the Netherlands	179
Battery disposal in the Taiwan	179
California Perchlorate Material Notice	179
Toxic and hazardous substance table (China)	179
Restriction of hazardous substance (Ukraine)	179
Restriction of hazardous substance (India)	180
EPEAT	180
China SEPA Ecolabel User Information	180

Appendix B Additional fax setup	181
Set up faxing (parallel phone systems)	182
Select the correct fax setup for your home or office	183
Case A: Separate fax line (no voice calls received)	184
Case B: Set up the printer with DSL	185
Case C: Set up the printer with a PBX phone system or an ISDN line	186
Case D: Fax with a distinctive ring service on the same line	187
Case E: Shared voice/fax line	188
Case F: Shared voice/fax line with voice mail	189
Case G: Fax line shared with computer modem (no voice calls received)	190
Set up the printer with a computer dial-up modem	191
Set up the printer with a computer DSL/ADSL modem	192
Case H: Shared voice/fax line with computer modem	193
Shared voice/fax with computer dial-up modem	193
Shared voice/fax with computer DSL/ADSL modem	194
Case I: Shared voice/fax line with answering machine	196
Case J: Shared voice/fax line with computer modem and answering machine	197
Shared voice/fax line with computer dial-up modem and answering machine	197
Shared voice/fax line with computer DSL/ADSL modem and answering machine	199
Case K: Shared voice/fax line with computer dial-up modem and voice mail	201
Serial-type fax setup	203
Test fax setup	204
Appendix C Errors (Windows)	205
Fax memory full	207
Unable to communicate with printer	208
Low on ink	209
Printhead Problem	210
Ink Cartridge Problem	211
Replace the ink cartridge	212
Incompatible older generation cartridge installed	213
Paper Mismatch	214
The cartridge cradle cannot move	215
Paper Jam	216
The printer is out of paper	217
Printer Offline	218
Printer Paused	219
Document failed to print	220
Printer failure	221
Door or cover open	222
Previously used ink cartridge installed	223
Ink cartridges depleted	224

Ink cartridge failure	225
Printer supply upgrade	226
Printer supply upgrade successful	227
Printer supply upgrade problem	228
Non-HP ink cartridges installed	229
Using Genuine HP Cartridges has its Rewards	230
Counterfeit Cartridge Advisory	231
Used, Refilled or Counterfeit Cartridge Detected	232
Use SETUP cartridges	233
Do not use SETUP cartridges	234
Not enough ink at startup	235
Use black ink only?	236
Use color ink only?	237
Incompatible ink cartridges	238
Ink sensor failure	239
Ink sensor warning	240
Problem with printer preparation	241
Color cartridge out of ink	242
Black cartridge out of ink	243
Automatic document feeder cover open	244
Problem with ink system	245
Index	247

1 How do I?

- [Get started on page 3](#)
- [Print on page 41](#)
- [Copy and scan on page 53](#)
- [Fax on page 61](#)
- [Web Services on page 87](#)
- [Work with ink cartridges on page 95](#)
- [Solve a problem on page 121](#)

2 Get started

This guide provides details about how to use the printer and how to resolve problems.

- [Accessibility](#)
- [HP EcoSolutions \(HP and the Environment\)](#)
- [Understand the printer parts](#)
- [Use the printer control panel](#)
- [HP Digital Solutions](#)
- [Near field communication \(NFC\)](#)
- [Paper basics](#)
- [Load paper](#)
- [Load an original on the scanner glass](#)
- [Load an original in the document feeder](#)
- [Insert a USB flash drive](#)
- [Set up and use accessories](#)
- [Maintain the printer](#)
- [Update the printer](#)
- [Open the HP printer software \(Windows\)](#)
- [Turn the printer off](#)
- [Restore defaults](#)

Accessibility

The printer provides a number of features that make it accessible for people with disabilities.

Visual

The HP software provided with the printer is accessible for users with visual impairments or low vision by using your operating system's accessibility options and features. The software also supports most assistive technology such as screen readers, Braille readers, and voice-to-text applications. For users who are color blind, colored buttons and tabs used in the HP software have simple text or icon labels that convey the appropriate action.

Mobility

For users with mobility impairments, the HP software functions can be executed through keyboard commands. The HP software also supports Windows accessibility options such as StickyKeys, ToggleKeys, FilterKeys, and MouseKeys. The printer doors, buttons, paper trays, and paper-width guides can be operated by users with limited strength and reach.

Support

For more details about the accessibility of this printer and HP's commitment to product accessibility, visit HP's website at www.hp.com/accessibility.

(OS X) For accessibility information, visit the Apple website at www.apple.com/accessibility.

HP EcoSolutions (HP and the Environment)

Hewlett-Packard is committed to helping you optimize your environmental footprint and empowering you to print responsibly—at home or in the office.

For more detailed information about environmental guidelines that HP follows during the manufacturing process, see [Environmental product stewardship program on page 177](#). For more information about HP's environmental initiatives, visit www.hp.com/ecosolutions.

- [Manage Power](#)
- [Optimize Printing Supplies](#)

Manage Power

To conserve electricity, the printer comes with the following features.

You can also turn the features on or off from the printer software or Embedded web server (EWS).

To open the printer software, see [Open the HP printer software \(Windows\) on page 37](#).

To open the EWS, see [Embedded web server on page 118](#).

Sleep mode

Power usage is reduced while in Sleep mode. After initial setup, the printer goes into low-power mode after 5 minutes of inactivity.

To change the time to Sleep mode:

1. From the printer control panel display, touch **eco** (ECO).
2. Touch **Sleep**, and then touch the desired option.



 **NOTE:** If you change your country or region from the printer control panel, the time to sleep mode is automatically set to the default, which is 5 minutes.

Schedule On and Off

Use this feature to automatically save energy during evenings and weekends. For example, you can schedule the printer to turn on at 8 a.m. and turn off at 8 p.m. from Monday to Friday. In this way, you will save energy during the night and weekends.

To configure the printer's Schedule On and Off feature:

1. From the printer control panel display, touch **eco** (ECO).
2. Touch **Schedule On and Off**.
3. Touch **Schedule On** and **Schedule Off** to set the time to turn the printer on and off.

 **CAUTION:** Always turn off the printer properly, using either **Sleep Mode**, **Schedule On and Off**, or  (the Power button).

If you incorrectly turn the printer off, the print carriage might not return to the correct position, causing problems with the ink cartridges and print quality issues.

Optimize Printing Supplies

To optimize printing supplies such as ink and paper, try the following:

- Optimize paper usage by printing on both sides of the paper.
- Save ink and paper when printing web content with HP Smart Print. For more information, visit www.hp.com/go/smartprint.
- Change the print mode to a draft setting. The draft setting uses less ink.
- Do not clean the printhead unnecessarily. Doing so wastes ink and shortens the life of the cartridges.

Understand the printer parts

This section contains the following topics:

- [Front view](#)
- [Printing supplies area](#)
- [Back view](#)

Front view

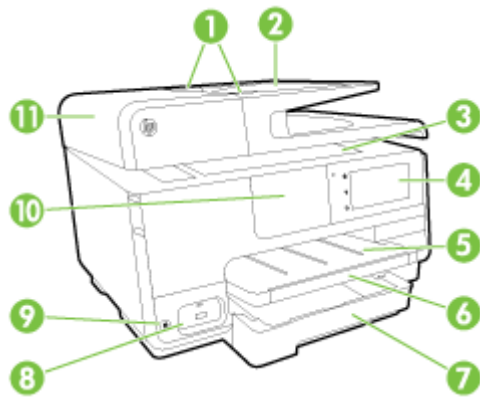

1	Document feeder paper-width guides
2	Document feeder tray
3	Scanner glass
4	Control panel display
5	Output tray
6	Output tray extender
7	Main input tray
8	Front USB port
9	Power button
10	Near field communication (NFC)
	NOTE: This feature is available with some models of the printer.
11	Document feeder tray

Printing supplies area

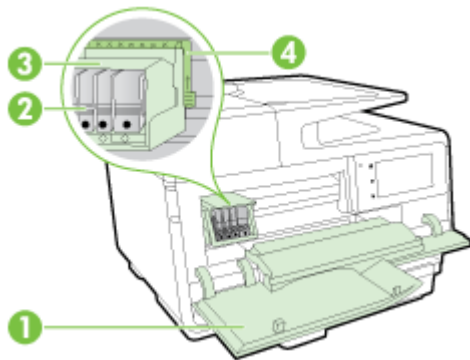

- | | |
|---|---------------------------|
| 1 | Ink cartridge access door |
| 2 | Ink cartridges |
| 3 | Printhead |
| 4 | Printhead latch |

 **NOTE:** Printing supplies should be kept in the printer to prevent possible print quality issues or printhead damage. Avoid removing supplies for extended periods of time. Do not turn off the printer when a cartridge is missing.

Back view

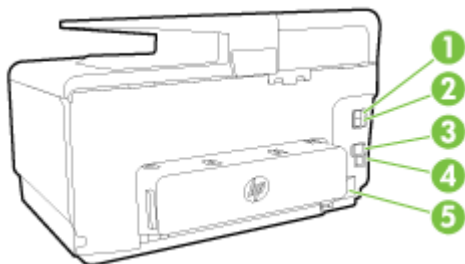

- | | |
|---|-----------------------|
| 1 | Fax port (2-EXT) |
| 2 | Fax port (1-LINE) |
| 3 | Ethernet network port |
| 4 | Rear USB port |
| 5 | Power input |

Use the printer control panel

This section contains the following topics:

- [Overview of buttons and lights](#)
- [Control panel display icons](#)
- [Change printer settings](#)





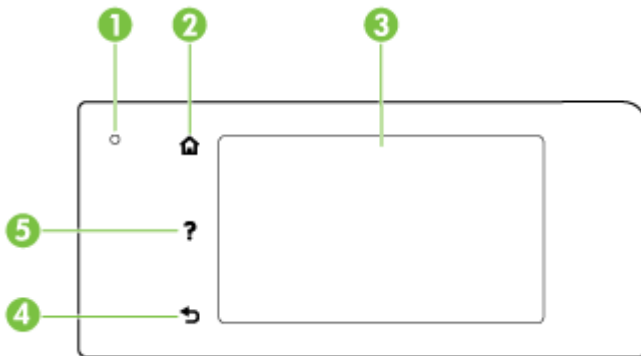

Overview of buttons and lights









The following diagram and related table provides a quick reference to the printer control panel features.



Label	Name and Description
1	Wireless status light: Blue light indicates a wireless connection. Touch  (Wireless) to turn on or off the printer wireless capabilities.
2	Home button: Returns to the home screen from any other screen.
3	Control panel display: Touch the screen to select menu options. For addition menu options, touch and slide your finger across the screen. For information about the icons that appear on the display, see Control panel display icons on page 9 .
4	Back button: Returns to the previous menu.
5	Help button: Opens the Help menu.

Control panel display icons

Icon	Purpose
	Shows that a wired network connection exists and also provides easy access to the network status screen.
	Displays wireless status and menu options. For more information, see Set up the printer for wireless communication on page 106 . NOTE:  (Ethernet) and  (Wireless) do not display at the same time. Showing the Ethernet icon or the wireless icon depends on the way your printer is connected to network. If the network connection of the printer has not been set up, by default, the printer control panel display shows  (Wireless).
	Turn on (with and without security) or off wireless direct. If turning on wireless direct with security, then you can also display the wireless direct name and security password.
eco	Displays a screen where you can configure the product power saving settings features.

Icon	Purpose
	Touch the icon to display the Web Services Settings where you can view the printer's email address and make ePrint settings. For more information, see HP ePrint on page 91 .
	Displays a screen where you can make copies or select other options.
	Displays a screen where you can send a fax, or choose fax settings.
	Displays a screen where you can make a scan, or change scan settings.
	Displays a screen where you can use print apps.
	Displays the Setup screen for generating reports, changing fax and other maintenance settings, and accessing the Help screen.
	Provides more information about the printer features.
	Displays a screen where you can see information about the ink cartridges, including fill levels. This icon has a red border when an ink cartridge needs attention. NOTE: Ink level warnings and indicators provide estimates for planning purposes only. When you receive a low-ink warning message, consider having a replacement cartridge available to avoid possible printing delays. You do not need to replace cartridges until prompted to do so.
	Displays the status of the Auto Answer function. Touch Auto Answer to turn it on or off. For more information, see Set the answer mode (Auto answer) on page 77 .

Change printer settings

Use the control panel to change the printer function and settings, print reports, or get help for the printer.



 **TIP:** If the printer is connected to a computer, you can also change the printer settings using the printer management tools.

For more information about these tools, see [Printer management tools on page 115](#).

To change settings for a function

The Home screen of the control panel display shows the available functions for the printer.



1. From the control panel display, touch and slide your finger across the screen and then touch the icon to select the desired function.
2. After selecting a function, touch and scroll through the available settings, and then touch the setting you want to change.
3. Follow the prompts on the control panel display to change the settings.

 **NOTE:** Touch  (Home) to return to the Home screen.

To change the printer settings

To change the printer settings or print reports, use the options available on the **Setup Menu** screen.

1. From the printer control panel display, touch and slide your finger across the screen and then touch **Setup**.
2. Touch and scroll through the screens.
3. Touch the screen items to select screens or options.

 **NOTE:** Touch  (Home) to return to the Home screen.

HP Digital Solutions

The printer includes a collection of digital solutions that can help you simplify and streamline your work. These digital solutions include the following:

- HP Digital Filing (including Scan to Network Folder and Scan to Email)
- HP Digital Fax (including Fax to Network Folder and Fax to Email)

This section contains the following topics:

- [What are HP Digital Solutions?](#)
- [Requirements](#)
- [Set up HP Digital Solutions](#)
- [Use the HP Digital Solutions](#)

What are HP Digital Solutions?

HP Digital Solutions are a set of tools provided with this printer that can help improve your office productivity.

HP Digital Filing

HP Digital Filing provides robust, general-office scanning—as well as basic, versatile, document-management capabilities—for multiple users over a network. With HP Digital Filing, you can simply walk up to the printer, select the options on the printer control panel, and either scan documents directly to computer folders on your network or quickly share them with business partners as email attachments—and all without using additional scanning software.

These scanned documents can be sent to a shared network folder for personal or group access or to one or more email addresses for quick sharing. In addition, you can configure specific scan settings for each scan destination, allowing you to make sure that the best settings are being used for each specific task.

HP Digital Fax

Never lose important faxes misplaced within a stack of paper pages again!

With HP Digital Fax, you can save incoming, black-and-white faxes to a computer folder on your network for easy sharing and storage, or you can forward faxes through email—allowing you to receive important faxes from anywhere while working away from the office.

In addition, you can turn off fax printing altogether — saving money on paper and ink, as well as helping reduce paper consumption and waste.

Requirements

Before you set up the HP Digital Solutions, make sure you have the following:

For all HP Digital Solutions

- **A network connection**

The printer can be connected either through a wireless connection or using an Ethernet cable.

 **NOTE:** If the printer is connected using a USB cable, you scan documents to a computer or attach scans to an email message using the HP software. For more information, see [Scan an original on page 56](#). You can receive faxes to your computer using HP Digital Fax. For more information, see [Receive faxes using HP Digital Fax on page 71](#).

- **The HP software**

HP recommends that you set up HP Digital Solutions using the HP software provided with the printer.

 **TIP:** If you would like to set up HP Digital Solutions without installing the HP software, you can use the printer's embedded web server.

For Scan to Network Folder, Fax to Network Folder

- **An active network connection.** You must be connected to the network.

- **An existing Windows (SMB) shared folder**

For information about finding the computer name, see the documentation for your operating system.

- **The network address for the folder**

On computer running Windows, network addresses are usually written in this format: `\\mypc\sharedfolder`

- **The name of the computer where the folder is located**

For information about finding the computer name, see the documentation for your operating system.

- **Appropriate privileges on the shared folder**

You must have write access to the folder.

- **A username and password for the shared folder (if necessary)**

For example, the Windows or OS X username and password used to log onto the network.

 **NOTE:** HP Digital Filing does not support Active Directory.

For Scan to Email, Fax to Email

- A valid email address
- Outgoing SMTP server information
- An active Internet connection

If you are setting up Scan to Email or Fax to Email on a computer running Windows, the setup wizard can automatically detect the email settings for the following email applications:

- Microsoft Outlook 2003–2007 (Windows XP, Windows Vista, and Windows 7)
- Outlook Express (Windows XP)
- Windows Mail (Windows Vista)

- Mozilla Thunderbird (Windows XP, Windows Vista, and Windows 7)
- Qualcomm Eudora (version 7.0 and above) (Windows XP and Windows Vista)
- Netscape (version 7.0) (Windows XP)

However, if your email application is not listed above, you can still set up and use Scan to Email and Fax to Email if your email application meets the requirements listed in this section.

Set up HP Digital Solutions

You can set up HP Digital Solutions using the HP software provided with the printer—either using software wizards that you can open from the HP printer software (Windows) or HP Utility (OS X).

 **TIP:** You can also use the printer's EWS to set up the HP Digital Solutions. For more information about using the EWS, see [Embedded web server on page 118](#).

 **NOTE:** If you are using the printer in an IPv6-only network environment, you must set up the digital solutions using the EWS.

This section contains the following topics:

- [Set up HP Digital Filing](#)
- [Set up HP Digital Fax](#)

Set up HP Digital Filing

To set up HP Digital Filing, follow the appropriate instructions.

 **NOTE:** You can also use these steps to change settings in the future.

This section contains the following topics:

- [Set up Scan to Network Folder](#)
- [Set up Scan to Email](#)

Set up Scan to Network Folder

You can configure up to 10 destination folders for each printer.

 **NOTE:** To use Scan to Network Folder, you must have created and configured the folder you are using on a computer connected to the network. You cannot create a folder from the printer's control panel. Also, make sure the folder preferences are set to provide read and write access. For more information about creating folders on the network and setting folder preferences, see the documentation for your operating system.

After you finish setting up Scan to Network Folder, the HP software automatically saves the configurations to the printer.

To set up Scan to Network Folder, complete the following steps for your operating system.

To set up Scan to Network Folder from the printer software (Windows)

1. Open the HP printer software. For more information, see [Open the HP printer software \(Windows\) on page 37](#).
2. Go to the **Scan** section under **Print, Scan & Fax**, and then double-click **Scan to Network Folder Wizard**.
3. Follow the on-screen instructions.

 **NOTE:** After you create destination folders, you can use the printer's EWS to customize the scan settings for these folders. On the last screen of the Scan to Network Folder Wizard, make sure the **Launch embedded web server when finished** check box is selected. When you click **Finish**, the EWS is displayed in your computer's default web browser. For more information about the embedded web server, see [Embedded web server on page 118](#).

To set up Scan to Network Folder from the printer software (OS X)

1. Open HP Utility. For more information, see [HP Utility \(OS X\) on page 117](#).
2. Click **Scan to Network Folder** under the **Scan Settings** section, and then follow the on-screen instructions.

 **NOTE:** You can customize the scan settings for each destination folder.

To set up Scan to Network Folder from Embedded web server (EWS)

1. Open the embedded web server (EWS). For more information, see [Open the embedded web server on page 118](#).
2. On the **Home** tab, click **Network Folder Setup** in the **Setup** box.
3. Click **New**, and then follow the on-screen instructions.

 **NOTE:** You can customize the scan settings for each destination folder.

4. After you have entered the required information about the network folder, click **Save and Test** to make sure the link to the network folder is working correctly. The entry is added to the **Network Folder** list.

Set up Scan to Email

You can use the printer to scan documents and send them to one or more email addresses as attachments—without additional scanning software. You do not need to scan files from your computer and attach them to email messages.

To use the Scan to Email feature, complete the following preliminary steps:

Set the Outgoing Email Profiles

Configure the email address which will appear in the FROM portion of the email message sent by the printer. You can add up to 10 Outgoing Email Profiles. You can use the HP software installed on your computer to create these profiles.

Add email addresses to the Email Address Book

Manage the list of people to whom you can send email messages from the printer. You can add up to 15 email addresses with their corresponding contact names. You can also create email groups. To add email addresses, you can use the printer's embedded web server (EWS) or the printer's control panel.

Configure other email options

You can configure default SUBJECT and body text that is included in all email messages sent from the printer. To configure these options, you can use the printer's EWS or the printer's control panel.

Step 1: Set up the outgoing email profiles

To set up the outgoing email profile used by the printer, complete the following steps for your operating system.

To set up the outgoing email profile from the printer software (Windows)

1. Open the HP printer software. For more information, see [Open the HP printer software \(Windows\) on page 37](#).
2. Go to the **Scan** section under **Print, Scan & Fax**, and then double-click **Scan to E-mail Wizard**.
3. Click **New**, and then follow the on-screen instructions.

 **NOTE:** After you set the Outgoing Email Profile, you can use the printer's embedded web server (EWS) to add more Outgoing Email Profiles, add email addresses to the Email Address Book, and configure other email options. To open the EWS automatically, make sure the **Launch embedded web server when finished** check box is selected on the last screen of the Scan to Email Wizard. When you click **Finish**, the EWS is displayed in your computer's default web browser. For more information about the embedded web server, see [Embedded web server on page 118](#)

To set up the outgoing email profile from the printer software (OS X)

1. Open HP Utility. For more information, see [HP Utility \(OS X\) on page 117](#).
2. Click **Scan to Email** under the **Scan Settings** section.
3. Follow the on-screen instructions.
4. After you have entered the required information about the network folder, click **Save and Test** to make sure the link to the network folder is working correctly. The entry is added to the **Outgoing Email Profiles** list.

To set up the outgoing email profile from Embedded web server (EWS)

1. Open the embedded web server (EWS). For more information, see [Embedded web server on page 118](#).
2. On the **Home** tab, click **Outgoing Email Profiles** in the **Setup** box.
3. Click **New**, and then follow the on-screen instructions.
4. After you have entered the required information about the network folder, click **Save and Test** to make sure the link to the network folder is working correctly. The entry is added to the **Outgoing Email Profile List**.

Step 2: Add email addresses to the Email Address Book

To add email addresses to the Email Address Book, complete the following steps:

1. Open the embedded web server (EWS). For more information, see [Embedded web server on page 118](#).
2. On the **Scan** tab, click **Email Address Book**.
3. Click **New** to add a single email address.

-Or-

Click **Group** to create an email distribution list.

 **NOTE:** Before you can create an email distribution list, you must have already added at least one email address to the Email Address Book.

4. Follow the on-screen instructions. The entry is added to the **Email Address Book**.

 **NOTE:** Contact names appear on the printer's control panel display and in your email application.

Step 3: Configure other email options

To configure other email options (such as configuring default SUBJECT and body text that is included in all email messages sent from the printer, as well as scan settings used when sending email from the printer), complete the following steps:

1. Open the embedded web server (EWS). For more information, see [Embedded web server on page 118](#).
2. On the **Scan** tab, click **Email Options**.
3. Change any settings, and then click **Apply**.

Set up HP Digital Fax

With HP Digital Fax, the printer automatically receives faxes and saves them directly to a network folder (Fax to Network Folder) or forwards them as email attachments (Fax to Email).

 **NOTE:** You can configure HP Digital Fax to use either Fax to Network Folder or to use Fax to Email. You cannot use both at the same time.

Received faxes are saved as TIFF (Tagged Image File Format) or PDF files.

 **CAUTION:** HP Digital Fax is available for receiving black-and-white faxes only. Color faxes are printed instead of being saved.

To set up HP Digital Fax from the printer software (Windows)

1. Open the HP printer software. For more information, see [Open the HP printer software \(Windows\) on page 37](#).
2. Go to the **Fax** section under the **Print, Scan & Fax**, and then double-click **Digital Fax Setup**.
3. Follow the on-screen instructions.

 **NOTE:** After you set up HP Digital Fax, you can use the printer's embedded web server (EWS) to edit HP Digital Fax settings. To open the EWS automatically, make sure the **Launch embedded web server when finished** check box is selected on the last screen of the Digital Fax Setup Wizard. When you click **Finish**, the EWS is displayed in your computer's default web browser. For more information about the embedded web server, see [Embedded web server on page 118](#).

To set up HP Digital Fax from the printer software (OS X)

1. Open HP Utility. For more information, see [HP Utility \(OS X\) on page 117](#).
2. Click **Digital Fax Archive**.
3. Follow the on-screen instructions.
4. After you have entered the required information, click **Save and Test** to make sure the link to the network folder is working correctly.

To set up HP Digital Fax from Embedded web server (EWS)

1. On the **Home** tab, click **Fax to Email/Network Folder** in the **Setup** box.
2. Follow the on-screen instructions.
3. After you have entered the required information, click **Save and Test** to make sure the link to the network folder is working correctly.

Use the HP Digital Solutions

To use the HP Digital Solutions available with the printer, follow the appropriate instructions.

Use HP Scan to Network Folder

1. Load your original print-side down on the right-front corner of the scanner glass or print-side up in the ADF. For more information, see [Load an original on the scanner glass on page 27](#) or [Load an original in the document feeder on page 28](#).
2. Touch **Scan**, and then touch **Network Folder**.
3. On the control panel display, select the name that corresponds to the folder you want to use.
4. If prompted, enter the PIN.
5. Change any scan settings, and then touch **Start Scan**.

 **NOTE:** The connection might take some time, depending on network traffic and connection speed.

Use Scan to Email

1. Load your original print-side down on the right-front corner of the scanner glass or print-side up in the ADF. For more information, see [Load an original on the scanner glass on page 27](#) or [Load an original in the document feeder on page 28](#).
2. Touch **Scan**, and then touch **Email**.
3. On the control panel display, select the name that corresponds to the Outgoing Email Profile you want to use.
4. If prompted, enter the PIN.
5. Select the TO email address (the email recipient) or enter an email address.
6. Enter or change the SUBJECT for the email message.
7. Change any scan settings, and then touch **Start Scan**.

 **NOTE:** The connection might take some time, depending on network traffic and connection speed.

Use HP Digital Fax

After you set up HP Digital Fax, any black-and-white faxes that you receive print, by default, and then are saved to the designated destination—either the network folder or email address that you have specified:

- If you are using Fax to Network Folder, this process happens in the background. HP Digital Fax does not notify you when faxes are saved to the network folder.
- If you are using Fax to Email and if your email application is set to notify you when new email messages arrive in your inbox, you can see when new faxes arrive.

Near field communication (NFC)

With near field communication (NFC), you can quickly print documents and images from a mobile device (such as a smartphone or tablet) just by touching the device on the printer. Look for  on the front of the printer, near the printer control panel, and then touch your mobile device to this area to print.

For more information about supported mobile devices and capabilities, visit the HP Mobile Printing web site (www.hp.com/go/mobileprinting).

 **NOTE:** This feature is available with some models of the printer.

To use this feature, make sure your mobile device supports NFC and make sure NFC is turned on in the printer.

Paper basics

The printer is designed to work well with most types of office paper. It is best to test a variety of print paper types before buying large quantities. Use HP paper for optimum print quality. Visit the HP website at www.hp.com for more information about HP paper.



HP recommends plain papers with the ColorLok logo for printing everyday documents. All papers with the ColorLok logo are independently tested to meet high standards of reliability and print quality, and produce documents with crisp, vivid color, bolder blacks, and that dry faster than ordinary plain papers. Look for papers with the ColorLok logo in a variety of weights and sizes from major paper manufacturers.

This section contains the following topics:

- [Recommended papers for printing](#)
- [Order HP paper supplies](#)
- [Tips for selecting and using paper](#)

Recommended papers for printing

If you want the best print quality, HP recommends using HP papers that are specifically designed for the type of project you are printing.

Depending on your country/region, some of these papers might not be available.

Photo printing

- **HP Premium Plus Photo Paper**

HP Premium Plus Photo Paper is HP's highest-quality photo paper for your best photos. With HP Premium Plus Photo Paper, you can print beautiful photos that are instant-dry so you can share them right off the printer. It is available in several sizes, including A4, 8.5 x 11 inches, 4 x 6 inches (10 x 15 cm), 5 x 7 inches (13 x 18 cm), and 11 x 17 inches (A3), and in two finishes - glossy or soft gloss (semi-gloss). Ideal for framing, displaying, or gifting your best photos and special photo projects. HP Premium Plus Photo Paper delivers exceptional results with professional quality and durability.

- **HP Advanced Photo Paper**

This thick photo paper features an instant-dry finish for easy handling without smudging. It resists water, smears, fingerprints, and humidity. Your prints have a look and feel comparable to a store-processed photo. It is available in several sizes, including A4, 8.5 x 11 inches, 10 x 15 cm (4 x 6 inches), 13 x 18 cm (5 x 7 inches). It is acid-free for longer lasting documents.

- **HP Everyday Photo Paper**

Print colorful, everyday snapshots at a low cost, using paper designed for casual photo printing. This affordable photo paper dries quickly for easy handling. Get sharp, crisp images when you use this paper with any inkjet printer. It is available in glossy finish in several sizes, including A4, 8.5 x 11 inches, and 10 x 15 cm (4 x 6 inches). It is acid-free for longer lasting documents.

Business documents

- **HP Premium Presentation Paper 120g Matte or HP Professional Paper 120 Matt**

These papers are heavy two-sided matte papers perfect for presentation, proposals, reports, and newsletters. They are heavyweight for an impressive look and feel.

- **HP Brochure Paper 180g Glossy or HP Professional Paper 180 Glossy**

These papers are glossy-coated on both sides for two-sided use. They are the perfect choice for near-photographic reproductions and business graphics for report covers, special presentations, brochures, mailers, and calendars.

- **HP Brochure Paper 180g Matte or HP Professional Paper 180 Matt**

These papers are matte-coated on both sides for two-sided use. They are the perfect choice for near-photographic reproductions and business graphics for report covers, special presentations, brochures, mailers, and calendars.

Everyday printing

- **HP Bright White Inkjet Paper**

HP Bright White Inkjet Paper delivers high-contrast colors and sharp text. It is opaque enough for two-sided color usage with no show-through, which makes it ideal for newsletters, reports, and flyers. It features ColorLok Technology for less smearing, bolder blacks, and vivid colors.

- **HP Printing Paper**

HP Printing Paper is a high-quality multifunction paper. It produces documents that look and feel more substantial than documents printed on standard multipurpose or copy paper. It features ColorLok Technology for less smearing, bolder blacks, and vivid colors. It is acid-free for longer lasting documents.

- **HP Office Paper**

HP Office Paper is a high-quality multifunction paper. It is suitable for copies, drafts, memos, and other everyday documents. It features ColorLok Technology for less smearing, bolder blacks, and vivid colors. It is acid-free for longer lasting documents.

- **HP Office Recycled Paper**

HP Office Recycled Paper is a high-quality multifunction paper made with 30% recycled fiber. It features ColorLok Technology for less smearing, bolder blacks and vivid colors.

Special projects

- **HP Iron-On Transfers**

HP Iron-on Transfers (for light or white fabrics) are the ideal solution for creating custom T-shirts from your digital photos.

Order HP paper supplies

The printer is designed to work well with most types of office paper. Use HP paper for optimum print quality. Visit the HP website at www.hp.com for more information about HP paper.

HP recommends plain papers with the ColorLok logo for printing and copying of everyday documents. All papers with the ColorLok logo are independently tested to meet high standards of reliability and print quality, and produce documents with crisp, vivid color, bolder blacks and dry faster than ordinary plain papers. Look for papers with the ColorLok logo in a variety of weights and sizes from major paper manufacturers.

You can purchase HP paper and supplies online at www.hp.com. Look for the **Shop for Products and Services** link.

Tips for selecting and using paper

For the best results, observe the following guidelines.

- Load only one type of paper at a time into a tray or automatic document feeder (ADF).
- When loading the trays and ADF, make sure the paper is loaded correctly.
- Do not overload the tray or ADF.
- To prevent jams, poor print quality, and other printing problems, avoid loading the following paper in the trays or ADF:
 - Multipart forms
 - Paper that is damaged, curled, or wrinkled
 - Paper with cutouts or perforations
 - Paper that is heavily textured, embossed, or does not accept ink well
 - Paper that is too lightweight or stretches easily
 - Paper that contains staples or clips

For more information on loading paper, see [Load paper on page 23](#) or [Load an original in the document feeder on page 28](#).

Load paper

This section provides instructions for loading paper into the printer.

- [Load standard-size paper](#)
- [Load envelopes](#)
- [Load cards and photo paper](#)

Load standard-size paper

To load standard paper:

1. Pull out main input tray.

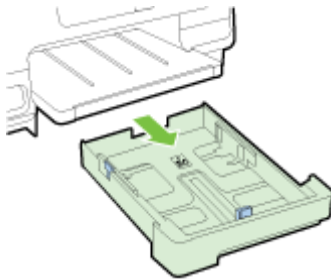

2. Slide the paper-width guides out as far as possible.
3. Insert the paper print-side down in the center of the tray.

Make sure the stack of paper is inserted as far inside the printer as possible and does not exceed the higher line marking in the tray. For more help, refer to the diagram engraved in the tray.

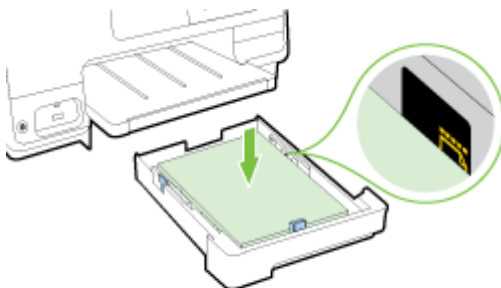

 **NOTE:** Do not load paper while the printer is printing.

4. Slide the paper-width guides in the tray until they touch the edge of the stack of paper, and then reinsert the tray.

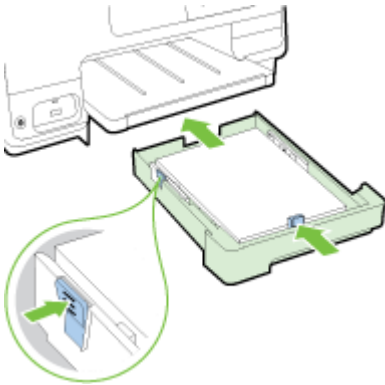

 **NOTE:** To load legal-size paper, press the blue latch at the bottom left of the input tray and fully extend the tray.

5. Pull out the output tray extension until the intended paper size is reached.

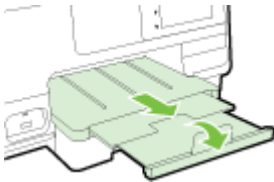

 **NOTE:** If you have a second tray, see [Install and use second tray \(Tray 2\)](#) on page 30 for how to load paper.

Load envelopes

To load an envelope:

 **NOTE:** If your printer has a second tray (Tray 2), do not insert envelopes for printing in this slot.

1. Pull out main input tray.

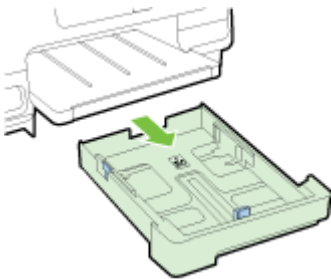

2. Insert the envelopes print-side down and load according to the graphic.

Make sure the stack of envelopes does not exceed the lower line marking in the tray. For more help, refer to the diagram engraved in the tray.

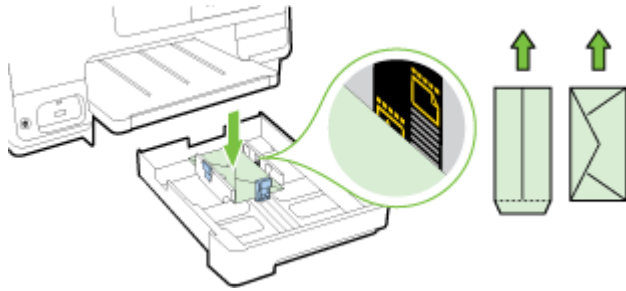

NOTE: Do not load envelopes while the printer is printing.

3. Slide the paper-width guides in the tray until they touch the edge of the stack of envelopes, and then reinsert the tray.

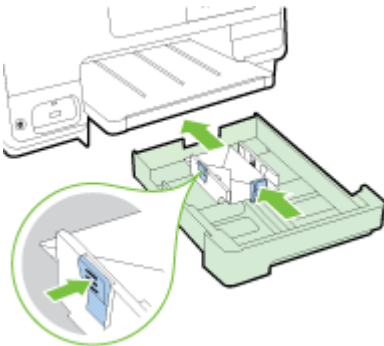

4. Pull out the output tray extension until the intended paper size is reached.

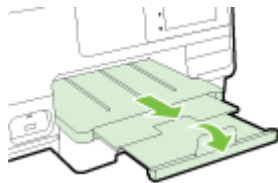

Load cards and photo paper

To load cards and photo paper:

If your printer has a second tray (Tray 2), do not insert cards or photo paper for printing in this slot.

1. Pull out main input tray.

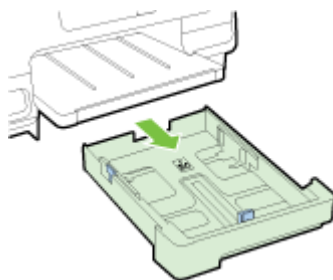

2. Insert the paper print-side down in the center of the tray.

Make sure the stack of paper is inserted as far inside the printer as possible and does not exceed the lower line marking in the tray. For more help, refer to the diagram engraved in the tray.

If the photo paper has a tab along one edge, make sure the tab is pointing towards the front of the printer.

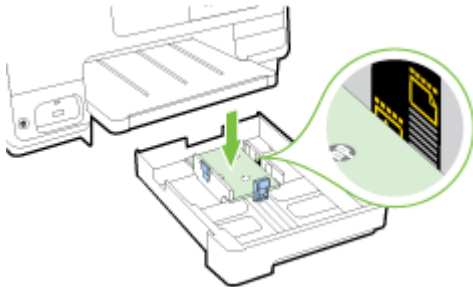

 **NOTE:** Do not load paper while the printer is printing.

3. Slide the paper-width guides in the tray until they touch the edge of the stack of paper, and then reinsert the tray.

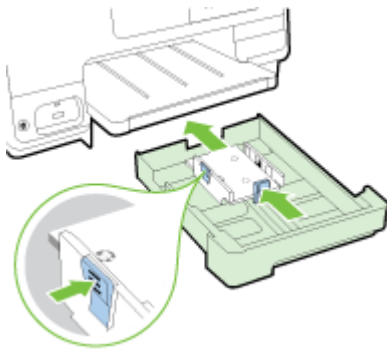



4. Pull out the output tray extension until the intended paper size is reached.



Load an original on the scanner glass

You can copy, scan, or fax originals by loading them on the scanner glass.

 **NOTE:** Many of the special features do not work correctly if the scanner glass and lid backing are not clean. For more information, see [Maintain the printer on page 34](#).

 **NOTE:** Remove all originals from the document feeder tray before lifting the lid on the printer.

To load an original on the scanner glass

Use these steps to load an original on the scanner glass.

1. Lift the scanner lid.
2. Load your original print-side down near to the engaged guides along the scanner glass edge as shown in the following illustration.

 **NOTE:** If you are using the scanner glass, ensure that the automatic document feeder is empty. Otherwise, the printer will sense the document in the ADF instead of the paper on the scanner glass.

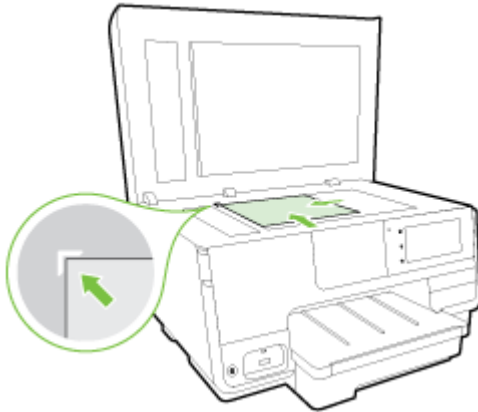

3. Close the lid.

Load an original in the document feeder

You can copy, scan, or fax a document by placing it in the document feeder.

⚠ CAUTION: Do not load photos in the document feeder; this might cause damage to your photos. Use only paper that is supported by the document feeder.

For more information, see [Tips for selecting and using paper on page 22](#).

📄 NOTE: Scanning double-sided documents on A4, Letter-, or legal-size paper can only be supported by some models of the printer ADF.

📄 NOTE: Some features, such as the **Fit to Page** copy feature, do not work when you load your originals in the ADF. You must load your originals on the scanner glass.

The document feeder tray holds a maximum of 35 or 50 sheets of plain A4-, Letter-, or legal-size paper, depending on the printer model.

To load an original in the document feeder

Use these steps to load a document in the ADF.

1. Load your original print-side up into the ADF.
 - a. If you are loading an original printed in portrait orientation, place the pages so that the top edge of the document goes in first. If you are loading an original printed in landscape orientation, place the pages so that the left edge of the document goes in first.
 - b. Slide the paper into the ADF until you hear a tone or see a message on the display indicating that the loaded pages were detected.

💡 TIP: For more help on loading originals in the ADF, refer to the diagram engraved in the document feeder tray.

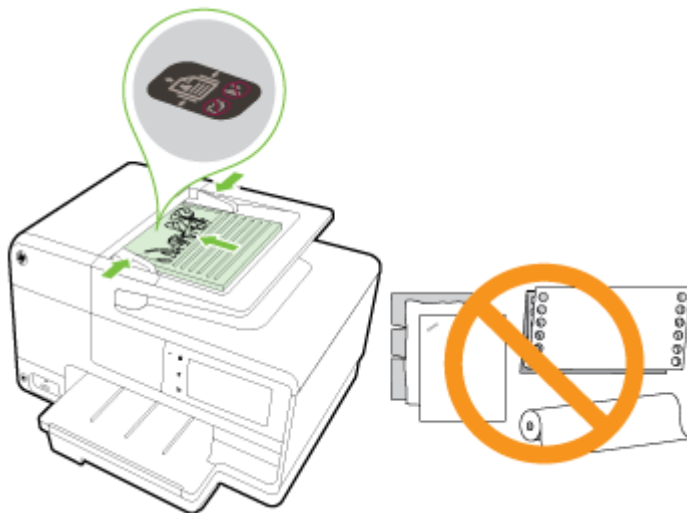

2. Slide the paper-width guides inward until they stop at the left and right edges of the paper.

Insert a USB flash drive

Using the USB port on the front of the printer, you can connect a USB flash drive. You can also transfer files from the USB flash drive to your computer or scan files to the USB flash drive from the printer.

 **CAUTION:** Attempting to remove a USB flash drive while it is being accessed can damage files on the USB flash drive. You can safely remove a USB flash drive only when the status light is not blinking.

 **NOTE:** The printer does not support encrypted USB flash drives.

To connect a USB flash drive

- ▲ Insert the USB flash drive to the USB port on the front of the printer.

 **NOTE:** If your USB flash drive does not fit into this port due to size limitations, or if the connector on the device is shorter than 11 mm (0.43 in), you will need to purchase a USB extension cable in order to use your device with this port.

Set up and use accessories

If you want to install and set up accessories (such as a second tray and duplexer), see the following sections.

When using more than one tray, you can make use of the tray features provided to achieve a better experience.

 **NOTE:** You can purchase the accessories online at www.hp.com. Look for **Shop for Products and Services**.

- To install a duplexer, see [Install the automatic two-sided printing accessory \(duplexer\) on page 30](#).
- To install Tray 2, see [Install and use second tray \(Tray 2\) on page 30](#).
- To understand about using tray features, see [Work with trays on page 31](#).

Install the automatic two-sided printing accessory (duplexer)

For information on duplexing, see [Print on both sides \(duplexing\) on page 48](#).

To install a duplexer

- ▲ Slide the duplexer into the back of the printer until the unit locks into place.

Do not press the buttons on either side of the duplexer when installing the unit; use them only for removing the unit from the printer.

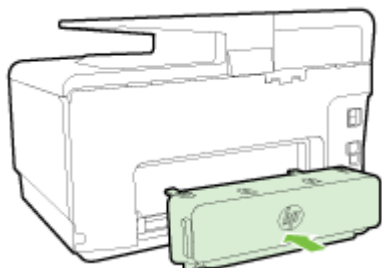

Install and use second tray (Tray 2)

To install Tray 2

1. Unpack the tray, remove the packing tapes and materials, and move the tray to the prepared location.

The surface must be sturdy and level.

2. Turn off the printer, and unplug the power cord from the electrical socket.
3. Set the printer on top of the tray.

 **CAUTION:** Be careful to keep your fingers and hands clear of the bottom of the printer.

4. Connect the power cord and turn on the printer.
5. Enable Tray 2 in the printer driver.

For more information, see [Work with trays on page 31](#).

To load paper in Tray 2

Tray 2 supports only plain paper that are not smaller than A4 or Letter . For more information about the capacity of the input tray, see [Input tray capacity on page 165](#).

1. Pull the tray out of the printer by grasping under the front of the tray.

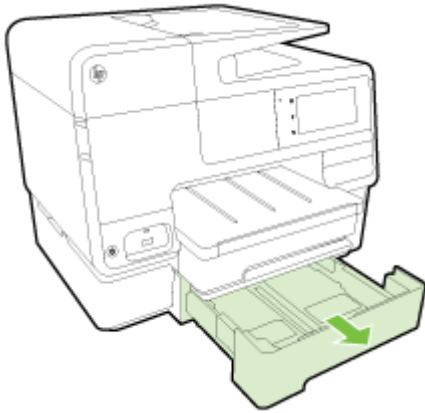

2. Insert the paper print-side down in the center of the tray.

Make sure the stack of paper aligns with the line on the paper-width guide, and does not exceed the higher line marking in the tray.

 **NOTE:** Tray 2 can be loaded only with plain paper.

3. Slide the paper-width guides in the tray to adjust them for the size that you have loaded.

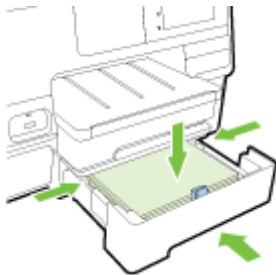

4. Gently reinsert the tray.
5. Pull out the output tray extender.

Work with trays

When using more than one tray, you can make use of the tray features provided and change the settings to achieve a better experience.

By default, the printer draws paper from Tray 1. If Tray 1 is empty and Tray 2 is installed and contains paper, the printer will draw paper from Tray 2.

You can change the behaviors using the following features:

- **Default Tray:** Set the default tray from which the printer draws paper first.
- **Tray Lock:** Lock a tray to prevent it from accidental use; for example, when you have loaded special paper (such as letterhead or preprinted paper).

The printer will not use a locked tray even when the other tray is empty.

 **NOTE:** For better experience, load only one type of paper in a tray.

 **NOTE:** Tray 2 supports only plain paper.

To achieve this	Follow these steps
Have paper loaded in both trays and use paper from one tray if the other tray is empty.	<ul style="list-style-type: none">• Load paper in both trays. For more information, see Load paper on page 23.• Turn off tray lock.
Have paper loaded in both trays and use paper from one of the trays first.	<ul style="list-style-type: none">• Load paper in both trays.• Set the desired tray as the default tray.
Be able to choose from plain paper and another paper type that you use occasionally.	<ul style="list-style-type: none">• Load special paper in main input tray and plain paper in Tray 2.
NOTE: For better experience, load only one type of paper in a tray.	<ul style="list-style-type: none">• Lock the main input tray and set Tray 2 as the default tray.

To change tray settings

 **NOTE:** You can also change the tray settings from the printer software or EWS.

To access EWS and the printer software, see [Embedded web server on page 118](#) and [Open the HP printer software \(Windows\) on page 37](#).

1. Make sure the printer is turned on.
2. Make sure you have turned on automatic selection of paper source.
3. From the printer control panel display, touch and slide your finger across the screen and touch **Setup**.
4. Touch **Tray Setup**, touch **Default Tray** or **Tray Lock**, and then select the appropriate option.

To turn on automatic selection of tray or paper source (Windows)

1. Depending on your operating system, do one of the following:
 - **Windows 8:** On the **Start** screen, click **Control Panel**, click **View devices and printers**; right-click the printer icon, and then click **Printing preferences**.
 - **Windows 7:** Click **Start**, click **Devices and Printers**; right-click the printer icon, click **Printing preferences**, and then select your printer name.
 - **Windows Vista and Windows XP:** Click **Start**, click **Printers** or **Printers and Faxes**; right-click the printer icon, click **Printing preferences**.
2. On the **Printing preferences** tab, click the **Paper/Quality** tab.
3. Select **Printer Auto Select** from the **Paper Source** drop-down list in the **Tray Selection** area.
4. Click **OK** twice to close the pages and accept changes.

To turn on automatic selection of tray or paper source (OS X)

1. From the **File** menu in your software, choose **Print**.
2. Make sure your printer is selected.
3. Select **Automatically Select** from the **Source** drop-down list.

Do the following if you do not see options on the Print dialog.

- **OS X v10.6:** Click the blue disclosure triangle next to the Printer selection to access the print options.
- **OS X Lion and Mountain Lion:** Click **Show Details** to access the print options.

Maintain the printer

This section provides instructions for keeping the printer in top working condition. Perform these maintenance procedures as necessary.

- [Clean the scanner glass](#)
- [Clean the exterior](#)
- [Clean the automatic document feeder](#)

Clean the scanner glass

Dust or dirt on the scanner glass, scanner lid backing, or scanner frame can slow down performance, degrade the quality of scans, and affect the accuracy of special features such as fitting copies to a certain page size.

To clean the scanner glass

1. Turn off the printer by pressing the  (the Power button) and unplug the power cord from the electrical socket.
2. Lift the scanner lid.
3. Clean the scanner glass and lid backing by using a soft, lint-free cloth that has been sprayed with a mild glass cleaner.



CAUTION: Use only glass cleaner to clean the scanner glass. Avoid cleaners that contain abrasives, acetone, benzene, and carbon tetrachloride, all of which can damage the scanner glass. Avoid isopropyl alcohol because it can leave streaks on the scanner glass.

CAUTION: Do not spray the glass cleaner directly on the scanner glass. If too much glass cleaner is applied, the cleaner could leak under the scanner glass and damage the scanner.

4. Close the scanner lid, and turn on the printer.

Clean the exterior

WARNING! Before cleaning the printer, press  (the Power button) to turn off the printer and unplug the power cord from the wall socket.

Use a soft, damp, lint-free cloth to wipe dust, smudges, and stains off of the case. Keep fluids away from the interior of the printer, as well as from the printer control panel.

Clean the automatic document feeder

If the automatic document feeder picks up multiple pages or if it does not pick up plain paper, you can clean the rollers and separator pad.

To clean the rollers or separator pad

1. Turn off the printer by pressing the  (the Power button) and unplug the power cord from the electrical socket.
2. Remove all originals from the document feeder tray.
3. Lift the automatic document feeder cover (1).

This provides easy access to the rollers (2) and separator pad (3).

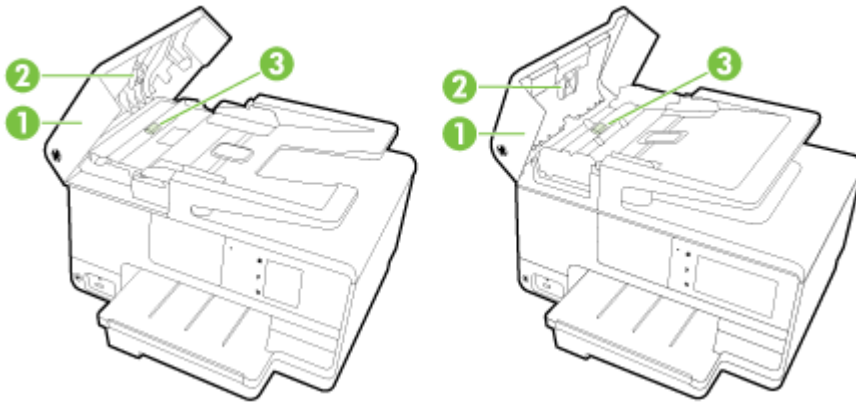

1	Automatic document feeder cover
2	Rollers
3	Separator pad

4. Lightly dampen a clean lint-free cloth with distilled water, then squeeze any excess liquid from the cloth.
5. Use the damp cloth to wipe any residue off the rollers or separator pad.

 **NOTE:** If the residue does not come off using distilled water, try using isopropyl (rubbing) alcohol.

6. Close the cover of the automatic document feeder.

Update the printer

HP is always working to improve the performance of its printers and bring you the latest features.

 **NOTE:** By default, if the printer is connected to a network and Web Services has been enabled, the printer automatically checks for updates.

To update the printer using the printer control panel

1. From the printer control panel display, touch  (HP ePrint), touch **OK**, touch **Settings**, and then touch **Printer Update**.
2. Touch **Check for Product Update**, and then follow the on-screen instructions.

To enable the printer to automatically check for updates

 **NOTE:** The default setting of **Auto Update** is **On**.

1. From the printer control panel display, touch  (HP ePrint), touch **OK**, touch **Settings**, and then touch **Printer Update**.
2. Touch **Auto Update** and then touch **On**.

To update the printer using the embedded web server

1. Open the EWS.
For more information, see [Embedded web server on page 118](#).
2. Click the **Web Services** tab.
3. In the **Web Services Settings** section, click **Product Update**, click **Check Now**, and then follow the on-screen instructions.
4. If the product update option is not available, follow these instructions:
 - a. In the **Web Services Settings** section, click **Setup**, click **Continue**, and follow the on-screen instructions.
 - b. If prompted, choose to allow the printer to check for and install printer updates.

 **NOTE:** If a printer update is available, the printer downloads and installs the update, and then restarts.

 **NOTE:** If prompted for proxy settings and if your network uses proxy settings, follow the on-screen instructions to set up a proxy server. If you do not have the details, contact your network administrator or the person who set up the network.

Open the HP printer software (Windows)

After installing the HP printer software, depending on your operating system, do one of the following:

- **Windows 8:** Right-click an empty area on the Start screen, click **All Apps** on the app bar, and then select the printer name.
- **Windows 7, Windows Vista, and Windows XP:** From the computer desktop, click **Start**, select **All Programs**, click **HP**, click the folder for the printer, and then select the icon with the printer's name.

Turn the printer off

Turn the printer off by pressing  (the Power button) located on the printer. Wait until the power light turns off before unplugging the power cord or turning off a power strip.

⚠ CAUTION: If you incorrectly turn the printer off, the print carriage might not return to the correct position, causing problems with the ink cartridges and print quality issues.

Restore defaults

If you disable some functions or change some settings and want to change them back, you can restore the printer to the original factory settings or network settings.

To restore the printer to the original factory settings

1. From the printer control panel display, touch and slide your finger across the screen and then touch **Setup**.
2. Touch **Tools**.
3. Touch **Restore Factory Defaults**, and then touch **Yes**.

A message appears stating that the printer defaults have been restored.

4. Touch **OK**.

To restore the printer to the original network settings

1. From the printer control panel, touch and slide your finger across the screen, touch **Setup**, and then touch **Network Setup**.

2. Touch **Restore Network Defaults**, and then touch **Yes**.

A message appears stating that the network defaults have been restored.

3. Touch **OK**.

4. Print the network configuration page and verify that the network settings have been reset.

For more information, see [Network configuration page on page 126](#).

 **NOTE:** Previously configured wireless settings are removed when you reset the printer network settings.

 **TIP:** You can visit the HP online support website at www.hp.com/support for information and utilities that can help you correct many common printer problems.

(Windows) If you're having trouble printing, [run the HP Print and Scan Doctor](#) to troubleshoot the issue automatically. The utility will try to diagnose and fix the issue. The HP Print and Scan Doctor may not be available in all languages.

3 Print

Most print settings are automatically handled by the software application. Change the settings manually only when you want to change print quality, print on specific types of paper, or use special features.

For more information about selecting the best print paper for your documents, see [Paper basics on page 20](#).

Choose a print job to continue:



[Print documents on page 42](#)



[Print on envelopes on page 43](#)



[Print photos on page 45](#)

Print documents

 **TIP:** This printer includes HP ePrint, a free service from HP that allows you to print documents on your HP ePrint-enabled printer anytime, from any location, without any additional software or printer drivers. For more information, see [HP ePrint on page 91](#).

To print from software (Windows)

1. Load paper in the tray. For more information, see [Load paper on page 23](#).
2. From your software, select **Print**.
3. Make sure your printer is selected.
4. Click the button that opens the **Properties** dialog box.

Depending on your software application, this button might be called **Properties**, **Options**, **Printer Setup**, **Printer Properties**, **Printer**, or **Preferences**.

5. Select the appropriate options.
 - On the **Layout** tab, select **Portrait** or **Landscape** orientation.
 - On the **Paper/Quality** tab, select the appropriate paper type from the **Media** drop-down list in the **Tray Selection** area, and then select the appropriate print quality in the **Quality Settings** area.
 - Click the **Advanced** button, in the **Paper/Output** area, select the appropriate paper size from the **Paper Size** drop-down list.

For more printing options, see [Tips for print success on page 49](#).

6. Click **OK** to close the **Properties** dialog box.
7. Click **Print** or **OK** to begin printing.

To print from software (OS X)

1. Load paper in the tray. For more information, see [Load paper on page 23](#).
2. From the **File** menu in your software, choose **Print**.
3. Make sure your printer is selected.
4. Specify the page properties.

Do the following if you do not see options on the Print dialog.

- **OS X v10.6:** Click the blue disclosure triangle next to the Printer selection to access the print options.
- **OS X Lion and Mountain Lion:** Click **Show Details** to access the print options.

 **NOTE:** The following options are available for your printer. Locations for the options can vary from one application to another.

- Choose the paper size.
 - Select the orientation.
 - Enter the scaling percentage.
5. Click **Print**.

Print on envelopes

Avoid envelopes with the following characteristics:

- Very slick finish
- Self-stick adhesives, clasps, or windows
- Thick, irregular, or curled edges
- Areas that are wrinkled, torn, or otherwise damaged

Make sure the folds of envelopes you load in the printer are sharply creased.



NOTE: For more information about printing on envelopes, see the documentation available with the software program you are using.

To print envelopes (Windows)

1. Load envelopes print-side down in the tray. For more information, see [Load paper on page 23](#).
2. On the **File** menu in your software, click **Print**.
3. Make sure your printer is selected.
4. Click the button that opens the **Properties** dialog box.

Depending on your software application, this button might be called **Properties**, **Options**, **Printer Setup**, **Printer Properties**, **Printer**, or **Preferences**.

5. Select the appropriate options.
 - On the **Layout** tab, select **Portrait** or **Landscape** orientation.
 - On the **Paper/Quality** tab, select the appropriate paper type from the **Media** drop-down list in the **Tray Selection** area, and then select the appropriate print quality in the **Quality Settings** area.
 - Click the **Advanced** button, in the **Paper/Output** area, select the appropriate paper size from the **Paper Size** drop-down list.

For more printing options, see [Tips for print success on page 49](#).

6. Click **OK**, and then click **Print** or **OK** in the **Print** dialog box.

To print envelopes (OS X)

1. Load envelopes print-side down in the tray. For more information, see [Load paper on page 23](#).
2. From the **File** menu in your software, choose **Print**.
3. Make sure your printer is selected.
4. Set the print options.

Do the following if you do not see options on the Print dialog.

- **OS X v10.6:** Click the blue disclosure triangle next to the Printer selection to access the print options.
- **OS X Lion and Mountain Lion:** Click **Show Details** to access the print options.



NOTE: The following options are available for your printer. Locations for the options can vary from one application to another.

- a. Select the appropriate envelope size from the **Paper Size** pop-up menu.
 - b. From the pop-up menu, choose **Paper Type/Quality**, and verify the paper type setting is set to **Plain Paper**.
5. Click **Print**.

Print photos

Do not leave unused photo paper in the input tray. The paper might start to curl, which could impair the quality of your printout. Photo paper should be flat before printing.

 **TIP:** This printer includes HP ePrint, a free service from HP that allows you to print documents on your HP ePrint-enabled printer anytime, from any location, and without any additional software or printer drivers. For more information, see [HP ePrint on page 91](#).

To print a photo from the computer (Windows)

1. Load paper in the tray. For more information, see [Load paper on page 23](#).
2. From your software, select **Print**.
3. Make sure your printer is selected.
4. Click the button that opens the **Properties** dialog box.

Depending on your software application, this button might be called **Properties**, **Options**, **Printer Setup**, **Printer Properties**, **Printer**, or **Preferences**.

5. Select the appropriate options.
 - On the **Layout** tab, select **Portrait** or **Landscape** orientation.
 - On the **Paper/Quality** tab, select the appropriate paper type from the **Media** drop-down list in the **Tray Selection** area, and then select the appropriate print quality in the **Quality Settings** area.
 - Click the **Advanced** button, in the **Paper/Output** area, select the appropriate paper size from the **Paper Size** drop-down list.

For more printing options, see [Tips for print success on page 49](#).

 **NOTE:** For maximum dpi resolution, go to **Paper/Quality** tab, select **Photo Paper** from the **Media** drop-down list, and then select **Best** in the **Quality Settings** area. Then click the **Advanced** button and select **Yes** from the **Print in Max DPI** drop-down list. If you want to print max DPI in grayscale, select **High Quality Grayscale** from the **Print in Grayscale** drop-down list.

6. Click **OK** to return to the **Properties** dialog box.
7. Click **OK**, and then click **Print** or **OK** in the **Print** dialog box.

 **NOTE:** After the printing is finished, remove unused photo paper from the input tray. Store the photo paper so it does not start to curl, which could reduce the quality of your printout.

To print a photo from the computer (OS X)

1. Load paper in the tray. For more information, see [Load paper on page 23](#).
2. From the **File** menu in your software, choose **Print**.
3. Make sure your printer is selected.
4. Set the print options.

Do the following if you do not see options on the Print dialog.

- **OS X v10.6:** Click the blue disclosure triangle next to the Printer selection to access the print options.
- **OS X Lion and Mountain Lion:** Click **Show Details** to access the print options.

 **NOTE:** The following options are available for your printer. Locations for the options can vary from one application to another.

- a. Choose the appropriate paper size in the **Paper Size** pop-up menu.
 - b. Select an **Orientation**.
 - c. From the pop-up menu, choose **Paper Type/Quality**, and then choose the following settings:
 - **Paper Type:** The appropriate photo paper type
 - **Quality: Best** or **Maximum dpi**
 - Click the **Color Options** disclosure triangle, and then choose the appropriate **Photo Fix** option.
 - **Off:** applies no changes to the image.
 - **Basic:** automatically focuses the image; moderately adjusts image sharpness.
5. Select any other print settings you want, and then click **Print**.

Print photos from a memory card

You can connect a USB flash drive (such as a keychain drive or portable hard drive) to the USB port on the front of the printer.

For more information about using memory devices, see [Insert a USB flash drive on page 29](#).

 **CAUTION:** Attempting to remove a memory device while it is being accessed can damage files on the memory device. You can safely remove a memory card only when the status light is not blinking.

1. Insert a USB flash drive into the front USB port.
2. From the control panel display, touch **Print Photos**.
3. Touch **View & Print** to display photos.
4. Touch a photo that you want to print, and then touch **Select**.
5. Scroll up or down to specify the number of photos to print.
6. Touch **Edit** to select options to edit the selected photos. You can rotate, crop a photo, or turn **Photo Fix** or **Red Eye Removal** on and off.
7. Touch **Done** and touch **Continue** to preview the selected photo. If you wish to adjust layout or paper type, touch **Settings**, and then touch your selection. You can also save any new settings as defaults.
8. Touch **Print** to begin printing.

Print using the maximum dpi

Use the maximum dots per inch (dpi) mode to print high-quality, sharp images on photo paper.

Printing in maximum dpi takes longer than printing with other settings and requires a large amount of memory.

To print in maximum dpi mode (Windows)

1. From your software, select **Print**.
2. Make sure your printer is selected.
3. Click the button that opens the **Properties** dialog box.
Depending on your software application, this button might be called **Properties**, **Options**, **Printer Setup**, **Printer Properties**, **Printer**, or **Preferences**.
4. Click the **Paper/Quality** tab.
5. From the **Media** drop-down list, select a media type from the available list.
 - HP Premium Plus Photo Papers
 - HP Advanced Photo Papers
6. Click the **Advanced** button.
7. In the **Printer Features** area, select **Yes** from the **Print in Max DPI** drop-down list.
8. Select the appropriate paper size from the **Paper Size** drop-down list.
9. Click **OK** to close the advanced options.
10. Confirm **Orientation** on the **Layout** tab, and then click **OK** to print.

To print using maximum dpi (OS X)

1. From the **File** menu in your software, choose **Print**.
2. Make sure your printer is selected.
3. Set the print options.

Do the following if you do not see options on the Print dialog.

- **OS X v10.6:** Click the blue disclosure triangle next to the Printer selection to access the print options.
- **OS X Lion and Mountain Lion:** Click **Show Details** to access the print options.

 **NOTE:** The following options are available for your printer. Locations for the options can vary from one application to another.

- a. Choose the appropriate paper size in the **Paper Size** pop-up menu.
- b. From the pop-up menu, choose **Paper Type/Quality**, and then choose the following settings:
 - **Paper Type:** The appropriate photo paper type
 - **Quality:** **Best** or **Maximum dpi**
4. Select any other print settings that you want, and then click **Print**.

Print on both sides (duplexing)

You can print on both sides of a sheet of paper automatically using the automatic two-sided printing accessory (duplexer).

 **NOTE:** Two-sided printing requires an automatic two-sided printing accessory (duplexer) to be installed on the printer.

 **NOTE:** You can perform manual duplexing by first printing only the odd pages, flipping the pages over, and then printing only the even pages.

To print on both sides of the page (Windows)

1. From your software, select **Print**.
2. Make sure your printer is selected.
3. Click the button that opens the **Properties** dialog box.

Depending on your software application, this button might be called **Properties**, **Options**, **Printer Setup**, **Printer Properties**, **Printer**, or **Preferences**.

4. Select the appropriate options.
 - On the **Layout** tab, select **Portrait** or **Landscape** orientation.
 - On the **Paper/Quality** tab, select the appropriate paper type from the **Media** drop-down list in the **Tray Selection** area, and then select the appropriate print quality in the **Quality Settings** area.
 - Click the **Advanced** button, in the **Paper/Output** area, select the appropriate paper size from the **Paper Size** drop-down list.

For more printing options, see [Tips for print success on page 49](#).

5. On the **Layout** tab, select **Flip on Long Edge** or **Flip on Short Edge** from the **Print on Both Sides** drop-down list.
6. Click **OK** to print.

 **NOTE:** After one page of the document is printed, you are prompted to wait for a few seconds. Then the printer automatically reloads the paper back to print on the other side. You do not need to manually reload the paper.

To print on both sides of the page (OS X)

1. From the **File** menu in your software, choose **Print**.
2. In the Print dialog, choose **Layout** from the pop-up menu.
3. Choose the type of binding you want for your two-sided pages, and then click **Print**.

Tips for print success

For good printing experience, HP ink cartridges should be correctly installed, have sufficient ink, and working properly; and paper should be properly loaded with correct print settings.

Ink tips

- If the print quality is not acceptable, see [Solve printing problems on page 131](#) for more information.

- Use Original HP ink cartridges.
- Install both the black and color cartridges correctly.

For more information, see [Replace the ink cartridges on page 99](#).

- Check the estimated ink levels in the cartridges to make sure there is sufficient ink.

For more information, see [Check the estimated ink levels on page 97](#).

- Always turn off the printer with  (the Power button) to allow the printer to protect the nozzles.

Paper loading tips

For more information, also see [Load paper on page 23](#).

- Load a stack of paper (not just one page). All the paper in the stack should be of the same size and type to avoid a paper jam.
- Load paper with the print-side down in the main tray.
- Ensure that paper loaded in the input tray lays flat and the edges are not bent or torn.
- Adjust the paper-width guides in the input tray to fit snugly against all paper. Make sure the guides do not bend the paper in the tray.

Printer settings tips (Windows)

- To change default print settings, click **Set Preferences** under **Print, Scan & Fax** in the HP printer software.

For more information to open the printer software, see [Open the HP printer software \(Windows\) on page 37](#).

- To select the number of pages to print per sheet, on the **Layout** tab of the printer driver, select the appropriate option from the **Pages per Sheet** drop-down list.
- If you want to change the page orientation, set it in your application interface.
- To view more printing settings, on the **Layout** or **Paper/Quality** tab of the printer driver, click the **Advanced** button to open the **Advanced Options** dialog box.
 - **Print in Grayscale:** Allows you to print a black and white document using the black ink only. Select **Black Ink Only**, and then click the **OK** button.
 - **Pages per Sheet Layout:** Helps you specify the order of the pages if you print document in more than two pages per sheet.

 **NOTE:** The preview on the **Layout** tab cannot reflect what you select from the **Pages per Sheet Layout** drop-down list.

- **Borderless Printing:** Select this feature to print photos without border. Not all paper types support this feature. You will see an alert icon beside the option if the selected paper type in the **Media** drop-down list does not support it.
- **Preserve Layout:** This feature only works with the duplex printing. If the image is larger than the printable area, select this feature to scale the page content to be within the smaller margins so that extra pages are not created.
- **HP Real Life Technologies:** This feature smooths and sharpens images and graphics for improved print quality.
- **Booklet:** Allows you to print multiple-page document as a booklet. It places two pages on each side of a sheet that can then be folded into a booklet in half size of the paper. Select a binding method from the drop-down list, and then click **OK**.
 - **Booklet-LeftBinding:** The binding side after folded into a booklet appears at the left side. Select the option if your reading habit is from left to right.
 - **Booklet-RightBinding:** The binding side after folded into a booklet appears at the right side. Select the option if your reading habit is from right to left.

 **NOTE:** The preview on the **Layout** tab cannot reflect what you select from the **Booklet** drop-down list.

- **Page Borders:** Allows you to add the borders to the pages if you print the document with two or more pages per sheet.

 **NOTE:** The preview on the **Layout** tab cannot reflect what you select from the **Page Borders** drop-down list.

- You can use printing shortcut to save setting time. A printing shortcut stores the setting values that are appropriate for a particular kind of job, so that you can set all the options with a single click. To use it, go to the **Printing Shortcut** tab, select one printing shortcut, and then click **OK**.

To add a new printing shortcut, after making settings on the **Layout** or **Paper/Quality** tab, click the **Printing Shortcut** tab, click **Save As** and enter a name, and then click **OK**.

To delete a printing shortcut, select it, and then click **Delete**.

 **NOTE:** You cannot delete the default printing shortcuts.

Printer settings tips (OS X)

- On the Print dialog, use the **Paper Size** pop-up menu to select the size of paper loaded in the printer.
- On the Print dialog, choose the **Paper Type/Quality** pop-up menu and select the appropriate paper type and quality.
- To print a black and white document using only black ink, choose the **Paper Type/Quality** from the pop-up menu and choose **Grayscale** from the Color pop-up menu.

Notes

- Original HP ink cartridges are designed and tested with HP printers and papers to help you easily produce great results, time after time.



NOTE: HP cannot guarantee the quality or reliability of non-HP supplies. Product service or repairs required as a result of using a non-HP supply will not be covered under warranty.

If you believe you purchased Original HP ink cartridges, go to www.hp.com/go/anticounterfeit.

- Ink level warnings and indicators provide estimates for planning purposes only.



NOTE: When you receive a low-ink warning message, consider having a replacement cartridge available to avoid possible printing delays. You do not need to replace the cartridges until print quality becomes unacceptable.

- Software settings selected in the print driver only apply to printing, they do not apply to copying or scanning.
- You can print your document on both sides of the paper.

4 Copy and scan

- Copy
- Scan

Copy

Using the **Copy** menu on the printer control panel display, you can easily select the number of copies and color or black-and-white copying.

You can also access advanced settings, such as change the paper type and size, adjust the darkness of the copy, or resize the copy.



To copy documents

1. Make sure you have paper loaded in the main tray. For more information, see [Load paper on page 23](#).
2. Place your original print-side down on the scanner glass or print-side up in the ADF.

For more information, see [Load an original on the scanner glass on page 27](#) or [Load an original in the document feeder on page 28](#).

 **NOTE:** If you are copying a photo, place it face down on the scanner glass, as shown by the icon on the edge of the glass.

3. From the printer control panel display, touch **Copy**.
4. Scroll up or down to select the number of copies.

 **TIP:** To save these settings as defaults for future jobs, from the printer control panel display, touch **Copy**, touch  or **Settings**, and then touch **Set As New Defaults**.

5. Touch **Black** or **Color** to start the copy job.

 **NOTE:** If you have a color original, selecting **Black** produces a black-and-white copy, while selecting **Color** produces a full-color copy.

More copy settings

You can customize copy jobs using the various settings available from the printer control panel.

In the **Copy** menu, touch  or **Settings** and change the desired settings.

- Number of Copies
- Paper Size
- Paper Type
- Tray Selection
- HP Copy Fix
- Two-Sided
- ID Copy
- Quality
- Preview and Edit
- Lighter/Darker
- Resize
- Collate
- Margin Shift

- Enhancements
- Set as New Defaults

Scan

You can scan documents, photos, and other originals, and send them to a variety of destinations, such as a folder on a computer.

Using the HP printer software, you can also scan documents into a format that you can search, copy, paste, and even edit.

 **NOTE:** Some scan functions are only available after you have installed the HP printer software.

 **TIP:** If you have problems scanning documents, see [Solve scan problems on page 137](#).

- [Scan an original](#)
- [Scan using Webscan](#)
- [Scanning documents as editable text](#)

Scan an original

Using the **Scan** menu on the printer control panel display, you can easily select the location of the scanning :

- [Scan to a computer](#)
- [Scan to a memory device](#)

 **NOTE:** The printer must be connected to the computer and be turned on.

 **NOTE:** If you are scanning an original from the printer control panel or from your computer using the HP printer software, the printer software provided with the printer must be installed on your computer prior to scanning. In addition, on Windows computers, the printer software must be running prior to scanning.

 **NOTE:** When scanning a borderless original, use the scanner glass and not the ADF.

Scan to a computer

 **NOTE:** To scan to a computer, make sure the feature is enabled.

(Windows) Open the HP printer software, go to the **Scan** section, and then select **Manage Scan to Computer**.

(OS X) If you installed HP Scan, open HP Utility. Under **Scan Settings**, click **Scan to Computer**, and ensure that **Enable Scan to Computer** is selected.

To scan an original from the printer control panel

1. Load your original print-side down in the left-rear corner of the scanner glass or in the ADF.
For more information, see [Load an original on the scanner glass on page 27](#) or [Load an original in the document feeder on page 28](#).
2. Touch **Scan**, and then select **Computer**.
3. Touch a computer that you want to scan to.
4. Choose the type of scan profile you want.
5. Touch **Start Scan**.

 **NOTE:** You can also use the HP printer software to scan documents into editable text. For more information, see [Scanning documents as editable text on page 58](#).

To scan an original from HP printer software (Windows)

1. Load your original print-side down in the left-rear corner of the scanner glass or print-side up in the ADF.

For more information, see [Load an original on the scanner glass on page 27](#) or [Load an original in the document feeder on page 28](#).

2. Open the HP printer software. For more information, see [Open the HP printer software \(Windows\) on page 37](#).
3. In the HP printer software, click **Scan a Document or Photo** under **Print, Scan & Fax**.
4. Select the type of scan that you want from the shortcut menu and then click **Scan**.

 **NOTE:** If **Show Scan Preview** is selected, you will be able to make adjustments to the scanned image in the preview screen.

5. Select **Save** if you want to keep the application open for another scan, or select **Done** to exit the application.
6. Click **Scan** and select a scan shortcut.
7. After the scan is saved, a Windows Explorer window will open in the directory where the scan was saved.

To scan an original from HP printer software (OS X)

1. Open HP Scan.
HP Scan is located in the **Applications/Hewlett-Packard** folder at the top level of the hard disk.
2. Choose the type of scan profile you want and follow the on-screen instructions.

Scan to a memory device

You can scan directly to a USB flash drive from the printer control panel without using a computer or the HP printer software.

 **NOTE:** To scan documents as editable text, use the printer software. For more information, see [Scanning documents as editable text on page 58](#).

To scan an original to a memory device from the printer control panel

1. Load your original print-side down in the left-rear corner of the scanner glass or print-side up in the ADF.

For more information, see [Load an original on the scanner glass on page 27](#) or [Load an original in the document feeder on page 28](#).

2. Insert a USB flash drive. For more information, see [Insert a USB flash drive on page 29](#).
3. Touch **Scan**, and then select **Memory Device**.
4. Make changes to any other scan options, and then touch **Start Scan**.

Scan using Webscan

Webscan is a feature of the embedded web server that lets you scan photos and documents from your printer to your computer using a web browser.

This feature is available even if you have not installed the HP printer software on your computer.

 **NOTE:** Webscan is turned off and needs to be turned on in the EWS. For more information about how to open the EWS, see [Open the embedded web server on page 118](#).

If you cannot find Webscan in the EWS, your network administrator might have turned it off. For more information, contact your network administrator or the person who set up your network.

To scan using Webscan

 **NOTE:** Scanning using Webscan offers basic scan options. For additional scan options or functionality, scan from the HP printer software.

1. Load your original print-side down on the left-rear corner of the scanner glass or print-side up in the ADF.

For more information, see [Load an original on the scanner glass on page 27](#) or [Load an original in the document feeder on page 28](#).

2. Open the embedded web server. For more information, see [Embedded web server on page 118](#).
3. Click the **Settings** tab.
4. In the **Security** section, click **Administrator Settings**, and click **OK**.
5. Select **Webscan** to enable Webscan.
6. Click **Apply** and then click **OK**.
7. Click the **Scan** tab, click **Webscan** in the left pane, change any settings, and then click **Start Scan**.

Scanning documents as editable text

To be able to edit letters, newspaper clippings, and many other documents, you can use the HP printer software to scan them into a format that you can search, copy, paste, and edit.

To scan documents as editable text (Windows)

1. Load your original print-side down in the left-rear corner of the glass or print-side up in the ADF.

For more information, see [Load an original on the scanner glass on page 27](#) or [Load an original in the document feeder on page 28](#).

2. Open the HP printer software. For more information, see [Open the HP printer software \(Windows\) on page 37](#).
3. In the HP printer software, select **Scan a Document or Photo** under **Print, Scan & Fax**.
4. Select the type of editable text:

I want to...	Follow these steps
Extract just the text, without any of the formatting of the original	Select the Save as Editable Text (OCR) shortcut from the list, and then select Text (.txt) from the File Type drop-down menu.

Extract the text, as well as some of the formatting of the original	Select the Save as Editable Text (OCR) shortcut from the list, and then select Rich Text (.rtf) from the File Type drop-down menu.
Extract the text and make it searchable in PDF readers	Select the Save as PDF shortcut from the list, and then select Searchable PDF (.pdf) from the File Type drop-down menu.

- Click **Scan** and follow the on-screen instructions.

To scan documents as editable text (OS X)

- Load your original print-side down in the left-rear corner of the glass or print-side up in the ADF.

For more information, see [Load an original on the scanner glass on page 27](#) or [Load an original in the document feeder on page 28](#).

- Open HP Scan.

HP Scan is located in the **Applications/Hewlett-Packard** folder at the top level of the hard disk.

- Select the type of editable text.

I want to...	Follow these steps
Extract just the text, without any of the formatting of the original	Select TXT from the Format pop-up menu.
Extract the text, as well as some of the formatting of the original	Select RTF from the Format pop-up menu.
Extract the text and make it searchable in PDF readers	Select Searchable PDF from the Format pop-up menu.

- Follow the on-screen instructions to complete the scan.

Guidelines for scanning documents as editable text

To ensure that the software can convert your documents successfully, do the following:

- Make sure the scanner glass or ADF window is clean.**

During a scan, smudges or dust on the scanner glass or ADF window might be scanned, as well, and can prevent the software from converting the document to editable text.

- Make sure the document is loaded correctly.**

When scanning documents as editable text from the ADF, the original must be loaded into the ADF with the top forward and print-side up. When scanning from the scanner glass, the original must be loaded with the top facing the left edge of the scanner glass.

Also, make sure the document is not skewed. For more information, see [Load an original on the scanner glass on page 27](#) or [Load an original in the document feeder on page 28](#).

- Make sure the text on the document is clear.**

To successfully convert the document to editable text, the original must be clear and of high quality.

The following conditions can hinder the process:

- The original is wrinkled.
- The structure of the document is too complex.
- The text is too faint or too small.

- The text is tightly spaced, or has missing or combined characters, "rn" might appear as "m."
- The text is on a colored background. Colored backgrounds can cause images in the foreground to blend too much.

- **Choose the correct type of editable text.**

Be sure to select a shortcut or preset that allows scanning as editable text. These options use scan settings designed to maximize the quality of your OCR scan.

(Windows) Use the **Editable Text (OCR)** or **Save as PDF** shortcuts.

(OS X) Use the **Documents** preset.

- **Save your file in the correct format.**

5 Fax

You can use the printer to send and receive faxes, including color faxes. You can schedule faxes to be sent at a later time and set up speed-dials to send faxes quickly and easily to frequently used numbers. From the printer control panel, you can also set a number of fax options, resolution, and the contrast between lightness and darkness on the faxes you send.

 **NOTE:** Before you begin faxing, make sure you have set up the printer correctly for faxing.

You can verify if the fax set up is correct by running the fax setup test from the printer control panel.

Learn more about fax setup and test, [click here to go online for more information](#).

- [Send a fax](#)
- [Receive a fax](#)
- [Set up speed-dial entries](#)
- [Change fax settings](#)
- [Fax and digital phone services](#)
- [Fax over Internet Protocol](#)
- [Fax reports](#)

Send a fax

You can send a fax in a variety of ways. Using the printer control panel, you can send a black-and-white or color fax. You can also send a fax manually from an attached phone. This allows you to speak with the recipient before sending the fax.

This section contains the following topics:

- [Send a standard fax](#)
- [Send a standard fax from the computer](#)
- [Send a fax manually from a phone](#)
- [Send a fax using monitor dialing](#)
- [Send a fax from memory](#)
- [Send a fax to multiple recipients](#)
- [Send a fax in Error Correction Mode](#)

Send a standard fax

You can easily send a single- or multiple-page black-and-white or color fax by using the printer control panel.

 **NOTE:** If you need printed confirmation that your faxes were successfully sent, fax confirmation must be enabled.

 **TIP:** You can also send a fax manually from a phone or by using monitor dialing. These features allow you to control the pace of your dialing. They are also useful when you want to use a calling card to charge the call and you have to respond to tone prompts while dialing.

To send a standard fax from the printer control panel

1. Load your original print-side down in the left-rear corner of the scanner glass or print-side up in the ADF.

For more information, see [Load an original on the scanner glass on page 27](#) or [Load an original in the document feeder on page 28](#).

 **NOTE:** If you are using the scanner glass, ensure that the automatic document feeder is empty. Otherwise, the printer will sense the document in the ADF instead of the paper on the scanner glass.

2. From the printer control panel display, touch **Fax**.
3. Enter the fax number by using the keypad.

 **TIP:** To add a pause in the fax number you are entering, touch * repeatedly, until a dash (-) appears on the display.

4. Touch **Black** or **Color**.

If the printer detects an original loaded in the automatic document feeder, it sends the document to the number you entered.

 **TIP:** If the recipient reports issues with the quality of the fax you sent, you can try changing the resolution or contrast of your fax.

Send a standard fax from the computer

You can send a document on your computer as a fax, without printing a copy and faxing it from the printer.

 **NOTE:** Faxes sent from your computer by this method use the printer fax connection, not your Internet connection or computer modem. Therefore, make sure the printer is connected to a working telephone line and that the fax function is set up and functioning correctly.

To use this feature, you must install the printer software using the installation program provided on the HP software CD provided with the printer.

To send a standard fax from the computer (Windows)

1. Open the document on your computer that you want to fax.
2. On the **File** menu in your software application, click **Print**.
3. From the **Name** list, select the printer that has “**fax**” in the name.
4. To change settings (such as selecting to send the document as a black fax or a color fax), click the button that opens the **Properties** dialog box. Depending on your software application, this button might be called **Properties**, **Options**, **Printer Setup**, **Printer**, or **Preferences**.
5. After you have changed any settings, click **OK**.
6. Click **Print** or **OK**.
7. Enter the fax number and other information for the recipient, change any further settings for the fax, and then click **Send Fax**. The printer begins dialing the fax number and faxing the document.

Send a standard fax from the computer (OS X)

1. Open the document on your computer that you want to fax.
2. From the **File** menu in your software, click **Print**.
3. Select the printer that has “**(Fax)**” in the name.
4. Select **Fax Recipients** from the pop-up menu below the **Orientation** setting.

 **NOTE:** If you cannot find the pop-up menu, try clicking the disclosure triangle next to the **Printer selection**.

5. Enter the fax number and other information in the boxes provided, and then click **Add to Recipients**.
6. Select the **Fax Mode** and any other fax options you want, and then click **Send Fax Now** to begin dialing the fax number and faxing the document.

Send a fax manually from a phone

Sending a fax manually allows you to make a phone call and talk with the recipient before you send the fax. This is useful if you want to inform the recipient that you are going to send them a fax before sending it. When you send a fax manually, you can hear the dial tones, telephone prompts, or other sounds through the handset on your telephone. This makes it easy for you to use a calling card to send your fax.

Depending on how the recipient has their fax machine set up, the recipient might answer the phone, or the fax machine might take the call. If a person answers the phone, you can speak with the

recipient before sending the fax. If a fax machine answers the call, you can send the fax directly to the fax machine when you hear the fax tones from the receiving fax machine.

To send a fax manually from an extension phone

1. Load your original print-side down in the left-rear corner of the scanner glass or print-side up in the ADF.

For more information, see [Load an original on the scanner glass on page 27](#) or [Load an original in the document feeder on page 28](#).

 **NOTE:** If you are using the scanner glass, ensure that the automatic document feeder is empty. Otherwise, the printer will sense the document in the ADF instead of the paper on the scanner glass.

2. From the printer control panel display, touch **Fax**.
3. Dial the number by using the keypad on the phone that is connected to the printer.

 **NOTE:** Do not use the keypad on the control panel of the printer when manually sending a fax. You must use the keypad on your phone to dial the recipient's number.

4. If the recipient answers the telephone, you can engage in a conversation before sending your fax.

 **NOTE:** If a fax machine answers the call, you will hear fax tones from the receiving fax machine. Proceed to the next step to transmit the fax.

5. When you are ready to send the fax, touch **Black** or **Color**.

 **NOTE:** If prompted, select **Send Fax**.

If you were on the phone with the recipient, ask the recipient to start receiving the fax when they hear fax tones on the fax machine.

The telephone line is silent while the fax is transmitting. At this point, you can hang up the telephone. If you want to continue speaking with the recipient, remain on the line until the fax transmission is complete.

Send a fax using monitor dialing

Monitor dialing allows you to dial a number from the printer control panel as you would dial a regular telephone. When you send a fax using monitor dialing, you can hear the dial tones, telephone prompts, or other sounds through the speakers on the printer. This enables you to respond to prompts while dialing, as well as control the pace of your dialing.

 **TIP:** If you are using a calling card and do not enter your PIN fast enough, the printer might start sending fax tones too soon and cause your PIN not to be recognized by the calling card service. If this is the case, you can create a speed dial entry to store the PIN for your calling card. For more information, see [Set up speed-dial entries on page 74](#).

 **NOTE:** Make sure the volume is turned on to hear a dial tone.



To send a fax using monitor dialing from the printer control panel

1. Load your original print-side down in the left-rear corner of the scanner glass or in the ADF.

For additional information, see [Load an original on the scanner glass on page 27](#) or [Load an original in the document feeder on page 28](#).

 **NOTE:** If you are using the scanner glass, ensure that the automatic document feeder is empty. Otherwise, the printer will sense the document in the ADF instead of the paper on the scanner glass.

2. From the printer control panel display, touch **Fax**.
3. Touch **Black** or **Color**.
 - If the printer detects an original loaded in the automatic document feeder, you hear a dial tone.
 - If the original is loaded on the scanner glass, select **Fax from scanner glass**.
4. When you hear the dial tone, enter the number by using the keypad on the printer control panel.
5. Follow any prompts that might occur.

 **TIP:** If you are using a calling card to send a fax and you have your calling card PIN stored as a speed dial, when prompted to enter your PIN, touch  (Speed dial) to select the speed dial entry where you have your PIN stored. For more information about creating speed-dial entries, see [Set up speed-dial entries on page 74](#).

Your fax is sent when the receiving fax machine answers.



Send a fax from memory

You can scan a black-and-white fax into memory and then send the fax from memory. This feature is useful if the fax number you are trying to reach is busy or temporarily unavailable. The printer scans the originals into memory and sends them once it is able to connect to the receiving fax machine. After the printer scans the pages into memory, you can immediately remove the originals from the document feeder tray or scanner glass.

 **NOTE:** You can only send a black-and-white fax from memory.

To send a fax from memory

1. Load your original print-side down in the ADF.

For additional information, see [Load an original in the document feeder on page 28](#).
2. From the printer control panel display, touch **Fax**.
3. Enter the fax number by using the keypad, touch  (Speed dial) to select a speed dial, or touch  (Call history) to select a previously dialed or received number.

For more information about creating speed-dial entries, see [Set up speed-dial entries on page 74](#).
4. Touch **Black** or **Color**.

The printer scans the originals into memory and sends the fax when the receiving fax machine is available.

Send a fax to multiple recipients



You can send a fax to multiple recipients at once by grouping individual speed dial entries into group speed dial entries.

To send a fax to multiple recipients using group speed dial

1. Load your original print-side down in the left-rear corner of the scanner glass or in the ADF.

For additional information, see [Load an original on the scanner glass on page 27](#) or [Load an original in the document feeder on page 28](#).

 **NOTE:** If you are using the scanner glass, ensure that the automatic document feeder is empty. Otherwise, the printer will sense the document in the ADF instead of the paper on the scanner glass.

2. From the printer control panel display, touch **Fax** and touch then  (Speed dial).
3. Touch  (**Setup**).
4. Touch **Group Speed Dial** and follow the on-screen instruction to create a recipient group.
5. Touch the recipient group from the **Select Speed Dial** screen.
6. Touch **Start Fax**.

If the printer detects an original loaded in the automatic document feeder, it sends the document to each number in the group speed dial entry.

 **NOTE:** You can only use group speed dial entries to send faxes in black and white, because of memory limitations. The printer scans the fax into memory then dials the first number. When a connection is made, it sends the fax and dials the next number. If a number is busy or not answering, the printer follows the settings for **Busy Redial** and **No Answer Redial**. If a connection cannot be made, the next number is dialed and an error report is generated.

For more information about change the redial options, see [Set the redial options on page 79](#).

Send a fax in Error Correction Mode

Error Correction Mode (ECM) prevents loss of data due to poor phone lines by detecting errors that occur during transmission and automatically requesting retransmission of the erroneous portion. Phone charges are unaffected, or might even be reduced, on good phone lines. On poor phone lines, ECM increases sending time and phone charges, but sends the data much more reliably. The default setting is **On**. Turn ECM off only if it increases phone charges substantially, and if you can accept poorer quality in exchange for reduced charges.

Before turning the ECM setting off, consider the following. If you turn ECM off:

- The quality and transmission speed of faxes you send and receive are affected.
- The **Fax Speed** is automatically set to **Medium**.
- You can no longer send or receive faxes in color.

To change the ECM setting from the control panel

1. From the printer control panel display, touch and slide your finger across the screen and then touch **Setup**.
2. Touch **Fax Setup**.
3. Touch **Advanced Fax Setup**.
4. Touch **Error Correction Mode** to turn on or off.
5. Select **On** or **Off**.

Receive a fax

You can receive faxes automatically or manually. If you turn off the **Auto Answer** option, you must receive faxes manually. If you turn on the **Auto Answer** option (the default setting), the printer automatically answers incoming calls and receives faxes after the number of rings that are specified by the **Rings to Answer** setting. (The default **Rings to Answer** setting is five rings.)

If you receive a Legal-size or larger fax and the printer is not currently set to use Legal-size paper, the printer reduces the fax so that it fits on the paper that is loaded. If you have disabled the **Automatic Reduction** feature, the printer prints the fax on two pages.

 **NOTE:** If you are copying a document when a fax arrives, the fax is stored in the printer memory until the copying finishes. This can reduce the number of fax pages stored in memory.

- [Receive a fax manually](#)
- [Set up backup fax](#)
- [Reprint received faxes from memory](#)
- [Forward faxes to another number](#)
- [Set the paper size for received faxes](#)
- [Set automatic reduction for incoming faxes](#)
- [Block unwanted fax numbers](#)
- [Receive faxes using HP Digital Fax](#)

Receive a fax manually

When you are on the phone, the person you are speaking with can send you a fax while you are still connected. This is referred to as manual faxing. Use the instructions in this section to receive a manual fax.

 **NOTE:** You can pick up the handset to talk or listen for fax tones.

You can receive faxes manually from a phone that is:

- Directly connected to the printer (on the 2-EXT port)
- On the same phone line, but not directly connected to the printer

To receive a fax manually

1. Make sure the printer is turned on and you have paper loaded in the main tray.
2. Remove any originals from the document feeder tray.
3. Set the **Rings to Answer** setting to a high number to allow you to answer the incoming call before the printer answers. Or, turn off the **Auto Answer** setting so that the printer does not automatically answer incoming calls.
4. If you are currently on the phone with the sender, instruct the sender to press **Start** on their fax machine.
5. When you hear fax tones from a sending fax machine, do the following:
 - a. From the printer control panel display, touch **Fax**, and then select **Black** or **Color**.
 - b. After the printer begins to receive the fax, you can hang up the phone or remain on the line. The phone line is silent during fax transmission.

Set up backup fax

Depending on your preference and security requirements, you can set up the printer to store all the faxes it receives, only the faxes it receives while the printer is in an error condition, or none of the faxes it receives.

To set backup fax from the printer control panel

1. From the printer control panel display, touch and slide your finger across the screen and then touch **Setup**.
2. Touch **Fax Setup**.
3. Touch **Advanced Fax Setup**.
4. Touch **Backup Fax Reception**.
5. Touch the required setting.

On	The default setting. When Backup fax is On , the printer stores all received faxes in memory. This enables you to reprint up to 30 of the most recently printed faxes if they are still saved in memory. NOTE: When printer memory is low, it overwrites the oldest, printed faxes as it receives new faxes. If the memory becomes full of unprinted faxes, the printer stops answering incoming fax calls. NOTE: If you receive a fax that is too large, such as a very detailed color photo, it might not be stored in memory due to memory limitations.
On Error Only	Causes the printer to store faxes in memory only if an error condition exists that prevents the printer from printing the faxes (for example, if the printer runs out of paper). The printer continues to store incoming faxes as long as there is memory available. (If the memory becomes full, the printer stops answering incoming fax calls.) When the error condition is resolved, the faxes stored in memory print automatically, and then they are deleted from memory.
Off	Faxes are never stored in memory. For example, you might want to turn off Backup fax for security purposes. If an error condition occurs that prevents the printer from printing (for example, the printer runs out of paper), the printer stops answering incoming fax calls.

Reprint received faxes from memory

The received faxes, which are not printed out, are stored in memory.

 **NOTE:** After the memory becomes full, the printer cannot receive the new fax until you print or delete the faxes from memory. You might also want to delete the faxes in memory for security or privacy purposes.

Depending on the sizes of the faxes in memory, you can reprint up to eight of the most recently printed faxes, if they are still in memory. For example, you might need to reprint your faxes if you lost the copy of your last printout.

To reprint faxes in memory from the printer control panel

1. Make sure you have paper loaded in the main tray. For more information, see [Load paper on page 23](#).
2. From the printer control panel display, touch and slide your finger across the screen and then touch **Setup**.
3. Touch **Fax Setup**.
4. Touch **Fax Tools**.

5. Touch **Reprint Faxes in Memory**.

The faxes are printed in the reverse order from which they were received with the most recently received fax printed first, and so on.

6. If you want to stop reprinting the faxes in memory, touch  (Cancel).

Forward faxes to another number

You can set up the printer to forward your faxes to another fax number. If fax forwarding function is enabled, your printer can receive and forward the black-and-white faxes only. A received color fax is forwarded in black and white.

HP recommends that you verify the number you are forwarding to is a working fax line. Send a test fax to make sure the fax machine is able to receive your forwarded faxes.

To forward faxes from the printer control panel

1. From the printer control panel display, touch and slide your finger across the screen and then touch **Setup**.
2. Touch **Fax Setup**.
3. Touch **Advanced Fax Setup**.
4. Touch **Fax Forwarding**.
5. Touch **On (Print and Forward)** to print and forward the fax, or select **On (Forward)** to forward the fax.

 **NOTE:** If the printer is not able to forward the fax to the designated fax machine (for example, if it is not turned on), the printer prints the fax. If you set up the printer to print error reports for received faxes, it also prints an error report.

6. At the prompt, enter the number of the fax machine intended to receive the forwarded faxes, and then touch **Done**. Enter the required information for each of the following prompts: start date, start time, end date, and end time.
7. Fax forwarding is activated. Touch **OK** to confirm.

If the printer loses power when fax forwarding is set up, it saves the fax forwarding setting and phone number. When the power is restored to the printer, the fax forwarding setting is still **On**.

 **NOTE:** You can cancel fax forwarding by selecting **Off** from the **Fax Forwarding** menu.

Set the paper size for received faxes

You can select the paper size for received faxes. The paper size you select should match what is loaded in your main tray. Faxes can be printed on Letter, A4, or Legal paper only.

 **NOTE:** If an incorrect paper size is loaded in the main tray when you receive a fax, the fax does not print and an error message appears on the display. Load Letter, A4, or Legal paper, and then touch **OK** to print the fax.

To set the paper size for received faxes from the printer control panel

1. From the printer control panel display, touch and slide your finger across the screen and then touch **Setup**.
2. Touch **Fax Setup**.

3. Touch **Basic Fax Setup**.
4. Touch **Fax Paper Size**, and then touch an option.

Set automatic reduction for incoming faxes

The **Automatic Reduction** setting determines what the printer does if it receives a fax that is too large for the default paper size. This setting is turned on by default, so the image of the incoming fax is reduced to fit on one page, if possible. If this feature is turned off, information that does not fit on the first page is printed on a second page. **Automatic Reduction** is useful when you receive a Legal-size fax and Letter-size paper is loaded in the main tray.

To set automatic reduction from the printer control panel

1. From the printer control panel display, touch and slide your finger across the screen and then touch **Setup**.
2. Touch **Fax Setup**.
3. Touch **Advanced Fax Setup**.
4. Touch **Automatic Reduction** to turn on or off.

Block unwanted fax numbers

If you subscribe to a caller ID service through your phone provider, you can block specific fax numbers so the printer does not print faxes received from those numbers. When an incoming fax call is received, the printer compares the number to the list of junk fax numbers to determine if the call should be blocked. If the number matches a number in the blocked fax numbers list, the fax is not printed. (The maximum number of fax numbers you can block varies by model.)

 **NOTE:** This feature is not supported in all countries/regions. If it is not supported in your country/region, **Junk Fax Blocker Setup** does not appear in the **Fax Options** or **Fax Settings** menu.

 **NOTE:** If no phone numbers are added in the Caller ID list, it is assumed that you are not subscribed to a Caller ID service.

- [Add numbers to the junk fax list](#)
- [Remove numbers from the junk fax list](#)
- [Print a Junk Fax Report](#)

Add numbers to the junk fax list

You can block specific numbers by adding them to the junk fax list.

To add a number to the junk fax list

1. From the printer control panel display, touch and slide your finger across the screen and then touch **Setup**.
2. Touch **Fax Setup**.
3. Touch **Basic Fax Setup**.
4. Touch **Junk Fax Blocker Setup**.
5. A message appears stating that Caller ID is required to block junk faxes. Touch **OK** to continue.
6. Touch **Add Numbers**.

7. To select a fax number to block from the caller ID list, touch **Select from Caller ID History**.

- or -

To manually enter a fax number to block, touch **Enter new number**.

8. After entering a fax number to block, touch **Done**, and then touch **OK**.

 **NOTE:** Make sure you enter the fax number as it appears on the control panel display, and not the fax number that appears on the fax header of the received fax, as these numbers can be different.

Remove numbers from the junk fax list

If you no longer want to block a fax number, you can remove a number from your junk fax list.

To remove numbers from the list of junk fax numbers

1. From the printer control panel display, touch and slide your finger across the screen and then touch **Setup**.
2. Touch **Fax Setup**.
3. Touch **Basic Fax Setup**.
4. Touch **Junk Fax Blocker Setup**.
5. Touch **Remove Numbers**.
6. Touch the number you want to remove, and then touch **OK**.

Print a Junk Fax Report

Use the following procedure to print a list of blocked junk fax numbers.

To print a Junk Fax Report

1. From the printer control panel display, touch and slide your finger across the screen and then touch **Setup**.
2. Touch **Settings** and touch **Fax Setup**.
3. Touch **Basic Fax Setup**.
4. Touch **Junk Fax Blocker Setup**.
5. Touch **Print Reports**, and then touch **Junk Fax List**.

Receive faxes using HP Digital Fax

If the printer is connected to your computer with an Ethernet cable, wireless connection, or USB cable, you can use HP Digital Fax to automatically receive faxes and save faxes directly to your E-mail box or your network folder that you specify. With HP digital Fax, you can store digital copies of your faxes easily and also eliminate the hassle of dealing with bulky paper files.

Received faxes are saved as TIFF (Tagged Image File Format).

The files are named in the following method: XXXX_YYYYYYY_ZZZZZZ.tif, where X is the sender's information, Y is the date, and Z is the time that the fax was received.

 **NOTE:** HP digital Fax is available for receiving black-and-white faxes only. Color faxes will be printed.

- [HP Digital Fax requirements](#)
- [Activate HP Digital Fax](#)
- [Modify HP Digital Fax settings](#)

HP Digital Fax requirements

- The destination folder of the computer or server must be on at all times. The destination computer must also be awake, faxes will not be saved if the computer is asleep or in hibernate mode.
- Paper must be loaded in the input tray. For more information, see [Load paper on page 23](#).

Activate HP Digital Fax

To set up HP Digital Fax (Windows)

1. Open the HP printer software. For more information, see [Open the HP printer software \(Windows\) on page 37](#).
2. In the HP printer software, click **Digital Fax Setup Wizard** under **Print, Scan & Fax**.
3. Follow the on-screen instructions.

To set up HP Digital Fax (OS X)

1. Open HP Utility. For more information, see [HP Utility \(OS X\) on page 117](#).
2. Select the printer.
3. Click **Digital Fax Archive** in the Fax Settings section.

Modify HP Digital Fax settings

You can turn off HP Digital Fax and disable printing faxes from the printer control panel.

To modify settings from the printer control panel

1. From the printer control panel display, touch and slide your finger across the screen and then touch **Setup**.
2. Touch **Fax Setup**.
3. Touch **Basic Fax Setup**, and then touch **HP Digital Fax**.
4. Select the setting that you want to change. You can change the following settings:
 - **Fax Print:** Choose this option to print faxes as they are received. If you turn off printing, color faxes will still print.
 - **Disable HP Digital Fax:** Turn off HP Digital Fax.



NOTE: Use the HP printer software on your computer to turn on HP Digital Fax.

To modify settings from the HP printer software (Windows)

1. Open the HP printer software. For more information, see [Open the HP printer software \(Windows\) on page 37](#).
2. In the HP printer software, click **Digital Fax Setup Wizard** under **Print, Scan & Fax**.
3. Follow the on-screen instructions.

To modify settings from the HP printer software (OS X)

1. Open HP Utility. For more information, see [HP Utility \(OS X\) on page 117](#).
2. Select the printer.
3. Click **Digital Fax Archive** in the Fax Settings section.

Turn off HP Digital Fax

1. From the printer control panel display, touch and slide your finger across the screen and then touch **Setup**.
2. Touch **Fax Setup**.
3. Touch **Basic Fax Setup** and then touch **HP Digital Fax**.
4. Touch **Disable HP Digital Fax**.
5. Touch **Yes**.

Set up speed-dial entries

You can set up frequently used fax numbers as speed-dial entries. This lets you dial those numbers quickly by using the printer control panel.

 **TIP:** In addition to creating and managing speed-dial entries from the printer control panel, you can also use tools available on your computer, such as the HP software included with the printer and the printer EWS. For more information, see [Printer management tools on page 115](#).

- [Set up and change speed-dial entries](#)
- [Set up and change group speed-dial entries](#)
- [Delete speed-dial entries](#)
- [Print a list of speed-dial entries](#)

Set up and change speed-dial entries

You can store fax numbers as speed-dial entries.

To set up speed-dial entries

1. From the printer control panel display, touch and slide your finger across the screen and then touch **Setup**.
2. Touch **Fax Setup**.
3. Touch **Speed Dial Setup**.
4. Touch **Add/Edit Speed Dial**, and then touch an unused entry number.
5. Type the fax number, and then touch **Next**.

 **NOTE:** Be sure to include any pauses or other required numbers, such as an area code, an access code for numbers outside a PBX system (usually a 9 or 0), or a long-distance prefix.

6. Type the name for the speed-dial entry, and then touch **Done**.
7. Touch **OK**.

To change speed-dial entries

1. From the printer control panel display, touch and slide your finger across the screen and then touch **Setup**.
2. Touch **Fax Setup**.
3. Touch **Speed Dial Setup**.
4. Touch **Add/Edit Speed Dial**, and then touch the speed-dial entry you want to change.
5. If you want to change the fax number, type the new number, and then touch **Next**.

 **NOTE:** Be sure to include any pauses or other required numbers, such as an area code, an access code for numbers outside a PBX system (usually a 9 or 0), or a long-distance prefix.

6. Type the name for the speed-dial entry, and then touch **Done**.
7. Touch **OK**.

Set up and change group speed-dial entries

You can store groups of fax numbers as group speed-dial entries.

To set up group speed-dial entries

 **NOTE:** Before you can create a group speed-dial entry, you must have already created at least one speed-dial entry.

1. From the printer control panel display, touch and slide your finger across the screen and then touch **Setup**.
2. Touch **Fax Setup**.
3. Touch **Speed Dial Setup**.
4. Touch **Group Speed Dial**, and then touch an unused entry number.
5. Touch the speed-dial entries you want to include in the group speed-dial entry, and then touch **OK**.
6. Type the name for the speed-dial entry, and then touch **Done**.

To change group speed-dial entries

1. From the printer control panel display, touch and slide your finger across the screen and then touch **Setup**.
2. Touch **Fax Setup**, and then select **Speed Dial Setup**.
3. Select **Group Speed Dial**, and then touch the entry you want to change.
4. If you want to add or change speed-dial entries from the group, touch the speed-dial entries you want to include or those you want to change, and then touch **OK**.
5. If you want to change the name of the group speed-dial, type the new name, and then touch **Done**.

To change speed-dial entries

1. From the printer control panel display, touch and slide your finger across the screen and then touch **Setup**.
2. Touch **Fax Setup**.
3. Touch **Speed Dial Setup**.
4. Touch **Add/Edit Speed Dial**, and then touch the speed-dial entry you want to change.
5. If you want to change the fax number, type the new number, and then touch **Next**.

 **NOTE:** Be sure to include any pauses or other required numbers, such as an area code, an access code for numbers outside a PBX system (usually a 9 or 0), or a long-distance prefix.

6. Type the name for the speed-dial entry, and then touch **Done**.
7. Touch **OK**.

Delete speed-dial entries

To delete speed-dial entries or group speed-dial entries, complete the following steps:

1. From the printer control panel display, touch and slide your finger across the screen and then touch **Setup**.
2. Touch **Fax Setup**, and then touch **Speed Dial Setup**.
3. Touch **Delete Speed Dial**, touch the entry you want to delete, touch **Delete**, and then touch **Yes** to confirm.



NOTE: Deleting a group speed-dial entry does not delete the individual speed-dial entries.

Print a list of speed-dial entries

To print a list of all of the speed-dial entries that have been set up, complete the following steps:

1. Load paper in the tray. For more information, see [Load paper on page 23](#).
2. From the printer control panel, touch **Setup**.
3. Touch **Fax Setup**, and then touch **Speed Dial Setup**.
4. Touch **Print Speed Dial List**.

Change fax settings

After completing the steps in the getting started guide that came with the printer, use the following steps to change the initial settings or to configure other options for faxing.

- [Configure the fax header](#)
- [Set the answer mode \(Auto answer\)](#)
- [Set the number of rings before answering](#)
- [Change the answer ring pattern for distinctive ring](#)
- [Set the dial type](#)
- [Set the redial options](#)
- [Set the fax speed](#)
- [Set the fax sound volume](#)

Configure the fax header

The fax header prints your name and fax number on the top of every fax you send. HP recommends that you set up the fax header by using the HP printer software provided with the printer. You can also set up the fax header from the printer control panel, as described here.



NOTE: In some countries/regions, the fax header information is a legal requirement.

To set or change the fax header

1. From the printer control panel display, touch and slide your finger across the screen and then touch **Setup**.
2. Touch **Fax Setup**, and then touch **Basic Fax Setup**.
3. Touch **Fax Header**.
4. Enter your personal or company name, and then touch **Done**.
5. Enter your fax number, and then touch **Done**.

Set the answer mode (Auto answer)

The answer mode determines whether the printer answers incoming calls.

- Turn on the **Auto Answer** setting if you want the printer to answer faxes **automatically**. The printer answers all incoming calls and faxes.
- Turn off the **Auto Answer** setting if you want to receive faxes **manually**. You must be available to respond in person to the incoming fax call or else the printer does not receive faxes.

To set the answer mode

1. From the printer control panel display, touch and slide your finger across the screen and then touch **Setup**.
2. Touch **Fax Setup**, and then touch **Basic Fax Setup**.
3. Touch **Auto Answer** to turn it on or off.

Set the number of rings before answering

If you turn on the **Auto Answer** setting, you can specify how many rings occur before incoming calls are automatically answered.

The **Rings to Answer** setting is important if you have an answering machine on the same phone line as the printer, because you want the answering machine to answer the phone before the printer does. The number of rings to answer for the printer should be greater than the number of rings to answer for the answering machine.

For example, set your answering machine to a low number of rings and the printer to answer in the maximum number of rings. (The maximum number of rings varies by country/region.) In this setup, the answering machine answers the call and the printer monitors the line. If the printer detects fax tones, it receives the fax. If the call is a voice call, the answering machine records the incoming message.

To set the number of rings before answering

1. From the printer control panel display, touch and slide your finger across the screen and then touch **Setup**.
2. Touch **Fax Setup**, and then touch **Basic Fax Setup**.
3. Touch **Rings to Answer**.
4. Touch the number of rings.
5. Touch **Done** to accept the setting.

Change the answer ring pattern for distinctive ring

Many phone companies offer a distinctive ring feature that allows you to have several phone numbers on one phone line. When you subscribe to this service, each number is assigned a different ring pattern. You can set up the printer to answer incoming calls that have a specific ring pattern.

If you connect the printer to a line with distinctive ring, have your telephone company assign one ring pattern to voice calls and another ring pattern to fax calls. HP recommends that you request double or triple rings for a fax number. When the printer detects the specified ring pattern, it answers the call and receives the fax.

 **TIP:** You can also use the Ring Pattern Detection feature in the printer control panel to set distinctive ring. With this feature, the printer recognizes and records the ring pattern of an incoming call and, based on this call, automatically determines the distinctive ring pattern assigned by your telephone company to fax calls.

If you do not have a distinctive ring service, use the default ring pattern, which is **All Rings**.

 **NOTE:** The printer cannot receive faxes when the main phone number is off the hook.

To change the answer ring pattern for distinctive ring

1. Verify that the printer is set to answer fax calls automatically.
2. From the printer control panel display, touch and slide your finger across the screen and then touch **Setup**.
3. Touch **Fax Setup**, and then select **Advanced Fax Setup**.
4. Touch **Distinctive Ring**.

5. A message appears stating that this setting should not be changed unless you have multiple numbers on the same telephone line. Touch **Yes** to continue.
6. Do one of the following:
 - Touch the ring pattern assigned by your telephone company to fax calls.
 - Or -
 - Touch **Ring Pattern Detection**, and then follow the instructions on the printer control panel.

 **NOTE:** If the Ring Pattern Detection feature cannot detect the ring pattern or if you cancel the feature before it finishes, the ring pattern is automatically set to the default, which is **All Rings**.

 **NOTE:** If you are using a PBX phone system that has different ring patterns for internal and external calls, you must call the fax number from an external number.

Set the dial type

Use this procedure to set tone-dialing or pulse-dialing mode. The factory-set default is **Tone**. Do not change the setting unless you know that your phone line cannot use tone dialing.

 **NOTE:** The pulse-dialing option is not available in all countries/regions.

To set the dial type

1. From the printer control panel display, touch and slide your finger across the screen and then touch **Setup**.
2. Touch **Fax Setup**, and then touch **Basic Fax Setup**.
3. Touch **Dial Type**.
4. Touch to select **Tone Dialing** or **Pulse Dialing**.

Set the redial options

If the printer was unable to send a fax because the receiving fax machine did not answer or was busy, the printer attempts to redial based on the settings for the busy-redial and no-answer-redial options. Use the following procedure to turn the options on or off.

- **Busy redial:** If this option is turned on, the printer redials automatically if it receives a busy signal. The factory-set default for this option is **On**.
- **No answer redial:** If this option is turned on, the printer redials automatically if the receiving fax machine does not answer. The factory-set default for this option is **Off**.

To set the redial options

1. From the printer control panel display, touch and slide your finger across the screen and then touch **Setup**.
2. Touch **Fax Setup**, and then touch **Advanced Fax Setup**.
3. Touch **Busy Redial** or **No Answer Redial**, and then select the appropriate options.

Set the fax speed

You can set the fax speed used to communicate between your printer and other fax machines when sending and receiving faxes.

If you use one of the following, setting the fax speed to a slower speed might be required:

- An Internet phone service
- A PBX system
- Fax over Internet Protocol (FoIP)
- An integrated services digital network (ISDN) service

If you experience problems sending and receiving faxes, try using a lower **Fax Speed**. The following table provides the available fax speed settings.

Fax speed setting	Fax speed
Fast	v.34 (33600 baud)
Medium	v.17 (14400 baud)
Slow	v.29 (9600 baud)

To set the fax speed

1. From the printer control panel display, touch and slide your finger across the screen and then touch **Setup**.
2. Touch **Fax Setup**, and then touch **Advanced Fax Setup**.
3. Touch **Fax Speed**.
4. Touch to select an option.

Set the fax sound volume

Use this procedure to increase or decrease the volume of the fax sounds.

To set the fax sound volume

1. From the printer control panel display, touch and slide your finger across the screen and then touch **Setup**.
2. Touch **Fax Setup**, and then touch **Basic Fax Setup**.
3. Touch **Fax Sound Volume**.
4. Touch to select **Soft**, **Loud**, or **Off**.

Fax and digital phone services

Many telephone companies provide their customers with digital phone services, such as the following:

- DSL: A Digital subscriber line (DSL) service through your telephone company. (DSL might be called ADSL in your country/region.)
- PBX: A private branch exchange (PBX) phone system.
- ISDN: An integrated services digital network (ISDN) system.
- FoIP: A low-cost phone service that allows you to send and receive faxes with your printer by using the Internet. This method is called Fax over Internet Protocol (FoIP).

For more information, see [Fax over Internet Protocol on page 82](#).

HP printers are designed specifically for use with traditional analog phone services. If you are in a digital phone environment (such as DSL/ADSL, PBX, or ISDN), you might need to use digital-to-analog filters or converters when setting up the printer for faxing.



NOTE: HP does not guarantee that the printer will be compatible with all digital service lines or providers, in all digital environments, or with all digital-to-analog converters. It is always recommended that you discuss with the telephone company directly for the correct setup options based on their line services provided.

Fax over Internet Protocol

You might be able to subscribe to a low cost phone service that allows you to send and receive faxes with your printer by using the Internet. This method is called Fax over Internet Protocol (FoIP).

You probably use a FoIP service (provided by your telephone company) when you:

- Dial a special access code along with the fax number.
- Have an IP converter box that connects to the Internet and provides analog phone ports for the fax connection.



NOTE: You can only send and receive faxes by connecting a phone cord to the port labeled "1-LINE" on the printer. This means that your connection to the Internet must be done either through a converter box (which supplies regular analog phone jacks for fax connections) or your telephone company.



TIP: Support for traditional fax transmission over any Internet protocol telephone systems are often limited. If you experience problems faxing, try using a slower fax speed or disabling the fax error-correction mode (ECM). However, if you turn off ECM, you cannot send and receive color faxes.

For more information about changing the fax speed, see [Set the fax speed on page 79](#). For more information about using ECM, see [Send a fax in Error Correction Mode on page 66](#).

If you have questions about Internet faxing, contact your Internet faxing services support department or your local service provider for further assistance.

Fax reports

You can set up the printer to print error reports and confirmation reports automatically for each fax you send and receive. You can also manually print system reports as required; these reports provide useful system information about the printer.

By default, the printer is set to print a report only if there is a problem sending or receiving a fax. A confirmation message that indicates whether a fax was successfully sent appears briefly on the control panel display after each transaction.

 **NOTE:** If the reports are not legible, you can check the estimated ink levels from the control panel or the HP software. For more information, see [Check the estimated ink levels on page 97](#).

- [Print fax confirmation reports](#)
- [Print fax error reports](#)
- [Print and view the fax log](#)
- [Clear the fax log](#)
- [Print the details of the last fax transaction](#)
- [Print a Caller ID Report](#)
- [View the Call History](#)

Print fax confirmation reports

If you require printed confirmation that your faxes were successfully sent, follow these instructions to enable fax confirmation **before** sending any faxes. Select either **On (Fax Send)** or **On (Send and Receive)**.

The default fax confirmation setting is **Off**. This means that a confirmation report is not printed for each fax sent or received. A confirmation message indicating whether a fax was successfully sent appears briefly on the control panel display after each transaction.

 **NOTE:** You can include an image of the first page of the fax on the Fax Sent Confirmation report if you select **On (Fax Send)** or **On (Send and Receive)**, and if you scan the fax to send from memory or use the **Scan and Fax** option.

To enable fax confirmation

1. From the printer control panel display, touch and slide your finger across the screen and then touch **Setup**.
2. Touch **Fax Setup**.
3. Touch **Advanced Fax Setup** and touch **Fax Confirmation**.
4. Touch to select one of the following options.

Off	Does not print a fax confirmation report when you send and receive faxes successfully. This is the default setting.
On (Fax Send)	Prints a fax confirmation report for every fax you send.
On (Fax Receive)	Prints a fax confirmation report for every fax you receive.
On (Send and Receive)	Prints a fax confirmation report for every fax you send and receive.

To include an image of the fax on the report

1. From the printer control panel display, touch and slide your finger across the screen and then touch **Setup**.
2. Touch **Fax Setup**.
3. Touch **Advanced Fax Setup** and touch **Fax Confirmation**.
4. Touch **On (Fax Send)** or **On (Send and Receive)**.
5. Touch **Fax Confirmation with image**.

Print fax error reports

You can configure the printer so that it automatically prints a report when there is an error during transmission or reception.

To set the printer to print fax error reports automatically

1. From the printer control panel display, touch and slide your finger across the screen and then touch **Setup**.
2. Touch **Fax Setup**.
3. Touch **Advanced Fax Setup** and touch **Fax Error Report**.
4. Touch to select one of the following.

On (Send and Receive)	Prints whenever a fax error occurs.
Off	Does not print any fax error reports.
On (Fax Send)	Prints whenever a transmission error occurs. This is the default setting.
On (Fax Receive)	Prints whenever a receiving error occurs.

Print and view the fax log

You can print a log of faxes that have been received and sent by the printer.

To print the fax log from the printer control panel

1. From the printer control panel display, touch and slide your finger across the screen and then touch **Setup**.
2. Touch **Fax Setup**, and then touch **Fax Reports**.
3. Touch **Fax Log**.

Clear the fax log

Use the following steps to clear the fax log.



NOTE: Clearing the fax log also deletes all faxes stored in memory.

To clear the fax log

1. From the printer control panel display, touch and slide your finger across the screen and then touch **Setup**.
2. Touch **Fax Setup**, and then touch **Fax Tools**.
3. Touch **Clear Fax Log**.

Print the details of the last fax transaction

The Last Fax Transaction report prints the details of the last fax transaction to occur. Details include the fax number, number of pages, and the fax status.

To print the Last Fax Transaction report

1. From the printer control panel display, touch and slide your finger across the screen and then touch **Setup**.
2. Touch **Fax Setup**, and then touch **Fax Reports**.
3. Touch **Last Transaction**.

Print a Caller ID Report

Use the following procedure to print a list of Caller ID fax numbers.

To print a Caller ID History Report

1. From the printer control panel display, touch and slide your finger across the screen and then touch **Setup**.
2. Touch **Fax Setup**, and then touch **Fax Reports**.
3. Touch **Caller ID Report**.

View the Call History

Use the following procedure to view a list of all the calls placed from the printer.

 **NOTE:** The call history cannot be printed. You can only view it from the printer control panel display.

To view the Call History

1. From the printer control panel display, touch **Fax**.
2. Touch  (Call history).

6 Web Services

The printer offers innovative, web-enabled solutions that can help you quickly access the Internet, obtain documents, and print them faster and with less hassle—and all without using a computer.

 **NOTE:** To use these web features, the printer must be connected to the Internet (either using an Ethernet cable or wireless connection). You cannot use these web features if the printer is connected using a USB cable.

This section contains the following topics:

- [What are Web Services?](#)
- [Set up Web Services](#)
- [Use Web Services](#)
- [Remove Web Services](#)

What are Web Services?

The printer includes the following Web Services:

- [HP ePrint](#)
- [Print apps](#)

HP ePrint

HP ePrint is a free service from HP that allows you to print to your HP ePrint-enabled printer anytime, from any location. It's as simple as sending an email to the email address assigned to your printer when you enable Web Services on the printer. No special drivers or software are needed. If you can send an email, you can print from anywhere, using HP ePrint.

Once you have signed up for an account on HP Connected (www.hpconnected.com), you can sign in to view your HP ePrint job status, manage your HP ePrint printer queue, control who can use your printer's HP ePrint email address to print, and get help for HP ePrint.

Print apps

Print apps allow you to easily locate and print preformatted web content, directly from your printer. You can also scan and store your documents digitally on the Web.

Print apps provide a wide range of content, from store coupons to family activities, news, travel, sports, cooking, photos, and many more. You can even view and print your online images from popular photo sites

Certain print apps also allow you to schedule the delivery of app content to your printer.

Pre-formatted content designed specifically for your printer means no cut-off text and pictures and no extra pages with only one line of text. On some printers, you can also choose paper and print quality settings on the print preview screen.

All without even having to turn on your computer!

Set up Web Services

To set up Web Services, use one of the following methods.



 **NOTE:** Before you set up Web Services, make sure your printer is connected to the Internet using either an Ethernet or wireless connection.

- [Set up Web Services using the printer control panel](#)
- [Set up Web Services using the embedded web server](#)
- [Set up Web Services using the HP printer software](#)

Set up Web Services using the printer control panel

The printer control panel provides an easy way to set up and manage Web Services.

To set up Web Services, complete the following steps:

1. Make sure the printer is connected to the Internet using either an Ethernet or wireless connection.
2. From the printer control panel, touch  (print apps) or  (HP ePrint).
3. Touch **Yes** to accept the Web Services terms of use and enable Web Services.
4. In the **Auto Update** screen, touch **Yes** to allow the printer to automatically check for and install product updates.

 **NOTE:** If a printer update is available, the printer will download and install the update, and then restart. You will have to repeat the instructions from step 1 to set up HP ePrint.

 **NOTE:** If prompted for proxy settings and if your network uses proxy settings, follow the on-screen instructions to set up a proxy server. If you do not have the proxy details, contact your network administrator or the person who set up the network.

5. When the printer is connected to the server, the printer prints an information page. Follow the instructions on the information page to finish the setup.

Set up Web Services using the embedded web server

You can use the printer's embedded web server (EWS) to set up and manage Web Services.

To set up Web Services, complete the following steps:

1. Open the EWS. For more information, see [Embedded web server on page 118](#).
2. Click the **Web Services** tab.
3. In the **Web Services Settings** section, click **Setup**, click **Continue**, and follow the on-screen instructions to accept the terms of use.
4. If prompted, choose to allow the printer to check for and install printer updates.

 **NOTE:** If a printer update is available, the printer downloads and installs the update, and then restarts. Repeat the instructions from step 1 to set up HP ePrint.

 **NOTE:** If prompted for proxy settings and if your network uses proxy settings, follow the on-screen instructions to set up a proxy server. If you do not have the proxy details, contact your network administrator or the person who set up the network.

5. When the printer is connected to the server, the printer prints an information page. Follow the instructions on the information page to finish the setup.

Set up Web Services using the HP printer software

If you did not set up Web Services when you installed the HP software on your computer, you can still use the software to set up Web Services.

To set up Web Services (Windows)

1. Open the HP printer software. For more information, see [Open the HP printer software \(Windows\) on page 37](#).
2. In the HP printer software, select **ePrint Setup** under **Print, Scan & Fax**. The printer EWS opens.
3. Click the **Web Services** tab.
4. In the **Web Services Settings** section, click **Setup**, click **Continue**, and follow the on-screen instructions to accept the terms of use.
5. If prompted, choose to allow the printer to check for and install printer updates.

 **NOTE:** If a printer update is available, the printer will download and install the update, and then restart. You will have to repeat the instructions from step 1 to set up HP ePrint.

6. If your network uses proxy settings when connecting to the Internet, enter these settings:
 - a. Touch **Enter Proxy**.
 - b. Enter the proxy server settings, and then touch **Done**.
7. When the printer is connected to the server, the printer prints an information page. Follow the instructions on the information page to finish the setup.

To set up Web Services (OS X)

- ▲ To set up and manage Web Services, you can use the printer's embedded web server (EWS). For more information, see [Set up Web Services using the embedded web server on page 89](#).

Use Web Services

The following section describes how to use and configure Web Services.

- [HP ePrint](#)
- [Print apps](#)

HP ePrint

HP ePrint allows you to print to your HP ePrint-enabled printer anytime, from any location.

To use HP ePrint, make sure to have the following:

- An Internet- and email-capable computer or mobile device
- An HP ePrint-capable printer on which Web Services has been enabled

 **TIP:** For more information about managing and configuring HP ePrint settings and to learn about the latest features, visit HP Connected at www.hpconnected.com.

Print using HP ePrint

To print documents using HP ePrint, complete the following steps:

1. Enable Web Services.
 - a. From the printer control panel display, touch  (HP ePrint).
 - b. Accept the Terms of Use, and then follow the on-screen instructions to enable Web Services.
 - c. Print the ePrint information page, and then follow the instructions on the page to sign up for an HP ePrint account.
2. On your computer or mobile device, open your email application.

 **NOTE:** For information about using the email application on your computer or mobile device, see the documentation provided with the application.

3. Create a new email message, and then attach the file that you want to print.
4. Enter the printer's email address in the "To" line of the email message, and then select the option to send the email message.

 **NOTE:** The HP ePrint server does not accept email print jobs if there are multiple email addresses included in the "To" or "Cc" fields. Only enter the email address of your HP printer in the "To" field. Do not enter any additional email addresses in the other fields.

Find the printer's email address

 **NOTE:** Make sure you have created an ePrint account.

To sign up for an account on HP Connected, visit HP Connected at www.hpconnected.com.

- ▲ From the printer control panel display, touch  (HP ePrint).

To customize the email address, touch **Print Info**. The printer prints an information page that contains the printer code and instructions on how to customize the email address.

Turn off HP ePrint

1. From the printer control panel, touch  (HP ePrint), and then touch **Settings**.
2. Touch **ePrint**, and then touch **Off**.

 **NOTE:** To remove all Web Services, see [Remove Web Services on page 93](#).

Print apps

Print apps allow you to easily locate and print pre-formatted web content, directly from your printer.

- [Use print apps](#)
- [Manage print apps](#)
- [Turn off print apps](#)

Use print apps

To use the print apps on your printer, touch  (print apps) on the printer control panel display, and then touch the print app you want to use.

For more information about individual print apps, visit www.hpconnected.com.

Manage print apps

You can manage your print apps with HP Connected. You can add, configure, or remove print app, and set the order in which they appear on your printer control panel display.

 **NOTE:** To manage print app from HP Connected, create an account on HP Connected and add your printer. For more information, visit www.hpconnected.com.

Turn off print apps

To turn off print apps, complete the following steps:

1. From the printer control panel, touch  (HP ePrint), and then touch **Settings**.
2. Touch **Apps**, and then touch **Off**.

 **NOTE:** To remove all Web Services, see [Remove Web Services on page 93](#).

Remove Web Services

To remove Web Services, complete the following steps:

1. From the printer control panel display, touch  (HP ePrint), and then touch **Settings**.
2. Touch **Remove Web Services**.

 **NOTE:** You can also remove Web Services from EWS. To access EWS, see [Open the embedded web server on page 118](#).

7 Work with ink cartridges

To ensure the best print quality from the printer, you need to perform some simple maintenance procedures.

 **TIP:** If you have problems copying documents, see [Solve printing problems on page 131](#).

This section contains the following topics:

- [Information on ink cartridges and the printhead](#)
- [Check the estimated ink levels](#)
- [Printing with black or color ink only](#)
- [Replace the ink cartridges](#)
- [Order ink cartridges](#)
- [Store printing supplies](#)
- [Anonymous usage information storage](#)

Information on ink cartridges and the printhead

The following tips help maintain HP ink cartridges and ensure consistent print quality.

- The instructions in this user guide are for replacing ink cartridges, and are not intended for first time installation.
- Keep all ink cartridges in the original sealed packages until they are needed.
- Be sure to turn off the printer properly. For more information, see [Turn the printer off on page 38](#).
- Store ink cartridges at room temperature (15-35° C or 59-95° F).
- Do not clean the printhead unnecessarily. This wastes ink and shortens the life of the cartridges.
- Handle ink cartridges carefully. Dropping, jarring, or rough handling during installation can cause temporary printing problems.
- If you are transporting the printer, do the following to prevent ink leaking from the printer or other damage from occurring to the printer:
 - Make sure you turn off the printer by pressing  (the Power button). Wait until all sounds of internal motion stop before unplugging the printer. For more information, see [Turn the printer off on page 38](#).
 - Make sure you leave the ink cartridges installed.
 - The printer must be transported sitting flat; it should not be placed on its side, back, front, or top.

⚠ CAUTION: HP recommends that you replace any missing cartridges as soon as possible to avoid print quality issues and possible extra ink usage or damage to the ink system. Never turn off the printer when ink cartridges are missing.

Related topics

- [Check the estimated ink levels on page 97](#)

Check the estimated ink levels

You can check the estimated ink levels from the printer software or from the printer control panel. For information about using these tools, see [Printer management tools on page 115](#) and [Use the printer control panel on page 9](#). You can also print the Printer Status page to view this information (see [Printer status report on page 125](#)).

To check the estimated ink levels from the printer control panel

1. From the printer control panel display, touch and slide your finger across the screen and then touch **Setup**.
2. Touch **Tools**, and then touch **Display Estimated Ink Levels**.

 **NOTE:** Ink level alerts and indicators provide estimates for planning purposes only. When you receive a low-ink alert, consider having a replacement cartridge available to avoid possible printing delays. You do not have to replace the cartridges until prompted to do so.

 **NOTE:** If you have installed a refilled or remanufactured cartridge, or a cartridge that has been used in another printer, the ink level indicator might be inaccurate or unavailable.

 **NOTE:** Ink from the cartridges is used in the printing process in a number of different ways, including in the initialization process, which prepares the printer and cartridges for printing, and in printhead servicing, which keeps print nozzles clear and ink flowing smoothly. In addition, some residual ink is left in the cartridge after it is used. For more information, see www.hp.com/go/inkusage.

Printing with black or color ink only

For regular usage, this product is not designed to print using only the black cartridge when the color cartridges are out of ink.

However, your printer is designed to let you print as long as possible when your cartridges start to run out of ink.

When there is sufficient ink in the printhead, the printer will offer you the use of black ink only when one or more of the color cartridges are out of ink, and the use of color ink only when the black cartridge is out of ink.

- The amount that you can print using black or color ink only is limited, so have replacement ink cartridges available when you are printing with black or color ink only.
- When there is no longer sufficient ink to print you will get a message that one or more cartridges are depleted, and you will need to replace the depleted cartridges before you resume printing.

⚠ CAUTION: While ink cartridges are not damaged when left outside of the printer, the printhead does need to have all cartridges installed at all times after the printer is set up and in use. Leaving one or more cartridge slots empty for an extended period may lead to print quality problems and possibly damage the printhead. If you have recently left a cartridge out of the printer for an extended period, or if you have had a recent paper jam, and have noticed poor print quality, clean the printhead. For more information, see [Clean the printhead on page 155](#).

Replace the ink cartridges

 **NOTE:** For information on recycling used ink supplies, see [HP inkjet supplies recycling program](#) on page 178.

If you do not already have replacement ink cartridges for the printer, see [Order ink cartridges](#) on page 101.

 **NOTE:** At this time, some portions of the HP web site are available in English only.

 **NOTE:** Not all cartridges are available in all countries/regions.

 **CAUTION:** HP recommends that you replace any missing cartridges as soon as possible to avoid print quality issues and possible extra ink usage or damage to the ink system. Never turn off the printer when ink cartridges are missing.

To replace the ink cartridges

Use these steps to replace the ink cartridges.

1. Make sure the printer is turned on.
2. Open the ink cartridge access door.

 **NOTE:** Wait until the print carriage stops moving before proceeding.

3. Press the front of the ink cartridge to release it, and then remove it from the slot.

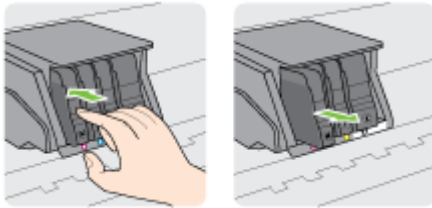

4. Remove the new ink cartridge from its packaging.
5. Using the color-coded letters for help, slide the ink cartridge into the empty slot until it is securely installed in the slot.

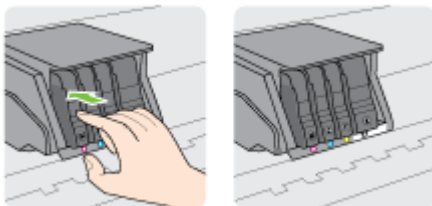

Make sure that you insert the ink cartridge into the slot that has the same colored letter as the color you are installing.



6. Repeat steps 3 through 5 for each ink cartridge you are replacing.
7. Close the print-carriage access door.

Order ink cartridges

To order ink cartridges, go to www.hp.com. (At this time, some portions of the HP website are available in English only.) Ordering cartridges online is not supported in all countries/regions. However, many countries have information on ordering by telephone, locating a local store and printing a shopping list. In addition, you can visit the www.hp.com/buy/supplies page to obtain information about purchasing HP products in your country.

Use only the replacement cartridges that have the same cartridge number as the ink cartridge you are replacing. You can find the cartridge number in the following places:

- In the embedded web server, by clicking the **Tools** tab, and then, under **Product Information** clicking **Ink Gauge**. For more information, see [Embedded web server on page 118](#).
- On the printer status report (see [Printer status report on page 125](#)).
- On the label of the ink cartridge you are replacing.
- On a sticker inside the printer. Open the ink cartridge access door to locate the sticker.



NOTE: The **Setup** ink cartridge that comes with the printer is not available for separate purchase.

Store printing supplies

Ink cartridges can be left in the printer for extended periods of time. However, to assure optimal ink cartridge health, be sure to turn off the printer properly.

For more information, see [Turn the printer off on page 38](#).

Anonymous usage information storage

The HP cartridges used with this printer contain a memory chip that assists in the operation of the printer. In addition, this memory chip stores a limited set of anonymous information about the usage of the printer, which might include the following: the number of pages printed using the cartridge, the page coverage, frequency of printing, and the printing modes used.

This information helps HP design future printers to meet our customers' printing needs. The data collected from the cartridge memory chip does not contain information that can be used to identify a customer or user of the cartridge or their printer.

HP collects a sampling of the memory chips from cartridges returned to HP's free return and recycling program (HP Planet Partners: www.hp.com/recycle). The memory chips from this sampling are read and studied in order to improve future HP printers. HP partners who assist in recycling this cartridge might have access to this data, as well.

Any third party possessing the cartridge might have access to the anonymous information on the memory chip. If you prefer to not allow access to this information, you can render the chip inoperable. However, after you render the memory chip inoperable, the cartridge cannot be used in an HP printer.

If you are concerned about providing this anonymous information, you can make this information inaccessible by turning off the memory chip's ability to collect the printer's usage information.

To disable the usage information function

1. From the printer control panel, touch and slide your finger across the screen and then touch **Setup**.
2. Select **Tools**, and then touch **Cartridge Chip Information**.
3. Touch **OK** to disable usage information collection.

 **NOTE:** To turn the usage information function on, restore the factory defaults. For more information about how to restore the defaults, see [Restore defaults on page 39](#).

 **NOTE:** You can continue to use the cartridge in the HP printer if you turn off the memory chip's ability to collect the printer's usage information.

8 Network setup

Additional advanced settings are available from the printer's home page (embedded web server or EWS).

For more information, see [Embedded web server on page 118](#).

- [Set up the printer for wireless communication](#)
- [Change network settings](#)
- [Change from a wireless connection to a USB or Ethernet connection](#)
- [Use HP wireless direct](#)

Set up the printer for wireless communication

- [Before you begin](#)
- [Set up the printer on your wireless network](#)
- [Change the connection type](#)
- [Test the wireless connection](#)
- [Turn on or off the wireless capability of the printer](#)



NOTE: If you encounter problems connecting the printer, see [Unable to connect the printer wirelessly on page 150](#).



TIP: For more information about setting up and using the printer wirelessly, visit the HP Wireless Printing Center (www.hp.com/go/wirelessprinting).

Before you begin

Ensure the following:

- The printer is not connected to the network using an Ethernet cable.
- The wireless network is set up and working properly.
- The printer and the computers that use the printer are on the same network (subnet).

While connecting the printer, you might be prompted to enter the wireless network name (SSID) and a wireless password.

- The wireless network name is the name of your wireless network.
- The wireless password prevents other people from connecting to your wireless network without your permission. Depending on the level of security required, your wireless network might use either a WPA key or WEP passphrase.

If you have not changed the network name or the security passkey since setting up your wireless network, you can sometimes find them on the back or side of the wireless router.

If you cannot find the network name or the security password or cannot remember this information, see the documentation provided with your computer or with the wireless router. If you still cannot find this information, contact your network administrator or the person who set up the wireless network.

Set up the printer on your wireless network

Use the Wireless Setup Wizard from the printer control panel display to set up wireless communication. For more information, see [Change from an Ethernet connection to a wireless connection on page 107](#).

1. From the printer control panel display, touch and slide your finger across the screen and then touch **Setup**.
2. Touch **Network Setup**.
3. Touch **Wireless Settings**.
4. Touch **Wireless Setup Wizard**.
5. Follow the display instructions to complete the setup.

If you are already using the printer with a different type of connection, such as a USB connection, follow the instructions in [Change the connection type on page 107](#) to set up the printer on your wireless network.

Change the connection type

After you have installed the HP printer software and connected the printer to your computer or to a network, you can use the software to change the connection type (for example, from a USB connection to a wireless connection).

 **NOTE:** If you are changing to a wireless connection, make sure that an Ethernet cable has not been connected to the printer. Connecting an Ethernet cable turns off the wireless capability of the printer. Also, you might be prompted to temporarily connect a USB cable during the setup process.

To change the connection type, do one of the following:

- [Change from an Ethernet connection to a wireless connection](#)
- [Change from a USB connection to a wireless connection](#)

Change from an Ethernet connection to a wireless connection

 **NOTE:** Check the prerequisites before you begin. For more information, see [Before you begin on page 106](#).

To change from an Ethernet connection to a wireless connection (Windows)

1. Remove the Ethernet cable from the printer.
2. Open the printer software after the installation. For more information, see [Open the HP printer software \(Windows\) on page 37](#).

Run the Wireless Setup Wizard to make the wireless connection. For more information, see [Set up the printer on your wireless network on page 106](#).

To change from an Ethernet connection to a wireless connection (OS X)

Before you proceed, go through the list at [Before you begin on page 106](#).

1. Connect the printer to your wireless network.
2. Use **HP Setup Assistant** in **Applications/Hewlett-Packard/Device Utilities** to change the software connection to wireless for this printer.

Change from a USB connection to a wireless connection

 **NOTE:** Check the prerequisites before you begin. For more information, see [Before you begin on page 106](#).

To change from a USB connection to a wireless network (Windows)

1. Depending on your operating system, do one of the following:
 - **Windows 8:** Right-click an empty area on the Start screen, click **All Apps** on the app bar, select the printer name, and then click **Utilities**.
 - **Windows 7, Windows Vista, and Windows XP:** From the computer desktop, click **Start**, select **All Programs**, click **HP**, click the folder of your printer.
2. Click **Printer Setup & Software**.
3. Select **Convert a USB connected printer to wireless**. Follow the on-screen instructions.

To change from a USB connection to a wireless network (OS X)

1. Connect the printer to your wireless network.
2. Use **HP Setup Assistant** in **Applications/Hewlett-Packard/Device Utilities** to change the software connection to wireless for this printer.

Learn more about how to change from a USB to wireless connection. [Click here to go online for more information.](#)

Test the wireless connection

Print the wireless test report for information about the printer wireless connection. The wireless test report provides information about the printer status, hardware (MAC) address, and IP address. If the printer is connected to a network, the test report displays details about the network settings.

To print the wireless test report

1. From the printer control panel, touch  (Wireless), and then touch **Settings**.
2. Touch **Print Reports**
3. Touch **Print Wireless Test Report**.

Turn on or off the wireless capability of the printer

The wireless capability of the printer is on by default, as indicated by the blue Wireless light on the printer control panel. If the wireless light is blinking, wireless enable (wireless radio on) but you do not have a wireless connection. If the wireless light is on solid blue, the printer has an active connection to a wireless network.

If your printer is connected using an Ethernet, the wireless capability is not used, in this case you might want to turn off the printer wireless capability.



NOTE: Connecting an Ethernet cable to the printer automatically turns off the wireless capability and the Wireless light also goes off.

1. From the printer control panel, touch and slide your finger across the screen, touch **Setup**, and then touch **Network Setup**.
2. Touch **Wireless Settings**.
3. Touch **Wireless** to turn on or turn off the radio.

Change network settings



From the printer control panel, you can set up and manage your printer wireless connection and perform a variety of network management tasks. This includes viewing and changing network settings, restoring network defaults, and turning the wireless function on or off.

- [View and print network settings](#)
- [Set link speed](#)
- [Change IP settings](#)

⚠ CAUTION: Network settings are provided for your convenience. However, unless you are an advanced user, you should not change some of these settings (such as the link speed, IP settings, default gateway, and firewall settings).

View and print network settings

To view or print network settings, use one of the following ways:

- From the printer control panel, touch  (Wireless) or  (Ethernet). The network status screen is displayed.
- Print the network configuration page. For more information, see [Network configuration page on page 126](#).
- Run the wireless test. For more information, see [Step 3: Run the wireless test on page 151](#).

To access the software, see [Open the HP printer software \(Windows\) on page 37](#).

Set link speed

You can change the speed at which data is transmitted over the network. The default is **Automatic**.

1. From the printer control panel, touch and slide your finger across the screen, touch **Setup**, and then touch **Network Setup**.
2. Touch **Ethernet Settings**.
3. Select **Advanced Setup**.
4. Touch **Link Speed**.
5. Touch the appropriate option that matches your network hardware.

Change IP settings

The default IP setting for the IP settings is **Automatic**, which sets the IP settings automatically. If you are an advanced user and want to use different settings (such as the IP address, subnet mask, or the default gateway), you can change them manually.

⚠ CAUTION: Be careful when manually assigning an IP address. If you enter an invalid IP address during the installation, your network components cannot connect with the printer.

1. From the printer control panel, touch and slide your finger across the screen, touch **Setup**, and then touch **Network Setup**.
2. Touch **Ethernet Settings** or **Wireless Settings**.
3. Touch **Advanced Setup**.
4. Touch **IP Settings**.

5. A message appears warning that changing the IP address removes the printer from the network. Touch **OK** to continue.
6. **Automatic** is selected by default. To change the settings manually, touch **Manual**, and then enter the appropriate information for the following settings:
 - **IP**
 - **Subnet Mask**
 - **Default Gateway**
 - **DNS Address**
7. Enter your changes, and then touch **Done**.
8. Touch **OK**.

Change from a wireless connection to a USB or Ethernet connection

To change from a wireless connection to a USB or Ethernet connection(Windows)

1. Depending on your operating system, do one of the following:
 - **Windows 8:** Right-click an empty area on the Start screen, click **All Apps** on the app bar, select the printer name, and then click **Utilities**.
 - **Windows 7, Windows Vista, and Windows XP:** From the computer desktop, click **Start**, select **All Programs**, click **HP**, click the folder of your printer.
2. Click **Printer Setup & Software**.
3. Click **Connect a new printer**.
4. Select the appropriate connection type when prompted and then follow the display instructions to complete the setup.

To change from a wireless connection to a USB or Ethernet connection (OS X)

1. Connect the printer to your wireless network.
2. Use **HP Setup Assistant** in **Applications/Hewlett-Packard/Device Utilities** to change the software connection to wireless for this printer.

Use HP wireless direct

With HP wireless direct, you can print wirelessly from a computer, smart phone, tablet, or other wireless-capable device—without connecting to an existing wireless network.

When using HP wireless direct, note the following guidelines:

- Make sure your computer or mobile device has the necessary software.
If you are using a computer, make sure you have installed the printer software provided with the printer.
- If you are using a mobile device, make sure you have installed a compatible printing app. For more information about mobile printing, visit www.hp.com/global/us/en/eprint/mobile_printing_apps.html.
- Make sure HP wireless direct is turned on in the printer and, if necessary, security is enabled. For more information, see [Turn on HP wireless direct on page 112](#).
- If you have not installed the HP printer software on the computer, connect to wireless direct first and then install the printer software. Select **Wireless** when prompted by the printer software for a connection type.
- Up to five computers and mobile devices can use the same HP wireless direct connection.
- HP wireless direct can be used while the printer is also connected to a computer using USB cable or to a network using a wireless connection.
- HP wireless direct cannot be used to connect a computer, mobile device, or printer to the Internet.

 [Click here to go online for more information.](#)

 **NOTE:** At this time, these websites might not be available in all languages.

This section contains the following topics:

- [Turn on HP wireless direct](#)
- [Print from a wireless-capable mobile device](#)
- [Print from a wireless-capable computer](#)

Turn on HP wireless direct

1. From the printer control panel, touch  (wireless direct).
2. Use the slider next to **HP Wireless Direct** to turn wireless direct on or off.

 **TIP:** If you would like to use HP wireless direct with greater security and if the computer or mobile device supports WPA2 encryption, touch **Security** to enable or disable security. With security enabled, only users with the password can connect wirelessly to the printer. Without enabling security, anyone with a wireless device within the wireless range of the printer can connect to the printer.

3. Touch **Wireless Direct Name** to display the wireless direct name.
4. If you have enabled security, touch **Security Passcode** to display the wireless direct password.

 **TIP:** You can also turn on HP wireless direct from the EWS. For more information about using the EWS, see [Embedded web server on page 118](#).

Print from a wireless-capable mobile device

Make sure you have installed a compatible printing app on your mobile device. For more information, visit www.hp.com/global/us/en/eprint/mobile_printing_apps.html.

1. Make sure you have turned on HP wireless direct on the printer. For more information, see [Turn on HP wireless direct on page 112](#).
2. Turn on the Wi-Fi connection on your mobile device. For more information, see the documentation provided with the mobile device.

 **NOTE:** If your mobile device does not support Wi-Fi, you are not able to use HP wireless direct.

3. From the mobile device, connect to a new network. Use the process you normally use to connect to a new wireless network or hotspot. Choose the HP wireless direct name from the list of wireless networks shown such as **HP-Print-**-Officejet Pro XXXX** (where ** are the unique characters to identify your printer and XXXX is the printer model located on the printer).

If HP wireless direct is turned on with security, enter the password when prompted.

4. Print your document.

Print from a wireless-capable computer

With HP wireless direct, you can print wirelessly from a computer without connecting to an existing wireless network or using the HP printer software provided with the printer.

Follow the instructions to print from your wireless-capable computer.

To print from a wireless-capable computer (Windows)

1. Make sure you have turned on HP wireless direct on the printer. For more information, see [Turn on HP wireless direct on page 112](#).
2. Turn on the computer's Wi-Fi connection. For more information, see the documentation provided with the computer.

 **NOTE:** If your computer does not support Wi-Fi, you are not able to use HP wireless direct.

3. From the computer, connect to a new network. Use the process you normally use to connect to a new wireless network or hotspot. Choose the HP wireless direct name from the list of wireless networks shown such as **HP-Print-**-Officejet Pro XXXX** (where ** are the unique characters to identify your printer and XXXX is the printer model located on the printer).

If HP wireless direct is turned on with security, enter the password when prompted.

4. Proceed to step 5 if the printer has been installed and connected to the computer over a wireless network. If the printer has been installed and connected to your computer with a USB cable, follow the steps below to install the printer software using the HP wireless direct connection.
 - a. Depending on your operating system, do one of the following:
 - **Windows 8:** Right-click an empty area on the Start screen, click **All Apps** on the app bar, select the printer name, and then click **Utilities**.
 - **Windows 7, Windows Vista, and Windows XP:** From the computer desktop, click **Start**, select **All Programs**, click **HP**, click the folder of your printer.
 - b. Click **Printer Setup & Software**, and then select **Connect a new printer**.

- c. When the **Connection Options** software screen appears, select **Wireless**.
Select your HP printer software from the list of detected printers.
 - d. Follow the on-screen instructions.
5. Print your document.

To print from a wireless-capable computer (OS X)

1. Make sure you have turned on HP wireless direct on the printer. For more information, see [Turn on HP wireless direct on page 112](#).
2. Turn on AirPort.
For more information, see the documentation provided by Apple.
3. Click the AirPort icon and choose the HP wireless direct name, such as **HP-Print-**-Officejet Pro XXXX** (where ****** are the unique characters to identify your printer and **XXXX** is the printer model located on the printer).
If HP wireless direct is turned on with security, enter the password when prompted.
4. Add the printer.
 - a. In **System Preferences**, select **Print & Fax** or **Print & Scan**, depending on your operating system.
 - b. Click + below the list of printers at the left.
 - c. Select the printer from the list of detected printers (the word “Bonjour” is listed the right column beside the printer name), and click **Add**.

9 Printer management tools

This section contains the following topics:

- [Toolbox \(Windows\)](#)
- [HP Utility \(OS X\)](#)
- [Embedded web server](#)

Toolbox (Windows)

The Toolbox provides maintenance information about the printer.



NOTE: The Toolbox can be installed from the HP Software CD if the computer meets the system requirements.

- [Open the Toolbox](#)

Open the Toolbox

1. Open the HP printer software. For more information, see [Open the HP printer software \(Windows\) on page 37](#).
2. In the HP printer software, click **Maintain Your Printer** under **Print, Scan & Fax**.

HP Utility (OS X)

HP Utility contains tools to configure print settings, calibrate the printer, order supplies online, and find web site support information.

 **NOTE:** The features available in HP Utility vary depending on the selected printer.

Ink level warnings and indicators provide estimates for planning purposes only. When you receive a low-ink warning message, consider having a replacement cartridge available to avoid possible printing delays. You do not need to replace cartridges until prompted to do so.

Double-click HP Utility in the **Hewlett-Packard** folder in the **Applications** folder at the top level of the hard disk.

Embedded web server

When the printer is connected to a network, you can use the printer's home page (embedded web server or EWS) to view status information, change settings, and manage it from your computer.

 **NOTE:** To view or change some settings, you might need a password.

You can open and use the embedded web server without being connected to the Internet. However, some features are not available.

- [About cookies](#)
- [Open the embedded web server](#)

About cookies

The embedded Web server (EWS) places very small text files (cookies) on your hard drive when you are browsing. These files let the EWS recognize your computer the next time you visit. For example, if you have configured the EWS language, a cookie helps remember which language you have selected so that the next time you access the EWS, the pages are displayed in that language. Some cookies (such as the cookie that stores customer-specific preferences) are stored on the computer until you clear them manually.

You can configure your browser to accept all cookies, or you can configure it to alert you every time a cookie is offered, which allows you to decide which cookies to accept or refuse. You can also use your browser to remove unwanted cookies.

 **NOTE:** Depending on your printer, if you disable cookies, you also disable one or more of the following features:

- Starting where you left the application (especially useful when using setup wizards)
- Remembering the EWS browser language setting
- Personalizing the EWS Home page

For information about how to change your privacy and cookie settings and how to view or delete cookies, see the documentation available with your Web browser.

Open the embedded web server

You can access the embedded Web server through either the network or Wireless Direct.

 **NOTE:** The printer must be on a network and must have an IP address. The IP address and hostname for the printer are listed on the status report. For more information, see [Network configuration page on page 126](#).

To open the embedded web server from a web browser

- In a supported web browser on your computer, type the IP address or hostname assigned to the printer.

For example, if the IP address is 123.123.123.123, type the following address into the web browser: `http://123.123.123.123`

To open the embedded web server through wireless direct

1. Touch  (wireless direct) from the printer control panel display.
2. If the display shows that wireless direct is **Off**, touch **Wireless Direct** to turn it on.

3. From your wireless computer, turn wireless on, search for and connect to the wireless direct name. If you have wireless direct security on, enter the wireless direct password when prompted.
4. In a supported Web browser on your computer, type the following address: `http://192.168.223.1`.

10 Solve a problem

The information in this section suggests solutions to common problems. If your printer is not operating correctly and these suggestions did not solve your problem, try using one of the following support services to obtain assistance.

This section contains the following topics:

- [HP support](#)
- [Get help from the printer control panel](#)
- [Understand printer reports](#)
- [Solve printer problems](#)
- [Solve printing problems](#)
- [Solve copy problems](#)
- [Solve scan problems](#)
- [Solve fax problems](#)
- [Solve HP ePrint and HP Printables problems](#)
- [Solve network problems](#)
- [Solve printer management problems](#)
- [Printhead maintenance](#)
- [Clear jams](#)
- [Clear the print carriage](#)

HP support

- [Register printer](#)
- [Support process](#)
- [Obtain electronic support](#)
- [HP support by phone](#)

Register printer

By taking just a few quick minutes to register, you can enjoy quicker service, more efficient support, and product support alerts. If you did not register your printer while installing the software, you can register now at <http://www.register.hp.com>.

Support process

If you have a problem, follow these steps:

1. Check the documentation that came with the printer.
2. Visit the HP online support website at www.hp.com/support.

HP online support is available to all HP customers. It is the fastest source for up-to-date product information and expert assistance, and includes the following features:

- Fast access to qualified online support specialists
 - Software and driver updates for the printer
 - Valuable troubleshooting information for common problems
 - Proactive printer updates, support alerts, and HP newsgrams that are available when you register the printer
3. Call HP support. For more information, see [HP support by phone on page 123](#).

Support options and availability vary by printer, country/region, and language.

Obtain electronic support

To find support and warranty information, go to the HP web site at www.hp.com/support. This website provides information and utilities that can help you correct many common printer problems. If prompted, select your country/region, and then click **Contact HP** for information about calling for technical support.

This web site also offers technical support, drivers, supplies, ordering information and other options such as:

- Access online support pages.
- Send HP an email message for answers to your questions.
- Connect with an HP technician by using online chat.
- Check for HP software updates.

You can also obtain support from the HP software for Windows or OS X, which provide easy, step-by-step solutions to common printing problems. For more information, see [Printer management tools on page 115](#).

Support options and availability vary by printer, country/region, and language.

HP support by phone

Phone support options and availability vary by printer, country/region, and language.

This section contains the following topics:

- [Before you call](#)
- [Phone support period](#)
- [Support phone numbers](#)
- [After the phone support period](#)

Before you call

Call HP support while you are in front of the computer and the printer. Be prepared to provide the following information:

- Model number
- Serial number (located on the back or bottom of the printer)
- Messages that appear when the situation occurs
- Answers to these questions:
 - Has this situation happened before?
 - Can you re-create it?
 - Did you add any new hardware or software to your computer at about the time that this situation began?
 - Did anything else occur prior to this situation (such as a thunderstorm or moving the printer)?

Phone support period

One year of phone support is available in North America, Asia Pacific, and Latin America (including Mexico). To determine the duration of phone support in Europe, the Middle East, and Africa, go to www.hp.com/support. Standard phone company charges apply.

Support phone numbers

For the most current HP list of telephone support numbers and call costs information, see www.hp.com/support.

After the phone support period

After the phone support period, help is available from HP at an additional cost. Help may also be available at the HP online support Web site: www.hp.com/support. Contact your HP dealer or call the support phone number for your country/region to learn more about support options.

Get help from the printer control panel

You can use the printer's help topics to learn more about the printer, and some help topics include animations that guide you through procedures, such as clearing jams.

To open the help topics from the printer control panel, touch “ (Help) from the Home screen.

Understand printer reports

You can print the following reports to help troubleshoot problems with the printer.

- [Printer status report](#)
- [Network configuration page](#)

Printer status report

Use the printer status report to view current printer information and ink cartridge status. Also use the printer status report to help you troubleshoot problems with the printer.

The printer status report also contains a log of recent events.

If you need to call HP, it is often useful to print the printer status report before calling.

To print the Printer Status Report

1. From the printer control panel display, touch and slide your finger across the screen and then touch **Setup**.
2. Touch **Print Reports** and then touch **Printer Status Report**.



1. **Product Information:** Shows printer information (such as the printer name, model number, serial number, and firmware version number), the accessories that are installed (such as the automatic two-sided printing accessory or duplexer), and the number of pages printed from the trays and accessories.
2. **Print Usage Information:** Shows summary information about pages printed from the printer.

3. **Ink Delivery System Information:** Shows the estimated ink levels (represented in graphical form as gauges) and the part numbers and warranty expiration dates for the ink cartridges.



NOTE: Ink level warnings and indicators provide estimates for planning purposes only. When you receive a low-ink warning message, consider having a replacement cartridge available to avoid possible printing delays. You do not need to replace cartridges until prompted to do so.

4. **Additional Assistance:** Provides information about where you can go to get more information about the printer, as well as information about how to set up a Fax Text and how to run a Wireless Network Test.

Network configuration page

If the printer is connected to a network, you can print a network configuration page to view the network settings for the printer and a list of networks detected by your printer. The last page of the report includes a list of all detectable wireless networks in the area, along with signal strength and the channels being used. This might help you select a channel for your network which is not heavily used by other networks (which will improve network performance).

You can use the network configuration page to help troubleshoot network connectivity problems. If you need to call HP, it is often useful to print this page before calling.

To print the network configuration page

1. From the printer control panel display, touch and slide your finger across the screen and then touch **Setup**.
2. Touch **Print Reports** and then touch **Network Configuration Page**.

HP Network Configuration Page	
Model - HP Officejet Pro 8810	
1	General Information Network Status: Offline Active Connection Type: None URL(s) for Embedded Web Server: http://0.0.0.0 Firmware Revision: FDL2CA1251DR Hostname: HPB91B88 Serial Number: CN31GFB25205Z1 Internet: Not applicable
	802.3 Wired Hardware Address (MAC): 28:92:4a:b9:1b:88 Link Configuration: None
	802.11 Wireless Hardware Address (MAC): 28:92:4a:c0:68:7d Status: Disconnected Communication Mode: Infrastructure Network Name (SSID): Not Set
	Wireless Direct Status: Off Hardware Address (MAC): 6a:3b:a5:f8:70:75
	Port 9100 Status: Enabled
	LPD Status: Enabled
	Bonjour Status: Enabled Service Name: Officejet Pro 8500 A909g [B01B88]
	SLP Status: Enabled
5	Microsoft Web Services WS Discovery Status: Enabled WS Print Status: Enabled
	SNMP Status: Read-write enabled SNMP Version: v1 Set Community Name: Not Specified Get Community Name: Not Specified
	IPP Status: Enabled
	Proxy Settings Address: Not Specified Port: Not Specified Authentication: Off

- 1. General Information:** Shows information about the current status and active connection type of the network, and other information, such as the URL of the embedded web server.
- 2. 802.3 Wired:** Shows information about the active Ethernet network connection, such as the IP address, subnet mask, default gateway, as well as the hardware address of the printer.
- 3. 802.11 Wireless:** Shows information about your wireless network connection, such as the host name, IP address, subnet mask, default gateway, and server. It also indicates the network name (SSID), the relative signal strengths and the channels being used. You can check the network list to view if your own network signal strength is good and change the wireless communication setup using Wireless Setup Wizard. For more information, see [Change from an Ethernet connection to a wireless connection on page 107](#).

4. **Wireless Direct:** Shows information about your wireless direct connection, such as the network name (SSID), IP address, subnet mask, default gateway, and server.
5. **Miscellaneous:** Shows information about more advanced network settings.
 - **Port 9100:** The printer supports raw IP printing through TCP Port 9100. This HP-proprietary TCP/IP port on the printer is the default port for printing. It is accessed by HP software (for example, the HP Standard Port).
 - **LPD:** Line Printer Daemon (LPD) refers to the protocol and programs associated with line-printer spooling services that may be installed on various TCP/IP systems.

 **NOTE:** The LPD functionality can be used with any host implementation of LPD that complies with the RFC 1179 document. The process for configuring printer spoolers, however, might differ. See your system documentation for information about configuring these systems.

- **Bonjour:** Bonjour services (which use mDNS, or Multicast Domain Name System) are typically used on small networks for IP address and name resolution (through UDP port 5353), where a conventional DNS server is not used.
- **SLP:** Service Location Protocol (SLP) is an Internet standard network protocol that provides a framework to allow networking applications to discover the existence, location, and configuration of networked services in enterprise networks. This protocol simplifies discovery and use of network resources such as printers, web servers, fax machines, video cameras, files systems, backup devices (tape drives), databases, directories, mail servers, calendars.
- **Microsoft Web Services:** Enable or disable the Microsoft Web Services Dynamic Discovery (WS Discovery) protocols or Microsoft Web Services for Devices (WSD) Print services supported on the printer. Disable unused print services to prevent access through those services.

 **NOTE:** For more information about WS Discovery and WSD Print, visit www.microsoft.com.

- **SNMP:** Simple Network Management Protocol (SNMP) is used by network management applications for device management. The printer supports SNMPv1/v2 and SNMPv3 protocols on IP networks.
- **WINS:** If you have a Dynamic Host Configuration Protocol (DHCP) server on your network, the printer automatically obtains its IP address from that server and registers its name with any RFC 1001 and 1002-compliant dynamic name services as long as a WINS server IP address has been specified.
- **IPP:** Internet Printing Protocol (IPP) is a standard network protocol for remote printing. Unlike other remote IP-based protocols, IPP supports access control, authentication, and encryption, allowing for more secure printing.
- **Proxy Settings:** Shows information about proxy address, port, and the status of authentication. You can change the proxy settings from EWS.

To change the proxy settings, click **Web Services** from EWS, click **Proxy Settings** in the **Web Services Settings**, select the appropriate options.

Solve printer problems

This section contains the following topics:

- [The printer shuts down unexpectedly](#)
- [Printhead alignment fails](#)
- [Paper-feed problems](#)
- [The printer cannot read the memory device](#)

The printer shuts down unexpectedly

Check the power and power connections

- Make sure the printer's power cord is connected firmly to a functioning power outlet.

Check the Schedule on and off feature

- The printer's Schedule On and Off feature will turn off the printer at the time you set.

Check if you enable the Schedule On and Off feature. For more information, see [Manage Power on page 5](#).

Printhead alignment fails

If the alignment process fails, make sure you have loaded unused, plain white paper into the input tray. If you have colored paper loaded in the input tray when you align the ink cartridges, the alignment fails.

If the alignment process fails repeatedly and the print quality is poor, you might need to clean the printhead. To clean the printhead, see [Clean the printhead on page 155](#).

If cleaning the printhead does not solve the problem, contact HP support. Go to www.hp.com/support. This website provides information and utilities that can help you correct many common printer problems. If prompted, select your country/region, and then click **Contact HP** for information on calling for technical support.

Paper-feed problems

 **TIP:** You can visit the HP online support website at www.hp.com/support for information and utilities that can help you correct many common printer problems.

Paper is not picked up from a tray

- Make sure paper is loaded in the tray. For more information, see [Load paper on page 23](#). Fan the paper before loading.
- Make sure the paper-width guides are set to the correct markings in the tray for the paper size you are loading. Also make sure the paper guides are snug, but not tight, against the stack.
- Make sure paper in the tray is not curled. Uncurl paper by bending it in the opposite direction of the curl.

Pages are skewing

- Make sure the paper loaded in the trays is aligned to the paper-width guides. If needed, pull out the trays from the printer and reload the paper correctly, making sure that the paper guides are aligned correctly.
- Load paper into the printer only when it is not printing.
- Remove and replace the automatic two-sided printing accessory (duplexer).
 - Push the button on either side of the duplexer, and then remove the unit.

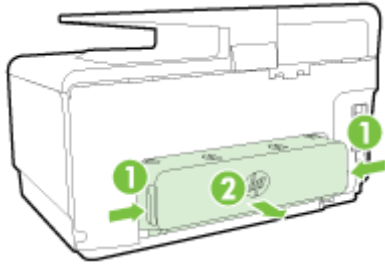

- Reinsert the duplexer into the printer.

Multiple pages are being picked up

- Make sure the paper-width guides are set to the correct markings in the tray for the paper size you are loading. Also make sure the paper-width guides are snug, but not tight, against the stack.
- Make sure the tray is not overloaded with paper.
- Use HP paper for optimum performance and efficiency.

The printer cannot read the memory device

Make sure that the memory device is one of the supported types and fully inserted into the correct slot. For more information, see [Insert a USB flash drive on page 29](#).

Some memory devices have a switch that controls how they can be used. Make sure that the switch is set so that the memory device can be read.

Solve printing problems

 **TIP:** (Windows) If you're having trouble printing, [run the HP Print and Scan Doctor](#) to troubleshoot the issue automatically. The utility will try to diagnose and fix the issue. The HP Print and Scan Doctor may not be available in all languages.

The printer is not responding (nothing prints)

- **There are print jobs stuck in the print queue**

Open the print queue, cancel all documents, and then reboot the computer. Try to print after the computer reboots. Refer to the Help system for the operating system for more information.

- **Check the HP software installation**

If the printer is turned off when printing, an alert message should appear on your computer screen; otherwise, the HP software provided with the printer might not be installed correctly. To resolve this, uninstall the HP software completely, and then reinstall the HP software.

- **Check the cable connections**

Make sure both ends of the USB cable or Ethernet cable are secure.

If the printer is connected to a network, check the following:

- Check the Link light on the back of the printer above the power input.
- Make sure you are not using a phone cord to connect the printer.

- **Check the printer's wireless connection**

If the printer is connected to the network with a wireless connection, check that the blue Wireless light is on and not blinking. A blinking light indicates there is connection problem between the printer and the network. You can print a Wireless Test Report to help diagnose any issues.

- **Check any personal firewall software installed on the computer**

The personal software firewall is a security program that protects a computer from intrusion. However, the firewall might block communication between the computer and the printer. If there is a problem communicating with the printer, try temporarily disabling the firewall. If the problem persists, the firewall is not the source of the communication problem. Re-enable the firewall.

 Use this troubleshooter to help you get your printer on the network if you have a firewall or antivirus protection that is causing a problem. [Click here to go online for more information.](#) At this time, this website might not be available in all languages.

- **Restart the printer and the computer**

If the printer is still not responding, turn off the printer and the computer, and turn them back on.

 If the above solutions do not resolve the problem, [click here for more online troubleshooting.](#)

Something on the page is missing or incorrect

- Try the solutions in **Print quality is not acceptable**

- **Check the printer location and length of USB cable**

High electromagnetic fields (such as those generated by USB cables) can sometimes cause slight distortions to printouts. Move the printer away from the source of the electromagnetic fields. Also, it is recommended that you use a USB cable that is less than 3 meters (9.8 feet) long to minimize the effects of these electromagnetic fields.

Print quality troubleshooting

1. Make sure you are using genuine HP ink cartridges. Genuine HP ink cartridges are designed and tested with HP printers to help you easily produce great results, time after time.

 **NOTE:** HP cannot guarantee the quality or reliability of non-HP supplies. Printer service or repairs required as a result of using a non-HP supply are not covered under warranty.

If you believe you purchased genuine HP ink cartridges, go to:

www.hp.com/go/anticounterfeit

2. Check the ink levels.

The ink cartridges might have insufficient ink.

Check the estimated ink levels in the ink cartridges. For more information, see [Check the estimated ink levels on page 97](#).

 **NOTE:** For regular usage, this product is not designed to print using only the black cartridge when the color cartridges are out of ink.

However, your printer is designed to let you print as long as possible when your cartridges start to run out of ink.

When there is sufficient ink in the printhead, the printer will offer you the use of black ink only when one or more of the color cartridges are out of ink, and the use of color ink only when the black cartridge is out of ink.

- The amount that you can print using black or color ink only is limited, so have replacement ink cartridges available when you are printing with black or color ink only.
- When there is no longer sufficient ink to print you will get a message that one or more cartridges are depleted, and you will need to replace the depleted cartridges before you resume printing.

For more information about printing under these conditions, see the following:

- When one or more color cartridges are out of ink, see [Use black ink only? on page 236](#).
 - When black cartridge is out of ink, see [Use color ink only? on page 237](#).
-

 **CAUTION:** While ink cartridges are not damaged when left outside of the printer, the printhead does need to have all cartridges installed at all times after the printer is set up and in use. Leaving one or more cartridge slots empty for an extended period may lead to print quality problems and possibly damage the printhead. If you have recently left a cartridge out of the printer for an extended period and have noticed poor print quality, clean the printhead.

For more information, see [Clean the printhead on page 155](#).

3. Check the paper loaded in the input tray. Make sure the paper is loaded correctly and that it is not wrinkled or too thick.

- Load paper with the print side facing down. For example, if you are loading glossy photo paper, load the paper with the glossy side down.
- Make sure the paper lays flat in the input tray and is not wrinkled. If the paper is too close to the printhead during printing, the ink might be smeared. This can happen if the paper is raised, wrinkled, or very thick, such as a mailing envelope.

For more information, see [Load paper on page 23](#).

4. Check the paper type.

HP recommends that you use HP papers or any other paper type with ColorLok technology that is appropriate for the printer. All papers with the ColorLok logo are independently tested to meet high standards of reliability and print quality, and produce documents with crisp, vivid color, bolder blacks and dry faster than ordinary plain papers. For more information, see [Paper basics on page 20](#).

Always make sure the paper you are printing on is flat. For best results when printing images, use HP Advanced Photo Paper.

Store specialty paper in its original packaging inside a resealable plastic bag on a flat surface in a cool, dry place. When you are ready to print, remove only the paper you plan to use immediately. When you have finished printing, return any unused photo paper to the plastic bag. This prevents the photo paper from curling.

5. Check the print settings by clicking the button that opens the **Properties** dialog box. (Depending on your software application, this button might be called **Properties**, **Options**, **Printer Setup**, **Printer Properties**, **Printer**, or **Preferences**.)

- Check the print settings in the printer driver to see if the color settings are incorrect.

For example, check to see if the document is set to print in grayscale. Or, check to see if advanced color settings such as saturation, brightness, or color tone, are set to modify the appearance of colors.

- Check the print quality setting and make sure it matches the type of paper loaded in the printer.

You might need to choose a lower print quality setting if colors are running into each other. Or, choose a higher setting if you are printing a high-quality photo, and then make sure photo paper such as HP Advanced Photo Paper is loaded in the input tray.

 **NOTE:** On some computer screens, colors might appear differently than they do when printed on paper. In this case, there is nothing wrong with the printer, print settings, or ink cartridges. No further troubleshooting is required.

6. Print and evaluate a print quality report.

Print quality problems can have many causes: software settings, a poor image file, or the printing system itself. If you are unhappy with the quality of your prints, a Print Quality Diagnostic page can help you determine if the printing system is working correctly.

To print a print quality report

- a. Touch and slide your finger across the screen, touch **Setup**.
- b. Touch **Print Reports**.
- c. Touch **Print Quality Report**.

HP Officejet Pro 8610 Series
Print Quality Diagnostic Page

Printer Information

Product model number: A3F94A
Product serial number: CN31GFB25205Z1
Service ID: Z3065
Firmware Version: FDL2CA1251DR
Pages printed: Tray 1=1, Tray 2=0, Total=1, Auto-duplex unit=0
Ink cartridge level: K=100, Y=100, M=100, C=100
*Estimates only. Actual ink levels may vary.

Test Pattern 1

If you see dark lines or white gaps where the arrows are pointing, calibrate linefeed.

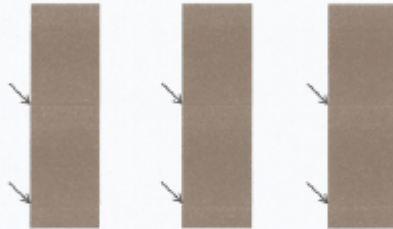

Test Pattern 2

If the lines are not straight and connected, align the printheads.



Test Pattern 3

If you see thin white lines across any of the colored blocks, clean the printhead.



If defects are seen on the page, follow the steps below:

- a. If the Print Quality Diagnostic report shows faded, partial, streaked, or missing color bars or patterns, check for depleted ink cartridges, and replace the ink cartridge that corresponds to the defective color bar or color pattern. If there is no depleted ink cartridge, remove and reinstall all ink cartridges to make sure they are properly installed.

Do not remove the depleted cartridge until you have a new ink cartridge available to replace. For information about how to install new cartridges, see [Replace the ink cartridges on page 99](#).

- b. If you see white or dark lines where the arrows are pointing in Test Pattern 1, calibrate the linefeed. For more information, see [Calibrate the linefeed on page 157](#).
- c. If the lines in Test Pattern 2 are not straight and connected, align the printhead. For more information, see [Align the printhead on page 156](#).
- d. If you see white lines in any of the color blocks in Test Pattern 3, clean the printhead. For more information, see [Clean the printhead on page 155](#).
- e. If none of the previous steps have helped, contact HP support to replace the printhead. For more information, see [HP support on page 122](#).



Solve copy problems

If the following topics do not help, see [HP support on page 122](#) for information about HP support.

- [Copies are blank or faded](#)
- [Size is reduced](#)
- [Copy quality is poor](#)

Learn more about how to solve copy issues. [Click here to go online for more information.](#)

Copies are blank or faded

- The contrast setting might be set too light. From the printer control panel display, touch **Copy**, touch  and **Settings**, touch **Lighter/Darker**, and then use the arrows to create darker copies.
- The quality setting of **Fast** (which produces draft-quality copies) might be responsible for the missing or faded documents. Change to the **Normal** or **Best** setting.
 - The contrast setting might be set too light. From the printer control panel display, touch **Copy**, touch  and **Settings**, touch **Lighter/Darker**, and then use the arrows to create darker copies.

Size is reduced

- The reduce/enlarge or other copy feature might have been set from the printer control panel to reduce the scanned image. Check the settings for the copy job to make sure that they are for normal size.
- The HP software settings might be set to reduce the scanned image. Change the settings, if needed. For more information, see the on-screen Help for the HP software.
- The dirty scanner glass might reduce the scanned image. Clean the scanner glass or lid backing. For more information, see [Maintain the printer on page 34](#).
- This incoming page size may be larger than the original currently loaded.

Copy quality is poor

- **Check the printer**
 - The scanner lid might not be closed correctly.
 - The scanner glass or lid backing might need cleaning. For more information, see [Maintain the printer on page 34](#).
 - The automatic document feeder (ADF) might need cleaning. For more information, see [Maintain the printer on page 34](#).
- **Unwanted lines**
 - The scanner glass, lid backing, or frame might need cleaning. For more information, see [Maintain the printer on page 34](#).
- **Copy is slanted or skewed**

If you are using the automatic document feeder (ADF), check the following:

- Make sure that the ADF input tray is not too full.
- Make sure that the ADF width adjusters are snug against the sides of the paper.

For more information, see [Load an original in the document feeder on page 28](#).

- **Horizontal grainy or white bands in light-gray to medium-gray areas**
 - The default enhancement setting might not be suitable for the job. Check the setting and change it to enhance text or photographs, if needed. For more information, see [Copy on page 54](#).

Solve scan problems

- [Scanner did nothing](#)
- [Scan takes too long](#)
- [Part of the document did not scan or text is missing](#)
- [Text cannot be edited](#)
- [Scanned image quality is poor](#)
- [Unable to scan to network folder](#)
- [Unable to scan to email](#)

Learn more about how to solve scan issues. [Click here to go online for more information.](#)

Scanner did nothing

- **Check the original**
 - Make sure that the original is loaded correctly. For more information, see [Load an original on the scanner glass on page 27](#) or [Load an original in the document feeder on page 28](#).
- **Check the printer**
 - The printer might be coming out of Sleep mode after a period of inactivity, which delays processing a short while. Wait until the printer displays the Home screen.

- **Check the HP software**

Make sure that the HP software provided with the printer is installed correctly.



NOTE: If you do not scan frequently, you can choose to turn off the feature.

- (Windows) Open the HP printer software. For more information, see [Open the HP printer software \(Windows\) on page 37](#). In the window that appears, go to the **Scan** section under **Print, Scan & Fax**, select **Scan a Document or Photo**.
- (OS X) Open HP Utility. For more information, see [HP Utility \(OS X\) on page 117](#). Under **Scan Settings**, select **Scan to Computer**, and ensure that **Enable Scan to Computer** is selected.

Scan takes too long

Scanning with higher scan resolution takes longer and results in larger file sizes. Lower the resolution to scan more quickly.

Part of the document did not scan or text is missing

- **Check the original**
 - Make sure that you loaded the original correctly.

For more information, see [Load an original on the scanner glass on page 27](#) or [Load an original in the document feeder on page 28](#).

- If you scanned the document from the ADF, try scanning the document directly from the scanner glass.

For more information, see [Load an original on the scanner glass on page 27](#).

- Colored backgrounds can cause images in the foreground to blend into the background. Try adjusting the settings before you scan the original, or try enhancing the image after you scan the original.

- **Check the settings**

- Make sure that the input paper size is large enough for the original that you are scanning.
- If you are using the HP printer software, the default settings in the printer software might be set to automatically perform a specific task other than the one that you are attempting. See the on-screen Help for the printer software for instructions about changing the properties.

Text cannot be edited

- Make sure that the OCR has been installed:

Depending on your operating system, do one of the following:

- **Windows 8:** Right-click an empty area on the Start screen, click **All Apps** on the app bar, select the printer name, and then click **Utilities**. Select **Printer Setup & Software**. Click **Add more software**, click **Customize Software Selections**, and make sure the OCR option is selected.
- **Windows 7, Windows Vista, and Windows XP:** From the computer desktop, click **Start**, select **All Programs**, click **HP**, select your printer name, and then select **Printer Setup & Software**. Click **Add More Software**, click **Customize Software Selections**, and make sure the OCR option is selected.
- (OS X) If you have installed the HP printer software using the Minimum installation option, the OCR software might not have been installed. To install this software, place the printer software CD into the computer, double-click the HP Installer icon on the printer software CD.

When you scan the original, make sure that you select a document type in the software that creates editable text. If text is classified as a graphic, it is not converted to text.

If you are using a separate OCR (optical character recognition) program, the OCR program might be linked to a word-processing program that does not perform OCR tasks. For more information, see the documentation provided with the OCR program.

Make sure you have selected an OCR language that corresponds to the language used for the document you are scanning. For more information, see the documentation provided with the OCR program.

- **Check the originals**

- When scanning documents as editable text from the ADF, the original must be loaded into the ADF with the top forward and print-side up. When scanning from the scanner glass, the original must be loaded with the top facing the right edge of the scanner glass. Also, make sure the document is not skewed. For more information, see [Load an original on the scanner glass on page 27](#) or [Load an original in the document feeder on page 28](#).
- The software might not recognize text that is tightly spaced. For example, if the text that the software converts has missing or combined characters, "rn" might appear as "m."

- The accuracy of the software depends on the image quality, text size, and structure of the original and the quality of the scan itself. Make sure that your original has good image quality.
- Colored backgrounds can cause images in the foreground to blend too much.

Scanned image quality is poor

- **Text or images on the back of a two-sided original appear in the scan**
 - Two-sided originals can "bleed" text or images from the back side to the scan if the originals are printed on paper that is too thin or too transparent.
- **Unwanted lines**

Ink, glue, correction fluid, or an unwanted substance might be on the scanner glass. Try cleaning the scanner glass.

For more information, see [Maintain the printer on page 34](#).
- **The scanned image is skewed (crooked)**
 - The original might have been loaded incorrectly. Be sure to use the paper-width guides when you load the originals into the ADF. For more information, see [Load an original in the document feeder on page 28](#).

For best results, use the scanner glass for scanning rather than the ADF. For more information, see [Load an original on the scanner glass on page 27](#).
- **The scanned image shows blots, lines, vertical white stripes, or other defects**
 - If the scanner glass is dirty, the image produced does not have optimum clarity.

See [Maintain the printer on page 34](#) for cleaning instructions.

 - The defects might be on the original and are not a result of the scanning process.
- **Size is reduced**
 - The HP printer software settings might be set to reduce the scanned image.

See the HP printer software Help for more information about changing the settings.

Unable to scan to network folder

 **NOTE:** HP Digital Filing does not support Active Directory.

- **The computer where the network folder is located is turned off**

Make sure the computer where the network folder is stored is turned on and connected to the network.
- **The network folder has not been set up correctly**
 - Make sure the folder is created on the server. For more information, see the documentation available for your operating system.
 - Make sure the folder has been shared and that users can both read and write to the folder. If you are using a Mac computer, make sure you have enabled SMB sharing. For more information, see the documentation available for your operating system.
 - Make sure the folder name uses only the letters or characters supported by the operating system. For more information, see the documentation available with the operating system.

- Make sure the folder name is entered in the correct format in the HP software. For more information, see the information in the wizard or the setup assistant.
- Make sure the valid username and password have been entered. For more information, see the information in the wizard or the setup assistant.
- **The disk is full**

Make sure the server containing the network folder has sufficient free disk space.
- **The printer cannot create a unique filename using the assigned prefix and suffix or the filename prefix has not been set up correctly**
 - The printer can create up to 9,999 files using the same prefix and suffix. If you have scanned many files to a folder, change the prefix.
 - Make sure the filename prefix uses only the letters or characters supported by the operating system. For more information, see the documentation available with the operating system.

Unable to scan to email

- **The email profile has not been set up correctly**

Make sure the valid outgoing SMTP server settings have been specified in the HP software. For more information about the SMTP server settings, see the documentation provided by your email service provider.
- **Email messages are sent to some recipients but not to others when sending to multiple recipients**

The email addresses might not be correct or might not be recognized by the email server. Make sure that the email addresses for all email recipients have been entered correctly in the HP software. Check your email Inbox for any delivery notification failure messages from the email server.
- **Sending large email messages**

Some email servers have been configured to reject email messages larger than a pre-determined size. To determine if your email server has a maximum file-size limit, see the documentation provided by your email service provider. If the email server does have such a limit, change the maximum email attachment size for the outgoing email profile to a value smaller than that of the email server.

Solve fax problems

This section contains fax setup troubleshooting information for the printer. If the printer is not set up correctly for faxing, you might experience problems when sending faxes, receiving faxes, or both.

If you are having faxing problems, you can print a fax test report to check the status of the printer. The test fails if the printer is not set up correctly for faxing. Perform this test after you have completed setting up the printer for faxing. For more information, see [Test fax setup on page 204](#).

If the test fails, review the report for information on how to fix any problems found. Learn more information about running fax test, [click here to go online for more information](#).

Learn more about fax troubleshooting, [click here to go online for more information](#). (At this time, this website might not be available in all languages.)

For further assistance, visit the HP online support site www.hp.com/support.

- [The fax test failed](#)
- [The display always shows Phone Off Hook](#)
- [The printer is having problems sending and receiving faxes](#)
- [The printer cannot receive faxes, but can send faxes](#)
- [The printer cannot send faxes, but can receive faxes](#)

The fax test failed

If you ran a fax test and the test failed, review the report for basic information about the error. For more detailed information, check the report to see which part of the test failed, and then review the appropriate topic in this section for solutions to try.

This section contains the following topics:

- [The "Fax Hardware Test" failed](#)
- [The "Fax Connected to Active Telephone Wall Jack" test failed](#)
- [The "Phone Cord Connected to Correct Port on Fax" test failed](#)
- [The "Using Correct Type of Phone Cord with Fax" test failed](#)
- [The "Dial Tone Detection" test failed](#)
- [The "Fax Line Condition" test failed](#)

The "Fax Hardware Test" failed

- Turn the printer off by pressing  (the Power button) located on the printer control panel and then unplug the power cord from the back of the printer. After a few seconds, plug the power cord in again, and then turn the power on. Run the test again. If the test fails again, continue reviewing the troubleshooting information in this section.
- Try to send or receive a test fax. If you can send or receive a fax successfully, there might not be a problem.
- If you are running the test from the **Fax Setup Wizard** (Windows) or **HP Utility** (OS X), make sure the printer is not busy completing another task, such as receiving a fax or making a copy. Check the display for a message indicating that the printer is busy. If it is busy, wait until it is finished and in the idle state before running the test.

- Make sure you use the phone cord that came with the printer. If you do not use the supplied phone cord to connect from the telephone wall jack to the printer, you might not be able to send or receive faxes. After you plug in the phone cord that came with the printer, run the fax test again.
- If you are using a phone splitter, this can cause faxing problems. (A splitter is a two-cord connector that plugs into a telephone wall jack.) Try removing the splitter and connecting the printer directly to the telephone wall jack.

After you resolve any problems found, run the fax test again to make sure it passes and the printer is ready for faxing. If the **Fax Hardware Test** continues to fail and you experience problems faxing, contact HP support. Go to www.hp.com/support. This website provides information and utilities that can help you correct many common printer problems. If prompted, select your country/region, and then click **Contact HP** for information on calling for technical support.

The "Fax Connected to Active Telephone Wall Jack" test failed

- Check the connection between the telephone wall jack and the printer to make sure the phone cord is secure.
- Make sure you use the phone cord that came with the printer. If you do not use the supplied phone cord to connect from the telephone wall jack to the printer, you might not be able to send or receive faxes. After you plug in the phone cord that came with the printer, run the fax test again.
- Make sure you have correctly connected the printer to the telephone wall jack. Using the phone cord supplied in the box with the printer, connect one end to your telephone wall jack, then connect the other end to the port labeled 1-LINE on the back of the printer. Learn more about setting up the printer for faxing, [click here to go online for more information](#).
- If you are using a phone splitter, this can cause faxing problems. (A splitter is a two-cord connector that plugs into a telephone wall jack.) Try removing the splitter and connecting the printer directly to the telephone wall jack.
- Try connecting a working phone and phone cord to the telephone wall jack that you are using for the printer and check for a dial tone. If you do not hear a dial tone, contact your telephone company and have them check the line.
- Try to send or receive a test fax. If you can send or receive a fax successfully, there might not be a problem.

After you resolve any problems found, run the fax test again to make sure it passes and the printer is ready for faxing.

The "Phone Cord Connected to Correct Port on Fax" test failed

Plug the phone cord into the correct port.

- Make sure you use the phone cord that came with the printer. If you do not use the supplied phone cord to connect from the telephone wall jack to the printer, you might not be able to send or receive faxes. After you plug in the phone cord that came with the printer, run the fax test again.
- If you are using a phone splitter, this can cause faxing problems. (A splitter is a two-cord connector that plugs into a telephone wall jack.) Try removing the splitter and connecting the printer directly to the telephone wall jack.

1. Using the phone cord supplied in the box with the printer, connect one end to your telephone wall jack, then connect the other end to the port labeled 1-LINE on the back of the printer.

 **NOTE:** If you use the 2-EXT port to connect to the telephone wall jack, you cannot send or receive faxes. The 2-EXT port should only be used to connect other equipment, such as an answering machine.

Figure 10-1 Back view of the printer



1	Telephone wall jack
2	Use the phone cord supplied in the box with the printer to connect to the "1-LINE" port

2. After you have connected the phone cord to the port labeled 1-LINE, run the fax test again to make sure it passes and the printer is ready for faxing.
3. Try to send or receive a test fax.

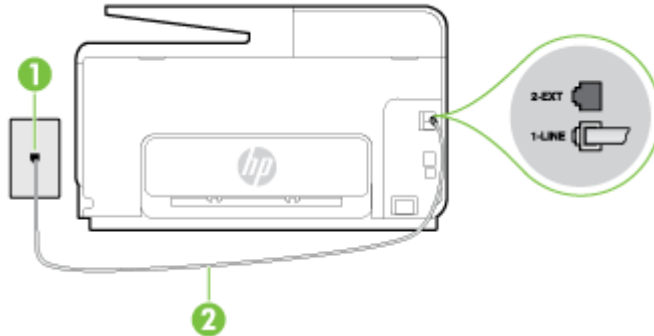
The "Using Correct Type of Phone Cord with Fax" test failed

- Make sure you used the phone cord supplied in the box with the printer to connect to the telephone wall jack. One end of the phone cord should be connected to the port labeled 1-LINE on the back of the printer, and the other end to your telephone wall jack, as shown in the illustration.

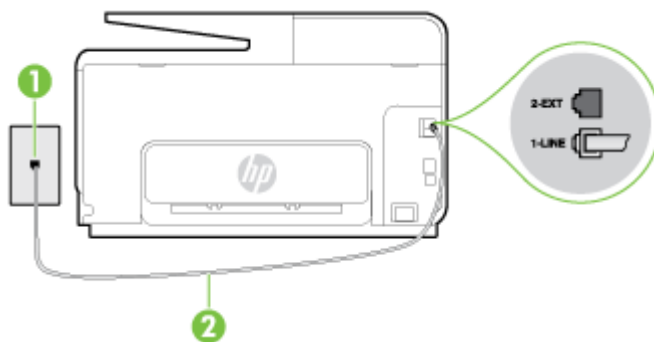

1	Telephone wall jack
2	Use the phone cord supplied in the box with the printer to connect to the "1-LINE" port

If the phone cord that came with the printer is not long enough, you can use a longer 2-wire phone cord to extend the length. You can purchase the cord at an electronics store that carries phone accessories.

- Check the connection between the telephone wall jack and the printer to make sure the phone cord is secure.

- Make sure you use the phone cord that came with the printer. If you do not use the supplied phone cord to connect from the telephone wall jack to the printer, you might not be able to send or receive faxes. After you plug in the phone cord that came with the printer, run the fax test again.
- If you are using a phone splitter, this can cause faxing problems. (A splitter is a two-cord connector that plugs into a telephone wall jack.) Try removing the splitter and connecting the printer directly to the telephone wall jack.

The "Dial Tone Detection" test failed

- Other equipment, which uses the same phone line as the printer, might be causing the test to fail. To find out if other equipment is causing a problem, disconnect everything from the phone line, and then run the test again. If the **Dial Tone Detection Test** passes without the other equipment, then one or more pieces of the equipment is causing problems; try adding them back one at a time and rerunning the test each time, until you identify which piece of equipment is causing the problem.
- Try connecting a working phone and phone cord to the telephone wall jack that you are using for the printer and check for a dial tone. If you do not hear a dial tone, contact your telephone company and have them check the line.
- Make sure you have correctly connected the printer to the telephone wall jack. Using the phone cord supplied in the box with the printer, connect one end to your telephone wall jack, then connect the other end to the port labeled 1-LINE on the back of the printer.
- If you are using a phone splitter, this can cause faxing problems. (A splitter is a two-cord connector that plugs into a telephone wall jack.) Try removing the splitter and connecting the printer directly to the telephone wall jack.
- If your telephone system is not using a standard dial tone, such as some PBX systems, this might cause the test to fail. This does not cause a problem sending or receiving faxes. Try sending or receiving a test fax.
- Check to make sure the country/region setting is set appropriately for your country/region. If the country/region setting is not set or is set incorrectly, the test might fail and you might have problems sending and receiving faxes.
- Make sure you connect the printer to an analog phone line or you cannot send or receive faxes. To check if your phone line is digital, connect a regular analog phone to the line and listen for a dial tone. If you do not hear a normal sounding dial tone, it might be a phone line set up for digital phones. Connect the printer to an analog phone line and try sending or receiving a fax.
- Make sure you use the phone cord that came with the printer. If you do not use the supplied phone cord to connect from the telephone wall jack to the printer, you might not be able to send or receive faxes. After you plug in the phone cord that came with the printer, run the fax test again.

After you resolve any problems found, run the fax test again to make sure it passes and the printer is ready for faxing. If the **Dial Tone Detection** test continues to fail, contact your telephone company and have them check the phone line.

The "Fax Line Condition" test failed

- Make sure you connect the printer to an analog phone line or you cannot send or receive faxes. To check if your phone line is digital, connect a regular analog phone to the line and listen for a dial tone. If you do not hear a normal sounding dial tone, it might be a phone line set up for digital phones. Connect the printer to an analog phone line and try sending or receiving a fax.
- Check the connection between the telephone wall jack and the printer to make sure the phone cord is secure.



- Make sure you have correctly connected the printer to the telephone wall jack. Using the phone cord supplied in the box with the printer, connect one end to your telephone wall jack, then connect the other end to the port labeled 1-LINE on the back of the printer.
- Other equipment, which uses the same phone line as the printer, might be causing the test to fail. To find out if other equipment is causing a problem, disconnect everything from the phone line, and then run the test again.
 - If the **Fax Line Condition Test** passes without the other equipment, then one or more pieces of the equipment is causing problems; try adding them back one at a time and rerunning the test each time, until you identify which piece of equipment is causing the problem.
 - If the **Fax Line Condition Test** fails without the other equipment, connect the printer to a working phone line and continue reviewing the troubleshooting information in this section.
- If you are using a phone splitter, this can cause faxing problems. (A splitter is a two-cord connector that plugs into a telephone wall jack.) Try removing the splitter and connecting the printer directly to the telephone wall jack.
- Make sure you use the phone cord that came with the printer. If you do not use the supplied phone cord to connect from the telephone wall jack to the printer, you might not be able to send or receive faxes. After you plug in the phone cord that came with the printer, run the fax test again.

After you resolve any problems found, run the fax test again to make sure it passes and the printer is ready for faxing. If the **Fax Line Condition** test continues to fail and you experience problems faxing, contact your telephone company and have them check the phone line.

The display always shows Phone Off Hook

- You are using the wrong type of phone cord. Make sure you are using the 2-wire phone cord that came with the printer to connect the printer to your phone line. If the phone cord that came with the printer is not long enough, you can use a longer phone cord to extend the length. You can purchase the cord at an electronics store that carries phone accessories.
- Other equipment that uses the same phone line as the printer might be in use. Make sure extension phones (phones on the same phone line, but not connected to the printer) or other equipment are not in use or off the hook. For example, you cannot use the printer for faxing if an extension phone is off the hook, or if you are using a computer dial-up modem to send email or access the Internet.

The printer is having problems sending and receiving faxes

- Make sure the printer is turned on. Look at the display on the printer. If the display is blank and  (the Power button) light is not lit, the printer is turned off. Make sure the power cord is firmly connected to the printer and plugged into a power outlet. Press  (the Power button) to turn on the printer.

After turning on the printer, HP recommends you wait five minutes before sending or receiving a fax. The printer cannot send or receive faxes while it is initializing after being turned on.

- If HP Digital Fax has been enabled, you might not be able to send or receive faxes if the fax memory is full (limited by printer memory).

- Make sure you used the phone cord supplied in the box with the printer to connect to the telephone wall jack. One end of the phone cord should be connected to the port labeled 1-LINE on the back of the printer and the other end to your telephone wall jack, as shown in the illustration.

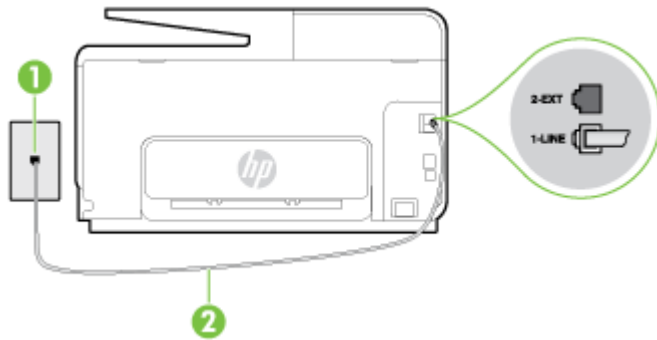

1	Telephone wall jack
2	Use the phone cord supplied in the box with the printer to connect to the "1-LINE" port

If the phone cord that came with the printer is not long enough, you can use a longer 2-wire phone cord to extend the length. You can purchase the cord at an electronics store that carries phone accessories.

- Try connecting a working phone and phone cord to the telephone wall jack that you are using for the printer and check for a dial tone. If you do not hear a dial tone, call your local telephone company for service.
- Other equipment, which uses the same phone line as the printer, might be in use. For example, you cannot use the printer for faxing if an extension phone is off the hook, or if you are using a computer dial-up modem to send an email or access the Internet.
- Check to see if another process has caused an error. Check the display or your computer for an error message providing information about the problem and how to solve it. If there is an error, the printer cannot send or receive a fax until the error condition is resolved.
- The phone line connection might be noisy. Phone lines with poor sound quality (noise) can cause faxing problems. Check the sound quality of the phone line by plugging a phone into the telephone wall jack and listening for static or other noise. If you hear noise, turn **Error Correction Mode (ECM)** off and try faxing again. For information about changing ECM, see [Send a fax in Error Correction Mode on page 66](#). If the problem persists, contact your telephone company.
- If you are using a digital subscriber line (DSL) service, make sure that you have a DSL filter connected or you cannot fax successfully. [Click here to go online for more information](#).
- Make sure the printer is not connected to a telephone wall jack that is set up for digital phones. To check if your phone line is digital, connect a regular analog phone to the line and listen for a dial tone. If you do not hear a normal sounding dial tone, it might be a phone line set up for digital phones.
- If you are using either a private branch exchange (PBX) or an integrated services digital network (ISDN) converter/terminal adapter, make sure the printer is connected to the correct port and the terminal adapter is set to the correct switch type for your country/region, if possible. [Click here to go online for more information](#).
- If the printer shares the same phone line with a DSL service, the DSL modem might not be grounded correctly. If the DSL modem is not grounded correctly, it can create noise on the phone line. Phone lines with poor sound quality (noise) can cause faxing problems. You can check the sound quality of the phone line by plugging a phone into the telephone wall jack and

listening for static or other noise. If you hear noise, turn off your DSL modem and completely remove power for at least 15 minutes. Turn the DSL modem back on and listen to the dial tone again.

 **NOTE:** You might notice static on the phone line again in the future. If the printer stops sending and receiving faxes, repeat this process.

If the phone line is still noisy, contact your telephone company. For information on turning your DSL modem off, contact your DSL provider for support.

- If you are using a phone splitter, this can cause faxing problems. (A splitter is a two-cord connector that plugs into a telephone wall jack.) Try removing the splitter and connecting the printer directly to the telephone wall jack.

The printer cannot receive faxes, but can send faxes

- If you are not using a distinctive ring service, check to make sure that the **Distinctive Ring** feature on the printer is set to **All Rings**. For more information, see [Change the answer ring pattern for distinctive ring on page 78](#).
- If **Auto Answer** is set to **Off**, you need to receive faxes manually; otherwise, the printer cannot receive the fax. For information on receiving faxes manually, see [Receive a fax manually on page 67](#).
- If you have a voice mail service at the same phone number you use for fax calls, you must receive faxes manually, not automatically. This means that you must be available to respond in person to incoming fax calls. Learn more about setting up the printer when you have a voice mail service, [click here to go online for more information](#). For information on receiving faxes manually, see [Receive a fax manually on page 67](#).
- If you have a computer dial-up modem on the same phone line with the printer, check to make sure that the software that came with your modem is not set to receive faxes automatically. Modems that are set up to receive faxes automatically take over the phone line to receive all incoming faxes, which prevents the printer from receiving fax calls.
- If you have an answering machine on the same phone line with the printer, you might have one of the following problems:
 - Your answering machine might not be set up correctly with the printer.
 - Your outgoing message might be too long or too loud to allow the printer to detect fax tones, and the sending fax machine might disconnect.
 - Your answering machine might not have enough quiet time after your outgoing message to allow the printer to detect fax tones. This problem is most common with digital answering machines.

The following actions might help solve these problems:

- When you have an answering machine on the same phone line you use for fax calls, try connecting the answering machine directly to the printer, [click here to go online for more information](#).
- Make sure the printer is set to receive faxes automatically. For information on setting up the printer to receive faxes automatically, see [Receive a fax on page 67](#).
- Make sure the **Rings to Answer** setting is set to a greater number of rings than the answering machine. For more information, see [Set the number of rings before answering on page 78](#).

- Disconnect the answering machine and then try receiving a fax. If faxing is successful without the answering machine, the answering machine might be causing the problem.
- Reconnect the answering machine and record your outgoing message again. Record a message that is approximately 10 seconds in duration. Speak slowly and at a low volume when recording your message. Leave at least 5 seconds of silence at the end of the voice message. There should be no background noise when recording this silent time. Try to receive a fax again.



NOTE: Some digital answering machines might not retain the recorded silence at the end of your outgoing message. Play back your outgoing message to check.

- If the printer shares the same phone line with other types of phone equipment, such as an answering machine, a computer dial-up modem, or a multi-port switch box, the fax signal level might be reduced. The signal level can also be reduced if you use a splitter or connect extra cables to extend the length of your phone. A reduced fax signal can cause problems during fax reception.

To find out if other equipment is causing a problem, disconnect everything except the printer from the phone line, and then try to receive a fax. If you can receive faxes successfully without the other equipment, one or more pieces of the other equipment is causing problems; try adding them back one at a time and receiving a fax each time, until you identify which equipment is causing the problem.

- If you have a special ring pattern for your fax phone number (using a distinctive ring service through your telephone company), make sure that the **Distinctive Ring** feature on the printer is set to match. For more information, see [Change the answer ring pattern for distinctive ring on page 78](#).

The printer cannot send faxes, but can receive faxes

- The printer might be dialing too fast or too soon. You might need to insert some pauses in the number sequence. For example, if you need to access an outside line before dialing the phone number, insert a pause following the access number. If your number is 95555555, and 9 accesses an outside line, you might insert pauses as follows: 9-555-5555. To enter a pause in the fax number you are typing, touch * repeatedly, until a dash (-) appears on the display.

You can also send the fax using monitor dialing. This enables you to listen to the phone line as you dial. You can set the pace of your dialing and respond to prompts as you dial. For more information, see [Send a fax using monitor dialing on page 64](#).

- The number you entered when sending the fax is not in the proper format or the receiving fax machine is having problems. To check this, try calling the fax number from a telephone and listen for fax tones. If you cannot hear fax tones, the receiving fax machine might not be turned on or connected, or a voice mail service could be interfering with the recipient's phone line. You can also ask the recipient to check the receiving fax machine for any problems.

Solve HP ePrint and HP Printables problems

If you are having problems using Web Services, such as HP ePrint and print apps, check the following:

- Make sure the printer is connected to the Internet using an Ethernet or wireless connection.



NOTE: You cannot use these web features if the printer is connected using a USB cable.

- Make sure the latest product updates have been installed on the printer. For more information, see [Update the printer on page 36](#).
- Make sure Web Services is enabled on the printer. For more information, see [Set up Web Services using the printer control panel on page 89](#).
- Make sure the network hub, switch, or router is turned on and working correctly.
- If you are connecting the printer using an Ethernet cable, make sure you are not connecting the printer using a phone cord or a crossover cable to connect the printer to the network and that the Ethernet cable is securely connected to the printer. For more information, see [General network troubleshooting on page 150](#).
- If you are connecting the printer using a wireless connection, make sure the wireless network is functioning properly. For more information, see [Unable to connect the printer wirelessly on page 150](#).
- If you are using HP ePrint, check the following:
 - Make sure the printer's email address is correct.
 - Make sure that the printer's email address is the only address listed in the "To" line of the email message. If other email addresses are listed in the "To" line, the attachments you are sending might not print.
 - Make sure you are sending documents that meet the HP ePrint requirements.
- If your network uses proxy settings when connecting to the Internet, make sure the proxy settings you are entering are valid:
 - Check the settings being used by the Web browser you are using (such as Internet Explorer, Firefox, or Safari).
 - Check with the IT administrator or person who set up your firewall.

If the proxy settings used by your firewall have changed, you must update these settings in either the printer control panel. If these settings are not updated, you will not be able to use Web Services. Learn how to work with your firewall and antivirus programs. [Click here to go online for more information](#).



TIP: For additional help on setting up and using Web Services, visit HP Connected at www.hpconnected.com.

Solve network problems

This section provides solutions to common problems on connecting or using the printer on the network.

 **TIP:** (Windows) If you're having trouble printing, [run the HP Print and Scan Doctor](#) to troubleshoot the issue automatically. The utility will try to diagnose and fix the issue. The HP Print and Scan Doctor may not be available in all languages.

- [General network troubleshooting](#)
- [Unable to connect the printer wirelessly](#)

For more information about network problems, check the following:

- Learn how to find your network security settings. [Click here to go online for more information.](#)
- Learn about the network troubleshooting tips. [Click here to go online for more information.](#)
- Learn how to work with your firewall and antivirus programs during printer setup. [Click here to go online for more information.](#)

General network troubleshooting

If the installation program cannot discover the printer, from the printer control panel, print the network configuration page, and enter the IP address manually in the installation program. For more information, see [Network configuration page on page 126](#).

 **TIP:** You can visit the HP online support website at www.hp.com/support for information and utilities that can help you correct many common printer problems.

(Windows) If you're having trouble printing, [run the HP Print and Scan Doctor](#) to troubleshoot the issue automatically. The utility will try to diagnose and fix the issue. The HP Print and Scan Doctor may not be available in all languages.

Ensure the following:

- Do not turn on the wireless capability of the printer prior to installing the HP printer software. Make sure the Wireless light is not on.
- When prompted during software installation, be sure to connect the Ethernet cable and check that the Ethernet light near the connector gets turned on.
- All cable connections to the computer and the printer are secure.
- The network is operational and the network hub, switch, or router is turned on.
- (Windows) All applications, including virus protection programs, spyware protection programs, and firewalls, are closed or disabled.

Unable to connect the printer wirelessly

Make sure you have already set up the printer wireless capabilities.

For more information about the wireless connection setup, see [Set up the printer for wireless communication on page 106](#).

Step 1: Make sure the Wireless (802.11) light is turned on

Understand the behaviors of the Wireless light on the printer.

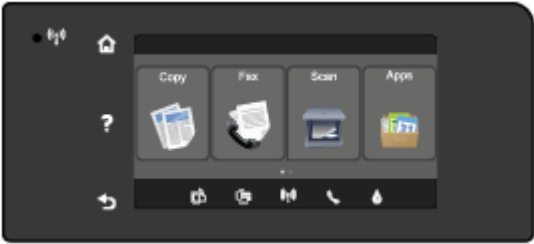
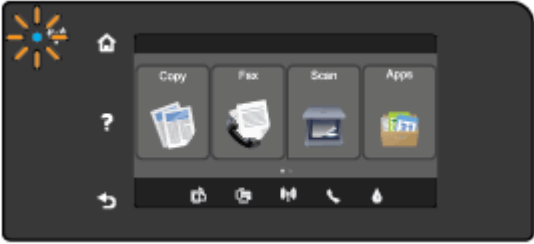
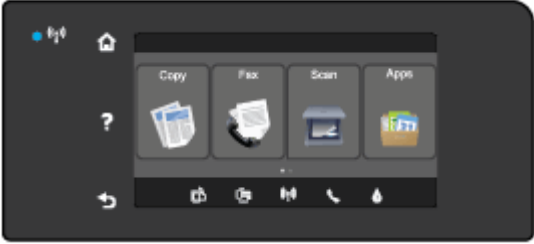
Light description/Light pattern	Explanation
The Wireless light is off.	The wireless capability of the printer is turned off.
	
The Wireless light is on but blinking.	The wireless capability of the printer is turned on and the printer is not connected to a network.
	
The Wireless light is on and solid.	The wireless capability of the printer is turned on and the printer is connected to a network.
	

If the blue wireless light on the printer control panel is not lit, the wireless capability of the printer might be turned off.

 **NOTE:** If your printer supports Ethernet networking, make sure that an Ethernet cable has not been connected to the printer. Connecting an Ethernet cable turns off the printer wireless capability.

To turn on the wireless capability of the printer

1. Touch  (Wireless) from the printer control panel, and then touch **Settings**.
2. Touch **Wireless Settings**.
3. Slide the button to turn on the printer wireless capability.

If the blue wireless light is blinking, it means the printer is not connected to a network. Use the HP printer software to connect the printer wirelessly.

Step 2: Make sure the computer is connected to the wireless network

Make sure your computer is connected to your wireless network. If you cannot connect the computer to the network, there might be a hardware issue with the router or computer.

Step 3: Run the wireless test

To check that the wireless connection is working properly, print the wireless test report.

1. Make sure the printer is turned on and paper is loaded in the tray.
2. From the printer control panel display, touch and slide your finger across the screen and then touch **Setup**.
3. Touch **Print Reports**.
4. Touch **Print Wireless Test Report**.

If the test fails, review the report for information on how to fix the problem and run the test again.

 **TIP:** If the wireless signal is weak or the printer has trouble staying connected, try moving the printer closer to the wireless router.

Step 4: Restart components of the wireless network

Turn off the router and the printer, and then turn them back on in this order: router first and then printer.

Sometimes, turning off devices and then turning them back on help resolve network communication issues. If you still cannot connect, turn off the router, the printer, and the computer, and then turn them back on in this order: router first, then printer, and then computer.

 **NOTE:** If you still have problems, visit the HP Wireless Printing Center (www.hp.com/go/wirelessprinting). (At this time, this website might not be available in all languages.) The website contains the latest information about setting up and using the printer on a wireless network, and resolving issues on wireless connection and security software.

 **TIP:** (Windows) If you're having trouble printing, run the HP Print and Scan Doctor to troubleshoot the issue automatically. The utility will try to diagnose and fix the issue. The HP Print and Scan Doctor may not be available in all languages.

If the wireless connection cannot be made, the printer can also be connected to the network using an Ethernet cable.

Solve printer management problems

This section provides solutions to common problems that involve managing the printer.

 **NOTE:** To use the embedded web server, the printer must be connected to a network using either an Ethernet or a wireless connection. You cannot use the embedded web server if the printer is connected to a computer with a USB cable.

 **TIP:** You can visit the HP online support website at www.hp.com/support for information and utilities that can help you correct many common printer problems.

Embedded web server cannot be opened

Check your network setup

- Make sure you are not using a phone cord or a crossover cable to connect the printer to the network.
- Make sure the network cable is securely connected to the printer.
- Make sure the network hub, switch, or router is turned on and working correctly.

Check the computer

- Make sure the computer that you are using is connected to the network.

 **NOTE:** To use the EWS, the printer must be connected to a network. You cannot use the embedded web server if the printer is connected to a computer with a USB cable.

Check your web browser

- Make sure the web browser meets the minimum system requirements. For more information, see system requirements in the Readme file.
- If your web browser uses any proxy settings to connect to the Internet, try turning off these settings. For more information, see the documentation available with your web browser.
- Make sure JavaScript and cookies are enabled in your web browser. For more information, see the documentation available with your web browser.

Check the printer IP address

- To check the IP address of the printer, obtain the IP address by printing a network configuration page. From the printer control panel display, touch  (Wireless), touch **Settings**, and then touch **Print Network Configuration**.
- Ping the printer using the IP address from the command prompt (Windows) or from Network Utility (OS X). (Network Utility is located in the **Utilities** folder in the **Applications** folder at the top level of the hard disk.)

For example, if the IP address is 123.123.123.123, type the following at the command prompt (Windows):

```
C:\>Ping 123.123.123.123
```

Or

In Network Utility (OS X), click the **Ping** tab, type the 123.123.123.123 in the box, and then click **Ping**.

If a reply appears, the IP address is correct. If a time-out response appears, the IP address is incorrect.

 **TIP:** If you are using a computer running Windows, you can visit the HP online support website at www.hp.com/support. This website provides information and utilities that can help you correct many common printer problems.

Printhead maintenance

If you are experiencing problems with printing, you might have a problem with the printhead. You should perform the procedures in the following sections only when directed to do so for resolving print quality issues.

Performing the aligning and cleaning procedures unnecessarily can waste ink and shorten the life of the cartridges.

This section contains the following topics:

- [Clean the printhead](#)
- [Align the printhead](#)
- [Calibrate the linefeed](#)
- [Reinstall the printhead](#)

Clean the printhead

If your printed output is streaked or has any incorrect or missing colors, the printhead might need to be cleaned.

There are two stages of cleaning. Each stage lasts about two minutes, uses one sheet of paper, and uses an increasing amount of ink. After each stage, review the quality of the printed page. You should only initiate the next phase of cleaning if the print quality is poor.

If print quality still seems poor after you complete both stages of cleaning, try aligning the printer. If print quality problems persist after cleaning and aligning, contact HP support. For more information, see [HP support on page 122](#).

 **NOTE:** Cleaning uses ink, so clean the printhead only when necessary. The cleaning process takes a few minutes. Some noise might be generated in the process. Before cleaning the printhead, make sure you load paper. For more information, see [Load paper on page 23](#).

Not turning the printer off correctly can cause print quality problems. For more information, see [Turn the printer off on page 38](#).

To clean the printhead from the control panel

1. Load Letter, A4, or Legal unused plain white paper into the main input tray. For more information, see [Load standard-size paper on page 23](#).
2. From the printer control panel display, touch and slide your finger across the screen and then touch **Setup**.
3. Touch **Tools**, and then touch **Clean Printhead**.

To clean the printhead from Toolbox (Windows)

1. Load Letter, A4, or Legal unused plain white paper into the main input tray. For more information, see [Load standard-size paper on page 23](#).
2. Open Toolbox. For more information, see [Open the Toolbox on page 116](#).
3. From the **Device Services** tab, click the icon to the left of **Clean Printheads**.
4. Follow the on-screen instructions.

To clean the printhead from HP Utility (OS X)

1. Load Letter, A4, or Legal unused plain white paper into the main input tray. For more information, see [Load standard-size paper on page 23](#).
2. Open HP Utility. For more information, see [HP Utility \(OS X\) on page 117](#).
3. In the **Information And Support** section, click **Clean Printheads**.
4. Click **Clean**, and then follow the on-screen instructions.

To clean the printhead from the embedded web server (EWS)

1. Load Letter, A4, or Legal unused plain white paper into the main input tray. For more information, see [Load standard-size paper on page 23](#).
2. Open the EWS. For more information, see [Embedded web server on page 118](#).
3. Click the **Tools** tab, and then click **Print Quality Toolbox** in the **Utilities** section.
4. Click **Clean Printhead** and follow the on-screen instructions.

Align the printhead

The printer automatically aligns the printhead during the initial setup.

You might want to use this feature for print quality issues in printouts where straight lines look wavy or jagged.

To align the printhead from the control panel

1. Load Letter, A4, or Legal unused plain white paper into the main input tray. For more information, see [Load standard-size paper on page 23](#).
2. From the printer control panel display, touch and slide your finger across the screen and then touch **Setup**.
3. Touch **Tools**, and then select **Align Printhead**.

To align the printhead from Toolbox (Windows)

1. Load Letter, A4, or Legal unused plain white paper into the main input tray. For more information, see [Load standard-size paper on page 23](#).
2. Open Toolbox. For more information, see [Open the Toolbox on page 116](#).
3. From the **Device Services** tab, click the icon to the left of **Align Printheads**.
4. Follow the on-screen instructions.

To align the printhead from HP Utility (OS X)

1. Load Letter, A4, or Legal unused plain white paper into the main input tray. For more information, see [Load standard-size paper on page 23](#).
2. Open HP Utility. For more information, see [HP Utility \(OS X\) on page 117](#).
3. In the **Information And Support** section, click **Align Printhead**.
4. Click **Align**, and then follow the on-screen instructions.

To align the printhead from the embedded web server (EWS)

1. Load Letter, A4, or Legal unused plain white paper into the main input tray. For more information, see [Load standard-size paper on page 23](#).
2. Open the EWS. For more information, see [Embedded web server on page 118](#).
3. Click the **Tools** tab, and then click **Print Quality Toolbox** in the **Utilities** section.
4. Click **Align Printer** and follow the on-screen instructions.

Calibrate the linefeed

If you are still seeing streaks and white lines, after aligning the printhead, then calibrate the linefeed.

To calibrate the linefeed from the control panel

1. Load Letter, A4, or Legal unused plain white paper into the main input tray. For more information, see [Load standard-size paper on page 23](#).
2. From the printer control panel display, touch and slide your finger across the screen and then touch **Setup**.
3. Touch **Tools**, and then touch **Calibrate Linefeed**.

To calibrate the linefeed from Toolbox (Windows)

1. Load Letter, A4, or Legal unused plain white paper into the main input tray. For more information, see [Load standard-size paper on page 23](#).
2. Open Toolbox. For more information, see [Open the Toolbox on page 116](#).
3. From the **Device Services** tab, click the icon to the left of **Linefeed Calibration**.
4. Follow the on-screen instructions.

To calibrate the linefeed from the embedded web server (EWS)

1. Load Letter, A4, or Legal unused plain white paper into the main input tray. For more information, see [Load standard-size paper on page 23](#).
2. Open the EWS. For more information, see [Embedded web server on page 118](#).
3. Click the **Tools** tab, and then click **Print Quality Toolbox** in the **Utilities** section.
4. Click **Calibrate Linefeed** and follow the on-screen instructions.

Reinstall the printhead

This procedure should only be performed when a **Missing or Failed Printhead** message has been seen and the printer has first been turned off and then back on to try to resolve the message. If the message persists, try this procedure.

To reinstall the printhead

1. Make sure that the printer is turned on.

2. Open the ink cartridge access door.

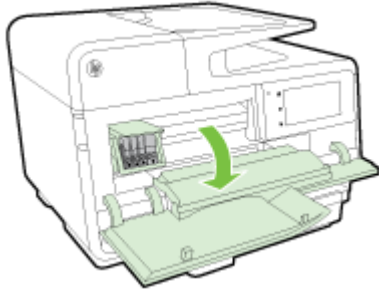

3. Lift the latch handle on the print carriage.

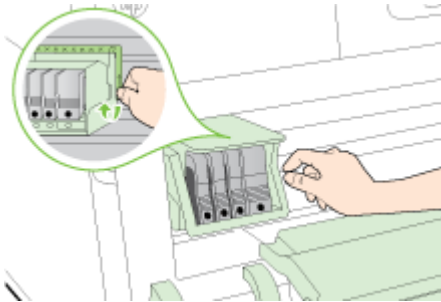

4. Remove the printhead by lifting it up and then pulling it out of the printer.



5. Make sure the latch handle is raised, and then reinsert the printhead.



6. Carefully lower the latch handle.

 **NOTE:** Make sure you lower the latch handle before reinserting the ink cartridges. Leaving the latch handle raised can result in incorrectly seated ink cartridges and problems printing. The latch must remain down in order to correctly install the ink cartridges.

7. Close the ink cartridge access door.

Clear jams

Occasionally, paper becomes jammed during a job.

Paper jams can occur either inside the printer or in the automatic document feeder.

⚠ CAUTION: To prevent possible damage to the printhead, clear paper jams as soon as possible.

💡 TIP: If you notice poor print quality, clean the printhead. For more information, see [Clean the printhead on page 155](#).

- [Clear paper jams inside the printer](#)
- [Clear paper jams in the automatic document feeder](#)
- [Avoid paper jams](#)

Clear paper jams inside the printer

1. Remove all paper from the output tray.

⚠ CAUTION: Trying to clear a paper jam from the front of the printer can damage the print mechanism. Always access and clear paper jams through the automatic two-sided printing accessory (duplexer).

2. Check the duplexer.
 - a. Push the buttons on either side of the duplexer, and then remove the duplexer.

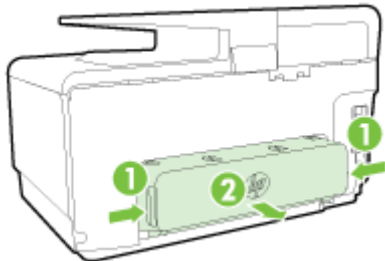

- b. Locate any jammed paper inside the printer, grasp it with both hands, and then pull it towards you.
-
- ⚠ CAUTION:** If the paper tears when you are removing it from the rollers, check the rollers and wheels for torn pieces of paper that might be remaining inside the printer. If you do not remove all the pieces of paper from the printer, more paper jams are likely to occur.
-
- c. If the jam is not there, push the latch on top of the duplexer and lower the cover. If paper is jammed inside, carefully remove it. Close the cover.
 - d. Reinsert the duplexer into the printer until it snaps into place.
3. If you have not found the jam and have Tray 2 installed, pull out the tray and remove the jammed paper, if possible. If not, do the following:
 - a. Ensure the printer is turned off and disconnect the power cord.
 - b. Lift the printer off Tray 2.
 - c. Remove the jammed paper from the bottom of the printer or from Tray 2.
 - d. Reposition the printer on the top of Tray 2.

4. Open the ink cartridge access door. If there is paper remaining inside the printer, ensure the carriage has moved to the right of the printer, free any paper scraps or wrinkled paper, and pull the paper towards you through the top of the printer.

⚠ WARNING! Do not reach into the printer when it is turned on and the carriage is stuck. When you open the ink cartridge access door, the carriage should return to its position on the right side of the printer. If it does not move to the right, turn off the printer before you remove any jam.

5. After clearing the jam, close all covers, turn on the printer (if you turned it off) and resend the print job.

If the above solutions do not resolve the problem, [click here for more online troubleshooting.](#)

Clear paper jams in the automatic document feeder

1. Lift the cover of the automatic document feeder.

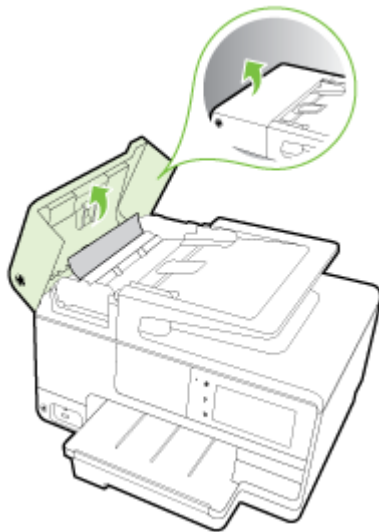

2. Lift the tab located on the front edge of the ADF.

- OR -

Push the green tab located in the center of the automatic document feeder.

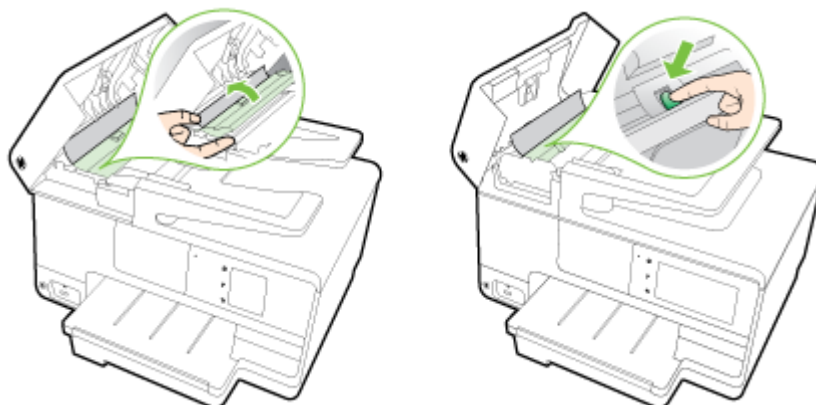

3. Gently pull the paper out of the rollers.

⚠ CAUTION: If the paper tears when you are removing it from the rollers, check the rollers and wheels for torn pieces of paper that might remain inside the printer. If you do not remove all the pieces of paper from the printer, more paper jams are likely to occur.

4. If you have pushed the green tab in step 2, pull it back in place.

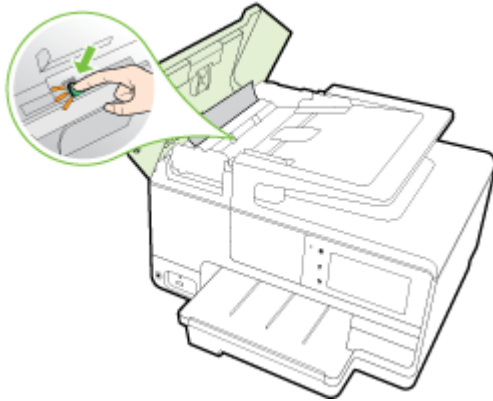

5. Close the cover of the automatic document feeder, pressing down firmly until it snaps into place.

If the above solutions do not resolve the problem, [click here for more online troubleshooting.](#)

Avoid paper jams

To help avoid paper jams, follow these guidelines.

- Remove printed papers from the output tray frequently.
- Make sure that you are printing with paper that is not wrinkled, folded, or damaged.
- Prevent curled or wrinkled paper by storing all unused paper flat in a resealable bag.
- Do not use paper that is too thick or too thin for the printer.
- Make sure that the trays are loaded correctly and are not too full. For more information, see [Load paper on page 23](#).
- Ensure that paper loaded in the input tray lays flat and the edges are not bent or torn.
- Do not place too much paper in the document feeder tray. For information on the maximum number of sheets allowed in the automatic document feeder, see [Paper size and weights on page 166](#).
- Do not combine different paper types and paper sizes in the input tray; the entire stack of paper in the input tray must be the same size and type.
- Adjust the paper-width guides in the input tray to fit snugly against all paper. Make sure the paper-width guides do not bend the paper in the input tray.
- Do not force paper too far forward in the input tray.
- If you are printing on both sides of a page, do not print highly saturated images on light weight paper.
- Use paper types that are recommended for the printer. For more information, see [Paper size and weights on page 166](#).
- If the printer is about to run out of paper, allow the printer to run out of paper first, and then add paper. Do not try to add paper when the printer is trying to pick up a sheet.
- Make sure that the printer is clean. For more information, see [Maintain the printer on page 34](#).

Clear the print carriage

Remove any objects, such as paper, that are blocking the print carriage.

See [Clear jams on page 159](#) for more information.



NOTE: Do not use any tools or other devices to remove jammed paper. Always use caution when removing jammed paper from inside the printer.



[Click here to go online for more information.](#)

A Technical information

This section contains the following topics:

- [Warranty information](#)
- [Specifications](#)
- [Regulatory information](#)
- [Environmental product stewardship program](#)

Warranty information

This section contains the following topics:

- [Ink cartridge warranty information](#)

Ink cartridge warranty information

The HP cartridge warranty is applicable when the product is used in its designated HP printing device. This warranty does not cover HP ink products that have been refilled, remanufactured, refurbished, misused, or tampered with.

During the warranty period the product is covered as long as the HP ink is not depleted and the end of warranty date has not been reached. The end of warranty date, in YYYY-MM format, may be found on the product as indicated:

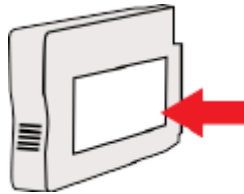

Specifications

For more information, visit www.hp.com/support. Select your country or region. Click **Product Support & Troubleshooting**. Enter the name shown on the front of the printer, and then select **Search**. Click **Product information**, and then click **Product specifications**.

- [System requirements](#)
- [Environmental specifications](#)
- [Input tray capacity](#)
- [Output tray capacity](#)
- [Paper size and weights](#)
- [Print specifications](#)
- [Copy specifications](#)
- [Scan specifications](#)
- [Fax specifications](#)
- [Cartridge yield](#)
- [Acoustic emission specifications](#)

System requirements

Software and system requirements can be found in the Readme file, which is available on the HP printer software CD provided with your printer.

For information about future operating system releases and support, visit the HP online support website at www.hp.com/support.

Environmental specifications

Operating temperature: 5° to 40° C (41° to 104° F)

Operating humidity: 15 to 80% RH non-condensing

Recommended operating conditions: 15° to 32° C (59° to 90° F)

Recommended relative humidity: 20 to 80% noncondensing

Input tray capacity

- **Main input tray**

Plain paper sheets: Up to 250

Envelopes: Up to 30

Index cards: Up to 80

Photo paper sheets: Up to 100

- **Tray 2**

Plain paper sheets (60 to 105 g/m² [16 to 28 lb]): Up to 250

 **NOTE:** Tray 2 supports only plain paper.

Output tray capacity

- Plain paper sheets: Up to 150
- Envelopes: Up to 30
- Index cards: Up to 80
- Photo paper sheets: Up to 100

Paper size and weights

For the list of supported paper sizes, see the HP printer software.

- Plain paper: 60 to 105 g/m² (16 to 28 lb)
- Envelopes: 75 to 90 g/m² (20 to 24 lb)
- Cards: Up to 200 g/m² (110-lb index maximum)
- Photo paper: 280 g/m² (75 lb)

Print specifications

- Print speeds vary according to the complexity of the document and printer model
- Method: drop-on-demand thermal officejet
- Language: PCL3 GUI
- Print resolution:

Draft mode	<ul style="list-style-type: none">• Color Input/Black Render: 300x300dpi• Output (Black/Color): Automatic
Normal mode	<ul style="list-style-type: none">• Color Input/Black Render: 600x600dpi• Output (Black/Color): Automatic
Plain-Best mode	<ul style="list-style-type: none">• Color Input/Black Render: 600x600dpi• Output (Black/Color): Automatic
Photo-Best mode	<ul style="list-style-type: none">• Color Input/Black Render: 600x600dpi• Output (Black/Color): Automatic
Max DPI mode	<ul style="list-style-type: none">• Color Input/Black Render: 1200x1200dpi• Output: Automatic (Black), 4800x1200 optimized dpi (Color)

Copy specifications

- Digital image processing
- Copy speeds vary according to the complexity of the document and printer model

Scan specifications

- Resolution: Up to 1200 x 1200 ppi optical

For more information about scan resolution, see the HP printer software.

- Color: 24-bit color, 8-bit grayscale (256 levels of gray)

- Maximum scan size from scanner glass:
 - U.S. Letter (A): 215.9 x 279.4 mm (8.5 inches x 11 inches)
 - U.S. Legal (HP Officejet Pro 8620 and HP Officejet Pro 8630 only): 215.9 x 355.6 mm (8.5 inches x 14 inches)
 - ISO A4: 210 x 297mm (8.27 inches x 11.7 inches)
- Maximum scan size from ADF:
 - ADF: 216 x 356 mm (8.5 x 14 inches)

Fax specifications

- Walk-up black-and-white and color fax capability.
- Up to 99 speed dials.
- Up to 100-page memory (based on ITU-T Test Image #1 at standard resolution). More complicated pages or higher resolution takes longer and uses more memory.
- Manual fax send and receive.
- Automatic busy redial up to five times (varies by model).
- Automatic no-answer redial one time (varies by model).
- Confirmation and activity reports.
- CCITT/ITU Group 3 fax with Error Correction Mode.
- 33.6 Kbps transmission.
- 4 seconds per page speed at 33.6 Kbps (based on ITU-T Test Image #1 at standard resolution). More complicated pages or higher resolution takes longer and uses more memory.
- Ring detect with automatic fax/answering machine switching.

	Photo (dpi)	Very Fine (dpi)	Fine (dpi)	Standard (dpi)
Black	205 x 196 (8-bit grayscale)	308 x 300	205 x 196	205 x 98
Color	205 x 200	205 x 200	205 x 200	205 x 200

HP Digital Fax Specifications

- Supported file type: Uncompressed TIFF
- Supported fax types: black-and-white faxes

Cartridge yield

Visit www.hp.com/go/learnaboutequipment/ for more information on estimated cartridge yields.

Acoustic emission specifications

Visit www.hp.com/support. Select your country or region. Click **Product Support & Troubleshooting**. Enter the name shown on the front of the printer, and then select **Search**. Click **Product information**, and then click **Product specifications**.

- Sound pressure (bystander position)

- LpAm 55 (dBA) (mono Draft print)
- Sound power
 - LwAd 6.8 (BA)

Regulatory information

The printer meets product requirements from regulatory agencies in your country/region.

This section contains the following topics:

- [Regulatory Model Number](#)
- [FCC statement](#)
- [Notice to users in Korea](#)
- [VCCI \(Class B\) compliance statement for users in Japan](#)
- [Notice to users in Japan about the power cord](#)
- [Noise emission statement for Germany](#)
- [Visual display workplaces statement for Germany](#)
- [Notice to users of the U.S. telephone network: FCC requirements](#)
- [Notice to users of the Canadian telephone network](#)
- [Notice to users in the European Economic Area](#)
- [Notice to users of the German telephone network](#)
- [Australia wired fax statement](#)
- [European Union Regulatory Notice](#)
- [Declaration of conformity](#)
- [Regulatory information for wireless products](#)

Regulatory Model Number

For regulatory identification purposes, your product is assigned a Regulatory Model Number. The Regulatory Model Number for your product is SNPRC-1401-02. This regulatory number should not be confused with the marketing name (HP Officejet Pro 8610 e-All-in-One, HP Officejet Pro 8620 e-All-in-One, and HP Officejet Pro 8630 e-All-in-One) or product number (A7F64A, A7F65A, or A7F66A).



NOTE: The printer availability varies by country or region.

FCC statement

FCC statement

The United States Federal Communications Commission (in 47 CFR 15.105) has specified that the following notice be brought to the attention of users of this product.

This equipment has been tested and found to comply with the limits for a Class B digital device, pursuant to Part 15 of the FCC Rules. These limits are designed to provide reasonable protection against harmful interference in a residential installation. This equipment generates, uses and can radiate radio frequency energy and, if not installed and used in accordance with the instructions, may cause harmful interference to radio communications. However, there is no guarantee that interference will not occur in a particular installation. If this equipment does cause harmful interference to radio or television reception, which can be determined by turning the equipment off and on, the user is encouraged to try to correct the interference by one or more of the following measures:

- Reorient or relocate the receiving antenna.
- Increase the separation between the equipment and the receiver.
- Connect the equipment into an outlet on a circuit different from that to which the receiver is connected.
- Consult the dealer or an experienced radio/TV technician for help.

For further information, contact:

Manager of Corporate Product Regulations
Hewlett-Packard Company
3000 Hanover Street
Palo Alto, Ca 94304
(650) 857-1501

Modifications (part 15.21)

The FCC requires the user to be notified that any changes or modifications made to this device that are not expressly approved by HP may void the user's authority to operate the equipment.

This device complies with Part 15 of the FCC Rules. Operation is subject to the following two conditions: (1) this device may not cause harmful interference, and (2) this device must accept any interference received, including interference that may cause undesired operation.

Notice to users in Korea

B 급 기기 (가정용 방송통신기기)	이 기기는 가정용(B급)으로 전자파적합등록을 한 기기로서 주로 가정에서 사용하는 것을 목적으로 하며, 모든 지역에서 사용할 수 있습니다.
------------------------	--

VCCI (Class B) compliance statement for users in Japan

この装置は、クラスB情報技術装置です。この装置は、家庭環境で使用することを目的としていますが、この装置がラジオやテレビジョン受信機に近接して使用されると、受信障害を引き起こすことがあります。取扱説明書に従って正しい取り扱いをして下さい。

VCCI-B

Notice to users in Japan about the power cord

製品には、同梱された電源コードをお使い下さい。
同梱された電源コードは、他の製品では使用出来ません。

Noise emission statement for Germany

Geräuschemission

LpA < 70 dB am Arbeitsplatz im Normalbetrieb nach DIN 45635 T. 19

Visual display workplaces statement for Germany

GS-Erklärung (Deutschland)

Das Gerät ist nicht für die Benutzung im unmittelbaren Gesichtsfeld am Bildschirmarbeitsplatz vorgesehen. Um störende Reflexionen am Bildschirmarbeitsplatz zu vermeiden, darf dieses Produkt nicht im unmittelbaren Gesichtsfeld platziert werden.

Notice to users of the U.S. telephone network: FCC requirements

Notice to users of the U.S Telephone network: FCC requirements

This equipment complies with Part 68 of the FCC rules and the requirements adopted by the ACTA. On the rear (or bottom) of this equipment is a label that contains, among other information, a product identifier in the format US:AAAEQ##TXXXX. If requested, this number must be provided to the telephone company.

Applicable connector jack Universal Service Order Codes ("USOC") for the Equipment is: RJ-11C.

A plug and jack used to connect this equipment to the premises wiring and telephone network must comply with the applicable FCC Part 68 rules and requirements adopted by the ACTA. A compliant telephone cord and modular plug is provided with this product. It is designed to be connected to a compatible modular jack that is also compliant. See installation instructions for details.

The REN is used to determine the number of devices that may be connected to a telephone line. Excessive RENs on a telephone line may result in the devices not ringing in response to an incoming call. In most but not all areas, the sum of RENs should not exceed five (5.0). To be certain of the number of devices that may be connected to a line, as determined by the total RENs, contact the local telephone company. For products approved after July 23, 2001, the REN for this product is part of the product identifier that has the format US:AAAEQ##TXXXX. The digits represented by ## are the REN without a decimal point (e.g., 00 is a REN of 0.0).

If this equipment causes harm to the telephone network, the telephone company will notify you in advance that temporary discontinuance of service may be required. But if advance notice isn't practical, the telephone company will notify the customer as soon as possible. Also, you will be advised of your right to file a complaint with the FCC if you believe it is necessary.

The telephone company may make changes in its facilities, equipment, operations or procedures that could affect the operation of the equipment. If this happens the telephone company will provide advance notice in order for you to make necessary modifications to maintain uninterrupted service.

If trouble is experienced with this equipment, please contact the manufacturer, or look elsewhere in this manual, for repair or warranty information. If the equipment is causing harm to the telephone network, the telephone company may request that you disconnect the equipment until the problem is resolved.

Connection to party line service is subject to state tariffs. Contact the state public utility commission, public service commission or corporation commission for information.

If your home has specially wired alarm equipment connected to the telephone line, ensure the installation of this equipment does not disable your alarm equipment. If you have questions about what will disable alarm equipment, consult your telephone company or a qualified installer.

WHEN PROGRAMMING EMERGENCY NUMBERS AND/OR MAKING TEST CALLS TO EMERGENCY NUMBERS:

- 1) Remain on the line and briefly explain to the dispatcher the reason for the call.
- 2) Perform such activities in the off-peak hours, such as early morning or late evenings.



Note The FCC hearing aid compatibility rules for telephones are not applicable to this equipment.

The Telephone Consumer Protection Act of 1991 makes it unlawful for any person to use a computer or other electronic device, including FAX machines, to send any message unless such message clearly contains in a margin at the top or bottom of each transmitted page or on the first page of the transmission, the date and time it is sent and an identification of the business or other entity, or other individual sending the message and the telephone number of the sending machine or such business, other entity, or individual. (The telephone number provided may not be a 900 number or any other number for which charges exceed local or long-distance transmission charges.)

In order to program this information into your FAX machine, you should complete the steps described in the software.

Notice to users of the Canadian telephone network

Note à l'attention des utilisateurs du réseau téléphonique canadien/Notice to users of the Canadian telephone network

Cet appareil est conforme aux spécifications techniques des équipements terminaux d'Industrie Canada. Le numéro d'enregistrement atteste de la conformité de l'appareil. L'abréviation IC qui précède le numéro d'enregistrement indique que l'enregistrement a été effectué dans le cadre d'une Déclaration de conformité stipulant que les spécifications techniques d'Industrie Canada ont été respectées. Néanmoins, cette abréviation ne signifie en aucun cas que l'appareil a été validé par Industrie Canada.

Pour leur propre sécurité, les utilisateurs doivent s'assurer que les prises électriques reliées à la terre de la source d'alimentation, des lignes téléphoniques et du circuit métallique d'alimentation en eau sont, le cas échéant, branchées les unes aux autres. Cette précaution est particulièrement importante dans les zones rurales.



Remarque Le numéro REN (Ringer Equivalence Number) attribué à chaque appareil terminal fournit une indication sur le nombre maximal de terminaux qui peuvent être connectés à une interface téléphonique. La terminaison d'une interface peut se composer de n'importe quelle combinaison d'appareils, à condition que le total des numéros REN ne dépasse pas 5.

Basé sur les résultats de tests FCC Partie 68, le numéro REN de ce produit est 0.0B.

This equipment meets the applicable Industry Canada Terminal Equipment Technical Specifications. This is confirmed by the registration number. The abbreviation IC before the registration number signifies that registration was performed based on a Declaration of Conformity indicating that Industry Canada technical specifications were met. It does not imply that Industry Canada approved the equipment.

Users should ensure for their own protection that the electrical ground connections of the power utility, telephone lines and internal metallic water pipe system, if present, are connected together. This precaution might be particularly important in rural areas.



Note The REN (Ringer Equivalence Number) assigned to each terminal device provides an indication of the maximum number of terminals allowed to be connected to a telephone interface. The termination on an interface might consist of any combination of devices subject only to the requirement that the sum of the Ringer Equivalence Numbers of all the devices does not exceed 5.

The REN for this product is 0.0B, based on FCC Part 68 test results.

Notice to users in the European Economic Area

Notice to users in the European Economic Area

This product is designed to be connected to the analog Switched Telecommunication Networks (PSTN) of the European Economic Area (EEA) countries/regions.

Network compatibility depends on customer selected settings, which must be reset to use the equipment on a telephone network in a country/region other than where the product was purchased. Contact the vendor or Hewlett-Packard Company if additional product support is necessary.

This equipment has been certified by the manufacturer in accordance with Directive 1999/5/EC (annex II) for Pan-European single-terminal connection to the public switched telephone network (PSTN). However, due to differences between the individual PSTNs provided in different countries, the approval does not, of itself, give an unconditional assurance of successful operation on every PSTN network termination point.

In the event of problems, you should contact your equipment supplier in the first instance.

This equipment is designed for DTMF tone dialing and loop disconnect dialing. In the unlikely event of problems with loop disconnect dialing, it is recommended to use this equipment only with the DTMF tone dial setting.

Notice to users of the German telephone network

Hinweis für Benutzer des deutschen Telefonnetzwerks

Dieses HP-Fax ist nur für den Anschluss eines analogen Public Switched Telephone Network (PSTN) gedacht. Schließen Sie den TAE N-Telefonstecker, der im Lieferumfang des HP All-in-One enthalten ist, an die Wandsteckdose (TAE 6) Code N an. Dieses HP-Fax kann als einzelnes Gerät und/oder in Verbindung (mit seriellen Anschluss) mit anderen zugelassenen Endgeräten verwendet werden.

Australia wired fax statement

In Australia, the HP device must be connected to Telecommunication Network through a line cord which meets the requirements of the Technical Standard AS/ACIF S008.

European Union Regulatory Notice



Products bearing the CE marking comply with one or more of the following EU Directives as may be applicable: Low Voltage Directive 2006/95/EC, EMC Directive 2004/108/EC, Ecodesign Directive 2009/125/EC, R&TTE Directive 1999/5/EC, RoHS Directive 2011/65/EU. Compliance with these directives is assessed using applicable European Harmonised Standards. The full Declaration of Conformity can be found at the following website: www.hp.com/go/certificates (Search with the product model name or its Regulatory Model Number (RMN), which may be found on the regulatory label.)

The point of contact for regulatory matters is:

Hewlett-Packard GmbH, Dept./MS: HQ-TRE, Herrenberger Strasse 140, 71034 Boeblingen, GERMANY

Products with external AC Adapters

CE compliance of this product is valid only if powered with the correct CE-marked AC adapter provided by HP.

Products with wireless functionality

EMF

- This product meets international guidelines (ICNIRP) for exposure to radio frequency radiation.

If it incorporates a radio transmitting and receiving device then in normal use, a separation distance of 20 cm ensures that radio frequency exposure levels comply with EU requirements.

Wireless functionality in Europe

- This product is designed for use without restrictions in all EU countries plus Iceland, Liechtenstein, Norway and Switzerland.

European telephone network declaration (Modem/Fax)

HP products with FAX capability comply with the requirements of the R&TTE Directive 1999/5/EC (Annex II) and carry the CE marking accordingly. However, due to differences between the individual PSTNs provided in different countries/regions, the approval does not, of itself, give an unconditional assurance of successful operation on every PSTN network termination point. In the event of problems, you should contact your equipment supplier in the first instance.

Declaration of conformity



DECLARATION OF CONFORMITY

according to ISO/IEC 17050-1 and EN 17050-1

DoC #: SNPRC-1401-02-R3

Supplier's Name: Hewlett-Packard Company
Supplier's Address: 138 Depot Road, #04-01, Singapore 109683

declares, that the product
Product Name and Model: HP Officejet Pro 8610 / 8620 / 8630 e-All-in-One Printer
Regulatory Model Number:¹⁾ SNPRC-1401-02
Product Options: All
Power Adapter: CM751-60190 (WW) / CM751-60046 [For China and India only]
Radio Module Number: SDGQB-1292

conforms to the following Product Specifications and Regulations:

EMC: CISPR22:2008 / EN55022:2010 Class B
CISPR24:2010 / EN55024:2010
EN 61000-3-2:2006+A1:2009+A2:2009
EN 61000-3-3:2008
FCC CFR 47, Part 15 / ICES - 003, Issue 5

Safety: IEC 60950-1:2005 (2nd Edition) +A1:2009
EN 60950-1:2006 +A1 1:2009 +A1:2010 +A1 2:2011
EN 62479:2010

Telecom: EN 301 489-1 V1.9.2:2011 / EN 301 489-17 V2.1.1:2009
EN 300 328 V1.7.1:2006
EN 62311:2008
FCC Rules and Regulations 47 CFR Part 68
TIA-968-B Telecommunications - Telephone Terminal Equipment Technical Requirements for Connection of Terminal Equipment to the Telephone Network (Sep 2009)
ES 203 021-2/-3 V2.1.2
CS - 03, Part 1, Issue 9, Amendment 4, December 2010

Energy: Regulation (EC) No. 1275/2008
ENERGY STAR® Qualified Imaging Equipment Operational Mode (OM) Test Procedure
Test Method for Calculating the Energy Efficiency of Single-Voltage External Ac-Dc and Ac-Ac Power Supplies (August 11, 2004)

RoHS: EN 50581: 2012

The product herewith complies with the requirements of the Low Voltage Directive 2006/95/EC, the EMC Directive 2004/108/EC, the R&TTE Directive 1999/5/EC, the Ecodesign Directive 2009/125/EC, RoHS Directive 2011/65/EU, and carries the **CE** marking accordingly.

This device complies with part 15 of the FCC Rules. Operation is subject to the following two conditions:
(1) This device may not cause harmful interference, and (2) this device must accept any interference received, including interference that may cause undesired operation.

Additional information:

- 1) This product is assigned a Regulatory Model Number which stays with the regulatory aspects of the design. The Regulatory Model Number is the main product identifier in the regulatory documentation and test reports, this number should not be confused with the marketing name or the product numbers.
- 2) The product was tested in a typical configuration.
- 3) The internal power adapter CM751-60046 is for India and China market only.
- 4) WiFi module operates only in 2.4 GHz band within this product.

Singapore
31 Oct 2013

Hou-Meng Yik, Manager
Product Regulations Manager
TCE & Q Injet Business and Platform

Local contact for regulatory topics only:

EU: Hewlett-Packard GmbH, HQ-TRE, Hertenberger Strasse 140, 71034 Boeblingen, Germany
U.S.: Hewlett-Packard, 3000 Hanover St., Palo Alto, CA 94304, U.S.A. 650-857-1501

www.hp.eu/certificates

Regulatory information for wireless products

This section contains the following regulatory information pertaining to wireless products:

- [Exposure to radio frequency radiation](#)
- [Notice to users in Brazil](#)
- [Notice to users in Canada](#)

- [Notice to users in Taiwan](#)
- [Notice to users in Mexico](#)
- [Wireless notice to users in Japan](#)

Exposure to radio frequency radiation

Exposure to radio frequency radiation



Caution The radiated output power of this device is far below the FCC radio frequency exposure limits. Nevertheless, the device shall be used in such a manner that the potential for human contact during normal operation is minimized. This product and any attached external antenna, if supported, shall be placed in such a manner to minimize the potential for human contact during normal operation. In order to avoid the possibility of exceeding the FCC radio frequency exposure limits, human proximity to the antenna shall not be less than 20 cm (8 inches) during normal operation.

Notice to users in Brazil

Aviso aos usuários no Brasil

Este equipamento opera em caráter secundário, isto é, não tem direito à proteção contra interferência prejudicial, mesmo de estações do mesmo tipo, e não pode causar interferência a sistemas operando em caráter primário. (Res.ANATEL 282/2001).

Notice to users in Canada

Notice to users in Canada/Note à l'attention des utilisateurs canadiens

Under Industry Canada regulations, this radio transmitter may only operate using an antenna of a type and maximum (or lesser) gain approved for the transmitter by Industry Canada. To reduce potential radio interference to other users, the antenna type and its gain should be so chosen that the equivalent isotropically radiated power (e.i.r.p.) is not more than that necessary for successful communication.

This device complies with Industry Canada licence-exempt RSS standard(s). Operation is subject to the following two conditions: (1) this device may not cause interference, and (2) this device must accept any interference, including interference that may cause undesired operation of the device.

WARNING! Exposure to Radio Frequency Radiation The radiated output power of this device is below the Industry Canada radio frequency exposure limits. Nevertheless, the device should be used in such a manner that the potential for human contact is minimized during normal operation.

To avoid the possibility of exceeding the Industry Canada radio frequency exposure limits, human proximity to the antennas should not be less than 20 cm (8 inches).

Conformément au Règlement d'Industrie Canada, cet émetteur radioélectrique ne peut fonctionner qu'avec une antenne d'un type et d'un gain maximum (ou moindre) approuvé par Industrie Canada. Afin de réduire le brouillage radioélectrique potentiel pour d'autres utilisateurs, le type d'antenne et son gain doivent être choisis de manière à ce que la puissance isotrope rayonnée équivalente (p.i.r.e.) ne dépasse pas celle nécessaire à une communication réussie.

Cet appareil est conforme aux normes RSS exemptes de licence d'Industrie Canada. Son fonctionnement dépend des deux conditions suivantes : (1) cet appareil ne doit pas provoquer d'interférences nuisibles et (2) doit accepter toutes interférences reçues, y compris des interférences pouvant provoquer un fonctionnement non souhaité de l'appareil.

AVERTISSEMENT relatif à l'exposition aux radiofréquences. La puissance de rayonnement de cet appareil se trouve sous les limites d'exposition de radiofréquences d'Industrie Canada. Néanmoins, cet appareil doit être utilisé de telle sorte qu'il soit mis en contact le moins possible avec le corps humain.

Afin d'éviter le dépassement éventuel des limites d'exposition aux radiofréquences d'Industrie Canada, il est recommandé de maintenir une distance de plus de 20 cm entre les antennes et l'utilisateur.

Notice to users in Taiwan

低功率電波輻射性電機管理辦法

第十二條

經型式認證合格之低功率射頻電機，非經許可，公司、商號或使用者均不得擅自變更頻率、加大功率或變更設計之特性及功能。

第十四條

低功率射頻電機之使用不得影響飛航安全及干擾合法通信；經發現有干擾現象時，應立即停用，並改善至無干擾時方得繼續使用。

前項合法通信，指依電信法規定作業之無線電通信。低功率射頻電機須忍受合法通信或工業、科學及醫藥用電波輻射性電機設備之干擾。

Notice to users in Mexico

Aviso para los usuarios de México

La operación de este equipo está sujeta a las siguientes dos condiciones: (1) es posible que este equipo o dispositivo no cause interferencia perjudicial y (2) este equipo o dispositivo debe aceptar cualquier interferencia, incluyendo la que pueda causar su operación no deseada.

Para saber el modelo de la tarjeta inalámbrica utilizada, revise la etiqueta regulatoria de la impresora.

Wireless notice to users in Japan

この機器は技術基準適合証明又は工事設計認証を受けた無線設備を搭載しています。

Environmental product stewardship program

Hewlett-Packard is committed to providing quality products in an environmentally sustainable manner:

- Design for recycling has been incorporated into this product.
- The number of materials has been kept to a minimum while ensuring proper functionality and reliability.
- Dissimilar materials have been designed to separate easily.
- Fasteners and other connections are easy to locate, access, and remove using common tools.
- High priority parts have been designed to access quickly for efficient disassembly and repair.

For more information, visit www.hp.com/ecosolutions

This section contains the following topics:

- [Paper use](#)
- [Plastics](#)
- [Material safety data sheets](#)
- [Recycling program](#)
- [HP inkjet supplies recycling program](#)
- [Disposal of waste equipment by users](#)
- [Power consumption](#)
- [Chemical substances](#)
- [Battery disposal in the Netherlands](#)
- [Battery disposal in the Taiwan](#)
- [California Perchlorate Material Notice](#)
- [Toxic and hazardous substance table \(China\)](#)
- [Restriction of hazardous substance \(Ukraine\)](#)
- [Restriction of hazardous substance \(India\)](#)
- [EPEAT](#)
- [China SEPA Ecolabel User Information](#)

Paper use

This product is suited for the use of recycled paper according to DIN 19309 and EN 12281:2002.

Plastics

Plastic parts over 25 grams are marked according to international standards that enhance the ability to identify plastics for recycling purposes at the end of product life.

Material safety data sheets

Material safety data sheets (MSDS) can be obtained from the HP website at:

www.hp.com/go/msds

Recycling program

HP offers an increasing number of product return and recycling programs in many countries/regions, and partners with some of the largest electronic recycling centers throughout the world. HP conserves resources by reselling some of its most popular products. For more information regarding recycling of HP products, please visit:

www.hp.com/recycle

HP inkjet supplies recycling program

HP is committed to protecting the environment. The HP Inkjet Supplies Recycling Program is available in many countries/regions, and lets you recycle used print cartridges and ink cartridges free of charge. For more information, go to the following website:

www.hp.com/hpinfo/globalcitizenship/environment/recycle/

Disposal of waste equipment by users



This symbol means do not dispose of your product with your other household waste. Instead, you should protect human health and the environment by handing over your waste equipment to a designated collection point for the recycling of waste electrical and electronic equipment. For more information, please contact your household waste disposal service, or go to <http://www.hp.com/recycle>.

Power consumption

Hewlett-Packard printing and imaging equipment marked with the ENERGY STAR® logo is qualified to the U.S. Environmental Protection Agency's ENERGY STAR specifications for imaging equipment. The following mark will appear on ENERGY STAR qualified imaging products:



Additional ENERGY STAR qualified imaging product model information is listed at: www.hp.com/go/energystar

Chemical substances

HP is committed to providing our customers with information about the chemical substances in our products as needed to comply with legal requirements such as REACH (*Regulation EC No 1907/2006 of the European Parliament and the Council*). A chemical information report for this product can be found at: www.hp.com/go/reach.

Battery disposal in the Netherlands

(NL) Batterij niet weggoien, maar inleveren als KCA.



Dit HP Product bevat een lithium-manganees-dioxide batterij. Deze bevindt zich op de hoofdprintplaat. Wanneer deze batterij leeg is, moet deze volgens de geldende regels worden afgevoerd.

Battery disposal in the Taiwan



廢電池請回收

Please recycle waste batteries.

California Perchlorate Material Notice

California Perchlorate Material Notice

Perchlorate material - special handling may apply. See: <http://www.dtsc.ca.gov/hazardouswaste/perchlorate/>

This product's real-time clock battery or coin cell battery may contain perchlorate and may require special handling when recycled or disposed of in California.

Toxic and hazardous substance table (China)

零件描述	有毒有害物質和元素					
	鉛	汞	鎘	六價鉻	多環芳烴	多環芳烴類
外殼和托盤*	0	0	0	0	0	0
電線*	0	0	0	0	0	0
印刷電路板*	X	0	0	0	0	0
打印系統*	X	0	0	0	0	0
顯示器*	X	0	0	0	0	0
噴墨打印機墨盒*	0	0	0	0	0	0
驅動光盤*	X	0	0	0	0	0
掃描儀*	X	X	0	0	0	0
兩棲配件*	X	0	0	0	0	0
電池板*	X	0	0	0	0	0
自動雙面打印系統*	0	0	0	0	0	0
外部電源*	X	0	0	0	0	0

0: 指此零件的所有均一材質中包含的這種有毒有害物質，含量低於SJ/T11363-2006 的限制
 X: 指此零件使用的均一材質中至少有一種包含的這種有毒有害物質，含量高於SJ/T11363-2006 的限制
 注：環保使用期限的參考標識取決於產品正常工作的溫度和濕度等條件
 *以上只適用於使用這些零件的產品

Restriction of hazardous substance (Ukraine)

Технічний регламент щодо обмеження використання небезпечних речовин (Україна)

Обладнання відповідає вимогам Технічного регламенту щодо обмеження використання деяких небезпечних речовин в електричному та електронному обладнанні, затвердженого постановою Кабінету Міністрів України від 3 грудня 2008 № 1057

Restriction of hazardous substance (India)

Restriction of hazardous substances (India)

This product complies with the "India E-waste (Management and Handling) Rule 2011" and prohibits use of lead, mercury, hexavalent chromium, polybrominated biphenyls or polybrominated diphenyl ethers in concentrations exceeding 0.1 weight % and 0.01 weight % for cadmium, except for the exemptions set in Schedule 2 of the Rule.

EPEAT

EPEAT

Most HP products are designed to meet EPEAT. EPEAT is a comprehensive environmental rating that helps identify greener electronics equipment. For more information on EPEAT go to www.epeat.net. For information on HP's EPEAT registered products go to www.hp.com/hpinfo/globalcitizenship/environment/pdf/epeat_printers.pdf.

China SEPA Ecolabel User Information

中国环境标识认证产品用户说明

噪声大于63.0Db(A)的办公设备不宜放置于办公室内。请在独立的隔离区域使用。

如需长时间使用本产品或打印大量文件，请确保在通风良好的房间内使用。

如您需要确认本产品处于零能耗状态，请按下电源关闭按钮，并将插头从电源插座断开。

您可以使用再生纸，以减少资源耗费。

B Additional fax setup

After completing all the steps in the getting started guide, use the instructions in this section to complete your fax setup. Keep your getting started guide for later use.

In this section, you learn how to set up the printer so that faxing works successfully with equipment and services you might already have on the same phone line.

 **TIP:** You can also use the Fax Setup Wizard (Windows) or HP Utility (OS X) to help you quickly set up some important fax settings such as the answer mode and fax header information. You can access these tools through the HP software you installed with the printer. After you run these tools, follow the procedures in this section to complete your fax setup.

This section contains the following topics:

- [Set up faxing \(parallel phone systems\)](#)
- [Serial-type fax setup](#)
- [Test fax setup](#)

Set up faxing (parallel phone systems)

Before you begin setting up the printer for faxing, determine which kind of phone system your country/region uses. The instructions for fax setup differ depending on whether you have a serial- or parallel-type phone system.

- If you do not see your country/region listed in the table, you probably have a serial-type phone system. In a serial-type phone system, the connector type on your shared telephone equipment (modems, phones, and answering machines) does not allow a physical connection to the "2-EXT" port on the printer. Instead, all equipment must be connected at the telephone wall jack.

 **NOTE:** In some countries/regions that use serial-type phone systems, the phone cord that came with the printer might have an additional wall plug attached to it. This enables you to connect other telecom devices to the wall jack where you plug in the printer.

You might need to connect the supplied phone cord to the adapter provided for your country/region.

- If your country/region is listed in the table, you probably have a parallel-type telephone system. In a parallel-type phone system, you are able to connect shared telephone equipment to the phone line by using the "2-EXT" port on the back of the printer.

 **NOTE:** If you have a parallel-type phone system, HP recommends you use the 2-wire phone cord supplied with the printer to connect it to the telephone wall jack.

Table B-1 Countries/regions with a parallel-type phone system

Argentina	Australia	Brazil
Canada	Chile	China
Colombia	Greece	India
Indonesia	Ireland	Japan
Korea	Latin America	Malaysia
Mexico	Philippines	Poland
Portugal	Russia	Saudi Arabia
Singapore	Spain	Taiwan
Thailand	USA	Venezuela
Vietnam		

If you are unsure which kind of telephone system you have (serial or parallel), check with your telephone company.

This section contains the following topics:

- [Select the correct fax setup for your home or office](#)
- [Case A: Separate fax line \(no voice calls received\)](#)
- [Case B: Set up the printer with DSL](#)
- [Case C: Set up the printer with a PBX phone system or an ISDN line](#)
- [Case D: Fax with a distinctive ring service on the same line](#)
- [Case E: Shared voice/fax line](#)

- [Case F: Shared voice/fax line with voice mail](#)
- [Case G: Fax line shared with computer modem \(no voice calls received\)](#)
- [Case H: Shared voice/fax line with computer modem](#)
- [Case I: Shared voice/fax line with answering machine](#)
- [Case J: Shared voice/fax line with computer modem and answering machine](#)
- [Case K: Shared voice/fax line with computer dial-up modem and voice mail](#)

Select the correct fax setup for your home or office

To fax successfully, you need to know what types of equipment and services (if any) share the same phone line with the printer. This is important because you might need to connect some of your existing office equipment directly to the printer, and you might also need to change some fax settings before you can fax successfully.

1. Determine if your telephone system is serial or parallel.

For more information, see [Set up faxing \(parallel phone systems\) on page 182](#).

- a. Serial-type telephone system—See [Serial-type fax setup on page 203](#).
 - b. Parallel-type telephone system—Go to step 2.
2. Select the combination of equipment and services sharing your fax line.
 - DSL: A Digital subscriber line (DSL) service through your telephone company. (DSL might be called ADSL in your country/region.)
 - PBX: A private branch exchange (PBX) phone system or an integrated services digital network (ISDN) system.
 - Distinctive ring service: A distinctive ring service through your telephone company provides multiple telephone numbers with different ring patterns.
 - Voice calls: Voice calls are received at the same phone number you use for fax calls on the printer.
 - Computer dial-up modem: A computer dial-up modem is on the same phone line as the printer. If you answer Yes to any of the following questions, you are using a computer dial-up modem:
 - Do you send and receive faxes directly to and from your computer software applications through a dial-up connection?
 - Do you send and receive email messages on your computer through a dial-up connection?
 - Do you access the Internet from your computer through a dial-up connection?
 - Answering machine: An answering machine that answers voice calls at the same phone number you use for fax calls on the printer.
 - Voice mail service: A voice mail subscription through your telephone company at the same number you use for fax calls on the printer.
 3. From the following table, select the combination of equipment and services applicable to your home or office setting. Then look up the recommended fax setup. Step-by-step instructions are included for each case in the sections that follow.



NOTE: If your home or office setup is not described in this section, set up the printer as you would a regular analog phone. Make sure you use the phone cord supplied in the box to connect one end to your telephone wall jack and the other end to the port labeled 1-LINE on the back of the printer. If you use another phone cord, you might experience problems sending and receiving faxes.

You might need to connect the supplied phone cord to the adapter provided for your country/region.

Other equipment or services sharing your fax line						Recommended fax setup
DSL	PBX	Distinctive ring service	Voice calls	Computer dial-up modem	Answering machine	Voice mail service
✓						
	✓					
		✓				
			✓			
			✓			✓
				✓		
			✓	✓		
			✓		✓	
			✓	✓	✓	
			✓	✓		✓

Case A: Separate fax line (no voice calls received)

If you have a separate phone line on which you receive no voice calls, and you have no other equipment connected on this phone line, set up the printer as described in this section.

Figure B-1 Back view of the printer

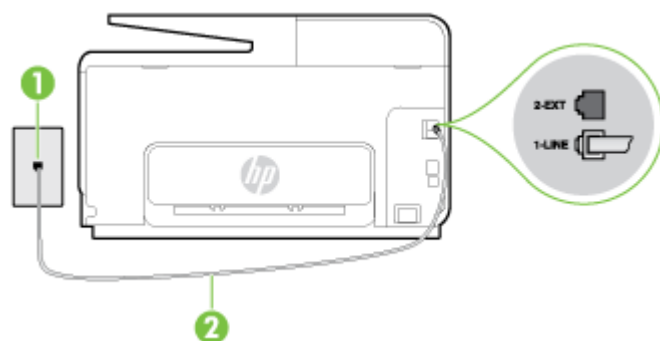

1	Telephone wall jack
2	Use the phone cord supplied in the box with the printer to connect to the 1-LINE port. You might need to connect the supplied phone cord to the adapter provided for your country/region.

To set up the printer with a separate fax line

1. Using the phone cord supplied in the box with the printer, connect one end to your telephone wall jack, then connect the other end to the port labeled 1-LINE on the back of the printer.

 **NOTE:** You might need to connect the supplied phone cord to the adapter provided for your country/region.

If you do not use the supplied cord to connect from the telephone wall jack to the printer, you might not be able to fax successfully. This special phone cord is different from the phone cords you might already have in your home or office.

2. Turn on the **Auto Answer** setting.
3. (Optional) Change the **Rings to Answer** setting to the lowest setting (two rings).
4. Run a fax test.

When the phone rings, the printer answers automatically after the number of rings you set in the **Rings to Answer** setting. The printer begins emitting fax reception tones to the sending fax machine and receives the fax.

Case B: Set up the printer with DSL

If you have a DSL service through your telephone company, and do not connect any equipment to the printer, use the instructions in this section to connect a DSL filter between the telephone wall jack and the printer. The DSL filter removes the digital signal that can interfere with the printer, so the printer can communicate correctly with the phone line. (DSL might be called ADSL in your country/region.)

 **NOTE:** If you have a DSL line and you do not connect the DSL filter, you cannot send and receive faxes with the printer.

Figure B-2 Back view of the printer



1	Telephone wall jack
2	DSL (or ADSL) filter and cord supplied by your DSL provider
3	Use the phone cord supplied in the box with the printer to connect to the 1-LINE port. You might need to connect the supplied phone cord to the adapter provided for your country/region.

To set up the printer with DSL

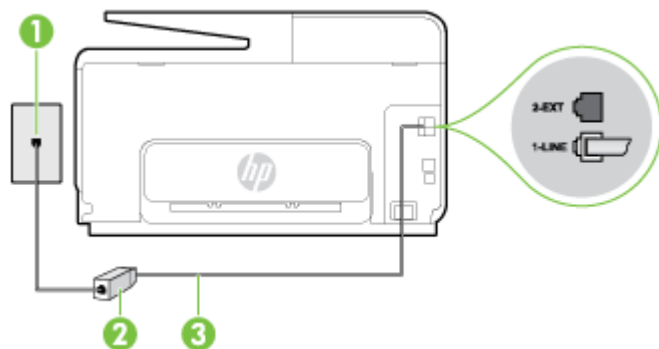
1. Obtain a DSL filter from your DSL provider.
2. Using the phone cord supplied in the box with the printer, connect one end to the open port on the DSL filter, and then connect the other end to the port labeled 1-LINE on the back of the printer.

NOTE: You might need to connect the supplied phone cord to the adapter provided for your country/region.

If you do not use the supplied cord to connect from the DSL filter to the printer, you might not be able to fax successfully. This special phone cord is different from the phone cords you might already have in your home or office.

As only one phone cord is supplied, you might need to obtain additional phone cords for this setup.

3. Connect an additional phone cord from the DSL filter to the telephone wall jack.
4. Run a fax test.

If you encounter problems setting up the printer with optional equipment, contact your local service provider or vendor for further assistance.

Case C: Set up the printer with a PBX phone system or an ISDN line

If you are using either a PBX phone system or an ISDN converter/terminal adapter, make sure you do the following:

- If you are using either a PBX or an ISDN converter/terminal adaptor, connect the printer to the port that is designated for fax and phone use. Also, make sure that the terminal adapter is set to the correct switch type for your country/region, if possible.

NOTE: Some ISDN systems allow you to configure the ports for specific phone equipment. For example, you might have assigned one port for telephone and Group 3 fax and another port for multiple purposes. If you have problems when connected to the fax/phone port of your ISDN converter, try using the port designated for multiple purposes; it might be labeled "multi-combi" or something similar.

- If you are using a PBX phone system, set the call waiting tone to "off."

NOTE: Many digital PBX systems include a call-waiting tone that is set to "on" by default. The call waiting tone interferes with any fax transmission, and you cannot send or receive faxes with the printer. Refer to the documentation that came with your PBX phone system for instructions on how to turn off the call-waiting tone.

- If you are using a PBX phone system, dial the number for an outside line before dialing the fax number.
- Make sure you use the supplied cord to connect from the telephone wall jack to the printer. If you do not, you might not be able to fax successfully. This special phone cord is different from the phone cords you might already have in your home or office. If the supplied phone cord is too short, you can purchase a longer 2-wire phone cord from your local electronics store and extend it.

You might need to connect the supplied phone cord to the adapter provided for your country/region.

If you encounter problems setting up the printer with optional equipment, contact your local service provider or vendor for further assistance.

Case D: Fax with a distinctive ring service on the same line

If you subscribe to a distinctive ring service (through your telephone company) that allows you to have multiple phone numbers on one phone line, each with a different ring pattern, set up the printer as described in this section.

Figure B-3 Back view of the printer

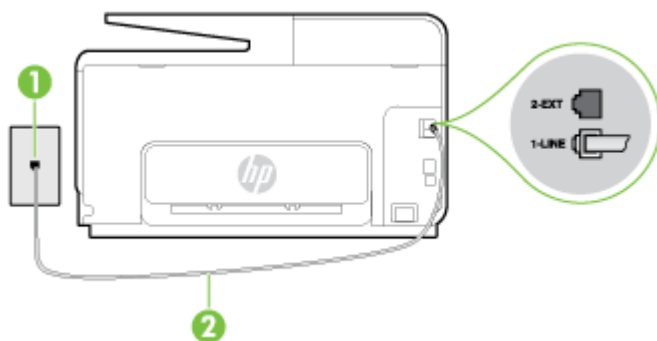

1	Telephone wall jack
2	Use the phone cord supplied in the box with the printer to connect to the 1-LINE port. You might need to connect the supplied phone cord to the adapter provided for your country/region.

To set up the printer with a distinctive ring service

1. Using the phone cord supplied in the box with the printer, connect one end to your telephone wall jack, then connect the other end to the port labeled 1-LINE on the back of the printer.

 **NOTE:** You might need to connect the supplied phone cord to the adapter provided for your country/region.

If you do not use the supplied cord to connect from the telephone wall jack to the printer, you might not be able to fax successfully. This special phone cord is different from the phone cords you might already have in your home or office.

2. Turn on the **Auto Answer** setting.
3. Change the **Distinctive Ring** setting to match the pattern that the telephone company assigned to your fax number.

 **NOTE:** By default, the printer is set to answer all ring patterns. If you do not set the **Distinctive Ring** to match the ring pattern assigned to your fax number, the printer might answer both voice calls and fax calls or it might not answer at all.

 **TIP:** You can also use the Ring Pattern Detection feature in the printer control panel to set distinctive ring. With this feature, the printer recognizes and records the ring pattern of an incoming call and, based on this call, automatically determines the distinctive ring pattern assigned by your telephone company to fax calls. For more information, see [Change the answer ring pattern for distinctive ring on page 78](#).

4. (Optional) Change the **Rings to Answer** setting to the lowest setting (two rings).
5. Run a fax test.

The printer automatically answers incoming calls that have the ring pattern you selected (**Distinctive Ring** setting) after the number of rings you selected (**Rings to Answer** setting). The printer begins emitting fax reception tones to the sending fax machine and receives the fax.

If you encounter problems setting up the printer with optional equipment, contact your local service provider or vendor for further assistance.

Case E: Shared voice/fax line

If you receive both voice calls and fax calls at the same phone number, and you have no other office equipment (or voice mail) on this phone line, set up the printer as described in this section.

Figure B-4 Back view of the printer

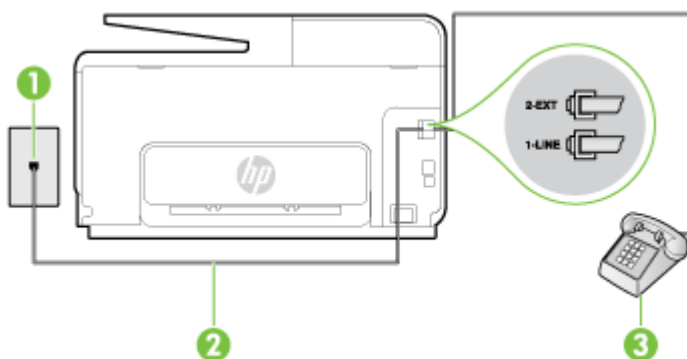

1

Telephone wall jack

2	Use the phone cord supplied in the box with the printer to connect to the 1-LINE port. You might need to connect the supplied phone cord to the adapter provided for your country/region.
3	Telephone (optional)

To set up the printer with a shared voice/fax line

- Using the phone cord supplied in the box with the printer, connect one end to your telephone wall jack, then connect the other end to the port labeled 1-LINE on the back of the printer.

 **NOTE:** You might need to connect the supplied phone cord to the adapter provided for your country/region.

If you do not use the supplied cord to connect from the telephone wall jack to the printer, you might not be able to fax successfully. This special phone cord is different from the phone cords you might already have in your home or office.

- Do one of the following:
 - If you have a parallel-type phone system, remove the white plug from the port labeled 2-EXT on the back of the printer, and then connect a phone to this port.
 - If you have a serial-type phone system, you might plug your phone directly on top of the printer cable which has a wall plug attached to it.
- Now you need to decide how you want the printer to answer calls, automatically or manually:
 - If you set up the printer to answer calls **automatically**, it answers all incoming calls and receives faxes. The printer cannot distinguish between fax and voice calls in this case; if you suspect the call is a voice call, you need to answer it before the printer answers the call. To set up the printer to answer calls automatically, turn on the **Auto Answer** setting.
 - If you set up the printer to answer faxes **manually**, you must be available to respond in person to incoming fax calls or the printer cannot receive faxes. To set up the printer to answer calls manually, turn off the **Auto Answer** setting.

- Run a fax test.

If you pick up the phone before the printer answers the call and hear fax tones from a sending fax machine, you need to answer the fax call manually.

If you encounter problems setting up the printer with optional equipment, contact your local service provider or vendor for further assistance.

Case F: Shared voice/fax line with voice mail

If you receive both voice calls and fax calls at the same phone number, and you also subscribe to a voice mail service through your telephone company, set up the printer as described in this section.

 **NOTE:** You cannot receive faxes automatically if you have a voice mail service at the same phone number you use for fax calls. You must receive faxes manually; this means you must be available to respond in person to incoming fax calls. If you want to receive faxes automatically instead, contact your telephone company to subscribe to a distinctive ring service, or to obtain a separate phone line for faxing.

Figure B-5 Back view of the printer



1	Telephone wall jack
2	Use the phone cord supplied in the box with the printer to connect to the 1-LINE port. You might need to connect the supplied phone cord to the adapter provided for your country/ region.

To set up the printer with voice mail

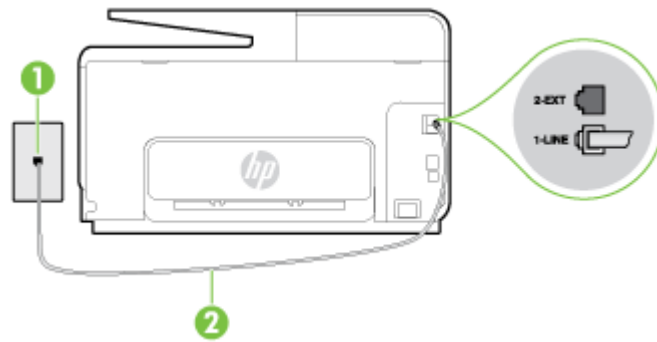
1. Using the phone cord supplied in the box with the printer, connect one end to your telephone wall jack, then connect the other end to the port labeled 1-LINE on the back of the printer.

You might need to connect the supplied phone cord to the adapter provided for your country/
region.

 **NOTE:** You might need to connect the supplied phone cord to the adapter provided for your country/region.

If you do not use the supplied cord to connect from the telephone wall jack to the printer, you might not be able to fax successfully. This special phone cord is different from the phone cords you might already have in your home or office.

2. Turn off the **Auto Answer** setting.
3. Run a fax test.

You must be available to respond in person to incoming fax calls, or the printer cannot receive faxes. You must initiate the manual fax before voicemail picks up the line.

If you encounter problems setting up the printer with optional equipment, contact your local service provider or vendor for further assistance.

Case G: Fax line shared with computer modem (no voice calls received)

If you have a fax line on which you receive no voice calls, and you also have a computer modem connected on this line, set up the printer as described in this section.

 **NOTE:** If you have a computer dial-up modem, your computer dial-up modem shares the phone line with the printer. You cannot use both your modem and the printer simultaneously. For example, you cannot use the printer for faxing while you are using your computer dial-up modem to send an email or access the Internet.

- Set up the printer with a computer dial-up modem
- Set up the printer with a computer DSL/ADSL modem

Set up the printer with a computer dial-up modem

If you are using the same phone line for sending faxes and for a computer dial-up modem, follow these directions for setting up the printer.

Figure B-6 Back view of the printer

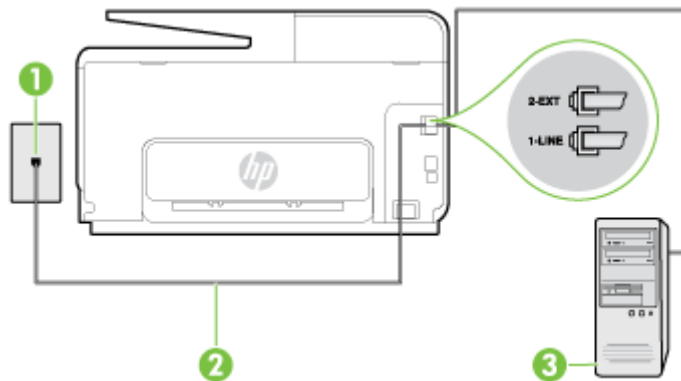

1	Telephone wall jack
2	Use the phone cord supplied in the box with the printer to connect to the 1-LINE port. You might need to connect the supplied phone cord to the adapter provided for your country/region.
3	Computer with modem

To set up the printer with a computer dial-up modem

1. Remove the white plug from the port labeled 2-EXT on the back of the printer.
2. Find the phone cord that connects from the back of your computer (your computer dial-up modem) to a telephone wall jack. Disconnect the cord from the telephone wall jack and plug it into the port labeled 2-EXT on the back of the printer.
3. Using the phone cord supplied in the box with the printer, connect one end to your telephone wall jack, then connect the other end to the port labeled 1-LINE on the back of the printer.

 **NOTE:** You might need to connect the supplied phone cord to the adapter provided for your country/region.

If you do not use the supplied cord to connect from the telephone wall jack to the printer, you might not be able to fax successfully. This special phone cord is different from the phone cords you might already have in your home or office.

4. If your modem software is set to receive faxes to your computer automatically, turn off that setting.

 **NOTE:** If you do not turn off the automatic fax reception setting in your modem software, the printer cannot receive faxes.

5. Turn on the **Auto Answer** setting.
6. (Optional) Change the **Rings to Answer** setting to the lowest setting (two rings).
7. Run a fax test.

When the phone rings, the printer automatically answers after the number of rings you set in the **Rings to Answer** setting. The printer begins emitting fax reception tones to the sending fax machine and receives the fax.

If you encounter problems setting up the printer with optional equipment, contact your local service provider or vendor for further assistance.

Set up the printer with a computer DSL/ADSL modem

If you have a DSL line and use that phone line to send faxes, follow these instructions to set up your fax.

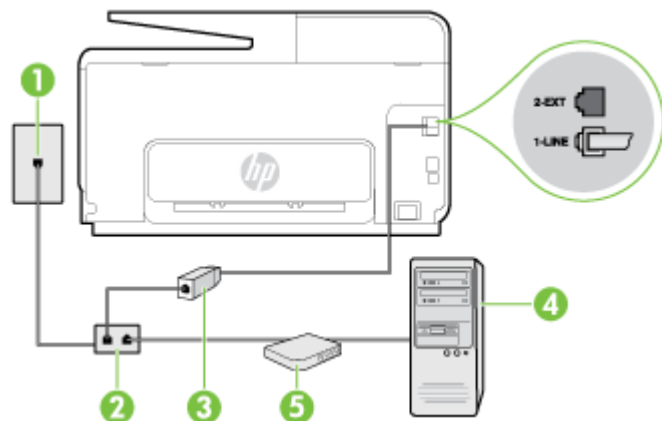

1	Telephone wall jack
2	Parallel splitter
3	DSL/ADSL filter
4	Computer
5	Computer DSL/ADSL modem

NOTE: You need to purchase a parallel splitter. A parallel splitter has one RJ-11 port on the front and two RJ-11 ports on the back. Do not use a 2-line phone splitter, a serial splitter, or a parallel splitter which has two RJ-11 ports on the front and a plug on the back.

Figure B-7 Example of a parallel splitter



To set up the printer with a computer DSL/ADSL modem

1. Obtain a DSL filter from your DSL provider.
2. Using the phone cord provided in the box with the printer, connect one end to the DSL filter, and then connect the other end to the port labeled 1-LINE on the back of the printer.

NOTE: You might need to connect the supplied phone cord to the adapter provided for your country/region.

If you do not use the supplied cord to connect from the DSL filter to the back of the printer, you might not be able to fax successfully. This special phone cord is different from the phone cords you might already have in your home or office.

3. Connect the DSL filter to the parallel splitter.

4. Connect the DSL modem to the parallel splitter.
5. Connect the parallel splitter to the wall jack.
6. Run a fax test.

When the phone rings, the printer automatically answers after the number of rings you set in the **Rings to Answer** setting. The printer begins emitting fax reception tones to the sending fax machine and receives the fax.

If you encounter problems setting up the printer with optional equipment, contact your local service provider or vendor for further assistance.

Case H: Shared voice/fax line with computer modem

There are two different ways to set up the printer with your computer based on the number of phone ports on your computer. Before you begin, check your computer to see if it has one or two phone ports.

 **NOTE:** If your computer has only one phone port, you need to purchase a parallel splitter (also called a coupler), as shown in the illustration. (A parallel splitter has one RJ-11 port on the front and two RJ-11 ports on the back. Do not use a two-line phone splitter, a serial splitter, or a parallel splitter which has two RJ-11 ports on the front and a plug on the back.)

- [Shared voice/fax with computer dial-up modem](#)
- [Shared voice/fax with computer DSL/ADSL modem](#)

Shared voice/fax with computer dial-up modem

If you use your phone line for both fax and telephone calls, use these instructions to set up your fax.

There are two different ways to set up the printer with your computer based on the number of phone ports on your computer. Before you begin, check your computer to see if it has one or two phone ports.

 **NOTE:** If your computer has only one phone port, you need to purchase a parallel splitter (also called a coupler), as shown in the illustration. (A parallel splitter has one RJ-11 port on the front and two RJ-11 ports on the back. Do not use a two-line phone splitter, a serial splitter, or a parallel splitter which has two RJ-11 ports on the front and a plug on the back.)

Figure B-8 Example of a parallel splitter



To set up the printer on the same phone line as a computer with two phone ports

Figure B-9 Back view of the printer

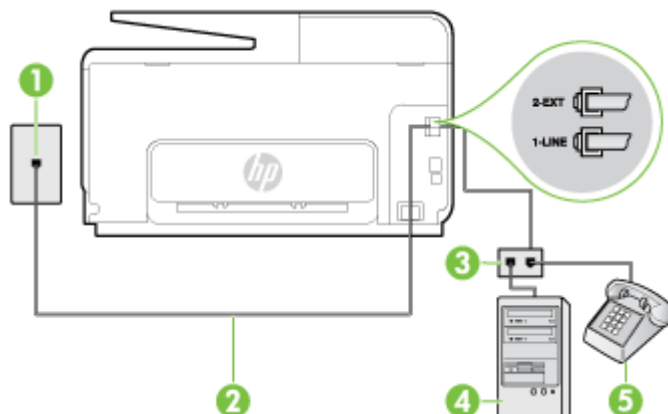

1	Telephone wall jack
2	Use the phone cord supplied in the box with the printer to connect to the 1-LINE port.
3	Parallel splitter
4	Computer with modem
5	Telephone

1. Remove the white plug from the port labeled 2-EXT on the back of the printer.
2. Find the phone cord that connects from the back of your computer (your computer dial-up modem) to a telephone wall jack. Disconnect the cord from the telephone wall jack and plug it into the port labeled 2-EXT on the back of the printer.
3. Connect a phone to the "OUT" port on the back of your computer dial-up modem.
4. Using the phone cord supplied in the box with the printer, connect one end to your telephone wall jack, then connect the other end to the port labeled 1-LINE on the back of the printer.

 **NOTE:** You might need to connect the supplied phone cord to the adapter provided for your country/region.

If you do not use the supplied cord to connect from the telephone wall jack to the printer, you might not be able to fax successfully. This special phone cord is different from the phone cords you might already have in your home or office.

5. If your modem software is set to receive faxes to your computer automatically, turn off that setting.

 **NOTE:** If you do not turn off the automatic fax reception setting in your modem software, the printer cannot receive faxes.

6. Now you need to decide how you want the printer to answer calls, automatically or manually:
 - If you set up the printer to answer calls **automatically**, it answers all incoming calls and receives faxes. The printer cannot distinguish between fax and voice calls in this case; if you suspect the call is a voice call, you need to answer it before the printer answers the call. To set up the printer to answer calls automatically, turn on the **Auto Answer** setting.
 - If you set up the printer to answer faxes **manually**, you must be available to respond in person to incoming fax calls or the printer cannot receive faxes. To set up the printer to answer calls manually, turn off the **Auto Answer** setting.

7. Run a fax test.

If you pick up the phone before the printer answers the call and hear fax tones from a sending fax machine, you need to answer the fax call manually.

If you use your phone line for voice, fax, and your computer dial-up modem, follow these directions to set up your fax.

If you encounter problems setting up the printer with optional equipment, contact your local service provider or vendor for further assistance.

Shared voice/fax with computer DSL/ADSL modem

Use these instructions if your computer has a DSL/ADSL modem

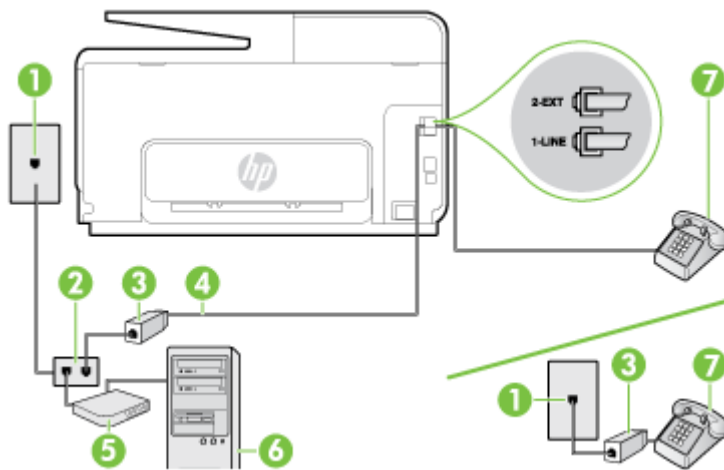

1	Telephone wall jack
2	Parallel splitter
3	DSL/ADSL filter
4	Use the phone cord provided to connect to the 1-LINE port on the back of the printer. You might need to connect the supplied phone cord to the adapter provided for your country/region.
5	DSL/ADSL modem
6	Computer
7	Telephone

NOTE: You need to purchase a parallel splitter. A parallel splitter has one RJ-11 port on the front and two RJ-11 ports on the back. Do not use a 2-line phone splitter, a serial splitter, or a parallel splitter which has two RJ-11 ports on the front and a plug on the back.

Figure B-10 Example of a parallel splitter



To set up the printer with a computer DSL/ADSL modem

1. Obtain a DSL filter from your DSL provider.

NOTE: Phones in other parts of the home/office sharing the same phone number with DSL service need to be connected to additional DSL filters to avoid noise when making voice calls.

2. Using the phone cord supplied in the box with the printers, connect one end to the DSL filter, then connect the other end to the port labeled 1-LINE on the back of the printer.

NOTE: You might need to connect the supplied phone cord to the adapter provided for your country/region.

If you do not use the supplied cord to connect from the DSL filter to the printer, you might not be able to fax successfully. This special phone cord is different from phone cords you might already have in your home or office.

3. If you have a parallel-type phone system, remove the white plug from the port labeled 2-EXT on the back of the printer, and then connect a phone to this port.

4. Connect the DSL filter to the parallel splitter.
5. Connect the DSL modem to the parallel splitter.
6. Connect the parallel splitter to the wall jack.
7. Run a fax test.

When the phone rings, the printer automatically answers after the number of rings you set in the **Rings to Answer** setting. The printer begins emitting fax reception tones to the sending fax machine and receives the fax.

If you encounter problems setting up the printer with optional equipment, contact your local service provider or vendor for further assistance.

Case I: Shared voice/fax line with answering machine

If you receive both voice calls and fax calls at the same phone number, and you also have an answering machine that answers voice calls at this phone number, set up the printer as described in this section.

Figure B-11 Back view of the printer

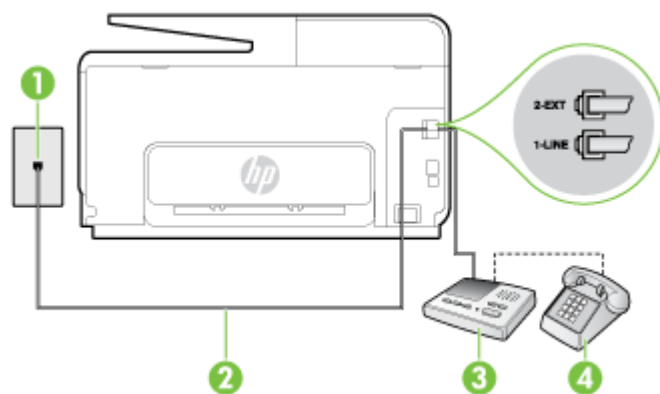

1	Telephone wall jack
2	Use the phone cord provided to connect to the 1-LINE port on the back of the printer You might need to connect the supplied phone cord to the adapter provided for your country/region.
3	Answering machine
4	Telephone (optional)

To set up the printer with a shared voice/fax line with answering machine

1. Remove the white plug from the port labeled 2-EXT on the back of the printer.
2. Unplug your answering machine from the telephone wall jack, and connect it to the port labeled 2-EXT on the back of the printer.

NOTE: If you do not connect your answering machine directly to the printer, fax tones from a sending fax machine might be recorded on your answering machine, and you might not receive faxes with the printer.

- Using the phone cord supplied in the box with the printer, connect one end to your telephone wall jack, then connect the other end to the port labeled 1-LINE on the back of the printer.

 **NOTE:** You might need to connect the supplied phone cord to the adapter provided for your country/region.

If you do not use the supplied cord to connect from the telephone wall jack to the printer, you might not be able to fax successfully. This special phone cord is different from the phone cords you might already have in your home or office.

- (Optional) If your answering machine does not have a built-in phone, for convenience you might want to connect a phone to the back of your answering machine at the "OUT" port.

 **NOTE:** If your answering machine does not let you connect an external phone, you can purchase and use a parallel splitter (also known as a coupler) to connect both the answering machine and telephone to the printer. You can use standard phone cords for these connections.

- Turn on the **Auto Answer** setting.
- Set your answering machine to answer after a low number of rings.
- Change the **Rings to Answer** setting on the printer to the maximum number of rings supported by your printer. (The maximum number of rings varies by country/region.)
- Run a fax test.

When the phone rings, your answering machine answers after the number of rings you have set, and then plays your recorded greeting. The printer monitors the call during this time, "listening" for fax tones. If incoming fax tones are detected, the printer emits fax reception tones and receives the fax; if there are no fax tones, the printer stops monitoring the line and your answering machine can record a voice message.

If you encounter problems setting up the printer with optional equipment, contact your local service provider or vendor for further assistance.

Case J: Shared voice/fax line with computer modem and answering machine

If you receive both voice calls and fax calls at the same phone number, and you also have a computer modem and answering machine connected on this phone line, set up the printer as described in this section.

 **NOTE:** Since your computer dial-up modem shares the phone line with the printer, you cannot use both your modem and the printer simultaneously. For example, you cannot use the printer for faxing while you are using your computer dial-up modem to send an email or access the Internet.

- [Shared voice/fax line with computer dial-up modem and answering machine](#)
- [Shared voice/fax line with computer DSL/ADSL modem and answering machine](#)

Shared voice/fax line with computer dial-up modem and answering machine

There are two different ways to set up the printer with your computer based on the number of phone ports on your computer. Before you begin, check your computer to see if it has one or two phone ports.

 **NOTE:** If your computer has only one phone port, you need to purchase a parallel splitter (also called a coupler), as shown in the illustration. (A parallel splitter has one RJ-11 port on the front and two RJ-11 ports on the back. Do not use a two-line phone splitter, a serial splitter, or a parallel splitter which has two RJ-11 ports on the front and a plug on the back.)

Figure B-12 Example of a parallel splitter



To set up the printer on the same phone line as a computer with two phone ports

Figure B-13 Back view of the printer

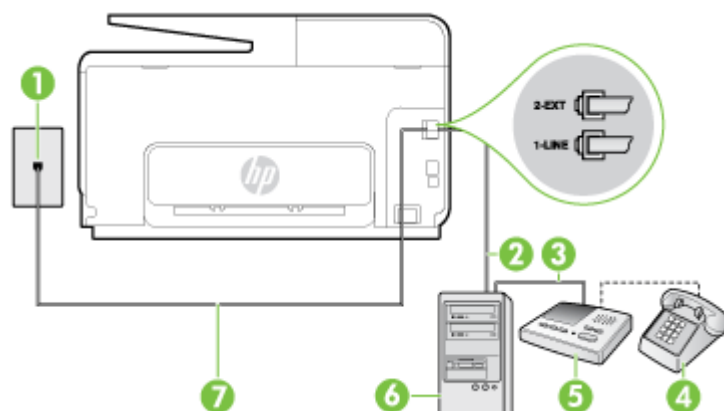

1	Telephone wall jack
2	"IN" phone port on your computer
3	"OUT" phone port on your computer
4	Telephone (optional)
5	Answering machine
6	Computer with modem
7	Use the phone cord supplied in the box with the printer to connect to the 1-LINE port. You might need to connect the supplied phone cord to the adapter provided for your country/region.

1. Remove the white plug from the port labeled 2-EXT on the back of the printer.
2. Find the phone cord that connects from the back of your computer (your computer dial-up modem) to a telephone wall jack. Disconnect the cord from the telephone wall jack and plug it into the port labeled 2-EXT on the back of the printer.
3. Unplug your answering machine from the telephone wall jack, and connect it to the port labeled "OUT" on the back of the computer (the computer dial-up modem).
4. Using the phone cord supplied in the box with the printer, connect one end to your telephone wall jack, then connect the other end to the port labeled 1-LINE on the back of the printer.

 **NOTE:** You might need to connect the supplied phone cord to the adapter provided for your country/region.

If you do not use the supplied cord to connect from the telephone wall jack to the printer, you might not be able to fax successfully. This special phone cord is different from the phone cords you might already have in your home or office.

- (Optional) If your answering machine does not have a built-in phone, for convenience you might want to connect a phone to the back of your answering machine at the "OUT" port.

 **NOTE:** If your answering machine does not let you connect an external phone, you can purchase and use a parallel splitter (also known as a coupler) to connect both the answering machine and telephone to the printer. You can use standard phone cords for these connections.

- If your modem software is set to receive faxes to your computer automatically, turn off that setting.

 **NOTE:** If you do not turn off the automatic fax reception setting in your modem software, the printer cannot receive faxes.

- Turn on the **Auto Answer** setting.
- Set your answering machine to answer after a low number of rings.
- Change the **Rings to Answer** setting on the printer to the maximum number of rings supported by the product. (The maximum number of rings varies by country/region.)
- Run a fax test.

When the phone rings, your answering machine answers after the number of rings you have set, and then plays your recorded greeting. The printer monitors the call during this time, "listening" for fax tones. If incoming fax tones are detected, the printer emits fax reception tones and receives the fax; if there are no fax tones, the printer stops monitoring the line and your answering machine can record a voice message.

If you encounter problems setting up the printer with optional equipment, contact your local service provider or vendor for further assistance.

Shared voice/fax line with computer DSL/ADSL modem and answering machine

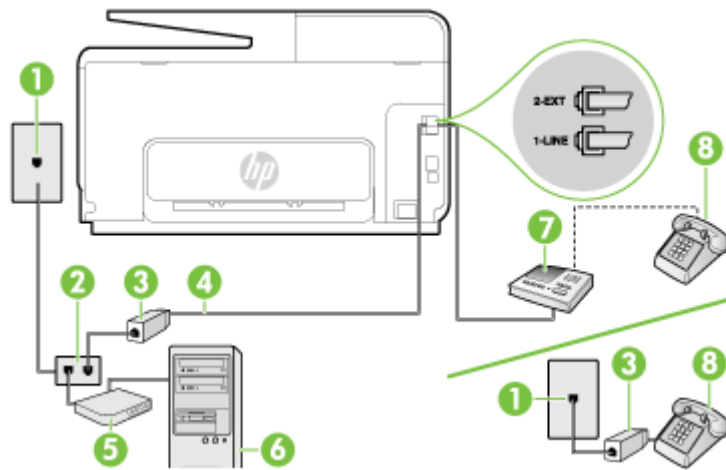

1	Telephone wall jack
2	Parallel splitter
3	DSL/ADSL filter
4	Phone cord provided with the printer connected to the 1-LINE port on the back of the printer You might need to connect the supplied phone cord to the adapter provided for your country/region.
5	DSL/ADSL modem
6	Computer

7	Answering machine
8	Telephone (optional)



 **NOTE:** You need to purchase a parallel splitter. A parallel splitter has one RJ-11 port on the front and two RJ-11 ports on the back. Do not use a 2-line phone splitter, a serial splitter, or a parallel splitter which has two RJ-11 ports on the front and a plug on the back.

Figure B-14 Example of a parallel splitter



To set up the printer with a computer DSL/ADSL modem

1. Obtain a DSL/ADSL filter from your DSL/ADSL provider.

 **NOTE:** Phones in other parts of the home/office sharing the same phone number with DSL/ADSL service need to be connected to additional DSL/ADSL filters, to avoid noise when making voice calls.

2. Using the phone cord supplied in the box with the printer, connect one end to the DSL/ADSL filter, then connect the other end to the port labeled 1-LINE on the back of the printer.

 **NOTE:** You might need to connect the supplied phone cord to the adapter provided for your country/region.

If you do not use the supplied cord to connect from the DSL/ADSL filter to the printer, you might not be able to fax successfully. This special phone cord is different from the phone cords you might already have in your home or office.

3. Connect the DSL/ADSL filter to the splitter.
4. Unplug the answering machine from the telephone wall jack, and connect it to the port labeled 2-EXT on the back of the printer.

 **NOTE:** If you do not connect your answering machine directly to the printer, fax tones from a sending fax machine might be recorded on your answering machine, and you might not receive faxes with the printer.

5. Connect the DSL modem to the parallel splitter.
6. Connect the parallel splitter to the wall jack.
7. Set your answering machine to answer after a low number of rings.
8. Change your **Rings to Answer** setting on the printer to the maximum number of rings supported by the printer.

 **NOTE:** The maximum number of rings varies by country/region.

9. Run a fax test.

When the phone rings, your answering machine answers after the number of rings you have set, and then play your recorded greeting. The printer monitors the call during this time, “listening” for fax tones. If incoming fax tones are detected, the printer emits fax reception tones and receive the fax; if there are no fax tones, the printer stops monitoring the line and your answering machine can record a voice message.

If you use the same phone line for telephone, fax, and have a computer DSL modem, follow these instructions to set up your fax.

If you encounter problems setting up the printer with optional equipment, contact your local service provider or vendor for further assistance.

Case K: Shared voice/fax line with computer dial-up modem and voice mail

If you receive both voice calls and fax calls at the same phone number, use a computer dial-up modem on the same phone line, and subscribe to a voice mail service through your telephone company, set up the printer as described in this section.

 **NOTE:** You cannot receive faxes automatically if you have a voice mail service at the same phone number you use for fax calls. You must receive faxes manually; this means you must be available to respond in person to incoming fax calls. If you want to receive faxes automatically instead, contact your telephone company to subscribe to a distinctive ring service, or to obtain a separate phone line for faxing.

Since your computer dial-up modem shares the phone line with the printer, you cannot use both your modem and the printer simultaneously. For example, you cannot use the printer for faxing if you are using your computer dial-up modem to send an email or access the Internet.

There are two different ways to set up the printer with your computer based on the number of phone ports on your computer. Before you begin, check your computer to see if it has one or two phone ports.

- If your computer has only one phone port, you need to purchase a parallel splitter (also called a coupler), as shown in the illustration. (A parallel splitter has one RJ-11 port on the front and two RJ-11 ports on the back. Do not use a two-line phone splitter, a serial splitter, or a parallel splitter which has two RJ-11 ports on the front and a plug on the back.)

Figure B-15 Example of a parallel splitter



- If your computer has two phone ports, set up the printer as follows:

Figure B-16 Back view of the printer

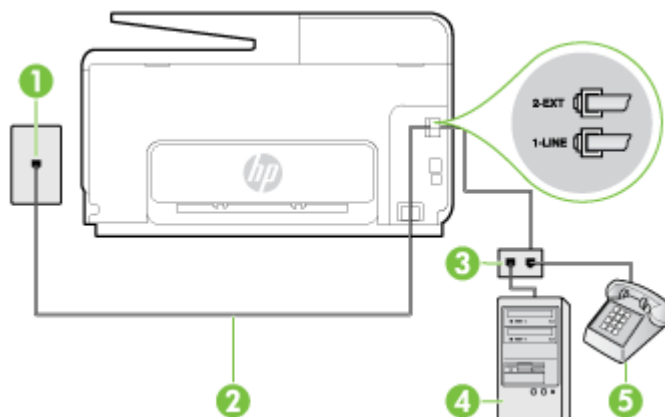

1	Telephone wall jack
2	Use the phone cord supplied in the box with the printer to connect to the 1-LINE port You might need to connect the supplied phone cord to the adapter provided for your country/region.
3	Computer with modem
4	Telephone

To set up the printer on the same phone line as a computer with two phone ports

1. Remove the white plug from the port labeled 2-EXT on the back of the printer.
2. Find the phone cord that connects from the back of your computer (your computer dial-up modem) to a telephone wall jack. Disconnect the cord from the telephone wall jack and plug it into the port labeled 2-EXT on the back of the printer.
3. Connect a phone to the "OUT" port on the back of your computer dial-up modem.
4. Using the phone cord supplied in the box with the printer, connect one end to your telephone wall jack, then connect the other end to the port labeled 1-LINE on the back of the printer.



NOTE: You might need to connect the supplied phone cord to the adapter provided for your country/region.

If you do not use the supplied cord to connect from the telephone wall jack to the printer, you might not be able to fax successfully. This special phone cord is different from the phone cords you might already have in your home or office.

5. If your modem software is set to receive faxes to your computer automatically, turn off that setting.



NOTE: If you do not turn off the automatic fax reception setting in your modem software, the printer cannot receive faxes.

6. Turn off the **Auto Answer** setting.
7. Run a fax test.

You must be available to respond in person to incoming fax calls, or the printer cannot receive faxes.

If you encounter problems setting up the printer with optional equipment, contact your local service provider or vendor for further assistance.

Serial-type fax setup

For information on setting up the printer for faxing using a serial-type phone system, see the Fax Configuration web site for your country/region.

Austria	www.hp.com/at/faxconfig
Germany	www.hp.com/de/faxconfig
Switzerland (French)	www.hp.com/ch/fr/faxconfig
Switzerland (German)	www.hp.com/ch/de/faxconfig
United Kingdom	www.hp.com/uk/faxconfig
Finland	www.hp.fi/faxconfig
Denmark	www.hp.dk/faxconfig
Sweden	www.hp.se/faxconfig
Norway	www.hp.no/faxconfig
Netherlands	www.hp.nl/faxconfig
Belgium (Dutch)	www.hp.be/nl/faxconfig
Belgium (French)	www.hp.be/fr/faxconfig
Portugal	www.hp.pt/faxconfig
Spain	www.hp.es/faxconfig
France	www.hp.com/fr/faxconfig
Ireland	www.hp.com/ie/faxconfig
Italy	www.hp.com/it/faxconfig

Test fax setup

You can test your fax setup to check the status of the printer and to make sure it is set up correctly for faxing. Perform this test after you have completed setting up the printer for faxing. The test does the following:

- Tests the fax hardware
- Verifies the correct type of phone cord is connected to the printer
- Checks that the phone cord is plugged into the correct port
- Checks for a dial tone
- Checks for an active phone line
- Tests the status of your phone line connection

The printer prints a report with the results of the test. If the test fails, review the report for information on how to fix the problem and rerun the test.

To test fax setup via the printer control panel

1. Set up the printer for faxing according to your particular home or office setup instructions.
2. Make sure the ink cartridges are installed, and that full-size paper is loaded in the input tray before starting the test.
3. From the printer control panel display, touch and slide your finger across the screen and then touch **Setup**.
4. Touch **Tools**, and then touch **Run Fax Test**.

The printer displays the status of the test on the display and prints a report.

5. Review the report.
 - If the test passes and you are still having problems faxing, check the fax settings listed in the report to verify the settings are correct. A blank or incorrect fax setting can cause problems faxing.
 - If the test fails, review the report for more information on how to fix any problems found.

C Errors (Windows)

- [Fax memory full](#)
- [Unable to communicate with printer](#)
- [Low on ink](#)
- [Printhead Problem](#)
- [Ink Cartridge Problem](#)
- [Replace the ink cartridge](#)
- [Incompatible older generation cartridge installed](#)
- [Paper Mismatch](#)
- [The cartridge cradle cannot move](#)
- [Paper Jam](#)
- [The printer is out of paper](#)
- [Printer Offline](#)
- [Printer Paused](#)
- [Document failed to print](#)
- [Printer failure](#)
- [Door or cover open](#)
- [Previously used ink cartridge installed](#)
- [Ink cartridges depleted](#)
- [Ink cartridge failure](#)
- [Printer supply upgrade](#)
- [Printer supply upgrade successful](#)
- [Printer supply upgrade problem](#)
- [Non-HP ink cartridges installed](#)
- [Using Genuine HP Cartridges has its Rewards](#)
- [Counterfeit Cartridge Advisory](#)
- [Used, Refilled or Counterfeit Cartridge Detected](#)
- [Use SETUP cartridges](#)

- Do not use SETUP cartridges
- Not enough ink at startup
- Use black ink only?
- Use color ink only?
- Incompatible ink cartridges
- Ink sensor failure
- Ink sensor warning
- Problem with printer preparation
- Color cartridge out of ink
- Black cartridge out of ink
- Automatic document feeder cover open
- Problem with ink system

Fax memory full

If Backup Fax Reception or HP Digital Fax is enabled and the printer has a problem (such as a paper jam), the printer saves incoming faxes to memory until the problem is resolved. However, the printer's memory might fill up with faxes that have not been printed yet or transferred to the computer.

To solve this problem, resolve any problems with the printer.

For more information, see [Solve fax problems on page 141](#).

Unable to communicate with printer

The computer cannot communicate with the printer because one of the following events has occurred:

- The printer has been turned off.
- The cable connecting the printer, such as a USB cable or a network (Ethernet) cable, has been disconnected.
- If the printer is connected to a wireless network, the wireless connection has been broken.

To solve this problem, try the following solutions:

- Make sure the printer is turned on and that  (the Power light) is on.
- Make sure the power cord and other cables are working and are firmly connected to the printer.
- Make sure the power cord is connected firmly to a functioning, alternating current (AC) power outlet.
- If the printer is connected to a network, make sure the network is functioning properly. For more information, see [General network troubleshooting on page 150](#).
- If the printer is connected to a wireless network, make sure the wireless network is functioning properly. For more information, see [Unable to connect the printer wirelessly on page 150](#).

Low on ink

The ink cartridge identified in the message is low on ink.

Ink level warnings and indicators provide estimates for planning purposes only. When you receive a low ink warning message, consider having a replacement cartridge available to avoid possible printing delays. You do not need to replace cartridges until prompted to do so.

For information about replacing ink cartridges, see [Replace the ink cartridges on page 99](#). For information about ordering ink cartridges, see [Order ink cartridges on page 101](#). For information about recycling used ink supplies, see [HP inkjet supplies recycling program on page 178](#).

 **NOTE:** Ink from the cartridges is used in the printing process in a number of different ways, including in the initialization process, which prepares the printer and cartridges for printing. In addition, some residual ink is left in the cartridge after it is used. For more information see www.hp.com/go/inkusage.

Printhead Problem

The printhead is missing, not detected, incorrectly installed, or incompatible.

If this error occurs at printer setup, try the following solutions:

- Reinstall the printhead.

For more information, see [Reinstall the printhead on page 157](#).

 **CAUTION:** The printheads contain electrical contacts that can be damaged easily.

If this error occurs after the printer has been used for a period of time, try the following solutions:

- Turn the printer off and on.

Turn off the printer, and then turn it on again by pressing  (the Power button).

If the problem persists, contact HP support for service or replacement. For more information, see [HP support on page 122](#).

Ink Cartridge Problem

The ink cartridge identified in the message is missing, damaged, or inserted into the wrong slot in the printer.

To solve this problem, try the following solutions. Solutions are listed in order, with the most likely solution first. If the first solution does not solve the problem, continue trying the remaining solutions until the issue is resolved.

Solution 1: Turn the printer off and on

Turn off the printer, and then turn it on again.

If the problem persists, try the next solution.

Solution 2: Install the ink cartridges correctly

Make sure all of the ink cartridges are properly installed:

1. Gently pull open the ink cartridge access door.
2. Remove the ink cartridge by pushing it in to release it, and then pulling it firmly toward you.
3. Insert the cartridge into the slot. Press firmly on the cartridge to ensure proper contact.
4. Close the ink cartridge access door and check if the error message has gone away.

Replace the ink cartridge

Replace the indicated ink cartridge. For more information, see [Replace the ink cartridges on page 99](#).

 **NOTE:** If your cartridge is still under warranty, contact HP support for service or replacement. For more information about ink cartridge warranty, see [Ink cartridge warranty information on page 164](#). If the problem persists after you replace the cartridge, contact HP support. For more information, see [HP support on page 122](#).

Incompatible older generation cartridge installed

You will need to use a newer version of this cartridge. In most cases you can identify a newer version of the cartridge by looking at the exterior of the cartridge package. Find the Warranty Ends date.



If it says 'v1' several spaces to the right of the date, then the cartridge is the updated newer version.

 [Click here to go online for more information.](#)

Paper Mismatch

The paper size or type selected in the printer driver does not match the paper loaded in the printer. Make sure that the correct paper is loaded in the printer, and then print the document again. For more information, see [Load paper on page 23](#).



NOTE: If the paper loaded in the printer is the correct size, change the selected paper size in the printer driver, and then print the document again.

The cartridge cradle cannot move

Something is blocking the ink cartridge cradle (the part of the printer that holds the ink cartridges).

To clear the obstruction, press  (the Power button) to turn off the printer, and then check the printer for jams.

For more information, see [Clear jams on page 159](#).

Paper Jam

Paper has become jammed in the printer.

Before you try to clear the jam, check the following:

- Make sure that you have loaded paper that meets specifications and is not wrinkled, folded, or damaged. For more information, see [Paper size and weights on page 166](#).
- Make sure that the printer is clean. For more information, see [Maintain the printer on page 34](#).
- Make sure that the trays are loaded correctly and are not too full. For more information, see [Load paper on page 23](#).

For instructions on clearing jams, as well as more information about how to avoid jams, see [Clear jams on page 159](#).

The printer is out of paper

The default tray is empty.

Load more paper, and then touch **OK**.

For more information, see [Load paper on page 23](#).

Printer Offline

The printer is currently offline. While offline, the printer cannot be used.

To change the printer's status, complete the following steps.

1. Depending on your operating system, do one the following:
 - **Windows 8:** On the **Start** screen, click **Control Panel**, and then click **View devices and printers**.
 - **Windows 7, Windows Vista, or Windows XP:** Click **Start**, and then click **Devices and Printers, Printers, or Printers and Faxes**.
2. If the printers listed in the dialog box are not being displayed in Details view, click the **View** menu, and then click **Details**.
3. If the printer is Offline, right-click the printer, and click **Use Printer Online**.
4. Try using the printer again.

Printer Paused

The printer is currently paused. While paused, new jobs are added to the queue but are not printed.

To change the printer's status, depending on your operating system, do one of the following:

To change the printer's status, do one of the following:

1. Depending on your operating system, do one the following:
 - **Windows 8:** On the **Start** screen, click **Control Panel**, and then click **View devices and printers**.
 - **Windows 7, Windows Vista, or Windows XP:** Click **Start**, and then click **Devices and Printers, Printers, or Printers and Faxes**.
2. If the printers listed in the dialog box are not being displayed in Details view, click the **View** menu, and then click **Details**.
3. If the printer is paused, right-click the printer, and click **Resume Printing**.
4. Try using the printer again.



Document failed to print

The printer could not print the document because a problem occurred in the printing system.

For information about solving printing problems, see [Solve printer problems on page 129](#).

Printer failure

There was a problem with the printer. Usually, you can resolve such problems by completing the following steps:

1. Press  (the Power button) to turn off the printer.
2. Unplug the power cord, and then plug in the power cord again.
3. Press  (the Power button) to turn on the printer.

If this problem persists, write down the error code provided in the message, and then contact HP support. For more information about contacting HP support, see [HP support on page 122](#).

Door or cover open

Before the printer can print documents, all doors and covers must be closed.

 **TIP:** When completely closed, most doors and covers snap into place.

If the problem persists after you've securely closed all doors and covers, contact HP support. For more information, see [HP support on page 122](#).

Previously used ink cartridge installed

The ink cartridge identified in the message was previously used in a different printer.

You can use ink cartridges in different printers, but if the cartridge was left outside of a printer for an extended period of time, the print quality of your documents might be affected. Also, if you use ink cartridges that have been used in a different printer, the ink level indicator might be inaccurate or unavailable.

If the print quality is unsatisfactory, try cleaning the printheads.

 **NOTE:** Ink from the cartridges is used in the printing process in a number of different ways, including in the initialization process, which prepares the printer and cartridges for printing, and in printhead servicing, which keeps print nozzles clear and ink flowing smoothly. In addition, some residual ink is left in the cartridge after it is used. For more information, see www.hp.com/go/inkusage.

For more information about storing ink cartridges, see [Order ink cartridges on page 101](#).

Ink cartridges depleted

The cartridges listed in the message must be replaced to resume printing. HP recommends that you do not remove an ink cartridge until a replacement is ready to install.

For more information, see [Replace the ink cartridges on page 99](#).

Ink cartridge failure

The cartridges listed in the message are damaged or have failed.

See [Replace the ink cartridges on page 99](#).

Printer supply upgrade

The cartridge listed in the message can only be used to upgrade one printer. Click OK to use it on this printer. If you do not wish to proceed with the supply upgrade for this printer, click Cancel Print and then remove the cartridge.

Printer supply upgrade successful

The supply upgrade was successful. The cartridges listed in the message can now be used in the printer.

Printer supply upgrade problem

The supply upgrade was not successful. The cartridges listed in the message can still be used in this printer. Replace the Supply Upgrade cartridge. For more information, see [Replace the ink cartridges on page 99](#).

Non-HP ink cartridges installed

HP cannot guarantee the quality or reliability of non-HP supplies. Printer service or repairs required as a result of using a non-HP supply will not be covered under warranty. If you believe you purchased Genuine HP ink cartridges, visit HP at www.hp.com/go/anticounterfeit for more information or to report fraud.

Using Genuine HP Cartridges has its Rewards

HP rewards loyal customers for using genuine HP supplies. Click the button below the message to view Rewards online. Reward may not be available in all regions.

Counterfeit Cartridge Advisory

The installed cartridge is not a new, genuine HP cartridge. Contact the store where this cartridge was purchased. To report suspected fraud, visit HP at www.hp.com/go/anticounterfeit. To continue using the cartridge, click **Continue**.

Used, Refilled or Counterfeit Cartridge Detected

The original HP ink in the cartridge has been depleted. The solution for this problem is to replace the ink cartridge or click OK to continue using the cartridge. For more information about replacing the cartridge, see [Replace the ink cartridges on page 99](#). HP rewards loyal customers for using genuine HP supplies. Click the button below the message to view Rewards online. Rewards may not be available in all regions.

⚠ WARNING! HP's ink cartridge warranty does not cover non-HP ink or cartridges. HP's printer warranty does not cover repairs or service due to use of non-HP cartridges or ink. HP does not guarantee the quality or reliability of non-HP ink. Information about ink levels will not be available.

Use SETUP cartridges

When you first setup the printer, you must install the cartridges that shipped in the box with the printer. These cartridges are labeled SETUP, and they calibrate your printer before the first print job. Failure to install the SETUP cartridges during the initial product setup causes an error. If you installed a set of regular cartridges, remove them and install the SETUP cartridges to complete printer setup. After printer setup is complete, the printer can use regular cartridges.

if you still receive error messages and the printer cannot complete ink system initialization, contact HP support. For more information, see [HP support on page 122](#).

[Click here to go online for more information.](#)

Do not use SETUP cartridges

SETUP cartridges cannot be used after the printer has been initialized. Remove and install non-SETUP cartridges. For more information, see [Replace the ink cartridges on page 99](#).

Not enough ink at startup

The used cartridges listed in the message might not have enough ink to complete one-time startup processes.

Solution: Install new cartridges or click **OK** to use installed cartridges.

If startup cannot complete with installed cartridges, new cartridges will be needed. For information on how to install new cartridges, see [Replace the ink cartridges on page 99](#).

Use black ink only?

The cartridges listed in the message are out of ink.

Solutions: To print in color, replace the empty cartridges. For information about how to install new cartridges, see [Replace the ink cartridges on page 99](#).

To temporarily print using Black ink only, click **Use Black Only**. The printer will replace color with grayscale. The empty cartridges will need to be replaced soon.

 **CAUTION:** Do **NOT** remove the empty color cartridge to print in **Use Black Only** mode.

Use color ink only?

The black cartridge is out of ink.

Solutions: To temporarily replace black with color, click **Use Color Only**. Black will be simulated. Text and photo quality will differ from those printed when using all cartridges. The black cartridge will need to be replaced soon.

To print with black, replace the black ink cartridge. For information about how to install new cartridges, see [Replace the ink cartridges on page 99](#).

 **CAUTION:** Do **NOT** remove the empty black cartridge to print in **Use Color Only** mode.

Incompatible ink cartridges

The ink cartridge is not compatible with your printer. This error can occur if you install an HP Instant Ink cartridge into a printer that has not been enrolled in the HP Instant Ink program. It can also occur if the HP Instant Ink cartridge was previously used in a different printer enrolled in the HP Instant Ink program.

Visit the [HP Instant Ink program](#) website for more information.

Ink sensor failure

The ink sensor has failed and the printer can no longer print.

Contact HP support. For more information, see www.hp.com/support.

Ink sensor warning

The ink sensor is reporting an unexpected condition. This could be caused by the cartridge, or the sensor may have failed. If the sensor has failed, it can no longer sense when your cartridges are out of ink. Printing with an empty cartridge will cause air to enter the ink system, which causes poor print quality. Significant amounts of ink will be used up to recover from this condition, which will deplete much of the ink supply for all cartridges.

Solution: Click **OK** to continue printing or replace the cartridge. For information about how to install new cartridges, see [Replace the ink cartridges on page 99](#).

Problem with printer preparation

The printer clock has failed and ink preparation may not be complete. The estimated Ink Level gauge might be inaccurate.

Solution: Check the print quality of your print job. If it is not satisfactory, running the printhead cleaning procedure from the toolbox might improve it.

Color cartridge out of ink

The cartridges listed in the message are out of ink.

Solutions: To print in color, replace the empty cartridges. For information about how to install new cartridges, see [Replace the ink cartridges on page 99](#).

To temporarily print using black ink only, click Cancel Print and then re-send the print job. The **Use black ink only?** message appears before the job prints. The empty cartridges will need to be replaced soon.

 **CAUTION:** Do **NOT** remove the empty color cartridge to print in **Use Black Only** mode.

Black cartridge out of ink

The black cartridge is out of ink.

Solutions: Replace the black ink cartridge. For information about how to install new cartridges, see [Replace the ink cartridges on page 99](#).

 **CAUTION:** Do **NOT** remove the empty black cartridge to print in **Use Color Only** mode.

To temporarily replace black with color, click Cancel Print and re-send the print job. The **Use color ink only?** message appears before the job prints. The black cartridge will need to be replaced soon.

Automatic document feeder cover open

Close the cover of the Automatic Document Feeder to continue.

Problem with ink system

Please remove the ink cartridges and examine them for any sign of leaks. If any cartridges have leaks, contact HP support. Do not use cartridges that are leaking.

If there are no leaks, re-install cartridges and close the printer cover. Turn the printer off then on again. If you get this message a second time, contact HP support.

For more information about contacting HP support, see [HP support on page 122](#).

Index

A

accessibility 4
accessories
 printer status report 125
 setup 30
acoustic emissions 167
ADSL, fax setup with
 parallel phone systems 185
after the support period 123
align printhead 156
answer ring pattern
 change 78
 parallel phone systems 187
answering machine
 set up with fax (parallel phone systems) 196
 set up with fax and modem 197
automatic document feeder (ADF)
 clean 35
 feeding problems, troubleshoot 35
automatic fax reduction 70

B

backup fax 68
baud rate 79
black and white pages
 fax 61
blank pages, troubleshoot
 copy 135
blocked fax numbers
 set up 70
broadcast faxing
 send 65
buttons, control panel 9

C

calibrate linefeed 157
carriage
 clear carriage jams 162
cartridges 101

clean
 automatic document feeder 35
 exterior 34
 printhead 155
 scanner glass 34
clear
 fax logs 84
colored text, and OCR 58
computer modem
 shared with fax (parallel phone systems) 190
 shared with fax and answering machine (parallel phone systems) 197
 shared with fax and voice line (parallel phone systems) 193
 shared with fax and voice mail (parallel phone systems) 201
confirmation reports, fax 83
connectors, locating 8
control panel
 buttons 9
 lights 9
 status icons 9
Copy 10
copy
 quality 135
 specifications 166
 troubleshoot 135
correct port test, fax 142
customer support
 electronic 122

D

dial tone test, failure 144
dial type, setting 79
dial-up modem
 shared with fax (parallel phone systems) 190

shared with fax and answering machine (parallel phone systems) 197
shared with fax and voice line (parallel phone systems) 193
shared with fax and voice mail (parallel phone systems) 201
distinctive ringing
 change 78
 parallel phone systems 187
document feeder
 load originals 28
DSL, fax setup with
 parallel phone systems 185
duplexer
 clear jams 159
 installation 30

E

ECM. *See* error correction mode
edit
 text in OCR program 58
embedded web server
 about 118
 opening 118
 troubleshoot, cannot be opened 153
 Webscan 57
environmental specifications 165
environmental sustainability program 177
error correction mode 66
error reports, fax 84
EWS. *See* embedded web server

F

fax
 answer mode 77
 answering machine and modem, shared with (parallel phone systems) 197

- answering machine, set up (parallel phone systems) 196
 - auto answer 77
 - backup fax 68
 - blocking numbers 70
 - confirmation reports 83
 - dial tone test, failed 144
 - dial type, setting 79
 - distinctive ringing setup (parallel phone systems) 187
 - distinctive ringing, change pattern 78
 - DSL, set up (parallel phone systems) 185
 - error correction mode 66
 - error reports 84
 - forwarding 69
 - header 77
 - Internet Protocol, over 82
 - ISDN line, set up (parallel phone systems) 186
 - line condition test, failed 144
 - log, clear 84
 - log, print 84
 - manual receive 67
 - modem and answering machine, shared with (parallel phone systems) 197
 - modem and voice line, shared with (parallel phone systems) 193
 - modem and voice mail, shared with (parallel phone systems) 201
 - modem, shared with (parallel phone systems) 190
 - monitor dialing 64, 65
 - paper size 69
 - parallel phone systems 182
 - PBX system, set up (parallel phone systems) 186
 - phone cord connection test, failed 142
 - phone cord type test, failed 143
 - print last transaction details 85
 - receive 67
 - receive, troubleshoot 145, 147
 - redial options 79
 - reduction 70
 - reports 83
 - reprint 68
 - rings to answer 78
 - send 62
 - send, troubleshoot 145, 148
 - separate line setup (parallel phone systems) 184
 - settings, change 77
 - setup types 183
 - shared phone line setup (parallel phone systems) 188
 - sound volume 80
 - specifications 167
 - speed 79
 - test failed 141
 - test setup 204
 - troubleshoot 141
 - voice mail, set up (parallel phone systems) 189
 - wall jack test, failed 142
 - Fax screen 10
 - firewalls, troubleshoot 131
 - FoIP 82
 - forwarding faxes 69
- G**
- glass, scanner
 - clean 34
 - load originals 27
 - locating 7
 - grainy or white bands on copies, troubleshoot 136
- H**
- hardware, fax setup test 141
 - head 155
 - header, fax 77
 - Help 10
 - HP Utility (OS X) opening 117
 - humidity specifications 165
- I**
- ink cartridges 8
 - check ink levels 97
 - locating 8
 - part numbers 101, 126
 - replace 99
 - status 126
 - tips 96
 - warranty expiration dates 126
 - ink level icons 10
 - ink levels, check 97
- J**
- ink-cartridge access door, locating 8
 - installation
 - duplexer 30
 - Internet Protocol
 - fax, using 82
 - IP address
 - checking for printer 153
 - IP settings 109
 - ISDN line, set up with fax
 - parallel phone systems 186
- J**
- jams
 - clear 159
 - paper 161
 - paper to avoid 22
 - junk fax mode 70
- L**
- lights, control panel 9
 - line condition test, fax 144
 - linefeed, calibrate 157
 - lines
 - copies, troubleshoot 135
 - scans, troubleshoot 139
 - link speed, setting 109
 - log, fax
 - print 84
- M**
- maintain
 - printhead 155
 - maintenance
 - align printhead 156
 - calibrate linefeed 157
 - check ink levels 97
 - clean printhead 155
 - printhead 155
 - reinstall the printhead 157
 - replace ink cartridges 99
 - manual faxing
 - receive 67
 - send 63, 64
 - memory
 - reprint faxes 68
 - save faxes 68
 - missing or incorrect information, troubleshoot 131
 - model number 125
 - modem
 - shared with fax (parallel phone systems) 190

- shared with fax and answering machine (parallel phone systems) 197
- shared with fax and voice line (parallel phone systems) 193
- shared with fax and voice mail (parallel phone systems) 201
- monitor dialing 64, 65
- multi-feeds, troubleshoot 130
- N**
- networks
 - connector illustration 8
 - firewalls, troubleshoot 131
 - IP settings 109
 - link speed 109
 - settings, change 109
 - solve problems 150
 - view and print settings 109
 - wireless communication setup 106
 - wireless settings 126
- noise information 167
- O**
- OCR
 - edit scanned documents 58
 - troubleshoot 138
- operating systems supported 165
- originals
 - scan 56
- OS X
 - HP Utility 117
- output tray
 - locating 7
- P**
- paper
 - clear jams 159
 - HP, order 21
 - jams 161
 - load tray 23
 - selecting 22
 - size, set for fax 69
 - skewed pages 130
 - specifications 166
 - troubleshoot feeding 129
- paper-feed problems, troubleshoot 129
- parallel phone systems
 - answering machine setup 196
 - countries/regions with 182
 - distinctive ringing setup 187
 - DSL setup 185
 - ISDN setup 186
 - modem and answering machine setup 197
 - modem and voice mail setup 201
 - modem setup 190
 - modem shared with voice line setup 193
 - PBX setup 186
 - separate line setup 184
 - setup types 183
 - shared line setup 188
- PBX system, set up with fax parallel phone systems 186
- phone cord
 - connected to correct port test failed 142
 - correct type test failed 143
- phone line, answer ring pattern 78
- phone support 123
- phone support period
 - period for support 123
- phone, fax from
 - receive 67
 - send, 63
- photos
 - insert USB flash drive 29
- power
 - troubleshoot 129
- power input, locating 8
- print
 - fax logs 84
 - fax reports 83
 - faxes 68
 - last fax details 85
 - printer status report 125
 - troubleshoot 129
- print settings
 - print quality 132
- print-carriage access door, locating 8
- printer control panel
 - locating 7
 - network settings 109
 - scan from 56
 - send faxes 62
- printer software (Windows)
 - about 116
 - opening 37, 116
- printer status report
 - information on 125
 - print 125
- printhead 157
 - clean 155
- printhead, align 156
- pulse dialing 79
- Q**
- quality, troubleshoot
 - copy 135
 - scan 139
- R**
- radio interference
 - regulatory information 174
- rear access panel
 - clear jams 159
 - illustration 8
- receive faxes
 - auto answer mode 77
 - automatically 67
 - blocking numbers 70
 - forwarding 69
 - manually 67
 - rings to answer 78
 - troubleshoot 145, 147
- recycle
 - ink cartridges 178
- redial options, setting 79
- reduce fax 70
- regulatory information 169, 174
- regulatory model number 169
- Reinstall the printhead 157
- replace ink cartridges 99
- reports
 - confirmation, fax 83
 - error, fax 84
 - fax test failed 141
 - printhead 155
- reprint
 - faxes from memory 68
- rings to answer 78
- S**
- save
 - faxes in memory 68
- scan
 - from printer control panel 56
 - from Webscan 57
 - OCR 58
 - quality 139
 - Scan screen 10
 - scan specifications 166

- slow 137
 - troubleshoot 137
 - Scan screen 10
 - scanner glass
 - clean 34
 - load originals 27
 - locating 7
 - second tray
 - use Tray 2 31
 - send faxes
 - basic fax 62
 - manually 63
 - memory, from 65
 - monitor dialing 64, 65
 - troubleshoot 145, 148
 - send scans
 - for OCR 58
 - troubleshoot 137
 - serial number 125
 - serial phone systems
 - countries/regions with 182
 - setup types 183
 - settings
 - network 109
 - speed, fax 79
 - volume, fax 80
 - Setup 10
 - setup
 - accessories 30
 - answering machine (parallel phone systems) 196
 - answering machine and modem (parallel phone systems) 197
 - computer modem (parallel phone systems) 190
 - computer modem and answering machine (parallel phone systems) 197
 - computer modem and voice line (parallel phone systems) 193
 - computer modem and voice mail (parallel phone systems) 201
 - distinctive ringing 78
 - distinctive ringing (parallel phone systems) 187
 - DSL (parallel phone systems) 185
 - fax scenarios 183
 - fax, with parallel phone systems 182
 - ISDN line (parallel phone systems) 186
 - PBX system (parallel phone systems) 186
 - separate fax line (parallel phone systems) 184
 - shared phone line (parallel phone systems) 188
 - test fax 204
 - voice mail (parallel phone systems) 189
 - voice mail and computer modem (parallel phone systems) 201
 - size
 - scans, troubleshoot 139
 - troubleshoot copy 135
 - skew, troubleshoot
 - copy 135
 - print 130
 - scan 139
 - software
 - OCR 58
 - Webscan 57
 - sound pressure 167
 - specifications
 - acoustic emissions 167
 - paper 166
 - physical 165
 - system requirements 165
 - speed
 - troubleshoot for scanner 137
 - speed dial
 - send fax 62
 - status
 - network configuration page 126
 - printer status report 125
 - status icons 9
 - stripes on scans, troubleshoot 139
 - subscriber identification code 77
 - supplies
 - printer status report 125
 - support 122
 - support process 122
 - system requirements 165
- T**
- technical information
 - copy specifications 166
 - fax specifications 167
 - scan specifications 166
 - telephone line, answer ring pattern 78
 - telephone wall jack, fax 142
 - telephone, fax from
 - receive 67
 - send 63
 - temperature specifications 165
 - tests, fax
 - dial tone, failed 144
 - failed 141
 - fax line condition 144
 - fax phone cord type test failed 143
 - hardware, failed 141
 - port connection, failed 142
 - setup 204
 - telephone wall jack 142
 - text
 - cannot be edited after scan, troubleshoot 138
 - missing from scan, troubleshoot 137
 - tone dialing 79
 - trays
 - clear jams 159
 - load paper 23
 - locating 7
 - paper-width guides illustration 7
 - troubleshoot feeding 129
 - troubleshoot
 - control panel help system 124
 - copy 135
 - copy quality 135
 - embedded web server 153
 - fax 141
 - fax dial tone test failed 144
 - fax hardware test failed 141
 - fax line test failed 144
 - fax phone cord connection test failed 142
 - fax phone cord type test failed 143
 - fax tests 141
 - fax wall jack test, failed 142
 - firewalls 131
 - jams, paper 161
 - missing or incorrect information 131
 - multiple pages are picked 130
 - network configuration page 126
 - nothing prints 131

- paper not picked up from tray
 - 129
- paper-feed problems 129
- power 129
- print 129
- printer status report 125
- printing problem 131
- receive faxes 145, 147
- scan 137
- scan quality 139
- send faxes 145, 148
- skewed copies 135
- skewed pages 130
- troubleshooting
 - solve network problems 150

U

- USB connection
 - port, locating 7, 8
- USB flash drive
 - insert 29

V

- view
 - network settings 109
- voice mail
 - set up with fax (parallel phone systems) 189
 - set up with fax and computer modem (parallel phone systems) 201
- volume
 - fax sounds 80

W

- wall jack test, fax 142
- web sites
 - customer support 122
 - environmental programs 177
- Webscan 57
- websites
 - accessibility information 4
- white bands or stripes,
 - troubleshoot
 - copies 136
 - scans 139
- Windows
 - system requirements 165
- wireless communication
 - regulatory information 174
 - set up 106
- wireless connection icons 9

© 2014 Hewlett-Packard Development Company, L.P.
www.hp.com



Free Manuals Download Website

<http://myh66.com>

<http://usermanuals.us>

<http://www.somanuals.com>

<http://www.4manuals.cc>

<http://www.manual-lib.com>

<http://www.404manual.com>

<http://www.luxmanual.com>

<http://aubethermostatmanual.com>

Golf course search by state

<http://golfingnear.com>

Email search by domain

<http://emailbydomain.com>

Auto manuals search

<http://auto.somanuals.com>

TV manuals search

<http://tv.somanuals.com>