



# HP Photosmart 2600/2700 series all-in-one

## User Guide



i n v e n t

HP Photosmart 2600/2700 series all-in-one



## **User Guide**

© Copyright 2004 Hewlett-Packard Development Company, L.P.

The information contained herein is subject to change without notice. Reproduction, adaptation or translation without prior written permission is prohibited, except as allowed under copyright laws.



Adobe and the Acrobat logo are either registered trademarks or trademarks of Adobe Systems Incorporated in the United States and/or other countries.

Windows®, Windows NT®, Windows ME®, Windows XP®, and Windows 2000® are U.S. registered trademarks of Microsoft Corporation.

Intel® and Pentium® are registered trademarks of Intel Corporation.

Energy Star® and Energy Star logo® are US registered marks of the United States Environmental Protection Agency.

Publication number: Q3450-90195

First edition: July 2004

## Notice

The only warranties for HP products and services are set forth in the express warranty statements accompanying such products and services. Nothing herein should be construed as constituting an additional warranty. HP shall not be liable for technical or editorial errors or omissions contained herein.

The Hewlett-Packard Company shall not be liable for incidental or consequential damages in connection with, or arising out of the furnishing, performance, or use of this document and the program material which it describes.

**Note:** Regulatory information can be found in the technical information chapter of this guide.



It is not lawful in many places to make copies of the following items. When in doubt, check with a legal representative first.

- Governmental paper or documents:
  - Passports
  - Immigration papers

- Selective service papers
- Identification badges, cards, or insignias

- Governmental stamps:
  - Postage stamps
  - Food stamps
- Checks or drafts drawn on Governmental agencies
- Paper currency, traveler's checks, or money orders
- Certificates of deposit
- Copyrighted works

## Safety information



**Warning** To prevent fire or shock hazard, do not expose this product to rain or any type of moisture.

Always follow basic safety precautions when using this product to reduce risk of injury from fire or electric shock.



**Warning** Potential shock hazard

- 1 Read and understand all instructions in the setup poster.
- 2 Use only a grounded electrical outlet when connecting the device to a power source. If you do not know whether the outlet is grounded, check with a qualified electrician.
- 3 Observe all warnings and instructions marked on the product.
- 4 Unplug this product from wall outlets before cleaning.
- 5 Do not install or use this product near water or when you are wet.
- 6 Install the product securely on a stable surface.
- 7 Install the product in a protected location where no one can step on or trip over the line cord, and where the line cord will not be damaged.
- 8 If the product does not operate normally, see the online Troubleshooting help.
- 9 No operator-serviceable parts inside. Refer servicing to qualified service personnel.
- 10 Use in a well-ventilated area.



**Warning** This equipment will be inoperable when mains power fails.

# Contents

<b>1</b>	<b>HP all-in-one overview</b> .....	<b>5</b>
	The HP all-in-one at a glance.....	5
	Control panel overview.....	6
	Menu Overview.....	10
	Use the HP Image Zone to do more with your HP all-in-one.....	12
<b>2</b>	<b>Find more information</b> .....	<b>19</b>
<b>3</b>	<b>Connection information</b> .....	<b>21</b>
	Supported connection types.....	21
	Connect using a USB cable.....	21
	Connect using Ethernet.....	21
	Connect using wireless.....	22
	Connect using the HP bt300 Bluetooth Wireless Printer Adapter.....	22
	Set Bluetooth security for your HP all-in-one.....	23
	Use Webscan.....	24
<b>4</b>	<b>Work with photos</b> .....	<b>27</b>
	Transfer photos.....	27
	Edit photos.....	28
	Share photos.....	30
	Print photos.....	31
<b>5</b>	<b>Load originals and load paper</b> .....	<b>35</b>
	Load an original.....	35
	Choose papers for printing and copying.....	36
	Load paper.....	37
	Avoid paper jams.....	43
<b>6</b>	<b>Use a memory card or PictBridge camera</b> .....	<b>45</b>
	The memory card slots and camera port.....	45
	Control memory card security on a network.....	46
	Transfer photos to your computer.....	46
	Print photos from a proof sheet.....	48
	Set photo print options.....	50
	Use the edit features.....	52
	Print photos directly from a memory card.....	53
	Print photos from a PictBridge-compatible digital camera.....	55
	Use quick print to print the current photo.....	55
	Print a DPOF file.....	55
	Use the slide show feature.....	56
	Share photos through HP Instant Share.....	57
	Use the HP Image Zone.....	58
<b>7</b>	<b>Use the copy features</b> .....	<b>59</b>
	Set the copy paper size.....	59
	Set the copy paper type.....	60
	Increase copy speed or quality.....	61
	Select an input tray.....	61
	Change default copy settings.....	62
	Make multiple copies of the same original.....	62

	Copy a two-page black-and-white document.....	62
	Make a 10 by 15 cm (4 by 6 inch) borderless copy of a photo.....	63
	Copy a 10 by 15 cm (4 by 6 inch) photo onto a full-size page.....	63
	Copy a photo several times on one page.....	64
	Resize an original to fit onto letter or A4 paper.....	65
	Copy a faded original.....	65
	Copy a document that has been faxed several times.....	66
	Enhance light areas of your copy.....	66
	Make a poster.....	67
	Prepare a color iron-on transfer.....	68
	Stop copying.....	68
<b>8</b>	<b>Use the scan features.....</b>	<b>69</b>
	Scan to an application.....	69
	Send a scan to an HP Instant Share destination.....	71
	Send a scan to a memory card.....	72
	Stop scanning.....	73
<b>9</b>	<b>Print from your computer.....</b>	<b>75</b>
	Print from a software application.....	75
	Change the print settings.....	76
	Stop a print job.....	77
<b>10</b>	<b>Fax setup.....</b>	<b>79</b>
	Choose the right fax setup for your home or office.....	80
	Select your fax setup case.....	81
	Case A: Separate fax line (no voice calls received).....	83
	Case B: Set up your HP all-in-one with DSL.....	84
	Case C: Set up your HP all-in-one with a PBX phone system or an ISDN line.....	85
	Case D: Fax with a distinctive ring service on the same line.....	85
	Case E: Shared voice/fax line.....	87
	Case F: Shared voice/fax line with voice mail.....	88
	Case G: Fax line shared with PC modem (no voice calls received).....	89
	Case H: Shared voice/fax line with PC modem.....	90
	Case I: Shared voice/fax line with answering machine.....	94
	Case J: Shared voice/fax line with PC modem and answering machine.....	95
	Case K: Shared voice/fax line with PC modem and voice mail.....	99
	Test your fax setup.....	102
<b>11</b>	<b>Use the fax features.....</b>	<b>105</b>
	Set up the HP all-in-one to receive faxes.....	105
	Send a fax.....	107
	Receive a fax.....	111
	Set the date and time.....	112
	Set the fax header.....	113
	Enter text and symbols.....	113
	Print reports.....	115
	Set up speed dialing.....	116
	Change the fax resolution and lighter/darker settings.....	117
	Set fax options.....	118
	Reprint or delete the faxes in memory.....	123
	Fax over the Internet.....	123
	Stop faxing.....	124

<b>12</b>	<b>Use HP Instant Share (USB)</b> .....	<b>125</b>
	Overview.....	125
	Get started.....	126
	Send images using your HP all-in-one.....	126
	Send images using your computer.....	129
<b>13</b>	<b>Use HP Instant Share (networked)</b> .....	<b>133</b>
	Overview.....	133
	Get started.....	135
	Send images directly from your HP all-in-one.....	137
	Send images using your computer.....	140
	Receive images.....	142
	Print received images.....	143
	Remove received images.....	147
	Remote print documents.....	147
	Set HP Instant Share options.....	148
<b>14</b>	<b>Order supplies</b> .....	<b>151</b>
	Order paper, transparency film, or other media.....	151
	Order print cartridges.....	151
	Order accessories.....	151
	Order other supplies.....	152
<b>15</b>	<b>Maintain your HP all-in-one</b> .....	<b>155</b>
	Clean the HP all-in-one.....	155
	Check the estimated ink levels.....	156
	Print a self-test report.....	157
	Work with print cartridges.....	158
	Change the device settings.....	167
	Self-maintenance sounds.....	168
<b>16</b>	<b>Troubleshooting information</b> .....	<b>169</b>
	Before you call HP Support.....	169
	View the Readme file.....	170
	Setup troubleshooting.....	170
	Operational troubleshooting.....	192
	Device update.....	201
<b>17</b>	<b>Get HP support</b> .....	<b>203</b>
	Get support and other information from the Internet.....	203
	HP customer support.....	203
	Access your serial number and service ID.....	203
	Call in North America during warranty.....	204
	Call elsewhere in the world.....	204
	Call in Australia post-warranty.....	206
	Call HP Korea customer support.....	207
	Call HP Japan customer support.....	207
	Prepare your HP all-in-one for shipment.....	208
<b>18</b>	<b>Warranty information</b> .....	<b>213</b>
	Duration of limited warranty.....	213
	Warranty service.....	213
	Warranty upgrades.....	213
	Returning your HP all-in-one for service.....	213
	Hewlett-Packard limited global warranty statement.....	214

<b>19</b>	<b>Technical information</b>	<b>217</b>
	System requirements	217
	Paper specifications	217
	Print specifications	219
	Copy specifications	220
	Fax specifications	220
	Memory card specifications	221
	Scan specifications	221
	Physical specifications	221
	Power specifications	221
	Environmental specifications	221
	Additional specifications	222
	Environmental product stewardship program	222
	Regulatory notices	223
	Regulatory notices for wireless products	226
	Declaration of conformity (European Economic Area)	228
	HP Photosmart 2600 series declaration of conformity	228
	HP Photosmart 2700 series declaration of conformity	229
	<b>Index</b>	<b>231</b>

# 1 HP all-in-one overview

Many HP all-in-one functions can be accessed directly, without turning on your computer. Tasks such as making a copy, sending a fax, or printing photos from a memory card can be accomplished quickly and easily from your HP all-in-one. This chapter describes the HP all-in-one hardware features, control panel functions, and how to access the **HP Image Zone** software.

**Note** The HP Photosmart 2600 series and HP Photosmart 2700 series all-in-ones have slightly different features. Some of the features described in this guide might not apply to the model you purchased.

**Tip** You can do more with your HP all-in-one by using the **HP Image Zone** software installed on your computer. The software includes enhanced copy, fax, scan, and photo functionality, as well as troubleshooting tips and product-specific help. For more information, see the onscreen **HP Image Zone Help** and [Use the HP Image Zone](#) to do more with your HP all-in-one.

## The HP all-in-one at a glance

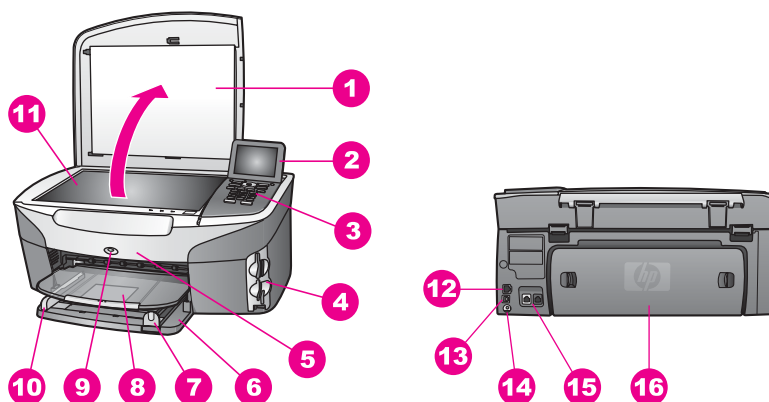

Label	Description
1	Lid
2	Color graphics display
3	Control panel
4	Memory card slots and PictBridge camera port
5	Print cartridge access door
6	Input tray



(continued)

Label	Description
7	Paper-length guide
8	Output tray
9	802.11b and g wireless radio on indicator (HP Photosmart 2700 series all-in-one only)
10	Paper-width guide
11	Glass
12	Ethernet port and Ethernet indicator lights
13	Rear USB port
14	Power connection
15	Fax ports (1-LINE and 2-EXT)
16	Rear clean-out door

**Note** The wireless radio on the HP Photosmart 2700 series all-in-one is on by default. The blue (wireless radio) light reflects the status of the wireless radio, and therefore remains on while the radio is on. If you connect your HP all-in-one using a USB or Ethernet cable, turn the wireless radio off. For information on turning off the wireless radio and the blue light, see the Network Guide that came with your HP all-in-one.

## Control panel overview

This section describes the functions of the control panel buttons, lights, and keypad, as well as the color graphics display icons and screen saver.

## Control panel features

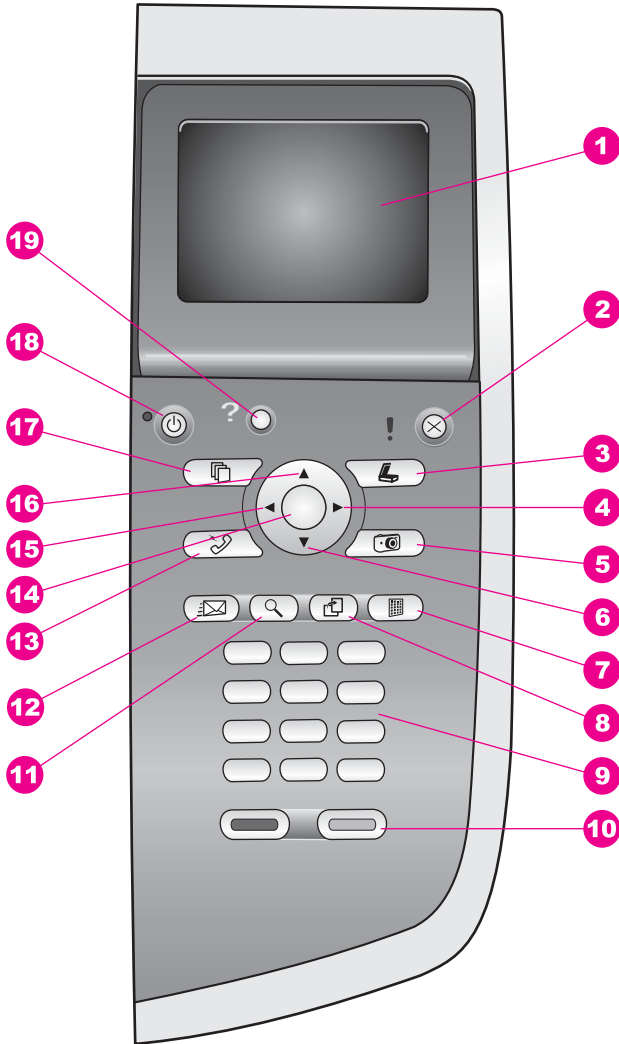









Label	Name and Description
1	<b>Color graphics display:</b> View menus, photos, and messages. The color graphics display can be pulled up and angled for better viewing.
2	<b>Cancel:</b> Stop a job, exit a menu, or exit settings.
3	<b>Scan:</b> Select the scan function. When the button is lit, the scan function is selected.

Label	Name and Description
4	<b>Right arrow:</b> Increase values, or go forward when viewing photos on the color graphics display.
5	<b>Photo:</b> Select the photo function. When the button is lit, the photo function is selected. Use this button to print photos from a memory card or to save photos to your computer.
6	<b>Down arrow:</b> Navigate down through menu options.
7	<b>Proof Sheet:</b> Print a proof sheet when a memory card has been inserted in a memory card slot. A proof sheet shows thumbnail views of all the photos on the memory card. You can select photos on the proof sheet, then print those photos by scanning the proof sheet.
8	<b>Rotate:</b> Rotate the currently displayed photo on the color graphics display 90 degrees. Subsequent presses continue to rotate the photo 90 degrees.  <b>Note</b> Rotate only affects printing in album mode.
9	<b>Keypad:</b> Enter fax numbers, values, or text.
10	<b>Start Black, Start Color:</b> Start a black or color copy, scan, fax, or memory card job.
11	<b>Zoom:</b> Enlarge the image on the color graphics display. You can also use this button to adjust the crop box when printing.
12	<b>HP Instant Share:</b> Access the HP Instant Share features.
13	<b>Fax:</b> Select the fax function. When the button is lit, the fax function is selected.
14	<b>OK:</b> Select a menu, setting, or value displayed on the color graphics display.
15	<b>Left arrow:</b> Decrease values, or go back when viewing photos on the color graphics display.
16	<b>Up arrow:</b> Navigate up through menu options.
17	<b>Copy:</b> Select the copy function. When the button is lit, the copy function is selected. The button is lit by default.
18	<b>On:</b> Turn the HP all-in-one on or off. When the HP all-in-one is off, a minimal amount of power is still supplied to the device. Unplug the power cord to completely disconnect the power supply to the HP all-in-one.
19	<b>Setup:</b> Access the menu system for reports, fax settings, and maintenance, as well as product-launched Help.

### Color graphics display icons

The following icons appear at the bottom of the color graphics display to provide important information about your HP all-in-one. Some of the icons appear only if your HP all-in-one has wireless network capability.

Icon	Purpose
	Shows that a print cartridge is nearly empty. The color on the bottom of the icon corresponds to the color on the top of the print cartridge. For example, the green icon represents the cartridge that has green on top, which is the tri-color print cartridge.
	Shows the ink level of the print cartridge represented by the color of the icon. This example shows the gray photo print cartridge.
	Left: shows that there is a wired connection. Right: shows that there is no wired connection.
	Shows that the HP all-in-one has wireless networking capability, but there is currently no wireless network connection. This is for infrastructure mode only. (HP Photosmart 2700 series all-in-one only)
	Shows that there is an ad hoc wireless network connection. (HP Photosmart 2700 series all-in-one only)
	Shows the signal strength of the wireless network connection. This is for infrastructure mode only. (HP Photosmart 2700 series all-in-one only)
	Shows that an HP Instant Share message has been received.
	Shows that HP Instant Share is set up, but polling is turned off.
	Shows that a Bluetooth adapter is installed, and there is a connection.

### Color graphics display screen saver

In order to prolong the life of the color graphics display, the display dims after two minutes of inactivity. After eight more minutes of inactivity (a total of ten minutes), the display goes into Screen Saver mode. After 60 minutes of inactivity, the color graphics display goes into Sleep State and the screen shuts off completely. The display turns back on when you perform an operation, such as pressing a control panel button, lifting the lid, inserting a memory card, accessing the HP all-in-one from a connected computer, or connecting a device to the front camera port.

## Menu Overview

The following tables provide a quick reference to top-level menus that appear on the HP all-in-one color graphics display.

### Copy Menu

Copy Menu
1. Number of Copies
2. Reduce/Enlarge
3. Tray Select
4. Paper Size
5. Paper Type
6. Copy Quality
7. Lighter/Darker
8. Enhancements
9. Color Intensity
0. Set New Defaults

### Scan To menu

The **Scan To** menu lists scan destinations, including applications installed on your computer. Therefore, your **Scan To** menu might list scan destinations different than the ones shown here.

Scan To (USB - Windows)
1. HP Image Zone
2. Microsoft PowerPoint
3. Adobe Photoshop
4. HP Instant Share
5. Memory Card

Scan To (USB - Macintosh)
1. JPEG to HP Gallery
2. Microsoft Word
3. Microsoft PowerPoint
4. HP Instant Share
5. Memory Card

### Scan Menu

When the HP all-in-one is connected to a network with one or more computers, the **Scan Menu** allows you to select a connected computer before displaying some options.

### Scan Menu (networked)

1. Select Computer
2. HP Instant Share
3. Memory Card

### Photo Menu

When the HP all-in-one is connected to one or more computers on a network, the **Photo Menu** shows a different set of options than when it is connected to a computer via a USB cable.

### Photo Menu

1. Print Options
2. Edit
3. Transfer to Computer
4. Slideshow
5. HP Instant Share

### Fax Menu

### Fax Menu

1. Resolution
2. Lighter/Darker
3. Set New Defaults

### Proof Sheet Menu

### Proof Sheet Menu

1. Print Proof Sheet
2. Scan Proof Sheet

### HP Instant Share menu

### HP Instant Share

1. Send
2. Receive
3. HP Instant Share Options

### Setup Menu

The **Help Menu** selection on the **Setup Menu** allows you to quickly find help on some key topics. Most of the information is presented on a connected Windows PC or

Macintosh computer screen. However, information about the color graphics display icons is presented on the color graphics display.

Setup Menu
1. Help Menu
2. Print Report
3. Speed Dial Setup
4. Basic Fax Setup
5. Advanced Fax Setup
6. Tools
7. Preferences
8. Network
9. HP Instant Share
0. Bluetooth

## Use the HP Image Zone to do more with your HP all-in-one

The **HP Image Zone** software is installed on your computer when you set up your HP all-in-one. For further information, see the Setup Guide that came with your device. Access to the **HP Image Zone** software differs by operating system (OS). For example, if you have a PC and are running Windows, the **HP Image Zone** software entry point is the **HP Director**. If you have a Macintosh and are running OS X V10.1.5 or later, the **HP Image Zone** software entry point is the **HP Image Zone** window. Regardless, the entry point serves as the launching pad for the **HP Image Zone** software and services.

You can quickly and easily expand the functionality of your HP all-in-one by using the **HP Image Zone** software. Look for boxes like this throughout the guide that provide topic-specific tips and helpful information for your projects.

### Access the HP Image Zone software (Windows)





Open the **HP Director** from the desktop icon, system tray icon, or from the **Start** menu. The **HP Image Zone** software features appear in the **HP Director**.

#### To open the HP Director

- Do one of the following:
  - On the Windows desktop, double-click the **HP Director** icon.
  - In the system tray at the far right of the Windows taskbar, double-click the **Hewlett-Packard Digital Imaging Monitor** icon.
  - On the taskbar, click **Start**, point to **Programs** or **All Programs**, select **HP**, and then click **HP Director**.
- In the **Select Device** box, click to see a list of installed devices.
- Select the HP all-in-one.

**Note** The icons in the **HP Director** graphic below might appear differently on your computer. The **HP Director** is customized to display icons associated with the device that is selected. If the selected device is not equipped with a particular feature or function, then the icon for that feature or function does not display in the **HP Director**.

**Tip** If the **HP Director** on your computer does not contain any icons, an error might have occurred during the software installation. To correct this, use the Control Panel in Windows to completely uninstall the **HP Image Zone** software; then reinstall the software. For more information, see the Setup Guide that came with your HP all-in-one.

Button	Name and Purpose
	<b>Scan Picture:</b> Scans a photo, picture, or drawing and displays it in the <b>HP Image Zone</b> .
	<b>Scan Document:</b> Scans a document that contains text or both text and graphics, and displays it in your selected program.
	<b>Make Copies:</b> Displays the Copy dialog box for the selected device, from which you can make a printed copy of your image or document. You can select the copy quality, number of copies, color, and size.
	<b>HP Image Zone:</b> Displays the <b>HP Image Zone</b> , where you can: <ul style="list-style-type: none"> <li>• View and edit images</li> <li>• Print photos in multiple sizes</li> <li>• Make and print a photo album, postcard, or flyer</li> <li>• Make a multimedia CD</li> <li>• Share images through e-mail or a website</li> </ul>
	<b>Transfer Images:</b> Displays the HP Image Transfer software, which allows you to transfer images from the HP all-in-one, and save them on your computer.

**Note** For information on additional features and menu items such as Software Update, Creative Ideas, and HP Shopping, see the onscreen **HP Image Zone Help**.

Menu and list items are also available to help you select the device you want to use, check its status, adjust a variety of software settings, and access the onscreen help. The following table explains these items.

Feature	Purpose
Help	Use this feature to access the <b>HP Image Zone Help</b> , which provides software help and troubleshooting information for your HP all-in-one.
Select Device	Use this feature to select the device you want to use from the list of installed devices.



Feature	Purpose
Settings	Use this feature to view or change various settings for your HP all-in-one, such as print, scan, or copy.
Status	Use this feature to display the current status of your HP all-in-one.

### Open the HP Image Zone software (Macintosh OS X v10.1.5 or later)

**Note** Macintosh OS X v10.2.1 and v10.2.2 are **not** supported.

When you install the **HP Image Zone** software, the **HP Image Zone** icon is placed in the Dock.

**Note** If you install more than one HP all-in-one, an **HP Image Zone** icon for each device is displayed in the Dock. For example, if you have an HP scanner and an HP all-in-one installed, two **HP Image Zone** icons are present in the Dock, one for each device. However, if you installed two of the same kind of device (for example, two HP all-in-ones) only one **HP Image Zone** icon is displayed in the Dock to represent all devices of that kind.

You can access the **HP Image Zone** software in one of two ways:

- Through the **HP Image Zone** window
- Through the **HP Image Zone** Dock menu

#### Open the HP Image Zone window

Select the **HP Image Zone** icon to open the **HP Image Zone** window. The **HP Image Zone** window has two main elements:

- The display area for the **Products/Services** tabs
  - The **Products** tab gives you access to many of the features of your HP imaging products, such as an installed products pop-up menu and a list of tasks available for the current product. The list may include tasks such as copy, scan, fax, or transfer images. Clicking on a task opens an application to assist you with that task.
  - The **Services** tab gives you access to digital imaging applications that can help you view, edit, manage, and share your images.
- The **Search HP Image Zone Help** text entry field  
The **Search HP Image Zone Help** text entry field lets you search **HP Image Zone Help** for keywords or phrases.





#### To open the HP Image Zone window

→ Click the **HP Image Zone** icon in the Dock.



The **HP Image Zone** window appears.

The **HP Image Zone** window displays only the **HP Image Zone** features that are appropriate for the selected device.

**Note** The icons in the table below might appear differently on your computer. The **HP Image Zone** window is customized to display feature icons associated with the device that is selected. If the selected device is not equipped with a particular feature or function, then that feature or function does not display in the **HP Image Zone** window.

Products	
Icon	Feature and Purpose
	<b>Unload Images:</b> Use this feature to transfer images from a memory card to your computer.
	<b>Scan Picture:</b> Use this feature to scan an image and display it in the <b>HP Gallery</b> .
	<b>Scan to OCR:</b> Use this feature to scan text and display it in the selected destination text editing software program.  <b>Note</b> Availability of this feature varies by country/region.
	<b>Make Copies:</b> Use this feature to make a copy in black and white or color.

## Services

Icon	Feature and Purpose
	<b>HP Gallery:</b> Use this feature to display the <b>HP Gallery</b> to view and edit images.
	<b>HP Image Print:</b> Use this feature to print images from an album using one of several templates available.
	<b>HP Instant Share:</b> Use this feature to open the <b>HP Instant Share</b> client application software. From the client application software you can share photos with family and friends using <b>HP Instant Share E-mail</b> or upload photos to an online photo album or online photo finishing service.

In addition to the feature icons, several menu and list items allow you to select the device you want to use, adjust a variety of software settings, and access the onscreen help. The following table explains these items.

Feature	Purpose
Select Device	Use this feature to select the device you want to use from a list of installed devices.
Settings	Use this feature to view or change various settings for your HP all-in-one, such as print, scan, or copy.

Feature	Purpose
Search <b>HP Image Zone Help</b>	Use this feature to search the <b>HP Image Zone Help</b> , which provides software help and troubleshooting information for your HP all-in-one.

### Display the HP Image Zone Dock menu

The **HP Image Zone** Dock menu provides a shortcut to **HP Image Zone** services. The Dock menu automatically contains all of the applications available in the **HP Image Zone** window **Services** tab list. You can also set **HP Image Zone** preferences to add other items to the menu, such as tasks from the **Products** tab list or **HP Image Zone Help**.

### To display the HP Image Zone Dock menu

- Do one of the following:
- Set either **HP Gallery** or **iPhoto** as your preferred photo manager.
  - Set additional options associated with your preferred photo manager.
  - Customize the list of items displayed in the **HP Image Zone** Dock menu.

### Access the HP Image Zone software (Macintosh OS earlier than X v10.1.5)

**Note** Macintosh OS 9 v9.1.5 and later and v9.2.6 and later **are** supported. Macintosh OS X v10.0 and v10.0.4 are **not** supported.

The **HP Director** is the entry point to the **HP Image Zone** software. Depending on the capabilities of your HP all-in-one, the **HP Director** lets you initiate device functions such as scanning, copying, faxing, or unloading images from a digital camera or memory card. You can also use the **HP Director** to open the **HP Gallery** to view, modify, and manage the images on your computer.

Use one of the following methods to open the **HP Director**. The methods are Macintosh OS specific..

- Macintosh OS X: The **HP Director** opens automatically during **HP Image Zone** software installation, and an **HP Director** icon is created in the Dock for your device. To display the **HP Director** menu:

In the Dock, click the **HP Director** icon for your device.

The **HP Director** menu appears.

**Note** If you install several HP devices of different kinds (for example, an HP all-in-one, a camera, and an HP scanner), an **HP Director** icon for each kind of device is displayed in the Dock. However, if you install two of the same kind of device (for example, you may have a laptop that you connect to two different HP all-in-one devices -- one at work and one at home) only one **HP Director** icon is displayed in the Dock to represent all devices of that kind.





- Macintosh OS 9: The **HP Director** is a standalone application that must be opened before its features can be accessed. Use one of the following methods to open the **HP Director**:

- Double-click the **HP Director** alias on the desktop.
- Double-click the **HP Director** alias in the **Applications:Hewlett-Packard:HP Photo and Imaging Software** folder.

The **HP Director** displays only the task buttons that pertain to the selected device.

**Note** The icons in the table below might appear differently on your computer. The **HP Director** menu is customized to display feature icons associated with the device that is selected. If the selected device is not equipped with a particular feature or function, then the icon for that feature or function does not display.

## Device Tasks

Icon	Purpose
	<p><b>Unload Images:</b> Use this feature to transfer images from a memory card to your computer.</p> <p><b>Note</b> Macintosh OS 9: Image transfer from a memory card to your computer is <b>not</b> supported over a network.</p>
	<p><b>Scan Picture:</b> Use this feature to scan an image and display it in the <b>HP Gallery</b>.</p>
	<p><b>Scan Document:</b> Use this feature to scan text and display it in the selected destination text editing software program.</p> <p><b>Note</b> Availability of this feature varies by country/region.</p>
	<p><b>Make Copies:</b> Use this feature to make a copy in black and white or color.</p>

## Manage and Share

Icon	Purpose
	<p><b>HP Gallery:</b> Use this feature to display the <b>HP Gallery</b> to view and edit images.</p>

In addition to the **HP Gallery** feature, several menu items without icons allow you to select other applications on your computer, change feature settings on your HP all-in-one, and access the onscreen help. The following table explains these items.

---







**Manage and Share**

---

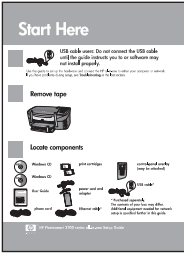
Feature	Purpose
More Applications	Use this feature to select other applications on your computer.
HP on the Web	Use this feature to select an HP website.
HP Help	Use this feature to select a source for help with your HP all-in-one.
Settings	Use this feature to view or change various settings for your HP all-in-one, such as print, scan, or copy.

# 2 Find more information

A variety of resources, both printed and onscreen, provide information about setting up and using your HP all-in-one.

 The cover of the 'Start Here' guide features a white background with a grey header. It includes a 'Remove tape' section with an image of the device and a 'Locate components' section with small images of various parts like the scanner, printer, and paper tray.	<b>Setup Guide</b> <p>The Setup Guide provides instructions for setting up your HP all-in-one and installing software. Make sure you follow the steps in order.</p> <p>If you have problems during setup, see Troubleshooting in the last section of the Setup Guide, or the Troubleshooting chapter in this guide.</p>
 The cover of the 'User Guide' for the HP Photosmart 2600 series printer shows a black and white image of the printer against a light background. The HP logo is visible in the bottom right corner.	<b>User Guide</b> <p>The User Guide contains information on how to use your HP all-in-one, including troubleshooting tips and step-by-step instructions.</p>
 The cover of the 'HP All-in-One Network Guide' features a white background with a grey header and a central image showing the printer connected to a network setup.	<b>Network Guide</b> <p>The Network Guide contains information on setting up and connecting your HP all-in-one to a network.</p>
 A simple icon of a compass rose, indicating a tour or orientation.	<b>HP Image Zone Tour</b> <p>The HP Image Zone Tour is a fun, interactive way to get a brief overview of the software included with your HP all-in-one. You'll learn how <b>HP Image Zone</b> can help you edit, organize, and print your photos.</p>
 An icon representing the HP Director software, showing a document and a printer.	<b>HP Director</b> <p>The HP Director provides easy access to the software applications, default settings, status, and onscreen Help for your HP device. To start the <b>HP Director</b>, double-click the <b>HP Director</b> icon from your desktop.</p>
 A screenshot of the HP Image Zone Help interface, showing a search bar and a list of help topics.	<b>HP Image Zone Help</b>

Find more information

	<p>The HP Image Zone Help provides detailed information on using the software for your HP all-in-one.</p> <ul style="list-style-type: none"><li>• The <b>Get step-by-step instructions</b> topic provides information on using the <b>HP Image Zone</b> software with HP devices.</li><li>• The <b>Explore what you can do</b> topic provides more information about the practical and creative things you can do with the <b>HP Image Zone</b> software and your HP devices.</li><li>• If you need further assistance or want to check for HP software updates, see the <b>Troubleshooting and support</b> topic.</li></ul>
	<p><b>Onscreen help from your device</b></p> <p>Onscreen help is available from your device and contains additional information on select topics. Access the onscreen help from the control panel. From the <b>Setup</b> menu, highlight the <b>Help</b> menu item and press <b>OK</b>.</p>
	<p><b>Readme</b></p> <p>The Readme file contains the most recent information which might not be found in other publications. Install the software to access the Readme file.</p>
<p><a href="http://www.hp.com/support">www.hp.com/support</a></p>	<p>If you have Internet access, you can get help and support from the HP website. This website offers technical support, drivers, supplies, and ordering information.</p>

# 3 Connection information

Your HP all-in-one comes equipped with networking capability. It also comes equipped with a USB port so you can connect directly to a computer using a USB cable. If you insert an HP bt300 Bluetooth® Wireless Printer Adapter into the PictBridge camera port (USB host port) on the front of your HP all-in-one, Bluetooth devices such as PDAs and camera phones can print to your HP all-in-one.

## Supported connection types

Description	Recommended number of connected computers for best performance	Supported software features	Setup instructions
USB connection	One computer connected by means of a USB cable to the device.	All features are supported.	Follow the Setup Guide for detailed instructions.
Ethernet (wired) connection	Up to five computers connected by means of a hub or router.	All features are supported, including Webscan.	Follow the Setup and Network Guides for detailed instructions.
802.11b or g (wireless) connection (HP Photosmart 2700 series all-in-one only)	Up to five computers connected by means of an access point. (infrastructure mode)	All features are supported, including Webscan.	Follow the Setup and Network Guides for detailed instructions.
HP bt300 Bluetooth® Wireless Printer Adapter (HP bt300)	Not applicable.	Printing.	Follow the instructions in <a href="#">Connect using the HP bt300 Bluetooth Wireless Printer Adapter</a> .

Connection information

## Connect using a USB cable

Detailed instructions for connecting a computer to your HP all-in-one using a USB cable are included in the Setup Guide that came with your device.

## Connect using Ethernet

The HP Photosmart 2600/2700 series all-in-one supports both 10 Mbps and 100 Mbps Ethernet network connections. Detailed instructions on connecting your HP all-in-one to an Ethernet (wired) network are included in the Setup and Network Guides that came with your device.



## Connect using wireless

The HP Photosmart 2700 series all-in-one uses an internal networking component that supports a wireless network. Detailed instructions on connecting your HP all-in-one to a wireless (802.11b or g) network are included in the Setup and Network Guides that came with your device.

## Connect using the HP bt300 Bluetooth Wireless Printer Adapter

The HP bt300 allows you to print images from most Bluetooth devices directly to your HP all-in-one without a cable connection. Simply insert the HP bt300 into the PictBridge camera port located on the front of the HP all-in-one and print from a Bluetooth device such as a PDA or camera phone.

**Note** Using Bluetooth technology to print from a PC or laptop to your HP all-in-one is not supported at this time.

### To connect the HP bt300 to your HP all-in-one

- 1 Insert the HP bt300 into the PictBridge camera port (shown in the graphic below).

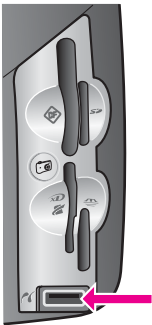

**Note** If you insert the HP bt300 into your HP all-in-one and a message displays on your color graphics display that says **No Bluetooth**, disconnect the adapter from the HP all-in-one and refer to [Device update](#).

- 2 Some Bluetooth devices exchange device addresses when they communicate with each other and establish a connection. If your Bluetooth device requires the address of your HP all-in-one to make a connection:
  - a Press **Setup** on the control panel of your HP all-in-one.  
The **Setup Menu** appears on the color graphics display.
  - b Press **0**, then press **1**.  
This displays the **Bluetooth** menu and then selects **Device Address**.  
The **Device Address** for your HP all-in-one displays. It is read only.
  - c To enter the address into your device, follow the instructions that came with your Bluetooth device.
- 3 Some Bluetooth devices display the printer's device name when connected. If your Bluetooth device displays the printer's name:
  - a Press **Setup** on the control panel of your HP all-in-one.  
The **Setup Menu** appears on the color graphics display.
  - b Press **0**, then press **2**.

This displays the **Bluetooth** menu and then selects **Device Name**.  
The **Device Name** screen appears.

**Note** Your HP all-in-one ships with the predefined name of **TBD**.

- c Use the visual keyboard on the **Device Name** screen to enter a new name.  
For more information on using the visual keyboard, see [Enter text and symbols](#).
- d When you have finished entering a name for your HP all-in-one, highlight **Done** on the visual keyboard and press **OK**.  
The name you entered will appear on your Bluetooth device when you connect to the HP all-in-one to print.

## Set Bluetooth security for your HP all-in-one

You can enable printer security settings through the **Bluetooth** menu on your HP all-in-one. Simply press **Setup** on the control panel, and select **Bluetooth** from the **Setup Menu**. From the **Bluetooth** menu, you can:

- Require passkey authentication prior to someone printing to your HP all-in-one from a Bluetooth device
- Make your HP all-in-one visible or invisible to Bluetooth devices that are within range

### Use a passkey to authenticate Bluetooth devices

You can set the security level of your HP all-in-one to either **Low** or **High**:

- **Low**: The HP all-in-one does not require a passkey. Any Bluetooth device within range can print to it.
- **High**: The HP all-in-one requires a passkey from the Bluetooth device before allowing the device to send a print job to it.

### To set your HP all-in-one to require passkey authentication

- 1 Press **Setup** on the control panel of your HP all-in-one.  
The **Setup Menu** appears on the color graphics display.
- 2 Press **0**, then press **3**.  
This displays the **Bluetooth** menu and then selects **Passkey**.  
The **Passkey** screen appears.  
  
**Note** Your HP all-in-one ships with a predefined passkey that is set to four zeroes.
- 3 Use the numbered keypad on the control panel of your HP all-in-one to enter a new passkey.  
For more information on using the keypad, see [Enter text and symbols](#).
- 4 When you have finished entering your passkey, press **OK**.  
The **Bluetooth** menu appears.
- 5 Press **5**.  
This selects **Security Level** and displays the **Security Level** menu.
- 6 Press **1** to select **High**.  
High level security requires authentication.

**Note** The default security setting is **Low**. Low level security does not require authentication.

Passkey authentication is now set for your HP all-in-one.

### Set your HP all-in-one to be invisible to Bluetooth devices

You can set your HP all-in-one to be either **Visible to all** Bluetooth devices (public) or **Not visible** to any (private):

- **Visible to all:** Any Bluetooth device within range can print to the HP all-in-one.
- **Not visible:** Only Bluetooth devices that have stored the device address of the HP all-in-one can print to it.

#### To set your HP all-in-one to be Not visible

- 1 Press **Setup** on the control panel of your HP all-in-one. The **Setup Menu** appears on the color graphics display.
- 2 Press **0**, then press **4**. This displays the **Bluetooth** menu and then selects **Accessibility**. The **Accessibility** menu appears.

**Note** Your HP all-in-one ships with a default accessibility level of **Visible to all**.

- 3 Press **2** to select **Not visible**.

Your HP all-in-one is inaccessible to Bluetooth devices that have not stored its device address.

### Reset Bluetooth settings on your HP all-in-one

If you want to reconfigure all of the Bluetooth settings on your HP all-in-one, you can reset them to factory defaults by performing the following:

- 1 Press **Setup** on the control panel of your HP all-in-one. The **Setup Menu** appears on the color graphics display.
- 2 Press **0**, then press **6**. This displays the **Bluetooth** menu and then selects **Reset Bluetooth**.

**Note** Only select **Reset Bluetooth** if you want all of your HP all-in-one Bluetooth settings returned to factory defaults.

## Use Webscan

Webscan lets you perform a basic scan through your HP all-in-one using just a Web browser. It also lets you perform the scan from your HP all-in-one without the device software installed on your computer. Just enter the IP address of the HP all-in-one in a Web browser and access the HP all-in-one embedded Web server Home page and Webscan.

The user interface for Webscan is unique to using the HP all-in-one and does not support scan-to destinations like the **HP Image Zone** scanning software. The e-mail functionality of Webscan is limited, so it is recommended you use the **HP Image Zone** scanning software for this feature instead.

#### To use Webscan

- 1 Enter the IP address of the HP all-in-one in a Web browser on your computer.

**Note** For more information on printing a network configuration page to obtain the IP address of your HP all-in-one, see the Network Guide that came with your device.

The embedded Web server **Home** page appears in the browser window.

- 2 In the left hand column, under **Applications**, select **Scan**.
- 3 Follow the onscreen instructions.



# 4 Work with photos

Your HP all-in-one allows you to transfer, edit, share, and print photos in several different ways. This chapter contains a brief overview of the wide range of options for performing each of these tasks, depending on your preferences and computer setup. More detailed information for each task is available in other chapters within this guide, or in the onscreen **HP Image Zone Help** that came with your software.

## Transfer photos

You have several different options for transferring photos. You can transfer photos to your HP all-in-one, your computer, or a memory card. For more information, see the section below specific to your operating system.

### Transfer photos using a Windows PC

The graphic below shows several methods for transferring photos to your Windows PC, HP all-in-one, or a memory card. For more information, see the list below the graphic.

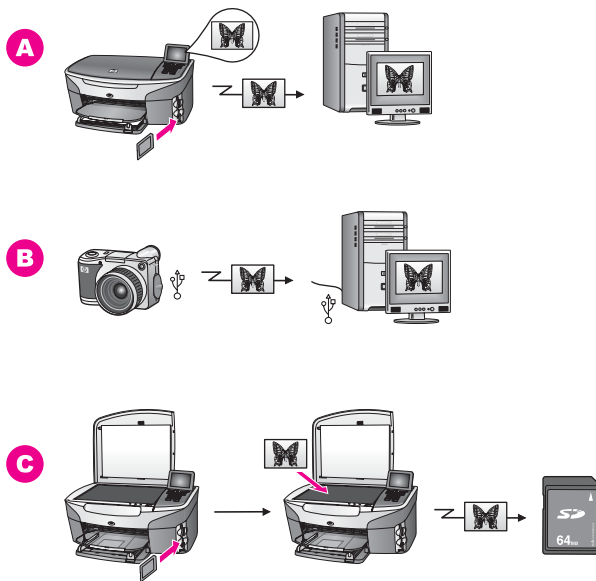

<b>A</b>	Transfer a photo from a memory card inserted into your HP all-in-one to your Windows PC.
<b>B</b>	Transfer a photo from your HP digital camera to your Windows PC.
<b>C</b>	Transfer a photo by scanning a photo directly onto a memory card inserted into your HP all-in-one.

## Transfer photos using a Macintosh

The graphic below shows several methods for transferring photos to your Macintosh, HP all-in-one, or a memory card. For more information, see the list below the graphic.

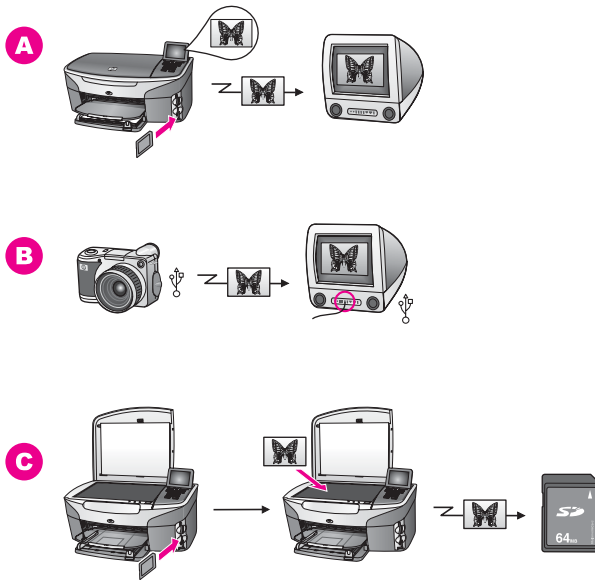

<b>A</b>	Transfer a photo from a memory card inserted into your HP all-in-one to your Macintosh.
<b>B</b>	Transfer a photo from your HP digital camera to your Macintosh.
<b>C</b>	Transfer a photo by scanning a photo directly onto a memory card inserted into your HP all-in-one.

## Edit photos

You have several different options for editing photos. For more information, see the section below specific to your operating system.

### Edit photos using a Windows PC

The graphic below shows two methods for editing photos using a Windows PC. For more information, see the list below the graphic.

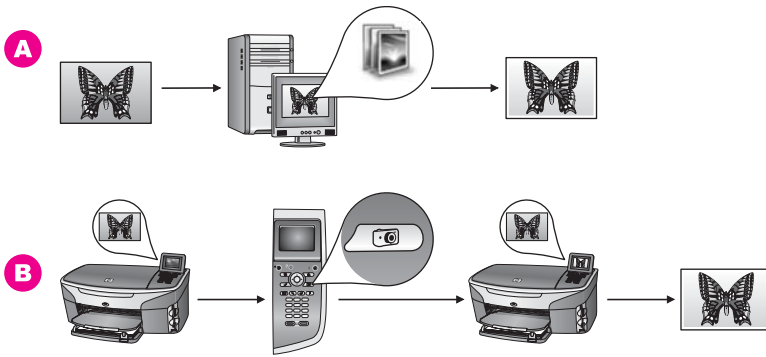

- |          |  |
|----------|--|
| <b>A</b> | Edit a photo on your Windows PC using the <b>HP Image Zone</b> software. |
| <b>B</b> | Edit a photo using the control panel on your HP all-in-one.              |

### Edit photos using a Macintosh

The graphic below shows three methods for editing photos using a Macintosh. For more information, see the list below the graphic.

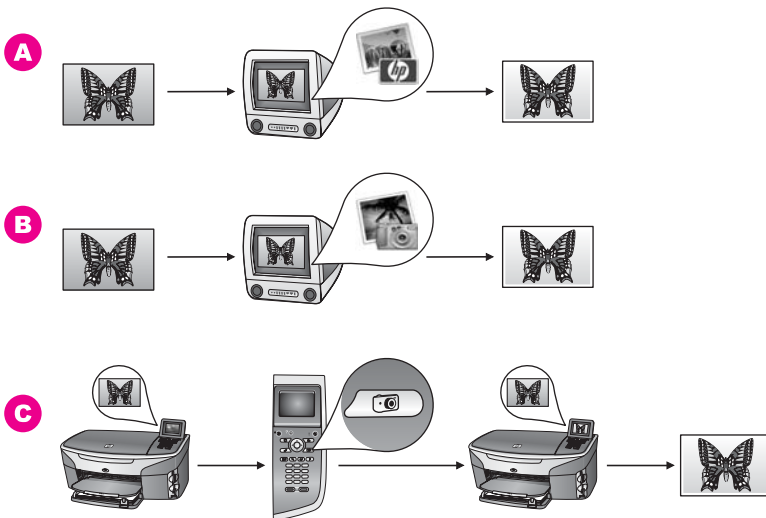

- |          |   |
|----------|---|
| <b>A</b> | Edit a photo on your Macintosh using the <b>HP Image Zone</b> software. |
| <b>B</b> | Edit a photo on your Macintosh using the iPhoto software.               |
| <b>C</b> | Edit a photo using the control panel on your HP all-in-one.             |



## Share photos

You have several different options for sharing photos with friends and family. For more information, see the section below specific to your operating system.

### Share photos using a Windows PC

The graphic below shows several methods for sharing photos using a Windows PC. For more information, see the list below the graphic.

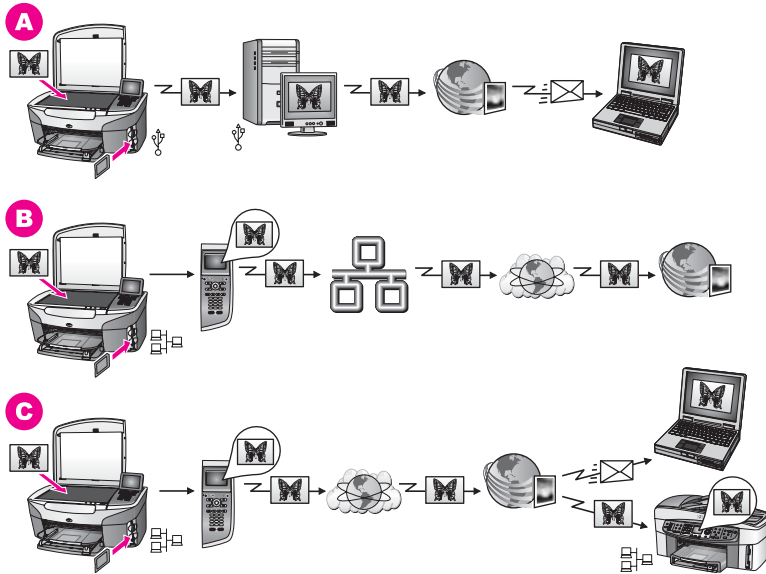

<b>A</b>	Share photos from your USB-connected HP all-in-one using the HP Instant Share service. Transfer photos from your USB-connected HP all-in-one to your computer, where you use the HP Instant Share software to send the photos through the HP Instant Share service as an e-mail to your friends or family.
<b>B</b>	Share photos from your network-connected HP all-in-one through the Internet to the HP Instant Share service, where the photos are stored in an online photo album.
<b>C</b>	Share photos from your network-connected HP all-in-one through the Internet to the HP Instant Share service. The HP Instant Share service can then send the photos to friends or family as an e-mail, or they can be sent to another network-connected HP all-in-one.

### Share photos using a Macintosh

The graphic below shows several methods for sharing photos using a Macintosh. For more information, see the list below the graphic.

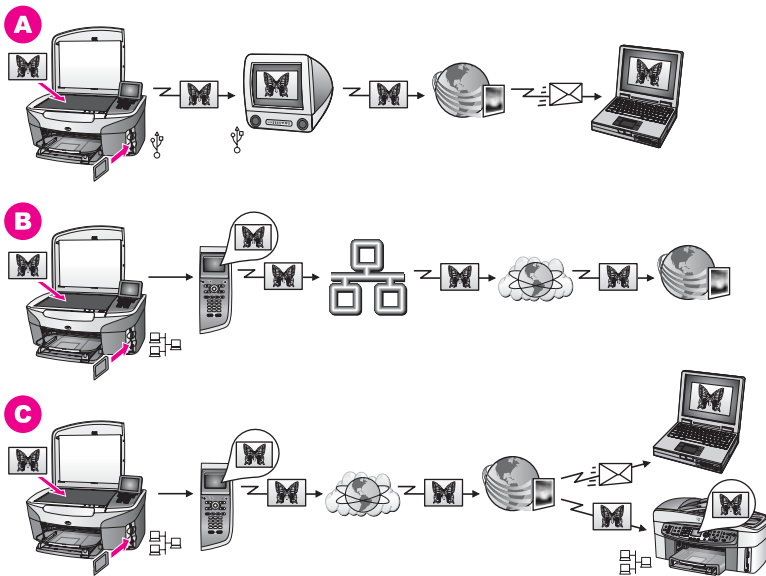

<b>A</b>	Share photos from your USB-connected HP all-in-one using the HP Instant Share service. Transfer photos from your USB-connected HP all-in-one to your computer, where you use the HP Instant Share software to send the photos through the HP Instant Share service as an e-mail to your friends or family.
<b>B</b>	Share photos from your network-connected HP all-in-one through the Internet to the HP Instant Share service, where the photos are stored in an online photo album.
<b>C</b>	Share photos from your network-connected HP all-in-one through the Internet to the HP Instant Share service. The HP Instant Share service can then send the photos to friends or family as an e-mail, or they can be sent to another network-connected HP all-in-one.

## Print photos

You have several different options for printing photos. For more information, see the section below specific to your operating system.

### Print photos using a Windows PC

The graphic below shows several methods for printing photos using a Windows PC. For more information, see the list below the graphic.

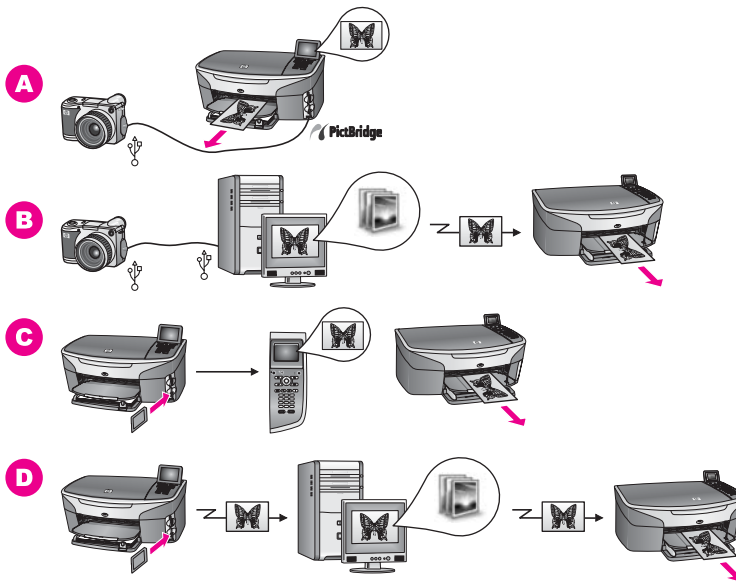

<b>A</b>	<p>Print photos from your PictBridge digital camera using PictBridge.</p> <p><b>Note</b> If your digital camera is an HP model that does not support PictBridge, you can still print directly to the HP all-in-one. Connect the camera to the USB port on the back of the HP all-in-one instead of to the camera port. This works with HP digital cameras only.</p>
<b>B</b>	Print photos from your camera using a software application on your computer.
<b>C</b>	Print photos from a memory card using the control panel on the HP all-in-one.
<b>D</b>	Print photos from a memory card by transferring photos to your Windows PC and printing them using the <b>HP Image Zone</b> software.

### Print photos using a Macintosh

The graphic below shows several methods for printing photos using a Macintosh. For more information, see the list below the graphic.

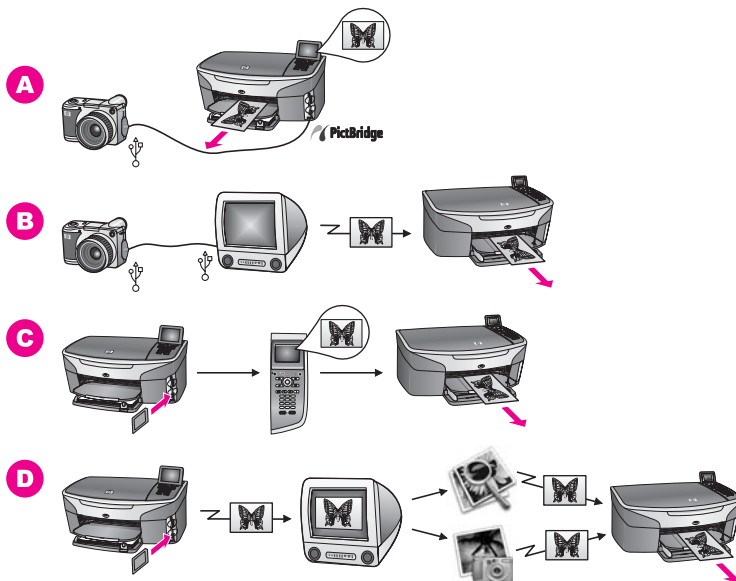

<p><b>A</b></p>	<p>Print photos from your PictBridge digital camera using PictBridge.</p> <p><b>Note</b> If your digital camera is an HP model that does not support PictBridge, you can still print directly to the HP all-in-one. Connect the camera to the USB port on the back of the HP all-in-one instead of to the camera port. This works with HP digital cameras only.</p>
<p><b>B</b></p>	<p>Print photos from your camera using a software application on your computer.</p>
<p><b>C</b></p>	<p>Print photos from a memory card using the control panel on the HP all-in-one.</p>
<p><b>D</b></p>	<p>Print photos from a memory card by transferring photos to your Macintosh and printing them using the <b>HP Gallery</b> software or the <b>HP Director</b> software.</p>



# 5 Load originals and load paper

This chapter provides instructions for loading originals on the glass to copy, scan, or fax; choosing the best paper type for your job; loading paper in the input tray; and avoiding paper jams.

## Load an original

You can copy, scan, or fax up to letter- or A4-size originals by loading them on the glass, as described here. You should also follow these instructions when loading a proof sheet on the glass for photo printing.

**Note** Many of the special features will not work correctly if the glass and lid backing are not clean. For more information, see [Clean the HP all-in-one](#).

### To load an original on the glass

- 1 Lift the lid and place your original face down on the right front corner of the glass. If you are loading a proof sheet, make sure the top of the proof sheet is lined up against the right edge of the glass.

**Tip** For more help on loading an original, refer to the guides along the front and right edges of the glass.

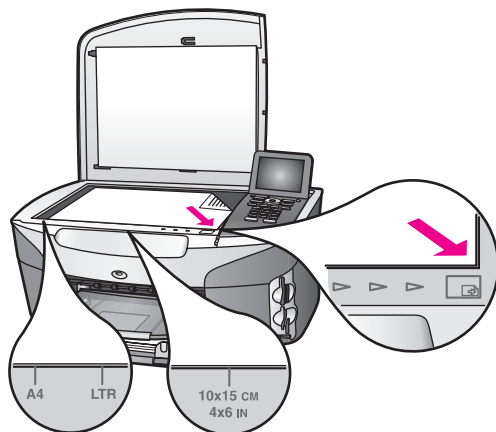

- 2 Close the lid.

**Tip** You can copy or scan oversized originals by completely removing the lid from your HP all-in-one. To remove the lid, lift the lid to the open position, grasp the sides of the lid, and then pull the lid upward. Your HP all-in-one functions normally with the lid removed. Replace the lid by inserting the tabs on the hinge back into the appropriate slots.

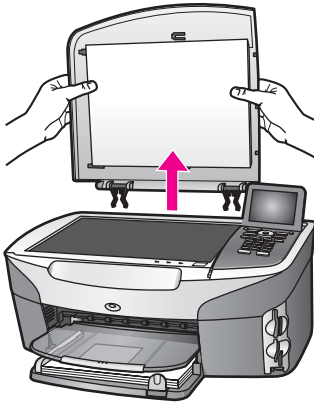

## Choose papers for printing and copying

You can use many types and sizes of paper in your HP all-in-one. Review the following recommendations to get the best printing and copying quality. Whenever you change paper types or sizes, remember to change those settings.

### Recommended papers

If you want the best print quality, HP recommends using HP papers that are specifically designed for the type of project you are printing. If you are printing photos, for example, load glossy or matte photo paper in the input tray. If you are printing a brochure or presentation, use a type of paper specifically designed for that purpose.

For more information about HP papers, see the onscreen **HP Image Zone Help**, or go to [www.hp.com/support](http://www.hp.com/support).

### Papers to avoid

Using paper that is too thin, paper that has a slick texture, or paper that stretches easily can cause paper jams. Using paper that has a heavy texture or does not accept ink can cause printed images to smear, bleed, or not fill in completely.

### We do not recommend printing to the following papers:

- Paper with cutouts or perforations (unless specifically designed for use with HP inkjet devices).
- Highly textured stock, such as linen. It may not print evenly, and the ink can bleed into these papers.
- Extremely smooth, shiny, or coated papers not specifically designed for your HP all-in-one. They can jam the HP all-in-one or repel the ink.
- Multi-part forms (such as duplicate and triplicate forms). They can wrinkle or get stuck. The ink is also more likely to smear.
- Envelopes with clasps or windows.

### We do not recommend copying to the following papers:

- Any size paper other than letter, A4, 10 by 15 cm (4 by 6 inch), 5 by 7 inch, Hagaki, or L. Depending on your country/region, some of these papers might not be available to you.
- Paper with cutouts or perforations (unless specifically designed for use with HP inkjet devices).
- Photo paper other than HP Premium Photo Paper or HP Premium Plus Photo Paper.
- Envelopes.
- Banner paper.
- Transparency film other than HP Premium Inkjet Transparency Film or HP Premium Plus Inkjet Transparency Film.
- Multiple-part forms or label stock.

## Load paper

This section describes the procedure for loading different types and sizes of paper into your HP all-in-one for your copies, printouts, or faxes.

**Tip** To help prevent rips, wrinkles, and curled or bent edges, store all paper flat in a resealable bag. If the paper is not stored properly, extreme changes in temperature and humidity might result in curled paper that does not work well in the HP all-in-one.

### Load full-size paper

You can load many types of letter, A4, or legal paper into the main input tray of your HP all-in-one.

**Tip** If you have the optional HP 250 Sheet Plain Paper Tray installed, you can load an additional 250 sheets of plain letter or A4 paper into the lower tray. Paper loaded in the optional lower tray is only available for printouts you print from the software applications on your computer. It is not available for copying or printing received faxes.

### To load full-size paper in the main input tray

- 1 Remove the output tray, and slide the paper-width and paper-length guides to their outermost positions.



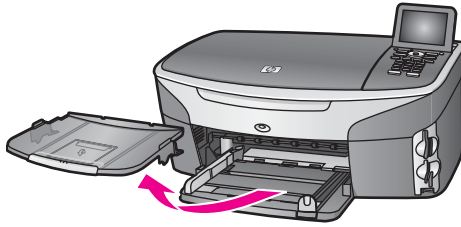

- 2 Tap a stack of paper on a flat surface to align the edges, and then check the paper for the following:
  - Make sure it is free of rips, dust, wrinkles, and curled or bent edges.
  - Make sure all the paper in the stack is the same size and type.
- 3 Insert the stack of paper into the input tray with the short edge forward and the print side down. Slide the stack of paper forward until it stops.

**Tip** If you are using letterhead, insert the top of the page first with the print side down. For more help on loading full-size paper and letterhead, refer to the diagram engraved in the base of the input tray.

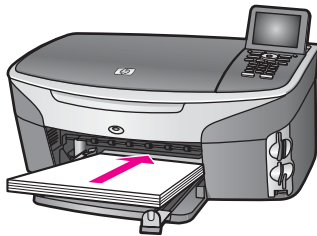

- 4 Slide the paper-width and paper-length guides inward until they stop at the edges of the paper. Do not overload the input tray; make sure the stack of paper fits within the input tray and is no higher than the top of the paper-width guide.



- 5 Replace the output tray.

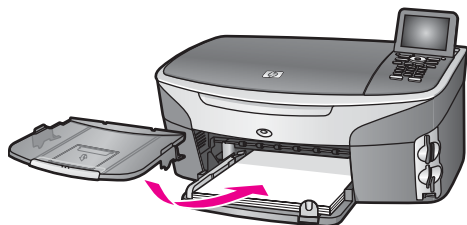

- 6 Fully extend the output tray extender to catch completed copy, print, or fax jobs.

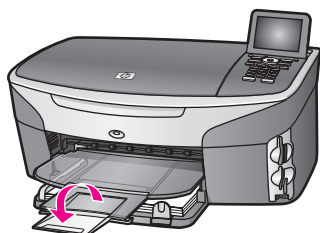

### To load full-size plain paper in the optional lower tray

- The HP 250 Sheet Plain Paper Tray is available as an accessory for this product. For information on loading paper in this accessory, read and follow the instructions that came with the accessory.

### Load 10by 15cm (4by 6inch) photo paper

You can load 10 by 15 cm (4 by 6 inch) photo paper into the main input tray of your HP all-in-one, or into an optional rear input tray. (In Japan, this accessory is called the Hagaki Tray with Auto Two-sided Print Accessory. Elsewhere, it is called the HP Auto Two-sided Print Accessory with Small Paper Tray.)

For the best results, use a recommended type of 10 by 15 cm (4 by 6 inch) photo paper, and set the paper type and size for your print or copy job. For more information, see the onscreen **HP Image Zone Help**.

**Tip** To help prevent rips, wrinkles, and curled or bent edges, store all paper flat in a resealable bag. If the paper is not stored properly, extreme changes in temperature and humidity might result in curled paper that does not work well in the HP all-in-one.

### To load 10 by 15 cm (4 by 6 inch) photo paper in the main input tray

- 1 Remove the output tray.
- 2 Remove all paper from the input tray.
- 3 Insert the stack of photo paper into the far right side of the input tray with the short edge forward and the glossy side down. Slide the stack of photo paper forward until it stops.

If the photo paper you are using has perforated tabs, load the photo paper so that the tabs are closest to you.

**Tip** For more help on loading small-size photo paper, refer to the icons engraved in the base of the input tray for loading photo paper (indicated by paper and camera icons). To make sure you have pushed the photo paper far enough forward, look for the engraved dotted lines in the base of the input tray. These indicate how far forward the paper must be loaded.

- 4 Slide the paper-length and paper-width guides inward against the stack of photo paper until they stop.  
Do not overload the input tray; make sure the stack of photo paper fits within the input tray and is no higher than the top of the paper-width guide.

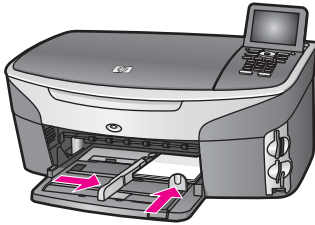

- 5 Replace the output tray.

#### To load 10 by 15 cm (4 by 6 inch) photo paper in the optional rear tray

- The HP Auto Two-sided Print Accessory with Small Paper Tray and the Hagaki Tray with Auto Two-sided Print Accessory are available for this product. For information on loading paper in either of these accessories, read and follow the instructions that came with the accessory.

### Load postcards or Hagaki cards

You can load postcards or Hagaki cards into the main input tray of your HP all-in-one, or into an optional rear input tray. (In Japan, this accessory is called the Hagaki Tray with Auto Two-sided Print Accessory. Elsewhere, it is called the HP Auto Two-sided Print Accessory with Small Paper Tray.)

For the best results, set the paper type and size before printing or copying. For more information, see the onscreen **HP Image Zone Help**.

#### To load postcards or Hagaki cards in the main input tray

- 1 Remove the output tray.
- 2 Remove all paper from the input tray.
- 3 Insert the stack of cards into the far right side of the input tray with the short edge forward and the print side down. Slide the stack of cards forward until it stops.

**Tip** For more help on loading postcards or Hagaki cards, refer to the icons engraved in the base of the input tray for loading photo paper (indicated by paper and camera icons).

- 4 Slide the paper-length and paper-width guides inward against the stack of cards until they stop.  
Do not overload the input tray; make sure the stack of cards fits within the input tray and is no higher than the top of the paper-width guide.

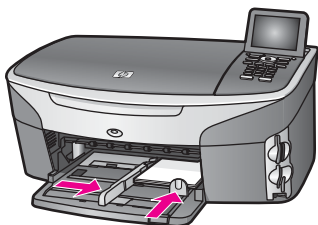

- 5 Replace the output tray.

### To load postcards or Hagaki cards in the optional rear tray

- The HP Auto Two-sided Print Accessory with Small Paper Tray and the Hagaki Tray with Auto Two-sided Print Accessory are available for this product. For information on loading paper in either of these accessories, read and follow the instructions that came with the accessory.

### Load envelopes

You can load one or more envelopes into the input tray of your HP all-in-one. Do not use shiny or embossed envelopes or envelopes that have clasps or windows.

**Note** For specific details on how to format text for printing on envelopes, consult the help files in your word processing software. For best results, consider using a label for the return address on envelopes.

### To load envelopes

- 1 Remove the output tray.
- 2 Remove all paper from the input tray.
- 3 Insert one or more envelopes into the far right side of the input tray with the envelope flaps up and to the left. Slide the stack of envelopes forward until it stops.

**Tip** For more help on loading envelopes, refer to the diagram engraved in the base of the input tray.

- 4 Slide the paper-length and paper-width guides inward against the stack of envelopes until they stop.  
Do not overload the input tray; make sure the stack of envelopes fits within the input tray and is no higher than the top of the paper-width guide.

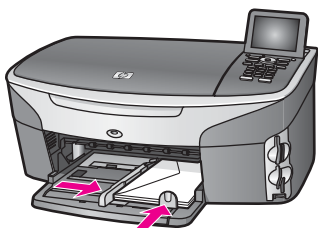

- 5 Replace the output tray.

## Load other types of paper

The following table provides guidelines for loading certain types of paper. For best results, adjust the paper settings each time you change paper sizes or paper types. For information on changing paper settings, see the onscreen **HP Image Zone Help**.

**Note** Not all paper sizes and paper types are available with all the functions on the HP all-in-one. Some paper sizes and paper types can only be used if you are starting a print job from the **Print** dialog box in a software application. They are not available for copying, faxing, or printing photos from a memory card or digital camera. Papers that are only available for printing from a software application are indicated as such, below.

Paper	Tips
HP papers	<ul style="list-style-type: none"> <li>● HP Premium Paper: Locate the gray arrow on the nonprinting side of the paper, and then slide the paper into the input tray with the arrow side facing up.</li> <li>● HP Premium Inkjet Transparency Film: Insert the film so that the white transparency strip (with arrows and the HP logo) is on top and is going into the input tray first. <ul style="list-style-type: none"> <li><b>Note</b> The HP all-in-one might not automatically detect transparency film if it is loaded incorrectly, or if you use transparency film other than HP transparency film. For best results, set the paper type to transparency film before printing or copying onto transparency film.</li> </ul> </li> <li>● HP Iron-On Transfers: Flatten the transfer sheet completely before using it; do not load curled sheets. (To prevent curling, keep transfer sheets sealed in the original package until you are ready to use them.) Locate the blue stripe on the nonprinting side of the transfer paper and then manually feed one sheet at a time into the input tray with the blue stripe facing up.</li> <li>● HP Matte Greeting Cards, HP Photo Greeting Cards, or HP Textured Greeting Cards: Insert a small stack of HP greeting card paper into the input tray with the print side down; slide the stack of cards forward until it stops.</li> </ul>
Labels (for printing from a software application only)	<p>Always use letter or A4 label sheets designed for use with HP inkjet devices (such as Avery inkjet labels), and make sure that the labels are not more than two years old. Labels on older sheets might peel off when the paper is pulled through the HP all-in-one, causing subsequent paper jams.</p> <ol style="list-style-type: none"> <li>1 Fan the stack of labels to make sure none of the pages are sticking together.</li> <li>2 Place a stack of label sheets on top of full-size plain paper in the input tray, label side down. Do not insert labels one sheet at a time.</li> </ol>
Continuous banner paper	<p>Continuous banner paper is also known as computer or z-fold paper.</p> <ol style="list-style-type: none"> <li>1 Remove the output tray.</li> </ol>

(continued)

Paper	Tips
(for printing from a software application only)	2 Remove all paper from the input tray.
	<b>Note</b> Leave the output tray off of the HP all-in-one while the banner prints to prevent the continuous banner paper from tearing.
	3 Verify that the stack of banner paper contains at least five pages in the stack.
	<b>Note</b> If you use non-HP banner paper, make sure you use 20-lb. paper.
	4 Carefully tear off the perforated edge strips from both sides of the paper stack, if any, and unfold and refold the paper to make sure the pages do not stick together.
	5 Slide the paper into the input tray so that the unattached edge is at the top of the stack.
6 Insert the first edge into the input tray until it stops, as shown below.	
	

## Avoid paper jams

To help avoid paper jams, follow these guidelines:

- Prevent curled or wrinkled paper by storing all unused paper flat in a resealable bag.
- Remove printed papers from the output tray frequently.
- Ensure that paper loaded in the input tray lays flat and the edges are not bent or torn.
- Do not combine different paper types and paper sizes in the input tray; the entire stack of paper in the input tray must be the same size and type.
- Adjust the paper guides in the input tray to fit snugly against all paper. Make sure the paper guides do not bend the paper in the input tray.
- Do not force paper too far forward in the input tray.
- Use paper types that are recommended for your HP all-in-one. For more information, see [Choose papers for printing and copying](#).

For information about clearing paper jams, see [Paper troubleshooting](#).



# 6 Use a memory card or PictBridge camera

The HP all-in-one can access the memory cards used in most digital cameras so you can print, store, manage, and share your photos. You can insert the memory card into the HP all-in-one, or connect your camera directly, letting the HP all-in-one read the contents of the memory card while it is still in the camera.

This chapter contains information on using memory cards or a PictBridge camera with your HP all-in-one. Read this chapter for information on transferring photos to your computer, setting photo print options, printing photos, editing photos, viewing slide shows, and sharing photos with your family and friends.

## The memory card slots and camera port

If your digital camera uses a memory card to store photos, you can insert the memory card in your HP all-in-one to print or save your photos.

You can print a proof sheet, which might be several pages long and shows thumbnail views of photos stored on the memory card, and print photos from the memory card, even if your HP all-in-one is not connected to a computer. You can also connect a digital camera that supports PictBridge to the HP all-in-one through the camera port and print directly from the camera.

Your HP all-in-one can read the following memory cards: CompactFlash (I, II), Memory Sticks, MultiMediaCard (MMC), Secure Digital, SmartMedia, and xD-Picture Card.

**Note** You can scan a document and send the scanned image to an inserted memory card. For more information, see [Send a scan to a memory card](#).

Your HP all-in-one features four slots for memory cards, shown in the following illustration, with the memory cards that correspond to each slot.

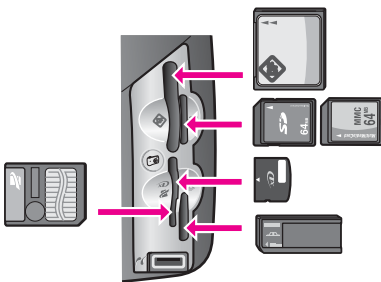

The slots are configured as follows:

- Top left slot: CompactFlash (I, II)
- Top right slot: Secure Digital, MultiMediaCard (MMC)
- Bottom left slot: SmartMedia, xD-Picture Card (fits in top right of the slot)



- Bottom right slot: Memory Stick, Magic Gate Memory Stick, Memory Stick Duo (with user-supplied adapter), Memory Stick Pro
- PictBridge camera port (below the memory card slots): compatible with any USB-equipped digital camera that supports PictBridge

**Note** The camera port only supports USB-equipped digital cameras that support PictBridge. If you attach a USB device that is not a compatible digital camera (or Bluetooth adapter) to the camera port, an error message appears on the color graphics display. If you have an older HP-brand digital camera, try using the USB cable that came with the camera. Plug it into the USB port on the back of the HP all-in-one and not into the camera port near the memory card slots. This works with HP digital cameras only.

**Tip** By default, Windows XP will format a memory card of 8 MB or less and 64 MB or more with the FAT32 format. Digital cameras and other devices use the FAT (FAT16 or FAT12) format and cannot operate with a FAT32 formatted card. Either format your memory card in your camera or select FAT format to format your memory card in a Windows XP PC.

## Control memory card security on a network

Your HP all-in-one, if networked, lets computers on your network access the contents of memory cards. When used on a wireless network that does not have wireless encryption enabled, anyone within wireless range who knows your network name and the HP all-in-one network ID can access the contents of your memory card while it is inserted in the HP all-in-one.

You can increase the privacy of data on your memory cards by establishing a WEP (Wired Equivalent Privacy) key or WPA/PSK (Wi-Fi Protected Access/Pre-Shared Key) on your wireless network or by setting the HP all-in-one so it never shares an inserted memory card with networked computers, wireless or not. This means that other computers on your network will also not be able to access the files on the memory card.

For more information on adding encryption to a wireless network, see the Network Guide.

**Note** The HP all-in-one never shares the contents of a memory card in a digital camera that is connected to the HP all-in-one through the camera port.

- 1 Press **Setup**.
- 2 Press **8**, and then press **3**.  
This displays the **Network menu** and then selects **Advanced Setup**.
- 3 Press **3** to select **Memory Card Security**.
- 4 Press the number next to the desired security option:
  - **1. Share Files**
  - **2. Do Not Share Files**

## Transfer photos to your computer

After you take photos with your digital camera, you can print them immediately or save them directly to your computer. To save them to your computer, you need to remove the

memory card from the camera and insert it in the appropriate memory card slot on the HP all-in-one.

**Note** You can only use one memory card in your HP all-in-one at a time.

- 1 Insert the memory card into the appropriate slot on your HP all-in-one. When the memory card is inserted correctly, the **Photo** button on the control panel begins to blink. **Reading photos...** appears on the color graphics display. The status light next to the memory card slots blinks green when the card is being accessed.

If you insert a memory card incorrectly, the status light next to the memory card slots blinks amber and the color graphics display shows an error message such as **Card is in backwards** or **Card is not fully inserted**.



**Warning** Never attempt to remove a memory card while it is being accessed. Doing so can damage files on the card. You can safely remove a card only when the status light next to the slots is not blinking.

- 2 If there are photo files on the memory card that have never been transferred before, a dialog box on your computer asks whether you want to save the photo files to your computer. If the HP all-in-one is on a network, you must press **Photo** to display the **Photo Menu**, press **3** to select **Transfer to computer**, and then select your computer from the displayed list. Return to your computer and follow the onscreen prompts.
- 3 Click the option to save.

This saves all the new photos from the memory card to your computer.

**For Windows:** by default, files are saved in month and year folders depending on when the photos were taken. The folders are created under the **C:\Documents and Settings\username\My Documents\My Pictures** folder in Windows XP and Windows 2000.

**For Macintosh:** by default, files are saved to the computer in a **Hard Drive: Documents:HP All-in-One Data:Photos** folder (OS 9) or **Hard Drive:Users:User Name:Pictures:HP Photos** folder (OS X).

**Tip** You can also use the control panel to transfer memory card files to an attached computer. Press **Photo**, and then press **3** to select **Transfer to computer**. Follow the prompts on the computer. In addition, the memory card appears as a drive on your computer. You can move the photo files from the memory card to the desktop.

If there are no new files on the memory card, when the HP all-in-one finishes reading the memory card the **Photo** button stops blinking and stays lit, and the status light next to the memory card slots remains lit. The first photo on the memory card appears on the color graphics display.

To navigate through the photos on the memory card, press **◀** or **▶** to move backward or forward through the photos, one photo at a time. Press and hold **◀** or **▶** to move rapidly backward or forward through the photos.

**Note** You can also use the Image Capture application on your Macintosh to unload images. For more information, see the documentation that came with your Macintosh.

## Print photos from a proof sheet

A proof sheet is a simple and convenient way to select photos and make prints directly from a memory card without the need for a computer. A proof sheet, which might be several pages long, shows thumbnail views of photos stored on the memory card. The file name, index number, and date appear under each thumbnail. Proof sheets are also a quick way to create a printed catalog of your photos. In order to print photos using a proof sheet, you need to print the proof sheet, complete it, and then scan it.

**Note** You can only print a proof sheet for a memory card inserted into the HP all-in-one. You cannot print photos from a PictBridge camera connected to the PictBridge camera port.

Printing photos from a proof sheet is done in three steps: printing a proof sheet, completing the proof sheet, and scanning the proof sheet. This section contains detailed information on all three steps.

**Tip** You can also improve the quality of the photos you print with the HP all-in-one by purchasing a photo or gray photo print cartridge. With the tri-color print cartridge and photo print cartridge installed, you have a six-ink system, which provides enhanced quality color photos. With the tri-color print cartridge and the gray photo print cartridge installed, you can print a full range of gray tones, which provides enhanced quality black-and-white photos. For more information on the photo print cartridge, see [Use a photo print cartridge](#). For more information on the gray photo print cartridge, see [Use a gray photo print cartridge](#).

### Print a proof sheet

The first step in using a proof sheet is to print it from the HP all-in-one.

- 1 Insert the memory card into the appropriate slot on your HP all-in-one.
- 2 Press **Proof Sheet**, and then press **1**.  
This displays the **Proof Sheet Menu** and then selects **Print Proof Sheet**.

**Note** Depending on how many photos are on the memory card, the time it takes to print a proof sheet can vary greatly.

- 3 If there are more than 20 photos on the card, the **Select Photos Menu** appears. Press the number next to the command you want to select:
  - **1. All**
  - **2. Last 20**
  - **3. Custom Range**

**Note** Use the proof sheet index number to select which photos to print for a custom range. This number might be different from the number associated with the photo on your digital camera. If you add or delete photos from your memory card, reprint the proof sheet to see accurate index numbers.

- 4 If you choose **Custom Range**, enter the photo index numbers for the first and last photos you want to print.

**Note** You can erase index numbers by pressing ◀ to backspace.

## Complete the proof sheet

After you have printed a proof sheet, you can use it to select the photos you want to print.

**Note** You might want to use a photo print cartridge for superior print quality. With the tri-color and photo print cartridges installed, you have a six-ink system. For more information, see [Use a photo print cartridge](#).



- 1 Select the photos to print by using a dark pen or pencil to fill in the circles located under the thumbnail images on the proof sheet.
- 2 Select one layout style by filling in a circle in step 2 of the proof sheet.

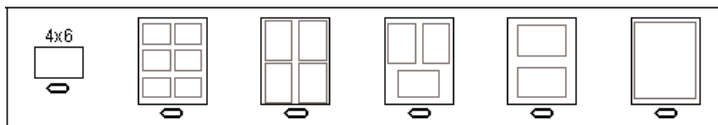

**Note** If you need more control over print settings than the proof sheet provides, you can print photos directly from the control panel. For more information, see [Print photos directly from a memory card](#).

## Scan a proof sheet

The final step in using a proof sheet is to scan the completed sheet you have placed on the scanner glass.

**Tip** Make sure the glass of the HP all-in-one is completely clean or the proof sheet might not scan properly. For more information, see [Clean the glass](#).

- 1 Load the proof sheet face down on the right front corner of the glass. Make sure the sides of the proof sheet touch the right and front edges. Close the lid.

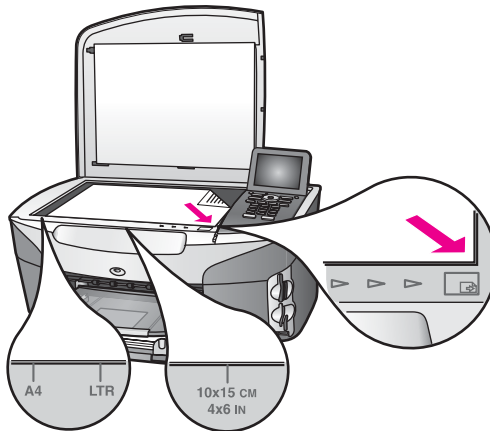

- 2 Load 10 by 15 cm (4 by 6 inch) photo paper in the input tray. Make sure the same memory card you used to print the proof sheet is still in the slot when you scan that proof sheet.
- 3 Press **Proof Sheet**, and then press **2**.  
This displays the **Proof Sheet Menu** and then selects **Scan Proof Sheet**. The HP all-in-one scans the proof sheet and prints the selected photos.

## Set photo print options

From the control panel of your HP all-in-one, you can control how your photos will print, including paper type and size, layout, and more.

This section contains information on the following topics: setting photo print options, changing print options, and setting new photo print option defaults.

You access and set photo print options from the **Photo Menu** available through the control panel on your HP all-in-one.

**Tip** You can also use the **HP Image Zone** software to set photo print options. For more information, see the **HP Image Zone Help**.

### Use the print options menu to set photo print options

The **Print Options** menu gives you access to a variety of settings that affect the way photos print, including number of copies, paper types, and more. The default measurements and sizes vary according to country/region.

- 1 Insert a memory card into the appropriate slot on your HP all-in-one.
- 2 Press **Photo**.  
The **Photo Menu** appears.
- 3 Press **1** to access the **Print Options** menu, and then press the number next to the setting you want to change.

Setting	Description
1. Number of Copies	Lets you set the number of copies to be printed.

Setting	Description
2. Image Size	<p>Lets you set the size at which you want the image printed. Most choices are self-explanatory, but two require some explanation: <b>Fill Entire Page</b> and <b>Fit to Page</b>.</p> <p>The <b>Fill Entire Page</b> setting scales the image to cover all of the printable area on the paper. If you inserted photo paper in the input tray, there will not be a white border around the photo. Some cropping may occur. <b>Fit to Page</b> scales the image to cover as much of the page as possible while keeping the original aspect ratio without cropping. The image is centered on the page and is surrounded by a white border.</p>
3. Tray Select	<p>Lets you select the input tray (front or rear) that the HP all-in-one should use. This setting is only available if a rear tray is detected when you turn on the HP all-in-one.</p>
4. Paper Size	<p>Lets you select the paper size for the current print job. The <b>Automatic</b> setting defaults to a large (letter or A4) and small 10 by 15 cm (4 by 6 inch) paper size that varies by country/region. When <b>Paper Size</b> and <b>Paper Type</b> are both set to <b>Automatic</b>, the HP all-in-one selects the best print options for the current print job. The other <b>Paper Size</b> settings let you override the automatic settings.</p>
5. Paper Type	<p>Lets you select the paper type for the current print job. The <b>Automatic</b> setting lets the HP all-in-one detect and set the paper type automatically. When <b>Paper Size</b> and <b>Paper Type</b> are both set to <b>Automatic</b>, the HP all-in-one selects the best options for the current print job. The other <b>Paper Type</b> settings let you override the automatic settings.</p>
6. Layout Style	<p>Lets you select one of three layout styles for the current print job.</p> <p>The <b>Paper Saver</b> layout fits as many photos on the paper as possible, rotating and cropping photos if necessary.</p> <p>The <b>Album</b> layouts keep the orientation of the original photos. Some cropping might occur.</p>
7. Smart Focus	<p>Lets you enable or disable automatic digital sharpening of photos. <b>Smart Focus</b> affects only printed photos. It does not change the appearance of photos on the color graphics display or the actual image file on the memory card. <b>Smart Focus</b> is enabled by default.</p>

Setting	Description
8. Digital Flash	Lets you make dark photos appear lighter. <b>Digital Flash</b> affects only printed photos. It does not change the appearance of photos on the color graphics display or the actual image file on the memory card. <b>Digital Flash</b> is turned off by default.
9. Set New Defaults	Lets you save the current <b>Print Options</b> settings as the new defaults.

### Change print options

You change each of the **Print Options** menu settings in the same way.

- 1 Press **Photo**, **1**, and then press the number next to the setting you want to change. You can scroll through the **Print Options** menu by pressing ▼ on the control panel to see all the options.  
The currently selected option is highlighted, and its default setting (if any) appears below the menu, at the bottom of the color graphics display.
- 2 Make the change to the setting, and then press **OK**.

**Note** Press **Photo** again to exit the **Print Options** menu and return to the photo display.

### Set new photo print options defaults

You can change the photo print options defaults from the control panel.

- 1 Press **Photo**, and then press **1**.  
The **Print Options** menu appears.
- 2 Make changes to any options as needed.  
The **Print Options** menu reappears when you confirm a new setting for any option.
- 3 Press **9** when the **Print Options** menu is showing, and then press **OK** when prompted to set new defaults.

All the current settings become the new defaults.

## Use the edit features

The HP all-in-one offers several basic editing controls that you can apply to the image currently displayed on the color graphics display. These controls include brightness adjustment, special color effects, and more.

This section contains information on the following topics: editing images on the HP all-in-one, and using the **Zoom** or **Rotate** functions.

### Edit images on the HP all-in-one

You can apply these editing controls on the photo currently being viewed. The edits apply to printing and viewing only; they are not saved to the image itself.

- 1 Press **Photo** and then press **2**.  
The **Edit** menu appears.
- 2 Select the Edit option you want to use by pressing the corresponding number.

Edit Option	Purpose
1. Photo Brightness	Lets you make the displayed image lighter or darker. Press ◀ to make the image darker. Press ▶ to make it lighter.
2. Color Effect	Displays a menu of special color effects you can apply to the image. <b>No Effect</b> leaves the image untouched. <b>Sepia</b> applies a brown tone found in photos from the 1900s. <b>Antique</b> is similar to <b>Sepia</b> , but with pale colors added so the image looks hand-tinted. <b>Black &amp; White</b> provides the same output as if you pressed <b>Start Black</b> .
3. Frame	Lets you apply a frame and frame color to the current image.
4. Redeye	Lets you remove red eye from photos. <b>On</b> makes red eye removal active. <b>Off</b> turns red eye removal off. The default is <b>Off</b> .

## Use the Zoom or Rotate functions

You can zoom in or out of a photo or rotate a photo before you print it. Zoom and Rotate settings apply only to the current print job. The settings are not saved with the photo.

### To use the Zoom feature

- 1 Display a photo on the color graphics display.
- 2 Press **Zoom**, and then press **1** to zoom out or **3** to zoom in to view the photo at different sizes. Use the arrow keys to pan around the photo and see the approximate area of the photo that will print.
- 3 Press **Start Color** or **Start Black** to print the photo.
- 4 Press **Cancel** to exit the Zoom function and return the photo to its original state.

### To use the Rotate feature

- 1 Display a photo on the color graphics display.
- 2 Press **Rotate** to rotate the photo 90 degrees clockwise at a time.
- 3 Press **Start Color** or **Start Black** to print the photo.
- 4 Press **Rotate** until the photo returns to its original state.

## Print photos directly from a memory card

You can insert a memory card in your HP all-in-one and use the control panel to print photos. For information on printing photos on your HP all-in-one from a PictBridge-compatible camera, see [Print photos from a PictBridge-compatible digital camera](#).

This section contains information on the following topics: printing individual photos, creating borderless photos, and deselecting photos.

**Note** When printing photos, you should select options for the correct paper type and photo enhancement. For more information, see [Set photo print options](#). You might also want to use the photo print cartridge for superior print quality. For more information, see [Use a photo print cartridge](#).



You can do more than print your photos if you use the **HP Image Zone** software. This software lets you use photos for iron-on transfers, posters, banners, stickers, and other creative projects. For more information, see the onscreen **HP Image Zone Help**.

### Print individual photos

You can print photos directly from the control panel without using a proof sheet.

- 1 Insert the memory card into the appropriate slot on your HP all-in-one. The **Photo** button lights up.
- 2 Display a photo on the color graphics display and press **OK** to select it for printing. A selected photo bears a checkmark. Use ◀ or ▶ to move backward or forward through the photos, one photo at a time. Press and hold ◀ or ▶ to move rapidly through the photos.

**Note** You can also select photos to print by entering the index numbers of the photos you want to print. Press the pound key (#) to specify a range: 21-30. Press **OK** when you are finished entering the photo index numbers. If you do not know the photo index number, print a photo proof sheet before selecting individual photos to print.

- 3 Press **Photo** to display the **Photo Menu**, and then modify the photo print options as desired. The print option settings revert back to the default settings after the print job is completed.
- 4 Press **Start Black** or **Start Color** to print the selected photos.

### Create borderless prints

An exceptional feature of your HP all-in-one is its ability to turn photos on a memory card into professional, borderless prints.

- 1 Insert the memory card into the appropriate slot on your HP all-in-one. The **Photo** button lights up.
- 2 Display a photo on the color graphics display and press **OK** to select it for printing. A selected photo bears a checkmark. Use ◀ or ▶ to move backward or forward through the photos, one photo at a time. Press and hold ◀ or ▶ to move rapidly through the photos.

**Note** You can also select photos by entering the index numbers of the photos you want to print. Press the pound key (#) to specify a range: 21-30. Press **OK** when you finish entering the photo index numbers.

- 3 Load photo paper face down in the back right corner of the input tray and adjust the paper guides.

**Tip** If the photo paper you are using has perforated tabs, load the photo paper so that the tabs are closest to you.

- 4 Press **Start Black** or **Start Color** to print the selected photos as borderless prints.

## Deselect photos

You can deselect photos from the control panel.

→ Do one of the following:

- Press **OK** to deselect the currently selected photo shown in the display.
- Press **Cancel** to deselect **all** photos and return to the idle screen.

## Print photos from a PictBridge-compatible digital camera

The HP all-in-one supports the PictBridge standard, which lets you connect any PictBridge-compatible camera to the camera port and print photos contained on the memory card in the camera.

- 1 Connect your PictBridge-compatible digital camera to the camera port on the front of your HP all-in-one using the USB cable supplied with your camera.
- 2 Turn on your camera and make sure it is in PictBridge mode.

**Note** When the camera is connected correctly, the status light next to the memory card slots is illuminated. The status light blinks green when printing from the camera. If the camera is not PictBridge-compliant or is not in PictBridge mode, the status light blinks amber and an error message displays on your computer monitor (if you have the HP all-in-one software installed). Disconnect the camera, correct the problem on the camera and reconnect. For more information about PictBridge camera port troubleshooting, see the onscreen **Troubleshooting Help** that came with your **HP Image Zone** software.

After you successfully connect your PictBridge-compliant camera to the HP all-in-one, you can print your photos. Make sure the size of the paper loaded in the HP all-in-one matches the setting on your camera. If the paper size setting on your camera is set to the default, the HP all-in-one uses the paper that is currently loaded in the input tray. Refer to the user guide that came with your camera for detailed information on printing from the camera.

**Tip** If your digital camera is an HP model that does not support PictBridge, you can still print directly to the HP all-in-one. Connect the camera to the USB port on the back of the HP all-in-one instead of to the camera port. This works with HP digital cameras only.

## Use quick print to print the current photo

You can use the **Quick Print** feature to print the photo currently being viewed on the color graphics display.

- 1 Insert the memory card into the appropriate slot on your HP all-in-one.
- 2 Navigate to a photo you want to print.
- 3 Press **Start Black** or **Start Color** to print the photo using the current settings.

## Print a DPOF file

The Digital Print Order Format (DPOF) is an industry-standard file that can be created by some digital cameras. Camera-selected photos are photos you marked for printing with your digital camera. When you select photos with your camera, the camera creates a

DPOF file that identifies which photos have been tagged for printing. Your HP all-in-one can read the DPOF file from the memory card so you do not have to reselect the photos to print.

**Note** Not all digital cameras allow you to tag your photos for printing. See your digital camera documentation to see if it supports DPOF. Your HP all-in-one supports DPOF file format 1.1.

When you print camera-selected photos, the HP all-in-one print settings do not apply; the settings in the DPOF file for photo layout and number of copies override those of your HP all-in-one.

The DPOF file is stored by the digital camera on a memory card and specifies the following information:

- Which photos to print
- The quantity of each photo to print
- Rotation applied to a photo
- Cropping applied to a photo
- Index printing (thumbnails of selected photos)

### To print camera-selected photos

- 1 Insert the memory card into the appropriate slot on your HP all-in-one. If there are DPOF-tagged photos, the **Print DPOF Photos** prompt appears on the color graphics display.
- 2 Do one of the following:
  - Press **1** to print all DPOF-tagged photos on the memory card.
  - Press **2** to bypass DPOF printing.

## Use the slide show feature

You can use the **Slide Show** option on the **Photo Menu** to view all the photos on a memory card as a slide show.

### View or print photos in a slide show

You can view or print photos displayed in a slide show using the **Slide Show** feature of the HP all-in-one.

#### To view a slide show

- 1 Insert the memory card into the appropriate slot on your HP all-in-one.
- 2 Press **Photo** to display the **Photo Menu**.
- 3 Press **4** to start the slide show.
- 4 Press **Cancel** to end the slide show.

#### To print the currently displayed photo in a slide show

- 1 When the photo you want to print appears on the color graphics display, press **Cancel** to cancel the slide show.
- 2 Press **Start Black** or **Start Color** to print the photo using the current settings.

## Share photos through HP Instant Share

The HP all-in-one and its software can help you share photos with friends and family members using a technology called HP Instant Share. You can use HP Instant Share to:

- Share photos with friends and relatives through e-mail.
- Create online albums.
- Order printed photos online.

**Note** Not all countries/regions can order printed photos online.

In order to take full advantage of the HP Instant Share features available from the control panel of your HP all-in-one, you must set up HP Instant Share on your HP all-in-one. For information on setting up HP Instant Share on your HP all-in-one, see [Use HP Instant Share \(USB\)](#) or [Use HP Instant Share \(networked\)](#).

**Note** If you set up HP Instant Share on a network, you will not be able to use HP Instant Share on a USB-connected device.

### Share photos from a memory card with friends and relatives (USB-connected)

Your HP all-in-one allows you to share photos immediately upon inserting a memory card. Simply insert the memory card into the appropriate card slot, select one or more photos, and press **Photo** on the control panel.

**Note** If you previously set up HP Instant Share on a network, you will not be able to use HP Instant Share on a USB-connected device.

- 1 Make sure the memory card is inserted into the appropriate card slot on your HP all-in-one.
- 2 Select one or more photos.
- 3 Press **Photo** on the control panel of your HP all-in-one.  
The **Photo Menu** appears on the color graphics display.
- 4 Press **5** to select **HP Instant Share**.

For Windows users, the **HP Image Zone** software opens on your computer. The **HP Instant Share** tab appears. Thumbnails of your photos appear in the Selection Tray. For more information, see the onscreen **HP Image Zone Help**.

For Macintosh users, the **HP Instant Share** client application software opens on your computer. Thumbnails of your photos appear in the **HP Instant Share** window.

**Note** If you are using a version of the Macintosh OS earlier than OS X v10.1.5 (including OS 9), your photos are uploaded to the **HP Gallery** on your Macintosh. Click **E-mail**. Send the photos as an e-mail attachment by following the prompts on your computer screen.

Follow the prompts on your computer for sharing the photos with others using HP Instant Share.

## Share photos from a memory card with friends and relatives (network-connected)

Your HP all-in-one allows you to share photos immediately upon inserting a memory card. Simply insert the memory card into the appropriate card slot, select one or more photos, and press **Photo** on the control panel.

Before you can share photos on your memory card on a network-connected HP all-in-one, you must first have HP Instant Share set up on the device. For more information on setting up HP Instant Share on your device, see [Get started](#).

- 1 Make sure the memory card is inserted into the appropriate card slot on your HP all-in-one.
- 2 Select one or more photos.
- 3 From the control panel, press **Photo**.  
The **Photo Menu** appears on the color graphics display.
- 4 Press **5** to select **HP Instant Share**.  
The **Share Menu** appears.
- 5 Use the **▲** and **▼** arrows to highlight a destination to which you want to send your photos.
- 6 Press **OK** to select the destination and send the photos.

## Use the HP Image Zone

You can use the **HP Image Zone** for viewing and editing image files. You can also print images, send images by e-mail or fax to friends and relatives, upload images to a website, or use images in fun and creative printing projects. The HP software lets you do all this and much more. Explore the software to take full advantage of the features of your HP all-in-one.

For more information, see the onscreen **HP Image Zone Help** that came with your software.

**For Windows:** If you want to open the **HP Image Zone** at a later time, open the **HP Director** and click the **HP Image Zone** icon.

**For Macintosh:** If you want to open the **HP Gallery** component of the **HP Image Zone** at a later time, open the **HP Director** and click **HP Gallery** (OS 9), or click **HP Director** in the Dock and select **HP Gallery** from the **Manage and Share** section of the **HP Director** menu (OS X).

# 7 Use the copy features

The HP all-in-one allows you to produce high-quality color and black-and-white copies on a variety of paper types, including transparencies. You can enlarge or reduce the size of an original to fit a specific paper size, adjust the darkness and color intensity of the copy, and use special features to make high-quality copies of photos, including 10 by 15 cm (4 by 6 inch) borderless copies.

This chapter provides instructions for increasing copy speed, enhancing copy quality, setting the number of copies to print, guidelines for choosing the best paper type and size for your job, making posters, and making iron-on transfers.

**Tip** For the best copy performance on standard copy projects, set the paper size to **Letter** or **A4**, the paper type to **Plain Paper**, and the copy quality to **Fast**.

For information on setting the paper size, see [Set the copy paper size](#).

For information on setting the paper type, see [Set the copy paper type](#).

For information on setting the copy quality, see [Increase copy speed or quality](#).

You can learn how to perform photo copy projects, such as making borderless copies of photos, enlarging and reducing the copies of photos to suit your preference, making multiple copies of photos on a page, and making quality enhancements to copies of faded photos.



Make a 10 by 15 cm (4 by 6 inch) borderless copy of a photo.



Copy a 10 by 15 cm (4 by 6 inch) photo onto a full-size page.

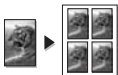

Copy a photo several times on one page.



Enhance light areas of your copy.

## Set the copy paper size

You can set the paper size on your HP all-in-one. The paper size you select should match what is loaded in your input tray. The default paper size setting for copying is **Automatic**, which causes the HP all-in-one to detect the size of paper in the input tray.

Paper type	Suggested paper size settings
Copier, multi-purpose, or plain papers	Letter or A4
Inkjet papers	Letter or A4
Iron-on transfers	Letter or A4
Letterhead	Letter or A4

(continued)

Paper type	Suggested paper size settings
Photo papers	10x15 cm or 10x15 cm Borderless 4x6 inches or 4x6 Borderless 5x7 inches or 5x7 Borderless Letter or Letter Borderless A4 or A4 Borderless L-size or L-size Borderless
Hagaki cards	Hagaki or Hagaki Borderless
Transparency films	Letter or A4

- 1 Press **Copy**, and then press **4**.  
This displays the **Copy Menu** and then selects **Paper Size**.
- 2 Press **▼** until the appropriate paper size appears.
- 3 Press **OK** to choose the displayed paper size.

## Set the copy paper type

You can set the paper type on your HP all-in-one. The default paper type setting for copying is **Automatic**, which causes the HP all-in-one to detect the type of paper in the input tray.

If you copy onto special papers, or if you experience poor print quality by using the **Automatic** setting, you can set the paper type manually from the **Copy Menu**.

- 1 Press **Copy**, and then press **5**.  
This displays the **Copy Menu** and then selects **Paper Type**.
- 2 Press **▼** to highlight a paper type setting, and then press **OK**.

Refer to the following table to determine which paper type setting to choose based on the paper loaded in the input tray.

Paper type	Control panel setting
Copier paper or letterhead	Plain Paper
HP Bright White Paper	Plain Paper
HP Premium Plus Photo Paper, Glossy	Premium Photo
HP Premium Plus Photo Paper, Matte	Premium Photo
HP Premium Plus 4 by 6 inch Photo Paper	Premium Photo
HP Photo Paper	Photo Paper
HP Everyday Photo Paper	Everyday Photo
HP Everyday Photo Paper, Semi Gloss	Everyday Matte
Other photo paper	Other Photo

(continued)

Paper type	Control panel setting
HP Iron-On Transfer (for color fabrics)	Iron-On
HP Iron-On Transfer (for light or white fabrics)	Iron-On Mirrored
HP Premium Paper	Premium Inkjet
Other inkjet paper	Premium Inkjet
HP Professional Brochure & Flyer Paper (Glossy)	Brochure Glossy
HP Professional Brochure & Flyer Paper (Matte)	Brochure Matte
HP Premium or Premium Plus Inkjet Transparency Film	Transparency
Other transparency film	Transparency
Plain Hagaki	Plain Paper
Glossy Hagaki	Premium photo
L (Japan only)	Premium Photo

## Increase copy speed or quality

The HP all-in-one provides three options that affect copy speed and quality.

- **Normal** delivers high-quality output and is the recommended setting for most of your copying. **Normal** copies faster than **Best**.
  - **Best** produces the highest quality for all paper and eliminates the banding (striping) effect that sometimes occurs in solid areas. **Best** copies more slowly than the other quality settings.
  - **Fast** copies faster than the **Normal** setting. The text is comparable to the quality of the **Normal** setting, but the graphics might be lower quality. The **Fast** setting uses less ink and extends the life of your print cartridges.
- 1 Make sure you have paper loaded in the input tray.
  - 2 Load your original face down on the right front corner of the glass.
  - 3 Press **Copy**, and then press **6**.  
This displays the **Copy Menu** and then selects **Copy Quality**.
  - 4 Press ▼ to highlight a quality setting, and then press **OK**.
  - 5 Press **Start Copy Black** or **Start Copy Color**.

## Select an input tray

If your HP all-in-one has more than one input tray, you can use the control panel to specify which input tray to use.

- 1 Press **Copy**, and then press **3**.  
This displays the **Copy Menu** and then selects **Tray Select**.
- 2 Press ▼ to highlight an input tray.
- 3 Press **OK** to choose the highlighted paper tray.



## Change default copy settings

When you change copy settings from the control panel, the settings apply only to the current copy job. To apply copy settings to all future copy jobs, you can save the settings as defaults.

When you change copy settings from the control panel or the **HP Director**, the settings apply only to the current copy job. To apply copy settings to all future copy jobs, you can save the settings as defaults.

- 1 Make any needed changes to the settings in the **Copy Menu**.
- 2 Press **0** to select **Set New Defaults** from the **Copy Menu**.
- 3 Press **OK** to accept the settings as the new default settings.

The settings you specify here are only saved on the HP all-in-one itself. They do not adjust the settings in the software. If you use the **HP Director** to control the settings on copies you make, you should set your most frequently used settings as the defaults in the **HP Copy** dialog box. To learn how, see the onscreen **HP Image Zone Help**.

## Make multiple copies of the same original

You set the number of copies that you want to print by using the **Number of Copies** option in the **Copy Menu**.

- 1 Make sure you have paper loaded in the input tray.
- 2 Load your original face down on the right front corner of the glass.
- 3 Press **Copy**, and then press **1**.  
This displays the **Copy Menu** and then selects **Number of Copies**.
- 4 Press **▶** or use the keypad to enter the number of copies, up to the maximum, and then press **OK**.  
(The maximum number of copies varies by model.)

**Tip** If you hold down either of the arrow buttons, the number of copies changes by increments of 5 to make it easier to set a large number of copies.

- 5 Press **Start Copy Black** or **Start Copy Color**.

In this example, the HP all-in-one makes three copies of the original 10 by 15 cm (4 by 6 inch) photo.

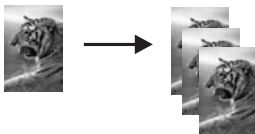

## Copy a two-page black-and-white document

You can use the HP all-in-one to copy a single- or multiple-page document in color or black and white. In this example, the HP all-in-one is used to copy a two-page black-and-white original.

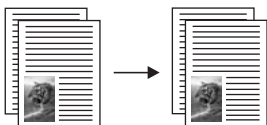

- 1 Make sure you have paper loaded in the input tray.
- 2 Load the first page of your original face down on the right front corner of the glass.
- 3 Press **Copy**, if not already lit.
- 4 Press **Start Copy Black**.
- 5 Remove the first page from the glass and load the second page.
- 6 Press **Start Copy Black**.

## Make a 10by 15cm (4by 6inch) borderless copy of a photo

For the best quality when copying a photo, load photo paper in the input tray and change your copy settings for the correct paper type and photo enhancement. You might also want to use the photo print cartridge for superior print quality. With the tri-color and photo print cartridges installed, you have a six-ink system. For more information, see [Use a photo print cartridge](#).

- 1 Load 10 by 15 cm (4 by 6 inch) photo paper in the input tray.
- 2 Load your original photo face down on the right front corner of the glass. Position the photo on the glass so the long edge of the photo is along the front edge of the glass.
- 3 Press **Start Copy Color**.

The HP all-in-one makes a 10 by 15 cm (4 by 6 inch) borderless copy of your original photo, as shown below.

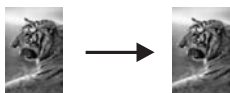

**Tip** If the output is not borderless, then set the paper size to **10x15 cm Borderless** or **4x6 Borderless**, set the paper type to **Photo Paper**, set the **Photo** enhancement, and then try again.

For more information on setting the paper size, see [Set the copy paper size](#).

For information on setting the paper type, see [Set the copy paper type](#).

For information on setting the **Photo** enhancement, see [Enhance light areas of your copy](#).

## Copy a 10by 15cm (4by 6inch) photo onto a full-size page

You can use the **Fill Entire Page** setting to automatically enlarge or reduce your original to fill the printable area of the paper size loaded in the input tray. In this example, **Fill Entire Page** is used to enlarge a 10 by 15 cm (4 by 6 inch) photo to create a full-size borderless copy. When copying a photo, you might want to use the photo print cartridge for superior print quality. With the tri-color and photo print

cartridges installed, you have a six-ink system. For more information, see [Use a photo print cartridge](#).

**Note** In order to achieve a borderless print without changing the proportions of the original, the HP all-in-one might crop some of the image around the margins. In most cases, this cropping will not be noticeable.

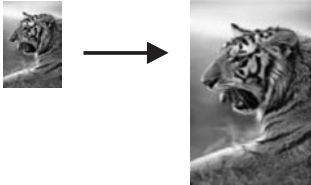

- 1 Load letter or A4 photo paper in the input tray.
- 2 Load your original photo face down on the right front corner of the glass. Position the photo on the glass so the long edge of the photo is along the front edge of the glass.
- 3 Press **Copy** to display the **Copy Menu**.
- 4 Press **2**, and then press **3**. This displays the **Reduce/Enlarge** menu and then selects **Fill Entire Page**.
- 5 Press **Start Copy Color**.

**Tip** If the output is not borderless, then set the paper size to **Letter Borderless** or **A4 Borderless**, set the paper type to **Photo Paper**, set the **Photo** enhancement, and then try again.

For information on setting the paper size, see [Set the copy paper size](#).

For information on setting the paper type, see [Set the copy paper type](#).

For information on setting the **Photo** enhancement, see [Enhance light areas of your copy](#).

## Copy a photo several times on one page

You can print multiple copies of an original on one page by selecting an image size from the **Reduce/Enlarge** option in the **Copy Menu**.

After you select one of the available sizes, you might be prompted whether you want to print multiple copies of the photo to fill the paper you have loaded in the input tray.

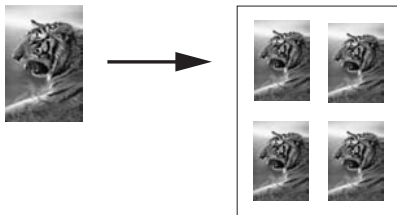

- 1 Make sure you have paper loaded in the input tray.
- 2 Load your original photo face down on the right front corner of the glass.

Position the photo on the glass so the long edge of the photo is along the front edge of the glass.

3 Press **Copy** to display the **Copy Menu**.

4 Press **2**, and then press **5**.

This displays the **Reduce/Enlarge** menu and then selects **Image Sizes**.

5 Press **▼** to highlight the size in which you want to copy the photo, and then press **OK**.

Depending on the image size you select, the **Many on Page?** prompt might appear to determine whether you want to print multiple copies of the photo to fill the paper in the input tray, or just one copy.

Some larger sizes do not prompt you for a number of images. In this case, only one image is copied to the page.

6 If the **Many on Page?** prompt appears, select **Yes** or **No**, and then press **OK**.

7 Press **Start Copy Black** or **Start Copy Color**.

## Resize an original to fit onto letter or A4 paper

If the image or text on your original fills the entire sheet with no margins, use the **Fit to Page** feature to reduce your original and prevent unwanted cropping of the text or images at the edges of the sheet.

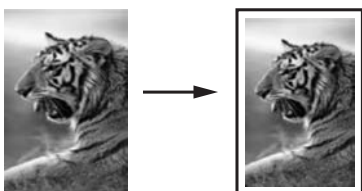

**Tip** You can also use **Fit to Page** to enlarge a small photo to fit within the printable area of a full-size page. In order to do this without changing the proportions of the original or cropping the edges, the HP all-in-one might leave an uneven amount of white space around the edges of the paper.

1 Make sure you have paper loaded in the input tray.

2 Load your original face down on the right front corner of the glass.

3 Press **Copy**, and then press **4**.

This displays the **Copy Menu** and then selects **Paper Size**.

4 Press **▼** to highlight **Letter**, and then press **OK**.

5 Press **1** to select **Reduce/Enlarge** from the **Copy Menu**.

6 Press **▼** to highlight **Fit to Page**, and then press **OK**.

7 Press **Start Copy Black** or **Start Copy Color**.

## Copy a faded original

You can use the **Lighter/Darker** option to adjust the lightness and darkness of the copies you make. You can also adjust the color intensity to make colors on your copy more vivid or more subtle.

1 Make sure you have paper loaded in the input tray.

2 Load your original face down on the right front corner of the glass.

- 3 Press **Copy**, and then press **7**.  
This displays the **Copy Menu** and then selects **Lighter/Darker**. The range of **Lighter/Darker** values appears as a scale on the color graphics display.
- 4 Press **▶** to darken the copy, and then press **OK**.  
**Note** You can also press **◀** to lighten the copy.
- 5 Press **9** to select **Color Intensity** from the **Copy Menu**.  
The range of color intensity values appears as a scale on the color graphics display.
- 6 Press **▶** to make the image more vivid, and then press **OK**.  
**Note** You can also press **◀** to make the image more pale.
- 7 Press **Start Copy Black** or **Start Copy Color**.

## Copy a document that has been faxed several times

You can use the **Enhancements** feature to automatically adjust the quality of text documents by sharpening edges of black text or adjust photographs by enhancing light colors that might otherwise appear white.

The **Mixed** enhancement is the default option. Use the **Mixed** enhancement to sharpen edges of most originals.

### To copy a blurred document from the control panel

- 1 Make sure you have paper loaded in the input tray.
- 2 Load your original face down on the right front corner of the glass.
- 3 Press **Copy**, and then press **8**.  
This displays the **Copy Menu** and then selects **Enhancements**.
- 4 Press **▼** to highlight the **Text** enhancement setting, and then press **OK**.
- 5 Press **Start Copy Black** or **Start Copy Color**.

**Tip** If any of the following occur, turn off **Text** enhancement by selecting **Photo** or **None**:

- Stray dots of color surround some text on your copies
- Large, black typefaces look splotchy (not smooth)
- Thin, colored objects or lines contain black sections
- Horizontal grainy or white bands appear in light- to medium-gray areas

## Enhance light areas of your copy

You can use **Photo** enhancements to enhance light colors that might otherwise appear white. You can also use **Photo** enhancements to eliminate or reduce any of the following that might occur when copying with **Text** enhancements:

- Stray dots of color surround some text on your copies
- Large, black typefaces look splotchy (not smooth)
- Thin, colored objects or lines contain black sections
- Horizontal grainy or white bands appear in light- to medium-gray areas

### To copy an overexposed photo from the control panel

- 1 Make sure you have paper loaded in the input tray.

- 2 Load your original photo face down on the right front corner of the glass.  
Position the photo on the glass so the long edge of the photo is along the front edge of the glass.
- 3 Press **Copy**, and then press **8**.  
This displays the **Copy Menu** and then selects **Enhancements**.
- 4 Press **▼** to highlight the **Photo** enhancement setting, and then press **OK**.
- 5 Press **Start Copy Color**.

It is easy to set **Enhancement** settings for photos and other documents you copy by using the **HP Image Zone** software that came with your HP all-in-one. With one click of your mouse button, you can set a photo to copy with **Photo** enhancements, a text document to copy with **Text** enhancements, or a document that contains both images and text to copy with both **Photo** and **Text** enhancements turned on. For more information, see the onscreen **HP Image Zone Help**.

## Make a poster

You can use the **Poster** feature to create an enlarged copy of your original in sections and assemble them into a poster.

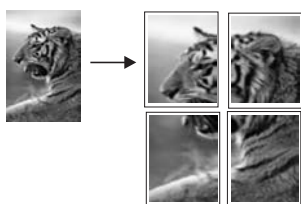

- 1 Make sure you have paper loaded in the input tray.
- 2 Load your original face down on the right front corner of the glass.  
If you are copying a photo, position the photo on the glass so the long edge of the photo is along the front edge of the glass.
- 3 Press **Copy** to display the **Copy Menu**.
- 4 Press **2**, and then press **6**.  
This displays the **Reduce/Enlarge** menu and then selects **Poster**.
- 5 Press **▼** to highlight a page width for the poster, and then press **OK**.  
The default poster size is two pages wide.
- 6 Press **Start Copy Black** or **Start Copy Color**.

After you select the poster width, the HP all-in-one adjusts the length automatically to maintain the proportions of the original.

**Tip** If the original cannot be enlarged to the selected poster size because it exceeds the maximum zoom percentage, an error message appears that tells you to try a smaller width. Select a smaller poster size and make the copy again.

You can be even more creative with your photos by using the **HP Image Zone** software that came with your HP all-in-one. For more information, see the onscreen **HP Image Zone Help**.

## Prepare a color iron-on transfer

You can copy an image or text onto an iron-on transfer, then iron it onto a T-shirt, pillow cover, place mat, or other piece of fabric.

**Tip** Practice applying a iron-on transfer on an old garment first.

- 1 Load the iron-on transfer paper in the input tray.
- 2 Load your original face down on the right front corner of the glass.  
If you are copying a photo, position the photo on the glass so the long edge of the photo is along the front edge of the glass.
- 3 Press **Copy**, and then press **5**.  
This displays the **Copy Menu** and then selects **Paper Type**.
- 4 Press **▼** to highlight **Iron-On** or **Iron-On Mirrored**, and then press **OK**.

**Note** Select **Iron-On** as the paper type for dark-colored fabrics, and **Iron-On Mirrored** for white and light-colored fabrics.

- 5 Press **Start Copy Black** or **Start Copy Color**.

**Note** When you select **Iron-On Mirrored** as the paper type, the HP all-in-one automatically copies a mirror image of your original so that it will appear properly when you iron it onto fabric.

## Stop copying

- To stop copying, press **Cancel** on the control panel.

# 8 Use the scan features

This chapter contains information on scanning to an application, to an HP Instant Share destination, and to a memory card.

Scanning is the process of converting text and pictures into an electronic format for your computer. You can scan just about anything: photos, magazine articles, text documents, and even 3D objects, as long as you are careful not to scratch the glass on your HP all-in-one. Scanning to a memory card makes your scanned images even more portable.

You can use the scanning features of your HP all-in-one to do the following:

- Scan text from an article into your word processor and quote it in a report.
- Print business cards and brochures by scanning a logo and using it in your publishing software.
- Send photos to friends and relatives by scanning your favorite prints and including them in e-mail messages.
- Create a photographic inventory of your house or office.
- Archive treasured photos in an electronic scrapbook.

**Note** Scanning text (also known as optical character recognition or OCR) lets you bring the content of magazine articles, books, and other printed matter into your favorite word processor and many other programs as fully editable text. Learning to do OCR right is important if you want to obtain the best results. Do not expect scanned text documents to be letter-perfect the first time you use your OCR software. Using OCR software is an art that takes time and practice to master. For more information about scanning documents, especially documents containing both text and graphics, see the documentation that came with your OCR software.

To use the scan features, your HP all-in-one and computer must be connected and turned on. The HP all-in-one software must also be installed and running on your computer prior to scanning. To verify that the HP all-in-one software is running on a Windows PC, look for the HP all-in-one icon in the system tray at the lower right side of the screen, near the time. On a Macintosh, the HP all-in-one software is always running.

**Note** Closing the HP Windows system tray icon can cause your HP all-in-one to lose some of its scan functionality and result in the **No Connection** error message. If this happens, you can restore full functionality by restarting your computer or by starting the **HP Image Zone** software.

For information about how to scan from the computer, and how to adjust, resize, rotate, crop, and sharpen your scans, see the onscreen **HP Image Zone Help** that came with your software.

## Scan to an application

You can scan originals placed on the glass directly from the control panel.



**Note** The menus shown in this section may vary in content depending on your computer's operating system and which applications you set up as scan destinations in the **HP Image Zone**.

### Scan an original (USB-connected)

Follow these steps if your HP all-in-one is directly connected to a computer through a USB cable.

- 1 Load your original face down in the right front corner of the glass.
- 2 Press **Scan**, if it is not already lit.  
The **Scan Menu** appears, listing destinations, including applications, for anything you scan. The default destination is whichever one you selected the last time you used this menu. You designate which applications and other destinations appear on the **Scan Menu** by using the **HP Image Zone** on your computer.
- 3 To select an application to receive the scan, press its number on the control panel or use the arrow keys to highlight it and then press **OK** or **Start Color**. To force the scan to be in black and white, press **Start Black** instead of **OK**.  
A preview image of the scan appears in the **HP Scan** window on the computer, where you can edit it.  
For more information about editing a preview image, see the onscreen **HP Image Zone Help** that came with your software.
- 4 Make any edits to the preview image in the **HP Scan** window. When you have finished, click **Accept**.  
The HP all-in-one sends the scan to the selected application. For example, if you chose the **HP Image Zone**, it automatically opens and displays the image.

### Scan an original (network-connected)

Follow these steps if your HP all-in-one is connected to one or more computers over a network.

- 1 Load your original face down in the right front corner of the glass.
- 2 Press **Scan**, if it is not already lit.  
The **Scan Menu** appears, listing various options.
- 3 Press **1** to choose **Select Computer** or use the arrow keys to highlight it and then press **OK**.  
The **Select Computer** menu appears, listing computers connected to the HP all-in-one.

**Note** The **Select Computer** menu may list computers with a USB connection in addition to those connected through the network.

- 4 To select the default computer, press **OK**. To select another computer, press its number on the control panel or use the arrow keys to highlight your selection and then press **OK**. To send the scan to an application on your computer, choose your computer in the menu.  
The **Scan Menu** appears, listing destinations, including applications, for anything you scan. The default destination is whichever one you selected the last time you used this menu. You designate which destinations appear on the **Scan Menu** by using the **HP Image Zone** on your computer. For more information, see the onscreen **HP Image Zone Help** that came with your software.

- 5 To select an application to receive the scan, press its number on the control panel or use the arrow keys to highlight it and then press **OK** or **Start Color**. To force the scan to be in black and white, press **Start Black** instead of **OK**.

If you chose the **HP Image Zone**, a preview image of the scan appears in the **HP Scan** window on the computer, where you can edit it.

- 6 Make any desired edits to the preview image in the **HP Scan** window. When you finish, click **Accept**.

The HP all-in-one sends the scan to the selected application. For example, if you chose the **HP Image Zone**, it automatically opens and displays the image.

## Send a scan to an HP Instant Share destination

HP Instant Share lets you share your photos with family and friends through e-mail messages, online photo albums, and high-quality prints. In order to take full advantage of the HP Instant Share features available from the control panel of your HP all-in-one, you must set up HP Instant Share on your HP all-in-one.

For information on setting up HP Instant Share on your HP all-in-one, see [Use HP Instant Share \(networked\)](#).

For information on using HP Instant Share, see the onscreen **HP Image Zone Help**.

**Note** If you set up HP Instant Share on a network, you will not be able to use HP Instant Share on a USB-connected device.

### Share a scanned image with friends and relatives (USB-connected device)

Share a scanned image by pressing **Scan** on the control panel. To use the **Scan** button, place an image face down on the glass, select a destination to which you want to send the image, and start the scan.

**Note** If you previously set up HP Instant Share on a network, you will not be able to use HP Instant Share on a USB-connected device.

- 1 Load your original face down on the right front corner of the glass.
- 2 Press **Scan**.  
The **Scan To** menu appears on the color graphics display.
- 3 Use the **▲** and **▼** arrows to highlight **HP Instant Share**.
- 4 Press **OK** to select the destination and scan the image.

The image is scanned and uploaded to your computer.

For Windows users, the **HP Image Zone** software opens on your computer. The **HP Instant Share** tab appears. A thumbnail of the scanned image appears in the Selection Tray. For more information, see the onscreen **HP Image Zone Help**.

For Macintosh users, the **HP Instant Share** client application software opens on your computer. A thumbnail of the scanned image appears in the **HP Instant Share** window.

**Note** If you are using a version of the Macintosh OS earlier than OS X v10.1.5 (including OS 9), the scanned image is uploaded to the **HP Gallery** on your Macintosh. Click **E-mail**. Send the image as an e-mail attachment by following the prompts on your computer screen.

Follow the prompts on your computer for sharing the scan with others using HP Instant Share.

## Share a scanned image with friends and relatives (network-connected)

Share a scanned image by pressing **Scan** on the control panel. To use the **Scan** button, place an image face down on the glass, select a destination to which you want to send the image, and start the scan.

Before you can share a scanned image on a network-connected HP all-in-one, you must first have **HP Image Zone** installed on your computer. For more information on installing **HP Image Zone** on your computer, see the Setup Guide that came with your HP all-in-one.

- 1 Load your original face down on the right front corner of the glass.
- 2 Press **Scan**.  
The **Scan Menu** appears on the color graphics display.
- 3 Press **2** to select **HP Instant Share**.  
The **Share Menu** appears.
- 4 Use the **▲** and **▼** arrows to highlight a destination to which you want to send your image.
- 5 Press **OK** to select the destination and scan the image.  
The image is scanned and sent to the destination selected.

## Send a scan to a memory card

You can send the scanned image as a JPEG image to the memory card that is currently inserted in one of the memory card slots on the HP all-in-one. This enables you to use the memory card features to generate borderless prints and album pages from the scanned image. It also enables you to access the scanned image from other devices that support the memory card.

### Send a scan to a memory card loaded in your HP all-in-one (USB-connected)

You can send the scanned image as a JPEG image to a memory card. This section describes the process when your HP all-in-one is directly connected to your computer through a USB cable. Make sure you have a memory card inserted in the HP all-in-one.

- 1 Load your original face down in the right front corner of the glass.
- 2 Press **Scan**, if it is not already lit.  
A **Scan Menu** appears, listing various options or destinations. The default destination is whichever one you selected the last time you used this menu.
- 3 Press **▼** until **Memory Card** is highlighted, and then press **OK**.  
The HP all-in-one scans the image and saves the file to the memory card in the JPEG format.

### Send a scan to a memory card loaded in your HP all-in-one (network-connected)

You can send the scanned image as a JPEG image to a memory card. This section describes the process when your HP all-in-one is connected to a network.

**Note** You can only send a scan to a memory card if the memory card is being shared across the network. See [Control memory card security on a network](#) for more information.

- 1 Load your original face down in the right front corner of the glass.
- 2 Press **Scan**, if it is not already lit.

- A **Scan Menu** appears, listing various options or destinations.
- 3 Press **3** to select **Memory Card** or use the arrow keys to highlight it and then press **OK**.

The HP all-in-one scans the image and saves the file to the memory card in the JPEG format.

## Stop scanning

- To stop scanning, press **Cancel** on the control panel.



# 9 Print from your computer

The HP all-in-one can be used with any software application that allows printing. The instructions vary slightly depending on whether you are printing from a Windows PC or a Macintosh. Make sure you follow the instructions for your operating system in this chapter.

In addition to the printing capabilities described in this chapter, you can print special print jobs such as borderless prints, newsletters, and banners; print images directly from a photo memory card or from a digital camera that supports PictBridge; print from a supported Bluetooth device, such as a camera phone or personal digital assistant (PDA); and use scanned images in printing projects in the **HP Image Zone**.

- For more information on printing from a memory card or digital camera, see [Use a memory card or PictBridge camera](#).
- For more information on setting up your HP all-in-one to print from a Bluetooth device, see [Connection information](#).
- For more information on performing special print jobs or printing images in the **HP Image Zone**, see the onscreen **HP Image Zone Help**.

## Print from a software application

Most print settings are automatically handled by the software application you are printing from or by HP ColorSmart technology. You need to change the settings manually only when you change print quality, print on specific types of paper or transparency film, or use special features.

### To print from the software application you used to create your document (Windows users)

- 1 Make sure you have paper loaded in the input tray.
- 2 On the **File** menu in your software application, click **Print**.
- 3 Select the HP all-in-one as the printer.
- 4 If you need to change settings, click the button that opens the **Properties** dialog box.  
Depending on your software application, this button might be called **Properties**, **Options**, **Printer Setup**, or **Printer**.
- 5 Select the appropriate options for your print job by using the features available in the **Paper/Quality**, **Finishing**, **Effects**, **Basics**, and **Color** tabs.

**Tip** You can easily print your job with a set of default settings based on the type of job you want to print. On the **Printing Shortcuts** tab, click a type of print task in the **What do you want to do?** list. The default settings for that type of print task are set, and summarized on the **Printing Shortcuts** tab. If necessary, you can adjust the settings here, or you can make your changes on the other tabs in the **Properties** dialog box.

- 6 Click **OK** to close the **Properties** dialog box.
- 7 Click **Print** or **OK** to begin printing.

### To print from the software application you used to create your document (Macintosh users)

- 1 Make sure you have paper loaded in the input tray.
- 2 Select the HP all-in-one in the **Chooser** (OS 9), **Print Center** (OS 10.2 or earlier), or **Printer Setup Utility** (OS 10.3 or later) before you begin printing.
- 3 From the **File** menu in your software application, choose **Page Setup**. The **Page Setup** dialog box appears, allowing you to specify the paper size, orientation, and scaling.
- 4 Specify the page attributes:
  - Choose the paper size.
  - Select the orientation.
  - Enter the scaling percentage.

**Note** For OS 9, the **Page Setup** dialog box also includes options to print a mirrored (or reversed) version of the image, and to adjust the page margins for two-sided printing.

- 5 Click **OK**.
- 6 From the **File** menu in your software application, choose **Print**. The **Print** dialog box appears. If you are using OS 9, the **General** panel opens. If you are using OS X, the **Copies & Pages** panel opens.
- 7 Change the print settings for each option in the pop-up menu, as appropriate for your project.
- 8 Click **Print** to begin printing.

## Change the print settings

You can customize the print settings of the HP all-in-one to handle nearly any print task.

### Windows users

Before you change print settings, you should decide if you want to change the settings for the current print job only, or if you want to make the settings the defaults for all future print jobs. How you display print settings depends on whether or not you want to apply the change to all future print jobs or just to the current print job.

#### To change the print settings for all future jobs

- 1 In the **HP Director**, click **Settings**, point to **Print Settings**, and then click **Printer Settings**.
- 2 Make changes to the print settings, and click **OK**.

#### To change the print settings for the current job

- 1 On the **File** menu in your software application, click **Print**.
- 2 Make sure the HP all-in-one is the selected printer.
- 3 Click the button that opens the **Properties** dialog box. Depending on your software application, this button might be called **Properties**, **Options**, **Printer Setup**, or **Printer**.
- 4 Make changes to the print settings, and click **OK**.
- 5 Click **Print** or **OK** in the **Print** dialog box to print the job.

## Macintosh users

Use the **Page Setup** and **Print** dialog boxes to change the settings for your print job. Which dialog box you use depends on which setting you want to change.

### To change the paper size, orientation, or scaling percentage

- 1 Select the HP all-in-one in the **Chooser** (OS 9), **Print Center** (OS 10.2 or earlier), or **Printer Setup Utility** (OS 10.3 or later) before you begin printing.
- 2 From the **File** menu in your software application, choose **Page Setup**.
- 3 Make changes to the paper size, orientation, and scaling percentage settings, and click **OK**.

### To change all other print settings

- 1 Select the HP all-in-one in the **Chooser** (OS 9), **Print Center** (OS 10.2 or earlier), or **Printer Setup Utility** (OS 10.3 or later) before you begin printing.
- 2 From the **File** menu in your software application, choose **Print**.
- 3 Make changes to the print settings, and click **Print** to print the job.

## Stop a print job

Although you can stop a print job from either the HP all-in-one or the computer, we recommend you stop it from the HP all-in-one for best results.

### To stop a print job from the HP all-in-one

- Press **Cancel** on the control panel. Look for the **Print Cancelled** message on the color graphics display. If the message does not appear, press **Cancel** again.





# 10 Fax setup

After completing all steps in the Setup Guide, use the instructions in this chapter to complete your fax setup. Please keep your Setup Guide for later use.

In this chapter, you will learn how to set up your HP all-in-one so that faxing works successfully with equipment and services you might already have on the same phone line as your HP all-in-one.

Before you begin setting up your HP all-in-one for faxing, determine which kind of phone system your country/region uses. The instructions for setting up your HP all-in-one for faxing differ depending whether you have a serial or parallel phone system.

- If the connector type on your shared telephone equipment (modems, phones, and answering machines) does not allow a physical connection to the "2-EXT" port on your HP all-in-one and instead must be connected at the telephone wall jack, you probably have a serial-type telephone system. Check the table below to make sure that your country/region does not appear in this list. If you are unsure which kind of telephone system you have (serial or parallel), check with your telephone company. This type of phone system uses a 4-wire phone cord to connect the HP all-in-one to the telephone wall jack.
- If your country/region is listed in the table, you probably have a parallel-type telephone system. This type of phone system uses a 2-wire phone cord to connect the HP all-in-one to the telephone wall jack.

Argentina	Australia	Brazil
Canada	Chile	China
Colombia	Greece	India
Indonesia	Ireland	Japan
Korea	Latin America	Malaysia
Mexico	Philippines	Poland
Portugal	Russia	Saudi Arabia
Singapore	Spain	Taiwan
Thailand	USA	Venezuela
Vietnam		

**Tip** You can also check the end of the phone cord that came in the box with your HP all-in-one. If the phone cord appears to have two wires, you have a 2-wire phone cord. If the phone cord has four wires, you have a 4-wire phone cord. The graphic below shows the differences between the phone cords.

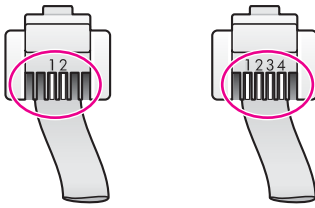

## Choose the right fax setup for your home or office

To fax successfully, you need to know what types of equipment and services (if any) share the same phone line with your HP all-in-one. This is important because you might need to connect some of your existing office equipment directly to your HP all-in-one, and you might also need to change some fax settings before you can fax successfully.

To determine the best way to set up the HP all-in-one in your home or office, first read through the questions in this section and record your answers. Next, refer to the table in the following section and choose the recommended setup case based on your answers.

Make sure to read and answer the following questions in the order they are presented.

- 1 Do you have a digital subscriber line (DSL) service through your telephone company?

- Yes, I have DSL.
- No.

If you answered Yes, proceed directly to [Case B: Set up your HP all-in-one with DSL](#). You do not need to continue answering questions.

If you answered No, please continue answering questions.

- 2 Do you have a private branch exchange (PBX) phone system or an integrated services digital network (ISDN) system?

If you answered Yes, proceed directly to [Case C: Set up your HP all-in-one with a PBX phone system or an ISDN line](#). You do not need to continue answering questions.

If you answered No, please continue answering questions.

- 3 Do you subscribe to a distinctive ring service through your telephone company that provides multiple phone numbers with different ring patterns?

- Yes, I have distinctive ring.
- No.

If you answered Yes, proceed directly to [Case D: Fax with a distinctive ring service on the same line](#). You do not need to continue answering questions.

If you answered No, please continue answering questions.

Are you unsure if you have distinctive ring? Many phone companies offer a distinctive ring feature that allows you to have several phone numbers on one phone line.

When you subscribe to this service, each phone number will have a different ring pattern. For example, you can have single, double, and triple rings for the different numbers. You might assign one phone number with a single ring to your voice calls, and another phone number with double rings to your fax calls. This allows you to tell the difference between voice and fax calls when the phone rings.

- 4 Do you receive voice calls at the same phone number you will use for fax calls on your HP all-in-one?
- Yes, I receive voice calls.
  - No.

Please continue answering questions.

- 5 Do you have a PC modem on the same phone line as your HP all-in-one?
- Yes, I have a PC modem.
  - No.

If you answer Yes to any of the following questions, you are using a PC modem:

- Do you send and receive faxes directly to and from your computer software programs through a dial-up connection?
- Do you send and receive e-mail messages on your computer through a dial-up connection?
- Do you access the Internet from your computer through a dial-up connection?

Please continue answering questions.

- 6 Do you have an answering machine that answers voice calls at the same phone number you will use for fax calls on your HP all-in-one?
- Yes, I have an answering machine.
  - No.

Please continue answering questions.

- 7 Do you subscribe to a voice mail service through your telephone company at the same phone number you will use for fax calls on your HP all-in-one?
- Yes, I have a voice mail service.
  - No.

After you have completed answering the questions, proceed to the next section to select your fax setup case.

## Select your fax setup case

Now that you have answered all of the questions about the equipment and services that share the phone line with your HP all-in-one, you are ready to choose the best setup case for your home or office.

From the first column in the following table, choose the combination of equipment and services applicable to your home or office setting. Then look up the appropriate setup case in the second or third column based on your phone system. Step-by-step instructions are included for each case later in this chapter.

If you have answered all of the questions in the previous section and have none of the described equipment or services, choose "None" from the first column in the table.

**Note** If your home or office setup is not described in this chapter, set up the HP all-in-one as you would a regular analog phone. Make sure you use the phone cord supplied in the box to connect one end to your telephone wall jack and the other end to the port labeled "1-LINE" on the back of your HP all-in-one. If you use another phone cord, you might experience problems sending and receiving faxes.

Other equipment/services sharing your fax line	Recommended fax setup for parallel-type phone systems	Recommended fax setup for serial-type phone systems
None (You answered No to all questions.)	Case A: Separate fax line (no voice calls received)	Case A: Separate fax line (no voice calls received)
DSL service (You answered Yes to question 1 only.)	Case B: Set up your HP all-in-one with DSL	Case B: Set up your HP all-in-one with DSL
PBX or ISDN system You answered Yes to question 2 only.)	Case C: Set up your HP all-in-one with a PBX phone system or an ISDN line	Case C: Set up your HP all-in-one with a PBX phone system or an ISDN line
Distinctive ring service (You answered Yes to question 3 only.)	Case D: Fax with a distinctive ring service on the same line	Case D: Fax with a distinctive ring service on the same line
Voice calls (You answered Yes to question 4 only.)	Case E: Shared voice/fax line	Case E: Shared voice/fax line
Voice calls and voice mail service (You answered Yes to questions 4 and 7 only.)	Case F: Shared voice/fax line with voice mail	Case F: Shared voice/fax line with voice mail
PC modem (You answered Yes to question 5 only.)	Case G: Fax line shared with PC modem (no voice calls received)	Not applicable.
Voice calls and PC modem (You answered Yes to questions 4 and 5 only.)	Case H: Shared voice/fax line with PC modem	Not applicable.
Voice calls and answering machine (You answered Yes to questions 4 and 6 only.)	Case I: Shared voice/fax line with answering machine	Not applicable.
Voice calls, PC modem, and answering machine (You answered Yes to questions 4, 5, and 6 only.)	Case J: Shared voice/fax line with PC modem and answering machine	Not applicable.
Voice calls, PC modem, and voice mail service	Case K: Shared voice/fax line with PC modem and voice mail	Not applicable.

(continued)

Other equipment/services sharing your fax line	Recommended fax setup for parallel-type phone systems	Recommended fax setup for serial-type phone systems
(You answered Yes to questions 4, 5, and 7 only.)		

## Case A: Separate fax line (no voice calls received)

If you have a separate phone line on which you receive no voice calls, and you have no other equipment connected on this phone line, set up your HP all-in-one as described in this section.

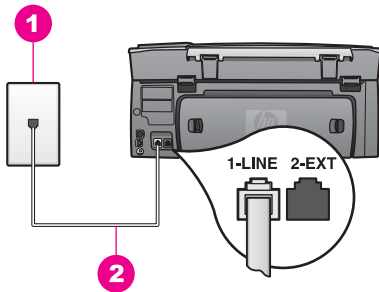

### Back view of the HP all-in-one

1	Telephone wall jack
2	Phone cord supplied in the box with your HP all-in-one connected to the "1-LINE" port

### To set up your HP all-in-one with a separate fax line

- 1 Using the phone cord supplied in the box with your HP all-in-one, connect one end to your telephone wall jack, then connect the other end to the port labeled "1-LINE" on the back of your HP all-in-one.



**Caution** If you do not use the supplied cord to connect from the telephone wall jack to your HP all-in-one, you might not be able to fax successfully. This special phone cord is different from the phone cords you might already have in your home or office. If the supplied phone cord is too short, see [The phone cord that came with my HP all-in-one is not long enough for information on extending it.](#)

- 2 Set up the HP all-in-one to answer incoming calls automatically:
  - a Press **Setup**, press **4**, and then press **3**.  
This displays the **Basic Fax Setup** menu and then selects **Auto Answer**.
  - b Press **1** to select **On**.
  - c Press **OK** to accept the setting.
- 3 (Optional) Change the **Rings to Answer** setting to one ring or two rings. For information on changing this setting, see [Set the number of rings before answering.](#)
- 4 Run a fax test. For information, see [Test your fax setup.](#)

When the phone rings, your HP all-in-one will answer automatically after the number of rings you set in the **Rings to Answer** setting. Then it will begin emitting fax reception tones to the sending fax machine and receive the fax.

## Case B: Set up your HP all-in-one with DSL

If you have a DSL service through your telephone company, use the instructions in this section to connect a DSL filter between the telephone wall jack and your HP all-in-one. The DSL filter removes the digital signal that can interfere with your HP all-in-one from communicating properly with the phone line. (DSL might be called ADSL in your country/region.)

**Caution** If you have a DSL line and you do not connect the DSL filter, you will not be able to send and receive faxes with your HP all-in-one.

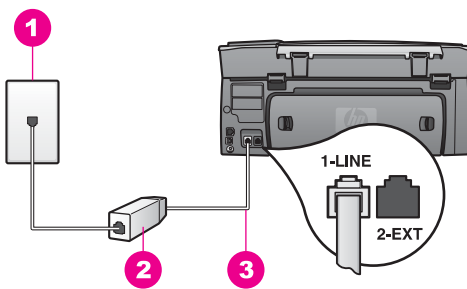

### Back view of the HP all-in-one

1	Telephone wall jack
2	DSL filter and cord supplied by your DSL provider
3	Phone cord supplied in the box with your HP all-in-one connected to the "1-LINE" port

### To set up your HP all-in-one with DSL

- 1 Obtain a DSL filter from your DSL provider.
- 2 Using the phone cord supplied in the box with your HP all-in-one, connect one end to the open port on the DSL filter, then connect the other end to the port labeled "1-LINE" on the back of your HP all-in-one.

**Caution** If you do not use the supplied cord to connect from the telephone wall jack to your HP all-in-one, you might not be able to fax successfully. This special phone cord is different from the phone cords you might already have in your home or office.

- 3 Connect the DSL filter cord to the telephone wall jack.
- 4 Run a fax test. For information, see [Test your fax setup](#).

## Case C: Set up your HP all-in-one with a PBX phone system or an ISDN line

If you are using either a PBX phone system or an ISDN converter/terminal adapter, make sure you do the following:

- If you are using either a PBX or an ISDN converter/terminal adaptor, connect the HP all-in-one to the port that is designated for fax and phone use. Also, make sure that the terminal adapter is set to the correct switch type for your country/region, if possible.

**Note** Some ISDN systems allow you to configure the ports for specific phone equipment. For example, you might have assigned one port for telephone and Group 3 fax and another port for multiple purposes. If you have problems when connected to the fax/phone port of your ISDN converter, try using the port designated for multiple purposes; it might be labeled "multi-combi" or something similar.

- If you are using a PBX phone system, set the call waiting tone to "off."



**Caution** Many digital PBX systems include a call-waiting tone that is factory-set to "on." The call waiting tone will interfere with any fax transmission, and you will not be able to send or receive faxes with your HP all-in-one. Refer to the documentation that came with your PBX phone system for instructions on how to turn off the call-waiting tone.

- If you are using a PBX phone system, dial the number for an outside line before dialing the fax number.
- Make sure you use the supplied cord to connect from the telephone wall jack to your HP all-in-one, you might not be able to fax successfully. This special phone cord is different from the phone cords you might already have in your home or office. If the supplied phone cord is too short, see [The phone cord that came with my HP all-in-one is not long enough](#) for information on extending it.

## Case D: Fax with a distinctive ring service on the same line

If you subscribe to a distinctive ring service (through your telephone company) that allows you to have multiple phone numbers on one phone line, each with a different ring pattern, set up your HP all-in-one as described in this section.



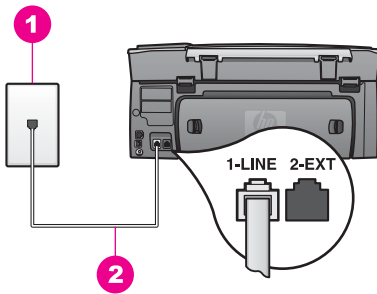

### Back view of the HP all-in-one

1	Telephone wall jack
2	Phone cord supplied in the box with your HP all-in-one connected to the "1-LINE" port

### To set up your HP all-in-one with a distinctive ring service

- Using the phone cord supplied in the box with your HP all-in-one, connect one end to your telephone wall jack, then connect the other end to the port labeled "1-LINE" on the back of your HP all-in-one.



**Caution** If you do not use the supplied cord to connect from the telephone wall jack to your HP all-in-one, you might not be able to fax successfully.

This special phone cord is different from the phone cords you might already have in your home or office. If the supplied phone cord is too short, see [The phone cord that came with my HP all-in-one is not long enough for information on extending it.](#)

- Set up the HP all-in-one to answer incoming calls automatically:
  - Press **Setup**, press **4**, and then press **3**.  
This displays the **Basic Fax Setup** menu and then selects **Auto Answer**.
  - Press **1** to select **On**.
  - Press **OK** to accept the setting.
- Change the **Answer Ring Pattern** setting to the pattern that has been assigned to your fax number by the telephone company, for example, double rings or triple rings.

For information on changing this setting, see [Change the answer ring pattern \(distinctive ringing\).](#)

**Note** Your HP all-in-one is factory-set to answer all ring patterns. If you do not set the correct ring pattern assigned to your fax number by the telephone company, your HP all-in-one might answer both voice calls and fax calls or it might not answer at all.

- (Optional) Change the **Rings to Answer** setting to one ring or two rings.  
For information on changing this setting, see [Set the number of rings before answering.](#)
- Run a fax test. For information, see [Test your fax setup.](#)

Your HP all-in-one will automatically answer incoming calls that have the ring pattern you selected (**Answer Ring Pattern** setting) after the number of rings you selected

(Rings to Answer setting). Then it will begin emitting fax reception tones to the sending fax machine and receive the fax.

## Case E: Shared voice/fax line

If you receive both voice calls and fax calls at the same phone number, and you have no other office equipment (or voice mail) on this phone line, set up your HP all-in-one as described in this section.

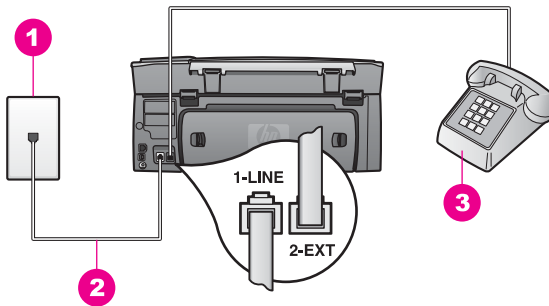

### Back view of the HP all-in-one

1	Telephone wall jack
2	Phone cord supplied in the box with your HP all-in-one connected to the "1-LINE" port
3	Optional phone for the HP all-in-one

### To set up your HP all-in-one with a shared voice/fax line

- 1 Using the phone cord supplied in the box with your HP all-in-one, connect one end to your telephone wall jack, then connect the other end to the port labeled "1-LINE" on the back of your HP all-in-one.



**Caution** If you do not use the supplied cord to connect from the telephone wall jack to your HP all-in-one, you might not be able to fax successfully. This special phone cord is different from the phone cords you might already have in your home or office. If the supplied phone cord is too short, see [The phone cord that came with my HP all-in-one is not long enough for information on extending it.](#)

- 2 Do one of the following, depending on your phone system:
  - If you have a parallel-type phone system, remove the white plug from the port labeled "2-EXT" on the back of your HP all-in-one, and then connect a phone to this port.
  - If you have a serial-type phone system, you might plug your phone directly to the telephone wall jack.
- 3 Now you need to decide how you want the HP all-in-one to answer calls, automatically or manually:
  - If you set up the HP all-in-one to answer calls automatically, it answers all incoming calls and receives faxes. Your HP all-in-one will not be able to

- distinguish between fax and voice calls in this case; if you suspect the call is a voice call, you will need to answer it before the HP all-in-one answers the call.
- If you set up the HP all-in-one to answer faxes manually, you must be available to respond in person to incoming fax calls or your HP all-in-one cannot receive faxes.

- a Press **Setup**, press **4**, and then press **3**.

This displays the **Basic Fax Setup** menu and then selects **Auto Answer**.

- b Press **1** to select **On** (automatic), or press **2** to select **Off** (manual).
- c Press **OK** to accept the setting.

- 4 Run a fax test. For information, see [Test your fax setup](#).

If you pick up the phone before the HP all-in-one and hear fax tones from a sending fax machine, you will need to answer the fax call manually. For information, see [Receive a fax manually](#).

## Case F: Shared voice/fax line with voice mail

If you receive both voice calls and fax calls at the same phone number, and you also subscribe to a voice mail service through your telephone company, set up your HP all-in-one as described in this section.

**Note** You cannot receive faxes automatically if you have a voice mail service at the same phone number you use for fax calls. You must receive faxes manually; this means you must be available to respond in person to incoming fax calls. If you want to receive faxes automatically instead, contact your telephone company to subscribe to a distinctive ring service, or to obtain a separate phone line for faxing.

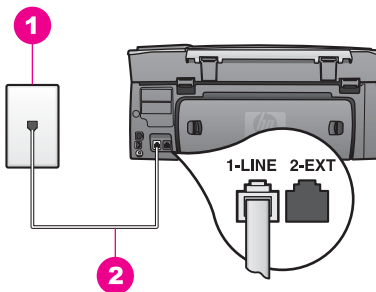

### Back view of the HP all-in-one

1	Telephone wall jack
2	Phone cord supplied in the box with your HP all-in-one connected to the "1-LINE" port

### To set up your HP all-in-one with voice mail

- 1 Using the phone cord supplied in the box with your HP all-in-one, connect one end to your telephone wall jack, then connect the other end to the port labeled "1-LINE" on the back of your HP all-in-one.



**Caution** If you do not use the supplied cord to connect from the telephone wall jack to your HP all-in-one, you might not be able to fax successfully. This special phone cord is different from the phone cords you might already have in your home or office. If the supplied phone cord is too short, see [The phone cord that came with my HP all-in-one is not long enough for information on extending it.](#)

- 2 Set up the HP all-in-one to answer incoming calls manually:
  - a Press **Setup**, press **4**, and then press **3**.

This displays the **Basic Fax Setup** menu and then selects **Auto Answer**.

- b Press **2** to select **Off**.
  - c Press **OK** to accept the setting.
- 3 Run a fax test. For information, see [Test your fax setup](#).

You must be available to respond in person to incoming fax calls, or your HP all-in-one cannot receive faxes. For information on receiving faxes manually, see [Receive a fax manually](#).

## Case G: Fax line shared with PC modem (no voice calls received)

If you have a fax line on which you receive no voice calls, and you also have a PC modem connected on this line, set up your HP all-in-one as described in this section. Since your PC modem shares the phone line with your HP all-in-one, you will not be able to use both your PC modem and your HP all-in-one simultaneously. For example, you cannot use your HP all-in-one for faxing if you are using your PC modem to send an e-mail or access the Internet.

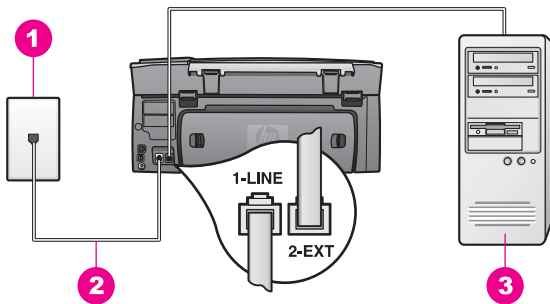

### Back view of the HP all-in-one

1	Telephone wall jack
2	Phone cord supplied in the box with your HP all-in-one connected to the "1-LINE" port
3	Computer with modem

### To set up your HP all-in-one with a PC modem

- 1 Remove the white plug from the port labeled "2-EXT" on the back of your HP all-in-one.

- 2 Find the phone cord that connects from the back of your computer (your PC modem) to a telephone wall jack. Disconnect the cord from the telephone wall jack and plug it into the port labeled "2-EXT" on the back of your HP all-in-one.
- 3 Using the phone cord supplied in the box with your HP all-in-one, connect one end to your telephone wall jack, then connect the other end to the port labeled "1-LINE" on the back of your HP all-in-one.



**Caution** If you do not use the supplied cord to connect from the telephone wall jack to your HP all-in-one, you might not be able to fax successfully. This special phone cord is different from the phone cords you might already have in your home or office. If the supplied phone cord is too short, see [The phone cord that came with my HP all-in-one is not long enough](#) for information on extending it.

- 4 If your PC modem software is set to receive faxes to your computer automatically, turn off that setting.



**Caution** If you do not turn off the auto fax receive setting in your PC modem software, your HP all-in-one will not be able to receive faxes.

- 5 Set up the HP all-in-one to answer incoming calls automatically by setting the **Auto Answer** option to **On**:
  - a Press **Setup**, press **4**, and then press **3**.  
This displays the **Basic Fax Setup** menu and then selects **Auto Answer**.
  - b Press **1** to select **On**.
  - c Press **OK** to accept the setting.
- 6 (Optional) Change the **Rings to Answer** setting to one ring or two rings. For information on changing this setting, see [Set the number of rings before answering](#).
- 7 Run a fax test. For information, see [Test your fax setup](#).

When the phone rings, your HP all-in-one will answer automatically after the number of rings you set in the **Rings to Answer** setting. Then it will begin emitting fax reception tones to the sending fax machine and receive the fax.

## Case H: Shared voice/fax line with PC modem

If you receive both voice calls and fax calls at the same phone number, and you also have a PC modem connected on this phone line, set up your HP all-in-one as described in this section.

Since your PC modem shares the phone line with your HP all-in-one, you will not be able to use both your PC modem and your HP all-in-one simultaneously. For example, you cannot use your HP all-in-one for faxing if you are using your PC modem to send an e-mail or access the Internet.

There are two different ways to set up your HP all-in-one with your computer based on the number of phone ports on your computer. Before you begin, check your computer to see if it has one or two phone ports:

- If your computer has only one phone port, see the next section, [Set up your HP all-in-one to a computer with one phone port](#). You will need to purchase a parallel splitter (also called a coupler) in order to send and receive faxes successfully and use your PC modem. (A parallel splitter has one RJ-11 port on the

front and two RJ-11 ports on the back. Do not use a 2-line phone splitter, a serial splitter, or a parallel splitter which has two RJ-11 ports on the front and a plug on the back.) You will also need three additional phone cords. You can purchase a parallel splitter and additional phone cords from an electronics store that carries phone accessories.

- If your computer has two phone ports, see [Set up your HP all-in-one to a computer with two phone ports](#).

## Set up your HP all-in-one to a computer with one phone port

This section describes how to set up your HP all-in-one with a PC modem if your computer has only one phone port.

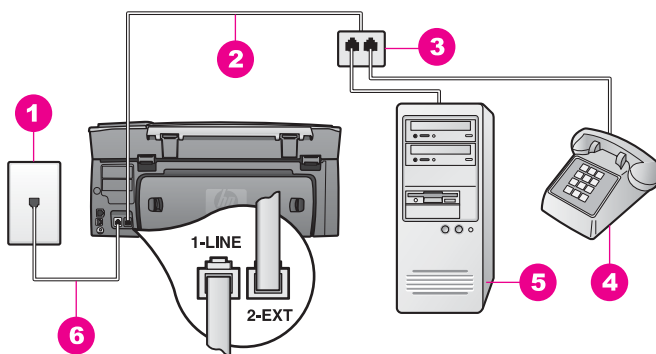

### Back view of the HP all-in-one

1	Telephone wall jack
2	Phone cord connected to the "2-EXT" port
3	Parallel splitter
4	Telephone
5	Computer with modem
6	Phone cord supplied in the box with your HP all-in-one connected to the "1-LINE" port

### To set up your HP all-in-one to a computer with one phone port

- 1 Find the phone cord that connects from the back of your computer (your PC modem) to a telephone wall jack. Disconnect the cord from the telephone wall jack and plug it into the parallel splitter on the side with two phone ports.
- 2 Using the phone cord supplied in the box with your HP all-in-one, connect one end to your telephone wall jack, then connect the other end to the port labeled "1-LINE" on the back of your HP all-in-one.



**Caution** If you do not use the supplied cord to connect from the telephone wall jack to your HP all-in-one, you might not be able to fax successfully. This special phone cord is different from the phone cords you might already have in your home or office. If the supplied phone cord is too short, see [The phone cord that came with my HP all-in-one is not long enough for information on extending it.](#)

- 3 Remove the white plug from the port labeled "2-EXT" on the back of your HP all-in-one.
- 4 Using another phone cord, connect one end to the port labeled "2-EXT" on the back of your HP all-in-one. Connect the other end of the phone cord to the parallel splitter on the side with the single phone port.
- 5 If your PC modem software is set to receive faxes to your computer automatically, turn off that setting.



**Caution** If you do not turn off the auto fax receive setting in your PC modem software, your HP all-in-one will not be able to receive faxes.

- 6 (Optional) Connect a phone to the other open phone port on the parallel splitter.
- 7 Now you need to decide how you want the HP all-in-one to answer calls, automatically or manually:
  - If you set up the HP all-in-one to answer calls automatically, it answers all incoming calls and receives faxes. Your HP all-in-one will not be able to distinguish between fax and voice calls in this case; if you suspect the call is a voice call, you will need to answer it before the HP all-in-one answers the call.
  - If you set up the HP all-in-one to answer faxes manually, you must be available to respond in person to incoming fax calls or your HP all-in-one cannot receive faxes.
    - a Press **Setup**, press **4**, and then press **3**.  
This displays the **Basic Fax Setup** menu and then selects **Auto Answer**.
    - b Press **1** to select **On** (automatic), or press **2** to select **Off** (manual).
    - c Press **OK** to accept the setting.
- 8 Run a fax test. For information, see [Test your fax setup](#).

If you pick up the phone before the HP all-in-one and hear fax tones from a sending fax machine, you will need to answer the fax call manually. For information, see [Receive a fax manually](#).

### Set up your HP all-in-one to a computer with two phone ports

This section describes how to set up your HP all-in-one with a PC modem if your computer has two phone ports.

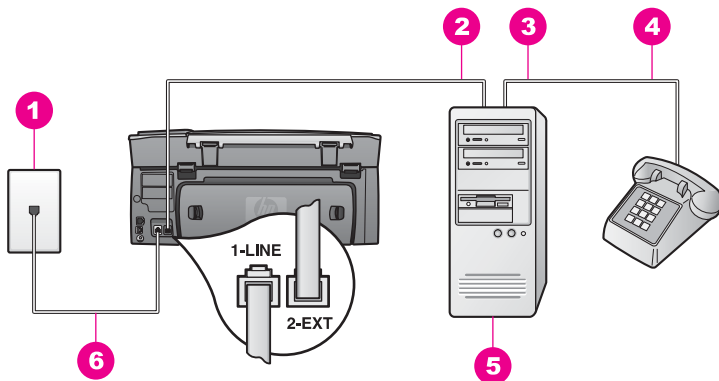

### Back view of the HP all-in-one

1	Telephone wall jack
2	"IN" phone port on your computer
3	"OUT" phone port on your computer
4	Telephone
5	Computer with modem
6	Phone cord supplied in the box with your HP all-in-one connected to the "1-LINE" port

### To set up your HP all-in-one to a computer with two phone ports

- 1 Remove the white plug from the port labeled "2-EXT" on the back of your HP all-in-one.
- 2 Find the phone cord that connects from the back of your computer (your PC modem) to a telephone wall jack. Disconnect the cord from the telephone wall jack and plug it into the port labeled "2-EXT" on the back of your HP all-in-one.
- 3 Connect a phone to the "OUT" port on the back of your PC modem.
- 4 Using the phone cord supplied in the box with your HP all-in-one, connect one end to your telephone wall jack, then connect the other end to the port labeled "1-LINE" on the back of your HP all-in-one.



**Caution** If you do not use the supplied cord to connect from the telephone wall jack to your HP all-in-one, you might not be able to fax successfully. This special phone cord is different from the phone cords you might already have in your home or office. If the supplied phone cord is too short, see [The phone cord that came with my HP all-in-one is not long enough for information on extending it.](#)

- 5 If your PC modem software is set to receive faxes to your computer automatically, turn off that setting.



**Caution** If you do not turn off the auto fax receive setting in your PC modem software, your HP all-in-one will not be able to receive faxes.

- 6 Now you need to decide how you want the HP all-in-one to answer calls, automatically or manually:
  - If you set up the HP all-in-one to answer calls automatically, it answers all incoming calls and receives faxes. Your HP all-in-one will not be able to



- distinguish between fax and voice calls in this case; if you suspect the call is a voice call, you will need to answer it before the HP all-in-one answers the call.
- If you set up the HP all-in-one to answer faxes manually, you must be available to respond in person to incoming fax calls or your HP all-in-one cannot receive faxes.
  - a Press **Setup**, press **4**, and then press **3**.  
This displays the **Basic Fax Setup** menu and then selects **Auto Answer**.
  - b Press **1** to select **On** (automatic), or press **2** to select **Off** (manual).
  - c Press **OK** to accept the setting.
- 7 Run a fax test. For information, see [Test your fax setup](#).

If you pick up the phone before the HP all-in-one and hear fax tones from a sending fax machine, you will need to answer the fax call manually. For information, see [Receive a fax manually](#).

## Case I: Shared voice/fax line with answering machine

If you receive both voice calls and fax calls at the same phone number, and you also have an answering machine that answers voice calls at this phone number, set up your HP all-in-one as described in this section.

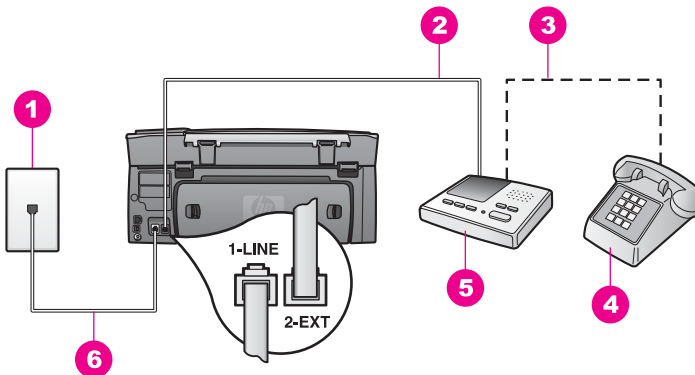

### Back view of the HP all-in-one

1	Telephone wall jack
2	"IN" port on your answering machine
3	"OUT" port on your answering machine
4	Telephone (optional)
5	Answering machine
6	Phone cord supplied in the box with your HP all-in-one connected to the "1-LINE" port

### To set up your HP all-in-one with a shared voice/fax line with answering machine

- 1 Remove the white plug from the port labeled "2-EXT" on the back of your HP all-in-one.
- 2 Unplug your answering machine from the telephone wall jack, and connect it to the port labeled "2-EXT" on the back of your HP all-in-one.

**Note** If you do not connect your answering machine directly to your HP all-in-one, fax tones from a sending fax machine might be recorded on your answering machine, and you probably will not be able to receive faxes with your HP all-in-one.

- Using the phone cord supplied in the box with your HP all-in-one, connect one end to your telephone wall jack, then connect the other end to the port labeled "1-LINE" on the back of your HP all-in-one.



**Caution** If you do not use the supplied cord to connect from the telephone wall jack to your HP all-in-one, you might not be able to fax successfully. This special phone cord is different from the phone cords you might already have in your home or office. If the supplied phone cord is too short, see [The phone cord that came with my HP all-in-one is not long enough for information on extending it.](#)

- (Optional) If your answering machine does not have a built-in phone, for convenience you might want to connect a phone to the back of your answering machine at the "OUT" port.
- Set up the HP all-in-one to answer incoming calls automatically:
  - Press **Setup**, press **4**, and then press **3**.  
This displays the **Basic Fax Setup** menu and then selects **Auto Answer**.
  - Press **1** to select **On**.
  - Press **OK** to accept the setting.
- Set your answering machine to answer after four or fewer rings.
- Change the **Rings to Answer** setting on your HP all-in-one to six rings. For information on changing this setting, see [Set the number of rings before answering](#).
- Run a fax test. For information, see [Test your fax setup](#).

When the phone rings, your answering machine will answer after the number of rings you have set, and then play your recorded greeting. The HP all-in-one monitors the call during this time, "listening" for fax tones. If incoming fax tones are detected, the HP all-in-one will emit fax reception tones and receive the fax; if there are no fax tones, the HP all-in-one stops monitoring the line and your answering machine can record a voice message.

## Case J: Shared voice/fax line with PC modem and answering machine

If you receive both voice calls and fax calls at the same phone number, and you also have a PC modem and answering machine connected on this phone line, set up your HP all-in-one as described in this section.

Since your PC modem shares the phone line with your HP all-in-one, you will not be able to use both your PC modem and your HP all-in-one simultaneously. For example, you cannot use your HP all-in-one for faxing if you are using your PC modem to send an e-mail or access the Internet.

There are two different ways to set up your HP all-in-one with your computer based on the number of phone ports on your computer. Before you begin, check your computer to see if it has one or two phone ports:

- If your computer has only one phone port, see the next section, [Set up your HP all-in-one to a computer with one phone port](#). You will need to purchase a parallel splitter (also called a coupler) in order to send and receive faxes successfully and use your PC modem. (A parallel splitter has one RJ-11 port on the front and two RJ-11 ports on the back. Do not use a 2-line phone splitter, a serial splitter, or a parallel splitter which has two RJ-11 ports on the front and a plug on the back.) You will also need three additional phone cords. You can purchase a parallel splitter and additional phone cords from an electronics store.
- If your computer has two phone ports, see [Set up your HP all-in-one to a computer with two phone ports](#).

### Set up your HP all-in-one to a computer with one phone port

This section describes how to set up your HP all-in-one with a PC modem if your computer has only one phone port.

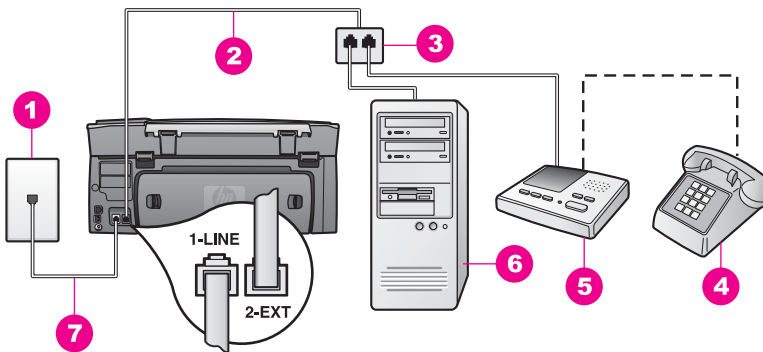

#### Back view of the HP all-in-one

1	Telephone wall jack
2	Phone cord connected to the "2-EXT" port
3	Parallel splitter
4	Telephone (optional)
5	Answering machine
6	Computer with modem
7	Phone cord supplied in the box with your HP all-in-one connected to the "1-LINE" port

#### To set up your HP all-in-one to a computer with one phone port

- 1 Find the phone cord that connects from the back of your computer (your PC modem) to a telephone wall jack. Disconnect the cord from the telephone wall jack and plug it into the parallel splitter on the side with two phone ports.
- 2 Using the phone cord supplied in the box with your HP all-in-one, connect one end to your telephone wall jack, then connect the other end to the port labeled "1-LINE" on the back of your HP all-in-one.



**Caution** If you do not use the supplied cord to connect from the telephone wall jack to your HP all-in-one, you might not be able to fax successfully. This special phone cord is different from the phone cords you might already have in your home or office. If the supplied phone cord is too short, see [The phone cord that came with my HP all-in-one is not long enough for information on extending it.](#)

- 3 Remove the white plug from the port labeled "2-EXT" on the back of your HP all-in-one.
- 4 Using another phone cord, connect one end to the port labeled "2-EXT" on the back of your HP all-in-one. Connect the other end of the phone cord to the parallel splitter on the side with the single phone port.
- 5 Unplug your answering machine from the telephone wall jack, and connect it to the parallel splitter on the side with two phone ports.

**Note** If you do not connect your answering machine in this way, fax tones from a sending fax machine might be recorded on your answering machine, and you might not be able to receive faxes with your HP all-in-one.

- 6 (Optional) If your answering machine does not have a built-in phone, for convenience you might want to connect a phone to the back of your answering machine at the "OUT" port.
- 7 If your PC modem software is set to receive faxes to your computer automatically, turn off that setting.



**Caution** If you do not turn off the auto fax receive setting in your PC modem software, your HP all-in-one will not be able to receive faxes.

- 8 Set up the HP all-in-one to answer incoming calls automatically:
  - a Press **Setup**, press **4**, and then press **3**.  
This displays the **Basic Fax Setup** menu and then selects **Auto Answer**.
  - b Press **1** to select **On**.
  - c Press **OK** to accept the setting.
- 9 Set your answering machine to answer after four or fewer rings.
- 10 Change the **Rings to Answer** setting on your HP all-in-one to six rings. For information on changing this setting, see [Set the number of rings before answering](#).
- 11 Run a fax test. For information, see [Test your fax setup](#).

When the phone rings, your answering machine will answer after the number of rings you have set, and then play your recorded greeting. The HP all-in-one monitors the call during this time, "listening" for fax tones. If incoming fax tones are detected, the HP all-in-one will emit fax reception tones and receive the fax; if there are no fax tones, the HP all-in-one stops monitoring the line and your answering machine can record a voice message.

### Set up your HP all-in-one to a computer with two phone ports

This section describes how to set up your HP all-in-one with a PC modem if your computer has two phone ports.

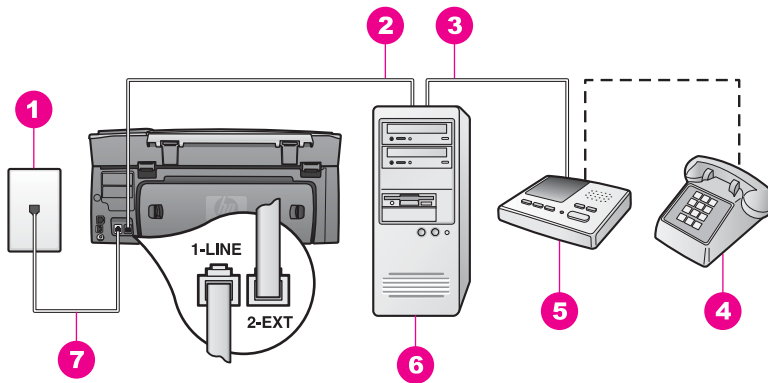

### Back view of the HP all-in-one

1	Telephone wall jack
2	"IN" phone port on your computer
3	"OUT" phone port on your computer
4	Telephone
5	Answering machine
6	Computer with modem
7	Phone cord supplied in the box with your HP all-in-one connected to the "1-LINE" port

### To set up your HP all-in-one to a computer with two phone ports

- 1 Remove the white plug from the port labeled "2-EXT" on the back of your HP all-in-one.
- 2 Find the phone cord that connects from the back of your computer (your PC modem) to a telephone wall jack. Disconnect the cord from the telephone wall jack and plug it into the port labeled "2-EXT" on the back of your HP all-in-one.
- 3 Unplug your answering machine from the telephone wall jack, and connect it to the "OUT" port on the back of your PC modem.

This allows a direct connection between the HP all-in-one and your answering machine, even though the PC modem is connected first in line.

**Note** If you do not connect your answering machine in this way, fax tones from a sending fax machine might be recorded on your answering machine, and you might not be able to receive faxes with your HP all-in-one.

- 4 Using the phone cord supplied in the box with your HP all-in-one, connect one end to your telephone wall jack, then connect the other end to the port labeled "1-LINE" on the back of your HP all-in-one.



**Caution** If you do not use the supplied cord to connect from the telephone wall jack to your HP all-in-one, you might not be able to fax successfully. This special phone cord is different from the phone cords you might already have in your home or office. If the supplied phone cord is too short, see [The phone cord that came with my HP all-in-one is not long enough for information on extending it.](#)

- 5 (Optional) If your answering machine does not have a built-in phone, for convenience you might want to connect a phone to the back of your answering machine at the "OUT" port.
- 6 If your PC modem software is set to receive faxes to your computer automatically, turn off that setting.



**Caution** If you do not turn off the auto fax receive setting in your PC modem software, your HP all-in-one will not be able to receive faxes.

- 7 Set up the HP all-in-one to answer incoming calls automatically:
  - a Press **Setup**, press **4**, and then press **3**.  
This displays the **Basic Fax Setup** menu and then selects **Auto Answer**.
  - b Press **1** to select **On**.
  - c Press **OK** to accept the setting.
- 8 Set your answering machine to answer after four or fewer rings.
- 9 Change the **Rings to Answer** setting on your HP all-in-one to six rings.  
For information on changing this setting, see [Set the number of rings before answering](#).
- 10 Run a fax test. For information, see [Test your fax setup](#).

When the phone rings, your answering machine will answer after the number of rings you have set, and then play your recorded greeting. The HP all-in-one monitors the call during this time, "listening" for fax tones. If incoming fax tones are detected, the HP all-in-one will emit fax reception tones and receive the fax; if there are no fax tones, the HP all-in-one stops monitoring the line and your answering machine can record a voice message.

## Case K: Shared voice/fax line with PC modem and voice mail

If you receive both voice calls and fax calls at the same phone number, use a PC modem on the same phone line, and subscribe to a voice mail service through your telephone company, set up your HP all-in-one as described in this section.

**Note** You cannot receive faxes automatically if you have a voice mail service at the same phone number you use for fax calls. You must receive faxes manually; this means you must be available to respond in person to incoming fax calls. If you want to receive faxes automatically instead, contact your telephone company to subscribe to a distinctive ring service, or to obtain a separate phone line for faxing.

Since your PC modem shares the phone line with your HP all-in-one, you will not be able to use both your PC modem and your HP all-in-one simultaneously. For example, you cannot use your HP all-in-one for faxing if you are using your PC modem to send an e-mail or access the Internet.

There are two different ways to set up your HP all-in-one with your computer based on the number of phone ports on your computer. Before you begin, check your computer to see if it has one or two phone ports:

- If your computer has only one phone port, see the next section, [Set up your HP all-in-one to a computer with one phone port](#). You will need to purchase a parallel splitter (also called a coupler) in order to send and receive faxes

successfully and use your PC modem. (A parallel splitter has one RJ-11 port on the front and two RJ-11 ports on the back. Do not use a 2-line phone splitter, a serial splitter, or a parallel splitter which has two RJ-11 ports on the front and a plug on the back.) You will also need three additional phone cords. You can purchase a parallel splitter and additional phone cords from an electronics store.

- If your computer has two phone ports, see [Set up your HP all-in-one to a computer with two phone ports](#).

## Set up your HP all-in-one to a computer with one phone port

This section describes how to set up your HP all-in-one with a PC modem if your computer has only one phone port.

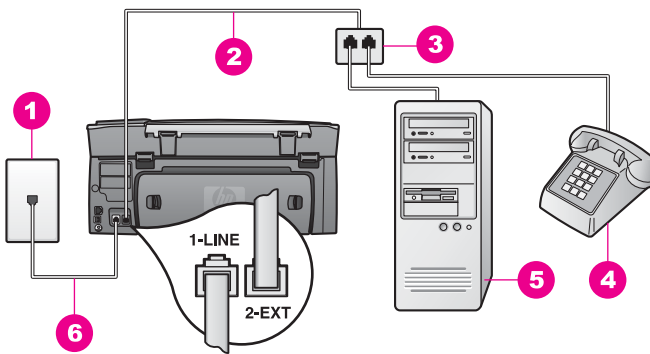

### Back view of the HP all-in-one

1	Telephone wall jack
2	Phone cord connected to the "2-EXT" port
3	Parallel splitter
4	Telephone
5	Computer with modem
6	Phone cord supplied in the box with your HP all-in-one connected to the "1-LINE" port

### To set up your HP all-in-one to a computer with one phone port

- 1 Find the phone cord that connects from the back of your computer (your PC modem) to a telephone wall jack. Disconnect the cord from the telephone wall jack and plug it into the parallel splitter on the side with two phone ports.
- 2 Using another phone cord, connect one end to the port labeled "2-EXT" on the back of your HP all-in-one. Connect the other end of the phone cord to the parallel splitter on the side with the single phone port.
- 3 Using the phone cord supplied in the box with your HP all-in-one, connect one end to your telephone wall jack, then connect the other end to the port labeled "1-LINE" on the back of your HP all-in-one.



**Caution** If you do not use the supplied cord to connect from the telephone wall jack to your HP all-in-one, you might not be able to fax successfully.

This special phone cord is different from the phone cords you might already have in your home or office. If the supplied phone cord is too short, see [The](#)

phone cord that came with my HP all-in-one is not long enough for information on extending it.

- 4 Remove the white plug from the port labeled "2-EXT" on the back of your HP all-in-one.
- 5 If your PC modem software is set to receive faxes to your computer automatically, turn off that setting.



**Caution** If you do not turn off the auto fax receive setting in your PC modem software, your HP all-in-one will not be able to receive faxes.

- 6 (Optional) Connect a phone to the other open phone port on the parallel splitter.
- 7 Set up the HP all-in-one to answer incoming calls manually:
  - a Press **Setup**, press **4**, and then press **3**.  
This displays the **Basic Fax Setup** menu and then selects **Auto Answer**.
  - b Press **2** to select **Off**.
  - c Press **OK** to accept the setting.
- 8 Run a fax test. For information, see [Test your fax setup](#).

You must be available to respond in person to incoming fax calls, or your HP all-in-one cannot receive faxes. For information on receiving faxes manually, see [Receive a fax manually](#).

## Set up your HP all-in-one to a computer with two phone ports

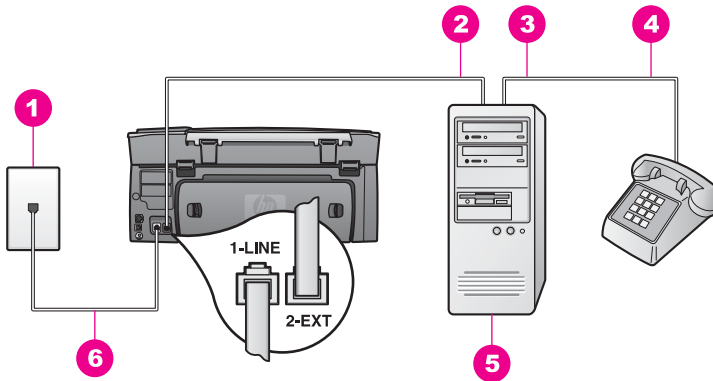

### Back view of the HP all-in-one

1	Telephone wall jack
2	"IN" phone port on your computer
3	"OUT" phone port on your computer
4	Telephone
5	Computer with modem
6	Phone cord supplied in the box with your HP all-in-one connected to the "1-LINE" port

### To set up your HP all-in-one to a computer with two phone ports

- 1 Remove the white plug from the port labeled "2-EXT" on the back of your HP all-in-one.



- 2 Find the phone cord that connects from the back of your computer (your PC modem) to a telephone wall jack. Disconnect the cord from the telephone wall jack and plug it into the port labeled "2-EXT" on the back of your HP all-in-one.
- 3 Connect a phone to the "OUT" port on the back of your PC modem.
- 4 Using the phone cord supplied in the box with your HP all-in-one, connect one end to your telephone wall jack, then connect the other end to the port labeled "1-LINE" on the back of your HP all-in-one.



**Caution** If you do not use the supplied cord to connect from the telephone wall jack to your HP all-in-one, you might not be able to fax successfully. This special phone cord is different from the phone cords you might already have in your home or office. If the supplied phone cord is too short, see [The phone cord that came with my HP all-in-one is not long enough](#) for information on extending it.

- 5 If your PC modem software is set to receive faxes to your computer automatically, turn off that setting.



**Caution** If you do not turn off the auto fax receive setting in your modem software, your HP all-in-one will not be able to receive faxes.

- 6 Set up the HP all-in-one to answer incoming calls manually:
  - a Press **Setup**, press **4**, and then press **3**.  
This displays the **Basic Fax Setup** menu and then selects **Auto Answer**.
  - b Press **2** to select **Off**.
  - c Press **OK** to accept the setting.
- 7 Run a fax test. For information, see the next section, [Test your fax setup](#).

You must be available to respond in person to incoming fax calls, or your HP all-in-one cannot receive faxes. For information on receiving faxes manually, see [Receive a fax manually](#).

## Test your fax setup

You can test your fax setup to check the status of your HP all-in-one and to make sure it is set up properly for faxing. Perform this test after you have completed setting up your HP all-in-one for faxing. The test does the following:

- Checks the fax hardware
- Verifies that the phone cord is plugged into the correct port
- Checks for a dial tone
- Checks for an active phone line
- Checks the status of your phone line connection

The HP all-in-one prints a report with the results of the test. If the test fails, review the report for information on how to fix the problem and rerun the test.

### To test your fax setup from the control panel

- 1 Set up your HP all-in-one for faxing according to the setup instructions in this chapter.
- 2 Make sure you have inserted the print cartridges and loaded paper before starting the test.  
For more information, see [Replace the print cartridges](#) and [Load full-size paper](#).

- 3 Press **Setup**.
- 4 Press **6**, then press **5**.  
This displays the **Tools** menu and then selects **Run Fax Test**.  
The HP all-in-one displays the status of the test on the color graphics display and prints a report.
- 5 Review the report.
  - If the test passes and you are still having problems faxing, check the fax settings listed in the report to verify the settings are correct. A blank or incorrect fax setting can cause problems faxing.
  - If the test fails, review the report for more information on how to fix any problems found.
- 6 After you pick up the fax report from your HP all-in-one, press **OK**.  
If necessary, resolve any problems found and rerun the test.  
For more information on resolving any problems found during the test, see [The fax test failed](#).



# 11 Use the fax features

You can use your HP all-in-one to send and receive faxes, including color faxes. You can set up speed dials to send faxes quickly and easily to frequently used numbers. From the control panel, you can also set a number of fax options, such as resolution.

You should explore the **HP Director** that came with your **HP Image Zone** software to take full advantage of all of its features. Using the **HP Director**, you can send a fax from your computer, include a computer-generated cover page, and quickly set up speed dials. For more information, see the onscreen **HP Image Zone Help**.

For information on accessing the **HP Director** and the onscreen help, see [Use the HP Image Zone to do more with your HP all-in-one](#).

## Set up the HP all-in-one to receive faxes

Your HP all-in-one can be set up to receive faxes automatically or manually, depending on your home or office setup. If you set up the HP all-in-one to answer faxes automatically, it answers all incoming calls and receives faxes. If you set up the HP all-in-one to answer faxes manually, you must be available to respond in person to the incoming fax call, or your HP all-in-one cannot receive faxes. For more information on receiving faxes manually, see [Receive a fax manually](#).

In certain situations you might want to receive faxes manually. For example, if you share a line between your HP all-in-one and phone and you do not have distinctive ringing or an answering machine, you will need to set up the HP all-in-one to answer fax calls manually. If you subscribe to a voice mail service, you will also need to answer fax calls manually. This is because the HP all-in-one will not be able to distinguish between fax calls and phone calls.

For more information on setting up your office equipment with the HP all-in-one, see [Fax setup](#).

### Choose the recommended answer mode for your setup

Refer to the table below to determine how you should answer incoming fax calls based on your home or office setup. From the first column in the table, choose the type of equipment and services applicable to your office setup. Then, look up the appropriate setting in the second column. The third column describes how the HP all-in-one will answer incoming calls.

After you have determined the recommended answer mode setting for your home or office setup, see [Set the answer mode](#) for more information.

Equipment/services sharing your fax line	Recommended Auto Answer setting	Description
None. (You have a separate fax line on which you receive only fax calls.)	On	The HP all-in-one automatically answers all incoming calls using the <b>Rings to Answer</b> setting. For more information on setting the

Equipment/services sharing your fax line	Recommended Auto Answer setting	Description
		number of rings, see <a href="#">Set the number of rings before answering</a> .
<p>A shared voice and fax line and no answering machine.</p> <p>(You have a shared phone line in which you receive both voice and fax calls.)</p>	Off	<p>The HP all-in-one will not automatically answer calls. You must receive all faxes manually by pressing <b>Start Black</b> or <b>Start Color</b>. For information on receiving faxes manually, see <a href="#">Receive a fax manually</a>.</p> <p>You might use this setting if the majority of calls on this phone line are voice calls and you rarely receive faxes.</p>
<p>Voice mail service provided by your telephone company.</p>	Off	<p>The HP all-in-one will not automatically answer calls. You must receive all faxes manually by pressing <b>Start Black</b> or <b>Start Color</b>. For information on receiving faxes manually, see <a href="#">Receive a fax manually</a>.</p>
<p>An answering machine and a shared voice and fax line.</p>	On	<p>The answering machine will answer the call and the HP all-in-one will monitor the line. If the HP all-in-one detects fax tones, the HP all-in-one will receive the fax.</p> <p><b>Note</b> This is the recommended default setting if you have an answering machine. Make sure the answering machine is set up properly with the HP all-in-one. For information, see <a href="#">Fax setup</a>.</p> <p>Also, set your HP all-in-one to answer the phone after the answering machine. The number of rings to answer for the HP all-in-one should be greater than the number of rings to answer for the answering machine. You want the answering machine to answer before your HP all-in-one. For more information on setting the number of rings to answer, see <a href="#">Set the number of rings before answering</a>.</p>
<p>Distinctive ringing service.</p>	On	<p>The HP all-in-one automatically answers all incoming calls.</p> <p>Make sure the ring pattern the phone company set for your fax line matches the <b>Answer Ring Pattern</b> set for the HP all-in-one. For more information, see <a href="#">Change the answer ring pattern (distinctive ringing)</a>.</p>

## Set the answer mode

The answer mode determines whether your HP all-in-one answers incoming calls or not. If you set up the HP all-in-one to answer faxes automatically (the **Auto Answer** option is set to **Yes**), it answers all incoming calls and receives faxes. If you set up the HP all-in-one to answer faxes manually (the **Auto Answer** option is set to **Off**), you must be available to respond in person to the incoming fax call, or your HP all-in-one will not receive faxes. For more information on receiving faxes manually, see [Receive a fax manually](#).

If you do not know which answer mode to use, see [Choose the recommended answer mode for your setup](#).

- 1 Press **Setup**.
- 2 Press **4**, and then press **3**.  
This displays the **Basic Fax Setup** menu and then selects **Auto Answer**.
- 3 Press **1** to select **On**, or press **2** to select **Off**.
- 4 Press **OK** to accept the setting.

## Send a fax

You can send a fax in a variety of ways. Using the control panel, you can send a black-and-white or color fax from your HP all-in-one. You can also send a fax manually from an attached phone. This allows you to speak with the recipient before sending the fax.

If you frequently send faxes to the same numbers, you can set up speed dials. Review this section for more information on all the ways you can send faxes.

### Send a basic fax

You can send a basic multiple-page fax by using the control panel.

**Note** If you need printed confirmation that your faxes were successfully sent, enable fax confirmation **before** sending any faxes. For information, see [Enable fax confirmation](#).

**Tip** You can also send a fax using monitor dialing. This allows you to control the pace of your dialing. This feature is useful when you want to use a calling card to charge the call and you need to respond to tone prompts while dialing. For more information, see [Send a fax using monitor dialing](#).

- 1 Load the first page face down on the right front corner of the glass.
- 2 Press **Fax**.  
The **Enter Fax Number** screen appears.
- 3 Enter the fax number by using the keypad.

**Tip** To enter a pause within a number sequence, press the **Space (#)** button repeatedly, until a dash appears on the color graphics display.

- 4 Press **Start Black**.
- 5 If the most recently sent black-and-white fax is stored in memory, the **Fax Mode** screen appears. Press **1** to send a new fax.
- 6 Press **Start Black** again.
- 7 If you have another page to fax, when prompted, press **1**. Load the next page face down on the right front corner of the glass, and then press **Start Black**. If you do not have another page to fax, press **2**.

After all the pages are scanned, the HP all-in-one sends the fax.

**Tip** You can also send a fax in color, such as a photo, from your HP all-in-one. Just press **Start Color** instead of **Start Black**.

Did you know that you can send a fax from your computer by using the **HP Director** that came with your **HP Image Zone** software? You can also create and attach a computer-generated cover page to send with your fax. It's easy. For more information, see the onscreen **HP Image Zone Help** that came with your **HP Image Zone** software.

## Enable fax confirmation

If you need printed confirmation that your faxes were successfully sent, follow these instructions to enable fax confirmation **before** sending any faxes.

The default fax confirmation setting is **Every Error**. This means that your HP all-in-one prints a report only if there is a problem with sending or receiving a fax. A confirmation message indicating whether a fax was successfully sent appears briefly on the color graphics display after each transaction. For more information on printing reports, see [Print reports](#).

- 1 Press **Setup**.
- 2 Press **2**, and then press **1**.  
This displays the **Print Report** menu and then selects **Fax Report Setup**.
- 3 Press **5**, and then press **OK**.

This selects **Send Only**.

Every time you send a fax, the HP all-in-one will print a confirmation report informing you whether the fax was sent successfully or not.

**Note** If you select **Send Only**, you will not receive printed reports if there are errors while the HP all-in-one is receiving faxes. Print the **Fax Log** to view any receive errors. For more information on printing the **Fax Log**, see [Generate reports manually](#).

## Send a fax manually from a phone

You can make a phone call and talk with the recipient before you send your fax. This method of sending a fax is called manually sending a fax. Sending a fax manually is useful if you want to make sure the recipient is available to receive the fax before you send it.

**Note** If you are going to send the fax directly to another fax machine, rather than speak with the recipient before sending it, we recommend that you send it directly from the control panel. When you send a fax manually from a phone, it can take longer to send. The other fax machine might time out before receiving the fax and the transmission might fail. In this case, send the fax from the control panel or by using monitor dialing. For information, see [Send a basic fax](#) or [Send a fax using monitor dialing](#).

The phone must be connected to the "2-EXT" port on the back of the HP all-in-one. For information on setting up your HP all-in-one with your phone, see [Fax setup](#).

You can send a black-and-white or color fax from a telephone; the following section provides instructions for sending the fax in black and white.

## To send a fax manually from a phone

- 1 Load the first page face down on the right front corner of the glass.
- 2 Dial the number by using the keypad on the phone that is connected to your HP all-in-one.

**Note** You must use the keypad on the phone to dial the number. Do not use the keypad on the control panel of the HP all-in-one.

- 3 Once you are ready to send the fax, press **Fax**.  
The **Fax Mode** screen appears.
- 4 Press **1** to send a new fax.
- 5 Press **Start Black**.  
If the recipient answers the telephone, you can engage in a conversation before sending your fax. Inform the recipient that they should press Start on their fax machine after they hear fax tones.
- 6 If you have another page to fax, when prompted, press **1**. Load it face down on the right front corner of the glass, and then press **OK**. If you do not have another page to fax, press **2**.

**Note** If you do not respond to the prompt within 30 seconds, the HP all-in-one automatically sends your fax.

The telephone line will go silent while the fax is transmitting. At this point, you can hang up the telephone. If you want to continue speaking with the recipient, remain on the line until the fax transmission is complete.

## Resend a fax to multiple recipients

The last black-and-white fax sent is stored in memory so that you can resend it to other recipients quickly without having to rescan the originals. The HP all-in-one does not store color faxes in memory.

The fax is stored in memory for up to 5 minutes while you remain in the **Enter Fax Number** screen. If you press any button that will exit the Fax menu (such as **Cancel**) or send a color fax, it will be deleted from memory.

- 1 Send a black-and-white fax.  
For information, see [Send a basic fax](#).
- 2 Enter the next fax number by using the keypad.
- 3 Press **Start Black**.
- 4 If the most recently sent black-and-white fax is still stored in memory, the **Fax Mode** screen appears.
- 5 Press **2** to send the last fax in memory.

The HP all-in-one dials the fax number and sends the fax. You can repeat these steps to send the fax stored in memory to another recipient.

## Send a fax using redial

You can use redial to send a fax to the last fax number dialed. You can send a black-and-white or color fax using redial. The following section provides instructions for sending the fax in black and white.

- 1 Load the first page face down on the right front corner of the glass.
- 2 Press **Fax**.  
The **Enter Fax Number** screen appears.



- 3 Press ▲ to redial the last number dialed.
- 4 Press **Start Black**.
- 5 If the most recently sent black-and-white fax is stored in memory, the **Fax Mode** screen appears. Press **1** to send a new fax.
- 6 Press **Start Black**.
- 7 If you have another page to fax, when prompted, press **1**. Load it face down on the right front corner of the glass, and then press **OK**. If you do not have another page to fax, press **2**.

The HP all-in-one sends the fax.

### Send a fax using speed dials

You can quickly send a fax from the HP all-in-one using speed dials. You can send a black-and-white or color fax using speed dials; the following section provides instructions for sending the fax in black and white.

Speed dial entries will not appear until you have set them up. For more information, see [Set up speed dialing](#).

- 1 Load the first page face down on the right front corner of the glass.
- 2 Press **Fax**.  
The **Enter Fax Number** screen appears.
- 3 Press ▼ to access speed dials.
- 4 Press ▼ until the appropriate speed-dial entry appears.

**Note** You can also enter the speed-dial code by using the keypad on the control panel.

- 5 Press **OK** to select the speed-dial entry.
- 6 Press **Start Black**.
- 7 If the most recently sent black-and-white fax is stored in memory, the **Fax Mode** screen appears. Press **1** to send a new fax.
- 8 Press **Start Black**.
- 9 If you have another page to fax, when prompted, press **1**. Load the next page face down on the right front corner of the glass, and then press **OK**. If you do not have another page to fax, press **2**.

### Send a fax using monitor dialing

Monitor dialing allows you to dial a number from the control panel as you would dial a regular telephone. This feature is useful when you want to use a calling card to charge the call and you need to respond to tone prompts while dialing. It also allows you to dial the number at your own pace, if necessary.

You can send a black-and-white or color fax using monitor dialing; the following section provides instructions for sending the fax in black and white.

**Note** Make sure the volume is turned on, or you will not hear a dial tone. For information, see [Adjust the volume](#).

#### To send a fax using monitor dialing from the control panel

- 1 Load the first page face down on the right front corner of the glass.
- 2 Press **Fax**.  
The **Enter Fax Number** screen appears.
- 3 Press **Start Black**.

- 4 Press **Start Black** again.  
The HP all-in-one scans the page into memory.
- 5 If you have another page to fax, when prompted, press **1**. Load the next page face down on the right front corner of the glass, and then press **OK**. If you do not have another page to fax, press **2**.  
The **Enter Fax Number** screen appears.
- 6 Once you hear the dial tone, enter the number by using the keypad on the control panel.
- 7 Follow any prompts that might occur.  
Your fax is sent when the receiving fax machine answers.

## Receive a fax

Depending on the **Auto Answer** setting, your HP all-in-one can receive faxes automatically or manually. If you have set the **Auto Answer** option to **Off**, you will need to receive faxes manually. If the **Auto Answer** option is set to **On**, your HP all-in-one will automatically answer incoming calls and receive faxes. For more information on **Auto Answer**, see [Set up the HP all-in-one to receive faxes](#).

**Note** If you installed a photo or gray photo print cartridge for printing photos, you might want to replace it with the black print cartridge when receiving faxes. See [Work with print cartridges](#).

### Set the number of rings before answering

You can specify how many rings should occur before your HP all-in-one automatically answers the incoming call.

**Note** This setting only applies if **Auto Answer** is set to **On**.

The **Rings to Answer** setting is important if you have an answering machine on the same phone line as your HP all-in-one. You want the answering machine to answer the phone before the HP all-in-one. The number of rings to answer for the HP all-in-one should be greater than the number of rings to answer for the answering machine.

For example, set your answering machine to answer in 4 rings and your HP all-in-one to answer in the maximum number of rings supported by your device. (The maximum number of rings varies by country/region.) In this setup, the answering machine will answer the call and the HP all-in-one will monitor the line. If the HP all-in-one detects fax tones, the HP all-in-one will receive the fax. If the call is a voice call, the answering machine will record the incoming message.

### To set the number of rings before answering from the control panel

- 1 Press **Setup**.
- 2 Press **4**, and then press **4** again.  
This displays the **Basic Fax Setup** menu and then **Rings to Answer**.
- 3 Enter the appropriate number of rings by using the keypad.
- 4 Press **OK** to accept the setting.

## Receive a fax manually

If you set up your HP all-in-one to receive faxes manually (the **Auto Answer** option is set to **Off**) or you answer the phone and hear fax tones, use the instructions in this section to receive faxes.

You can receive faxes manually from a phone that is:

- Directly connected to the HP all-in-one (on the "2-EXT" port)
  - On the same phone line, but is not connected to the HP all-in-one
- 1 Make sure the HP all-in-one is turned on and you have paper loaded in the input tray.
  - 2 Remove any originals from the glass.
  - 3 Set the **Rings to Answer** setting to a high number to allow you to answer the incoming call before the HP all-in-one answers. Or, set the **Auto Answer** setting to **Off** so that the HP all-in-one does not automatically answer incoming calls.

For information on setting the number of **Rings to Answer**, see [Set the number of rings before answering](#). For information on setting **Auto Answer**, see [Set the answer mode](#).

- 4 Do one of the following:
  - If your phone is on the same phone line (but not plugged into the back of the HP all-in-one) and you hear fax tones from a sending fax machine, wait 5 - 10 seconds before pressing **1 2 3** on your phone. If the HP all-in-one does not begin receiving the fax, wait several more seconds and press **1 2 3** again.

**Note** When the HP all-in-one receives an incoming call, it displays **Ringling** on the color graphics display. If you pick up the phone, **Phone-Off Hook** appears after a few seconds. You must wait until this message appears before pressing **1 2 3** on your phone or you will not be able to receive the fax.

- If your phone is plugged directly into the back of the HP all-in-one and you hear fax tones from a sending fax machine, press the **Fax** button on the control panel. Press ▼ until **Receive Fax Manually** is highlighted, and then press **OK**. Press the **Start Black** or **Start Color** button on the control panel, and then hang up the telephone.
- If you are currently on the phone with the sender using a phone connected to the HP all-in-one, instruct them to press Start on their fax machine first. Once you hear fax tones from a sending fax machine, press the **Fax** button on the control panel. Press ▼ until **Receive Fax Manually** is highlighted, and then press **OK**. Press the **Start Black** or **Start Color** button on the control panel, and then hang up the telephone.

**Note** If you press **Start Color** but the sender sent the fax in black and white, the HP all-in-one prints the fax in black and white.

## Set the date and time

You can set the date and time from the control panel. When a fax is transmitted, the current date and time are printed along with the fax header. The date and time format is based on the language and country/region setting.

**Note** If your HP all-in-one loses power, you will need to reset the date and time.

- 1 Press **Setup**.
- 2 Press **4**, and then press **1**.  
This displays the **Basic Fax Setup** menu and then selects **Date and Time**.
- 3 Enter the month, day, and year by pressing the appropriate numbers on the keypad. Depending on your country/region setting, you might enter the date in a different order.  
The underline cursor is presented initially beneath the first digit; it automatically advances to the next digit when you press a button. The time prompt automatically appears after you enter the last digit of the date.
- 4 Enter the hours and minutes.  
If your time is displayed in the 12-hour format, the **AM or PM** prompt automatically appears after you enter the last digit.
- 5 If prompted, press **1** for AM, or **2** for PM.  
The new date and time settings appear on the color graphics display.

## Set the fax header

The fax header prints your name and fax number on the top of every fax you send. We recommend that you set up the fax header by using the **Fax Setup Wizard** (Windows users) or the **Setup Assistant** (Macintosh users) during the **HP Image Zone** software installation. You can also set up the fax header from the control panel.

The fax header information is required by law in many countries/regions.

- 1 Press **Setup**.
- 2 Press **4**, and then press **2**.  
This displays the **Basic Fax Setup** menu and then selects **Fax Header**.
- 3 Enter your personal or company name.  
For information on entering text from the control panel, see [Enter text and symbols](#).
- 4 When you are finished entering your personal or company name, select **Done** on the visual keyboard, and then press **OK**.
- 5 Enter your fax number by using the numeric keypad.
- 6 Press **OK**.

You might find it easier to enter fax header information by using the **HP Director** that came with your **HP Image Zone** software. In addition to entering fax header information, you can also enter cover page information that will be used when you send a fax from your computer and attach a cover page. For more information, see the onscreen **HP Image Zone Help** that came with your **HP Image Zone** software.

## Enter text and symbols

You can enter text and symbols from the control panel by using the visual keyboard that appears automatically on the color graphics display when setting up your fax header information or speed-dial entries. You can also use the keypad on the control panel to enter text and symbols.

You can also enter symbols from the keypad when you dial a fax or phone number. When the HP all-in-one dials the number, it will interpret the symbol and respond accordingly. For example, if you enter a dash in the fax number, the HP all-in-one will

pause before dialing the remainder of the number. A pause is useful if you need to access an outside line before dialing the fax number.

**Note** If you want to enter a symbol in your fax number, such as a dash, you will need to enter the symbol by using the keypad.

### Enter text using the visual keyboard

You can enter text or symbols by using the visual keyboard that automatically appears on the color graphics display when you need to enter text. For example, the visual keyboard automatically appears when you are setting up fax header information or speed-dial entries.

- To select a letter, number, or symbol in the visual keyboard, press ◀, ▶, ▲, and ▼ to highlight the appropriate selection.
- Once you have highlighted the appropriate letter, number, or symbol, press **OK** on the control panel to select it.  
The selection appears on the color graphics display.
- To enter lowercase letters, select the **abc** button on the visual keyboard, and then press **OK**.
- To enter uppercase letters, select the **ABC** button on the visual keyboard, and then press **OK**.
- To enter numbers and symbols, select the **123** button on the visual keyboard, and then press **OK**.
- To erase a letter, number, or symbol, select **Clear** on the visual keyboard, and then press **OK**.
- To add a space, press ▶ on the visual keyboard, and then press **OK**.

**Note** Make sure you use the ▶ on the visual keyboard to add a space. You will not be able to add a space by using the arrow buttons on the control panel.

- When you are finished entering text, numbers, or symbols, select **Done** on the visual keyboard, and then press **OK**.

### Enter text using the keypad on the control panel

You can also enter text or symbols by using the keypad on the control panel. Your selections will appear in the visual keyboard on the color graphics display.

- Press the keypad numbers that correspond to the letters of a name. For example, the letters a, b, and c correspond to the number 2, as shown on the button below.



- Press a button multiple times to see the available characters.

**Note** Depending on your language and country/region setting, additional characters might be available.

- After the correct letter appears, wait for the cursor to advance automatically to the right, or press ▶. Press the number that corresponds to the next letter in the name. Press the button multiple times until the correct letter appears. The first letter of a word is automatically set to uppercase.

**Tip** The cursor automatically advances to the right after a few seconds.

- To insert a space, press **Space (#)**.
- To enter a pause, press **Symbols (\*)**. A dash appears in the number sequence.
- To enter a symbol, such as @, press the **Symbols (\*)** button repeatedly to scroll through the list of available symbols: asterisk (\*), dash (-), ampersand (&), period (.), slash (/), parentheses ( ), apostrophe ('), equals (=), number sign (#), at (@), underscore (\_), plus (+), exclamation (!), semi colon (;), question (?), comma (,), colon (:), percent (%), and approximation (~).
- If you make a mistake, press an arrow button to select **Clear** on the visual keyboard, and then press **OK**.
- When you are finished entering text, numbers, or symbols, press an arrow button to select **Done** on the visual keyboard, and then press **OK**.

## Print reports

You can set up your HP all-in-one to print error reports automatically and confirmation reports for each fax you send and receive. You can also manually print system reports as you need them; these reports provide useful system information about your HP all-in-one.

By default, your HP all-in-one is set to print a report only if there is a problem with sending or receiving a fax. A confirmation message that indicates whether a fax was successfully sent appears briefly on the color graphics display after each transaction.

### Generate reports automatically

You can configure your HP all-in-one so that it automatically prints error and confirmation reports.

**Note** If you need printed confirmation each time a fax is sent, follow these instructions before sending any faxes and select **Send Only**.

- 1 Press **Setup**.
- 2 Press **2**, and then press **1**.  
This displays the **Print Report** menu and then selects **Fax Report Setup**.
- 3 Press ▼ to scroll through the following report types:
  - **1. Every Error**: prints whenever there is any kind of fax error (default).
  - **2. Send Error**: prints whenever there is a transmission error.
  - **3. Receive Error**: prints whenever there is a receiving error.
  - **4. Every Fax**: confirms every time a fax is sent or received.
  - **5. Send Only**: prints every time a fax is sent indicating whether the fax was successful or not.
  - **6. Off**: does not print any error or confirmation reports.
- 4 After the report that you want is highlighted, press **OK**.

### Generate reports manually

You can manually generate reports about your HP all-in-one, such as the status of the last fax you sent, a list of programmed speed-dial entries, or a self-test report for diagnostic purposes.

- 1 Press **Setup**, and then press **2**.

- This displays the **Print Report** menu.
- 2 Press **▼** to scroll through the following report types:
    - 1. **Fax Report Setup**: prints the automatic fax reports as described in [Generate reports automatically](#).
    - 2. **Last Transaction**: prints details of the last fax transaction.
    - 3. **Fax Log**: prints a log of approximately the last 30 fax transactions.
    - 4. **Speed Dial List**: prints a list of programmed speed-dial entries.
    - 5. **Self-Test Report**: prints a report to assist you in diagnosing print and alignment problems. For more information, see [Print a self-test report](#).
  - 3 After the report that you want is highlighted, press **OK**.

## Set up speed dialing

You can assign speed-dial entries to fax numbers you use often. This lets you dial those numbers quickly by using the control panel.

For information on sending a fax using speed dials, see [Send a fax using speed dials](#).

You can quickly and easily set up speed-dial entries from your computer by using the **HP Director** that came with your **HP Image Zone** software. For more information, see the onscreen **HP Image Zone Help** that came with your **HP Image Zone** software.

### Create speed-dial entries

You can create speed-dial entries for fax numbers that you use frequently.

- 1 Press **Setup**.
- 2 Press **3**, and then press **1**.  
This displays the **Speed Dial Setup** menu and then selects **Individual Speed Dial**. The first unassigned speed-dial entry appears on the color graphics display.
- 3 Press **OK** to select the displayed speed-dial entry. You can also press **▼** or **▲** to select a another empty entry, and then press **OK**.
- 4 Enter the fax number to assign to that entry, and then press **OK**.

**Tip** To enter a pause within a number sequence, press the **Space (#)** button repeatedly, until a dash appears on the color graphics display.

The visual keyboard automatically appears on the color graphics display.

- 5 Enter the name. After you have finished entering the name, select **Done** on the visual keyboard, and then press **OK**.  
For more information on entering text using the visual keyboard, see [Enter text and symbols](#).
- 6 Press **1** if you want to set up another number, or press **Cancel** to exit the **Speed Dial Setup** menu.

### Update speed-dial entries

You can change the phone number or name of an individual speed-dial entry.

- 1 Press **Setup**.
- 2 Press **3**, and then press **1**.  
This displays the **Speed Dial Setup** menu and then selects **Individual Speed Dial**.
- 3 Press **▼** or **▲** to scroll through the speed-dial entries, and then press **OK** to select the appropriate entry.

- 4 When the current fax number appears, press ◀ to erase it.
- 5 Enter the new fax number.
- 6 Press **OK** to save the new number.  
The visual keyboard automatically appears on the color graphics display.
- 7 Use the visual keyboard to change the name.  
For more information on using the visual keyboard, see [Enter text and symbols](#).
- 8 Press **OK**.
- 9 Press **1** to update another speed-dial entry, or press **Cancel** to exit.

## Delete speed-dial entries

You can delete an individual or group speed-dial entry.

- 1 Press **Setup**.
- 2 Press **3**, and then press **2**.  
This displays the **Speed Dial Setup** menu and then selects **Delete Speed Dial**.
- 3 Press ▼ or ▲ until the speed-dial entry that you want to delete appears, and then press **OK** to delete it. You can also enter the speed-dial code by using the keypad on the control panel.
- 4 Press **1** to delete another speed-dial entry, or press **Cancel** to exit.

## Change the fax resolution and lighter/darker settings

You can change the fax **Resolution** and **Lighter/Darker** settings for documents that you are faxing.

### Change the fax resolution

The **Resolution** setting affects the transmission speed and quality of faxed black-and-white documents. The HP all-in-one sends faxes at the highest resolution supported by the receiving fax machine. You can only change the resolution for faxes that you are sending in black and white. All color faxes will be sent using **Fine** resolution. The following resolution settings are available:

- **Fine**: provides high-quality text suitable for faxing most documents. This is the default setting.
- **Photo**: provides the best quality fax when sending photographs. If you choose **Photo**, be aware that the faxing process takes longer to complete. When faxing photographs, we recommend that you choose **Photo**.
- **Standard**: provides the fastest possible fax transmission with the lowest quality.

This setting returns to the default setting five minutes after the job has been completed, unless you set your changes as the default. For information, see [Set new default settings](#).

### To change the resolution from the control panel

- 1 Load the first page face down on the right front corner of the glass.
- 2 Press **Fax**.  
This displays the **Enter Fax Number** screen.
- 3 Enter the fax number by using the keypad.
- 4 Press **Fax** again, and then press **1**.  
This displays the **Fax Menu** and then selects **Resolution**.
- 5 Press ▼ to select a resolution setting, and then press **OK**.
- 6 Press **Start Black**.



**Note** If you press **Start Color**, the fax will be sent using the **Fine** setting.

- 7 If the most recently sent black-and-white fax is stored in memory, the **Fax Mode** screen appears. Press **1** to send a new fax.
- 8 Press **Start Black**.
- 9 If you have another page to fax, when prompted, press **1**. Load the next face down on the right front corner of the glass, and then press **OK**. If you do not have another page to fax, press **2**.

### Change the lighter/darker setting

You can change the contrast of a fax to be darker or lighter than the original. This feature is useful if you are faxing a document that is faded, washed out, or handwritten. You can darken the original by adjusting the contrast.

This setting returns to the default setting five minutes after the job has been completed, unless you set your changes as the default. For information, see [Set new default settings](#).

- 1 Load the first page face down on the right front corner of the glass.
- 2 Press **Fax**.  
This displays the **Enter Fax Number** screen.
- 3 Enter the fax number by using the keypad.
- 4 Press **Fax** again, and then press **2**.  
This displays the **Fax Menu** and then selects **Lighter/Darker** menu.
- 5 Press **◀** to lighten the fax or press **▶** to darken it.  
The indicator moves to the left or right as you press an arrow.
- 6 Press **Start Black**.
- 7 If the most recently sent black-and-white fax is stored in memory, the **Fax Mode** screen appears. Press **1** to send a new fax.
- 8 Press **Start Black**.
- 9 If you have another page to fax, when prompted, press **1**. Load the next face down on the right front corner of the glass, and then press **OK**. If you do not have another page to fax, press **2**.

### Set new default settings

You can change the default value for the **Resolution** and **Lighter/Darker** setting through the control panel.

- 1 Make your changes to **Resolution** and **Lighter/Darker**.
- 2 If you are not already in the **Fax Menu**, press **Fax** twice.  
This selects the **Fax Menu**.
- 3 Press **3**.  
This selects **Set New Defaults**.
- 4 Press **OK**.

## Set fax options

There are numerous fax options that you can set, such as controlling whether the HP all-in-one redials a busy number automatically. When you make changes to the following options, the new setting becomes the default. Review this section for information on changing fax options.

## Set the paper size for received faxes

You can select the paper size for received faxes. The paper size you select should match what is loaded in your input tray. Faxes can be printed on letter, A4, or legal paper only.

**Note** If an incorrect paper size is loaded in the input tray when a fax is received, the fax does not print and an error message appears on the color graphics display. Load letter, A4, or legal paper, and then press **OK** to print the fax.

- 1 Press **Setup**.
- 2 Press **4**, and then press **5**.  
This displays the **Basic Fax Setup** menu and then selects **Fax Paper Size**.
- 3 Press **▼** to highlight an option, and then press **OK**.

## Set tone or pulse dialing

You can set the dial mode for your HP all-in-one to either tone dialing or pulse dialing. Most telephone systems work with either type of dialing. If your telephone system does not require pulse dialing, we recommend using tone dialing. If you have a public telephone system or a private branch exchange (PBX) system, you may need to select **Pulse Dialing**. Contact your local telephone company if you are unsure which setting to use.

**Note** If you select **Pulse Dialing**, some phone system features might not be available. It can also take longer to dial a fax or phone number.

- 1 Press **Setup**.
- 2 Press **4**, and then press **6**.  
This displays the **Basic Fax Setup** menu and then selects **Tone or Pulse Dialing**.
- 3 Press **▼** to highlight an option, and then press **OK**.

## Adjust the volume

Your HP all-in-one provides three levels for adjusting the ring and speaker volume. The ring volume is the volume of the phone rings. The speaker volume is the level of everything else, such as the dial tones, fax tones, and button press beeps. The default setting is **Soft**.

- 1 Press **Setup**.
- 2 Press **4**, and then press **7**.  
This displays the **Basic Fax Setup** menu and then selects **Ring and Beep Volume**.
- 3 Press **▼** to select one of the options: **Soft**, **Loud**, or **Off**.

**Note** If you select **Off**, you will not hear a dial tone, fax tones, or incoming ring tones.

- 4 Press **OK**.

## Change the answer ring pattern (distinctive ringing)

Many phone companies offer a distinctive ringing feature that allows you to have several phone numbers on one phone line. When you subscribe to this service, each number will have a different ring pattern. For example, you can have single, double, and

triple rings for the different numbers. You can set up your HP all-in-one to answer incoming calls that have a specific ring pattern.

If you connect your HP all-in-one to a line with distinctive ringing, have your telephone company assign one ring pattern to voice calls and another ring pattern to fax calls. We recommend that you request double or triple rings for a fax number. When the HP all-in-one detects the specified ring pattern, it will answer the call and receive the fax.

For example, you might have your telephone company assign double rings to your fax number and a single ring to your voice number. In this setup, set the **Answer Ring Pattern** for your HP all-in-one to **Double Rings**. You can also set the **Rings to Answer** setting to **3**. When a call comes in with a double ring, the HP all-in-one answers it after three rings and receives the fax.

If you do not have this service, use the default ring pattern, which is **All Rings**.

### To change the answer ring pattern from the control panel

- 1 Verify that your HP all-in-one is set to answer fax calls automatically. For information, see [Set up the HP all-in-one to receive faxes](#).
- 2 Press **Setup**.
- 3 Press **5**, and then press **1**.  
This displays the **Advanced Fax Setup** menu and then selects **Answer Ring Pattern**.
- 4 Press **▼** to highlight an option, and then press **OK**.

When the phone rings with the ring pattern assigned to your fax line, the HP all-in-one answers the call and receives the fax.

### Redial a busy or unanswered number automatically

You can set your HP all-in-one to redial a busy or an unanswered number automatically. The default setting for **Busy Redial** is **Redial**. The default setting for **No Answer Redial** is **No Redial**.

- 1 Press **Setup**.
- 2 Do one of the following:
  - To change the **Busy Redial** setting, press **5**, and then press **2**.  
This displays the **Advanced Fax Setup** menu and then selects **Busy Redial**.
  - To change the **No Answer Redial** setting press **5**, and then press **3**.  
This displays the **Advanced Fax Setup** menu and then selects **No Answer Redial**.
- 3 Press **▼** to select **Redial** or **No Redial**.
- 4 Press **OK**.

### Set automatic reduction for incoming faxes

This setting determines what your HP all-in-one does if it receives a fax that is too large for the default paper size. With this setting turned on (the default), the image of the incoming fax is reduced so that it fits on one page, if possible. With this feature turned off, information that does not fit on the first page is printed on a second page.

**Automatic Reduction** is useful when you receive a legal-size fax and letter-size paper is loaded in the input tray.

- 1 Press **Setup**.
- 2 Press **5**, and then press **4**.

This displays the **Advanced Fax Setup** menu and then selects **Automatic Reduction**.

- 3 Press ▼ to select **Off** or **On**.
- 4 Press **OK**.

## Set backup fax reception

The HP all-in-one stores all received faxes in memory. If there is an error condition that prevents the HP all-in-one from printing the faxes, **Backup Fax Reception** allows you to continue receiving faxes. During the error condition, with **Backup Fax Reception** enabled, the faxes are stored in memory.

For example, if the HP all-in-one is out of paper and **Backup Fax Reception** is enabled, all received faxes are stored in memory. After you load more paper, you can print the faxes. If you disable this feature, the HP all-in-one will not answer incoming fax calls until the error condition is resolved.

Error conditions, such as the following, may prevent the HP all-in-one from printing faxes:

- There is no paper loaded in the input tray
- There is a paper jam
- The print-carriage access door is open
- The print carriage is stalled

During normal operation (whether **Backup Fax Reception** is **On** or **Off**), the HP all-in-one stores all faxes in memory. After the memory becomes full, the HP all-in-one overwrites the oldest, printed faxes as it receives new faxes. If you want to delete all the faxes in memory, turn off the HP all-in-one by pressing the **On** button.

**Note** If **Backup Fax Reception** is **On** and there is an error condition, the HP all-in-one stores the faxes it receives in memory as "unprinted." All unprinted faxes remain in memory until they are printed or deleted. When the memory becomes full of unprinted faxes, the HP all-in-one will not receive any more fax calls until the unprinted faxes are printed or deleted from memory. For information on printing or deleting faxes from memory, see [Reprint or delete the faxes in memory](#).

The default **Backup Fax Reception** setting is **On**.

### To set backup fax reception from the control panel

- 1 Press **Setup**.
- 2 Press **5**, and then press **5** again.  
This displays the **Advanced Fax Setup** menu and then selects **Backup Fax Reception**.
- 3 Press ▼ to select **On** or **Off**.
- 4 Press **OK**.

## Use error correction mode

**Error Correction Mode (ECM)** eliminates data that is lost due to poor phone lines by detecting errors that occur during transmission and automatically requesting retransmission of the erroneous portion. Phone charges are unaffected, or might even be reduced, on good phone lines. On poor phone lines, ECM increases sending time and phone charges, but sends the data much more reliably. The default setting is on.

Turn ECM off only if it increases phone charges substantially, and you can accept poorer quality in exchange for reduced charges.

The following rules apply to ECM:

- If you turn ECM off, this applies only to faxes that you send. This does not apply to faxes that you receive.
- If you turn ECM off, set the **Fax Speed** to **Medium**. If the **Fax Speed** is set to **Fast**, the fax will automatically be sent with ECM on. For information on changing the **Fax Speed**, see [Set the fax speed](#).
- If you send a fax in color, the fax will be sent with ECM on, regardless of the option currently set.

### To change the ECM setting from the control panel

- 1 Press **Setup**.
- 2 Press **5**, and then press **6**.  
This displays the **Advanced Fax Setup** menu and then selects **Error Correction Mode**.
- 3 Press **▼** to select **Off** or **On**.
- 4 Press **OK**.

### Set the fax speed

You can set the fax speed used to communicate between your HP all-in-one and other fax machines when sending and receiving faxes. The default fax speed is **Fast**.

If you use one of the following, setting the fax speed to a slower speed might be required:

- An Internet phone service
- A PBX system
- Fax over Internet Protocol (FoIP)
- An integrated services digital network (ISDN) service

If you experience problems sending and receiving faxes, you might want to try setting the **Fax Speed** setting to **Medium** or **Slow**. The following table provides the available fax speed settings.

Fax speed setting	Fax speed
Fast	v.34 (33600 baud)
Medium	v.17 (14400 baud)
Slow	v.29 (9600 baud)

### To set the fax speed from the control panel

- 1 Press **Setup**.
- 2 Press **5**, and then press **7**.  
This displays the **Advanced Fax Setup** menu and then selects **Fax Speed**.
- 3 Press **▼** to select an option, and then press **OK**.

## Reprint or delete the faxes in memory

You can reprint or delete the faxes stored in memory. You might need to reprint a fax in memory if your HP all-in-one runs out of paper while receiving a fax. Or, if the memory of the HP all-in-one becomes full, you might need to clear it in order to continue receiving faxes.

**Note** The HP all-in-one stores all faxes it receives in memory, even when the faxes are printed. This allows you to reprint the faxes later, if needed. After the memory becomes full, the HP all-in-one overwrites the oldest, printed faxes as it receives new faxes.

### To reprint faxes in memory from the control panel

- 1 Make sure you have paper loaded in the input tray.
- 2 Press **Setup**.
- 3 Press **6**, and then press **4**.  
This displays the **Tools** menu and then selects **Reprint Faxes in Memory**. The faxes are printed in the reverse order they were received with the most recently received fax printed first, and so on.
- 4 If you do not need a fax that is printing, press **Cancel**.  
The HP all-in-one begins printing the next fax in memory.

**Note** You will need to press **Cancel** for each stored fax in order to stop it from printing.

### To delete all the faxes in memory from the control panel

- To delete all the faxes from memory, turn off the HP all-in-one by pressing the **On** button.

All faxes stored in memory will be deleted from memory after you turn off the power to your HP all-in-one.

## Fax over the Internet

You may subscribe to a low cost phone service that allows you to send and receive faxes with your HP all-in-one by using the Internet. This method is called Fax over Internet Protocol (FoIP). You probably use a FoIP service (provided by your telephone company) if you:

- Dial a special access code along with the fax number, or
- Have an IP converter box that connects to the Internet and provides analog phone ports for the fax connection.

**Note** You can only send and receive faxes by connecting a phone cord to the port labeled "1-LINE" on the HP all-in-one and not from the Ethernet port. This means that your connection to the Internet must be done either through a converter box (which supplies regular analog phone jacks for fax connections) or your telephone company.

The FoIP service might not work properly when the HP all-in-one is sending and receiving faxes at high speed (33600bps). If you experience problems sending and receiving faxes, use a slower fax speed. You can do this by changing the **Fax Speed**

setting from **High** (the default) to **Medium**. For information on changing this setting, see [Set the fax speed](#).

You should also check with your telephone company to make sure their Internet phone service supports faxing. If they do not support faxing, you will not be able to send and receive faxes through the Internet.

## Stop faxing

You can cancel a fax you are sending or receiving at any time.

### To stop faxing from the control panel

- Press **Cancel** on the control panel to stop a fax you are sending or receiving. Look for the **Fax Cancelled** message on the color graphics display. If it does not appear, press **Cancel** again.

The HP all-in-one prints any pages it has already started printing and then cancels the remainder of the fax. This can take a few moments.

### To cancel a number you are dialing

- Press **Cancel** to cancel a number you are currently dialing.

# 12 Use HP Instant Share (USB)

HP Instant Share makes it easy to share photos with family and friends. Just scan a photo or insert a memory card into the appropriate card slot on your HP all-in-one, select one or more photos to share, select a destination for your photos, and then send the photos on their way. You can even upload your photos to an online photo album or an online photo finishing service. Availability of services varies by country/region.

With **HP Instant Share E-mail**, family and friends always get photos they can view -- no more large downloads or images that are too big to open. An e-mail message with thumbnail images of your photos is sent with a link to a secure Web page where family and friends can easily view, share, print, and save the photos.

**Note** If your HP all-in-one is connected to a network and is set up with HP Instant Share, use the information contained in [Use HP Instant Share \(networked\)](#). The information contained in this chapter only pertains to a device that is connected to a computer with a USB cable and has not been previously connected to a network or set up with HP Instant Share.

## Overview

If your HP all-in-one is USB-connected, you can share photos with friends and relatives using your device and the HP software installed on your computer. If you have a Windows-based computer, use the **HP Image Zone** software; if you have a Macintosh, use the **HP Instant Share** client application software.

**Note** A USB-connected device is an HP All-in-One that is connected to a computer by means of a USB cable and relies on the computer for access to the Internet.

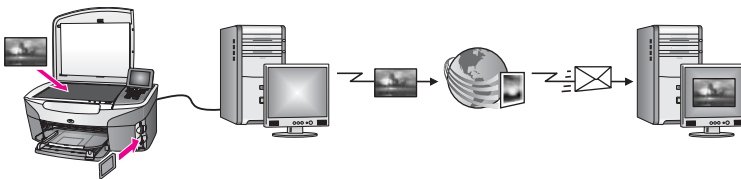

Use HP Instant Share to send images from your HP all-in-one to a destination of your choice. The destination, for example, can be an e-mail address, an online photo album, or an online photo finishing service. Availability of services varies by country/region.

**Note** You can also send images to a friend or relative's network-connected HP All-in-One or photo printer. To send to a device, you must have an HP Passport user ID and password. The receiving device must be set up and registered with HP Instant Share. You will also need to obtain the name the recipient assigned to the receiving device. Further instructions are provided in step 5 in [Send images using your HP all-in-one](#).



## Get started

You must have the following to use HP Instant Share with your HP all-in-one:

- An HP all-in-one connected to a computer with a USB cable
- Internet access through the computer to which the HP all-in-one is connected
- Based on your operating system:
  - Windows: **HP Image Zone** software installed on your computer
  - Macintosh: **HP Image Zone** software installed on your computer, including the **HP Instant Share** client application software

For more information, see the Setup Guide that came with your device.

Once you have set up your HP all-in-one and installed the **HP Image Zone** software, you are ready to start sharing photos using HP Instant Share.

## Send images using your HP all-in-one

Images can be photos or scanned documents. Either can be shared with friends and relatives using your HP all-in-one and HP Instant Share. Select photos from a memory card or scan an image, press **HP Instant Share** on the control panel of your HP all-in-one, and send your images to the destination of your choice. See the topics below for detailed instructions.

### Send photos from a memory card

Use your HP all-in-one to share photos immediately upon inserting a memory card, or insert the memory card and share photos at a later time. To share photos immediately, insert the memory card into the appropriate card slot, select one or more photos, and then press **HP Instant Share** on the control panel.

If you insert the memory card, and then decide to send the photos at a later time, you will find that when you come back to your HP all-in-one it has gone into idle mode. Simply press **HP Instant Share** and follow the prompts to select and share photos.

**Note** For more information on using a memory card, see [Use a memory card or PictBridge camera](#).

### To send photos immediately upon inserting your memory card

- 1 Make sure the memory card is inserted into the appropriate card slot on your HP all-in-one.
- 2 Select one or more photos.  
For more information on selecting photos, see [Use a memory card or PictBridge camera](#).

**Note** Movie file types might not be supported by the HP Instant Share service.

- 3 Press **HP Instant Share** on the control panel of your HP all-in-one.  
For Windows users, the **HP Image Zone** software opens on your computer. The **HP Instant Share** tab appears. Thumbnails of your photos appear in the Selection Tray. For more information on the **HP Image Zone**, see [Use the HP Image Zone](#) in the onscreen help.  
For Macintosh users, the **HP Instant Share** client application software opens on your computer. Thumbnails of your photos appear in the **HP Instant Share** window.

**Note** If you are using a Macintosh OS earlier than X v10.1.5 (including OS 9 v9.1.5), your photos are uploaded to the **HP Gallery** on your Macintosh. Click **E-mail**. Send the photos as an e-mail attachment by following the prompts on your computer screen.

- 4 Follow the steps appropriate for your operating system:

**If you are using a Windows-based computer:**

- a From either the **Control** or **Work** areas of the **HP Instant Share** tab, click the link or icon of the service you want to use to send your photos.

**Note** If you click **See All Services**, you can choose from among all of the services available in your country/region, for example: **HP Instant Share E-mail** and **Create Online Albums**. Follow the onscreen instructions.

The **Go Online** screen appears in the Work area.

- b Click **Next** and follow the onscreen instructions.

**If you are using a Macintosh:**

- a Make sure the photos you want to share display in the **HP Instant Share** window.  
Use the - button to remove photos, or the + button to add photos to the window.
- b Click **Continue** and follow the onscreen instructions.
- c From the HP Instant Share services list, select the service you want to use to send your photos.
- d Follow the onscreen instructions.

- 5 From the **HP Instant Share E-mail** service, you can:

- Send an e-mail message with thumbnail images of your photos which can be viewed, printed, and saved over the Web.
- Open and maintain an e-mail address book. Click **Address Book**, register with HP Instant Share, and create an HP Passport account.
- Send your e-mail message to multiple addresses. Click the multiple address link.
- Send a collection of images to a friend or relative's network-connected device. Enter the name assigned to the device by the recipient in the **E-mail address** field followed by @send.hp.com. You will be prompted to sign in to HP Instant Share with your HP Passport **userid** and **password**.

**Note** If you have not previously set up HP Instant Share, click **I need an HP Passport account** on the **Sign in with HP Passport** screen. Obtain an HP Passport user ID and password.

**Note** You can also use the **Photo** button to send images from your memory card. For more information, see [Use a memory card or PictBridge camera](#).

**To insert the memory card and send photos at a later time**

- 1 Insert the memory card into the appropriate slot on your HP all-in-one. After a period of time, the HP all-in-one will go into idle mode. The HP all-in-one is in idle mode when the idle screen appears on the color graphics display.
- 2 Press **HP Instant Share** on the control panel of your HP all-in-one. The **Send from Where?** menu appears on the color graphics display.

- 3 Press **1** to select **Memory card**.  
The first photo on your memory card appears on the color graphics display.
- 4 Select one or more photos.  
  
**Note** For more information on selecting photos, see [Use a memory card or PictBridge camera](#).
- 5 Follow the steps (starting with step 3) in [To send photos immediately upon inserting your memory card](#).

### Send a scanned image

Share a scanned image by pressing **HP Instant Share** on the control panel. To use the **HP Instant Share** button, place the image on the glass, select the scanner as the means by which you are going to send the image, select a destination, and start the scan.

**Note** For more information on scanning an image, see [Use the scan features](#).

#### To send a scanned image from your HP all-in-one

- 1 Load your original face down on the right front corner of the glass.
- 2 Press **HP Instant Share** on the control panel of your HP all-in-one.  
The **Send from Where?** menu appears on the color graphics display.
- 3 Press **2** to select **Scanner**.  
The image is scanned and uploaded to your computer.  
For Windows users, the **HP Image Zone** software opens on your computer. The **HP Instant Share** tab appears. A thumbnail of the scanned image appears in the Selection Tray. For more information on the **HP Image Zone**, see [Use the HP Image Zone](#) in the onscreen help.  
For Macintosh users, the **HP Instant Share** client application software opens on your computer. A thumbnail of the scanned image appears in the **HP Instant Share** window.

**Note** If you are using a Macintosh OS earlier than X v10.1.5 (including OS 9 v9.1.5), your photos are uploaded to the **HP Gallery** on your Macintosh. Click **E-mail**. Send the scanned image as an e-mail attachment by following the prompts on your computer screen.

- 4 Follow the steps appropriate for your operating system:

#### If you are using a Windows-based computer:

- a From either the **Control** or **Work** areas of the **HP Instant Share** tab, click the link or icon of the service you want to use to send your scanned image.

**Note** If you click **See All Services**, you can choose from among all of the services available in your country/region, for example: **HP Instant Share E-mail** and **Create Online Albums**. Follow the onscreen instructions.

The **Go Online** screen appears in the Work area.

- b Click **Next** and follow the onscreen instructions.

### If you are using a Macintosh:

- a Make sure the scanned image you want to share displays in the **HP Instant Share** window.  
Use the **-** button to remove photos, or the **+** button to add photos to the window.
  - b Click **Continue** and follow the onscreen instructions.
  - c From the HP Instant Share services list, select the service you want to use to send your scanned image.
  - d Follow the onscreen instructions.
- 5 From the **HP Instant Share E-mail** service, you can:
- Send an e-mail message with thumbnail images of your photos which can be viewed, printed, and saved over the Web.
  - Open and maintain an e-mail address book. Click **Address Book**, register with HP Instant Share, and create an HP Passport account.
  - Send your e-mail message to multiple addresses. Click the multiple address link.
  - Send a collection of images to a friend or relative's network-connected device. Enter the name assigned to the device by the recipient in the **E-mail address** field followed by **@send.hp.com**. You will be prompted to sign in to HP Instant Share with your HP Passport **userid** and **password**.

**Note** If you have not previously set up HP Instant Share, click **I need an HP Passport account** on the **Sign in with HP Passport** screen. Obtain an HP Passport user ID and password.

**Note** You can also use the **Scan** button to send a scanned image. For more information, see [Use the scan features](#).

## Send images using your computer

In addition to using your HP all-in-one to send images through HP Instant Share, you can use the **HP Image Zone** software installed on your computer to send images. The **HP Image Zone** software lets you select and edit one or more images, and then access HP Instant Share to select a service (for example, **HP Instant Share E-mail**) and send your images. At a minimum, you can share images through the following:

- HP Instant Share E-mail (send to an e-mail address)
- HP Instant Share E-mail (send to a device)
- Online Albums
- Online photo finishing (availability varies by country/region)

### Send images using the HP Image Zone software (Windows)

Use the **HP Image Zone** software to share images with friends and relatives. Simply open the **HP Image Zone**, select the images you want to share, and forward the images using the **HP Instant Share E-mail** service.

**Note** For more information on using the **HP Image Zone** software, see the onscreen **HP Image Zone Help**.

#### To use the HP Image Zone software

- 1 Double-click the **HP Image Zone** icon on your desktop.

The **HP Image Zone** window opens on your computer. The **My Images** tab appears in the window.

- 2 Select one or more images from the folder(s) in which they are stored. For more information, see the onscreen **HP Image Zone Help**.

**Note** Use the **HP Image Zone** image editing tools to edit your images and achieve the results you want. For more information, see the onscreen **HP Image Zone Help**.

- 3 Click the **HP Instant Share** tab.  
The **HP Instant Share** tab appears in the **HP Image Zone** window.
- 4 From either the **Control** or **Work** areas of the **HP Instant Share** tab, click the link or icon of the service you want to use to send your scanned image.

**Note** If you click **See All Services**, you can choose from among all of the services available in your country/region -- for example, **HP Instant Share E-mail** and **Create Online Albums**. Follow the onscreen instructions.

The **Go Online** screen appears in the **Work** area of the **HP Instant Share** tab.

- 5 Click **Next** and follow the onscreen instructions.
- 6 From the **HP Instant Share E-mail** service, you can:
  - Send an e-mail message with thumbnail images of your photos which can be viewed, printed, and saved over the Web.
  - Open and maintain an e-mail address book. Click **Address Book**, register with HP Instant Share, and create an HP Passport account.
  - Send your e-mail message to multiple addresses. Click the multiple address link.
  - Send a collection of images to a friend or relative's network-connected device. Enter the name assigned to the device by the recipient in the **E-mail address** field followed by @send.hp.com. You will be prompted to sign in to HP Instant Share with your HP Passport **userid** and **password**.

**Note** If you have not previously set up HP Instant Share, click **I need an HP Passport account** on the **Sign in with HP Passport** screen. Obtain an HP Passport user ID and password.

## Send images using the HP Instant Share client application software (Macintosh OS X v10.1.5 and later)

**Note** Macintosh OS X v10.2.1 and v10.2.2 are **not** supported.

Use the HP Instant Share client application to share images with friends and relatives. Simply open the HP Instant Share window, select the images you want to share, and forward the images using the **HP Instant Share E-mail** service.

**Note** For more information on using the **HP Instant Share** client application software, see the onscreen **HP Image Zone Help**.

### To use the HP Instant Share client application

- 1 Select the **HP Image Zone** icon from the Dock.  
The **HP Image Zone** opens on your desktop.
- 2 In the **HP Image Zone**, click the **Services** button at the top of the window. A list of applications appears in the lower part of the **HP Image Zone**.

- 3 Choose **HP Instant Share** from the list of applications.  
The **HP Instant Share** client application software opens on your computer.
- 4 Use the **+** button to add an image to the window, or the **-** button to remove an image.

**Note** For more information on using the **HP Instant Share** client application software, see the onscreen **HP Image Zone Help**.

- 5 Make sure the images you want to share display in the **HP Instant Share** window.
- 6 Click **Continue** and follow the onscreen instructions.
- 7 From the HP Instant Share services list, select the service you want to use to send your scanned image.
- 8 Follow the onscreen instructions.
- 9 From the **HP Instant Share E-mail** service, you can:
  - Send an e-mail message with thumbnail images of your photos which can be viewed, printed, and saved over the Web.
  - Open and maintain an e-mail address book. Click **Address Book**, register with HP Instant Share, and create an HP Passport account.
  - Send your e-mail message to multiple addresses. Click the multiple address link.
  - Send a collection of images to a friend or relative's network-connected device. Enter the name assigned to the device by the recipient in the **E-mail address** field followed by **@send.hp.com**. You will be prompted to sign in to HP Instant Share with your HP Passport **userid** and **password**.

**Note** If you have not previously set up HP Instant Share, click **I need an HP Passport account** on the **Sign in with HP Passport** screen. Obtain an HP Passport user ID and password.

### Share images using the HP Director (Macintosh OS earlier than X v10.1.5)

**Note** Macintosh OS 9 v9.1.5 and later and v9.2.6 and later **are** supported. Macintosh OS X v10.0 and v10.0.4 are **not** supported.

Share images with anyone who has an e-mail account. Simply start the **HP Director** and open the **HP Gallery**. Then create a new e-mail message using an e-mail application installed on your computer.

**Note** For more information, see the HP Imaging Gallery section in the onscreen **HP Photo and Imaging Help**.

#### To use the e-mail option within the HP Director

- 1 Display the **HP Director** menu:
  - In OS X, select the **HP Director** icon from the Dock.
  - In OS 9, double-click the **HP Director** shortcut on your desktop.
- 2 Open the **HP Photo and Imaging Gallery**:
  - In OS X, select **HP Gallery** from the **Manage and Share** section of the **HP Director** menu.
  - In OS 9, click **HP Gallery**.
- 3 Select one or more images to share.

- 4 For more information, see the onscreen **HP Photo and Imaging Help**.  
Click **E-mail**.  
The e-mail program on your Macintosh opens.  
Share the images as an e-mail attachment by following the prompts on your computer screen.

# 13 Use HP Instant Share (networked)

HP Instant Share makes it easy to share photos with family and friends. Just scan a photo or insert a memory card into the appropriate card slot on your HP all-in-one, select one or more photos to share, select a destination for your photos, and then send the photos on their way. You can even upload your photos to an online photo album or an online photo finishing service. Availability of services varies by country/region.

## Overview

If your HP all-in-one is connected to a network and has direct Internet access (that is, it does not rely on your computer for an Internet connection), you have full access to the HP Instant Share features offered through your device. These features include the ability to send and receive images, as well as remote print to your HP all-in-one. A description of each feature follows.

**Note** Images can be photos or scanned text. Either can be shared with friends and relatives using your HP all-in-one and HP Instant Share.

### HP Instant Share Send

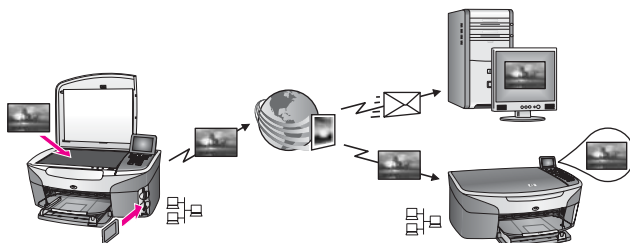

HP Instant Share Send lets you send images from your HP all-in-one to a destination of your choice by means of the HP Instant Share service. (You can also send images from the **HP Image Zone** software installed on your computer.) The destination you set up can be an e-mail address, a friend or relative's network-connected device, an online photo album, or an online photo finishing service. Availability of services varies by country/region. For more information, see [Send images directly from your HP all-in-one](#).

**Note** A network-connected device is an HP All-in-One that offers HP Instant Share and accesses the Internet through a home network or other configuration that does not require a computer for access. If a device is network-connected and connected to a computer through a USB cable, the network connection has preeminence.

The symbol for network connectivity is .



## HP Instant Share Receive

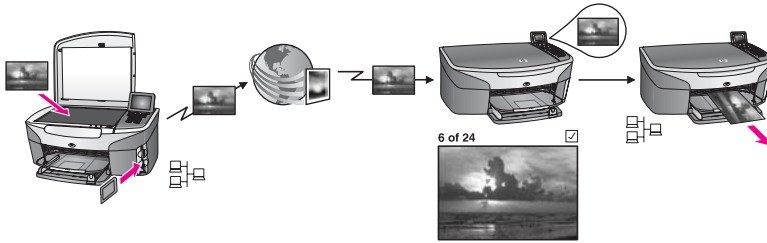

HP Instant Share Receive lets you receive images from any friend or relative who has accessed the HP Instant Share service and obtained an HP Passport user ID and password.

### Receive images from any sender or a specified group of senders

You can receive images from any sender with an HP Passport account (Open mode) or a specified group of senders (Private mode).

- If you choose to receive from any sender, simply provide the name of your HP all-in-one to those senders from whom you want to receive images. You assign a name to your device when you set up your HP all-in-one with HP Instant Share. The device name is not case sensitive.  
Open mode (receive from any sender) is the default receive mode. For more information on receiving in Open mode, see [Receive from any sender \(Open mode\)](#).  
You can also choose to block specific individuals from sending to your HP all-in-one through the HP Instant Share access list. For more information on using the access list, see the HP Instant Share service onscreen Help.
- If you choose to receive from a specified group of senders, add each sender from whom you wish to receive images to the HP Instant Share access list; then assign each sender access privileges. For more information on assigning access privileges, see the HP Instant Share service onscreen Help.

### Preview or automatically print received images

HP Instant Share gives you the option to preview an image collection prior to printing or allow collections to print automatically to your HP all-in-one. Auto print privileges are enabled on a sender by sender basis from the HP Instant Share access list.

Only image collections from those senders to whom you assign auto print privileges will automatically print to your device. All other collections will be received in preview mode.

**Note** For more information on HP Instant Share Receive, see [Receive images](#).

## HP remote printing



HP remote printing lets you print from a Windows application to a network-connected device in a separate location. For example, you can use the HP remote printer driver to print from your laptop at a coffee shop to your HP all-in-one at home. You can also print to your device while working from home over a virtual private network (VPN). For more information, see [Remote print documents](#).

Further, a friend or relative who does not have a network-connected device can download the remote printer driver to his computer and print to your HP all-in-one (after you have provided him with the name of your device). For more information, see [Remote print documents](#).

## Get started

You must have the following to use HP Instant Share with your HP all-in-one:

- A functional local area network (LAN)
- An HP all-in-one connected to the LAN
- Direct access to the Internet through an Internet Service Provider (ISP)
- An HP Passport user ID and password
- HP Instant Share set up on your device

You can set up HP Instant Share and obtain an HP Passport user ID and password:

- From the **HP Image Zone** software on your computer
- By pressing HP Instant Share on the control panel of your HP all-in-one
- When the option is offered to you at the end of the software install (Macintosh only)

For more information, see the **HP Instant Share Setup Wizard** onscreen Help.

**Note** Make sure you select the **Typical** install when installing your HP all-in-one software. HP Instant Share will **not** function on a device with a minimum install.

Once you have obtained an HP Passport user ID and password, created a unique name for your HP all-in-one, and registered your device, you have the option to add senders to an access list and create destinations. If you choose to use the access list and create destinations at a later date, follow the instructions in the following topics.

**Note** When you sign up with HP Instant Share and register your HP all-in-one, you are automatically added to the access list for your device and given auto print privileges. For more information on becoming an HP Instant Share member and registering your device, see [Get started](#).

## Create destinations

Create destinations to designate locations to which you (the sender) want to send images. A destination, for example, can be an e-mail address, a friend or relative's

network-connected device, an online photo album, or an online photo finishing service. Availability of services varies by country/region.

**Note** Although destinations are created on the HP Instant Share service, they are accessed through the HP all-in-one.

### To create destinations

- 1 Press **HP Instant Share** on the control panel of your HP all-in-one. The **HP Instant Share** menu appears on the color graphics display.
- 2 Press **3** to select **Add New Destination**. The **Select Computer** menu appears, with a list of computers connected to your network.
- 3 Select a computer from the list.

**Note** **HP Image Zone** software must be installed on the computer selected, and the computer must be able to access the HP Instant Share service.

- 4 The HP Instant Share service screens appear in a window on your computer. Sign in to HP Instant Share with your HP Passport **userid** and **password**. The HP Instant Share manager appears.

**Note** You will not be prompted for your HP Passport **userid** and **password** if you have set the HP Instant Share service to remember them.

- 5 Select the **Share** tab and follow the onscreen instructions to create a new destination.

For more information, see the onscreen Help.

If you want to send a collection of images to a friend or relative's network-connected device, select **HP Instant Share E-mail**. In the **E-mail address** field enter the name of the device followed by **@send.hp.com**. (This particular e-mail address can only be used with HP Instant Share.)

**Note** To send to a device: 1) both the sender and recipient must have an HP Passport user ID and password; 2) the device to which the image is sent must be registered with HP Instant Share; and 3) the image must be sent using **HP Instant Share E-mail** or HP remote printing.

Prior to setting up a device destination in **HP Instant Share E-mail** or adding a printer for use with HP remote printing, ask the recipient for the unique name he assigned to his network-connected device. The device name is created by a person when he signs up with HP Instant Share and registers his device. For more information, see [Get started](#).

### Use the HP Instant Share access list

The access list is used when your HP all-in-one is set to receive in either Open or Private mode.

- In Open mode, you receive image collections from any sender who has an HP Passport account, and who knows the name you assigned to your device. By choosing to receive in Open mode, you are allowing a sender to send images to your device.

Use the access list to assign auto print privileges. Also use it to block senders from whom you do **not** want to receive images.

- In Private mode, you only receive images from senders you specify on the access list. Individuals added to the list must have an HP Passport user ID and password.

When you add a sender to the list, grant one of the following access privileges:

- Allow: Allows images received from a sender to be previewed prior to printing.
- Auto print: Allows images received from a sender to print automatically to your device.
- Block: Ensures you do not receive unwanted images from a sender.

### To use the access list

- 1 Press **HP Instant Share** on the control panel of your HP all-in-one. The **HP Instant Share** menu appears on the color graphics display.
- 2 Press **3**, and then press **5**. This displays the **Instant Share Options** menu, and then selects **Manage Account**. The **Select Computer** menu appears, with a list of computers connected to your network.
- 3 Select a computer from the list.

**Note** **HP Image Zone** software must be installed on the computer selected, and the computer must be able to access the HP Instant Share service.

The HP Instant Share service screens appear in a window on your computer.

- 4 At the prompt, sign in to HP Instant Share with your HP Passport **userid** and **password**. The HP Instant Share manager appears.

**Note** You will not be prompted for your HP Passport **userid** and **password** if you have set the HP Instant Share service to remember them.

- 5 Follow the onscreen instructions to add or remove senders and change access privileges using the access list.

For more information, see the onscreen Help.

**Note** You will need to obtain the HP Passport user ID of each sender you are adding to the access list. The user ID is required in order to add a sender to the list. After you have added a sender to the list and granted access privileges, the access list displays the sender's information as follows: access privileges granted, first name, last name, and HP Passport user ID.

## Send images directly from your HP all-in-one

Images can be photos or scanned documents. Either can be shared with friends and relatives using your HP all-in-one and HP Instant Share. Select photos from a memory card or scan an image, press **HP Instant Share** on the control panel of your HP all-in-one, and send your images to the destination of your choice. See the topics below for detailed instructions.

**Note** If you are sending to a network-connected device, the receiving device must be registered with HP Instant Share.

## Send photos from a memory card

Your HP all-in-one gives you the option to send photos immediately upon inserting a memory card, or insert the memory card and send photos at a later time. To send photos immediately, insert the memory card into the appropriate card slot, select one or more photos, and press **HP Instant Share** on the control panel.

If you insert the memory card, and then decide to send the photos at a later time, you will find that when you come back to your HP all-in-one it has gone into idle mode. Simply press **HP Instant Share** and follow the prompts to select and share photos.

**Note** For more information on using a memory card, see [Use a memory card or PictBridge camera](#).

### To send a photo to your friend or relative's network-connected device

- 1 Ask your friend or relative (recipient) for the name he assigned to his network-connected device.

**Note** The device name is assigned when you set up your HP Instant Share account and register your HP all-in-one. The device name is not case sensitive.

- 2 Verify that the recipient either is receiving in Open mode or has included your HP Passport user ID in the access list for the receiving device.  
For more information, see [Receive from any sender \(Open mode\)](#) and [Use the HP Instant Share access list](#).
- 3 Create a destination using the device name you obtained from the recipient.  
For more information, see [Create destinations](#).
- 4 Press **HP Instant Share** to send your photos.  
For more information, see the following procedure.

### To send photos immediately upon inserting your memory card

- 1 Make sure the memory card is inserted into the appropriate card slot on your HP all-in-one.
- 2 Select one or more photos.  
For more information on selecting photos, see [Use a memory card or PictBridge camera](#).

**Note** Movie file types might not be supported by the HP Instant Share service.

- 3 From the control panel of your HP all-in-one, press **HP Instant Share**.  
The **Share Menu** appears on the color graphics display.  
The **Share Menu** displays the destinations you created on the HP Instant Share service. For more information, see [Create destinations](#).
- 4 Use the ▲ and ▼ arrows to highlight a destination to which you want to send your photos.
- 5 Press **OK** to select the destination and send your photos.

**Note** You can also use the **Photo** button to send images from your memory card. For more information, see [Use a memory card or PictBridge camera](#).

### To insert the memory card and send photos at a later time

- 1 Insert the memory card into the appropriate slot on your HP all-in-one.

- After a period of time, the HP all-in-one will go into idle mode. The HP all-in-one is in idle mode when the idle screen appears on the color graphics display.
- 2 When you are ready to send the photos, press **HP Instant Share** on the control panel of your HP all-in-one.  
The **HP Instant Share** menu appears on the color graphics display.
  - 3 Press **1** to select **Send**.  
The **Send from Where?** menu appears.
  - 4 Press **1** to select **Memory card**.  
The first photo on your memory card appears on the color graphics display.
  - 5 Select one or more photos.  
For more information on selecting photos, see [Use a memory card or PictBridge camera](#).
  - 6 Press **Photo** on the control panel.  
The **Share Menu** appears.  
The **Share Menu** displays the destinations you created on the HP Instant Share service. For more information, see [Create destinations](#).
  - 7 Use the **▲** and **▼** arrows to highlight a destination to which you want to send your photos.
  - 8 Press **OK** to select the destination and send your photos.

## Send photos from a destination file

If your HP digital camera supports HP Instant Share, it lets you assign photos to destinations on a memory card. The assigned photos are stored in a destination file. When you remove the memory card from the camera and place it in the appropriate card slot on your HP all-in-one, the HP all-in-one reads the memory card and forwards the photos to their assigned destinations.

### To send photos to destinations assigned by your HP digital camera

- 1 Make sure the memory card is inserted into the appropriate card slot on your HP all-in-one.  
For more information, see [Use a memory card or PictBridge camera](#).  
The **Destinations Found** dialog appears on the color graphics display.
- 2 Press **1** to select **Yes, send photos to HP Instant Share destinations**.  
The photos are sent to their assigned destinations.

**Note** Sending photos to a large number of destinations might take a long time and might exceed the maximum number of destinations to which the HP all-in-one can send in a single transaction. Reinserting the memory card will cause the remaining photos to be sent to their destinations.

## Send a scanned image

You can share a scanned image by pressing **HP Instant Share** on the control panel. To use the **HP Instant Share** button, place the image on the glass, select the scanner as the method you are using to send the image, select a destination, and start the scan.

**Note** For more information on scanning an image, see [Use the scan features](#).

### To send a scanned image to your friend or relative's network-connected device

- 1 Ask your friend or relative (recipient) for the name he assigned to his network-connected device.

**Note** The device name is assigned when you set up your HP Instant Share account and register your HP all-in-one. The device name is not case sensitive.

- 2 Verify that the recipient either is receiving in Open mode or has included your HP Passport user ID in the access list for the receiving device.  
For more information, see [Receive from any sender \(Open mode\)](#) and [Use the HP Instant Share access list](#).
- 3 Create a destination using the device name you obtained from your friend or relative.  
For more information, see [Create destinations](#).
- 4 Press **HP Instant Share** to send your photos.  
For more information, see the following procedure.

### To send a scanned image from your HP all-in-one

- 1 Load your original face down on the right front corner of the glass.
- 2 From the control panel, press **HP Instant Share**.  
The **HP Instant Share** menu appears on the color graphics display.
- 3 Press **1** to select **Send**.  
The **Send from Where?** menu appears.
- 4 Press **2** to select **Scanner**.  
The **Share Menu** appears.  
The **Share Menu** displays the destinations you created on the HP Instant Share service. For more information, see [Create destinations](#).
- 5 Use the **▲** and **▼** arrows to highlight a destination to which you want to send your image.
- 6 Press **OK** to select the destination and begin the scan.  
The image is scanned and sent to the destination selected.

**Note** You can also use the **Scan** button to send a scanned image. For more information, see [Use the scan features](#).

### Cancel sending images

Sending images to a destination, or set of destinations, can be canceled at any time by pressing **Cancel** on the control panel. The effect of the cancellation depends on whether a collection of images has been uploaded to the HP Instant Share service.

- If a collection is fully uploaded to the HP Instant Share service, it is sent to its destination.
- If a collection is in the process of being uploaded to the HP Instant Share service, it is not sent to its destination.

## Send images using your computer

In addition to using your HP all-in-one to send images through HP Instant Share, you can use the **HP Image Zone** software installed on your computer to send images. The **HP Image Zone** software lets you select and edit one or more images, and then access HP Instant Share to select a service (for example, **HP Instant Share E-mail**) and send your images. At a minimum, you can share images through the following:

- HP Instant Share E-mail (send to an e-mail address)
- HP Instant Share E-mail (send to a device)

- Online Albums
- Online photo finishing (availability varies by country/region)

**Note** You cannot receive image collections using the **HP Image Zone** software.

If you want to share images using HP Instant Share E-mail (send to a device), perform the tasks in the bullets below:

- Ask the recipient for the name he assigned to his network-connected device.
 

**Note** The device name is assigned when you set up your HP Instant Share account and register your HP all-in-one. For more information, see [Get started](#).
- Verify that the recipient either is receiving in Open mode or has included your HP Passport user ID in the access list for the receiving device. For more information, see [Receive from any sender \(Open mode\)](#) and [Use the HP Instant Share access list](#).
- Perform the operating system specific instructions following.

### To send images from the HP Image Zone (Windows users)

- 1 Double-click the **HP Image Zone** icon on your desktop. The **HP Image Zone** window opens on your computer. The **My Images** tab appears in the window.
- 2 Select one or more images from the folder(s) in which they are stored. For more information, see the onscreen **HP Image Zone Help**.

**Note** Use the **HP Image Zone** image editing tools to edit your images and achieve the results you want. For more information, see the onscreen **HP Image Zone Help**.

- 3 Click the **HP Instant Share** tab. The **HP Instant Share** tab appears in the **HP Image Zone** window.
- 4 In the **Control** area, click **See All Services**. The **Go Online** screen appears in the **Work** area of the **HP Instant Share** tab.
- 5 Click **Next**.
- 6 From the services list, select the service you want to use to send your images.
- 7 Follow the onscreen instructions.

For more information, see the onscreen Help.

If you want to send a collection of images to a friend or relative's network-connected device, select **HP Instant Share E-mail**. In the **E-mail address** field enter the name of the device followed by [@send.hp.com](mailto:@send.hp.com). You will be prompted to sign in to HP Instant Share with your HP Passport **userid** and **password**.

**Note** If you have not previously set up HP Instant Share, click **I need an HP Passport account** on the **Sign in with HP Passport** screen. Obtain an HP Passport user ID and password. At the **Region and Terms of Use** screen, select your country/region, and accept the **Terms of Use**.

### To send images from the HP Image Zone (Macintosh OS X v10.1.5 and later users)

**Note** Macintosh OS X v10.2.1 and v10.2.2 are not supported.

- 1 Select the **HP Image Zone** icon from the Dock.



- 1 The **HP Image Zone** opens on your desktop.
- 2 In the **HP Image Zone**, click the **Services** button at the top of the window. A list of applications appears in the lower part of the **HP Image Zone**.
- 3 Choose **HP Instant Share** from the list of applications. The **HP Instant Share** client application software opens on your computer.
- 4 Add the images you want to share to the **HP Instant Share** window. For more information, see the HP Instant Share section of the **HP Image Zone Help**.
- 5 When you have added all of the images, click **Continue**.
- 6 Follow the onscreen instructions.
- 7 From the services list, select the service you want to use to send your images.
- 8 Follow the onscreen instructions.

For more information, see the onscreen Help.

If you want to send a collection of images to a friend or relative's network-connected device, select **HP Instant Share E-mail**. In the **E-mail address** field enter the name of the device followed by **@send.hp.com**. You will be prompted to sign in to HP Instant Share with your HP Passport **userid** and **password**.

**Note** If you have not previously set up HP Instant Share, click **I need an HP Passport account** on the **Sign in with HP Passport** screen. Obtain an HP Passport user ID and password. At the **Region and Terms of Use** screen, select your country/region, and accept the **Terms of Use**.

## Receive images

Images can be sent from one network-connected device to another. You can receive a collection of images from any sender who has an HP Passport user ID and password (Open mode) or a specified group of senders (Private mode). The default receive mode is Open. For more information, see [HP Instant Share Receive](#).

**Note** An image collection (or collection of images) is a group of images sent by an individual to a specific destination which, in this case, is your device.

### Receive from any sender (Open mode)

By default, your HP all-in-one is set to receive in Open mode. Any friend or relative with a valid HP Passport account who knows your device name is allowed to send you an image collection. The collection will **not** automatically print unless you grant auto print privileges to the sender through the HP Instant Share access list. For more information, see [Use the HP Instant Share access list](#).

**Note** Even though your HP all-in-one is set to receive from any sender, you can still block the receipt of images from specific senders. Simply block them using the access list. For more information, see [Use the HP Instant Share access list](#).

You can also block images sent to your device by accessing the print jobs list on the HP Instant Share service.

### To receive images from any sender

- 1 Press **HP Instant Share** on the control panel of your HP all-in-one. The **HP Instant Share** menu appears on the color graphics display.
- 2 Press **3** to select **HP Instant Share Options**. The **Instant Share Options** menu appears.

- 3 Press **1** to select **Receive Options**.  
The **Receive Options** menu appears.
- 4 Press **2** to select **Open, receive from any sender**.  
By default, your HP all-in-one is set to allow you to preview images in a collection before printing. To automatically print images received, see [To automatically print received images](#).

### Receive from a specified group of senders (Private mode)

When you set your HP all-in-one to receive in Private mode, image collections are received from a specified group of allowed senders, each of whom has an HP Passport account. This is accomplished by adding each sender to the access list. As you add a sender to the list, grant access privileges. For more information, see [Use the HP Instant Share access list](#).

**Note** In Private mode, you will only receive image collections from senders who have an HP Passport account and to whom you have granted allowed or auto print privileges.

In Private mode, received images are printed manually unless auto print privileges have been granted through the access list. For more information, see [Print received images](#).

### To receive images from a specified group of allowed senders

- 1 Add senders to the HP Instant Share access list and grant privileges.  
For more information, see [Use the HP Instant Share access list](#).
- 2 After you have completed the list, press **HP Instant Share** on the control panel of your HP all-in-one.  
The **HP Instant Share** menu appears on the color graphics display.
- 3 Press **3**, and then press **1**.  
This displays the **Instant Share Options** menu, and then selects **Receive Options**.  
The **Receive Options** menu appears.
- 4 Press **1** to select **Private, receive from allowed senders**.
- 5 Set your HP all-in-one to allow you to preview images in a collection before printing, or automatically print each image received.  
For more information, see [Print received images](#).

## Print received images

The HP Instant Share service receives image collections sent to your device and indicates (by collection) the access privileges assigned to the sender. Your HP all-in-one checks the HP Instant Share service for received images in one of two ways:

- If your HP all-in-one is network-connected and has been set up with HP Instant Share, it will automatically check the HP Instant Share service at a set interval (for example, every 20 minutes) for new image collections. This process is called auto checking and is enabled by default on your device.  
If your HP all-in-one detects that a collection has been received at the HP Instant Share service, an icon appears on the color graphics display to let you know that one or more collections have been received. If a received collection is from an allowed sender with auto print privileges, it automatically prints from your device. If a received collection is from an allowed sender **without** auto print privileges,

information about the collection is displayed in the **Received** collections list in the HP all-in-one.

- If auto checking is not enabled, or if you want to check to see if you have received a collection between auto check intervals, press **HP Instant Share** and select **Receive** from the **HP Instant Share** menu. Selecting **Receive** triggers your HP all-in-one to check for new image collections and download the information to your device's **Received** collection list.

If a received collection is from an allowed sender with auto print privileges, you will be prompted either to **Print Now** or **Print Later**. If you select **Print Now**, the images in the collection are printed. If you select **Print Later**, information about the collection is displayed in the **Received** collections list.

The following sections describe how to print received images, set print size and related print options, and cancel print jobs.

### Automatically print received images

A collection of images received from an allowed sender with auto print privileges will automatically print to your HP all-in-one if auto checking is enabled on your device.

#### To automatically print received images

- 1 Add a sender to the HP Instant Share access list and grant him auto print privileges.  
For more information, see [Use the HP Instant Share access list](#).
- 2 Press **HP Instant Share** on the control panel of your HP all-in-one.  
The **HP Instant Share** menu appears on the color graphics display.
- 3 Press **3**, and then press **2**.  
This displays the **Instant Share Options** menu, and then selects **Auto Checking**.  
The **Auto Checking** menu appears.
- 4 Press **1** to select **On**.

With **Auto Checking** "On," your HP all-in-one periodically queries the HP Instant Share service to see if you have received an image collection. If a collection is detected, and it is from a sender with permission to auto print, it is downloaded to your device and printed.

**Note** To query the HP Instant Share service manually, press **HP Instant Share** and then press **2** to select **Receive** from the **HP Instant Share** menu. Your HP all-in-one queries the HP Instant Share service. If it finds one or more collections to auto print, the **Print Job Ready** screen appears on the color graphics display. If you press **1** to select **Print Now**, the collection is printed and added to the **Received** collections list. If you press **2** to select **Print Later**, the collection is just added to the **Received** collections list.

### Manually print received images

A collection of images received from a sender who is allowed to send to your device, but does not have auto print privileges, is held on the HP Instant Share service until you decide how to process the images through your HP all-in-one. You can either preview the images in a collection before printing or print the entire collection without previewing the images.

#### To preview images before printing

- 1 Press **HP Instant Share** on the control panel of your HP all-in-one.

- The **HP Instant Share** menu appears on the color graphics display.
- 2 Press **2** to select **Receive**.  
The HP all-in-one queries the HP Instant Share service to see if you have received an image collection. If a collection is found, it is downloaded to your device. The **Received** collections list appears on the color graphics display.
  - 3 Use the **▲** and **▼** arrows to select a collection to view.
  - 4 Press **OK**.
  - 5 Select one or more images from the collection.
  - 6 Press **Start Color**, **Start Black**, or **Photo**.
    - If you press **Start Color**, the selected images print according to the defaults (that is, one copy of a 10 by 15 cm (4 by 6 inch) print)
    - If you press **Start Black**, the selected images print in black and white according to the defaults (that is, one copy of a 10 by 15 cm (4 by 6 inch) print)
    - If you press **Photo**, you can select from a list of print options (for example, number of copies, image size, paper size, and paper type) before you print. After you select the options you want, press **Start Color** or **Start Black**.

**Note** For more information on print options, see [Set photo print options](#).

### To print an image collection without previewing it

- 1 Press **HP Instant Share** on the control panel of your HP all-in-one.  
The **HP Instant Share** menu appears on the color graphics display.
- 2 Press **2** to select **Receive**.  
The HP all-in-one queries the HP Instant Share service to see if you have received an image collection. If a collection is found, it is downloaded to your device. The **Received** collections list appears.
- 3 Use the **▲** and **▼** arrows to select a collection to print.
- 4 Press **Start Color** or **Start Black**.  
The images print according to the print information they contain. If they do not contain print information, the images print according to the remote print options defined in the **Instant Share Options** menu.

## Set print options

Images scanned by an HP All-in-One are forwarded to a receiving device with a specific print size. Similarly, images and documents forwarded by the HP remote printer driver are received with a defined print size. When a document, or collection of images, is received with a defined print size, the items are printed according to the following rules:

- If the collection or document is set to auto print, the HP all-in-one uses the print size specified.
- If the collection or document is previewed before printing, the HP all-in-one uses options defined in the **Print Options** menu (either the defaults or what the user has selected).
- If the collection or document is printed without previewing, the HP all-in-one uses the print size specified.

Images sent from a camera or memory card are forwarded to a receiving device **without** print information. When an image, or collection of images, is received **without** print information, the items are printed according to the following rules:

- If the image or collection is set to auto print, the HP all-in-one uses the remote print options defined in the **Instant Share Options** menu.
- If the image or collection is previewed before printing, the HP all-in-one uses options defined in the **Print Options** menu (either the defaults or what the user has selected).
- If the image or collection is printed without previewing, the HP all-in-one uses the remote print options defined in the **Instant Share Options** menu.

Each of the above rules is detailed in the tasks following.

#### To set remote print options for a collection set to auto print

- 1 Press **HP Instant Share** on the control panel of your HP all-in-one. The **HP Instant Share** menu appears on the color graphics display.
- 2 Press **3**, and then press **6**. This displays the **Instant Share Options** menu, and then selects **Remote Print Size**. The **Image Size** menu appears.
- 3 Use the **▲** and **▼** arrows to select the appropriate image size. The default setting is **Fit to Page**.  
For more information, see [Set photo print options](#).

#### To set print options for a collection previewed before printing

- 1 Press **HP Instant Share** on the control panel of your HP all-in-one. The **HP Instant Share** menu appears on the color graphics display.
- 2 Press **2** to select **Receive**. The HP all-in-one queries the HP Instant Share service to see if you have received an image collection. If a collection is found, it is downloaded to your device. The **Received** collections list appears on the color graphics display.
- 3 Use the **▲** and **▼** arrows to select a collection to view.
- 4 Press **OK**.
- 5 Select one or more images from the collection.
- 6 Press **Photo** on the control panel. The **Print Options** menu appears.
- 7 Select the item you want to configure (for example: number of copies, image size, paper size, and paper type), and then select the setting.  
**Note** For more information on print options, see [Set photo print options](#).
- 8 Press **Start Black** or **Start Color** to print.

#### To set remote print options for a collection printed without previewing

- Follow the instructions in [To set remote print options for a collection set to auto print](#).

## Cancel print jobs

Your HP all-in-one lets you cancel any action at any time. Simply press **Cancel** to halt receive, preview, and print jobs.

- If you select **Receive** from the **HP Instant Share** menu and then press **Cancel**, your device stops checking to see if new image collections have been received by the HP Instant Share service. You are returned to the **HP Instant Share** menu.
- If you are previewing a collection of images and press **Cancel**, any images you selected for print are deselected. You are returned to the **Received** collections list.
- If you have started printing an image collection and press **Cancel**, the print job quits. The image in the midst of printing and the remaining images are not printed. Your HP all-in-one goes into idle mode.

**Note** Cancelled print jobs will not reprint automatically.

## Remove received images

Within the **Received** collections list displayed on your HP all-in-one, image collections are presented so that the most recent collection appears first. Older collections expire after 30 days. (The number of days specified is subject to change. See the Terms of Service on the HP Instant Share service for the most current information.)

If you receive a large number of collections, you might want to reduce the number of collections displayed. Your HP all-in-one provides a way to remove image collections from the **Received** collections list.

### To remove image collections

- 1 Press **HP Instant Share** on the control panel of your HP all-in-one.  
The **HP Instant Share** menu appears on the color graphics display.
- 2 Press **3** to select **HP Instant Share Options**.  
The **Instant Share Options** menu appears.
- 3 Press **3** to select **Remove Collections**.  
The **Remove Collections** list appears.
- 4 Use the **▲** and **▼** arrows to highlight a collection to remove.
- 5 Press **OK** to select a collection for removal.  
You can deselect a collection by pressing **OK** a second time.
- 6 Select all collections you want removed.
- 7 When you are finished, highlight the **Done Selecting** label, and then press **OK**.  
The selected items are removed from the **Received** collections list.

## Remote print documents

The HP remote printer driver lets you send print jobs from Windows applications to remote, network-connected printing devices. For example, you can remote print from your laptop (or other PC) to your HP all-in-one, access your computer at work through a VPN and print to your device, or send a print job from any other remote network-connected device to your HP All-in-One. Each unit sending a print job must have the HP remote printer driver installed on it.

The HP remote printer driver is installed on the computer (or laptop) on which you installed the software for your device. If you want to install the HP remote printer driver on another laptop, install the device software or download the driver from the HP website.

**Note** To download the HP remote printer driver from the HP website, make sure you use a broadband connection. Do not use a dial-up connection. It will take approximately 3 to 5 minutes to download the driver using a broadband connection.

### To use the HP remote printer driver

- 1 From a Windows application, select **File** and then **Print**. The **Print** window appears on your computer screen.
- 2 Select the printer named **HP remote printers**.
- 3 Click printer **Properties** and set your print options.
- 4 Click **OK** to print.  
The HP Instant Share **Welcome** screen appears in a window on your computer. The **Welcome** screen only appears if you have not previously selected **Do not show this screen again**.
- 5 Follow the onscreen instructions.
- 6 At the prompt, enter your HP Passport **userid** and **password**, and then click **Next**.

**Tip** You will only be prompted for your HP Passport userid and password if you have not previously set the service to remember your userid and password.

**Note** If you have not previously set up HP Instant Share, click **I need an HP Passport account** on the **Sign in with HP Passport** screen. Obtain an HP Passport user ID and password. At the **Region and Terms of Use** screen, select your country/region, and accept the **Terms of Use**.

The **Select a Remote Printer** screen appears.

- 7 If you are printing to your HP all-in-one, select your printer from the list of printers.

**Note** Printers are listed using the unique name assigned to the device when the device was set up and registered with HP Instant Share. Any printer to which you have been allowed access will appear on the list.

If you are printing to a network-connected device other than your own, select the name of the printer from the list of printers. If it is the first time you have printed to the device, click **Add Printer** to add the device to the list. For more information on sending to a device, see steps 1 and 2 in the task [To send a photo to your friend or relative's network-connected device](#).

- 8 Follow the onscreen instructions.

**Note** For more information on receiving remote print jobs, see [Receive images](#).

## Set HP Instant Share options

Your HP all-in-one lets you:

- Choose whether you will receive image collections in Open or Private mode
- Enable or disable auto checking
- Remove printed or unwanted image collections from the **Received** collections list
- Add or delete senders and assign access privileges from the access list
- View the unique name you assigned to your device
- Reset your HP Instant Share device settings to factory defaults

### To set HP Instant Share options

- 1 Press **HP Instant Share** on the control panel of your HP all-in-one.

- The **HP Instant Share** menu appears on the color graphics display.
- Press **3** to select **HP Instant Share Options**.  
The **Instant Share Options** menu appears on the color graphics display.
  - Use the **▲** and **▼** arrows to highlight the option you want to access.  
Options are described in the table below.

### Instant Share Options

Receive Options	Selecting <b>Receive Options</b> lets you choose whether your HP all-in-one will receive a collection of images from any sender who has a valid HP Passport account (Open mode) or a specified group of senders (Private mode). The default is set to <b>Open, receive from any sender</b> . For more information, see <a href="#">Open, receive from any sender</a> and <a href="#">Receive from a specified group of senders (Private mode)</a> and <a href="#">Receive from any sender (Open mode)</a> .
Auto Checking	Selecting <b>Auto Checking</b> lets you decide whether or not your HP all-in-one checks the HP Instant Share service at predetermined intervals for new messages. If auto checking is set to <b>On</b> , an icon displays on the color graphics display to let you know when an image collection has been received. (The icon is described in the <a href="#">HP all-in-one overview</a> . For more information, see <a href="#">To preview images before printing</a> and <a href="#">To automatically print received images</a> .  <b>Note</b> If you never send or receive images, or are happy to check manually for messages by pressing the <b>HP Instant Share</b> button, set auto checking to <b>Off</b> .
Remove Collections	Selecting <b>Remove Collections</b> lets you remove image collections from the <b>Received</b> collections list. For more information, see <a href="#">Remove received images</a> .
Display Device Name	Selecting <b>Display Device Name</b> lets you view the name you assigned to your HP all-in-one when you signed up with HP Instant Share and registered your device. The device name is used by others to send to your device. For more information, see <a href="#">To send a photo to your friend or relative's network-connected device</a> .
Manage Account	If your HP all-in-one is not set up with HP Instant Share, selecting <b>Manage Account</b> launches the <b>HP Instant Share Setup Wizard</b> . If your device is already set up, selecting <b>Manage Account</b> lets you manage your HP Instant Share account from your computer. After you sign in with your HP Passport <b>userid</b> and <b>password</b> , you are presented with the HP Instant Share manager. Options include the ability to create a destination and add senders to the access list. For more information, see the topics under <a href="#">Get started</a> .



---

### Instant Share Options

---

Remote Print Size	Selecting <b>Remote Print Size</b> lets you set the print size for received images. For more information, see <a href="#">Set print options</a> .
Reset HP Instant Share	<p>Selecting <b>Reset HP Instant Share</b> lets you reset your HP Instant Share device settings to factory defaults. This means your HP all-in-one is no longer registered with HP Instant Share.</p> <p><b>Note</b> If you reset your HP Instant Share device settings, your HP all-in-one will no longer be able to send or receive images until it is again set up with HP Instant Share.</p> <p>Select this option when you either want to give your device to someone else or want to switch your HP all-in-one from being network-connected to USB-connected.</p>

# 14 Order supplies

You can order recommended types of HP paper, print cartridges, and HP all-in-one accessories online from the HP website.

## Order paper, transparency film, or other media

To order media such as HP Premium Paper, HP Premium Plus Photo Paper, HP Premium Inkjet Transparency Film, or HP Iron-On Transfer, go to [www.hp.com](http://www.hp.com). If prompted, choose your country/region, follow the prompts to select your product, and then click one of the shopping links on the page.

## Order print cartridges

To order print cartridges for your HP all-in-one, go to [www.hp.com](http://www.hp.com). If prompted, choose your country/region, follow the prompts to select your product, and then click one of the shopping links on the page.

Your HP all-in-one supports the following print cartridges:

Print cartridges	HP reorder number
HP black inkjet print cartridge	#96, 28 ml black print cartridge
HP tri-color inkjet print cartridge	#97, 16 ml color print cartridge #95, 11 ml color print cartridge
HP photo inkjet print cartridge	#99, 15 ml color photo print cartridge
HP gray photo inkjet print cartridge	#100, 15 ml gray print cartridge

**Note** Print cartridge reorder numbers vary by country/region. If the reorder numbers listed in this guide do not match the numbers on the print cartridges currently installed in your HP all-in-one, order new print cartridges with the same numbers as those you currently have installed.

You can find out the reorder numbers for all the print cartridges your device supports through the **Printer Toolbox**. In the **HP Director**, click **Settings**, point to **Print Settings**, and then click **Printer Toolbox**. Click the **Estimated Ink Levels** tab, and then click **Print Cartridge Ordering Information**.

You can also contact a local HP reseller or go to [www.hp.com/support](http://www.hp.com/support) to confirm the correct print cartridge reorder numbers for your country/region.

## Order accessories

To order accessories for your HP all-in-one, such as an additional paper tray or a duplexer for automatic two-sided printing, go to [www.hp.com](http://www.hp.com). If prompted, choose your country/region, follow the prompts to select your product, and then click one of the shopping links on the page.

Depending on your country/region, your HP all-in-one might support the following accessories:

Accessory and HP model number	Description
HP Automatic Two-sided Printing Accessory ph5712	Enables you to automatically print on both sides of a sheet of paper. With this accessory installed you can print on both sides of the page without having to manually flip and reload the pages in the middle of your print job.
HP Auto Two-sided Print Accessory with Small Paper Tray (also called the Hagaki Tray with Auto Two-sided Print Accessory) ph3032	Adds a dedicated paper tray for small paper sizes and envelopes to the rear of your HP all-in-one and enables you to automatically print on both sides of full- and small-size papers. With this accessory installed, you can load full-size paper in the main input tray and small paper, such as Hagaki cards, in the rear input tray. This saves you time when switching between print jobs on different size papers because you do not need to remove and reload paper each time.
HP 250 Sheet Plain Paper Tray pt3447	Adds a dedicated paper tray for up to 250 sheets of full-size plain paper to your HP all-in-one. With this accessory installed, you can load plain paper in the lower input tray and special paper types in the upper input tray. This saves you time when switching between print jobs on different types of paper because you do not need to remove and reload paper each time.
HP bt300 Bluetooth® Wireless Printer Adapter bt300	Enables you to print from a Bluetooth device to your HP all-in-one. This accessory plugs into the camera port on the front of the HP all-in-one and accepts print jobs from supported Bluetooth devices, such as a digital camera phone or a personal digital assistant (PDA). It does not support printing from a Bluetooth-enabled PC or Macintosh computer.

## Order other supplies

To order other supplies, such as HP all-in-one software, a copy of the printed User Guide, a Setup Guide, or other customer-replaceable parts, call the appropriate number below:

- In the U.S. or Canada, dial **1-800-474-6836 (1-800-HP invent)**.
- In Europe, dial +49 180 5 290220 (Germany) or +44 870 606 9081 (U.K.).

To order HP all-in-one software in other countries/regions, call the phone number for your country/region. The numbers listed below are current as of the publication date of this guide. For a list of current ordering numbers, go to [www.hp.com/support](http://www.hp.com/support). If prompted, choose your country/region, and then click **Contact HP** for information on calling for technical support.

Country/region	Number for ordering
Asia Pacific (except for Japan)	65 272 5300

(continued)

Country/region	Number for ordering
Australia	131047
Europe	+49 180 5 290220 (Germany) +44 870 606 9081 (U.K.)
New Zealand	0800 441 147
South Africa	+27 (0)11 8061030
U.S. and Canada	1-800-HP-INVENT (1-800-474-6836)



# 15 Maintain your HP all-in-one

The HP all-in-one requires little maintenance. Sometimes you might want to clean the glass and lid backing to remove surface dust and ensure that your copies and scans remain clear. You will also need to replace, align, or clean your print cartridges occasionally. This chapter provides instructions for keeping your HP all-in-one in top working condition. Perform these simple maintenance procedures as necessary.

## Clean the HP all-in-one

Fingerprints, smudges, hair, and other debris on the glass or lid backing slow down performance and affect the accuracy of special features such as **Fit to Page**. To ensure that your copies and scans remain clear, you might need to clean the glass and lid backing. You might also want to dust the exterior of the HP all-in-one.

### Clean the glass

Dirty glass from fingerprints, smudges, hair, and dust slows down performance and affects the accuracy of features such as **Fit to Page**.

- 1 Turn off the HP all-in-one, unplug the power cord, and raise the lid.

**Note** When you unplug the power cord, the date and time are erased. You will need to reset the date and time later, when you plug the power cord back in. Any faxes stored in memory are also erased.

- 2 Clean the glass with a soft cloth or sponge slightly moistened with a nonabrasive glass cleaner.



**Warning** Do not use abrasives, acetone, benzene, or carbon tetrachloride on the glass; they can damage it. Do not place or spray liquid directly on the glass; the liquid might seep under the glass and damage the device.

- 3 Dry the glass with a chamois or cellulose sponge to prevent spotting.

### Clean the lid backing

Minor debris can accumulate on the white document backing located underneath the lid of the HP all-in-one.

- 1 Turn off the HP all-in-one, unplug the power cord, and raise the lid.
- 2 Clean the white document backing with a soft cloth or sponge slightly moistened with a mild soap and warm water.
- 3 Wash the backing gently to loosen debris. Do not scrub the backing.
- 4 Dry the backing with a chamois or soft cloth.



**Warning** Do not use paper-based wipes, as these might scratch the backing.

- 5 If further cleaning is needed, repeat the previous steps using isopropyl (rubbing) alcohol, and wipe the backing thoroughly with a damp cloth to remove any residual alcohol.



**Warning** Be careful not to spill alcohol on the glass or painted parts of the HP all-in-one, as this might damage the device.

### Clean the exterior

Use a soft cloth or slightly moistened sponge to wipe dust, smudges, and stains off the case. The interior of the HP all-in-one does not require cleaning. Keep fluids away from the control panel and the interior of the HP all-in-one.



**Warning** To avoid damage to painted parts of the HP all-in-one, do not use alcohol or alcohol-based cleaning products on the control panel, lid, or other painted parts of the device.

## Check the estimated ink levels

You can easily check the ink supply level to determine how soon you might need to replace a print cartridge. The ink supply level shows an estimate of the amount of ink remaining in the print cartridges.

### To check the ink levels from the control panel

- Look for two icons at the bottom of the color graphics display that represent the levels of ink remaining in the two installed print cartridges.
  - A green icon represents an estimate of the amount of ink remaining in the tri-color print cartridge.
  - A black icon represents an estimate of the amount of ink remaining in the black print cartridge.
  - An orange icon represents an estimate of the amount of ink remaining in the photo print cartridge.
  - A blue-gray icon represents an estimate of the amount of ink remaining in the gray photo print cartridge.

If you are using non-HP print cartridges or cartridges that have been refilled, or if there is no print cartridge installed in one of the cartridge stalls, one or both icons might not appear in the icon bar. The HP all-in-one cannot detect the amount of ink remaining in non-HP print cartridges or cartridges that have been refilled.

If an icon shows a hollow ink drop, the print cartridge represented by that color icon has very little ink remaining and will need to be changed soon. Replace the print cartridge when the print quality starts to degrade.

For more information on the ink level icons on the color graphics display, see [Color graphics display icons](#).

You can also check the estimated amount of ink remaining in your print cartridges from the computer. If you have a USB connection between your computer and the HP all-in-one, see the onscreen **HP Image Zone Help** for information on checking the ink levels from the **Printer Toolbox**. If you have a network connection, you can check the ink levels from the Embedded Web Server (EWS). See the Network Guide for information on accessing the EWS.

## Print a self-test report

If you are experiencing problems with printing, print a self-test report before you replace the print cartridges. This report provides useful information on several aspects of your device, including your print cartridges.

- 1 Load letter, A4, or legal unused plain white paper into the input tray.
- 2 Press **Setup**.
- 3 Press **2**, then press **5**.

This displays the **Print Report** menu and then selects **Self-Test Report**.

The HP all-in-one prints a self-test report, which might indicate the source of the printing problem. A sample of the ink test area of the report is shown below.

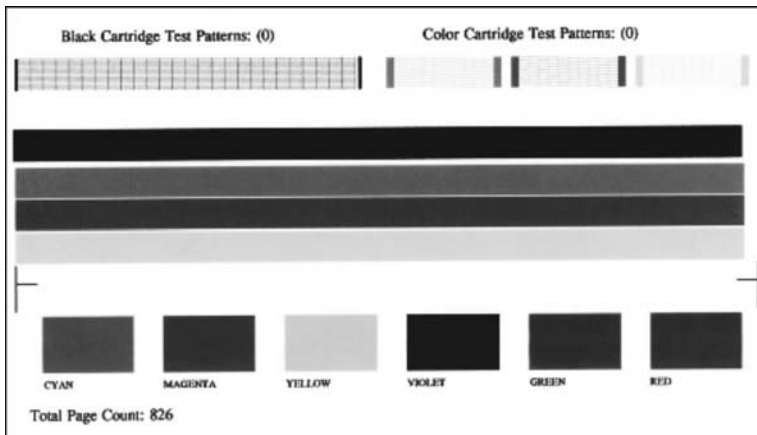

- 4 Make sure the test patterns are even and show a complete grid.  
If more than a few lines in a pattern are broken, this might indicate a problem with the nozzles. You might need to clean the print cartridges. For more information, see [Clean the print cartridges](#).
- 5 Make sure the lines of color extend across the page.  
If the black line is missing, faded, streaked, or shows lines, this might indicate a problem with the black or photo print cartridge in the right slot.  
If any of the remaining three lines are missing, faded, streaked, or show lines, this might indicate a problem with the tri-color print cartridge in the left slot.
- 6 Make sure the color blocks have even consistency and are representative of the colors listed below.

You should see cyan, magenta, yellow, violet, green, and red color blocks.

If color blocks are missing, or if a block of color is muddy or does not match the label indicated below the block, this might indicate that the tri-color print cartridge is out of ink. You might need to replace the print cartridge. For more information on replacing print cartridges, see [Replace the print cartridges](#).

**Note** For examples of test patterns, lines of color, and color blocks from normal and malfunctioning print cartridges, see the onscreen **HP Image Zone Help** that came with your software.



## Work with print cartridges

To ensure the best print quality from your HP all-in-one, you will need to perform some simple maintenance procedures. This section provides guidelines for handling the print cartridges and instructions for replacing, aligning, and cleaning the print cartridges.

### Handle the print cartridges

Before you replace or clean a print cartridge, you should know the part names and how to handle the print cartridges.

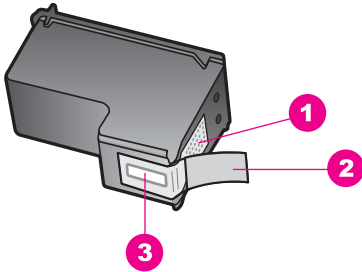

1	Copper-colored contacts
2	Plastic tape with pink pull tab (must be removed before installing)
3	Ink nozzles under tape

Hold the print cartridges by their black plastic sides, with the label on top. Do not touch the copper-colored contacts or the ink nozzles.

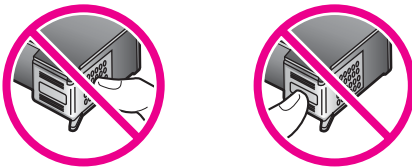

**Warning** Be careful not to drop the print cartridges. This can damage them, making them unusable.

### Replace the print cartridges

When the ink level for the print cartridge is low, a message appears on the color graphics display.

**Note** You can also check the ink levels by using the **HP Director** that came with the **HP Image Zone** software on your computer. For more information, see [Check the estimated ink levels](#).

When you receive a low-ink warning message on the color graphics display, make sure you have a replacement print cartridge available. You should also replace the print cartridges when you see faded text or if you experience print quality issues related to the print cartridges.

**Tip** You can also use these instructions to replace the black print cartridge with a photo or gray photo print cartridge for printing high-quality color or black-and-white photos.

To find out the reorder number for all the print cartridges that your HP all-in-one supports, see [Order print cartridges](#). To order print cartridges for your HP all-in-one, go to [www.hp.com](http://www.hp.com). If prompted, choose your country/region, follow the prompts to select your product, and then click one of the shopping links on the page.

### To replace the print cartridges

- 1 Make sure the HP all-in-one is on.



**Warning** If the HP all-in-one is off when you lift the print-carriage access door to access the print cartridges, the HP all-in-one will not release the cartridges for changing. You might damage the HP all-in-one if the print cartridges are not docked safely on the right side when you try to remove them.

- 2 Open the print-carriage access door by lifting from the front center of the device, until the door locks into place. The print carriage is on the far right side of the HP all-in-one.

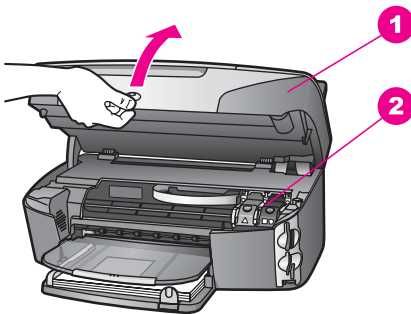

1	Print-carriage access door
2	Print carriage

- 3 When the print carriage is idle and silent, press down and then lift a latch inside the HP all-in-one.  
If you are replacing the tri-color print cartridge, lift the green latch on the left.  
If you are replacing the black, photo, or gray photo print cartridge, lift the black latch on the right.

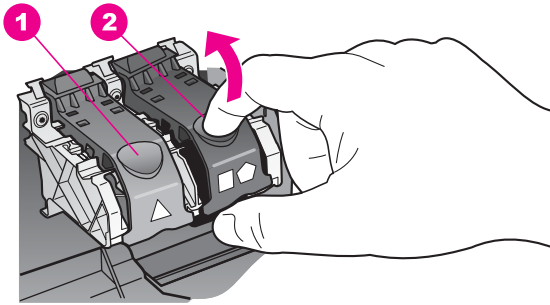

1	Print cartridge latch for the tri-color print cartridge
2	Print cartridge latch for the black, photo, and gray photo print cartridges

- 4 Push down on the print cartridge to release it, and then pull it toward you out of its slot.

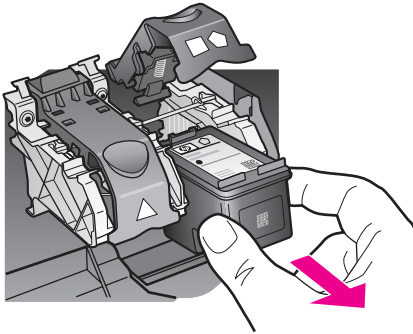

- 5 If you are removing the black print cartridge in order to install the photo or gray photo print cartridge, store the black print cartridge in the print cartridge protector. For more information, see [Use the print cartridge protector](#).  
If you are removing the print cartridge because it is low or out of ink, recycle the print cartridge. The HP Inkjet Supplies Recycling Program is available in many countries/regions, and lets you recycle used print cartridges free of charge. For more information, go to the following website:  
[www.hp.com/hpinfo/globalcitizenship/environment/recycle/inkjet.html](http://www.hp.com/hpinfo/globalcitizenship/environment/recycle/inkjet.html)
- 6 Remove the new print cartridge from its packaging and, being careful to touch only the black plastic, gently remove the plastic tape by using the pink pull tab.

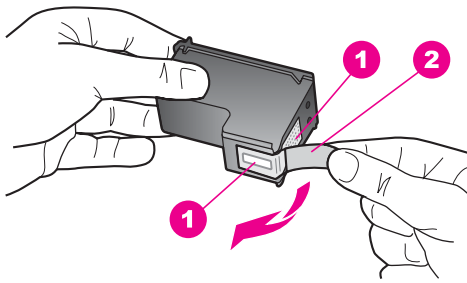

1	Copper-colored contacts
2	Plastic tape with pink pull tab (must be removed before installing)
3	Ink nozzles under tape

**Caution** Do not touch the copper-colored contacts or ink nozzles. Touching these parts can result in clogs, ink failure, and bad electrical connections.

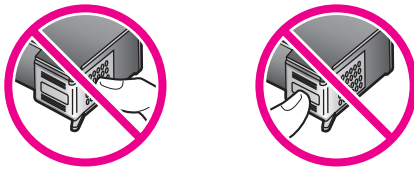

- 7 Slide the new print cartridge down the ramp and into the empty slot. Push the print cartridge forward until it clicks into place. If the print cartridge you are installing has a white triangle on its label, slide the print cartridge into the slot on the left. The latch is green with a solid white triangle on it. If the print cartridge you are installing has a white square or a white pentagon on its label, slide the print cartridge into the slot on the right. The latch is black with a solid white square and a solid white pentagon on it.

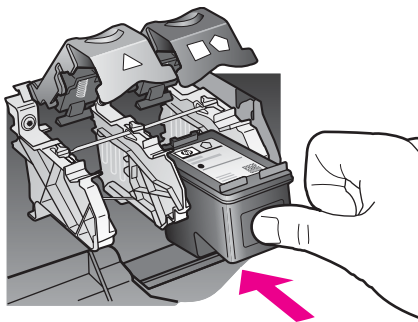

- 8 Press down on the latch until it stops. Make sure the latch catches below the bottom tabs.

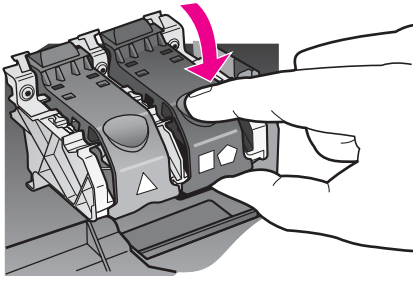

- 9 Close the print-carriage access door.

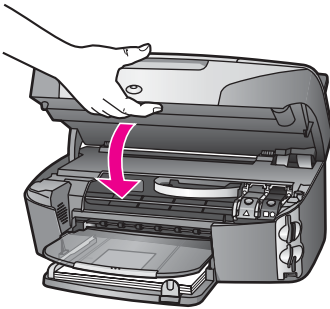

### Use a photo print cartridge

You can optimize the quality of the color photos you print and copy with your HP all-in-one by purchasing a photo print cartridge. Remove the black print cartridge and insert the photo print cartridge in its place. With the tri-color print cartridge and photo print cartridge installed, you have a six-ink system, which provides enhanced quality color photos.

When you want to print regular text documents, swap the black print cartridge back in. Use a print cartridge protector to keep your print cartridge secure when it is not being used.

- For more information on purchasing a photo print cartridge, see [Order print cartridges](#).
- For more information on replacing print cartridges, see [Replace the print cartridges](#).
- For more information on using the print cartridge protector, see [Use the print cartridge protector](#).

### Use a gray photo print cartridge

You can optimize the quality of the black-and-white photos you print and copy with your HP all-in-one by purchasing a gray photo print cartridge. Remove the black print cartridge and insert the gray photo print cartridge in its place. With the tri-color print cartridge and gray photo print cartridge installed, you can print a full range of gray tones, which provides enhanced quality black-and-white photos.

When you want to print regular text documents, swap the black print cartridge back in. Use a print cartridge protector to keep your print cartridge secure when it is not being used.

- For more information on purchasing a gray photo print cartridge, see [Order print cartridges](#).
- For more information on replacing print cartridges, see [Replace the print cartridges](#).
- For more information on using the print cartridge protector, see [Use the print cartridge protector](#).

## Use the print cartridge protector

In some countries/regions, when you purchase a photo print cartridge, you might also receive a print cartridge protector. In other countries/regions, a print cartridge protector comes in the box with your HP all-in-one. If neither your print cartridge nor your HP all-in-one came with a print cartridge protector, you can order one from HP Support. Go to [www.hp.com/support](http://www.hp.com/support).

The print cartridge protector is designed to keep a print cartridge secure and prevent it from drying out when it is not being used. Whenever you remove a print cartridge from the HP all-in-one with the intention of using it again later, store it in the print cartridge protector. For example, store the black print cartridge in a print cartridge protector if you are removing it so you can print high-quality photos with the photo and tri-color print cartridges.

### To insert a print cartridge into the print cartridge protector

- Slide the print cartridge into the print cartridge protector at a slight angle and snap it securely into place.

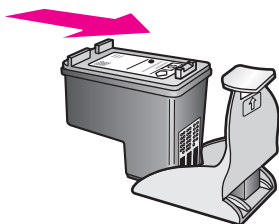

### To remove the print cartridge from the print cartridge protector

- Press down and back on the top of the print cartridge protector to release the print cartridge, then slide the print cartridge out of the print cartridge protector.

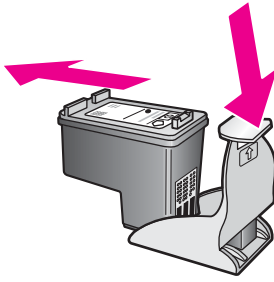

## Align the print cartridges

The HP all-in-one prompts you to align cartridges every time you install or replace a print cartridge. You can also align the print cartridges at any time from the control panel or by using the **HP Image Zone** software on your computer. Aligning the print cartridges ensures high-quality output.

**Note** If you remove and reinstall the same print cartridge, the HP all-in-one will not prompt you to align the print cartridges. The HP all-in-one remembers the alignment values for that print cartridge, so you do not need to realign the print cartridges.

### To align the print cartridges from the control panel when prompted

- Make sure you have letter or A4 unused plain white paper loaded in the input tray, and then press **OK**.

The HP all-in-one prints a print cartridge alignment sheet and aligns the print cartridges. Recycle or discard the page.

**Note** If you have colored paper loaded in the input tray when you align the print cartridges, the alignment will fail. Load unused plain white paper into the input tray, and then try the alignment again.

If the alignment fails again, you might have a defective sensor or print cartridge. Contact HP Support. Go to [www.hp.com/support](http://www.hp.com/support). If prompted, choose your country/region, and then click **Contact HP** for information on calling for technical support.

### To align the cartridges from the control panel at any other time

- 1 Load letter or A4 unused plain white paper into the input tray.
- 2 Press **Setup**.
- 3 Press **6**, then press **2**.

This displays the **Tools** menu and then selects **Align Print Cartridge**.

The HP all-in-one prints a print cartridge alignment sheet and aligns the print cartridges. Recycle or discard the page.

For information on aligning the print cartridges by using the **HP Image Zone** software that came with your HP all-in-one, see the onscreen **HP Image Zone Help** that came with your software.

## Clean the print cartridges

Use this feature when the self-test report shows streaking or white lines through any of the lines of color. Do not clean print cartridges unnecessarily, as this wastes ink and shortens the life of the ink nozzles.

### To clean the print cartridges from the control panel

- 1 Load letter or A4 unused plain white paper into the input tray.
- 2 Press **Setup**.
- 3 Press **6**, then press **1**.

This displays the **Tools** menu and then selects **Clean Print Cartridge**.

The HP all-in-one prints a page that you can recycle or discard.

If copy or print quality still seem poor after you clean the print cartridges, try cleaning the print cartridge contacts before replacing the affected print cartridge.

For information on cleaning the print cartridge contacts, see [Clean the print cartridge contacts](#). For information on replacing the print cartridges, see [Replace the print cartridges](#).

For information on cleaning the print cartridges by using the **HP Image Zone** software that came with your HP all-in-one, see the onscreen **HP Image Zone Help** that came with your software.

## Clean the print cartridge contacts

Clean the print cartridge contacts only if you get repeated messages on the color graphics display prompting you to check a print cartridge after you already have cleaned or aligned the print cartridges.

Before cleaning the print cartridge contacts, remove the print cartridge and verify that nothing is covering the print cartridge contacts, then reinstall the print cartridge. If you continue to get messages to check the print cartridges, clean the print cartridge contacts.

Make sure you have the following materials available:

- Dry foam rubber swabs, lint-free cloth, or any soft material that will not come apart or leave fibers.
- Distilled, filtered, or bottled water (tap water might contain contaminants that can damage the print cartridges).



**Warning** Do **not** use platen cleaners or alcohol to clean the print cartridge contacts. These can damage the print cartridge or the HP all-in-one.

### To clean the print cartridge contacts

- 1 Turn on the HP all-in-one and open the print-carriage access door. The print carriage is on the far right side of the HP all-in-one.
- 2 Wait until the print carriage is idle and silent, and then unplug the power cord from the back of the HP all-in-one.

**Note** When you unplug the power cord, the date and time are erased. You will need to reset the date and time later, when you plug the power cord back in. For more information, see [Set the date and time](#). Any faxes stored in memory are also erased.

- 3 Lift one of the latches to the open position, and then remove the print cartridge.



**Note** Do not remove both print cartridges at the same time. Remove and clean each print cartridge one at a time. Do not leave a print cartridge outside the HP all-in-one for more than 30 minutes.

- 4 Inspect the print cartridge contacts for ink and debris buildup.
- 5 Dip a clean foam rubber swab or lint-free cloth into distilled water, and squeeze any excess water from it.
- 6 Hold the print cartridge by its sides.
- 7 Clean only the copper-colored contacts. For information on cleaning the ink nozzle area, see [Clean the area around the ink nozzles](#).

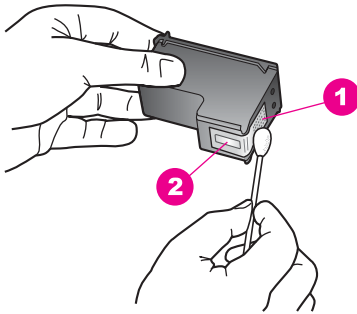

1	Copper-colored contacts
2	Ink nozzles (do not clean)

- 8 Place the print cartridge back into the print carriage slot and close the latch.
- 9 Repeat if necessary for the other print cartridge.
- 10 Gently close the print-carriage access door and plug the power cord into the back of the HP all-in-one.

### Clean the area around the ink nozzles

If the HP all-in-one is used in a dusty environment, a small amount of debris might accumulate inside the device. This debris can include dust, hair, carpet, or clothing fibers. When debris gets on the print cartridges, it can cause ink streaks and smudges on printed pages. Ink streaking can be corrected by cleaning around the ink nozzles as described here.

**Note** Clean the area around the ink nozzles only if you continue to see streaks and smudges on your printed pages after you have already cleaned the print cartridges by using the control panel or the **HP Image Zone**. For more information, see [Clean the print cartridges](#).

Make sure you have the following materials available:

- Dry foam rubber swabs, lint-free cloth, or any soft material that will not come apart or leave fibers.
- Distilled, filtered, or bottled water (tap water might contain contaminants that can damage the print cartridges).



**Warning** Do **not** touch the copper-colored contacts or ink nozzles. Touching these parts can result in clogs, ink failure, and bad electrical connections.

## To clean the area around the ink nozzles

- 1 Turn on the HP all-in-one and open the print-carriage access door. The print carriage is on the far right side of the HP all-in-one.
- 2 Wait until the print carriage is idle and silent, and then unplug the power cord from the back of the HP all-in-one.

**Note** When you unplug the power cord, the date and time are erased. You will need to reset the date and time later, when you plug the power cord back in. For more information, see [Set the date and time](#). Any faxes stored in memory are also erased.

- 3 Lift one of the latches to the open position, and then remove the print cartridge.

**Note** Do not remove both print cartridges at the same time. Remove and clean each print cartridge one at a time. Do not leave a print cartridge outside the HP all-in-one for more than 30 minutes.

- 4 Place the print cartridge on a piece of paper with the ink nozzles facing up.
- 5 Lightly moisten a clean foam rubber swab with distilled water.
- 6 Clean the face and edges around the ink nozzle area with the swab, as shown below.

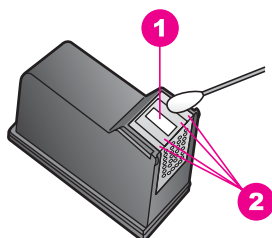

1	Nozzle plate (do not clean)
2	Face and edges around the ink nozzle area



**Warning** Do **not** clean the nozzle plate.

- 7 Place the print cartridge back into the print carriage slot and close the latch.
- 8 Repeat if necessary for the other print cartridge.
- 9 Gently close the print-carriage access door and plug the power cord into the back of the HP all-in-one.

## Change the device settings

You can change the power save time and prompt delay time settings on your HP all-in-one so that it behaves according to your preference. You can also restore the device settings to what they were when you purchased your device. This will erase any new defaults you have set.

### Set the power save time

The light bulb in the scanner of your HP all-in-one remains on for a specified period so that the HP all-in-one is immediately ready to respond to your request. When the

HP all-in-one has not been used within that specified period, it turns the light bulb off to preserve power. You can exit this mode by pressing any button on the control panel.

Your HP all-in-one is automatically set to enter power save mode after 12 hours. Follow these steps if you want the HP all-in-one to enter this mode earlier.

- 1 Press **Setup**.
- 2 Press **7**, then press **2**.  
This displays the **Preferences** menu and then selects **Set Power Save Mode Time**.
- 3 Press **▼** to select the appropriate time, then press **OK**.  
You can choose 1, 4, 8, or 12 hours for the power save time.

### Set the prompt delay time

The **Prompt Delay Time** option allows you to control the amount of time that passes before a message prompts you to take further action. For example, if you press **Copy** and the prompt delay time passes without you pressing another button, the message "Press **START** to copy. Press **Number** or **OK** to select." appears in the color graphics display. You can choose **Fast**, **Normal**, **Slow**, or **Off**. If you select **Off**, hints will not appear on the color graphics display but other messages, such as low ink warnings and error messages, will still appear.

- 1 Press **Setup**.
- 2 Press **7**, then press **3**.  
This displays the **Preferences** menu and then selects **Set Prompt Delay Time**.
- 3 Press **▼** to select a delay time, then press **OK**.

### Restore the factory defaults

You can restore the original factory settings to what they were when you purchased your HP all-in-one.

**Note** Restoring the factory defaults will not change the date information you set, nor will it affect any changes you made to scan settings and the language and country/region settings.

You can perform this process from the control panel only.

- 1 Press **Setup**.
- 2 Press **6**, then press **3**.  
This displays the **Tools** menu and then selects **Restore Factory Defaults**.  
The factory default settings are restored.

## Self-maintenance sounds

The HP all-in-one might make noises after long periods (approximately 2 weeks) of inactivity. This is normal operation and is necessary to ensure the HP all-in-one produces the best quality printouts.

# 16 Troubleshooting information

This chapter contains troubleshooting information for the HP all-in-one. Specific information is provided for installation and configuration issues, and some operational topics. For more troubleshooting information, see the onscreen **HP Image Zone Help** file that came with your software.

Many issues are caused when the HP all-in-one is connected to the computer using a USB cable before the HP all-in-one software is installed on the computer. If you connected the HP all-in-one to your computer before the software installation screen prompts you to do so, you must follow these steps:

- 1 Disconnect the USB cable from the computer.
- 2 Uninstall the software (if you have already installed it).
- 3 Restart your computer.
- 4 Turn off the HP all-in-one, wait one minute, then restart it.
- 5 Reinstall the HP all-in-one software. Do not connect the USB cable to the computer until prompted by the software installation screen.

For information about uninstalling and reinstalling the software, see [Uninstall and reinstall the software](#).

This section contains the following topics:

- **Setup troubleshooting:** Contains information on hardware setup, software installation, fax setup, and HP Instant Share setup troubleshooting information.
- **Operational troubleshooting:** Contains information on issues that may occur during normal tasks when using the HP all-in-one features.
- **Device update:** Based on advice from HP customer support or a message on the color graphics display, you might access the HP support website to retrieve an upgrade for your device. This section contains information about updating your device.

## Before you call HP Support

If you have a problem, follow these steps:

- 1 Check the documentation that came with the HP all-in-one.
  - **Setup Guide:** The Setup Guide explains how to set up the HP all-in-one.
  - **User Guide:** The User Guide is the book you are reading. This book describes the basic features of the HP all-in-one, explains how to use the HP all-in-one without connecting it to a computer, and contains setup and operational troubleshooting information.
  - **HP Image Zone Help:** The onscreen **HP Image Zone Help** describes how to use the HP all-in-one with a computer and contains additional troubleshooting information not covered in the User Guide.

- **Readme file:** The Readme file contains information on possible installation problems and system requirements. For more information, see [View the Readme file](#).
  - **Network Guide:** The Network Guide explains how to set up your HP all-in-one on a network.
- 2 If you are unable to solve the problem using the information in the documentation, visit [www.hp.com/support](http://www.hp.com/support) to do the following:
    - Access online support pages.
    - Send HP an e-mail message for answers to your questions.
    - Connect with an HP technician by using online chat.
    - Check for software updates.

Support options and availability vary by product, country/region, and language.
  - 3 Contact your local point of purchase. If the HP all-in-one has a hardware failure, you will be asked to bring the HP all-in-one to where you purchased it. Service is free during the HP all-in-one limited warranty period. After the warranty period, you will be quoted a service charge.
  - 4 If you are unable to solve the problem using the onscreen Help or HP websites, call HP Support using the number for your country/region. For more information, see [Get HP support](#).

## View the Readme file

You might want to refer to the Readme file for more information on possible installation problems and system requirements.

- In Windows, you can access the Readme file from Windows taskbar by clicking **Start**, pointing to **Programs** or **All Programs**, pointing to **Hewlett-Packard**, pointing to **HP Photosmart 2600/2700 series all-in-one**, and then clicking **View the Readme File**.
- In Macintosh OS 9 or OS X, you can access the Readme file by double-clicking the icon located in the top-level folder of the HP all-in-one software CD-ROM.

## Setup troubleshooting

This section includes installation and configuration troubleshooting tips for some of the most common issues associated with hardware, software, fax, and **HP Instant Share** features of the HP all-in-one.

### Hardware setup troubleshooting

Use this section to solve any problems you might encounter while setting up the HP all-in-one hardware.

#### My HP all-in-one does not turn on

##### Solution

Make sure each of the power cords is firmly connected, and wait a few seconds for the HP all-in-one to turn on. If this is the first time you have turned on the HP all-in-one, it can take up to a minute to turn on. Also, if the HP all-in-one is plugged in to a power strip, make sure the power strip is turned on.

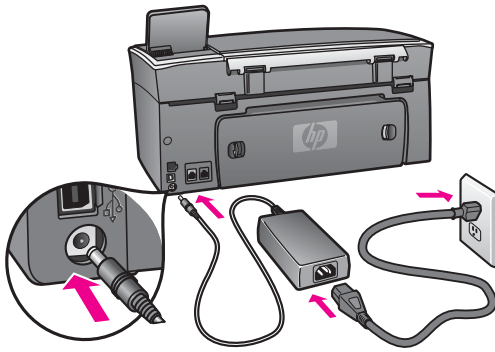

I connected the USB cable, but I am having problems using the HP all-in-one with my computer

### Solution

You must first install the software that came with your HP all-in-one before connecting the USB cable. During installation, do not plug in the USB cable until prompted by the onscreen instructions. Connecting the USB cable before prompted can cause errors.

Once you have installed the software, connecting your computer to your HP all-in-one with a USB cable is straightforward. Simply plug one end of the USB cable into the back of your computer and the other into the back of the HP all-in-one. You can connect to any USB port on the back of your computer.

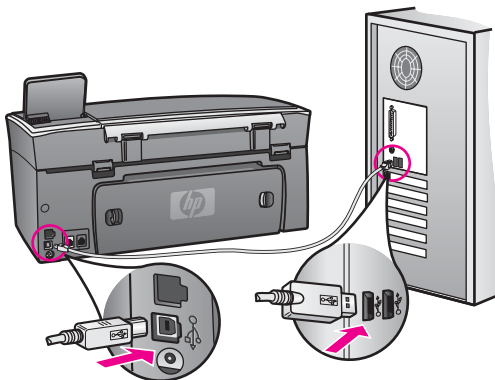

I received a message on the color graphics display to attach the control panel overlay

### Solution

This might mean the control panel overlay is not attached, or it is attached incorrectly. Make sure to align the overlay over the buttons on the top of the HP all-in-one and snap it firmly into place.

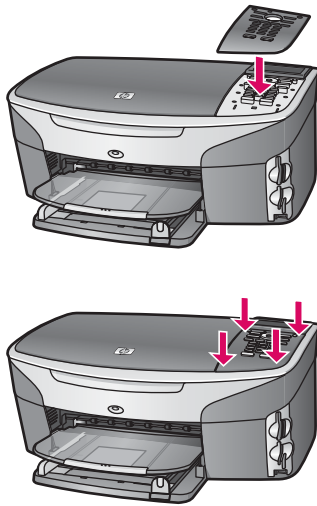

### The color graphics display shows the wrong language

#### Solution

Usually, you set the language and country/region when you first set up the HP all-in-one. However, you can change these settings at any time by using the following procedure:

- 1 Press **Setup**.
- 2 Press **7**, and then press **1**.  
This selects **Preferences**, and then selects **Set Language & Country/Region**. A list of languages appears. You can scroll through the list of languages by pressing the **▲** and **▼** arrows.
- 3 When your language is highlighted, press **OK**.
- 4 When prompted, press **1** for Yes or **2** for No.  
The countries/regions for the selected language appear. Press **▲** or **▼** to scroll through the list.
- 5 When the language you want to select is highlighted, press **OK**.
- 6 When prompted, press **1** for Yes or **2** for No.

### The wrong measurements are showing in menus on the color graphics display

#### Solution

You may have selected the incorrect country/region when setting up your HP all-in-one. The country/region you select determines the paper sizes shown on the color graphics display.

To change the country/region, you must first set the default language again. Usually, you set the language and country/region when you first set up the HP all-in-one. However, you can change these settings at any time by using the following procedure:

- 1 Press **Setup**.
- 2 Press **7**, and then press **1**.  
This selects **Preferences**, and then selects **Set Language & Country/Region**.

- A list of languages appears. You can scroll through the list of languages by pressing the ▲ and ▼ arrows.
- 3 When your language is highlighted, press **OK**.
  - 4 When prompted, press **1** for Yes or **2** for No.  
The countries/regions for the selected language appear. Press ▲ or ▼ to scroll through the list.
  - 5 When the language you want to select is highlighted, press **OK**.
  - 6 When prompted, press **1** for Yes or **2** for No.

### I received a message on the color graphics display to align the print cartridges

#### Solution

The HP all-in-one prompts you to align cartridges every time you install a new print cartridge. For more information, see [Align the print cartridges](#).

**Note** If you remove and reinstall the same print cartridge, the HP all-in-one will not prompt you to align the print cartridges. The HP all-in-one remembers the alignment values for that print cartridge, so you do not need to realign the print cartridges.

### I received a message on the color graphics display that the print cartridge alignment failed

#### Cause

The incorrect type of paper is loaded in the input tray.

#### Solution

If you have colored paper loaded in the input tray when you align the print cartridges, the alignment fails. Load unused plain white letter or A4 paper into the input tray, and then try the alignment again.

If the alignment fails again, you might have a defective sensor or print cartridge. Contact HP Support. Go to [www.hp.com/support](http://www.hp.com/support). If prompted, choose your country/region, and then click **Contact HP** for information on calling for technical support.

---

#### Cause

Protective tape is covering the print cartridges.

#### Solution

Check each print cartridge. If the plastic tape is still covering the ink nozzles, gently remove the plastic tape by using the pink pull tab. Do not touch the ink nozzles or the copper-colored contacts.



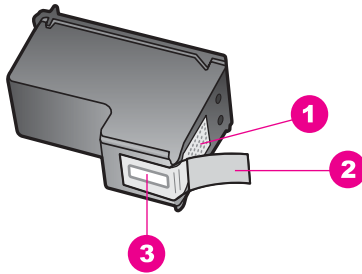

1	Copper-colored contacts
2	Plastic tape with pink pull tab (must be removed before installing)
3	Ink nozzles under tape



Reinsert the print cartridges and verify that they are fully inserted and locked in place.

### Cause

The contacts on the print cartridge are not touching the contacts in the print carriage.

### Solution

Remove and then reinsert the print cartridges. Verify that they are fully inserted and locked in place.

### Cause

The print cartridge or sensor is defective.

### Solution

Contact HP Support. Go to [www.hp.com/support](http://www.hp.com/support). If prompted, choose your country/region, and then click **Contact HP** for information on calling for technical support.

## The HP all-in-one does not print

### Solution

If your HP all-in-one and computer are not communicating with each other, try the following:

- Check the USB cable. If you are using an older cable, it might not be working properly. Try connecting it to another product to see if the USB cable works. If

you experience problems, the USB cable might need to be replaced. Also verify that the cable does not exceed 3 meters (9.8 feet) in length.

- Make sure your computer is USB ready. Some operating systems, such as Windows 95 and Windows NT, do not support USB connections. Check the documentation that came with your operating system for more information.
- Check the connection from your HP all-in-one to your computer. Verify that the USB cable is securely plugged into the USB port on the back of your HP all-in-one. Make sure the other end of the USB cable is plugged into a USB port on your computer. After the cable is connected properly, turn your HP all-in-one off and then on again.

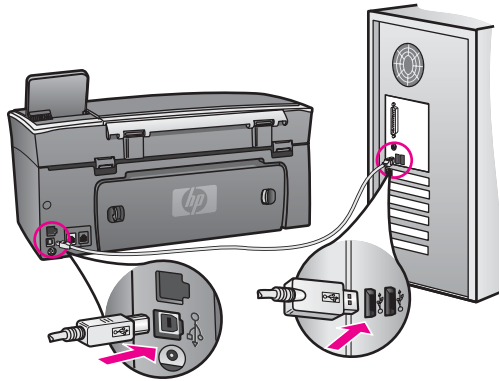

- Check other printers or scanners. You might need to disconnect older products from your computer.
- If your HP all-in-one is networked, see the Network Guide that came with your HP all-in-one.
- After you check the connections, try restarting your computer. Turn your HP all-in-one off and then on again.
- If necessary, remove and then install the **HP Image Zone** software again. For more information, see [Uninstall and reinstall the software](#).

For more information on setting up your HP all-in-one and connecting it to your computer, see the Setup Guide that came with your HP all-in-one.

### I received a message on the color graphics display about a paper jam or a blocked carriage

#### Solution

If either a paper jam or blocked carriage error message appears on the color graphics display, there might be some packing material inside the HP all-in-one. Lift open the print-carriage access door to expose the print cartridges and remove any packing material (such as tape or cardboard) or any other foreign objects blocking the carriage path.

### Software installation troubleshooting

If you encounter a problem during software installation, see the topics below for a possible solution. If you encounter a hardware problem during setup, see [Hardware setup troubleshooting](#).

During a normal installation of the HP all-in-one software, the following events occur:

- 1 The HP all-in-one CD-ROM runs automatically.
- 2 The software installs.
- 3 Files are copied to your hard drive.
- 4 You are requested to connect the HP all-in-one to your computer.
- 5 A green OK and check mark appear on an installation wizard screen.
- 6 You are requested to restart your computer.
- 7 The Fax Setup wizard runs.
- 8 The registration process runs.

If any of these things did not occur, there might be a problem with the installation. To check the installation on a PC, verify the following:

- Start the **HP Director** and check to make sure the following icons appear: **Scan Picture**, **Scan Document**, **Send Fax** and **HP Gallery**. For information on starting **HP Director**, see the onscreen **HP Image Zone Help** that came with your software. If the icons do not appear immediately, you might need to wait a few minutes for the HP all-in-one to connect to your computer. Otherwise, see [Some of the icons are missing in the HP Director](#).

**Note** If you performed a minimum installation of the software (as apposed to a typical installation), the **HP Image Zone** and **Copy** are not installed and will not be available from the **HP Director**.

- Open the Printers dialog box and check to see that the HP all-in-one is listed.
- Look in the system tray at the far right of the Windows taskbar for an HP all-in-one icon. This indicates that the HP all-in-one is ready.

### When I insert the CD-ROM into my computer's CD-ROM drive, nothing happens

#### Solution

Do the following:

- 1 From the Windows **Start** menu, click **Run**.
- 2 In the **Run** dialog box, enter **d:\setup.exe** (if your CD-ROM drive is not assigned to drive letter D, enter the appropriate drive letter), and then click **OK**.

### The minimum system checks screen appears

#### Solution

Your system does not meet the minimum requirements to install the software. Click **Details** to see what the specific problem is, and then correct the problem before attempting to install the software.

### A red X appears on the USB connect prompt

#### Solution

Normally, a green check appears indicating that the plug and play is successful. A red X indicates that the plug and play failed.

Do the following:

- 1 Verify that the control panel overlay is firmly attached, unplug the HP all-in-one power cord, and then plug it in again.
- 2 Verify that the USB and power cables are plugged in.

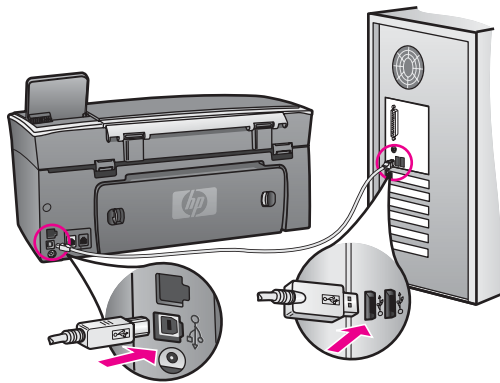

- 3 Click **Retry** to retry the plug and play setup. If this does not work, continue to the next step.
- 4 Verify that the USB cable is set up properly as follows:
  - Unplug the USB cable and plug it in again.
  - Do not attach the USB cable to a keyboard or non-powered hub.
  - Verify that the USB cable is 3 meters or less in length.
  - If you have several USB devices attached to your computer, you might want to unplug the other devices during the installation.
- 5 Continue with the installation and restart the computer when prompted. Then open **HP Director** and check for the essential icons (**Scan Picture**, **Scan Document**, **Send Fax**, and **HP Gallery**).
- 6 If the essential icons do not appear, remove the software and then reinstall it. For more information, see [Uninstall and reinstall the software](#).

### I received a message that an unknown error has occurred

#### Solution

Try to continue with the installation. If that doesn't work, stop and then restart the installation, and follow the directions on the screen. If an error occurs, you might need to uninstall and then reinstall the software. Do not simply delete the HP all-in-one program files from your hard drive. Make sure to remove them properly using the uninstall utility provided in the HP all-in-one program group.

For more information, see [Uninstall and reinstall the software](#).

### Some of the icons are missing in the HP Director

If the essential icons (**Scan Picture**, **Scan Document**, **Send Fax**, and **HP Gallery**) do not appear, your installation might not be complete.

#### Solution

If your installation is incomplete, you might need to uninstall and then reinstall the software. Do not simply delete the HP all-in-one program files from your hard drive. Make sure to remove them properly using the uninstall utility provided in the HP all-in-one program group. For more information, see [Uninstall and reinstall the software](#).

### The fax wizard does not start

### Solution

Launch the fax wizard as follows:

- 1 Start the **HP Director**. For more information, see the onscreen **HP Image Zone Help** that came with your software.
- 2 Click the **Settings** menu, select **Fax Settings and Setup**, then select **Fax Setup Wizard**.

### The registration screen does not appear

#### Solution

- In Windows, you can access the registration screen from the Windows taskbar by clicking Start, pointing to **Programs** or **All Programs (XP)**, **Hewlett-Packard, HP Photosmart 2600/2700 series all-in-one**, and then clicking **Sign up now**.

### The Digital Imaging Monitor does not appear in the system tray

#### Solution

If the Digital Imaging Monitor does not appear in the system tray, start the **HP Director** to check whether or not essential icons are there. For more information about starting the **HP Director**, see the onscreen **HP Image Zone Help** that came with your software.

For more information about missing essential icons in the **HP Director**, see [Some of the icons are missing in the HP Director](#).

The system tray normally appears in the lower-right corner of the desktop.



### Uninstall and reinstall the software

If your installation is incomplete, or if you connected the USB cable to the computer before prompted by the software installation screen, you might need to uninstall and then reinstall the software. Do not simply delete the HP all-in-one program files from your hard drive. Make sure to remove them properly using the uninstall utility provided in the HP all-in-one program group.

A reinstall can take from 20 to 40 minutes for both Windows and Macintosh computers. There are three methods to uninstall the software on a Windows computer.

#### To uninstall from a Windows computer, method 1

- 1 Disconnect your HP all-in-one from your computer. Do not connect the HP all-in-one to your computer until after you have reinstalled the software.
- 2 Press the **On** button to turn off the HP all-in-one.
- 3 On the Windows taskbar, click **Start**, **Start Programs** or **All Programs (XP)**, **Hewlett-Packard, HP Photosmart 2600/2700 series all-in-one, uninstall software**.
- 4 Follow the onscreen instructions.
- 5 If you are asked whether you would like to remove shared files, click **No**. Other programs that use these files might not work properly if the files are deleted.

- Restart your computer.

**Note** It is important that you disconnect your HP all-in-one before restarting your computer. Do not connect the HP all-in-one to your computer until after you have reinstalled the software.

- To reinstall the software, insert the HP all-in-one CD-ROM into your computer's CD-ROM drive, and follow the onscreen instructions and the instructions provided in the Setup Guide that came with your HP all-in-one.
- After the software is installed, connect the HP all-in-one to your computer.
- Press the **On** button to turn the HP all-in-one on.  
After connecting and turning on your HP all-in-one, you might have to wait several minutes for all of the Plug and Play events to complete.
- Follow the onscreen instructions.

When the software installation is complete, the Status Monitor icon appears in the Windows system tray.

To verify that the software is properly installed, double-click the **HP Director** icon on the desktop. If the **HP Director** shows the key icons (**Scan Picture**, **Scan Document**, **Send Fax**, and **HP Gallery**), the software has been properly installed.

### To uninstall from a Windows computer, method 2

**Note** Use this method if **Uninstall Software** is not available in the Windows Start menu.

- On the Windows taskbar, click **Start, Settings, Control Panel**.
- Double-click **Add/Remove Programs**.
- Select **HP all-in-one & Officejet 4.0**, and then click **Change/Remove**.  
Follow the onscreen instructions.
- Disconnect your HP all-in-one from your computer.
- Restart your computer.

**Note** It is important that you disconnect your HP all-in-one before restarting your computer. Do not connect the HP all-in-one to your computer until after you have reinstalled the software.

- Launch setup.
- Follow the onscreen instructions and the instructions provided in the Setup Guide that came with your HP all-in-one.

### To uninstall from a Windows computer, method 3

**Note** This is an alternate method if **Uninstall Software** is not available in the Windows Start menu.

- Run the HP Photosmart 2600/2700 series all-in-one software Setup program.
- Select **Uninstall** and follow the onscreen directions.
- Disconnect your HP all-in-one from your computer.
- Restart your computer.

**Note** It is important that you disconnect your HP all-in-one before restarting your computer. Do not connect the HP all-in-one to your computer until after you have reinstalled the software.

- 5 Run the HP Photosmart 2600/2700 series all-in-one software Setup program again.
- 6 Launch **Reinstall**.
- 7 Follow the onscreen instructions and the instructions provided in the Setup Guide that came with your HP all-in-one.

### To uninstall from a Macintosh computer

- 1 Disconnect the HP all-in-one from your Macintosh.
- 2 Double-click the **Applications: HP All-in-One Software** folder.
- 3 Double-click **HP Uninstaller**.  
Follow the onscreen instructions.
- 4 After the software is uninstalled, disconnect your HP all-in-one, and then restart your computer.

**Note** It is important that you disconnect your HP all-in-one before restarting your computer. Do not connect the HP all-in-one to your computer until after you have reinstalled the software.

- 5 To reinstall the software, insert the HP all-in-one CD-ROM into your computer's CD-ROM drive.
- 6 On the desktop, open the CD-ROM and then double-click **HP all-in-one installer**.
- 7 Follow the onscreen instructions and the instructions provided in the Setup Guide that came with your HP all-in-one.

### Fax setup troubleshooting

This section contains fax setup troubleshooting information for the HP all-in-one. If your HP all-in-one is not set up properly for faxing, you might experience problems when sending faxes, receiving faxes, or both.

**Tip** This section contains only setup-related troubleshooting. For additional fax troubleshooting topics, such as problems with your printouts or slow fax reception, see the onscreen Troubleshooting Help that came with your **HP Image Zone** software.

If you are having faxing problems, you can print a fax test report to check the status of your HP all-in-one. The test will fail if your HP all-in-one is not set up properly for faxing. Perform this test after you have completed setting up your HP all-in-one for faxing.

### To test your fax setup

- 1 Press **Setup**.
- 2 Press **6**, and then press **5**.  
This displays the **Tools** menu and then selects **Run Fax Test**.  
The HP all-in-one displays the status of the test on the color graphics display and prints a report.

- 3 Review the report.
  - If the test passes and you are still having problems faxing, check the fax settings listed in the report to verify the settings are correct. A blank or incorrect fax setting can cause faxing problems.
  - If the test fails, review the report for information on how to fix any problems found. For more information, you can also see the next section, [The fax test failed](#).
- 4 Press **OK** to return to the **Setup Menu**.

If you are still experiencing faxing problems, continue with the following sections for more troubleshooting help.

### The fax test failed

If you ran a fax test and the test failed, review the report for basic information about the error. For more detailed information, check the report to see which part of the test failed, and then navigate to the appropriate topic in this section for information:

- [The fax hardware test failed](#)
- [The fax connected to active telephone wall jack test failed](#)
- [The phone cord connected to correct port on fax test failed](#)
- [The fax line condition test failed](#)
- [The dial tone detection test failed](#)

### The fax hardware test failed

#### Solution

- Turn off the HP all-in-one by using the **On** button located on the control panel and then unplug the power cord from the back of the HP all-in-one. After a few seconds, plug the power cord back in and turn the power on. Run the test again. If the test fails again, continue reviewing the troubleshooting information in this section.
- Try to send or receive a test fax. If you can send or receive a fax successfully, there might not be a problem.
- If you have a Windows computer and are running the test from the **Fax Setup Wizard**, make sure the HP all-in-one is not busy completing another task, such as receiving a fax or making a copy. Check the color graphics display for a message indicating that the HP all-in-one is busy. If it is busy, wait until it is finished and in the idle state, before running the test.

After you resolve any problems found, run the fax test again to make sure it passes and your HP all-in-one is ready for faxing. If the **Fax Hardware Test** continues to fail and you experience problems faxing, contact HP for support. For information on contacting HP for support, see [Get HP support](#).

### The fax connected to active telephone wall jack test failed

#### Solution

- Check the connection between the telephone wall jack and the HP all-in-one to make sure the phone cord is secure.
- Make sure you use the phone cord that came with your HP all-in-one. If you do not use the supplied phone cord to connect from the telephone wall jack to your HP all-in-one, you may not be able to send or receive faxes. After you



plug in the phone cord that came with your HP all-in-one, run the fax test again.

- Make sure you have correctly connected the HP all-in-one to the telephone wall jack. Using the phone cord supplied in the box with your HP all-in-one, connect one end to your telephone wall jack, then connect the other end to the port labeled "1-LINE" on the back of your HP all-in-one. For more information on setting up your HP all-in-one for faxing, see [Fax setup](#).
- If you are using a phone splitter, this can cause faxing problems. (A splitter is a two-cord connector that plugs into a telephone wall jack.) Try removing the splitter and connecting the HP all-in-one directly to the telephone wall jack.
- Try connecting a working phone and phone cord to the telephone wall jack that you are using for the HP all-in-one and check for a dial tone. If you do not hear a dial tone, contact your telephone company and have them check the line.
- Try to send or receive a test fax. If you can send or receive a fax successfully, there might not be a problem.

After you resolve any problems found, run the fax test again to make sure it passes and your HP all-in-one is ready for faxing.

### The phone cord connected to correct port on fax test failed

#### Solution

The phone cord is plugged into the wrong port on the back of the HP all-in-one.

- 1 Using the phone cord supplied in the box with your HP all-in-one, connect one end to your telephone wall jack, then connect the other end to the port labeled "1-LINE" on the back of your HP all-in-one.

**Note** If you use the "2-EXT" port to connect to the telephone wall jack, you will not be able to send or receive faxes. The "2-EXT" port should only be used to connect other equipment, such as an answering machine or a telephone.

- 2 After you have connected the phone cord to the port labeled "1-LINE", run the fax test again to make sure it passes and your HP all-in-one is ready for faxing.
- 3 Try to send or receive a test fax.

### The fax line condition test failed

#### Solution

- Make sure you connect your HP all-in-one to an analog phone line or you will not be able to send or receive faxes. To check if your phone line is digital, connect a regular analog phone to the line and listen for a dial tone. If you do not hear a normal sounding dial tone, it might be a phone line set up for digital phones. Connect your HP all-in-one to an analog phone line and try sending or receiving a fax.
- Check the connection between the telephone wall jack and the HP all-in-one to make sure the phone cord is secure.
- Make sure you have correctly connected the HP all-in-one to the telephone wall jack. Using the phone cord supplied in the box with your HP all-in-one, connect one end to your telephone wall jack, then connect the other end to the

port labeled "1-LINE" on the back of your HP all-in-one. For more information on setting up your HP all-in-one for faxing, see [Fax setup](#).

- Other equipment, which uses the same phone line as the HP all-in-one, might be causing the test to fail. To find out if other equipment is causing a problem, disconnect everything from the phone line, and then run the test again.
  - If the **Fax Line Condition Test** passes without the other equipment, then one or more pieces of the equipment is causing problems; try adding them back one at a time and rerunning the test each time, until you identify which piece of equipment is causing the problem.
  - If the **Fax Line Condition Test** fails without the other equipment, connect the HP all-in-one to a working phone line and continue reviewing the troubleshooting information in this section.
- If you are using a phone splitter, this can cause faxing problems. (A splitter is a two-cord connector that plugs into a telephone wall jack.) Try removing the splitter and connecting the HP all-in-one directly to the telephone wall jack.

After you resolve any problems found, run the fax test again to make sure it passes and your HP all-in-one is ready for faxing. If the **Fax Line Condition** test continues to fail and you experience problems faxing, contact your telephone company and have them check the phone line.

## The dial tone detection test failed

### Solution

- Other equipment, which uses the same phone line as the HP all-in-one, might be causing the test to fail. To find out if other equipment is causing a problem, disconnect everything from the phone line, and then run the test again. If the **Dial Tone Detection Test** passes without the other equipment, then one or more pieces of the equipment is causing problems; try adding them back one at a time and rerunning the test each time, until you identify which piece of equipment is causing the problem.
- Try connecting a working phone and phone cord to the telephone wall jack that you are using for the HP all-in-one and check for a dial tone. If you do not hear a dial tone, contact your telephone company and have them check the line.
- Make sure you have correctly connected the HP all-in-one to the telephone wall jack. Using the phone cord supplied in the box with your HP all-in-one, connect one end to your telephone wall jack, then connect the other end to the port labeled "1-LINE" on the back of your HP all-in-one. For more information on setting up your HP all-in-one for faxing, see [Fax setup](#).
- If you are using a phone splitter, this can cause faxing problems. (A splitter is a two-cord connector that plugs into a telephone wall jack.) Try removing the splitter and connecting the HP all-in-one directly to the telephone wall jack.
- If your telephone system is not using a standard dial tone, such as some PBX systems, this may cause the test to fail. This will not cause a problem sending or receiving faxes. Try sending or receiving a test fax.
- Check to make sure the country/region setting is set appropriately for your country/region. If the country/region setting is not set or is not set correctly, the test may fail and you might have problems sending and receiving faxes. To check the setting, press **Setup** and then press **7**. The language and country/region settings appear on the color graphics display. If the country/region

setting is incorrect, press **OK** and follow the prompts on the color graphics display to change it.

- Make sure you connect your HP all-in-one to an analog phone line or you will not be able to send or receive faxes. To check if your phone line is digital, connect a regular analog phone to the line and listen for a dial tone. If you do not hear a normal sounding dial tone, it might be a phone line set up for digital phones. Connect your HP all-in-one to an analog phone line and try sending or receiving a fax.

After you resolve any problems found, run the fax test again to make sure it passes and your HP all-in-one is ready for faxing. If the **Dial Tone Detection** test continues to fail, contact your telephone company and have them check the phone line.

### The HP all-in-one is having problems sending and receiving faxes

#### Solution

**Note** This possible solution applies only in the countries/regions that receive a 2-wire phone cord in the box with the HP all-in-one, including: Argentina, Australia, Brazil, Canada, Chile, China, Colombia, Greece, India, Indonesia, Ireland, Japan, Korea, Latin America, Malaysia, Mexico, Philippines, Poland, Portugal, Russia, Saudi Arabia, Singapore, Spain, Taiwan, Thailand, USA, Venezuela, and Vietnam.

- Make sure you used the phone cord supplied in the box with your HP all-in-one to connect to the telephone wall jack. One end of this special 2-wire phone cord should be connected to the port labeled "1-LINE" on the back of your HP all-in-one and the other end to your telephone wall jack, as shown below.

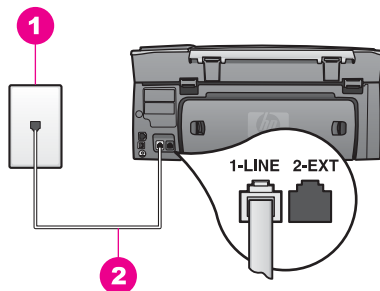

1	Telephone wall jack
2	Phone cord supplied in the box with your HP all-in-one

This special 2-wire cord is different from the more common 4-wire phone cords you might already have in your home or office. Check the end of the cord and compare it to the two types of cords shown below.

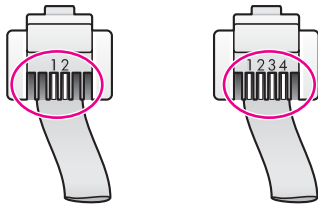

If you used the 4-wire phone cord, disconnect it, find the supplied 2-wire cord, and then connect the 2-wire cord to the port labeled "1-LINE" on the back of your HP all-in-one. For more information on connecting this phone cord and setting up your HP all-in-one for faxing, see [Fax setup](#).

If the supplied phone cord is not long enough, you can extend it. For information see [The phone cord that came with my HP all-in-one is not long enough](#).

- Try connecting a working phone and phone cord to the telephone wall jack that you are using for the HP all-in-one and check for a dial tone. If you do not hear a dial tone, contact your telephone company and have them check the line.
- Other equipment, which uses the same phone line as the HP all-in-one, might be in use. For example, you cannot use your HP all-in-one for faxing if an extension phone is off hook, or if you are using your PC modem to send an e-mail or access the Internet.
- The phone line connection might be noisy. Phone lines with poor sound quality (noise) can cause faxing problems. Check the sound quality of the phone line by plugging a phone into the telephone wall jack and listening for static or other noise. If you hear noise, turn **Error Correction Mode (ECM)** off and try faxing again. For information, see [Use error correction mode](#). If the problem persists, contact your telephone company.
- If you are using a digital subscriber line (DSL) service, make sure that you have a DSL filter connected or you will not be able to fax successfully. The DSL filter removes the digital signal and allows your HP all-in-one to communicate properly with the phone line. Obtain a DSL filter from your DSL provider. If you already have a DSL filter, make sure it is connected correctly. For information, see [Case B: Set up your HP all-in-one with DSL](#).
- Make sure your HP all-in-one is not connected to a telephone wall jack that is set up for digital phones. To check if your phone line is digital, connect a regular analog phone to the line and listen for a dial tone. If you do not hear a normal sounding dial tone, it might be a phone line set up for digital phones.
- If you are using either a private branch exchange (PBX) or an integrated services digital network (ISDN) converter/terminal adapter, make sure the HP all-in-one is connected to the port that is designated for fax and phone use. Also, make sure that the terminal adapter is set to the correct switch type for your country/region, if possible.

Note that some ISDN systems allow you to configure the ports for specific phone equipment. For example, you might have assigned one port for telephone and Group 3 fax and another port for multiple purposes. If you continue to have problems when connected to the fax/phone port, try using the port designated for multiple purposes; it might be labeled "multi-combi" or

something similar. For information on setting up your HP all-in-one with a PBX phone system or ISDN line, see [Fax setup](#).

- If your HP all-in-one shares the same phone line with a DSL service, the DSL modem might not be properly grounded. If the DSL modem is not properly grounded, it can create noise on the phone line. Phone lines with poor sound quality (noise) can cause faxing problems. You can check the sound quality of the phone line by plugging a phone into the telephone wall jack and listening for static or other noise. If you hear noise, turn off your DSL modem and completely remove power for at least 15 minutes. Turn the DSL modem back on and listen to the dial tone again.

**Note** You might notice static on the phone line again in the future. If your HP all-in-one stops sending and receiving faxes, repeat this process.

If the phone line is still noisy or for more information on turning your DSL modem off, contact your DSL provider for support. You can also contact your telephone company.

- If you are using a phone splitter, this can cause faxing problems. (A splitter is a two-cord connector that plugs into a telephone wall jack.) Try removing the splitter and connecting the HP all-in-one directly to the telephone wall jack.

### The HP all-in-one is having problems sending a manual fax

#### Solution

- Make sure the telephone you use to initiate the fax call is connected directly to the HP all-in-one. To send a fax manually, the telephone must be connected directly to the port labeled "2-EXT" on the HP all-in-one, as shown below. For information on sending faxes manually, see [Send a fax manually from a phone](#).

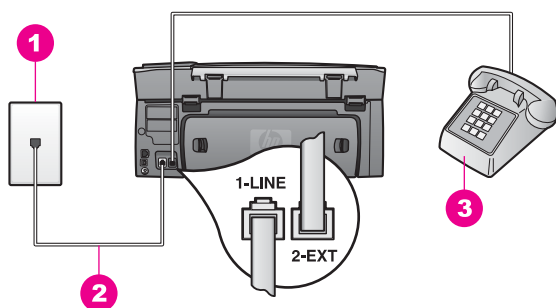

1	Telephone wall jack
2	Phone cord supplied in the box with your HP all-in-one
3	Telephone

- If you are sending a fax manually from your phone that is connected directly to the HP all-in-one, you must use the keypad on the telephone to send the fax. You cannot use the keypad on the control panel of the HP all-in-one.

### The HP all-in-one cannot receive faxes, but can send faxes

## Solution

- If you are not using a distinctive ring service, check to make sure that the **Answer Ring Pattern** feature on your HP all-in-one is set to **All Rings**. For information, see [Change the answer ring pattern \(distinctive ringing\)](#).
- If **Auto Answer** is set to **Off**, you will need to manually receive faxes; otherwise, your HP all-in-one will not receive the fax. For information on receiving faxes manually, see [Receive a fax manually](#).
- If you have a voice mail service at the same phone number you use for fax calls, you must receive faxes manually, not automatically. This means that you must be available to respond in person to incoming fax calls. For information on setting up your HP all-in-one when you have a voice mail service, see [Fax setup](#). For information on receiving faxes manually, see [Receive a fax manually](#).
- If you have a PC modem on the same phone line with your HP all-in-one, check to make sure that the PC modem software is not set to receive faxes automatically. Modems with the auto fax receive feature turned on will receive all incoming faxes, which prevents the HP all-in-one from receiving fax calls.
- If you have an answering machine on the same phone line with your HP all-in-one, you might have one of the following problems:
  - Your answering machine might not be set up properly with your HP all-in-one.
  - Your outgoing message might be too long or too loud to allow the HP all-in-one to detect fax tones, and the calling fax machine might disconnect.
  - Your answering machine might hang up too quickly after the outgoing message plays if it does not detect someone trying to record a message, as when a fax is calling. This prevents the HP all-in-one from detecting the fax tones. This problem is most common with digital answering machines.

The following actions might help solve these problems:

- When you have an answering machine on the same phone line you use for fax calls, try connecting the answering machine directly to the HP all-in-one as described in [Fax setup](#).
- Make sure your HP all-in-one is set to receive faxes automatically. For information on setting up your HP all-in-one to receive faxes automatically, see [Set up the HP all-in-one to receive faxes](#).
- Make sure the **Rings to Answer** setting is correct. Set your answering machine to answer in 4 rings and your HP all-in-one to answer in the maximum number of rings supported by your device. (The maximum number of rings varies by country/region.) In this setup, the answering machine will answer the call and the HP all-in-one will monitor the line. If the HP all-in-one detects fax tones, the HP all-in-one will receive the fax. If the call is a voice call, the answering machine will record the incoming message. For information on setting the number of rings to answer, see [Set the number of rings before answering](#).
- Disconnect the answering machine and then try receiving a fax. If you can receive a fax without the answering machine, the answering machine might be causing the problem.
- Reconnect the answering machine and rerecord your outgoing message. Make sure the message is as short as possible (no more than 10 seconds long), and that you speak softly and slowly when recording it. At the end

of your outgoing message, record an additional 4 - 5 seconds of silence with no background noise. Try to receive a fax again.

**Note** Some digital answering machines might not retain the recorded silence at the end of your outgoing message. Play back your outgoing message to check.

- If your HP all-in-one shares the same phone line with other types of phone equipment, such as an answering machine, a PC modem, or multi-port switch box, the fax signal level might be reduced. This can cause problems during fax reception.

To find out if other equipment is causing a problem, disconnect everything except the HP all-in-one from the phone line, and then try to receive a fax. If you can receive faxes successfully without the other equipment, one or more pieces of the other equipment is causing problems; try adding them back one at a time and receiving a fax each time, until you identify which equipment is causing the problem.

- If you have a special ring pattern for your fax phone number (using a distinctive ring service through your telephone company), make sure that the **Answer Ring Pattern** feature on your HP all-in-one is set to match. For example, if the telephone company has assigned your fax number a double ring pattern, make sure **Double Rings** is selected as the **Answer Ring Pattern** setting. For information on changing this setting, see [Change the answer ring pattern \(distinctive ringing\)](#).

**Note** The HP all-in-one cannot recognize some ring patterns, such as those with alternating short and long ringing patterns. If you are having problems with a ring pattern of this type, ask your telephone company to assign a non-alternating ring pattern.

### Fax tones are recorded on my answering machine

#### Solution

- When you have an answering machine on the same phone line you use for fax calls, try connecting the answering machine directly to the HP all-in-one as described in [Fax setup](#). If you do not connect the answering machine as recommended, fax tones might be recorded on your answering machine.
- Make sure your HP all-in-one is set to receive faxes automatically. If your HP all-in-one is set up to receive faxes manually, the HP all-in-one will not answer incoming calls. You must be available to respond in person to incoming fax calls, or the HP all-in-one will not receive the fax and your answering machine will record the fax tones. For information on setting up your HP all-in-one to receive faxes automatically, see [Set up the HP all-in-one to receive faxes](#).
- Make sure the **Rings to Answer** setting is correct. The number of rings to answer for the HP all-in-one should be greater than the number of rings to answer for the answering machine. If the answering machine and the HP all-in-one are set to the same number of rings to answer, both devices will answer the call, and fax tones will be recorded on the answering machine.

Set your answering machine to answer in 4 rings and your HP all-in-one to answer in the maximum number of rings supported by your device. (The maximum number of rings varies by country/region.) In this setup, the

answering machine will answer the call and the HP all-in-one will monitor the line. If the HP all-in-one detects fax tones, the HP all-in-one will receive the fax. If the call is a voice call, the answering machine will record the incoming message. For information on setting the number of rings to answer, see [Set the number of rings before answering](#).

### I hear static on my phone line since connecting the HP all-in-one

#### Solution

**Note** This possible solution applies only in the countries/regions that receive a 2-wire phone cord in the box with the HP all-in-one, including: Argentina, Australia, Brazil, Canada, Chile, China, Colombia, Greece, India, Indonesia, Ireland, Japan, Korea, Latin America, Malaysia, Mexico, Philippines, Poland, Portugal, Russia, Saudi Arabia, Singapore, Spain, Taiwan, Thailand, USA, Venezuela, and Vietnam.

- If you did not connect the 2-wire cord (supplied in the box with your HP all-in-one) to the port labeled "1-LINE" on the back of your HP all-in-one to your telephone wall jack, you might hear static on your phone line and you probably will not be able to fax successfully. This special 2-wire cord is different from the more common 4-wire phone cords you might already have in your home or office.
- If you are using a phone splitter, this can cause static on the phone line. (A splitter is a two-cord connector that plugs into a telephone wall jack.) Try removing the splitter and connecting the HP all-in-one directly to the telephone wall jack.
- If you are not using a proper grounded power outlet for your HP all-in-one, you might hear static on your phone line. Try connecting to another power outlet.

### The phone cord that came with my HP all-in-one is not long enough

#### Solution

If the phone cord that came with your HP all-in-one is not long enough, you can use a coupler to extend the length. You can purchase a coupler at an electronics store that carries phone accessories. You will also need another phone cord, which can be a standard phone cord that you might already have in your home or office.

**Tip** If your HP all-in-one came with a 2-wire phone cord adaptor, you can use it with a 4-wire phone cord to extend the length. For information on using the 2-wire phone cord adaptor, see the documentation that came with it.

#### To extend your phone cord

- 1 Using the phone cord supplied in the box with your HP all-in-one, connect one end to the coupler, then connect the other end to the port labeled "1-LINE" on the back of your HP all-in-one.
- 2 Connect another phone cord to the open port on the coupler and to the telephone wall jack, as shown below.



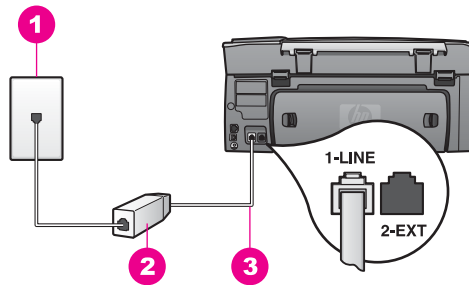

1	Telephone wall jack
2	Coupler
3	Phone cord supplied in the box with the HP all-in-one

## I am having problems faxing over the Internet

### Solution

Check the following:

- The FoIP service might not work properly when the HP all-in-one is sending and receiving faxes at high speed (33600bps). If you experience problems sending and receiving faxes, use a slower fax speed. You can do this by changing the **Fax Speed** setting from **High** (the default) to **Medium**. For information on changing this setting, see [Set the fax speed](#).
- You can only send and receive faxes by connecting a phone cord to the port labeled "1-LINE" on the HP all-in-one and not from the Ethernet port. This means that your connection to the Internet must be done either through a converter box (which supplies regular analog phone jacks for fax connections) or your telephone company.
- You should also check with your telephone company to make sure their Internet phone service supports faxing. If they do not support faxing, you will not be able to send and receive faxes through the Internet.

## HP Instant Share setup issues

**HP Instant Share** setup errors (such as might be involved in setting up your **HP Passport** account or **Address Book**) are covered in the **HP Instant Share** service screen-specific help. Specific operational troubleshooting information is provided in the [HP Instant Share troubleshooting](#).

Use this section to solve HP Instant Share errors generated as a result of the way the device was set up.

### Minimum installation error

## Solution

HP Instant Share cannot be set up on your HP all-in-one. The HP Instant Share feature is not installed.

- To enable the HP Instant Share feature, insert the installation CD that came with your product and select **Typical (Recommended)**.
  - If you need an installation CD for an HP Photosmart 2600 series all-in-one, you can order one from [www.hp.com/support](http://www.hp.com/support).
  - If you need an installation CD for an HP Photosmart 2700 series all-in-one, you can order one from [www.hp.com/support](http://www.hp.com/support).

**Note** If your system does not meet the system requirements for a **Typical** software installation, you will not be able to install and use HP Instant Share.

## You need to install device software

### Solution

You have not installed the HP all-in-one software.

- To install the HP all-in-one software, insert the installation CD that came with your product and select **Typical (Recommended)**.
  - If you need an installation CD for an HP Photosmart 2600 series all-in-one, you can order one from [www.hp.com/support](http://www.hp.com/support).
  - If you need an installation CD for an HP Photosmart 2700 series all-in-one, you can order one from [www.hp.com/support](http://www.hp.com/support).

## (HP Instant Share) Not Set Up

### Solution

You have pressed the **HP Instant Share** button and your HP all-in-one is not registered with HP Instant Share.

- 1 Press **1** to select **Yes, set up HP Instant Share for easy photo sharing**. The HP Instant Share Setup Wizard opens in a browser on your computer.
- 2 Follow the onscreen instructions to obtain an HP Passport account and set up your HP all-in-one for HP Instant Share.

## HP Instant Share is not set up or network is not available

### Solution

You have not set up HP Instant Share on your device.

- 1 Press **HP Instant Share** on the control panel of your HP all-in-one.
- 2 Press **1** to select **Yes, set up HP Instant Share for easy photo sharing**. The HP Instant Share Setup Wizard opens in a browser on your computer.
- 3 Follow the onscreen instructions to obtain an HP Passport account and set up your HP all-in-one for HP Instant Share.

### Solution

The network is not available.

- For detailed information, see the Network Guide that came with your HP all-in-one.

## Destinations not set up on device. Refer to manual for Help.

### Solution

The HP Instant Share service did not find any destinations. No destinations were configured.

- Create destinations to designate locations to which you want to send images. A destination, for example, can be an e-mail address, a friend or relative's network-connected device, an online photo album, or an online photo finishing service. Availability of services varies by country/region.

### To create destinations

- 1 Press **HP Instant Share** on the control panel of your HP all-in-one. The **HP Instant Share** menu appears on the color graphics display.
- 2 Press **3** to select **Add New Destination**. The **Select Computer** menu appears, with a list of computers connected to your network.
- 3 Select a computer from the list.

**Note** **HP Image Zone** software must be installed on the computer selected, and the computer must be able to access the HP Instant Share service.

- 4 The HP Instant Share service screens appear in a window on your computer. Sign in to HP Instant Share with your HP Passport **userid** and **password**. The HP Instant Share manager appears.

**Note** You will not be prompted for your HP Passport **userid** and **password** if you have set the HP Instant Share service to remember them.

- 5 Select the **Share** tab and follow the onscreen instructions to create a new destination.

For more information, see the onscreen Help.

If you want to send a collection of images to a friend or relative's network-connected device, select **HP Instant Share E-mail**. In the **E-mail address** field enter the name of the device to which you want to send followed by **@send.hp.com**.

**Note** To send to a device: 1) both the sender and recipient must have an HP Passport user ID and password; 2) the device to which the image is sent must be registered with HP Instant Share; and 3) the image must be sent using **HP Instant Share E-mail** or HP remote printing.

Prior to setting up a device destination in **HP Instant Share E-mail** or adding a printer for use with HP remote printing, ask the recipient for the unique name he assigned to his network-connected device. The device name is created by a person when he signs up with HP Instant Share and registers his device. For more information, see [Get started](#).

## Operational troubleshooting

The **HP Photosmart 2600/2700 series all-in-one** troubleshooting section in the **HP Image Zone** contains troubleshooting tips for some of the most common issues associated with your HP all-in-one.

To access the troubleshooting information from a Windows computer, go to the **HP Director**, click **Help**, and then choose **Troubleshooting and Support**. Troubleshooting is also available through the Help button that appears on some error messages.

To access troubleshooting information from Macintosh OS X v10.1.5 and later, click the **HP Image Zone** icon in the Dock, select **Help** from the menu bar, choose **HP Image Zone Help** from the **Help** menu, and then choose **HP Photosmart 2600/2700 series all-in-one Troubleshooting** in the Help Viewer.

If you have Internet access, you can get help from the HP website at [www.hp.com/support](http://www.hp.com/support). The website also provides answers to frequently asked questions.

## Paper troubleshooting

To help avoid paper jams, only use paper types that are recommended for your HP all-in-one. For a list of recommended papers, see the onscreen **HP Image Zone Help**, or go to [www.hp.com/support](http://www.hp.com/support).

Do not load curled or wrinkled paper, or paper with bent or torn edges, into the input tray. For more information, see [Avoid paper jams](#).

If paper does become jammed in your device, follow these instructions to clear the paper jam.

### Paper has jammed the HP all-in-one

#### Solution

- 1 Press in the tabs on the rear clean-out door to remove the door as shown below.

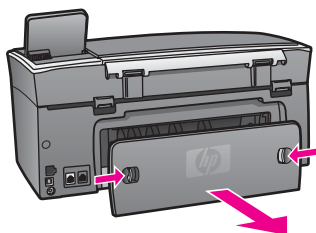

**Caution** Trying to clear a paper jam from the front of the HP all-in-one can damage the print mechanism. Always access and clear paper jams through the rear clean-out door.

- 2 Gently pull the paper out of the rollers.

**Warning** If the paper tears when you are removing it from the rollers, check the rollers and wheels for torn pieces of paper that might remain inside the device. If you do not remove all the pieces of paper from the HP all-in-one, more paper jams are likely to occur.

- 3 Replace the rear clean-out door. Gently push the door forward until it snaps into place.
- 4 Press **OK** to continue the current job.

## Paper has jammed the optional two-sided printing accessory

### Solution

You might need to remove the two-sided printing accessory. For more information, see the printed guide that came with your two-sided printing accessory.

**Note** If you turned the HP all-in-one off before clearing the paper jam, turn it back on, and then restart your printing or copying job.

## Print cartridge troubleshooting

If you are experiencing problems with printing, you might have a problem with one of the print cartridges. Try the following:

- 1 Remove and reinsert the print cartridges and verify that they are fully inserted and locked in place.
- 2 If the problem persists, print a self-test report to determine if there is a problem with the print cartridges.  
This report provides useful information about your print cartridges, including status information.
- 3 If the self-test report shows a problem, clean the print cartridges.
- 4 If the problem persists, clean the copper-colored contacts of the print cartridges.
- 5 If you are still experiencing problems with printing, determine which print cartridge is experiencing the problem and replace it.

For more information on these topics, see [Maintain your HP all-in-one](#).

## HP Instant Share troubleshooting

Error messages discussed in this section appear on your HP all-in-one color graphics display. Basic HP Instant Share troubleshooting topics are covered below. Online help is provided for any error messages encountered on the HP Instant Share service.

### General errors

Use this section to solve the following generic HP Instant Share errors.

#### HP Instant Share error. Refer to manual for Help.

### Solution

The HP all-in-one experienced an error.

→ Shut down and restart your HP all-in-one.

#### To shut down your HP all-in-one

- 1 Turn off the HP all-in-one by using the **On** button located on the control panel.
- 2 Unplug the power cord from the back of the HP all-in-one.

#### HP Instant Share error. Try again later.

### Solution

The HP Instant Share service sent data that is not recognized by the HP all-in-one.

→ Try the task again later. If that doesn't work, shut down and restart your HP all-in-one.

## To shut down your HP all-in-one

- 1 Turn off the HP all-in-one by using the **On** button located on the control panel.
- 2 Unplug the power cord from the back of the HP all-in-one.

## Connection errors

Use this section to solve the following errors generated when your HP all-in-one fails to connect to the HP Instant Share service.

### No network connection. See documentation.

#### Solution

##### Wired network

Network cables are loose or disconnected.

Incomplete or incorrect network connections prevent devices from communicating with each other and generate problems in your network.

- Check cable connections from the HP all-in-one to your gateway, router, or hub to ensure connections are secure. If these connections are secure, check your remaining cables to ensure connections are secure. Make sure none of the cables are crushed or damaged.
- Check all of the following connections: power cords; cables between the HP all-in-one and the hub or router; cables between the hub or router and your computer; and (if applicable) cables to and from your modem or Internet connection.
- If the connections mentioned above are secure, connect the cable to the HP all-in-one to a working part of the network to verify the cable is bad, or swap out remaining cables (one at a time) until you replace the malfunctioning cable.

**Note** You can also launch the **HP Director** from the desktop on your computer, and click **Status**. A dialog box appears on the computer stating whether or not the HP all-in-one is connected.

#### Solution

##### Wireless Network

There is some sort of interference.

The HP all-in-one is out of range of the access point.

- Verify that physical barriers and other forms of interference are limited. Signals transmitted between your HP all-in-one and access point are affected by interference from other wireless devices - including cordless phones, microwave ovens, and neighboring wireless networks. Physical objects between the computer and the HP all-in-one also affect transmitted signals. If this is occurring, move your network components closer to the HP all-in-one. To minimize interference from another wireless network, try changing channels.
- Move the HP all-in-one and the access point closer together. If the distance between your access point and the HP all-in-one is significant, try reducing the distance. (The range for 802.11b is approximately 100 feet, and less if there is any interference.) If possible, provide a clear path between the access point and HP all-in-one, and minimize sources of radio interference.

**Solution**

Your HP all-in-one was connected to a network at one time. It is now directly connected to a computer using a USB cable. The HP Instant Share application is reading the previous network settings.

- If you are trying to use HP Instant Share while using a USB cable, reset the network settings on the HP all-in-one or access HP Instant Share from the **HP Image Zone** software on your computer.

**Note** For more information on resetting network settings, see the Networking Guide that came with your HP all-in-one.

**Failed to connect to HP Instant Share****Solution**

The domain name server (DNS) did not have an entry for the URL.

- Check the DNS settings, then try the task again later.

**To check the DNS IP address**

- 1 Press **Setup** on the control panel of your HP all-in-one. The **Setup Menu** appears on the color graphics display.
- 2 Press **8**, and then press **1**. This selects **Network** and then **View Network Settings**. The **Network Settings** menu appears.
- 3 Press **1** to select **Print Detailed Report**. The network configuration page prints on your HP all-in-one.
- 4 Find the DNS Server information and verify that the IP address of the network's domain name server is accurate. Call your Internet Service Provider (ISP) to verify the DNS address.
- 5 If it is invalid, access the embedded Web server (EWS) and enter the correct IP address.

**To enter information in the EWS**

- 1 Find the device IP Address on the network configuration page.
- 2 Enter the device IP Address into the **Address** field on a browser on your computer. The EWS **Home** page appears in your browser window.
- 3 Click the **Networking** tab.
- 4 Using the sidebar navigation, find the information you are looking to change and enter the correct information.

For more information, see the **HP Photosmart 2600/2700 series all-in-one** section in the **HP Image Zone Help**.

## Solution

The HP Instant Share service is not responding. Either the service is down for maintenance, the proxy settings are inaccurate, or one or more of your network cables are disconnected.

→ Try one of the following:

- Check your proxy settings (see the procedure below).
- Check your network connections. For more information, see the Network Guide that came with your HP all-in-one.
- Try the task again later.

**Note** Your HP all-in-one does not support proxies that require authentication.

## To check your proxy settings

- 1 Press **Setup** on the control panel of your HP all-in-one. The **Setup Menu** appears on the color graphics display.
  - 2 Press **8**, and then press **1**. This selects **Network** and then **View Network Settings**. The **Network Settings** menu appears.
  - 3 Press **1** to select **Print Detailed Report**. The network configuration page prints on your HP all-in-one.
  - 4 Find the device IP Address on the network configuration page.
  - 5 Enter the device IP Address into the **Address** field on a browser on your computer. The embedded Web server (EWS) **Home** page appears in your browser window.
  - 6 Click the **Networking** tab.
  - 7 Under **Applications**, click **Instant Share**.
  - 8 Verify the proxy settings.
  - 9 If the settings are inaccurate, enter the correct information in the appropriate field(s) in the EWS.
- For more information, see the Network Guide that came with your HP all-in-one.

## Failed to connect to HP Instant Share. Check DNS address.

### Solution

The HP all-in-one cannot connect to the HP Instant Share service. Possible causes include: the DNS IP address is unknown; no DNS IP address is set; or the DNS IP address is all zeroes.

→ Verify the DNS IP address used by your HP all-in-one.

For more information, see [To check the DNS IP address](#).

## Failed to connect to HP Instant Share. DNS server not responding.

### Solution

Either the DNS server is not responding, the network is down, or the DNS IP address is invalid.

- 1 Verify the DNS IP address used by your HP all-in-one.



- For more information, see [To check the DNS IP address](#).
- 2 If the DNS IP address is valid, try connecting again later.

### Failed to connect to HP Instant Share. Check proxy address.

#### Solution

The DNS server could not resolve the proxy URL to an IP address.

- 1 Verify the proxy information used by your HP all-in-one.  
For more information, see [To check your proxy settings](#).
- 2 If the proxy information is valid, try connecting again later.

### Connection lost to HP Instant Share service.

#### Solution

The HP all-in-one lost its connection to the HP Instant Share service.

- 1 Check physical network connections and make sure the network is operational.  
For more information, see the Network Guide that came with your HP all-in-one.
- 2 Once you verify network connectivity, retry the task.

### Send image collections errors

Use this section to solve errors generated when problems are encountered sending images from your HP all-in-one to a selected destination.

### Corrupted Destination file found.

#### Solution

There is something wrong with the format of the Destination (Intent) file on the memory card.

- Consult the user documentation that came with your camera and reassign intents on the memory card.

### Destination not authorized on this device.

#### Solution

One or more of the HP Instant Share destinations does not belong to the registered user of the device.

- Make sure the camera and HP all-in-one are registered under the same HP Passport account.

### Memory card error

#### Solution

The memory card might be defective.

- 1 Remove the memory card from the HP all-in-one, and then reinsert the card.
- 2 If this does not work, shut down and restart your HP all-in-one.
- 3 If this does not work, reformat the memory card.

As a last resort, replace the memory card.

## HP Instant Share storage limit exceeded. Refer to manual for Help.

### Solution

The job you were sending failed. Allotted disk space has been exceeded on the HP Instant Share service.

**Note** Older files are automatically deleted from your account. This error will go away in a few days or weeks.

### To remove files from the HP Instant Share service

- 1 Press **HP Instant Share** on the control panel of your HP all-in-one. The **HP Instant Share** menu appears on the color graphics display.
- 2 Press **3**, and then press **5**. This selects the **Instant Share Options** menu and then **Manage Account**. The HP Instant Share service screens appear in a window on your computer.
- 3 Sign in to HP Instant Share with your HP Passport **userid** and **password**.

**Note** You will not be prompted for your HP Passport **userid** and **password** if you have set the HP Instant Share service to remember them.

- 4 Follow the onscreen instructions.
- 5 From the HP Instant Share setup menu, select **Manage Account**.
- 6 Follow the onscreen instructions to remove files from your account.

## Send and Receive image collections errors

Use this section to solve errors that are common to both HP Instant Share Send and Receive functions.

### Login failed. Refer to the manual for Help.

#### Solution

The HP all-in-one failed to log in to the HP Instant Share service.

- Try again later.
- Set up the device again through HP Instant Share.

### HP Instant Share service discontinued.

#### Solution

The HP Instant Share service has been discontinued.

- The service has been discontinued. If you have any questions, contact HP Customer Support.

### HP Instant Share service temporarily unavailable. Try again later.

#### Solution

The HP Instant Share service is currently down for maintenance.

- Try connecting again later.

## HP Instant Share Error Report messages

If you encounter a problem while sending images to a destination, an HP Instant Share Error Report prints on your HP all-in-one. Use this section to solve possible file problems shown on the Error Report.

### Unsupported file format

#### Solution

One of the files sent to the HP Instant Share service is not one of the supported file types.

→ Convert the file to a JPEG and try the task again.

### Corrupted file

#### Solution

The file you sent is corrupted.

→ Replace the file and try again. For example, retake the digital photo or regenerate the image.

### Exceeds supported file size

#### Solution

One of the files sent to the HP Instant Share service exceeds the server's file size limit.

→ Rework the image so that it is below 5 MB in size, and then try sending it again.

## Photo memory card troubleshooting

The following troubleshooting tips relate only to Macintosh users of iPhoto.

### You insert a memory card into a networked HP all-in-one, but iPhoto does not see it.

#### Solution

A memory card must appear on the desktop for iPhoto to find it, but a memory card inserted in a networked HP all-in-one does not automatically mount on the desktop. If you simply launch iPhoto from its folder or by double-clicking an alias, the application cannot see the inserted, but unmounted memory card. Instead start the **HP Director** and choose **iPhoto** from **More Applications**. When you start iPhoto from within the **HP Director** in this way, the application sees and mounts the memory card automatically.

### You have video clips on a memory card, but they do not appear in iPhoto after you import the memory card's contents.

#### Solution

iPhoto handles still photos only. To manage both video clips and still images, use **Unload Images** from the **HP Director** instead.

## Fax troubleshooting

**Tip** For additional fax troubleshooting topics, such as problems with your printouts or slow fax reception, see the onscreen Troubleshooting Help that came with your **HP Image Zone** software.

### When I send a fax, I receive an error message saying the memory is full

#### Solution

If you are sending a fax and receive a message on the color graphics display indicating the memory is full, try the following:

- If you are sending a multiple-page fax, try sending the pages separately, one at a time.
- Try changing the **Lighter/Darker** setting to either a lighter or darker setting and resending the fax. For information on changing the **Lighter/Darker** setting, see [Change the lighter/darker setting](#).
- If you are sending a black-and-white fax with **Photo** resolution, try pressing **Start Color** instead of **Start Black**.

## Device update

Several options are provided to update your HP all-in-one. Each involves downloading a file to your computer to start the **Device Update Wizard**. For example:

- Based on advice from HP customer support you might access the HP support website to retrieve an upgrade for your device.
- A dialog might appear on your HP all-in-one color graphics display to direct you to update your device.

**Note** If you are a Windows user, you can set the **Software Update** utility (part of the **HP Image Zone** software installed on your computer) to automatically search the HP support website for device updates at predetermined intervals. For more information on the **Software Update** utility, see the onscreen **HP Image Zone Help**.

### Device update (Windows)

Use one of the following to retrieve an update for your device:

- Use your Web browser to download an update for your HP all-in-one from [www.hp.com/support](http://www.hp.com/support). The file will be a self-extracting executable with the extension `.exe`. When you double-click the `.exe` file, the **Device Update Wizard** opens on your computer.
- Use the **Software Update** utility to automatically search the HP support website for device updates at predetermined intervals.

**Note** After the **Software Update** utility is installed on your computer, it searches for device updates. If you do not have the latest version of the **Software Update** utility at the time of install, a dialog appears on your computer prompting you to upgrade. Accept the upgrade.

### To use device update

- 1 Do one of the following:
  - Double-click the update .exe file you downloaded from [www.hp.com/support](http://www.hp.com/support).
  - When prompted, accept the device update found by the **Software Update** utility.

The **Device Update Wizard** opens on your computer.
- 2 At the **Welcome** screen, click **Next**.  
The **Select a Device** screen appears.
- 3 Select your HP all-in-one from the list, and then click **Next**.  
The **Important Information** screen appears.
- 4 Make sure your computer and device meet the requirements listed.
- 5 If you meet the requirements, click **Update**.  
The **Updating Device** screen appears. A light begins to flash on the control panel of your HP all-in-one.  
The screen on your color graphics display turns green as the update is loaded and extracted to your device.
- 6 Do not disconnect, shut down, or otherwise disturb your device while the update is occurring.

**Note** If you disrupt the update, or an error message indicates the update failed, call HP support for assistance.

After your HP all-in-one shuts down and restarts, an update complete screen appears on your computer

Your device is updated. It is now safe to use your HP all-in-one.

### Device update (Macintosh)

The device update installer provides a means to apply updates to your HP all-in-one as follows:

- 1 Use your Web browser to download an update for your HP all-in-one from [www.hp.com/support](http://www.hp.com/support).
- 2 Double-click the downloaded file.  
The installer opens on your computer.
- 3 Follow the onscreen prompts to install the update to your HP all-in-one.
- 4 Restart the HP all-in-one to complete the process.

# 17 Get HP support

Hewlett-Packard provides Internet and phone support for your HP all-in-one.

This chapter provides information on how to get support from the Internet, contact HP customer support, access your serial number and service ID, and prepare your HP all-in-one for shipment. If you are unable to find the answer you need in the printed or onscreen documentation supplied with your product, you can contact one of the HP support services listed in the following pages. Some support services are available only in the U.S. and Canada, while others are available in many countries/regions worldwide. If a support service number is not listed for your country/region, contact your nearest authorized HP dealer for help.

## Get support and other information from the Internet

If you have Internet access, you can get help from the following HP website:

[www.hp.com/support](http://www.hp.com/support)

This website offers technical support, drivers, supplies, and ordering information.

## HP customer support

Software programs from other companies might be included with your HP all-in-one. If you experience problems with any of those programs, you will receive the best technical assistance by calling the experts at that company.

If you need to contact HP Customer Support, do the following before you call.

- 1 Make sure that:
  - a Your HP all-in-one is plugged in and turned on.
  - b The specified print cartridges are installed correctly.
  - c The recommended paper is properly loaded in the input tray.
- 2 Reset your HP all-in-one:
  - a Turn off the HP all-in-one by pressing the **On** button.
  - b Unplug the power cord from the back of the HP all-in-one.
  - c Plug the power cord back into the HP all-in-one.
  - d Turn on the HP all-in-one by pressing the **On** button.
- 3 For more information, go to [www.hp.com/support](http://www.hp.com/support).  
This website offers technical support, drivers, supplies, and ordering information.
- 4 If you are still experiencing problems and need to speak with an HP Customer Support Representative, do the following:
  - a Have the specific name of your HP all-in-one, as it appears on the control panel, available.
  - b Print a self-test report. For information on printing a self-test report, see [Print a self-test report](#).
  - c Make a color copy to have available as a sample printout.
  - d Be prepared to describe your problem in detail.
  - e Have your serial number and service ID ready. For information on how to access your serial number and service ID, see [Access your serial number and service ID](#).
- 5 Call HP Customer Support. Be near your HP all-in-one when you call.

## Access your serial number and service ID

You can access important information by using the **Information Menu** of your HP all-in-one.

**Note** If your HP all-in-one is not turning on, you can view the serial number by looking at the top sticker above the rear USB port. The serial number is the 10-character code in the upper left corner of the sticker.

- 1 Press and hold **OK**. While holding **OK**, press **4**. This displays the **Information Menu**.
- 2 Press **▶** until **Model Number** appears and then press **OK**. This displays the service ID. Write down the complete service ID.
- 3 Press **Cancel** and then **▶** until **Serial Number** appears.
- 4 Press **OK**. This displays the serial number. Write down the complete serial number.
- 5 Press **Cancel** to exit the **Information Menu**.

## Call in North America during warranty

Call **1-800-474-6836 (1-800-HP invent)**. US phone support is available in both English and Spanish languages 24 hours a day, 7 days a week (days and hours of support may change without notice). This service is free during the warranty period. A fee may apply outside the warranty period.

## Call elsewhere in the world

The numbers listed below are current as of the publication date of this guide. For a list of current international HP Support Service numbers, go to [www.hp.com/support](http://www.hp.com/support) and choose your own country/region or language.

You can call the HP support center in the following countries/regions. If your country/region is not listed, contact your local dealer or nearest HP Sales and Support Office to find out how to obtain services.

Support service is free during the warranty period; however, your standard long-distance phone charges will apply. In some cases, a flat fee per single incident will also apply.

For phone support in Europe, please check for the details and conditions of phone support in your country/region by going to [www.hp.com/support](http://www.hp.com/support).

Alternatively, you can ask your dealer or call HP at the phone number provided in this guide.

As part of our constant efforts to improve our phone support service, we advise you to check our website on a regular basis for new information regarding service features and delivery.

Country/Region	HP technical support	Country/Region	HP technical support
Algeria <sup>1</sup>	+213 61 56 45 43	Lebanon	+971 4 883 8454
Argentina	(54)11-4778-8380, 0-810-555-5520	Luxembourg (French)	900 40 006
Australia during warranty	131047	Luxembourg (German)	900 40 007
Australia post-warranty (per-call charge)	1902 910 910	Malaysia	1-800-805405
Austria	+43 1 86332 1000	Mexico	01-800-472-6684
Bahrain	800 171	Mexico (Mexico City)	(55) 5258-9922
Bangladesh	fax to: +65-6275-6707	Middle East	+971 4 366 2020
Belgium (Dutch)	+32 070 300 005	Morocco <sup>1</sup>	+212 22 404747
Belgium (French)	+32 070 300 004	Netherlands (0.10 Euro/min.)	0900 2020 165

(continued)

Country/Region	HP technical support	Country/Region	HP technical support
Bolivia	800-100247	New Zealand	0800 441 147
Brazil (Demais Localidades)	0800 157751	Nigeria	+234 1 3204 999
Brazil (Grande São Paulo)	(11) 3747 7799	Norway <sup>2</sup>	+47 815 62 070
Brunei	fax to: +65-6275-6707	Oman	+971 4 883 8454
Cambodia	fax to: +65-6275-6707	Pakistan	fax to: +65-6275-6707
Canada during warranty	(905) 206 4663	Palestine	+971 4 883 8454
Canada post-warranty (per-call charge)	1-877-621-4722	Panama	001-800-711-2884
Caribbean & Central America	1-800-711-2884	Peru	0-800-10111
Chile	800-360-999	Philippines	632-867-3551
China	86-21-38814518, 8008206616	Poland	+48 22 5666 000
Colombia	01-800-51-474-6836 (01-800-51-HP invent)	Portugal	+351 808 201 492
Costa Rica	0-800-011-4114, 1-800-711-2884	Puerto Rico	1-877-232-0589
Czech Republic	+420 261307310	Qatar	+971 4 883 8454
Denmark	+45 70 202 845	Romania	+40 (21) 315 4442
Dominican Republic	1-800-711-2884	Russian Federation, Moscow	+7 095 7973520
Ecuador (Andinatel)	999119+1-800-7112884	Russian Federation, St. Petersburg	+7 812 3467997
Ecuador (Pacifitel)	1-800-225528+1-800-7112884	Saudi Arabia	800 897 1444
Egypt	+20 2 532 5222	Singapore	65 - 62725300
English (International)	+44 (0) 207 512 5202	Slovakia	+421 2 50222444
Finland	+358 (0) 203 66 767	South Africa (RSA)	086 0001030
France (0.34 Euro/min.)	+33 (0)892 69 60 22	South Africa, Outside Republic	+27 11 2589301
Germany (0.12 Euro/min.)	+49 (0) 180 5652 180	Spain	+34 902 010 059
Greece (Cyprus to Athens toll free)	800 9 2649	Sri Lanka	fax to: +65-6275-6707



Country/Region	HP technical support	Country/Region	HP technical support
Greece, inside country/ region	801 11 22 55 47	Sweden	+46 (0)77 120 4765
Greece, international	+30 210 6073603	Switzerland <sup>3</sup>	+41 0848 672 672
Guatemala	1800-995-5105	Taiwan	+886 (2) 8722-8000, 0800 010 055
Hong Kong SAR	+(852) 2802 4098	Thailand	0-2353-9000
Hungary	+36 1 382 1111	Trinidad & Tobago	1-800-711-2884
India	91-80-8526900	Tunisia <sup>1</sup>	+216 71 89 12 22
India (toll free)	1600-4477 37	Turkey	+90 216 579 71 71
Indonesia	62-21-350-3408	Ukraine, Kiev	+7 (380 44) 4903520
Ireland	+353 1890 923 902	United Arab Emirates	800 4520
Israel	+972 (0) 9 830 4848	United Kingdom	+44 (0) 870 010 4320
Italy	+39 848 800 871	United States	1-800-474-6836 (1-800- HP invent)
Jamaica	1-800-711-2884	Venezuela	0-800-474-6836 (0-800- HP invent)
Japan	+81-3-3335-9800	Venezuela (Caracas)	(502) 207-8488
Jordan	+971 4 883 8454	Vietnam	84-8-823-4530
Korea	+82 1588 3003	W. Africa	+351 213 17 63 80
Kuwait	+971 4 883 8454	Yemen	+971 4 883 8454

- 1 This Call Center supports French-speaking customers from the following countries/regions: Morocco, Tunisia, and Algeria.
- 2 Setup price per call: 0.55 Norway kroner (0.08 Euro), customer price per minute: 0.39 Norway kroner (0.05 Euro).
- 3 This Call Center supports German-, French-, and Italian-speaking customers in Switzerland (0.08 CHF/min. during peak hours, 0.04 CHF/min. during off-peak hours).

## Call in Australia post-warranty

If your product is not under warranty, call 131047. A per-incident, out-of-warranty support fee will be charged to your credit card.  
You can also call 1902 910 910. A per-incident, out-of-warranty support fee will be charged to your phone bill.

## Call HP Korea customer support

### HP 한국 고객 지원 문의

- \*고객 지원 센터 대표 전화  
1588-3003
- \*제품가격 및 구입처 정보 문의 전화  
080-703-0700
- \*전화 상담 가능 시간:  
평 일 09:00~18:00  
토요일 09:00~13:00  
(일요일, 공휴일 제외)

## Call HP Japan customer support

### カスタマー・ケア・センター

TEL : 0570-000-511 (ナビダイヤル)

03-3335-9800 (ナビダイヤルをご利用いただけない場合)

FAX : 03-3335-8338

月~金 9:00 ~ 17:00

土・日 10:00 ~ 17:00 (祝祭日、1/1~3を除く)

FAXによるお問い合わせは、ご質問内容とともに、ご連絡先、  
弊社製品名、接続コンピュータ名をご記入ください。

## HP Quick Exchange Service (Japan)

製品に問題がある場合は以下に記載されている電話番号に連絡してください。製品が故障している、または欠陥があると判断された場合、**HP Quick Exchange Service**がこの製品を正常品と交換し、故障した製品を回収します。保証期間中は、修理代と配送料は無料です。また、お住まいの地域にも依りますが、プリンタを次の日までに交換することも可能です。

電話番号：0570-000511（自動応答）  
 :03-3335-9800（自動応答システムが使用できない場合）  
 サポート時間：平日の午前 9:00 から午後 5:00 まで  
 土日の午前 10:00 から午後 5:00 まで。  
 祝祭日および1月1日から3日は除きます。

### サービスの条件

- サポートの提供は、カスタマケアセンターを通してのみ行われます。
  - カスタマケアセンターがプリンタの不具合と判断した場合に、サービスを受けることができます。
- ご注意:** ユーザの扱いが不適切であったために故障した場合は、保証期間中であっても修理は有料となります。詳細については保証書を参照してください。

### その他の制限

- 運送の時間はお住まいの地域によって異なります。詳しくは、カスタマケアターに連絡してご確認ください。
- 出荷配送は、当社指定の配送業者が行います。
- 配送は交通事情などの諸事情によって、遅れる場合があります。
- このサービスは、将来予告なしに変更することがあります。

## Prepare your HP all-in-one for shipment

If after contacting HP Customer Support or returning to the point of purchase, you are requested to send your HP all-in-one in for service, remove the print cartridges and pack the HP all-in-one in the original packing materials to avoid further damage. You can remove print cartridges from your HP all-in-one whether it is turning on or not. Retain the power cord and control panel overlay in case the HP all-in-one needs to be replaced.

This section provides instructions on how to remove print cartridges from a functional HP all-in-one, remove print cartridges from a non-functional HP all-in-one, and remove the control panel overlay and pack your HP all-in-one.

**Note** This information does not apply to customers in Japan. For information on service options in Japan, see [HP Quick Exchange Service \(Japan\)](#).

### Remove print cartridges from a functional HP all-in-one

- 1 Turn on the HP all-in-one.  
See [Remove print cartridges from a nonfunctional HP all-in-one](#) if your device will not turn on.
- 2 Open the print-carriage access door.
- 3 Wait until the print carriage is idle and silent, and then remove the print cartridges from their slots and lower the latches. For information on removing the print cartridges, see [Replace the print cartridges](#).



**Warning** Remove both print cartridges and lower both latches. Failure to do so might damage your HP all-in-one.

- 4 Place the print cartridges in print cartridge protectors or an airtight plastic container so they will not dry out, and put them aside. Do not send them with the HP all-in-one unless the HP customer support call agent instructs you to.

- 5 Close the print-carriage access door and wait a few minutes for the print carriage to move back to its home position (on the right side).

**Note** Make sure the scanner has returned to its parked position before turning off the HP all-in-one.

- 6 Press the **On** button to turn off the HP all-in-one.
- 7 Unplug the power cord, and then disconnect it from the HP all-in-one. Do not return the power cord with the HP all-in-one.



**Warning** The replacement HP all-in-one will not be shipped with a power cord. Store the power cord in a safe place until the replacement HP all-in-one arrives.

- 8 See [Remove the control panel overlay and pack your HP all-in-one](#) to complete preparation for shipment.

### Remove print cartridges from a nonfunctional HP all-in-one

Follow these steps if you need to remove print cartridges for shipment and your HP all-in-one will not turn on. See [Remove print cartridges from a functional HP all-in-one](#) if your device is turning on. Follow the steps below to unlock the print cartridge cradle, remove the print cartridges, and then lock the print cartridge cradle.

- 1 Unplug the power cord, and then disconnect it from the HP all-in-one. Do not return the power cord with the HP all-in-one.



**Warning** The replacement HP all-in-one will not be shipped with a power cord. Store the power cord in a safe place until the replacement HP all-in-one arrives.

- 2 Facing the front of the HP all-in-one, turn the right-hand side toward you until approximately 12.5 cm (5 inches) of the bottom right side hangs over the edge of a flat surface (such as a desk or table).

This exposes a round purple cover on the bottom.



**Warning** Do not tilt the HP all-in-one on its side, this might cause more damage.



- 3 Locate the cover on the bottom, and then follow the steps below to unlock the print cartridge cradle.
  - a Use the tab to rotate the cover 1/4 turn in either direction.
  - b Remove the cover. This exposes a gear that controls the height of the print cartridge cradle.
  - c Rotate the gear toward the back of the unit until it stops.

**Note** You will rotate the gear a number of times before it stops.

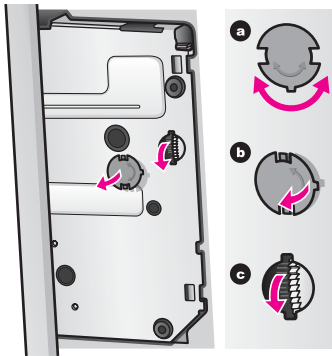

- 4 Open the print-carriage access door, and then remove the print cartridges from their slots and lower the latches.  
Remove both print cartridges and lower both latches. Failure to do so might damage your HP all-in-one.
- 5 Place the print cartridges in print cartridge protectors or an airtight plastic container so they will not dry out, and put them aside. Do not send them with the HP all-in-one unless the HP customer support call agent instructs you to.
- 6 Rotate the gear toward the front of the HP all-in-one until it stops.  
This locks and secures the print cartridge cradle for safe shipment.
- 7 Reattach the cover to the bottom of the HP all-in-one by aligning the two tabs directly across from each other on the cover with the whole slots. With the cover in position rotate it 1/4 turn to lock the cover in its place.
- 8 See [Remove the control panel overlay and pack your HP all-in-one](#) to complete preparation for shipment.

### Remove the control panel overlay and pack your HP all-in-one

Complete the following steps once you have removed the print cartridges and unplugged the HP all-in-one.



**Warning** The HP all-in-one must be unplugged before following these steps.

- 1 Remove the control panel overlay as follows:
  - a Make sure the color graphics display is lying flat against the HP all-in-one.
  - b Place your finger on the top right corner of the control panel overlay.
  - c Gently pry the corner up and lift the control panel overlay from the device as shown below.

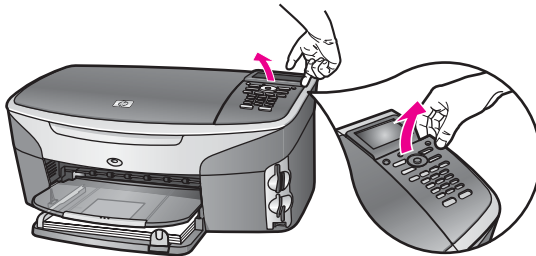

**Tip** You can also use a thin, flat object, such as a credit card, to lift the control panel overlay. Gently slide the credit card at a slight angle, about 45 degrees, between the color graphics display and the control panel overlay. Apply slight downward pressure to lift the control panel overlay.

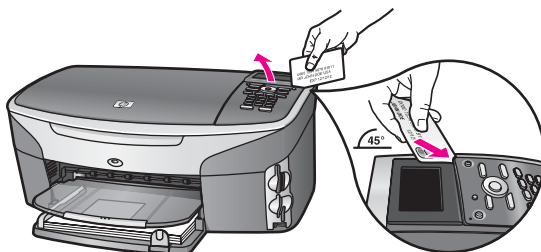

- 2 Retain the control panel overlay. Do not return the control panel overlay with the HP all-in-one.

**Warning**  The replacement HP all-in-one might not come with a control panel overlay. Store your control panel overlay in a safe place, and when the replacement HP all-in-one arrives, reattach your control panel overlay. You must attach your control panel overlay to use the control panel functions on the replacement HP all-in-one.

**Tip** See the Setup Guide that came with your HP all-in-one for instructions on how to attach your control panel overlay.

**Note** The replacement HP all-in-one might come with instructions for setting up your device.

- 3 If available, pack the HP all-in-one for shipment by using the original packing materials or the packaging materials that came with your exchange device.

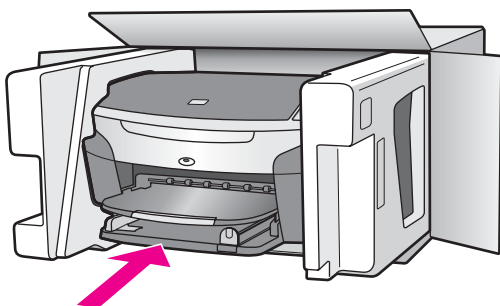

If you do not have the original packaging materials, please use other adequate packaging materials. Shipping damage caused by improper packaging and/or improper transportation is not covered under the warranty.

- 4 Place the return shipping label on the outside of the box.
- 5 Include the following items in the box:
  - A complete description of symptoms for service personnel (samples of print quality problems are helpful).
  - A copy of the sales slip or other proof of purchase to establish the warranty coverage period.
  - Your name, address, and a phone number where you can be reached during the day.



# 18 Warranty information

Your HP all-in-one comes with a limited warranty that is described in this section. Information about how to obtain warranty service and how you can upgrade your standard factory warranty is also provided.

This chapter provides information on duration of limited warranty, warranty service, warranty upgrades, returning you HP all-in-one for service, and contains the Hewlett-Packard limited global warranty statement.

## Duration of limited warranty

Duration of Limited Warranty (hardware and labor): 1 Year

Duration of Limited Warranty (CD media): 90 Days

Duration of Limited Warranty (print cartridges): Until the HP ink is depleted or the "end of warranty" date printed on the cartridge has been reached, whichever occurs first. This warranty does not cover HP ink products that have been refilled, remanufactured, refurbished, misused, or tampered with.

## Warranty service

To obtain HP repair service, the customer must contact an HP service office or an HP Customer Support Center for basic troubleshooting first. See [HP customer support](#) for steps to take before calling Customer Support.

If your HP all-in-one needs a minor part replacement that you can replace, HP might prepay shipping charges, duty and taxes; provide telephone assistance for replacing the part; and pay shipping charges, duty, and taxes for any part that HP asks you to return. Otherwise, the HP Customer Support Center will direct you to an authorized service provider who is certified by HP to service the product.

**Note** This information does not apply to customers in Japan. For information on service options in Japan, see [HP Quick Exchange Service \(Japan\)](#).

## Warranty upgrades

Depending on your country/region, HP might offer a warranty upgrade option that extends or enhances your standard product warranty. Available options might include priority phone support, return service, or next business day exchange. Typically, service coverage begins on product purchase date and must be purchased within a limited time of product purchase.

For more information:

- In the U.S., dial 1-866-234-1377 to speak to an HP advisor.
- Outside the U.S., please call your local HP Customer Support office. See [Call elsewhere in the world](#) for a list of international Customer Support numbers.
- Go to [www.hp.com/support](http://www.hp.com/support).

If prompted, choose your country/region, and then find warranty information.

## Returning your HP all-in-one for service

Before returning your HP all-in-one for service, you must call HP Customer Support. See [HP customer support](#) for steps to take before calling Customer Support.

**Note** This information does not apply to customers in Japan. For information on service options in Japan, see [HP Quick Exchange Service \(Japan\)](#).



## Hewlett-Packard limited global warranty statement

The following information specifies the HP limited global warranty.

### Extent of limited warranty

Hewlett-Packard ("HP") warrants to the end-user customer ("Customer") that each HP Photosmart 2600/2700 series all-in-one product ("Product"), including related software, accessories, media, and supplies, shall be free from defects in material and workmanship for the duration, which begins on the date of purchase by the Customer.

For each hardware Product, the duration of HP's limited warranty is one year for parts and one year for labor. For all other Products, the duration of HP's limited warranty for both parts and labor is ninety days.

For each software Product, HP's limited warranty applies only to a failure to execute programming instructions. HP does not warrant that the operation of any Product shall be uninterrupted or error free.

HP's limited warranty covers only those defects which arise as a result of normal use of a Product, and does not cover any other problems, including those which arise as a result of (a) improper maintenance or modification, (b) software, accessories, media, or supplies not provided or supported by HP, or (c) operation outside the Product's specifications.

For any hardware Product, the use of a non-HP ink cartridge or a refilled ink cartridge does not affect either the warranty to the Customer or any HP support contract with the Customer.

However, if Product failure or damage is attributable to the use of a non-HP or refilled ink cartridge, HP shall charge its standard labor and materials charges to service the Product for the failure or damage.

If HP receives, during the applicable warranty period, notice of a defect in any Product, HP shall either repair or replace the defective Product, at HP's option. Where labor charges are not covered by HP's limited warranty, repairs shall be at HP's standard charges for labor.

If HP is unable to repair or replace, as applicable, a defective Product which is covered by HP's warranty, HP shall, within a reasonable time after being notified of the defect, refund the purchase price for the Product.

HP shall have no obligation to repair, replace, or refund until the Customer returns the defective Product to HP.

Any replacement product may be either new or like-new, provided that it has functionality at least equal to that of the Product being replaced.

HP products, including each Product, may contain remanufactured parts, components, or materials equivalent to new in performance.

HP's limited warranty for each Product is valid in any country/region or locality where the covered HP product is distributed by HP. Contracts for additional warranty service, such as on-site service, are available from any authorized HP service facility in countries/regions where the product is distributed by HP or by an authorized representative.

### Limitations of warranty

TO THE EXTENT ALLOWED BY LOCAL LAW, NEITHER HP NOR ITS THIRD PARTY SUPPLIERS MAKE ANY OTHER WARRANTY OR CONDITION OF ANY KIND, WHETHER EXPRESS OR IMPLIED, WARRANTIES OR CONDITIONS OF MERCHANTABILITY, SATISFACTORY QUALITY, AND FITNESS FOR A PARTICULAR PURPOSE.

### Limitations of liability

To the extent allowed by local law, the remedies provided in this Limited Warranty Statement are the Customer's sole and exclusive remedies.

TO THE EXTENT ALLOWED BY LOCAL LAW, EXCEPT FOR THE OBLIGATIONS SPECIFICALLY SET FORTH IN THIS LIMITED WARRANTY STATEMENT, IN NO EVENT SHALL HP OR ITS THIRD PARTY SUPPLIERS BE LIABLE FOR DIRECT, INDIRECT, SPECIAL, INCIDENTAL, OR CONSEQUENTIAL DAMAGES, WHETHER BASED ON CONTRACT, TORT,

OR ANY OTHER LEGAL THEORY AND WHETHER ADVISED OF THE POSSIBILITY OF SUCH DAMAGES.

### Local law

This Limited Warranty Statement gives the Customer specific legal rights. The Customer may also have other rights which vary from state to state in the United States, from province to province in Canada, and from country/region to country/region elsewhere in the world.

To the extent this Limited Warranty Statement is inconsistent with local law, this Statement shall be deemed modified to be consistent with such local law. Under such local law, certain disclaimers and limitations of this Statement may not apply to the Customer. For example, some states in the United States, as well as some governments outside the United States (including provinces in Canada), may:

Preclude the disclaimers and limitations in this Statement from limiting the statutory rights of a consumer (for example, the United Kingdom);

Otherwise restrict the ability of a manufacturer to enforce such disclaimers or limitations; or

Grant the Customer additional warranty rights, specify the duration of implied warranties which the manufacturer cannot disclaim, or not allow limitations on the duration of implied warranties.

FOR CONSUMER TRANSACTIONS IN AUSTRALIA AND NEW ZEALAND, THE TERMS IN THIS LIMITED WARRANTY STATEMENT, EXCEPT TO THE EXTENT LAWFULLY PERMITTED, DO NOT EXCLUDE, RESTRICT, OR MODIFY, AND ARE IN ADDITION TO, THE MANDATORY STATUTORY RIGHTS APPLICABLE TO THE SALE OF THE COVERED HP PRODUCTS TO SUCH CUSTOMERS.

### Limited warranty information for EU countries/regions

Listed below are the names and addresses of the HP entities which grant HP's Limited Warranty (manufacturer's warranty) in EU countries/regions.

**You may also have statutory legal rights against the seller on the basis of the purchase agreement in addition to the manufacturer's warranty, which are not restricted by this manufacturer's warranty.**

Belgique/Luxembourg Hewlett-Packard Belgium SA/NV Woluwedal 100 Boulevard de la Woluwe B-1200 Brussels	Ireland Hewlett-Packard Ireland Ltd. 30 Herbert Street IRL-Dublin 2
Danmark Hewlett-Packard A/S Kongevej 25 DK-3460 Birkerød	Nederland Hewlett-Packard Nederland BV Startbaan 16 1187 XR Amstelveen NL
France Hewlett-Packard France 1 Avenue du Canada Zone d'Activite de Courtaboeuf F-91947 Les Ulis Cedex	Portugal Hewlett-Packard Portugal - Sistemas de Informática e de Medida S.A. Edificio D. Sancho I Quinta da Fonte Porto Salvo 2780-730 Paco de Arcos P-Oeiras

## Chapter 18

(continued)

Deutschland Hewlett-Packard GmbH Herrenberger Straße 110-140 D-71034 Böblingen	Österreich Hewlett-Packard Ges.m.b.H. Lieblgasse 1 A-1222 Wien
España Hewlett-Packard Española S.A. Carretera Nacional VI km 16.500 28230 Las Rozas E-Madrid	Suomi Hewlett-Packard Oy Piispankalliontie 17 FIN-02200 Espoo
Greece Hewlett-Packard Hellas 265, Mesogion Avenue 15451 N. Psychiko Athens	Sverige Hewlett-Packard Sverige AB Skalholtsgatan 9S-164 97 Kista
Italia Hewlett-Packard Italiana S.p.A Via G. Di Vittorio 9 20063 Cernusco sul Naviglio I-Milano	United Kingdom Hewlett-Packard Ltd Cain Road Bracknell GB-Berks RG12 1HN

# 19 Technical information

This chapter provides information on accessing system requirements, paper specifications, print specifications, copy specifications, memory card specifications, scan specifications, physical specifications, power specifications, environmental specifications, regulatory notices, and the declaration of conformity for your HP all-in-one.

## System requirements

Software system requirements are located in the Readme file. For information on viewing the Readme file, see [View the Readme file](#).

## Paper specifications

This section contains information about paper-tray capacities, paper sizes, and print margin specifications.

### Paper-tray capacities

Type	Paper weight	Input tray <sup>1</sup>	Output tray <sup>2</sup>
Plain paper (15 mm)	16 to 24 lb. (60 to 90 gsm)	150 (20 lb. paper)	50 black (20 lb. paper) 20 color (20 lb. paper)
Index Cards	110 lb. index max (200 gsm)	30	30
Hagaki Cards (15 mm)	N/A	60	60
Envelopes (15 mm)	20 to 24 lb. (75 to 90 gsm)	21	10
Banners (4 mm)	16 to 24 lb. (60 to 90 gsm)	20	20 or fewer
Transparency film	N/A	25	25 or fewer
Labels (8 mm)	N/A	30	30
4 by 6 inch (10 by 15 cm) Photo Paper	145 lb. (236 gsm)	30	30
8.5 by 11 inch (216 by 279 mm) Photo Paper	N/A	20	20

1 Maximum capacity.

2 Output tray capacity is affected by the type of paper and the amount of ink you are using. HP recommends emptying the output tray frequently.

## Paper sizes

Type	Size
Paper	Letter: 216 by 279 mm (8.5 by 11 inches) A4: 210 by 297 mm (8.27 by 11.7 inches) A5: 148 by 210 mm (5.8 by 8.3 inches) Executive: 184.2 by 266.7 mm (7.25 by 10.5 inches) Legal <sup>1</sup> : 216 by 356 mm (8.5 by 14 inches)
Banner	HP Banner Paper, 90 g/m <sup>2</sup> (24 lb. Bond), A (C1820A) and A4 Size Third Party Z-Fold Computer Paper, 60-90 g/m <sup>2</sup> (16-24 lb. Bond), A and A4 size, with tractor perforations removed
Envelopes	U.S. #10: 104 by 241 mm (4.125 by 9.5 inches) A2: 111 by 146 mm (4.4 by 5.8 inches) DL: 110 by 220 mm (4.3 by 8.7 inches) C6: 114 by 162 mm (4.5 by 6.4 inches)
Transparency film	Letter: 216 by 279 mm (8.5 by 11 inches) A4: 210 by 297 mm
Photo paper	102 by 152 mm (4 by 6 inches) 127 by 178 mm (5 by 7 inches) Letter: 216 by 279 mm (8.5 by 11 inches) A4: 210 by 297 mm (8.27 by 11.7 inches)
Cards	Index card: 76.2 by 127 mm (3 by 5 inches) Index card: 101 by 152 mm (4 by 6 inches) Index card: 127 by 203.2 mm (5 by 8 inches) 127 by 178 mm (5 by 7 inches) A6: 105 by 148.5 mm (4.13 by 5.85 inches) Hagaki postcard: 100 by 148 mm (3.94 by 5.83 inches)
Labels	Letter: 216 by 279 mm (8.5 by 11 inches) A4: 210 by 297 mm (8.27 by 11.7 inches)
Custom	76 by 127 mm up to 216 by 356 mm (3 by 5 inches up to 8.5 by 14 inches)

<sup>1</sup> 20 lb. and up

## Print margin specifications

	Top (leading edge)	Bottom (trailing edge) <sup>1</sup>	Left	Right
U.S. (Letter, Legal)	1.8 mm (0.07 inches)	3 mm (0.12 inches)	3.2 mm (0.13 inches)	3.2 mm (0.13 inches)
Executive	1.8 mm (0.07 inches)	6 mm (0.24 inches)	3.2 mm (0.13 inches)	3.2 mm (0.13 inches)

(continued)

	Top (leading edge)	Bottom (trailing edge) <sup>1</sup>	Left	Right
ISO (A4, A5) and JIS (B5)	1.8 mm (0.07 inches)	6.0 mm (0.2 inches)	3.2 mm (0.13 inches)	3.2 mm (0.13 inches)
Envelopes	1.8 mm (0.07 inches)	14.3 mm (0.5 inches)	3.2 mm (0.13 inches)	3.2 mm (0.13 inches)
Index Card (3 by 5 inch, 4 by 6 inch, 5 by 8 inch)	1.8 mm (0.07 inches)	6.0 mm (0.2 inches)	3.2 mm (0.13 inches)	3.2 mm (0.13 inches)
Non-index 4 by 6 inch card	3.2 mm (0.13 inches)	3 mm (0.12 inches)	3.2 mm (0.13 inches)	3.2 mm (0.13 inches)
A6 card	1.8 mm (0.07 inches)	6 mm (0.24 inches)	3.2 mm (0.13 inches)	3.2 mm (0.13 inches)
4 by 6 inch photo paper	3.2 mm (0.13 inches)	3.2 mm (0.13 inches)	3.2 mm (0.13 inches)	3.2 mm (0.13 inches)

1 This margin is not compatible; however, the total writing area is compatible. The writing area is offset from center by 5.4 mm (0.21 inches), which causes asymmetric top and bottom margins.

## Print specifications

- 1200 by 1200 dpi black
- 1200 by 1200 dpi color graphics resolution
- Print speeds vary according to the complexity of the document
- Panorama-size printing
- Method: drop-on-demand thermal inkjet
- Language: HP PCL Level 3, PCL3 GUI or PCL 10
- Optional photo print cartridge and grey photo print cartridge
- Duty cycle: 500 printed pages per month (average)
- Duty cycle: 1250 printed pages per month (maximum)

Mode		Resolution (dpi)	Speed (ppm) on plain paper	Speed (seconds) 4 by 6 inch borderless photo
Maximum dpi	Black and Color	1200 by 1200 up to 4800 dpi optimized <sup>1</sup>	0.5	150
Best	Black and Color	1200 by 1200 <sup>2</sup>	2.1	96
Normal	Black	600 by 600	9.8	53
	Color	600 by 600	5.7	53
Fast Normal	Black	600 by 600	11.6	33
	Color	600 by 600	7.4	33
Fast Draft	Black	300 by 300	30	27

Mode		Resolution (dpi)	Speed (ppm) on plain paper	Speed (seconds) 4 by 6 inch borderless photo
	Color	300 by 300	20	27

- 1 Up to 4800 by 1200 optimized dpi color printing. Adding a photo print cartridge increases print quality
- 2 PhotoREt color printing with photo paper.

## Copy specifications

- Digital image processing
- Up to 99 copies from original (varies by model)
- Digital zoom from 25 to 400% (varies by model)
- Fit to page, Poster, Many on page
- Up to 30 copies per minute black; 20 copies per minute color (varies by model)
- Copy speeds vary according to the complexity of the document

Mode		Speed (ppm)	Print resolution (dpi)	Scan resolution (dpi)
Best	Black	up to 0.8	1200 by 1200	1200 by 1200 <sup>1</sup>
	Color	up to 0.8	1200 by 1200 up to 4800 dpi optimized <sup>1</sup>	1200 by 1200 <sup>1</sup>
Normal	Black	up to 9.8	600 by 600	300 by 300
	Color	up to 5.7	600 by 600	300 by 300
Fast	Black	up to 30	300 by 300	300 by 300
	Color	up to 20	300 by 300	300 by 300

- 1 On premium photo paper.

## Fax specifications

- Walk-up black and white and color fax capability
- Up to 75 speed dials (varies by model)
- Up to 90-page memory (varies by model, based on ITU-T Test Image #1 at standard resolution). More complicated pages or higher resolution will take longer and use more memory.
- Manual multiple-page fax
- Automatic busy redial up to five times (varies by model)
- Automatic no-answer redial one time (varies by model)
- Confirmation and activity reports
- CCITT/ITU Group 3 fax with Error Correction Mode
- 33.6 Kbps transmission
- 3 seconds per page speed at 33.6 Kbps (based on ITU-T Test Image #1 at standard resolution). More complicated pages or higher resolution take longer and use more memory
- Ring detect with automatic fax/answering machine switching

	Photo (dpi)	Fine (dpi)	Standard (dpi)
Black	200 by 200	200 by 200	200 by 100

(continued)

	Photo (dpi)	Fine (dpi)	Standard (dpi)
Color	200 by 200	200 by 200	200 by 200

## Memory card specifications

- Maximum recommended number of files on a memory card: 1,000
- Maximum recommended individual file size: 12 megapixel maximum, 8 MB maximum
- Maximum recommended memory card size: 1 GB (solid state only)

**Note** Approaching any of the recommended maximums on a memory card might cause the performance of the HP all-in-one to be slower than expected.

### Supported memory card types

- CompactFlash
- SmartMedia
- Memory Stick
- Memory Stick Duo
- Memory Stick Pro
- Secure Digital
- MultiMediaCard (MMC)
- xD-Picture Card

## Scan specifications

- Image editor included
- Integrated OCR software automatically converts scanned text to editable text
- Scan speeds vary according to the complexity of the document
- Twain-compliant interface
- Resolution: 2400 by 4800 dpi optical, up to 19,200 dpi enhanced
- Color: 48-bit color, 8-bit grayscale (256 levels of gray)
- Maximum scan size from glass: 8.5 by 11.7 inches (216 by 297 mm)

## Physical specifications

- Height: 21.21 cm (8.35 inches) (color graphics display in the down position)
- Width: 46.4 cm (18.3 inches)
- Depth: 37.2 cm (14.7 inches)  
49 cm (19.3 inches) (HP Automatic Two-sided Printing Accessory attached)
- Weight: 8.5 kg (18.75 pounds)  
10.8 kg (23.75 pounds) (HP Automatic Two-sided Printing Accessory and optional HP 250 Sheet Plain Paper Tray attached)

## Power specifications

- Power consumption: 75 W maximum
- Input voltage: AC 100 to 240 V ~ 2 A 50–60 Hz, grounded
- Output voltage: DC 31Vdc===2420 mA

## Environmental specifications

- Recommended operating temperature range: 15° to 32° C (59° to 90° F)
- Allowable operating temperature range for the HP all-in-one: 5° to 40° C (41° to 104° F)
- Allowable operating temperature range for the printing system: -15° to 35° C (5° to 104° F)
- Humidity: 15% to 85% RH non-condensing
- Non-operating (Storage) temperature range: -4° to 60° C (-40° to 140° F)



- In the presence of high electromagnetic fields it is possible the output from the HP all-in-one may be slightly distorted
- HP recommends using a USB cable less than or equal to 3 m (10 feet) in length to minimize injected noise due to potential high electromagnetic fields

## Additional specifications

Memory: 16 MB ROM, 64 MB DRAM

If you have Internet access, you can get acoustic information from the HP website. Go to: [www.hp.com/support](http://www.hp.com/support).

## Environmental product stewardship program

This section provides information on protecting the environment; ozone production; energy consumption; paper use; plastics; material safety data sheets; and recycling programs.

This section contains information about environmental standards.

### Protecting the environment

Hewlett-Packard is committed to providing quality products in an environmentally sound manner. This product has been designed with several attributes to minimize impacts on our environment. For more information, visit HP's Commitment to the Environment website at:

[www.hp.com/hpinfo/globalcitizenship/environment/index.html](http://www.hp.com/hpinfo/globalcitizenship/environment/index.html)

### Ozone production

This product generates no appreciable ozone gas (O<sub>3</sub>).

### Energy consumption

Energy usage drops significantly while in ENERGY STAR® mode, which saves natural resources, and saves money without affecting the high performance of this product. This product qualifies for ENERGY STAR, which is a voluntary program established to encourage the development of energy-efficient office products.



ENERGY STAR is a U.S. registered service mark of the U.S. EPA. As an ENERGY STAR partner, HP has determined that this product meets ENERGY STAR guidelines for energy efficiency.

For more information on ENERGY STAR guidelines, go to the following website:

[www.energystar.gov](http://www.energystar.gov)

### Paper use

This product is suited for the use of recycled paper according to DIN 19309.

### Plastics

Plastic parts over 25 grams are marked according to international standards that enhance the ability to identify plastics for recycling purposes at the end of the product's life.

### Material safety data sheets

Material safety data sheets (MSDS) can be obtained from the HP website at:

[www.hp.com/go/msds](http://www.hp.com/go/msds)

Customers without Internet access should contact their local HP Customer Care Center.

## Recycling program

HP offers an increasing number of product return and recycling programs in many countries, as well as partnering with some of the largest electronic recycling centers throughout the world. HP also conserves resources by refurbishing and reselling some of its most popular products.

This HP product contains the following materials that may require special handling at end-of-life:

- Mercury in the fluorescent lamp in the scanner (< 2 mg)
- Lead in the solder

## HP inkjet supplies recycling program

HP is committed to protecting the environment. The HP Inkjet Supplies Recycling Program is available in many countries/regions, and lets you recycle used print cartridges free of charge. For more information, go to the following website:

[www.hp.com/hpinfo/globalcitizenship/environment/recycle/inkjet.html](http://www.hp.com/hpinfo/globalcitizenship/environment/recycle/inkjet.html)

## Regulatory notices

The HP all-in-one meets product requirements from regulatory agencies in your country/region.

This section contains regulatory topics that do not pertain to wireless functions.

### Regulatory model identification number

For regulatory identification purposes, your product is assigned a Regulatory Model Number. The Regulatory Model Number for your product is SDGOB-0304-01/SDGOB-0304-02. This regulatory number should not be confused with the marketing name (HP Photosmart 2600/2700 series all-in-one) or product number (Q3450A/Q3452A).

### Notice to users of the U.S. telephone network: FCC requirements

This equipment complies with FCC rules, Part 68. On this equipment is a label that contains, among other information, the FCC Registration Number and Ringer Equivalent Number (REN) for this equipment. If requested, provide this information to your telephone company.

An FCC compliant telephone cord and modular plug is provided with this equipment. This equipment is designed to be connected to the telephone network or premises wiring using a compatible modular jack which is Part 68 compliant. This equipment connects to the telephone network through the following standard network interface jack: USOC RJ-11C.

The REN is useful to determine the quantity of devices you may connect to your telephone line and still have all of those devices ring when your number is called. Too many devices on one line may result in failure to ring in response to an incoming call. In most, but not all, areas the sum of the RENs of all devices should not exceed five (5). To be certain of the number of devices you may connect to your line, as determined by the REN, you should call your local telephone company to determine the maximum REN for your calling area.

If this equipment causes harm to the telephone network, your telephone company may discontinue your service temporarily. If possible, they will notify you in advance. If advance notice is not practical, you will be notified as soon as possible. You will also be advised of your right to file a complaint with the FCC. Your telephone company may make changes in its facilities, equipment, operations, or procedures that could affect the proper operation of your equipment. If they do, you will be given advance notice so you will have the opportunity to maintain uninterrupted service.

If you experience trouble with this equipment, please contact the manufacturer, or look elsewhere in this manual, for warranty or repair information. Your telephone company may ask you to disconnect this equipment from the network until the problem has been corrected or until you are sure that the equipment is not malfunctioning.

This equipment may not be used on coin service provided by the telephone company. Connection to party lines is subject to state tariffs. Contact your state public utility commission, public service commission, or corporation commission for more information.

This equipment includes automatic dialing capability. When programming and/or making test calls to emergency numbers:

- Remain on the line and explain to the dispatcher the reason for the call.
- Perform such activities in the off-peak hours, such as early morning or late evening.

**Note** The FCC hearing aid compatibility rules for telephones are not applicable to this equipment.

The Telephone Consumer Protection Act of 1991 makes it unlawful for any person to use a computer or other electronic device, including fax machines, to send any message unless such message clearly contains in a margin at the top or bottom of each transmitted page or on the first page of transmission, the date and time it is sent and an identification of the business, other entity, or other individual sending the message and the telephone number of the sending machine or such business, other entity, or individual. (The telephone number provided may not be a 900 number or any other number for which charges exceed local or long-distance transmission charges.) In order to program this information into your fax machine, you should complete the steps described in the software.

### FCC statement

The United States Federal Communications Commission (in 47 CFR 15.105) has specified that the following notice be brought to the attention of users of this product.

Declaration of Conformity: This equipment has been tested and found to comply with the limits for a Class B digital device, pursuant to part 15 of the FCC Rules. Operation is subject to the following two conditions: (1) this device may not cause harmful interference, and (2) this device must accept any interference received, including interference that may cause undesired operation. Class B limits are designed to provide reasonable protection against harmful interference in a residential installation. This equipment generates, uses, and can radiate radio frequency energy, and, if not installed and used in accordance with the instructions, may cause harmful interference to radio communications. However, there is no guarantee that interference will not occur in a particular installation. If this equipment does cause harmful interference to radio or television reception, which can be determined by turning the equipment off and on, the user is encouraged to try to correct the interference by one or more of the following measures:

- Reorient the receiving antenna.
- Increase the separation between the equipment and the receiver.
- Connect the equipment into an outlet on a circuit different from that to which the receiver is connected.
- Consult the dealer or an experienced radio/TV technician for help.

For more information, contact the Product Regulations Manager, Hewlett-Packard Company, San Diego, (858) 655-4100.

The user may find the following booklet prepared by the Federal Communications Commission helpful: How to Identify and Resolve Radio-TV Interference Problems. This booklet is available from the U.S. Government Printing Office, Washington DC, 20402. Stock No. 004-000-00345-4.



**Caution** Pursuant to Part 15.21 of the FCC Rules, any changes or modifications to this equipment not expressly approved by the Hewlett-Packard Company may cause harmful interference and void the FCC authorization to operate this equipment.

### Exposure to radio frequency radiation



**Caution** The radiated output power of this device is far below the FCC radio frequency exposure limits. Nevertheless, the device shall be used in such a manner that the potential for human contact during normal operation is minimized. This product and any attached external antenna, if supported, shall be placed in such a manner to minimize the potential for human contact during normal operation. In order to avoid the possibility of exceeding the FCC radio frequency exposure limits, human proximity to the antenna shall not be less than 20 cm (8 inches) during normal operation.

## Note à l'attention des utilisateurs du réseau téléphonique Canadien/notice to users of the Canadian telephone network

Cet appareil est conforme aux spécifications techniques des équipements terminaux d'Industrie Canada. Le numéro d'enregistrement atteste de la conformité de l'appareil. L'abréviation IC qui précède le numéro d'enregistrement indique que l'enregistrement a été effectué dans le cadre d'une Déclaration de conformité stipulant que les spécifications techniques d'Industrie Canada ont été respectées. Néanmoins, cette abréviation ne signifie en aucun cas que l'appareil a été validé par Industrie Canada.

Pour leur propre sécurité, les utilisateurs doivent s'assurer que les prises électriques reliées à la terre de la source d'alimentation, des lignes téléphoniques et du circuit métallique d'alimentation en eau sont, le cas échéant, branchées les unes aux autres. Cette précaution est particulièrement importante dans les zones rurales.

Le numéro REN (Ringer Equivalence Number) attribué à chaque appareil terminal fournit une indication sur le nombre maximal de terminaux qui peuvent être connectés à une interface téléphonique. La terminaison d'une interface peut se composer de n'importe quelle combinaison d'appareils, à condition que le total des numéros REN ne dépasse pas 5.

Basé sur les résultats de tests FCC Partie 68, le numéro REN de ce produit est 0.2B.

This equipment meets the applicable Industry Canada Terminal Equipment Technical Specifications. This is confirmed by the registration number. The abbreviation IC before the registration number signifies that registration was performed based on a Declaration of Conformity indicating that Industry Canada technical specifications were met. It does not imply that Industry Canada approved the equipment.

Users should ensure for their own protection that the electrical ground connections of the power utility, telephone lines and internal metallic water pipe system, if present, are connected together. This precaution may be particularly important in rural areas.

**Note** The Ringer Equivalence Number (REN) assigned to each terminal device provides an indication of the maximum number of terminals allowed to be connected to a telephone interface. The termination on an interface may consist of any combination of devices subject only to the requirement that the sum of the Ringer Equivalence Numbers of all the devices does not exceed 5.

The REN for this product is 0.2B, based on FCC Part 68 test results.

## Notice to users in the European Economic Area



This product is designed to be connected to the analog Switched Telecommunication Networks (PSTN) of the European Economic Area (EEA) countries/regions.

Network compatibility depends on customer selected settings, which must be reset to use the equipment on a telephone network in a country/region other than where the product was purchased. Contact the vendor or Hewlett-Packard Company if additional product support is necessary.

This equipment has been certified by the manufacturer in accordance with Directive 1999/5/EC (annex II) for Pan-European single-terminal connection to the public switched telephone network (PSTN). However, due to differences between the individual PSTNs provided in different countries, the approval does not, of itself, give an unconditional assurance of successful operation on every PSTN network termination point.

In the event of problems, you should contact your equipment supplier in the first instance.

This equipment is designed for DTMF tone dialing and loop disconnect dialing. In the unlikely event of problems with loop disconnect dialing, it is recommended to use this equipment only with the DTMF tone dial setting.

### Notice to users of the German telephone network

This HP fax product is designed to connect only to the analogue public-switched telephone network (PSTN). Please connect the TAE N telephone connector plug, provided with the HP all-in-one into the wall socket (TAE 6) code N. This HP fax product can be used as a single device and/or in combination (in serial connection) with other approved terminal equipment.

### Geräuschemission

LpA < 70 dB am Arbeitsplatz im Normalbetrieb nach DIN 45635 T. 19

### Notice to users in Japan (VCCI-2)

この装置は、情報処理装置等電波障害自主規制協議会（VCCI）の基準に基づくクラスB情報技術装置です。この装置は、家庭環境で使用することを目的としていますが、この装置がラジオやテレビジョン受信機に近接して使用されると受信障害を引き起こすことがあります。  
取り扱い説明書に従って正しい取り扱いをして下さい。

### Notice to users in Korea

## 사용자 안내문(B급 기기)

이 기기는 비업무용으로 전자파 적합 등록을 받은 기기로서, 주거지역에서는 물론 모든 지역에서 사용할 수 있습니다.

## Regulatory notices for wireless products

This section contains regulatory information pertaining to wireless products.

### Note à l'attention des utilisateurs Canadien/notice to users in Canada

**For Indoor Use.** This digital apparatus does not exceed the Class B limits for radio noise emissions from the digital apparatus set out in the Radio Interference Regulations of the Canadian Department of Communications. The internal wireless radio complies with RSS 210 of Industry Canada.

**For Indoor Use.** Le présent appareil numérique n'émet pas de bruit radioélectrique dépassant les limites applicables aux appareils numériques de la classe B prescrites dans le Règlement sur le brouillage radioélectrique édicté par le ministère des Communications du Canada. Le composant RF interne est conforme à la norme CDN-210 d'Industrie Canada.

この機器の使用周波数帯では、電子レンジ等の産業・科学・医療用機器のほか工場の製造ライン等で使用されている移動体識別用の構内無線局（免許を要する無線局）及び特定小電力無線局（免許を要しない無線局）が運用されています。

- 1 この機器を使用する前に、近くで移動体識別用の構内無線局及び特定小電力無線局が運用されていないことを確認して下さい。
- 2 万一、この機器から移動体識別用の構内無線局に対して電波干渉の事例が発生した場合には、速やかに使用周波数を変更するか又は電波の発射を停止した上、下記連絡先にご連絡頂き、混信回避のための処置等（例えば、パーティションの設置など）についてご相談して下さい。
- 3 その他、この機器から移動体識別用の特定小電力無線局に対して電波干渉の事例が発生した場合など何かお困りのことが起きたときは、次の連絡先へお問い合わせ下さい。

連絡先：日本ヒューレット・パッカード株式会社 TEL：0120-014121

2.4DS4

### Notice to users in Italy

License required for use. Verify with your dealer or directly with General Direction for Frequency Planning and Management (Direzione Generale Pianificazione e Gestione Frequenze).

E' necessaria una concessione ministeriale anche per l'uso del prodotto. Verifici per favore con il proprio distributore o direttamente presso la Direzione Generale Pianificazione e Gestione Frequenze.

### Notice to users in France

For 2.4 GHz Wireless LAN operation of this product certain restrictions apply: This equipment may be used indoor for the entire 2400-2483.5 MHz frequency band (channels 1-13). For outdoor use, only 2454-2483.5 MHz frequency band (channels 10-13) may be used. For the latest requirements, see [www.art-telecom.fr](http://www.art-telecom.fr).

Pour une utilisation en rseau sans fil 2,4 GHz de ce produit, certaines restrictions s'appliquent : cet appareil peut tre utilis l'intrieur des btiments sur toute la bande de frquences 2400-2483,5 MHz (canaux 1 13). Pour une utilisation l'extrieur des btiments, seule la partie 2454-2483,5 MHz (canaux 10 13) peut tre utilise. Pour connatre les dernires rglementations en vigueur, consultez le site Web [www.art-telecom.fr](http://www.art-telecom.fr).

### Notice to users in the European Economic Area (wireless products)

Radio products with the CE 0984 or CE alert marking comply with the R&TTE Directive (1999/5/EC) issued by the Commission of the European Community.

**Note** Low-power radio LAN product operating in 2.4-GHz band, for Home and Office environments. In some countries/regions, using the product may be subject to specific restrictions as listed for specific countries/regions below.

This product may be used in the following EU and EFTA countries/regions: Austria, Belgium, Denmark, Finland, Germany, Greece, Iceland, Ireland, Italy, Liechtenstein, Luxembourg, Netherlands, Norway, Portugal, Sweden, Switzerland and United Kingdom. For normal wireless LAN operation of this product, only a limited band is available in France (Channels 10, 11, 12 and 13). L'Autorité de régulation des télécommunications (ART) has special regulations for hotspots allowing additional channels. For more information, including local rulings and authorization, please see the ART website : [www.art-telecom.fr](http://www.art-telecom.fr).

## Declaration of conformity (European Economic Area)

The Declaration of Conformity in this document complies with ISO/IEC Guide 22 and EN 45014. It identifies the product, manufacturer's name and address, and applicable specifications recognized in the European community.

## HP Photosmart 2600series declaration of conformity



### DECLARATION OF CONFORMITY

according to ISO/IEC Guide 22 and EN 45014

**Manufacturer's Name:** Hewlett-Packard Company

**Manufacturer's Address:** 16399 West Bernardo Drive  
San Diego CA 92127, USA

**declares, that the product**

**Regulatory Model Number:** SDGOB-0304-01

**Product Name:** Photosmart 2600 Series (Q3450A)

**Model Number(s):** 2610 (Q5542A/B, Q5548C), 2610xi (Q5543A), 2608 (Q5541D),  
2610v (Q5550A), 2605 (Q5551A/B), 2615 (Q5553B), 2613 (Q5546C)

**Power Adapter(s) HP part#:** 0950-4483 (domestic)  
0950-4484 (international)

**conforms to the following Product Specifications:**

**Safety:** IEC 60950-1: 2001  
EN 60950-1: 2002  
IEC 60825-1 Edition 1.2: 2001 / EN 60825-1+A11+A2+A1: 2002 Class 1(Laser/Led)  
UL 60950-1: 2003  
CAN/CSA-22.2 No. 60950-1-03  
NOM 019-SFCI-1993, AS/NZS 60950: 2000, GB4943: 2001

**EMC:** CISPR 22:1997 / EN 55022:1998 Class B  
CISPR 24:1997 / EN 55024:1998  
IEC 61000-3-2: 2000 / EN 61000-3-2: 2000  
IEC 61000-3-3/A1: 2001 / EN 61000-3-3/ A1: 2001  
CNS13438:1998, VCCI-2  
FCC Part 15-Class B/ICES-003, Issue 2  
GB9254: 1998

**Telecom:** TBR 21:1998, AS/ACIF S002:2001, FCC Part 68

#### Supplementary Information:

The product herewith complies with the requirements of the Low Voltage Directive 73/23/EC, the EMC Directive 89/336/EC and with the R&TTE Directive 1999/5/EC (Annex II) and carries the CE-marking accordingly. The product was tested in a typical configuration.

11 March 2004

Date

Steve Smith, Hardware Test & Regs MGR.

European Contact for regulatory topics only: Hewlett Packard GmbH, HQ-TRE, Herrenberger Strasse 140,  
D-71034 Böblingen Germany, FAX +49-7031-14-3143

# HP Photosmart 2700series declaration of conformity



## DECLARATION OF CONFORMITY

according to ISO/IEC Guide 22 and EN 45014

**Manufacturer's Name:** Hewlett-Packard Company

**Manufacturer's Address:** 16399 West Bernardo Drive  
San Diego CA 92127, USA

**Declares, that the product**

**Regulatory Model Number:** SDGOB-0304-02

**Product Name:** Photosmart 2700 Series (**Q3452A**)

**Model Number(s):** 2710 (Q5552A/B, Q5545C), 2710xi (Q5544A), 2713 (Q5547C)

**Power Adapter(s) HP part#:** 0950-4483 (domestic), 0950-4484 (international)

**Radio Module Model No:** RSULD-0303

**Conforms to the following Product Specifications:**

**Safety:** IEC 60950-1: 2001  
EN 60950-1: 2002  
IEC 60825-1 Edition 1.2: 2001 / EN 60825-1+A11+A2+A1: 2002 Class 1(Laser/Led)  
UL 60950-1: 2003  
CAN/CSA-22.2 No. 60950-1-03  
NOM 019-SFCI-1993, AS/NZS 60950: 2000, GB4943: 2001

**EMC:** CISPR 22:1997 / EN 55022:1998 Class B  
CISPR 24:1997 / EN 55024:1998  
IEC 61000-3-2: 2000 / EN 61000-3-2: 2000  
IEC 61000-3-3/A1: 2001 / EN 61000-3-3/ A1: 2001  
CNS13438:1998, VCCI-2  
FCC Part 15-Class B/ICES-003, Issue 2  
GB9254: 1998,  
EN 301 489-17 v1.2.1 (2002)

**Telecom:** Option for Analogue modem: TBR 21:1998 / AS/ACIF S008: 2001/ FCC Part 68

Option for Radio Link: EN 300 328-2 v1.2.1 (2001),  
Equipment Class 2, R&TTE Directive Annex 4

Notified Body Number – 0984 

**Health:** EU: 1999/519/EC

**Supplementary Information:**

The product herewith complies with the requirements of the Low Voltage Directive 73/23/EC, the EMC Directive 89/336/EC and with the R&TTE Directive 1999/5/EC (Annex 2/4) and carries the CE-marking accordingly. The product was tested in a typical configuration.

11 March 2004

Date

European Contact for regulatory topics only:

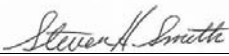

Steve Smith, Hardware Test & Regs MGR.

Hewlett Packard GmbH, HQ-TRE, Herrenberger Strasse 140,  
D-71034, Böblingen, Germany . FAX +49-7031-14-3143





# Index

## Symbols/Numerics

- 10 by 15 cm photo paper
  - load 39
  - specifications 217
- 2-wire phone cord 184, 189
- 4 by 6 inch photo paper,
  - load 39
- 4-wire phone cord 184, 189

## A

- A4 paper, load 37
- access list, HP Instant Share 136, 148
- accessories, order 151
- ADSL line. *see* DSL line
- align print cartridges 164
- answer mode 105
- answer ring pattern 85, 119
- answering machine
  - receive faxes 105
  - setup 94, 95
  - troubleshoot 188
- auto checking 143
- auto print 144
- automatic fax reports 115

## B

- banner paper
  - load 42
  - specifications 217
- baud rate 122
- best copy quality 61
- blocked carriage 175
- Bluetooth
  - accessibility 23
  - connect to your HP all-in-one 22
  - passkey authentication 23
  - security settings 23
- borderless copies
  - fill entire page 63
  - photo 63
- borderless photos
  - print from memory card 54

## C

- cancel
    - button 7
    - copy 68
    - fax 124
    - print job 77
    - scan 73
  - carriage, blocked 175
  - cartridges. *see* print cartridges
  - clean
    - exterior 156
    - glass 155
    - lid backing 155
    - print cartridge
      - contacts 165
      - print cartridge ink nozzle area 166
    - print cartridges 165
  - color
    - copies 66
    - intensity 65
  - color graphics display
    - change language 172
    - change measurements 172
    - icons 8
    - screen saver 9
  - CompactFlash memory card 45
  - computer modem. *see* PC modem
  - confirmation reports, fax 115
  - connect USB cable 171
  - connection problems, fax 184, 186
  - connection types supported
    - Bluetooth adapter 22
    - Ethernet 21
    - USB 21
    - wireless 22
  - contrast, fax 118
  - control panel
    - enter text 113
    - overview 6
  - copy
    - black-and-white documents 62
  - cancel 68
  - color intensity 65
  - default settings 62
  - enhance light areas 66
  - enlarge into poster 67
  - iron-on transfer 68
  - menu 10
  - menu button 8
  - number of copies 62
  - paper size 59
  - paper types,
    - recommended 60
  - photos onto letter paper 63
  - photos, enhance 66
  - quality 61
  - several on one page 64
  - specifications 220
  - speed 61
  - text, enhance 66
- correct port test, fax 182
- customer support
  - Australia 206
  - before you call 169
  - contact 203
  - HP Quick Exchange Service (Japan) 208
  - Japan 207
  - Korea 207
  - North America 204
  - outside U.S. 204
  - serial number 203
  - service ID 203
  - warranty 213
  - website 203

## D

- darken
  - copies 65
  - faxes 118
- date, set 112
- declaration of conformity
  - European Economic Area 228
  - HP Photosmart 2600 series 228
  - HP Photosmart 2700 series 229

- default settings
    - fax 118
    - restore 168
  - destination file
    - send photos 139
  - destinations
    - create 135
    - manage 148
  - device update
    - about 201
    - Macintosh 202
    - Windows 201
  - dial tone test, failure 183
  - digital camera
    - PictBridge 55
  - distinctive ringing 85, 105, 119
  - DNS. *see* domain name server
  - domain name server
    - check IP address 196, 197
  - down arrow 8
  - DPOF file 55
  - DSL line, set up with fax 84
- E**
- embedded Web server 196
  - enter text 113
  - envelopes
    - load 41
    - specifications 217
  - environment
    - Environmental product stewardship program 222
    - environmental specifications 221
  - error correction mode (ECM) 121
  - error reports, fax 115
  - EWS. *see* embedded Web server
- F**
- factory defaults, restore 168
  - fast copy quality 61
  - fax
    - answer call 112
    - answer mode, set 105, 107
    - answer ring pattern 119
    - answering machine 94, 95, 186, 188
    - auto answer, set 105, 107
    - backup fax reception 121
    - cancel 124
    - contrast 118
    - date and time 112
    - defaults 118
    - delete 123
    - distinctive ringing 85, 105, 119
    - DSL line, set up 84
    - enter text and symbols 113
    - error correction mode (ECM) 121
    - full 201
    - header 113
    - Internet, over 123, 190
    - ISDN line, set up 85
    - lighten or darken 118
    - manual receive 112
    - manual send 108, 186
    - memory 201
    - memory is full 201
    - menu 11
    - menu button 8
    - monitor dialing 110
    - paper size 119
    - pause 113
    - PBX system, set up 85
    - PC modem, set up 89, 90, 95, 99
    - phone cord 181, 184, 189
    - receive 111
    - redial 109, 120
    - reduce automatically 120
    - reports 102, 108, 115
    - reprint 123
    - resolution 117
    - rings to answer 111
    - send 107
    - set up 79, 180
    - settings 117, 118
    - specifications 220
    - speed 122
    - speed dial 110, 116, 117
    - static on the phone line 189
    - test 102, 180
    - test failed 181
    - tone or pulse dial 119
    - troubleshoot 180
    - voice mail, set up 88, 99
    - volume 119
  - FCC requirements 223
  - FCC statement 224
  - fill entire page 63
  - fit to page 65
  - FoIP 123, 190
  - four-wire phone cord 184, 189
- G**
- glass
    - clean 155
    - load original 35
  - greeting cards, load 42
- H**
- Hagaki cards, load 40
  - hardware setup
    - troubleshoot 170
  - hardware test, fax 181
  - header, fax 113
  - HP all-in-one
    - about 5
    - return 208
  - HP Director
    - HP Instant Share 131
    - missing icons 177
    - start 12
  - HP Gallery
    - OS 9 HP Image Zone 17
    - OS X HP Image Zone 15
  - HP help (OS 9 HP Image Zone) 18
  - HP Image Print (OS X HP Image Zone) 15
  - HP Image Zone
    - button (Windows) 13
    - HP Instant Share 129, 130, 140
    - Macintosh 14, 16, 130
    - overview 12
    - send images 140
    - Windows 12, 129
  - HP Instant Share
    - access list 136
    - auto checking 143
    - auto print 136, 144
    - cancel print jobs 147
    - cancel sending images 140
    - connection errors 195
    - connection lost 198
    - destination file 139
    - destinations 135, 192
    - destinations not authorized 198
    - e-mail 57, 71

- e-mail images from
    - HP Image Zone (network) 140
  - e-mail photos from a memory card (USB) 126
  - e-mail photos from memory card (network) 138
  - e-mail photos from the HP Image Zone (USB) 129
  - Error Report 200
  - file corrupted 200
  - file size exceeded 200
  - general errors 194
  - HP Image Zone 129, 140
  - HP remote printing 135, 147
  - icons 9
  - login failed 199
  - manage account 148
  - manually print images 144
  - menu 11
  - minimum install 190
  - network-connected 58
  - Not set up 191
  - online albums 57
  - Open mode 134, 136, 142
  - Options menu 148
  - overview 125, 133
  - preview images 144
  - print images 143
  - print options 145
  - Private mode 134, 136, 143
  - quality prints 57
  - receive from allowed senders 143
  - receive from any sender 142
  - receive images 134, 142
  - remove images 147
  - scan images 71
  - send
    - images 57, 71, 126, 133, 137, 198
    - send images from HP image Zone (USB) 129
    - send photos from a memory card (network) 138
    - send photos from a memory card (USB) 126
    - send scanned images 128, 139
    - send to a device 71, 126, 129, 135, 137, 140
    - service discontinued 199
    - service unavailable 199
    - setup (networked) 135
    - setup (USB) 126
    - storage limit exceeded 199
    - troubleshoot error messages 194
    - troubleshoot setup 190
    - USB-connected 57
  - HP Instant Share
  - HP on the Web (OS 9 HP Image Zone) 18
  - HP remote printing
    - how to remote print 147
    - overview 135
- I**
- individual speed dial entries 116
  - ink cartridges. *see* print cartridges
  - ink level icons 9
  - ink levels, check 156
  - input tray
    - capacities 217
    - select 61
  - install device software 191
  - installation problems 170
  - Instant Share. *see* HP Instant Share
  - Internet, fax using 123, 190
  - iron-on iron-on transfers
    - copy 68
  - iron-on transfers
    - load 42
  - ISDN line, set up 85
- J**
- jams, paper 43, 175, 193
- K**
- keypad 8, 113
- L**
- labels
    - load 42
    - specifications 217
  - left arrow 8
  - legal paper
    - load 37
    - specifications 217
  - letter paper
    - load 37
    - specifications 217
  - lid backing, clean 155
  - lighten
    - copies 65
    - faxes 118
  - line condition test, fax 182
  - load
    - 10 by 15 cm photo paper 39
    - 4 by 6 inch photo paper 39
    - A4 paper 37
    - banner paper 42
    - envelopes 41
    - full-size paper 37
    - greeting cards 42
    - Hagaki cards 40
    - iron-on transfers 42
    - labels 42
    - legal paper 37
    - letter paper 37
    - original 35
    - postcards 40
    - transparencies 42
- M**
- Magic Gate Memory Stick 45
  - maintenance
    - align print cartridges 164
    - check ink levels 156
    - clean exterior 156
    - clean glass 155
    - clean lid backing 155
    - clean print cartridges 165
    - power save mode 167
    - prompt delay time 168
    - replace print cartridges 158
    - restore factory defaults 168
    - self-test report 157
  - make copies
    - HP Director (Windows) 13
    - OS 9 HP Image Zone (Macintosh) 17
    - OS X HP Image Zone (Macintosh) 15
  - manual
    - fax reports 115

- receive, fax 112
- send, fax 108, 110
- troubleshoot, fax 186

media. see paper

memory

- delete faxes 123
- reprint faxes 123
- save faxes 121

memory card

- troubleshoot 200

memory cards

- CompactFlash 45
- defective 198
- e-mail photos 57
- insert 46
- Memory Stick 45
- MicroDrive 45
- MultiMediaCard (MMC) 45
- overview 45
- print DPOF file 55
- print photos 53
- proof sheet 48
- save files to computer 46
- scan to 72
- Secure Digital 45
- send photos 126, 138
- share photos 57
- SmartMedia 45
- specifications 221
- xD 45

Memory Stick memory card 45

MicroDrive memory card 45

minimum install 190

modem. see PC modem

monitor dialing 110

more applications (OS 9 HP

Image Zone) 18

MultiMediaCard (MMC) memory card 45

## N

normal copy quality 61

number of copies

- copy 62

## O

OK button 8

on button 8

order

- accessories 151
- paper 151
- print cartridges 151
- Setup Guide 152

software 152

User Guide 152

## P

paper

- incompatible types 36
- jams 43, 193
- load 37
- order 151
- paper sizes 218
- recommended copy types 60
- recommended types 36
- size, set for fax 119
- specifications 217
- troubleshoot 193

paper tray capacities 217

parallel phone systems 80

PBX system, set up 85

PC modem

- set up with fax 89, 90, 95
- troubleshoot 184, 186

phone

- receive fax 112
- send fax 108

phone cord

- check 182
- connection, failure 182
- extend 189

phone numbers, customer support 203

photo

- menu 11
- menu button 8

photo memory card.. see

memory cards

photo paper

- load 39
- specifications 217

photos

- auto print 144
- borderless 54
- deselect 55
- e-mail 57, 71
- enhance copies 66
- file corrupted 200
- file size 200
- gray photo print cartridge 162
- HP Image Zone 129, 140
- HP Instant Share 57
- manually print 144
- photo print cartridge 162

preview 144

print 143

print from DPOF file 55

print options 145

print, cancel 147

Quick Print 55

receive from allowed

senders 143

receive from any

sender 142

scan 71

send 57, 71

send from a destination file 139

send from a memory

card 126, 138

send scanned

images 128, 139

share 57, 71

slide show 56

unsupported file format 200

physical specifications 221

PictBridge 55

postcards, load 40

posters

- copy 67

power save mode 167

power specifications 221

preview images 144

print

- cancel job 77
- fax reports 102, 108, 115
- faxes 123
- from computer 75
- from software application 75
- photos from DPOF file 55
- photos from memory card 53
- print options 76
- proof sheet 48
- Quick Print 55
- self-test report 157
- specifications 219

print cartridge protector 163

print cartridges

- align 164
- check ink levels 156
- clean 165
- clean contacts 165
- clean ink nozzle area 166

- gray photo print cartridge 162
  - handle 158
  - order 151
  - part names 158
  - photo print cartridge 162
  - replace 158
  - store 163
  - troubleshoot 173, 194
  - print margin specifications 218
  - prompt delay time 168
  - proof sheet
    - fill in 49
    - menu 11
    - print 48
    - scan 49
  - proxy settings 198
  - pulse dial 119
- Q**
- quality
    - copy 61
  - Quick Print 55
- R**
- Readme file 170
  - receive faxes
    - manually 112
    - troubleshooting 184, 186
  - receive images in HP Instant Share 134, 142
  - recycling 223
  - redial fax 109, 120
  - reduce faxes to fit 120
  - reduce/enlarge copies
    - fit several on one page 64
    - poster 67
    - resize to fit letter 65
  - regulatory notices
    - Canadian statement 225
    - declaration of conformity (European Economic Area) 228
    - declaration of conformity (U.S.) 228, 229
    - FCC requirements 223
    - FCC statement 224
    - notice to users in Japan 226
    - notice to users in Korea 226
    - notice to users in the European Economic Area 225
    - notice to users of the German telephone network 226
    - regulatory model identification number 223
  - regulatory notices wireless products
    - notice to users in Canada 226
    - notice to users in France 227
    - notice to users in Italy 227
    - notice to users in the European Economic Area 227
  - reinstall software 178
  - remote printing. *see* HP remote printing
  - replace print cartridges 158
  - reports
    - confirmation 115
    - error 115
    - fax 102, 108, 115, 180
    - fax log 115
    - fax test failed 181
    - last fax transaction 115
    - self-test 115, 157
    - speed dial list 115
  - reprint faxes in memory 123
  - resolution, fax 117
  - restore factory settings 168
  - return your HP all-in-one 208
  - right arrow 8
  - ring, answer pattern 119
  - rings to answer fax 111
  - rotate button 8
- S**
- save
    - photos to computer 46
  - save, faxes in memory 121
  - scan
    - cancel 73
    - from front panel 69
    - HP Instant Share 71, 128, 139
    - menu 11
    - menu button 7
    - network-connected device 70
    - proof sheet 49
    - specifications 221
    - stop 73
    - to memory card 72
    - USB-connected device 70
  - scan document
    - HP Director (Windows) 13
    - OS 9 HP Image Zone (Macintosh) 17
  - scan glass
    - clean 155
    - load original 35
  - scan picture
    - HP Director (Windows) 13
    - OS 9 HP Image Zone (Macintosh) 17
    - OS X HP Image Zone (Macintosh) 15
  - scan to
    - menu (USB - Macintosh) 10
    - menu (USB - Windows) 10
  - scan to OCR (OS X HP Image Zone) 15
  - screen saver 9
  - Secure Digital memory card 45
  - security
    - Bluetooth adapter 23
  - self-test report 115, 157
  - send fax
    - basic fax 107
    - manual 108, 110, 186
    - monitor dialing 110
    - multiple recipients 109
    - redial 109
    - speed dials 110
  - send to a device
    - from a memory card 126, 138
    - HP Director (Macintosh) 131
    - HP Image Zone 140
    - HP Image Zone (Macintosh) 130
    - HP Image Zone (Windows) 129
    - scanned images 128, 139
  - serial number 203
  - serial phone system 80
  - service ID 203
  - settings
    - auto answer 105

- date and time 112
- fax 118
- print options 76
- speed, fax 122
- setup
  - answering machine 94, 95
  - distinctive ringing 85, 119
  - DSL line 84
  - fax 79
  - ISDN line 85
  - menu 12
  - menu button 8
  - PBX system 85
  - PC modem 89, 90, 95, 99
  - separate fax line 83
  - shared phone line 87
  - test fax 102, 180
  - troubleshoot fax 180
  - voice mail 88, 99
- shut down your HP all-in-one 194
- slide show 56
- SmartMedia memory card 45
- software
  - reinstall 178
  - troubleshoot installation 175
  - uninstall 178
- software application, print from 75
- software update. *see* device update
- sounds, adjust fax 119
- specifications. *see* technical information
- speed
  - copy 61
- speed dialing
  - create entries 116
  - delete settings 117
  - edit 116
  - print list 115
  - send fax 110
- start black 8
- start color 8
- stop
  - copy 68
  - fax 124
  - print job 77
  - scan 73
- subscriber identification code 113
- support
  - before you call 169
  - resources 169
- symbols, enter 113
- system requirements 217
- T**
- technical information
  - copy specifications 220
  - environmental specifications 221
  - fax specifications 220
  - memory card specifications 221
  - paper sizes 218
  - paper specifications 217
  - paper tray capacities 217
  - physical specifications 221
  - power specifications 221
  - print margin specifications 218
  - print specifications 219
  - scan specifications 221
  - system requirements 217
  - weight 221
  - wireless specifications 226
- telephone
  - receive fax 112
  - send fax 108
- telephone answering machine. *see* answering machine
- telephone numbers, customer support 203
- telephone wall jack, fax 181
- test
  - dial tone 183
  - fax hardware test 181
  - fax line condition 182
  - fax port 182
  - fax setup 102, 180
  - fax test failed 181
  - phone cord 182
  - telephone wall jack 181
- text
  - enhance on copies 66
  - enter on keypad 113
- time, set 112
- tone dial 119
- transfer images button (HP Director) 13
- transparencies
  - load 42
  - specifications 217
- troubleshoot
  - about setup 170
  - answering machines 188
  - blocked carriage 175
  - check DNS address 197
  - check proxy address 198
  - check proxy settings 196
  - connection lost to HP Instant Share service 198
  - contact customer support 169
  - corrupt destination file 198
  - destinations not authorized 198
  - destinations not set up 192
  - DNS server not responding 197
  - failed to connect to HP Instant Share 196
  - fax 180, 201
  - fax
    - problems 184, 186, 188, 190
  - 190
  - fax test 181
  - hardware setup 170
  - HP Instant Share not set up 191
  - HP Instant Share operations 194
  - HP Instant Share setup 190
  - incorrect measurements 172
  - jams, paper 43, 175, 193
  - language, display 172
  - memory card error 198
  - memory cards 200
  - minimum install 190
  - no network connection 195
  - operational tasks 192
  - overview 169
  - paper 193
  - print cartridges 173, 194
  - Readme file 170
  - receiving faxes 184, 186
  - sending faxes 184, 186
  - setup 170
  - software installation 175
  - static on phone line 189
  - support resources 169
  - USB cable 171
- two-sided printing accessory jams, troubleshoot 194

## Index

two-wire phone cord 184, 189

### U

uninstall

software 178

unload images

OS 9 HP Image Zone 17

OS X HP Image Zone 15

up arrow 8

USB cable installation 171

### V

visual keyboard 113

voice mail

set up with fax 88, 99, 105

troubleshoot 186

volume, adjust fax 119

### W

wall jack test, fax 181

warranty

upgrades 213

Webscan 24

wired connection icons 9

wireless connection icons

ad hoc 9

### X

xD memory card 45

### Z

zoom button 8





i n v e n t



Printed on at least 50% total recycled fiber  
with at least 10% post-consumer paper

© 2004 Hewlett-Packard Development Company, L.P.

Electronic Edition

[www.hp.com](http://www.hp.com)



Q3450-90195

## Free Manuals Download Website

<http://myh66.com>

<http://usermanuals.us>

<http://www.somanuals.com>

<http://www.4manuals.cc>

<http://www.manual-lib.com>

<http://www.404manual.com>

<http://www.luxmanual.com>

<http://aubethermostatmanual.com>

Golf course search by state

<http://golfingnear.com>

Email search by domain

<http://emailbydomain.com>

Auto manuals search

<http://auto.somanuals.com>

TV manuals search

<http://tv.somanuals.com>