



HP SB360

Digital Camera

Quick Start Guide

Getting Started

Parts of the Camera

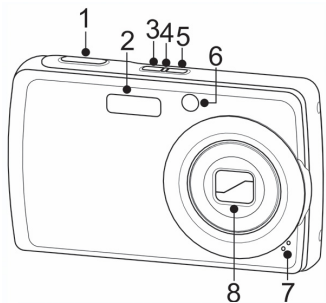

1. Shutter button
2. Flash
3. Stabilizer
4. LED indicator
5. Power button
6. Self-timer LED / AF Assist Lamp
7. Microphone
8. Zoom Lens

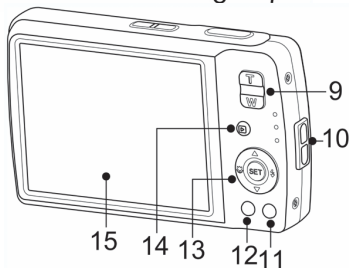

9. Zoom buttons
10. Strapping
11. Function / Delete button
12. Menu Button
13. SET button / 4-way navigation control
14. Playback button
15. LCD screen

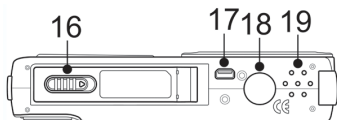

16. Battery / SD card compartment
17. USB / TV Out
18. Tripod screw hole
19. Speaker

Setting the Display Language / Date & Time

When using the camera for the first time after purchasing, be sure to choose a language and set the date & time before using the camera.

Setting the Display Language

1

Turn the power on, and set the camera to the Setup Menu.

2

Select [Language].

- Press ▲ or ▼ to select [LANGUAGE] then press SET button to launch the submenu.

3

Select a language.

- Press ▲ or ▼ to select a language and press SET button to apply the setting.

4

Press the MENU button to close the menu.

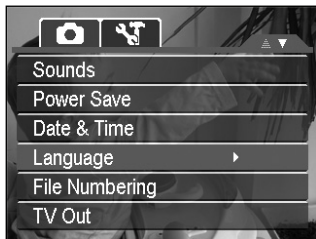

Setting the Date & Time

1

Turn the power on, and set the camera to the Setup Menu.

2

Select [Date & Time].

- Press ▲ or ▼ to select [Date & Time] then press **SET** button to launch the submenu.



3

Set date and time.

- Press ▲ or ▼ to change the value of the cursor located. Press ⏏ or ⚡ button to move the cursor between settings.

4

Apply the setting.

- After adjusting the settings, press the **OK** or the **MENU** button to apply the setting.



Caution

- Once the date, time and language have been set, changing the batteries or removing the SD card will NOT reset these settings. However, if the batteries are removed for longer than 48 hours, the Date and Time will need to be re-set.

Using the Menu

When the menu is displayed, use the 4-way navigation control and the **SET** button to move through menu selections and apply your desired settings. To close the menu anytime, press the menu button again

Using the Shooting Menu

1
Turn the power on, and set the camera to Shooting mode.

2
 Press **Menu** to launch the Shooting Menu.

3
Use the **▲** or **▼** keys to move through the menu selections.

4
To select an item, press **↵**.

5
Change the submenu settings using the 4-way navigation control.

6
Press the **SET** button to save and apply settings.

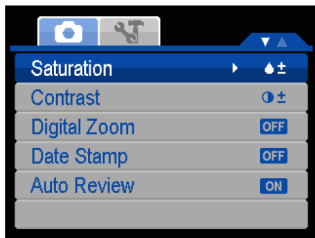

Using the Setup Menu



You can access the Setup menu whether you are in Shooting or Playback mode. The Setup menu allows you to configure general camera settings.

1





Press  to launch the Record/ Playback Menu.

2

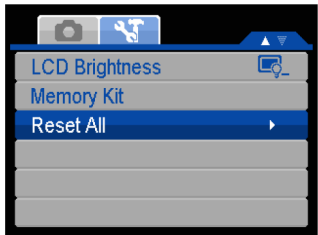
Use the  or  keys to change the menu tab to  Setup menu.



3

Use the  or  keys to move through the menu selections.

4

To select an item, press .

5

Change the submenu settings using the 4-way navigation control.

6

Press the SET button to save and apply settings.

Using the Function Menu



The **Function Menu** is used to adjust capture settings in Shooting Mode. It contains My Mode, Resolution, Quality, EV Compensation, White Balance, ISO, Metering, and Color Mode.



Press the **FUNC** button of your camera to launch the Function Menu.



Press the **FUNC** button again to close the menu.

- The Menu bar displays the current status of your camera settings. Only the available functions for the settings are shown as icon on the menu bar.
- The available options for each item on the menu bar are shown in the Menu options.
- Use the  or  to move through the menu selections then press the **SET** button to save and apply changes

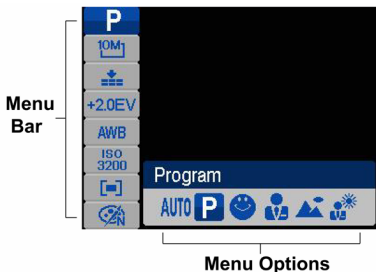

My Mode

The My Mode function displays the 6 most recent modes used in order. When you move through the different modes in the menu options, the items on the menu bar changes synchronously to the corresponding available settings.

P/N: 7525C00043A

Free Manuals Download Website

<http://myh66.com>

<http://usermanuals.us>

<http://www.somanuals.com>

<http://www.4manuals.cc>

<http://www.manual-lib.com>

<http://www.404manual.com>

<http://www.luxmanual.com>

<http://aubethermostatmanual.com>

Golf course search by state

<http://golfingnear.com>

Email search by domain

<http://emailbydomain.com>

Auto manuals search

<http://auto.somanuals.com>

TV manuals search

<http://tv.somanuals.com>