



Operator's manual
HUSQVARNA AUTOMOWER®
550H



EN, English

Read the operator's manual carefully and make sure that you understand the instructions before you use the product.

Contents

1 Introduction		4 Operation	
1.1 Support.....	3	4.1 Main switch.....	30
1.2 Product description.....	3	4.2 Start.....	30
1.3 Product overview.....	4	4.3 Operating mode - Start.....	30
1.4 Symbols on the product.....	5	4.4 Operating mode - Park.....	31
1.5 Symbols in Automower® Connect.....	6	4.5 Stop.....	31
1.6 Symbols on the battery.....	6	4.6 Switch off.....	31
1.7 Overview of the settings structure (1).....	7	4.7 Charge a flat battery.....	32
1.8 Overview of the settings structure (2).....	8		
1.9 Overview of the settings structure (3) (Bluetooth® short-range connectivity only).....	9	5 Maintenance	
2 Safety		5.1 Introduction - maintenance.....	33
2.1 Safety definitions.....	10	5.2 Clean the product.....	33
2.2 General safety instructions.....	10	5.3 Replace the blades.....	34
2.3 Safety instructions for operation.....	12	5.4 Battery.....	34
3 Installation		5.5 Winter service.....	35
3.1 Introduction - Installation.....	15	6 Troubleshooting	
3.2 Before the installation of the wires.....	15	6.1 Introduction - troubleshooting.....	36
3.3 Before the installation of the product.....	15	6.2 Fault messages.....	36
3.4 Installation of the product.....	19	6.3 Information messages.....	41
3.5 To put the wire into position with stakes...20		6.4 LED indicator lamp on the charging station.....	43
3.6 To bury the boundary wire or the guide wire.....	20	6.5 LED indicator lamp on the product.....	44
3.7 To change the position of the boundary wire or the guide wire.....	20	6.6 Symptoms.....	45
3.8 To extend the boundary wire or the guide wire.....	21	6.7 Finding breaks in the loop wire.....	46
3.9 After the installation of the product.....	21	7 Transportation, storage and disposal	
3.10 Automower® Connect.....	21	7.1 Transportation.....	49
3.11 Automower® Connect menu.....	22	7.2 Storage.....	49
3.12 Settings in Automower® Connect.....	22	7.3 Disposal.....	49
3.13 Timer settings.....	22	8 Technical data	
3.14 Cutting height.....	23	8.1 Technical data.....	50
3.15 Operation.....	23	8.2 Registered trademarks.....	52
3.16 Installation.....	24	9 Warranty	
3.17 Accessories.....	26	9.1 Guarantee terms.....	53
3.18 General (Bluetooth® only).....	27	10 Applicable to US/CA market	
3.19 Security (Bluetooth® only).....	27	10.1 Supplier's Declaration of Conformity.....	54
3.20 Automower® Connect (Bluetooth® only).....	28	10.2 Compliance requirements.....	54
3.21 Messages (Bluetooth® only).....	28		
3.22 My mowers.....	28		
3.23 Automower® Direct.....	28		
3.24 Husqvarna Fleet Services™.....	29		

1 Introduction

Serial number:

PIN code:

The serial number is on the product rating plate and on the product carton.

- Use the serial number to register your product on www.husqvarna.com.

1.1 Support

For support about the Husqvarna product, speak to your servicing dealer.

The operator selects the operation settings with the keys on the keypad. The display shows the selected and possible operation settings, and the operation mode of the product.

1.2 Product description

Note: Husqvarna regularly updates the appearance and function of the products. Refer to *Support on page 3*.

The boundary wire and the guide wire controls the movement of the product within the work area.

The product is a robotic lawn mower. The product has a battery power source and cuts the grass automatically. Collection of grass is not necessary.

1.2.1 Automower® Connect

Automower® Connect is a mobile application that makes it possible to select the operation settings remotely. Refer to *Automower® Connect (Bluetooth® only) on page 28*.

1.3 Product overview

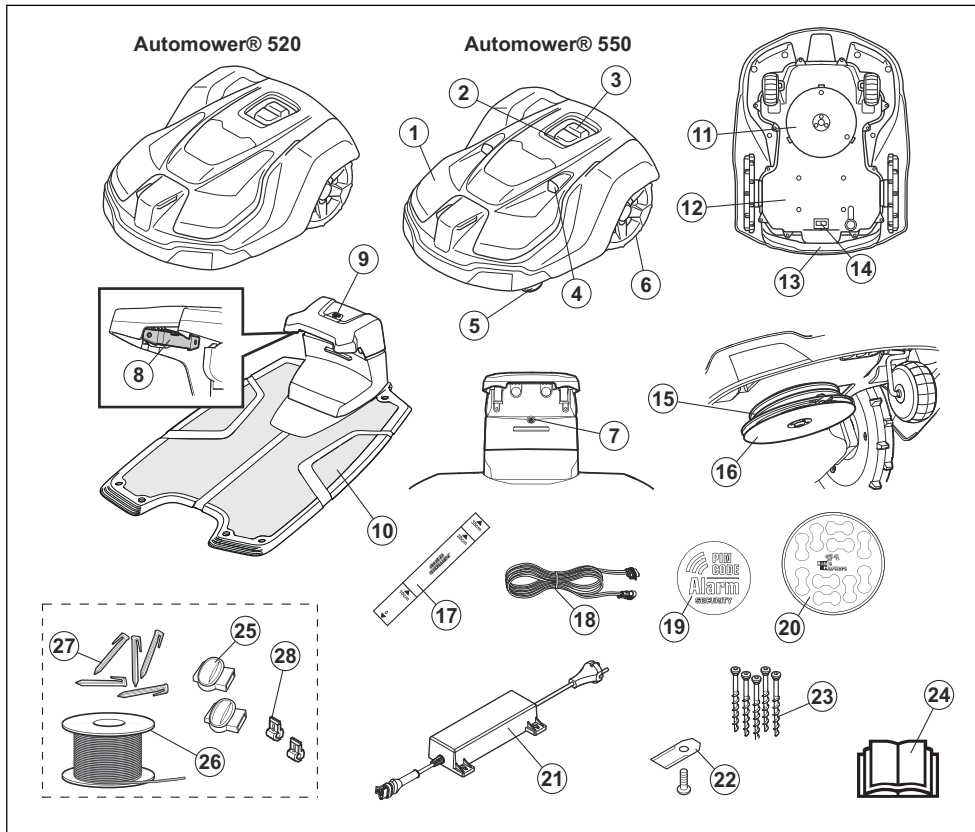

The numbers in the illustration represent:

- | | |
|---|--|
| <ul style="list-style-type: none"> 1. Body 2. LED indicator lamp of the product 3. STOP/START button 4. Ultrasonic sensors 5. Front wheels 6. Rear wheels 7. LED indicator lamp of the charging station 8. Contact strips 9. Park button 10. Charging station 11. Cutting system | <ul style="list-style-type: none"> 12. Chassis box with electronics, battery and motors 13. Handle 14. Main switch 15. Blade disc 16. Skid plate 17. Measurement gauge 18. Low voltage cable 19. Alarm decal 20. Cable markers 21. Power supply ¹ 22. Extra blades 23. Screws for securing the charging station |
|---|--|

¹ The appearance may differ depending on market

- 24. Operator's manual and Quick Guide
- 25. Couplers for loop wire ²
- 26. Loop wire for boundary loop and guide wire ₃
- 27. Stakes⁴
- 28. Connector for the loop wire ⁵

1.4 Symbols on the product

These symbols can be found on the product. Study them carefully.



WARNING: Read the user instructions before operating the product.



WARNING: Operate the disabling device before working on or lifting the machine.

The product can only start when the correct PIN code has been entered. Switch off the product before carrying out any inspections and/or maintenance.



WARNING: Keep a safe distance from the machine when operating. Keep your hands and feet away from the rotating blades.



WARNING: Do not ride on the machine. Never put your hands or feet close to or under the machine.

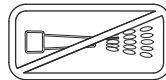

Never use a high-pressure washer or even running water to clean the product.

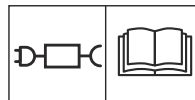

Use a detachable power supply as defined on the rating label next to the symbol.

CE This product conforms to the applicable EC Directives.



Noise emission to surroundings. The product's emissions are set out in *Technical data on page 50* and on the rating plate.

² Is a part of the Installation kit which is purchased separately.

³ See note 2

⁴ See note 2

⁵ See note 2



It is not permitted to dispose this product as normal household waste. Ensure that the product is recycled in accordance with local legal requirements.



The chassis contains components which are sensitive to electrostatic discharge (ESD). The chassis must also be resealed in a professional manner. For these reasons the chassis shall only be opened by authorized service technicians. A broken seal can result in the entire or parts of the guarantee no longer being valid.



The low voltage cable must not be shortened, extended or spliced. Do not use a trimmer nearby the low voltage cable. Be careful when trimming edges where the cables are placed.

1.5 Symbols in Automower® Connect



The timer function controls when the product cuts the lawn.



The cutting height function allows the operator to set the cutting height of the product.



The operation function is used for manual settings for the operation.



The installation function is used for manual settings for the installation.



The accessories function is used for settings made for the accessories.



The settings function is where the general settings for the products are set. (Only available for Bluetooth® short-range connectivity)



The security function lets the operator select between 3 security levels. (Only available for Bluetooth® short-range connectivity)



Automower® Connect is where the operator enables and disables the Automower® Connect module on the product. (Only available for Bluetooth® short-range connectivity)

1.6 Symbols on the battery



Read the user instructions.



Do not discard the battery into fire and do not expose the battery to a heat source.



Do not immerse the battery into water.

1.7 Overview of the settings structure (1)

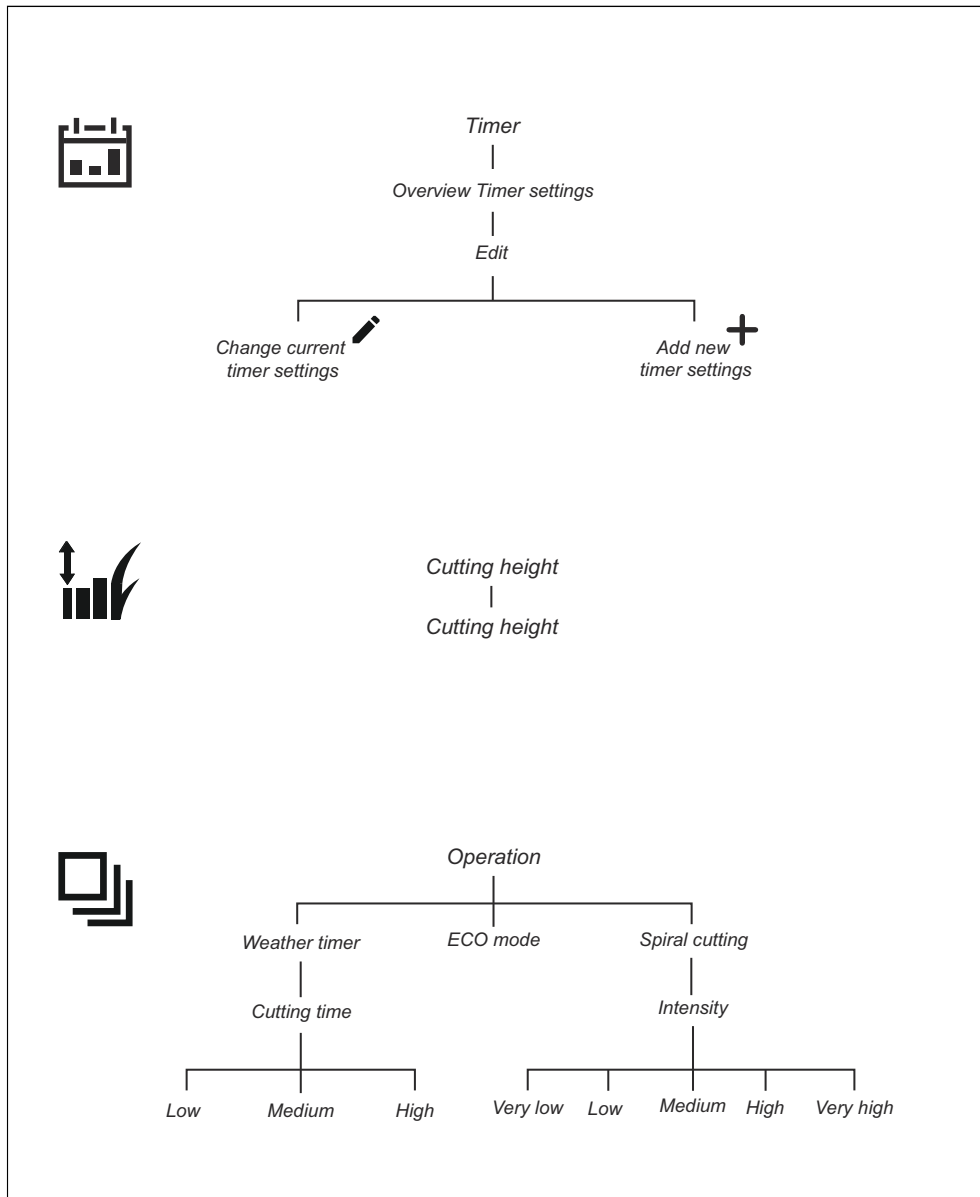

1.8 Overview of the settings structure (2)

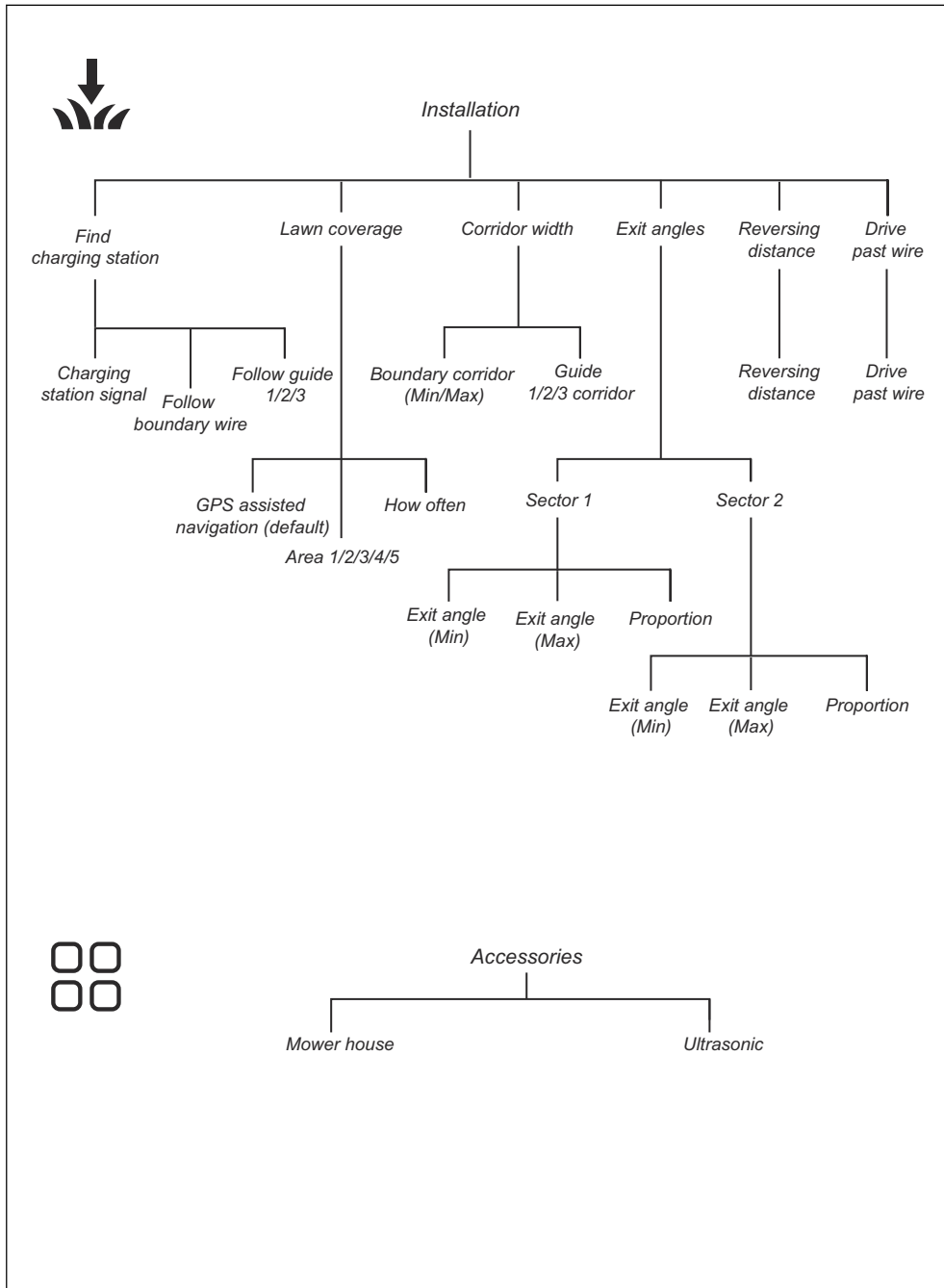

1.9 Overview of the settings structure (3) (Bluetooth® short-range connectivity only)

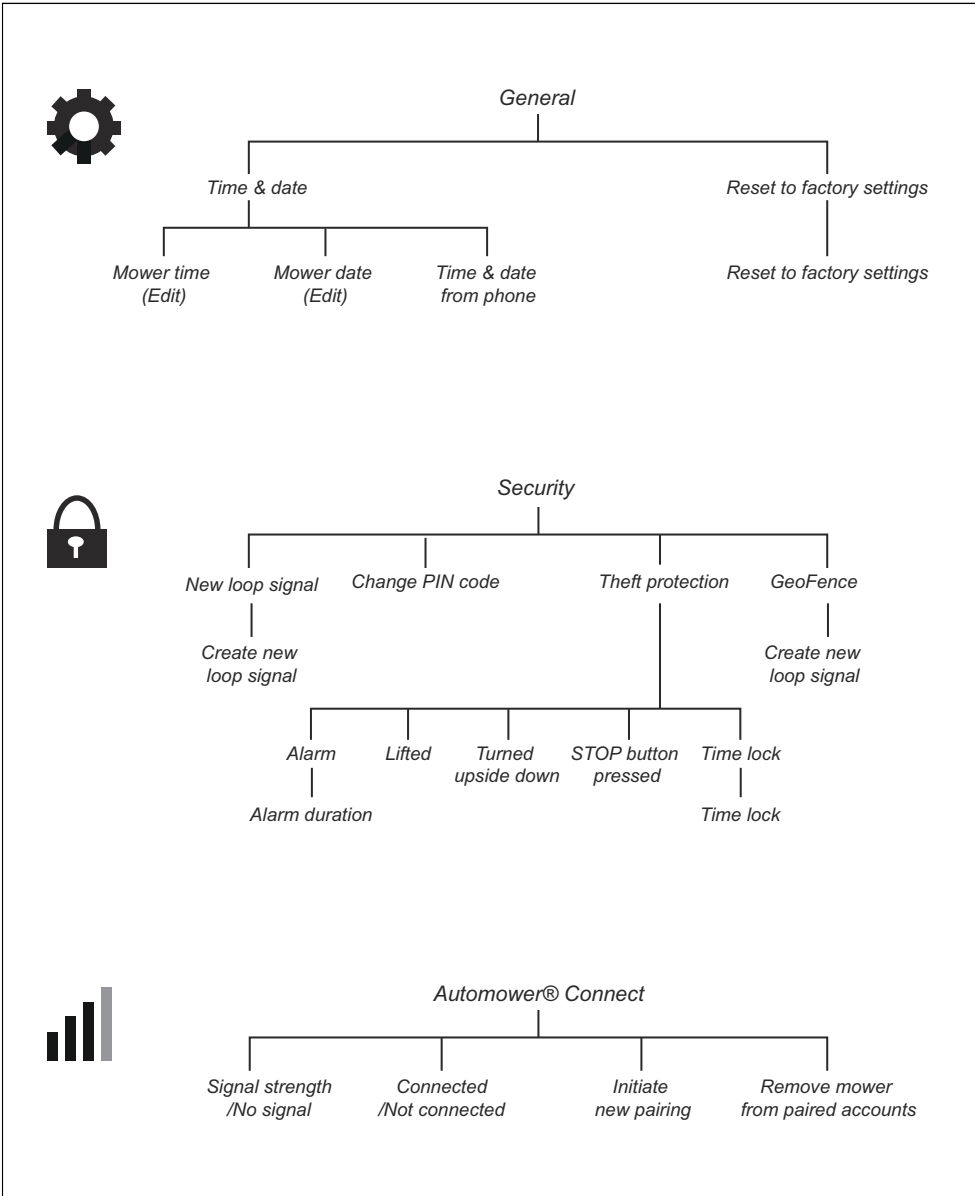

2 Safety

2.1 Safety definitions

Warnings, cautions and notes are used to point out specially important parts of the manual.



WARNING: Used if there is a risk of injury or death for the operator or bystanders if the instructions in the manual are not obeyed.



CAUTION: Used if there is a risk of damage to the product, other materials or the adjacent area if the instructions in the manual are not obeyed.

Note: Used to give more information that is necessary in a given situation.

2.2 General safety instructions

The following system is used in the Operator's Manual to make it easier to use:

- Text written in *italics* is a text that is in the Automower® Connect app, or is a reference to another section in the Operator's manual.
- Text written in **bold** is one of the buttons on the product.
- Text written in *UPPERCASE* and *italics* refer to the different operating modes available in the product.

2.2.1 IMPORTANT. READ CAREFULLY BEFORE USE. KEEP FOR FUTURE REFERENCE

The operator is responsible for accidents or hazards occurring to other people or property.

This appliance is not intended for use by persons (including children) with reduced physical, sensory or mental capabilities (that could affect a safe handling of the product), or lack of experience and knowledge, unless they have been given supervision or instruction concerning use of the appliance by a person responsible for their safety.

This appliance can be used by children aged from 8 years and above and persons with reduced physical, sensory or mental capabilities or lack of experience and knowledge if they have been given supervision or instruction concerning use of the appliance in a safe way and understand the hazards involved. Local regulations may restrict the age of the operator. Cleaning and maintenance shall not be made by children without supervision.

Never connect the power supply to an outlet if the plug or cord is damaged. Worn or damaged cord increase the risk of electric shock.

Only charge the battery in the included charging station. Incorrect use may result in electric shock, overheating or leaking of corrosive liquid from the battery. In the event of leakage of electrolyte, flush with water/neutralizing agent. Seek medical help if it comes in contact with the eyes.

Use only original batteries recommended by the manufacturer. Product safety cannot be guaranteed with other than original batteries. Do not use non-rechargeable batteries.

The appliance must be disconnected from the supply mains when removing the battery.



WARNING: The product can be dangerous if used incorrectly.



WARNING: Do not use the product when persons, especially children, or animals, are in the work area.



WARNING: Keep your hands and feet away from the rotating blades. Never put your hands or feet close to or under the product when the motor is running.

2.3 Safety instructions for operation

2.3.1 Use

- The product may only be used with the equipment recommended by the manufacturer. All other types of use are incorrect. The manufacturer's instructions with regard to operation/maintenance must be followed precisely.
- Warning signs shall be placed around the work area of the product if it is used in public areas. The signs shall have the following text: **Warning! Automatic lawnmower! Keep away from the machine! Supervise children!**

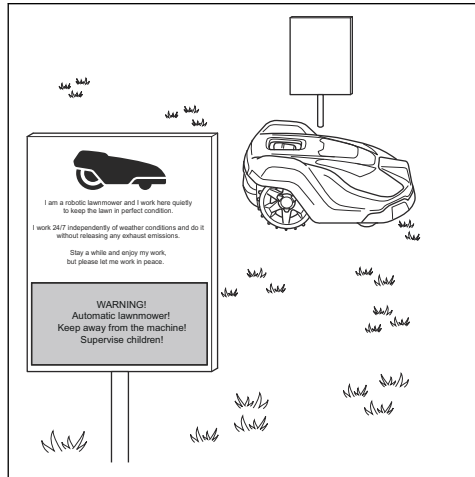

- Use the **PARK** function or switch off the main switch when persons, especially children or animals, are in the work area. It is recommended to program the product for use during hours when the area is free from activity, e.g. at night. Refer to *Park until further notice on page 31*. Consider that certain species, e.g. hedgehogs, are active at night. They can potentially be harmed by the product.
- The product may only be operated, maintained and repaired by persons that are fully conversant with its special characteristics and safety regulations. Please read the Operator's Manual carefully and make sure you understand the instructions before using the product.
- It is not permitted to modify the original design of the product. All modifications are made at your own risk.
- Check that there are no stones, branches, tools, toys or other objects on the lawn that can damage the blades. Objects on the lawn can also lead to the product getting stuck. Help may be required to remove the object before the product can continue mowing. Always set the main switch in position *0* before clearing a blockage.

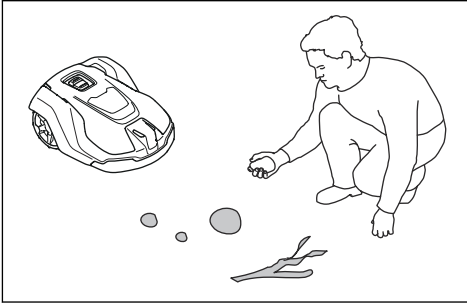

- Start the product according to the instructions. When the main switch is set to 1; make sure to keep your hands and feet away from the rotating blades. Never put your hands and feet under the product.
- Never touch moving hazardous parts, such as the blade disc, before it has come to a complete stop.
- Never lift up the product or carry it around when the main switch is in position 1.
- The product must never be allowed to collide with persons or other living creatures. If a person or other living creature comes in the way of the product, it shall be stopped immediately. Refer to *Stop on page 31*.
- Do not put anything on top of the product or its charging station.
- Do not allow the product to be used with a defective guard, blade disc or body. Neither should it be used with defective blades, screws, nuts or cables. Never connect a damaged cable, or touch a damaged cable before it is disconnected from the supply.
- Do not use the product if the main switch does not work.
- Always switch off the product using the main switch when the product is not in use. The product can only start when the main switch is set to 1 and the correct PIN code has been entered.
- The product must never be used at the same time as a sprinkler. Use the timer function so the product and sprinkler never run simultaneously. Refer to *Timer settings on page 22*.
- Husqvarna does not guarantee full compatibility between the product and other types of wireless systems such as remote controls, radio transmitters, hearing loops,

underground electric animal fencing or similar.

- The built-in alarm is very loud. Be careful, especially if the product is handled indoors.
- Metal objects in the ground (for example reinforced concrete or anti-mole nets) can result in a stoppage. The metal objects can cause interference with the loop signal which then can lead to a stoppage.
- Operation and storage temperature is 0-50 °C / 32-122 °F. Temperature range for charging is 0-45 °C / 32-113 °F. Too high temperatures might cause damage to the product.

2.3.2 Battery safety



WARNING: Lithium-ion batteries can explode or cause fire if disassembled, short-circuited, exposed to water, fire, or high temperatures. Handle carefully, do not dismantle, open the battery or use any type of electrical/mechanical abuse. Avoid storage in direct sunlight.

For more information about the battery, refer to *Technical data on page 50*

2.3.3 How to lift and move the product

To safely move from or within the work area:

1. Press the **STOP** button to stop the product.

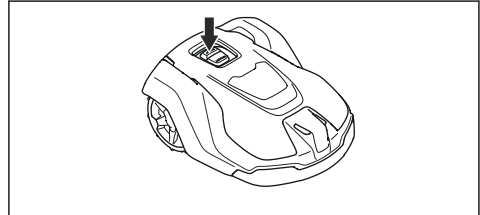

2. Set the main switch in position 0.

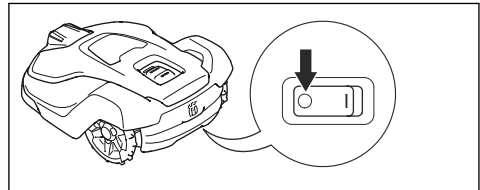

3. Carry the product by the handle under the product with the blade disc away from the body.



CAUTION: Do not lift the product when it is parked in the charging station. It can damage the charging station and/or the product. Press **STOP** and pull the product out of the charging station before lifting it.

2.3.4 Maintenance



WARNING: When the product is turned upside down the main switch must always be in the 0 position.

The main switch should be set in the 0 position before all work on the chassis of the product, such as cleaning or replacing the blades.

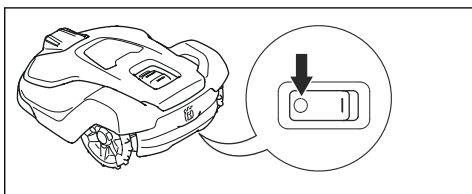

CAUTION: Never use a high-pressure washer or even running water to clean the product. Never use solvents for cleaning.



CAUTION: Use the plug to disconnect the charging station before any cleaning or maintenance of the charging station or the loop wire.

Inspect the product each week and replace any damaged or worn parts. Refer to *Maintenance on page 33*.

2.3.5 In the event of a thunderstorm

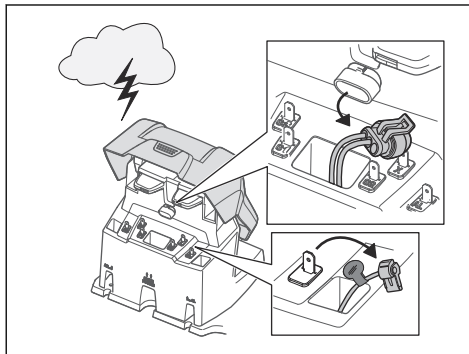

To reduce the risk of damage to electrical components in the product and the charging station, we recommend that all connections to the charging station are disconnected (power supply, boundary wire and guide wire) if there is a risk of a thunderstorm.

1. Mark the wires to simplify reconnecting. The charging station's connections are marked AR, AL and G1. Some models have additional guide wires (G2, G3).
2. Disconnect all connected wires and the power supply.
3. Connect all the wires and the power supply if there is no longer a risk of thunder. It is important that each wire is connected to the right place.

3 Installation

3.1 Introduction - Installation



WARNING: Read and understand the safety chapter before you install the product.



CAUTION: Only use original spare parts and installation material.

Note: Refer to www.husqvarna.com for more information about installation.

3.2 Before the installation of the wires

You can select to attach the wires with stakes or bury them. You can use the 2 procedures for the same work area.

- Bury the boundary wire or the guide wire if you are going to use a dethatcher on the work area. If not, attach the boundary wire or guide wire with stakes.
- Cut the grass before you install the product. Make sure that the grass is maximum 10 cm / 4 in.

Note: The first weeks after installation the perceived sound level when cutting the grass may be higher than expected. When the product has cut the grass for some time, the perceived sound level is much lower.

3.3 Before the installation of the product

- Make a blueprint of the work area and include all obstacles.
- Make a mark on the blueprint where to put the charging station, the boundary wire and the guide wire.
- Make a mark on the blueprint where the guide wire connects to the boundary wire. Refer to *To install the guide wire on page 20*.
- Fill in holes in the lawn.

Note: Holes with water in the lawn can cause damage to the product.

3.3.1 To examine where to put the charging station

- Keep a minimum 2 m / 7 ft. of free space in front of the charging station.
- Keep a minimum of 1.5 m / 5 ft. of free space to the right and to the left of the charging station.
- Put the charging station near an outdoor power outlet.
- Put the charging station on a level surface.

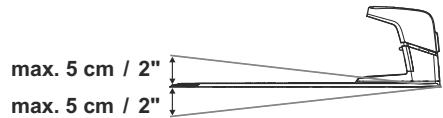

- Put the charging station in the lowest possible section of the work area.
- Put the charging station in an area without an irrigation system.
- Put the charging station in an area with protection from the sun.
- If the charging station is installed on an island, make sure to connect the guide wire to the island. Refer to *To make an island on page 17*.

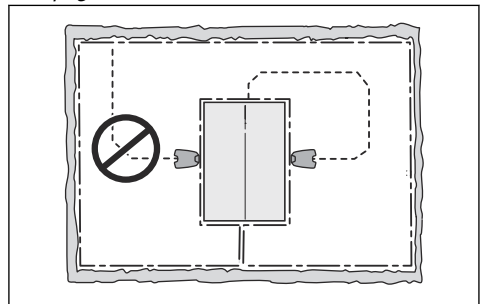

3.3.2 To examine where to put the power supply

- Put the power supply in an area with a roof and protection from the sun and rain.
- Put the power supply in an area with good airflow.
- Use a residual-current device (RCD) when you connect the power supply to the power outlet.



WARNING: Do not change the power supply. Do not cut or extend the low-voltage cable. There is a risk of electrical shock.

Low-voltage cables of different lengths are available as accessories.



CAUTION: Make sure that the blades on the product do not cut the low-voltage cable.



CAUTION: Do not put the low-voltage cable in a coil or below the charging station plate. The coil causes interference with the signal from the charging station.



3.3.3 To examine where to put the boundary wire



CAUTION: If the work area is adjacent to water bodies, precipices or a public road, the boundary wire must have a protective wall. The wall must be minimum 15 cm / 6 in. in height.

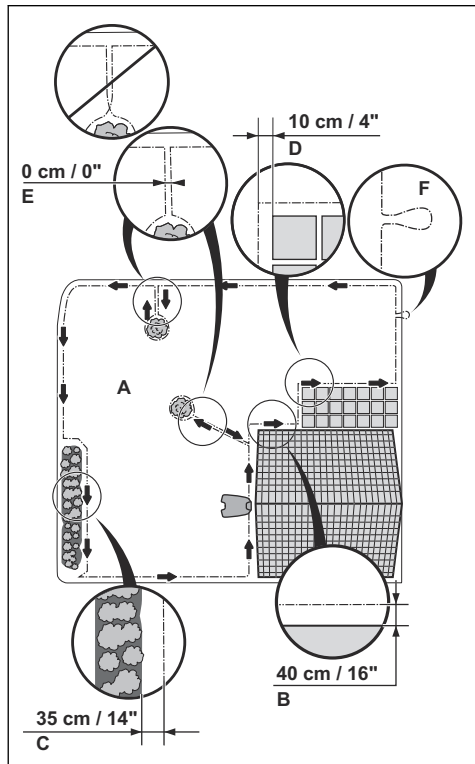

- Put the boundary wire around all of the work area (A). Adapt the distance between the boundary wire and obstacles.
- Put the boundary wire 40 cm / 16 in. (B) from an obstacle that is more than 5 cm / 2 in. high.
- Put the boundary wire 35 cm / 14 in. (C) from an obstacle that is 1-5 cm / 0.4-2 in. high.
- Put the boundary wire 10 cm / 4 in. (D) from an obstacle that is less than 1 cm / 0.4 in.
- If you have a paving stone path that is in level with the lawn, put the boundary wire below the paving stone.

Note: If the paving stone is minimum 35 cm / 14 in. wide, use the factory setting for the *Drive Past Wire* function to cut all the grass adjacent to the paving stone.



CAUTION: Do not let the product operate on gravel.

- If you make an island, put the boundary wire that runs to and from the island near together (E). Put the wires in the same stake.
- Make an eyelet (F) where the guide wire is to be connected to the boundary wire.



CAUTION: Do not make sharp bends when you install the boundary wire.



CAUTION: For careful operation without noise, isolate all obstacles such as trees, roots and stones.

- Put the 2 sections of boundary wire that run to and from the obstacle together.
- Put the 2 sections of boundary wire in the same stake.

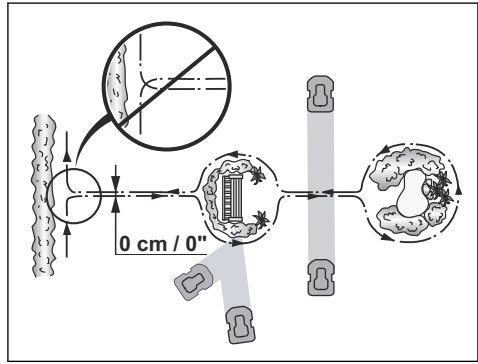

CAUTION: Do not put a section of boundary wire across the other. The sections of boundary wire must be parallel.



CAUTION: Do not put the guide wire across the boundary wire, for example a boundary wire that goes to an island.

3.3.3.1 To put the boundary wire in a slope

- For slopes steeper than 45% inside the work area, isolate the slope with boundary wire.
- For slopes steeper than 15% along the outer edge of the lawn, put the boundary wire 20 cm / 8 in. (A) from the edge.
- For slopes adjacent to a public road, put a fence or a protective wall along the outer edge of the slope.

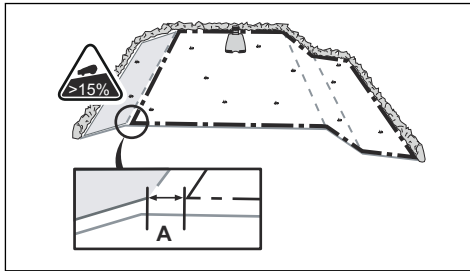

3.3.3.2 Passages

A passage is a section that has boundary wire on each side and that connects 2 work areas. The passage must be a minimum of 60 cm / 24 in. wide.

Note: If a passage is less than 2 m / 6.5 ft. wide, install a guide wire through the passage.

3.3.3.3 To make an island

- Put the boundary wire to and around the obstacle to make an island.

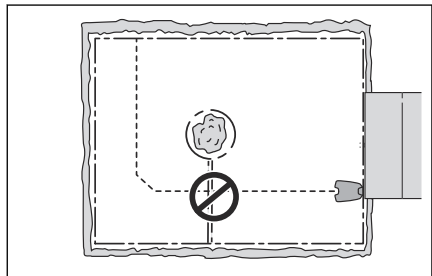

3.3.3.4 To make a secondary area

Make a secondary area if the work area has 2 areas that are not connected with a passage.

- Put the boundary wire around the secondary area (B) to make an island. The work area with the charging station is the main area (A). Refer to *To make an island on page 17*.

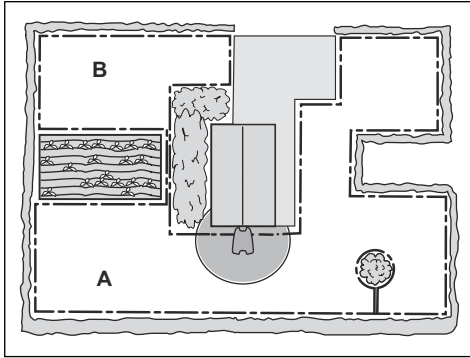

Note: When the product cuts grass in the secondary area, the *Secondary area mode* must be selected. Refer to *Secondary area on page 31*.

3.3.4 To examine where to put the guide wire

- Put the guide wire in a line at a minimum of 2 m / 7 ft. in front of the charging station.
- Make sure that the guide wire has as much free area as possible to the left of the guide wire when facing the charging station. Refer to *To set the corridor width of the guide wire on page 26*.
- Put the guide wire minimum 30 cm / 12 in. from the boundary wire.
- Do not make sharp bends when you install the guide wire.
- If the work area has a slope, put the guide wire diagonally across the slope.

3.3.5 Work area examples

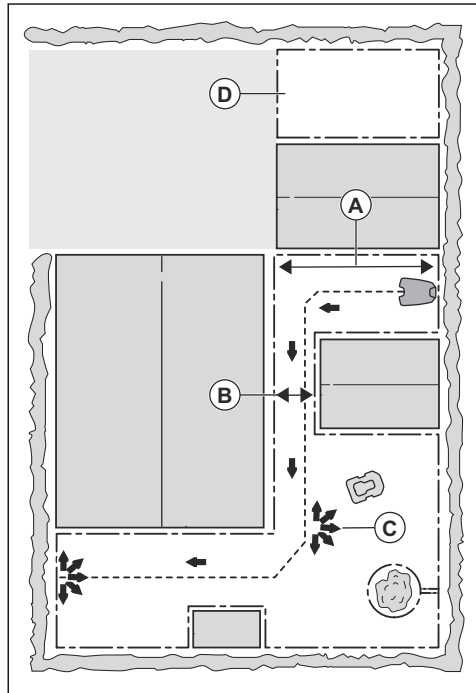

- If the charging station is put in a small area (A), make sure that the distance to the boundary wire is at a minimum 3 m / 10 ft.
- If the work area has a passage (B), make sure that the distance to the boundary wire is at a minimum 2 m / 6.5 ft. If the passage is smaller than 2 m / 6.5 ft., install a guide wire through the passage. Minimum passage between the boundary wire is 60 cm / 24 in.
- If the work area has areas which are connected by small passages (C), change the settings in *Lawn Coverage*. Refer to *Lawn coverage on page 25*.
- Use the GPS Assisted Navigation. Refer to *Lawn coverage on page 25*.
- If the work area includes a secondary area (D), refer to *To make a secondary area on page 17*. Put the product in the secondary area and select *Secondary area mode*. Refer to *Secondary area on page 31*.

3.4 Installation of the product

3.4.1 To install the charging station



WARNING: Obey national regulations about electrical safety.

1. Read and understand the instructions about the charging station. Refer to *To examine where to put the charging station on page 15*.
2. Put the charging station in the selected area.
3. Connect the low-voltage cable to the charging station.
4. Put the power supply at a minimum height of 30 cm / 12 in.

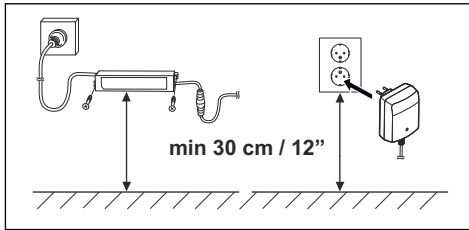

WARNING: Do not put the power supply at a height where there is a risk it can be put in water. Do not put the power supply on the ground.



WARNING: Do not encapsulate the power supply. Condensed water can harm the power supply and increase the risk of electrical shock.

5. Connect the power supply cable to a 100-240V outdoor power outlet.



WARNING: Applicable to USA/ Canada. If power supply is installed outdoors: Risk of Electric Shock. Install only to a covered Class A GFCI receptacle (RCD) that has an enclosure that is weatherproof with the attachment plug cap inserted or removed.

6. Put the low-voltage cable in the ground with stakes or bury the cable. Refer to *To put the wire into position with stakes on page 20* or *To bury the boundary wire or the guide wire on page 20*.
7. Connect the wires to the charging station. Refer to *To install the boundary wire on page 19* and *To install the boundary wire on page 19*.
8. Attach the charging station to the ground with the supplied screws.



CAUTION: Do not make new holes in the charging station plate.



CAUTION: Do not put your feet on the charging station.

3.4.2 To install the boundary wire

1. Put the boundary wire around all of the work area. Start and complete the installation behind the charging station.



CAUTION: Do not put unwanted wire in a coil. The coil causes interference with the product.

2. Open the connector and put the boundary wire in the connector.

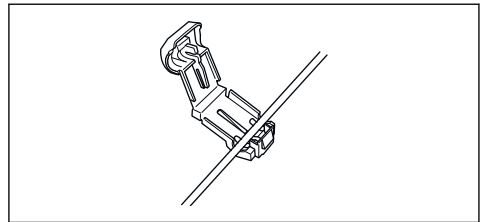

3. Close the connector with a pair of pliers.
4. Cut the boundary wire 1-2 cm / 0.4-0.8 in. above each connector.
5. Put the right end of boundary wire into the channel with the mark "AR".
6. Put the left end of boundary wire into the channel with the mark "AL".
7. Push the right connector onto the metal pin with the mark "AR".
8. Push the left connector onto the metal pin with the mark "AL".

- Put the cable mark on the left and right boundary wire.

after a time result in a broken circuit.

3.4.3 To install the guide wire

- Open the connector and put the wires in the connector.
- Close the connector with a pair of pliers.
- Cut the guide wires 1-2 cm / 0.4-0.8 in. above each connector.
- Put the guide wires centrally below the charging station plate, and push them through the slot in the charging station tower.
- Push the connector onto the metal pin with the mark "G1" (if applicable, also for G2 and G3).
- Put the cable mark on the guide wires.
- Put the end of the guide wires at the eyelet on the boundary wire.
- Cut the boundary wire with a pair of wire cutters.
- Connect the guide wires to the boundary wire with a coupler.

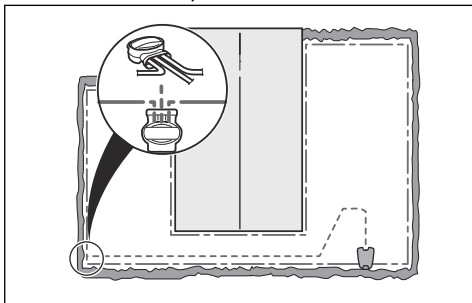

- Put the 2 ends of the boundary wire and the end of the guide wires into the coupler.

Note: Make sure that you can see the end of the guide wires through the transparent area of the coupler.

- Push the button on the coupler with an adjustable pliers.



CAUTION: Twinned cables, or a screw terminal block that is insulated with insulation tape are not satisfactory splices. Soil moisture will cause the wire to oxidize and

- Attach the guide wires to the ground with stakes or bury the guide wires in the ground. Refer to *To put the wire into position with stakes on page 20* or *To bury the boundary wire or the guide wire on page 20*.

3.5 To put the wire into position with stakes

- Put the boundary wire and the guide wire on the ground.
- Put the stakes at a maximum of 30 cm / 12 in. distance from each other.
- Attach the stakes to the ground with a hammer or a plastic mallet.



CAUTION: Make sure that the stakes hold the boundary wire and the guide wire against the ground.

Note: The wire is overgrown with grass and not visible after a few weeks.

3.6 To bury the boundary wire or the guide wire

- Cut a groove in the ground with an edge cutter or a straight shovel.
- Put the boundary wire or the guide wire cm / in. into the ground.

3.7 To change the position of the boundary wire or the guide wire

- If the boundary wire or the guide wire is put into position with stakes, remove the stakes from the ground.
- Carefully remove the boundary wire or the guide wire from the ground.
- Adjust the boundary wire or the guide wire into a new position.
- Put the boundary wire or the guide wire into position. Refer to *To put the wire into position with stakes on page 20* or *To bury the boundary wire or the guide wire on page 20*.

3.8 To extend the boundary wire or the guide wire

Note: Extend the boundary wire or the guide wire if it is too short for the work area. Use original spare parts, for example couplers.

1. Cut the boundary wire or the guide wire with a pair of wire cutters where it is necessary to install the extension.
2. Add wire where it is necessary to install the extension.
3. Put the boundary wire or the guide wire into position.
4. Put the wire ends into a coupler.

Note: Make sure that you can see the ends of the boundary wire or the guide wire through the transparent area of the coupler.

5. Push the button on the coupler with an adjustable pliers.

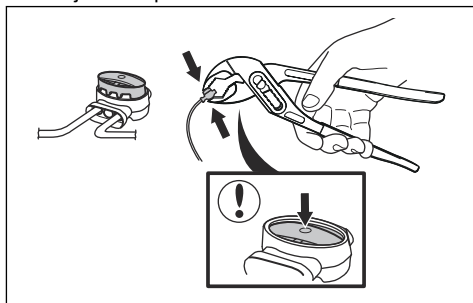

3.9 After the installation of the product

3.9.1 To do a visual check of the charging station

1. Make sure that the indicator LED lamp on the charging station has a green light.
2. If the indicator LED lamp does not have a green light, do a check of the installation. Refer to *LED indicator lamp on the charging station on page 43* and *To install the charging station on page 19*.

3.9.2 To start the product for the first time

When the product is switched on for the first time, there are some basic settings to do before the product can start to operate. You must for

example pair the product and the charging station, and you can choose to enable the theft protection in GeoFence. Refer to *GeoFence on page 28*. You must also pair the product and the Automower® Connect app to be able to change the settings and operate the product. Refer to *Automower® Connect (Bluetooth® only) on page 28*.

1. Set the **Main switch** to position *1*.

Note: The Bluetooth® pairing mode is active for 3 minutes. If pairing has not been successful within this time period, switch off the product. Wait until the LED status indicator is not lit, and then switch on the product again.

2. Enter the factory PIN code.
3. Log in to your Husqvarna account in the Automower® Connect app.
4. Start Bluetooth® on your mobile device.
5. Select *My mowers* in the Automower® Connect app, and then select the plus sign (+).
6. Select model. The Automower® Connect app searches for available products within short-range (Bluetooth®).
7. Select product.
8. Obey the instructions in the Automower® Connect app.

Note: It is only necessary to pair the Automower® Connect app and the product once.

3.10 Automower® Connect

The product has Automower® Connect included from factory.

The app gives 2 modes of connectivity: Long-range cellular connectivity and Short-range Bluetooth® connectivity.

The product can connect to mobile devices that have the Automower® Connect app installed. Automower® Connect is a free app for your mobile device. The Automower® Connect app gives extended functions to your Husqvarna product. You can:

- See the status of your product.
- Change settings to your product.

- Get extended product information.
- Get an alarm if the product moves out of the work area.

Note: All countries do not support Automower® Connect because of regional specified cellular systems.

The Automower® Connect app is preferable if you have one or few products installed. For users with several products we recommend you to use Husqvarna Fleet Services™. Refer to *Husqvarna Fleet Services™* on page 29.

3.10.1 To install Automower® Connect

1. Download the Automower® Connect app on your mobile device.
2. Sign up for a Husqvarna account in the Automower® Connect app.
3. Log in to your Husqvarna account in the Automower® Connect app.

3.10.2 To pair Automower® Connect and the product

1. Do step 1-7 in *To start the product for the first time on page 21*.
2. Obey the instructions in the Automower® Connect app.

3.11 Automower® Connect menu

The main menu in Automower® Connect offers 4 options:

- *Dashboard*
- *Map*
- *Settings*
- *Messages (only available for Bluetooth short-range connectivity)*

3.11.1 Dashboard

The dashboard shows the current status of the product both visually and in text. It is very easy to control the product by tapping the controls, for example *Park*.

In the lower part of the dashboard there are shortcuts to the *Timer settings* and the *Map*. The dashboard also shows symbols according to below:

1. The battery status shows the remaining battery charge. A flash is shown over the

battery symbol when the product charges its battery. A plug is shown over the battery symbol when the product is standing in the charging station without charging.

2. Cutting height.



For more information about the operating modes *Start*, *Park* and *Pause*, see *Operation on page 30*.

3.11.2 Map

The map shows the current position of the product and the set centerpoint (origin) for GeoFence.

3.11.2.1 Map settings

1. Open *Map* in the main menu.
2. Tap the settings symbol down to the right.
3. Enable/disable *Movement path*.
4. Enable/disable *GeoFence radius*.
5. Choose *Map view* or *Satellite view*.

3.12 Settings in Automower® Connect



The product has factory settings but the settings can be adapted to each work area.

The settings that can be changed are described in each of the Settings chapters.

3.13 Timer settings



The timer function controls which periods the product operates.

3.13.1 To calculate the timer setting

1. Calculate the dimension of your lawn in m^2 / yd^2 .
2. Divide the m^2 / yd^2 of the lawn with the approximate operation capacity. Refer to table below.
3. The result is equal to the number of hours that the product must operate each day.

Note: The operation capacity is approximate and timer settings can be adjusted.

Model	Approximate operation capacity, m^2/h / yd^2/h
Automower® 550H	208 / 248

Example: A lawn of $1000 m^2$ / $1200 yd^2$, cut with an Automower® 550H.

$$1000 m^2 / 208 \approx 5 h.$$

$$1200 yd^2 / 248 \approx 5 h.$$

Days / week	h / day	Timer settings
7	5	10:00 - 15:00 / 10 am - 3 pm

3.13.2 Edit timer settings

Tap *Edit* on the Timer Overview screen in the Automower® Connect app. Several timer intervals can be useful to enable the lawn for children's game or other activities during certain hours. To disable mowing a whole day, uncheck that day in the timer settings.

3.13.3 Edit current timer settings

1. Tap the pencil icon to edit an existing timer setting.
2. Choose which days of the week and hours the product should operate.
3. Tap *Save*.

3.13.4 Add a new timer setting

1. Tap the plus sign.
2. Choose which days of the week and hours the product should operate.
3. Tap *Save*.

3.14 Cutting height



The cutting height can be varied from MIN (5 cm / 2 in.) to MAX (9 cm / 3.6 in.).



CAUTION: During the first weeks after a new installation, the cutting height must be set to MAX to avoid damaging the loop wire. After this, the cutting height can be lowered step by step every week until the desired cutting height has been reached.

3.14.1 To set the cutting height

1. Tap the horizontal bar and drag it to the desired cutting height.
2. Tap *Save*.

3.15 Operation



In the Operation's menu it is possible to change the settings of the *Weather timer*, *ECO mode* and *Spiral cutting*.

3.15.1 Weather timer

The *Weather timer* allows the product to automatically adjust its mowing time based on how fast the grass grows.

When the *Weather timer* is activated, the product needs time to decide the optimal mowing time for the work area in question. For this reason it can take a couple of days before mowing is optimized for the *Weather timer*.

The product can not operate longer than the timer settings. It is therefore recommended to only deselect the times when the product must not operate. All other time should be made available for the *Weather timer*.

When the *Weather timer* is activated, it is very important to regularly check that the blade disc is clean and that the blades are in good condition. Any grass twisted around the blade disc shaft, or blunt blades, can affect the *Weather timer*.

1. Tap the **On/Off** bar to enable/disable the *Weather timer*.

Note: If the mowing results are not satisfying, the cutting time can be adjusted to mow for a longer time (*High*) or for a shorter time (*Low*)

3.15.2 ECO mode

The ECO mode function automatically turns off the signal in the boundary loop, the guide wires and the charging station when the product is not mowing. ECO mode is suitable to use where there is other wireless equipment not compatible with the product, for example some hearing loops or garage doors. When ECO mode is activated, the indicator lamp in the charging station flashes green.

ECO mode means that the product can only be started in the charging station and not out in the work area. In ECO mode, it is therefore very important to always press the **STOP** button on top of the product, before removing the product from the charging station. It is otherwise not possible to start the product inside the work area. If the lawnmower has been removed by mistake without first pressing the **STOP** button, the lawnmower must be placed back in the charging station and the **STOP** button pressed. Then press the **START** button to be able to start inside the work area.

Note: In ECO mode, always press the **STOP** button before removing the product from the charging station.

1. Tap the **On/Off** bar to enable/disable ECO mode.

3.15.3 Spiral cutting

If the product enters an area where it senses the grass is longer than average, it can change the movement pattern to spiral cutting. This means that the product mows in a spiral pattern to faster cut the area with longer grass. It is possible to set the intensity of the spiral cutting. *Very low / Low* intensity means that spiral cutting begins less often. *High / Very high* intensity means that spiral cutting begins more often.

Note: In order to minimize the risk for lawn wear in steep slopes, spiral cutting does not start in slopes steeper than 15%.

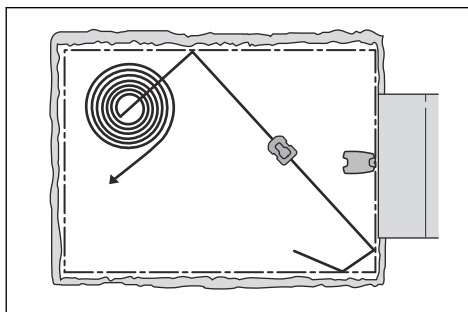

1. Tap the **On/Off** bar to enable/disable *Spiral cutting*.
2. The intensity can be adjusted to trigger on a shorter or longer grass length. Choose an appropriate intensity level by tapping on *Very low, Low, Medium, High* or *Very high*.

3.16 Installation



In the Installation menu it is possible to adapt the settings of the product for best mowing result.

3.16.1 Methods for the product to find the charging station

The product has 3 search methods to find the charging station:

- Charging station signal - The product moves in the work area until it finds the signal of the charging station.
- Guide wire - The product moves in the work area until it finds the guide wire. The product moves along the guide wire to the charging station.
- Boundary wire - The product moves in the work area until it finds the boundary wire. The product moves along the boundary wire to the charging station.

The factory setting is set to mix the 3 search methods. When the battery is low the product starts to search for the charging station with the irregular method for 3 min. After 3 min the product changes search method to the guide wire method. The product tries to find the guide wire for 8 min. After 11 min the product changes search method to the boundary wire method.

You can change the settings for how the product finds the charging station to adapt to the work area.

3.16.2 Finding the charging station

The product can be set to search for the charging station in one or more of the following three ways:

1. Charging station signal
2. Follow boundary wire
3. Follow guide wire

The default settings are set so that these 3 search options are combined to find the charging station as fast as possible, but also with a minimum risk of tracks forming on the lawn. The product always starts by searching for the *Charging station signal*. After a specified time delay, it also uses *Follow guide* and *Follow boundary wire*.

Common causes why the product cannot follow the wire are:

- Obstacles close to the wire have not been isolated.
- The charging station, the boundary wire or the guide wire is not installed in accordance with the instructions in *To install the charging station on page 19*, *To install the boundary wire on page 19* and in *To install the guide wire on page 20*.

3.16.3 Lawn coverage

The product has GPS Assisted Navigation that helps the product select the most optimal operation.

In more complex gardens operation can be improved by carrying out some of the manual settings in the Lawn coverage menu.

3.16.3.1 To disable and enable the GPS function

Disable the GPS Assisted Navigation to make manual settings in *Lawn Coverage*.

Note: It is recommended to use GPS Assisted Navigation.

1. Select *GPS assisted navigation*.
2. Tap the On/Off to enable or disable *GPS assisted navigation*.

Note: When GPS assisted navigation is enabled it is used as long as there is a GPS service. The GPS assisted navigation is used even if manual settings have been made. Only when GPS service is not available, the manual settings are used.

3.16.3.2 Area 1-5 > Enable/disable

Each area can be enabled/disabled, without having to reenter the settings.

1. Tap the **On/Off** bar for Area 1-5.

3.16.3.3 Area 1-5 > How? and How far?

Specify to the right, left or Guide depending on which direction the product should go. The direction (left or right) is when facing the charging station.

1. Slide the horizontal bar to alternate between *Lawn coverage* settings.
2. Slide the horizontal bar to change the distance.

The default settings let the product follow the guide wire 300 m / 328 yd. in 20% of the times it leaves the charging station. If the guide wire in reality is less than 300 m / 328 yd. the product will follow it to the point where the guide wire is connected to the boundary wire.

3.16.3.4 Area 1-5 > How often?

How often the product should go to the remote area is selected as a proportion of the total number of times it leaves the charging station. At all other times, the products starts to mow close to the charging station.

Select the percentage that corresponds to the size of the remote area relative to the total work area. If the remote area is for instance half of the total work area, 50% should be selected. A lower figure should be specified if the remote area is smaller. If more areas are used, take into account that the total figure cannot exceed 100%.

1. Slide the horizontal bar to change the percentage.

3.16.4 Corridor width

3.16.4.1 To set the corridor width of the boundary wire

The boundary wire corridor is the area adjacent to the boundary wire, which the product uses to

find the charging station. When the product moves in the direction of the charging station, it always moves to the left of the boundary wire.

The boundary corridor width is specified in intervals from 1-9. The first number in the interval specifies the shortest distance to the boundary loop and the second number the longest distance. The distance the product maintains from the boundary loop varies depending on the layout of the work area. The default setting is 3-6.

1. Slide the horizontal bar to specify the required interval.

3.16.4.2 To set the corridor width of the guide wire

The guide corridor is the area adjacent to the guide wire, which the product uses to find the charging station. When the product moves in the direction of the charging station, it always moves to the left of the guide wire.

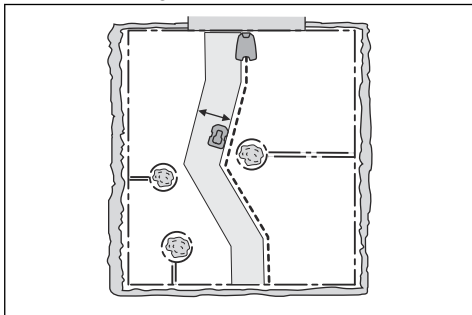

The guide corridor width is adjusted automatically. Only in rare occasions manual settings need to be entered. The guide corridor width can be set between 0 and 9. If guide corridor width is set to 0, the product straddles the guide wire. This means that the product runs right over the guide wire. The default setting is 9.

1. Slide the horizontal bar to specify the required value.

Note: Make the corridor width as wide as possible for a minimum risk of lines in the lawn.

3.16.5 Exit angles

Normally the product leaves the charging station in a direction within the 90°-270° exit sector. By changing the exit angles, it makes it easier for the product to reach the work areas.

3.16.5.1 Exit angles > Sectors

The product can be set for 1 or 2 exit sectors. If the charging station is placed in a passage, 2 exit angles, for instance 70° - 110° and 250° - 290°, can be used.

When 2 exit angles are used, there is a need to also specify how often the product must leave the charging station in *Sector 1*. This is done using the *Proportion* function by initially specifying a percentage.

For instance the percentage of 75 % means that the product leaves the charging station in *Sector 1* on 75% of the times and 25% of the times in *Sector 2*.

1. Slide the horizontal bar to specify the required angles in degrees for the sectors, and proportion as a percentage.

3.16.6 To set the reversing distance

The reversing distance makes the product move in reverse for a set amount of cm before the product starts to cut the lawn. The default setting is 60 cm.

1. Slide the horizontal bar to specify the required reversing distance.

3.16.7 To set the Drive Past Wire function

The front of the product always moves past the boundary wire by a specified distance before the product moves back into the work area. The factory setting is 31 cm. You can select a distance of 20 cm and 50 cm.

1. Slide the horizontal bar to specify how much the product should pass the boundary wire.

3.17 Accessories



Settings for accessories mounted on the product can be made in this menu.

3.17.1 Mower house

When this option is enabled, the wear on the product and the house is reduced, but it can result in more uncut grass around the charging station.

3.17.2 Ultrasonic

Ultrasonic is applicable for Automower® 550H. It ensures that the product reduces speed before it hits an obstacle. This function can be disabled, which means the product will always operate at a lower speed.

3.18 General (Bluetooth® only)



This function is used to set time and date, or to reset to default settings.

3.18.1 Time & Date

This function allows you to set current time and date manually, or to choose to get it from the mobile device.

- **Set time:** Tap *Edit*, then enter the correct time and tap *OK*.
- **Set date:** Tap *Edit*, then enter the correct time and tap *OK*.

3.18.2 To reset to factory settings

This function allows you to reset the product to the factory default settings.

The following settings are however not altered:

- Security level
- PIN code
- Loop signal
- Messages
- Date & Time

1. Select *Reset to factory settings*.
2. Confirm by choosing *Reset*.

3.19 Security (Bluetooth® only)



In the settings menu settings relating to security and the connection between the product and the charging station can be made.

3.19.1 To create a new loop signal

The loop signal is randomly selected to create a unique link between the product and the charging station. In rare cases, there may be a need to generate a new signal, for instance if two adjacent installations have a very similar signal.

1. Place the product in the charging station.

2. Select *Create new loop signal*.
3. Await confirmation that the loop signal has been generated. This normally takes about 10 seconds.

3.19.2 Change PIN code

Note: Changing the PIN code is not possible if the LED indicator lamp on top of the product is either red (error) or green (mowing).

1. Enter the current PIN code.
2. Enter the new PIN code.
3. Confirm by entering the same code again.

Make a note of the new PIN code on the designated line in Memo. Refer to *Introduction on page 3*.

3.19.3 Theft protection

In the *Theft protection* menu it is possible to set the alarm duration and also what events should trigger the alarm.

3.19.3.1 Alarm duration

There is a possibility to set how long the alarm signal should last. A setting between 1 and 10 minutes is possible.

3.19.3.2 Lifted

If the alarm *Lifted* is enabled, the product senses changes in the lift sensors, and the alarm goes off.

3.19.3.3 Turned upside down

If the alarm *Turned upside down* is enabled, the product senses changes in the tilt sensors, and the alarm goes off.

3.19.3.4 STOP button pressed

If the alarm *"STOP button pressed"* is enabled, the alarm goes off if someone presses the **STOP** button. To avoid alarm, the operator must be within short-range (Bluetooth®).

Note: After an alarm has been triggered, you must be close by the product, and clear the alarm in the app by entering the PIN code (only available for short-range Bluetooth® connectivity).

3.19.3.5 Time lock

A time lock can be set to decide how many days will pass before the PIN code must be entered. This means that the product cannot be operated/controlled without first entering the correct PIN code. When the time limit has passed the product continues to mow as normal, but the PIN code must be entered before any new commands or settings can be done. When the PIN code is entered, the product is ready to continue operating. A setting between 1 to 100 days is possible, and the default setting is 30 days.

3.19.4 GeoFence

The GeoFence function makes it possible to track the movement of the product, for example in case of theft.

Before GeoFence can be used, its center point (origin) must be set. This is either done during the first start-up sequence, or in the *Security* menu.

Note: It is only possible to set the center point in GeoFence with short-range connectivity (Bluetooth®).

Note: The product must have access to GPS satellites to be able to set a GPS position. If the charging station is placed in a mower house, under a roof or a large tree, try to place the product out on the lawn. Then try to set GeoFence again.

1. Select *Settings > Security > GeoFence* in the Automower® Connect app.
2. Enable GeoFence by tapping on the **On/Off** bar.
3. Save the GeoFence setting.

The GeoFence radius is 500 m.

Note: When putting the product into storage for a long period, such as during the winter, Husqvarna recommends to switch off the **main switch**.

With the GeoFence function activated, you will need the PIN code in order to switch off the product. Once the main switch has been switched off, the function will stay active for another 12 hours. After that it will not be possible

to communicate with the product and the GeoFence function will not be active.

3.20 Automower® Connect (Bluetooth® only)



In *Automower® Connect* you can enable/disable the Automower® Connect module. You can also see the signal strength, connectivity status, initiate new pairing or remove the product from the paired accounts.

3.21 Messages (Bluetooth® only)

In this menu the previous fault and information messages can be found. For some of the messages, there are tips and advice to help to rectify the fault.

Note: The *Messages* menu is only available for Bluetooth® short-range connectivity.

If the product is disrupted in any way, for example it is trapped or the battery is low, a message is saved relating to the disruption and the time it happened.

If the same message is repeated several times, this may indicate that an adjustment to the installation or the product is required. Refer to *Installation on page 15*.

3.22 My mowers

When choosing *My mowers* you can manage all the products paired to your account, as well as add new ones. If there are several paired products it is possible to select one of them as *Current mower*.

To pair a new product to the Automower® Connect app:

1. Select the plus sign (+).
2. Select model.
3. Follow the instructions in the Automower® Connect app to finalize the pairing.

3.23 Automower® Direct

Automower® Direct uses short-range Bluetooth® communication, and is included in Automower® 550H.

Automower® Direct is useful if the operator has the Automower® Connect app and the PIN code, but has not created a Husqvarna account. Automower® Direct is also useful if the connection with the product is only temporary.

Husqvarna cannot guarantee the time period or coverage of the long-range cellular connectivity. There is therefore a possibility to communicate with the product through Bluetooth® if you are in short-range of the product. You can use Automower® Direct without a Husqvarna account as long as you have the product PIN code.

Note: The Automower® Direct connection is only valid as long as you are within Bluetooth® range. If you move out of Bluetooth® range, you will lose the Automower® Direct connection and you must do the connection process again.

3.23.1 To start to use Automower® Direct

1. Download the Automower® Connect app on your mobile device.
2. Select Automower® Direct on the start screen of the Automower® Connect app.
3. Start Bluetooth® on your mobile device and on the product, refer to *To start the product for the first time on page 21*.
4. Select the product to pair with in the Automower® Connect app.
5. Enter the PIN code for the product.

Note: You have access to the menus and functions as long as you are within Bluetooth® short-range.

3.24 Husqvarna Fleet Services™

Husqvarna Fleet Services™ is a cloud solution that gives the commercial fleet manager an overview of all products. It also gives the fleet manager the possibility to control all products remotely. Husqvarna Fleet Services™ is included for Automower® 550H. For more information about Husqvarna Fleet Services™, refer to www.husqvarna.com.

3.24.1 To connect to the product with Husqvarna Fleet Services™

1. Download the Husqvarna Fleet Services™ app and Automower® Connect app to your mobile device.
2. Create a Husqvarna Fleet Services™ account (www.husqvarna.com).
3. Log on to the Husqvarna Fleet Services™ app.
4. Set the **Main switch** on the product to position *1*.

Note: The Bluetooth® pairing mode is active for 3 minutes. If pairing has not been successful within this time period, switch off the product. Wait until the LED status indicator is not lit, and then switch on the product again.

5. Select the plus sign (+) in the Husqvarna Fleet Services™ app.
6. Select *Automower®* and then *Automower® Pro*. The Husqvarna Fleet Services™ app searches for available products within short-range (Bluetooth®).
7. Select product.
8. Select *Acquire pairing code* to connect the product to your Husqvarna Fleet Services™ account.
9. Obey the instructions in the Husqvarna Fleet Services™ app.

Note: It is only necessary to pair Husqvarna Fleet Services™ app and the product once.

4 Operation

4.1 Main switch



WARNING: Read the safety instructions carefully before you start the product.



WARNING: Keep your hands and feet away from the rotating blades. Never put your hands or feet close to or under the product when the motor is running.



WARNING: Do not use the product when persons, especially children, or animals, are in the work area.

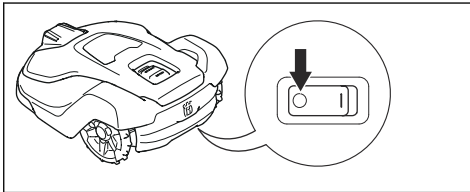

- Set the **Main switch** in the *1* position to start the product.
- Set the **Main switch** in the *0* position when the product is not in use or before any work, inspection or maintenance is being carried out.

When the **Main switch** is set in the *0* position the motors on the product cannot start.

4.2 Start

1. Set the **Main switch** to position *1*.
2. Open the Automower® Connect app.
3. Select the *Dashboard*.
4. Select *Start* in the Automower® Connect app.

If the product is parked in the charging station, it will only leave the charging station when the battery is fully charged and if the timer is set to allow the product to operate.

Note: Make sure that the **START** button on top of the product is in the correct position. The product does not start if the **STOP** button is activated.



4.3 Operating mode - Start

When *Start* has been selected the following operation selections can be selected.

- Main area
- Override timer
- Secondary area

4.3.1 Main area

Main area is the standard work mode where the product cuts grass and charges automatically.

1. Open the Automower® Connect app.
2. Select *Dashboard* in the Main menu.
3. Select *Start*
4. Select *Resume on main area* to start the product.

4.3.2 Override timer

Any timer settings can be temporarily overridden by selecting *Override timer*.

1. Select *Dashboard* in the Main menu.
2. Select *Start*.
3. Slide the horizontal bar of *Override timer* to find a suitable override duration. It is possible to override the timer up to 7 days.
4. Select a suitable override duration.

4.3.3 Secondary area

In the *Secondary area* mode, the product mows until the battery is empty.

If the product charges in the *Secondary area* mode, it will fully charge, drive out about 50 cm / 20 in. and then stop. This indicates that it is charged and ready to start mowing.

Note: It is recommended to change the operation selection to *Main area* before placing the product in the charging station.

4.4 Operating mode - Park

When selecting *Park* the following operation selections can be chosen.

- Park until further notice
- Start on next timer
- Parking duration

4.4.1 Park until further notice

The product stays in the charging station until another operating mode is selected by pressing the **START** button.

4.4.2 Start on next timer

The product stays in the charging station until the next Timer setting permits operation. This operation selection is suitable when there is a need to pause operation, for example for temporary irrigation or for games on the lawn.

4.4.3 Parking duration

The product stays in the charging station for the chosen park duration. This operation selection is suitable if one wishes to pause an ongoing mowing cycle and allow the product to stay in the charging station.

4.4.4 The charging station's park button

The **PARK** button on the charging station is applicable for Automower® 550H. It is used to call the product back to the charging station. *Park* in the Automower® Connect app offers the same function. The **PARK** button on the charging station is useful for instance when the product operates in a large work area and the operator does not have access to the Automower® Connect app.

An LED in the **PARK** button is lit when the button has been pressed. The LED diode goes out when the product is parked in the charging station.

The product stays in the charging station until *Start* in the Automower® Connect app is activated.

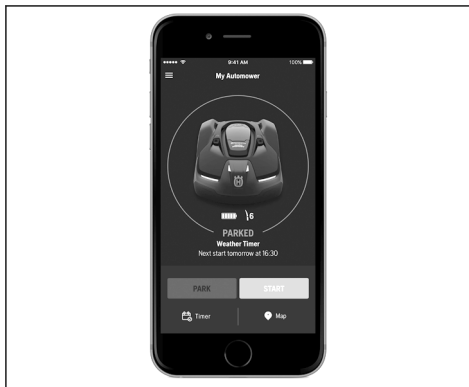

4.4.5 Operating mode - Pause

When selecting *Pause* in the Automower® Connect app, the product stops the current activity and pause. The product is paused until either *Park* or *Start* is selected in the Automower® Connect app.

4.5 Stop

1. Press the **STOP** button on top of the product.

The product stops and the blade motor stops.

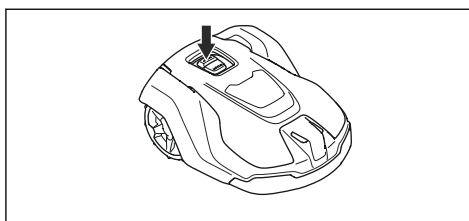

4.6 Switch off

1. Press the **STOP** button on top of the product.
2. Set the **Main switch** to position 0.

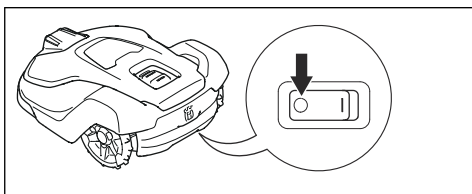

WARNING: Always switch off the product using the main switch if it requires maintenance, or if the product must be moved outside the work area.

4.7 Charge a flat battery

When the Husqvarna product is new or has been stored for a long period, the battery will be flat and needs to be charged before starting.



WARNING: Only charge the product using a charging station which is intended for it. Incorrect use may result in electric shock, overheating or leakage of corrosive liquid from the battery.

In the event of leakage of electrolyte flush with water and seek medical help if it comes in contact with the eyes etc.

1. Set the **Main switch** to position *1*.
2. Place the product in the charging station. Slide the product in as far as possible to ensure proper contact between the product and the charging station. See contact and charging strips in *Product overview on page 4*
3. The dashboard in the Automower® Connect app shows that charging is in progress.

5 Maintenance

5.1 Introduction - maintenance

For better operating reliability and longer service life: check and clean the product regularly and replace worn parts if necessary. All maintenance and servicing must be done according to Husqvarna's instructions. Refer to *Maintenance on page 33*.

It is important that the blade disc rotates easily. The edges of the blades should not be damaged. The lifetime of the blades varies immensely and depends for instance on:

- Operating time and size of the work area.
- Type of grass and seasonal growth.
- Soil, sand and use of fertilizers.
- The presence of objects such as, toys, tools, stones, roots and the like.

The normal life is 2 to 5 weeks when used under favorable conditions. Refer to *Replace the blades on page 34* on how to replace the blades.



WARNING: Wear protective gloves.

Note: Working with blunt blades gives a poorer mowing result. The grass is not cut cleanly and more energy is needed, resulting in the product not being able to maintain such a large area.

5.2 Clean the product

It is important to keep the product clean. A product with large amounts of grass stuck to it will not cope as well with slopes. It is recommended to clean using a brush.

Husqvarna offers a special cleaning and maintenance kit as an accessory. Contact your Husqvarna central service.



CAUTION: Never use a high-pressure washer to clean the product. Never use solvents for cleaning.

5.2.1 Chassis and blade disc

Inspect the blade disc and blades once a week.

1. Set the **Main switch** to position 0.

2. Lift the product onto its side.
3. Clean the blade disc and chassis using for example a dish brush. At the same time, check that the blade disc rotates freely in relation to the foot guard. Also, check that the blades are intact and can pivot freely.

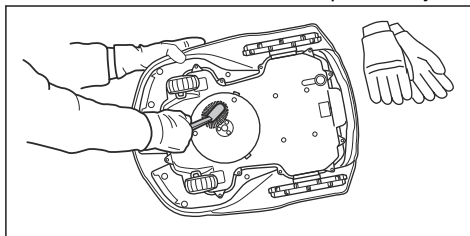

5.2.2 Chassis

Clean the underside of the chassis. Brush or wipe with a damp cloth.

5.2.3 Wheels

Clean around the front wheels and rear wheel as well as the rear wheel bracket. Grass on the wheels can impact on how the product performs in slopes.

5.2.4 Cover

Use a damp, soft sponge or cloth to clean the cover. If the cover is very dirty it may be necessary to use a soap solution or washing-up liquid.

5.2.5 Charging station

Clean the charging station regularly from grass, leaves, twigs and other objects that may impede docking.



WARNING: Use the plug to disconnect the charging station before any maintenance, or cleaning of charging station or power supply.

5.3 Replace the blades



WARNING: Use blades and screws of the right type. Husqvarna can only guarantee safety when using original blades. Only replacing the blades and reusing the screw can result in a screw wearing during mowing. The blades can then be propelled from under the body and cause serious injury.

Replace worn or damaged parts for safety reasons. Even if the blades are intact, they should be replaced on a regular basis for the best mowing result and low energy usage. All 3 blades and screws must be replaced at the same time to obtain a balanced cutting system. Use Husqvarna original blades embossed with the crowned H-mark logotype, refer to *Technical data on page 50*.

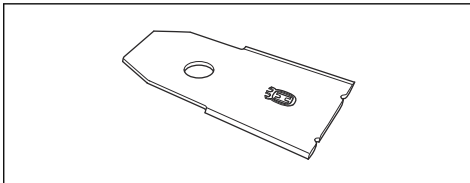

5.3.1 To replace the blades

1. Set the **Main switch** to position 0.

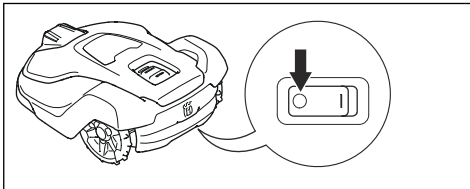

2. Turn the product upside down. Place the product on a soft and clean surface to avoid scratching the body and the hatch.
3. Rotate the skid plate so that its holes align with the screws for the blade.
4. Remove the 3 screws. Use a manual straight slot or cross-tip screwdriver.

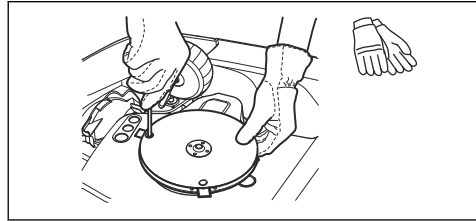

5. Remove each blade and screw.
6. Fasten new blades and screws.
7. Check that the blades can pivot freely.

5.4 Battery



WARNING: Only charge the product using a charging station and power supply which is intended for it. Incorrect use may result in electric shock, overheating or leakage of corrosive liquid from the battery. In the event of leakage of electrolyte flush with water and seek medical help if it comes in contact with the eyes etc.



WARNING: Use only original batteries recommended by the manufacturer. Product safety cannot be guaranteed with other batteries. Do not use non-rechargeable batteries.



CAUTION: The battery must be charged fully before winter storage. If the battery is not fully charged it can be damaged and in certain cases be rendered useless.

Below indicates that the battery is getting old and eventually needs replacing:

- The operating time for the product is shorter than normal between charges. This leads to more charging cycles than normal, which increases the risk of tracks forming near the charging station.
- The product is found standing out on the lawn with *Empty battery* message. This indicates that the product does not have battery capacity enough to find the charging station.

The battery is fine as long as the product maintains a well-cut lawn.

Note: Battery life is dependent on the length of the season and how many hours a day the product is operating. A long season or many hours of use a day means that the battery must be replaced more regularly.

Contact your local Husqvarna representative to replace the battery.

5.5 Winter service

Take your product to your local Husqvarna representative for service prior to winter storage. Regular winter service will maintain the product in good condition and create the best conditions for a new season without any disruptions.

Service usually includes the following:

- Thorough cleaning of the body, the chassis, the blade disc and all other moving parts.
- Testing of the products's function and components.
- Checking and, if required, replacing wear items such as blades and bearings.
- Testing the products's battery capacity as well as a recommendation to replace battery if necessary.
- If new software is available, the product is updated.

6 Troubleshooting

6.1 Introduction - troubleshooting

All messages can be found in the *Messages* menu in Automower® Connect. More suggestions for steps to take in the event of malfunction or symptoms can be found on www.husqvarna.com.

Note: The *Messages* menu is only available for short-range connectivity (Bluetooth®).

6.2 Fault messages

The list below shows a number of fault messages that may be shown in the display of the product. Contact your local Husqvarna representative if the same message appears often.

Message	Cause	Action
<i>Wheel motor blocked</i>	Grass or other object is wrapped around the drive wheel.	Check the drive wheel and remove the grass or other object.
<i>Cutting system blocked</i>	Grass or other object is wrapped around the blade disc.	Check the drive wheel and remove the grass or other object.
	The blade disc lies in a pool of water.	Move the product and prevent the collection of water in the work area.
<i>Cutting height blocked</i>	Grass or other object is wrapped around the cutting height adjustment, or between the blade disc and chassis.	Check the blade disc and the bellows around the cutting height adjustment, and remove any grass or other objects that may have got stuck.
<i>Trapped</i>	The product has got caught in something.	Free the product and rectify the reason for it becoming trapped.
	The product is stuck behind a number of obstacles.	Check if there are any obstacles which make it hard for the product to move on from this location.

Message	Cause	Action
<i>No loop signal</i>	The power supply is not connected.	Check the wall socket connection and whether an earth-fault breaker has tripped or not. Check that the low voltage cable is connected to the charging station.
	The low voltage cable is damaged or not connected.	Check that the low voltage cable is not damaged. Check that it is also properly connected to the charging station and to the power supply.
	The boundary wire is not connected to the charging station.	Check that the boundary wire connectors are fitted properly to the charging station. Replace connectors if damaged. Refer to <i>To install the boundary wire on page 19</i> .
	Boundary wire broken.	Find out where the break is. Replace the damaged section of the loop with a new loop wire and splice using an original coupler. Refer to <i>Finding breaks in the loop wire on page 46</i> .
	<i>ECO mode</i> is activated and the product has attempted to start outside the charging station.	Place the product in the charging station and start the product again. Refer to <i>Start on page 30</i> .
	The boundary wire is laid in the wrong direction around an island.	Check that the boundary wire was laid according to instructions, e.g. in the right direction around the island. Refer to <i>Before the installation of the product on page 15</i> .
	The connection between the product and the charging station has been broken.	Place the product in the charging station and generate a new loop signal. Refer to <i>To create a new loop signal on page 27</i> .
<i>Wrong PIN code</i>	Disturbances from metal objects (fences, reinforcement steel) or buried cables close by.	Try moving the boundary wire.
	Wrong PIN code has been entered. Five attempts are permitted, and the keypad is then blocked for five minutes.	Enter the correct PIN code. Contact your local Husqvarna representative if you forget the PIN code.

Message	Cause	Action
<i>Outside work area</i>	The boundary wire connections to the charging station are crossed.	Check that the boundary wire is connected correctly.
	The boundary wire is too close to the edge of the work area.	Check that the boundary wire has been laid according to the instructions. Refer to <i>To install the boundary wire on page 19</i> .
	The work area slopes too much by the boundary loop.	
	The boundary wire is laid in the wrong direction around an island.	
	Disturbances from metal objects (fences, reinforcement steel) or buried cables close by.	Try moving the boundary wire.
	The product finds it hard to distinguish the signal from another product installation close by.	Place the product in the charging station and generate a new loop signal. Refer to <i>To create a new loop signal on page 27</i> .
<i>Empty battery</i>	The product cannot find the charging station.	Check that the charging station and the guide wire are installed in accordance with the instructions. Refer to <i>Installation of the product on page 19</i> .
	The guide wire is broken or not connected.	Find out where the break is and rectify it.
	The battery is spent.	Replace the battery. Refer to <i>Battery on page 34</i> .
	The charging station's antenna is defective.	Check if the indicator lamp in the charging station flashes red. Refer to <i>LED indicator lamp on the charging station on page 43</i> .
<i>No drive</i>	The product has got caught in something.	Free the product and rectify the reason for the lack of drive. If it is due to wet grass, wait until the lawn has dried before using the product.
	The work area includes a steep slope.	Maximum guaranteed slope is 45%. Steeper slopes should be isolated. Refer to <i>To put the boundary wire in a slope on page 17</i> .
	The guide wire is not laid at an angle on a slope.	If the guide wire is laid on a slope, it must be laid at an angle across the slope.
<i>Wheel motor overloaded</i>	The product has got caught in something.	Free the product and rectify the reason for the lack of drive. If it is due to wet grass, wait until the lawn has dried before using the product.

Message	Cause	Action
<i>Charging station blocked</i>	The contact between the charging strips and contact strips may be poor and the product has made a number of attempts to charge.	Put the product in the charging station and check that the charging strips and contact strips make good contact.
	An object is obstructing the product.	Remove the object.
	The charging station is tilted or bent.	Confirm that the charging station is placed on a fully flat and horizontal ground. The charging station must not be tilted or bent.
<i>Stuck in charging station</i>	There is an object in the way of the product preventing it from leaving the charging station.	Remove the object.
<i>Upside down</i>	The product is leaning too much or has turned over.	Place the product on a flat, level surface, and start the product again.
<i>Needs manual charging</i>	The product is set to the <i>Secondary area</i> operating mode.	Place the product in the charging station. This behavior is normal and no action is required.
<i>Next start hh:mm</i>	The timer setting prevents the product from operating.	Change the timer settings. Refer to <i>Timer settings on page 22</i> .
	The clock on the product is not correct.	Set the time. Refer to <i>Time & Date on page 27</i> .
<i>Lifted</i>	The lift sensor has been activated as the product has become trapped.	Free the product.
<i>Collision sensor problem, front/rear</i>	The body of the product can not move freely around its chassis.	Check that the body of the product can move freely around its chassis. If the problem remains, the message requires action by an authorized service technician.
<i>Wheel drive problem, right/left</i>	Grass or other object is wrapped around the drive wheel.	Clean the wheels and around the wheels.
<i>Alarm! Mower stopped</i>	The alarm was activated because the product was stopped.	Adjust the mower security settings in the <i>Security</i> menu. Refer to <i>Security (Bluetooth® only) on page 27</i> .
<i>Alarm! Mower lifted</i>	The alarm was activated because the product was lifted.	
<i>Alarm! Mower tilted</i>	The alarm was activated because the product was tilted.	

Message	Cause	Action
<i>Electronic problem</i>	Temporary electronic or software related issue in the product.	Switch off/on the product. If the problem remains, the message requires action by an authorized service technician.
<i>Loop sensor problem, front/rear</i>		
<i>Charging system problem</i>		
<i>Tilt sensor problem</i>		
<i>Temporary problem</i>		
<i>Temporary battery problem</i>	Temporary battery or software related issue in the product.	Switch off/on the product. If the problem remains, the message requires action by an authorized service technician.
<i>Battery problem</i>		
<i>Charging current too high</i>	Wrong or faulty power supply unit.	Switch off/on the product. If the problem remains, the message requires action by an authorized service technician.
<i>Connectivity problem</i>	Potential problem on the connectivity circuit board in the product.	Switch off/on the product. If the problem remains, the message requires action by an authorized service technician.

6.3 Information messages

The list below shows a number of information messages that may be found in the *Messages* menu in the Automower® Connect app. Contact your local Husqvarna representative if the same message appears often.

Message	Cause	Action
<i>Low battery</i>	The product cannot find the charging station.	Check that the charging station and the guide wire are installed in accordance with the instructions. Refer to <i>Before the installation of the product on page 15</i> .
	The guide wire is broken or not connected.	Find out where the break is and rectify it.
	The battery is spent.	Replace the battery. Refer to <i>Battery on page 34</i> .
	The charging station's antenna is defective.	Check if the indicator lamp in the charging station flashes red. Refer to <i>LED indicator lamp on the charging station on page 43</i> .
<i>Settings restored</i>	Confirmation that a <i>Reset all user settings</i> has been carried out.	This is normal. No action required.
<i>Limited cutting height range</i>	The maximum and minimum position of the cutting height adjustment is limited.	Check that no grass or other objects are blocking the blade disc from moving up or down.
		Carry out a cutting height calibration. Contact your local Husqvarna representative.
<i>Unexpected cutting height adj</i>	The cutting height adjustment is altered without a request from the product.	Carry out a cutting height calibration. Contact your local Husqvarna representative.
<i>Cutting system imbalance</i>	The product has discovered vibrations in the cutting disc.	Verify that the blades and screws are intact and not worn out. Verify that all blades are correctly mounted. Check that no double blades are mounted on any of the three blade positions.

Message	Cause	Action
<i>Guide 1 not found</i> <i>Guide 2 not found</i> <i>Guide 3 not found</i>	The guide wire is not connected to the charging station.	Check that the guide wire's connector is tightly connected to the charging station. Refer to <i>To install the guide wire on page 20</i> .
	Break in the guide wire.	Find out where the break is. Replace the damaged section of the guide wire with a new loop wire and splice using an original coupler.
	The guide wire is not connected to the boundary loop.	Check that the guide wire is connected correctly to the boundary loop. Refer to <i>To install the guide wire on page 20</i> .
<i>Guide calibration failed</i>	The product has failed to calibrate the guide wire.	Check that the guide wires are installed according to the instructions. Refer to <i>To install the guide wire on page 20</i> .
<i>Guide calibration accomplished</i>	The product has succeeded to calibrate the guide wire.	No action required.
<i>GPS navigation problem</i>	Problem with the GPS assisted navigation equipment.	Contact your local Husqvarna representative if this message appears often.
<i>Weak GPS signal</i>	The GPS signal is weak for the current work area. GPS assisted navigation cannot be used.	If the message appears often, disable the GPS assisted navigation and instead use the manual settings for Lawn coverage. Refer to <i>To disable and enable the GPS function on page 25</i> .
<i>Difficult finding home</i>	The product has been following the boundary wire several laps without finding the charging station.	The installation has not been done correctly. Refer to <i>Installation on page 15</i> .
		Wrong corridor width setting on boundary wire. Refer to <i>To set the corridor width of the boundary wire on page 25</i> .
		The product was started on a Secondary area with the Main area setting.
<i>Temporary problem with the server.</i>	Please try again.	Contact your local Husqvarna representative if this message appears often.
<i>Connection problems</i>	Problem with the Automower® Connect module	Restart the product. If there still is a connection problem, try to unpair the product (<i>My mowers</i>) and then pair it again. If the problem remains, contact your local Husqvarna representative.
<i>Connection settings restored</i>	Settings for wireless connectivity have been restored due to an error.	Check and revise settings if necessary.

Message	Cause	Action
<i>Weak signal</i>	Weak GPS signal for Automower® Connect module	Make sure that the product is not upside down. If the problem remains, the message requires action by an authorized service technician.
<i>SIM card requires PIN</i>	The SIM card must be unlocked.	Make sure the correct SIM PIN has been entered into the mower's menu (Network > SIM card). Contact your local Husqvarna representative if this message appears often.
<i>SIM card locked</i>	The SIM card must be replaced.	Contact your local Husqvarna representative.
<i>SIM card not found</i>	Automower® Connect requires a SIM card to be inserted in the mower.	Contact your local Husqvarna representative.
<i>GeoFence problem</i>	The GeoFence is not work due to poor (or no) communication with the system.	Contact your local Husqvarna representative.

6.4 LED indicator lamp on the charging station

For a fully functional installation, the indicator lamp in the charging station must emit a solid or flashing green light. If any other color than green is visible, follow the troubleshooting guide below.

There is more help on www.husqvarna.com. If you still need help, please contact your local Husqvarna representative.

Light	Cause	Action
<i>Solid green light</i>	Good signals	No action required
<i>Green flashing light</i>	The signals are good and <i>ECO mode</i> is activated.	No action required. For more information on <i>ECO mode</i> . Refer to <i>ECO mode on page 24</i> .
<i>Blue flashing light</i>	The boundary loop is not connected to the charging station.	Check that the boundary wire connectors are fitted properly to the charging station. Refer to <i>To install the boundary wire on page 19</i> .
	Break in the boundary loop.	Find out where the break is. Replace the damaged section of the loop with a new loop wire and splice using an original coupler.
<i>Red flashing light</i>	Interruption in the charging station's antenna.	Contact your local Husqvarna representative.
<i>Solid red light</i>	Fault in the circuit board or incorrect power supply in the charging station. The fault should be rectified by an authorized service technician.	Contact your local Husqvarna representative.

6.5 LED indicator lamp on the product

There is a LED indicator lamp on top of the product, which shows the current status:

Light	Cause	Action
<i>Solid green light</i>	The product is either mowing the lawn, or leaving the charging station.	No action required.
<i>Solid blue light</i>	The product is either paused, parked, charging or is searching for the charging station.	No action required.
<i>Solid yellow light</i>	The STOP button has been pressed.	Press the START button on top of the product to start it again.
<i>Solid red light</i>	The product has stopped due to an error.	Clear the error by pressing the STOP button, and then activate the product by pressing the START button on top of the product.
<i>Flashing yellow light</i>	The product requests the PIN code.	The PIN code needs to be confirmed in the Automower® Connect app before the product can be activated.

There is more help on www.husqvarna.com. If you still need help, please contact your local Husqvarna representative.

6.6 Symptoms

If your product does not work as expected, follow the symptoms guide below.

There is a FAQ (Frequently Asked Questions) on www.husqvarna.com which provides more detailed answers to a number of standard questions. Contact your local Husqvarna representative if you still cannot find the reason for the fault.

Symptoms	Cause	Action
The product has difficulty docking.	The boundary wire is not laid in a long straight line that is far enough out from the charging station.	Check that the charging station has been installed correctly. Refer to <i>To install the charging station on page 19</i>
	The charging station is on a slope.	Place the charging station on a surface that is entirely level. Refer to <i>To examine where to put the charging station on page 15</i> .
The product runs at the wrong time	The product clock needs to be set.	Set the clock. Refer to <i>Time & Date on page 27</i> .
	The start and stop times for mowing are incorrect.	Reset the start time and stop time settings for mowing. Refer to <i>Timer settings on page 22</i> .
The product vibrates.	Damaged blades lead to imbalance in the cutting system.	Inspect the blades and screws and replace them if necessary. Refer to <i>To replace the blades on page 34</i> .
	Too many blades in the same position lead to imbalance in the cutting system.	Check that only one blade is fitted at each screw.
	Different versions (thickness) of Husqvarna blades are used.	Check if the blades are of different versions.
The product runs, but the blade disc does not rotate.	The product searches for the charging station.	No action. The blade disc does not rotate when the product is searching for the charging station.
The product mows for shorter periods than usual between charges.	Grass or other foreign object blocks the blade disc.	Remove and clean the blade disc. Refer to <i>Chassis and blade disc on page 33</i> .
	The battery is spent.	Replace the battery. Refer to <i>Battery on page 34</i> .
Both the mowing and charging times are shorter than usual.	The battery is spent.	Replace the battery. Refer to <i>Battery on page 34</i> .
The product is parked for hours in the charging station.	The product is parked due to a timer setting, or because <i>Park until further notice</i> has been chosen in the app.	Open the app and edit the timer settings, or go to <i>Dashboard</i> and start the product.

Symptoms	Cause	Action
The product often moves in circles or spirals.	Spiral cutting is a natural part of the product's movement pattern.	Adjust the intensity of spiral cutting. This function can be disabled if necessary. Refer to <i>Spiral cutting on page 24</i> .
The product turns round and stays on a small area for several minutes.	This is completely normal for the product. The product has GPS assisted navigation that contributes to an even result.	No action.
Uneven mowing results.	The product works too few hours per day.	Increase the mowing time. Refer to <i>Timer settings on page 22</i> . The <i>Weather timer</i> senses that the lawn has been mowed more than it actually has. Increase the intensity level in the <i>Weather timer</i> . Disable the <i>Weather timer</i> if this does not help.
	The <i>How often?</i> setting is incorrect in relation to the layout of the work area. Note: Not applicable if GPS assisted navigation is enabled.	Check that the correct <i>How often?</i> value is selected.
	The shape of the work area requires the use of <i>Area 1-5</i> for the product to find its way to all remote areas. Note: Not applicable if GPS assisted navigation is enabled.	Use <i>Area 1-5</i> to steer the product to a remote area. Refer to <i>Lawn coverage on page 25</i> .
	Work area is too large.	Try to limit the work area, or to extend the work time. Refer to <i>To examine where to put the boundary wire on page 16</i> .
	Dull blades.	Replace all the blades. Refer to <i>Replace the blades on page 34</i> .
	Long grass in relation to the set cutting height.	Increase the cutting height and then successively lower it.
	Accumulation of grass by the blade disc or around the motor shaft.	Check that the blade disc rotates freely and easily. If not, screw off the blade disc and remove grass and foreign objects. Refer to <i>Chassis and blade disc on page 33</i> .

6.7 Finding breaks in the loop wire

Breaks in the loop wire are usually the result of unintentional physical damage to the wire such as when gardening with a shovel. In countries with ground frost, also sharp stones that move in the ground can damage the wire. Breaks can also occur due to the wire being stretched excessively during installation.

Mowing the grass too low right after the installation can damage wire insulation. Damage to the insulation may not cause disruptions until several weeks or months later.



CAUTION: Always select the maximum cutting height the first weeks after installation and then lower the height one step at a time every second week until the desired cutting height has been reached.

A defective splicing of the loop wire can also lead to disruptions several weeks after the splice was done. A faulty splice can, for example, be the result of the original coupler not being pressed together hard enough with a pair of pliers, or that a coupler of lower quality than the original coupler has been used.

Note: Please first check all known splices before further troubleshooting is done.

A wire break can be located by gradually halving the distance of the loop where the break may have occurred until there is only a very short section of the wire left.

The following method does not work if *ECO mode* is activated. Make sure first that *ECO mode* is turned off. Refer to *ECO mode on page 24*.

1. Check that the indicator lamp in the charging station flashes blue, which indicates a break in the boundary loop. Refer to *LED indicator lamp on the charging station on page 43*.

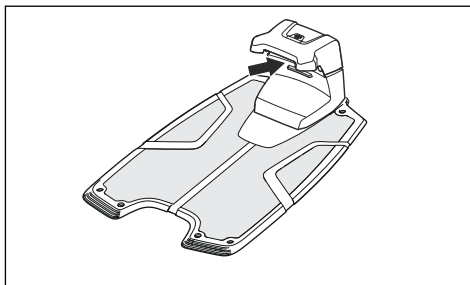

2. Check that the boundary wire connections to the charging station are properly connected and not damaged. Check that the indicator lamp in the charging station is still flashing blue.

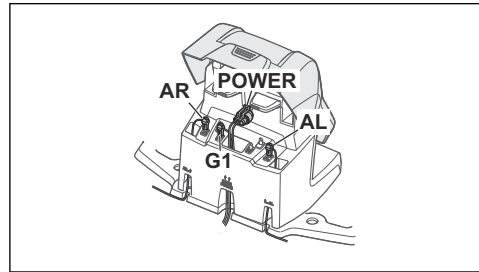

3. Switch the connections between the guide wire and the boundary wire in the charging station.

Start by switching connection AL and G1.

If the indicator lamp is lit with a solid green light, then the break is somewhere on the boundary wire between AL and the point where the guide wire is connected to the boundary wire (thick black line in the illustration).

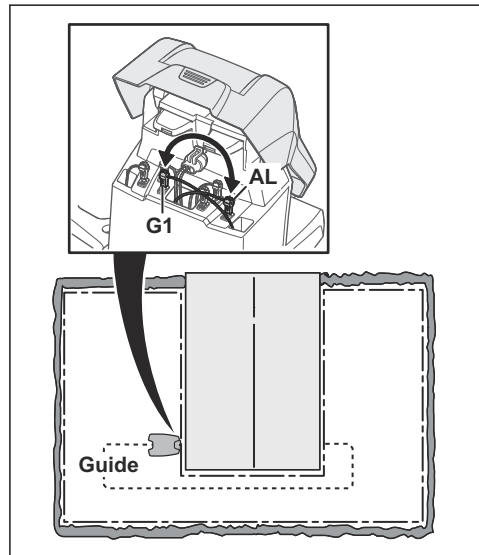

To rectify the fault you will need boundary wire, connector(s) and coupler(s):

- a) If the suspected boundary wire is short then it is easiest to exchange all of the boundary wire between AL and the point where the guide wire is connected to the boundary wire (thick black line).

b) If the suspected boundary wire is long (thick black line) then do as follows: Put AL and G1 back to their original positions. Then disconnect AR. Connect a new loop wire to AR. Connect the other end of this new loop wire at the middle of the suspected wire section.

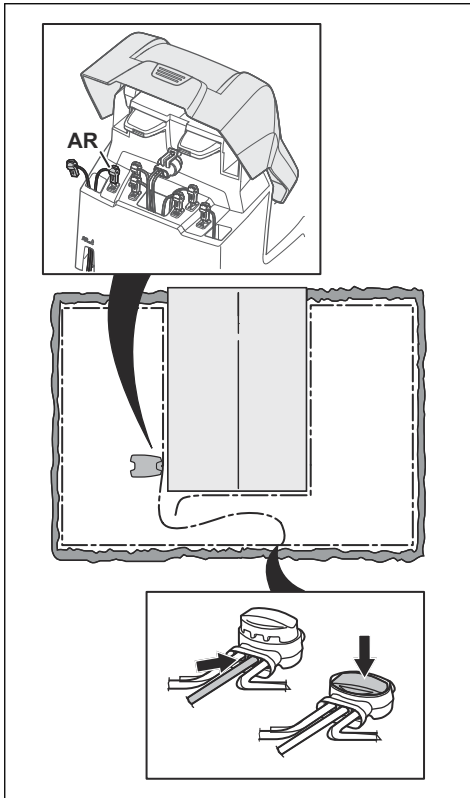

If the indicator lamp now is green, then the break is somewhere in the wire between the disconnected end to the point where the new wire is connected (thick black line below). In that case, move the connection for the new wire closer to the disconnected end (roughly at the middle of the suspected wire section) and check again if the indicator lamp is green.

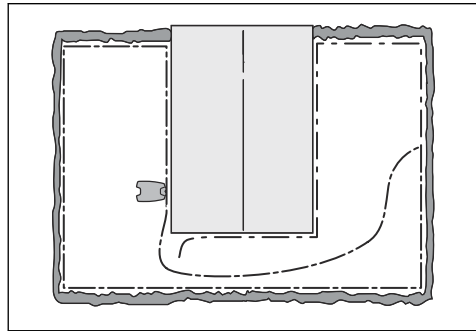

Continue until only a very short section of the wire remains which is the difference between a solid green light and a flashing blue light. Then follow instruction in step 5 below.

4. If indicator lamp still flashes blue in step 3 above: Put AL and G1 back in their original positions. Then switch AR and G1. If indicator lamp now is lit with a solid green light then disconnect AL and connect a new boundary wire to AL. Connect the other end of this new wire at the middle of the suspected wire section. Follow the same approach as in 3a) and 3b) above.
5. When the break is found, the damaged section must be replaced with a new wire. Always use original couplers.

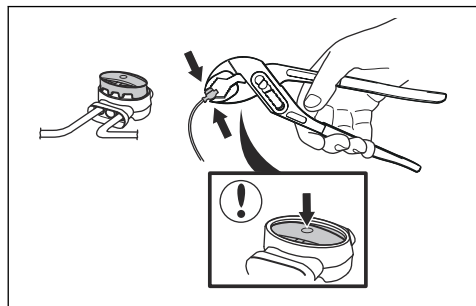

7 Transportation, storage and disposal

7.1 Transportation

The supplied Li-ion batteries obey the Dangerous Goods Legislation requirements.

- Obey all applicable national regulations.
- Obey the special requirement on package and labels for commercial transportations, including by third parties and forwarding agents.

7.2 Storage

- Fully charge the product. Refer to *Charge a flat battery on page 32*.
- Disconnect the product with the **main switch**. Refer to *Switch off on page 31*.
- Clean the product. Refer to *Clean the product on page 33*.
- Keep the product in a dry, frost free space.
- Keep the product with all wheels on level ground during storage, or use a Husqvarna wall hanger.
- If you keep the charging station indoors, disconnect and remove the power supply and all the connectors from the charging station. Put the end of each connector wire in a container with grease.

Note: If you keep the charging station outdoors, do not disconnect the power supply and the connectors.

7.3 Disposal

- Obey the local recycling requirements and applicable regulations.
- For questions about how to remove the battery, refer to *To remove the battery on page 49*.

7.3.1 To remove the battery



CAUTION: Only remove the battery when you dispose the product. When you remove the warranty seal, the Husqvarna warranty is no longer applicable.

1. Disconnect the product with the **Main switch**. Refer to *Switch off on page 31*.

2. Pull out the grommet on the charging cable at the very front of the product, and carefully remove the connector.
3. Lift the cover, one corner at a time.
4. Remove the 14 screws with a Torx 20.

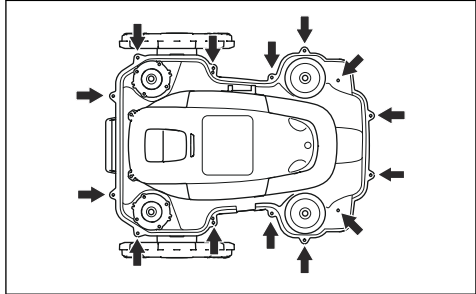

5. Lift the rear edge of the top section of the chassis.
6. Disconnect the MMI cable from the main circuit board.
7. Remove the top section of the chassis.
8. Remove the 3 screws that holds the battery with a Torx 20.

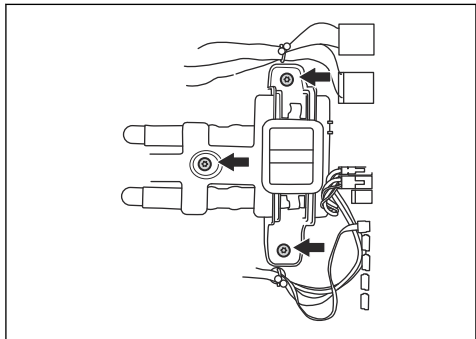

9. Disconnect the battery connection from the main circuit board.
10. Open the battery cover and remove the battery.

8 Technical data

8.1 Technical data

Dimensions	Automower® 550H
Length, cm / in.	75 / 29.5
Width, cm / in.	63 / 24.8
Height, cm / in.	33 / 13
Weight, kg / lbs	15 / 33

Electrical system	Automower® 550H
Battery, Lithium-Ion 18V, 5.2 Ah, Art. No	588 14 64-01
Battery, Lithium-Ion 18V, 5.0 Ah, Art. No	593 11 84-01
Battery, Lithium-Ion 18V, 4.9 Ah, Art. No	593 11 84-02
Power supply, V/28 V DC	100-240
Low voltage cable length, m	10
Mean energy consumption at maximum use	23 kWh/month in a 5000 m ² work area
Charging current, A DC	7
Average mowing time, min	270
Average charging time, min	60

Boundary wire antenna	Automower® 550H
Operating Frequency Band, Hz	300-80000
Maximum Radio-frequency power, mW @60m ⁶	<25 mW @60m

Noise emissions measured in the environment as sound power ⁷	Automower® 550H
Measured sound power noise level, dB (A)	60
Noise emissions uncertainties K_{WA} , dB (A)	1
Guaranteed sound power noise level, dB (A)	61
Sound pressure noise level at the operator's ear, dB (A) ⁸	49

⁶ Maximum active output power to antennas in the frequency band in which the radio equipment operates.

⁷ Noise emissions in the environment measured as sound power (L_{WA}) in conformity with EC directive 2000/14/EC. The guaranteed sound power level includes variation in production as well as variation from the test code with 1-3 dB(A).

⁸ Sound pressure noise uncertainties K_{pA} , 2-4 dB (A).

Mowing	Automower® 550H
Cutting system	3 pivoted cutting blades
Maximum blade motor speed, rpm	2300
Power consumption during cutting, W +/- 20 %	35
Cutting height, cm / in.	5-9 / 2-3.6
Cutting width, cm / in.	24 / 9.4
Narrowest possible passage, cm / in.	60 / 24
Maximum angle for cutting area, %	45
Maximum angle for boundary wire, %	15
Maximum length boundary wire, m / yd	800 / 874
Maximum length guide loop, m / yd	400 / 437
Working capacity, m ² / yd ² +/- 20%	5000 / 5979

IP-classification	Automower® 550H
Robotic lawnmower	IPX4
Charging station	IPX1
Power supply	IPX4

Frequency Band Support	
Bluetooth® Frequency range	2400.0-2483.5 MHz
Automower® Connect 3G	Band 19 (800 MHz)
	Band 5 (850 MHz)
	Band 8 (900 MHz)
	Band 2 (1900 MHz)
	Band 1 (2100 MHz)
Automower® Connect 2G	GSM 850 MHz
	E-GSM 900 MHz
	DCS 1800 MHz
	PCS 1900 MHz

Power Class		
Bluetooth® Output power	8 dBm	
Automower® Connect 3G	Power Class 3	24 dBm
Automower® Connect 2G	Power Class 4 (for GSM/E-GSM)	33 dBm
	Power Class 1 (for DCS/PCS)	30 dBm

Full compatibility cannot be guaranteed between the product and other types of wireless systems such as remote controls, radio transmitters, hearing loops, buried electric animal fencing or similar.

The products are made in England or the Czech Republic. See information on the rating plate. Refer to *Introduction on page 3*.

8.2 Registered trademarks

The *Bluetooth®* word mark and logos are registered trademarks owned by *Bluetooth SIG, inc.* and any use of such marks by Husqvarna is under license.

9 Warranty

9.1 Guarantee terms

Husqvarna guarantees this product's functionality for a period of two years (from date of purchase). The guarantee covers serious faults relating to materials or manufacturing faults. Within the guarantee period, we will replace the product or repair it at no charge if the following terms are met:

- The product and the charging station may only be used in compliance with the instructions in this Operator's Manual. This manufacturer's warranty does not affect warranty entitlements against the dealer/retailer.
- End-users or non-authorized third parties must not attempt to repair the product.

Examples of faults which are not included in the guarantee:

- Damage caused by water seepage from using a high-pressure washer, or from being submerged under water, for example when heavy rain forms pools of water.
- Damage caused by lightning.
- Damage caused by improper battery storage or battery handling.
- Damage caused by using a battery that is not a Husqvarna original battery.
- Damage caused by not using Husqvarna original spare parts and accessories, such as blades and installation material.
- Damage to the loop wire.
- Damage caused by non-authorized changing or tampering with the product or its power supply.

The blades and wheels are seen as disposable and are not covered by the guarantee.

If an error occurs with your Husqvarna product, please contact Husqvarna customer service for further instructions. Please have the receipt and the product's serial number at hand when contacting Husqvarna customer service.

10 Applicable to US/CA market

10.1 Supplier's Declaration of Conformity

Issuer: Husqvarna AB, Drottninggatan 2, S-561 82 Huskvarna, Sweden
www.husqvarnagroup.com.

Responsible party: Husqvarna Professional Products, Inc. 9335 Harris Corners Parkway Suite 500 Charlotte, NC 28269 United States U.S. Contact information: James McNew, Manager Product Compliance, Telephone: +1 704 597 5000.

10.2 Compliance requirements

FCC ID: XPY1CGM5NNN (Automower® Connect module).

FCC ID: ZASHQ-BLE-1A and **FCC ID ZASHQ-BLE-1B** (Bluetooth® module).

The Bluetooth module is located on the HMI-board (PCBA) in the upper chassis. It must only be accessed by an authorized service technician.

The device complies with part 15 of the FCC Rules. Operation is subjected to the following 2 conditions:

1. This device may not cause harmful interference.
2. This device must accept any interference received, including interference that may cause undesired operation.



WARNING: To comply with RF exposure requirements, please maintain a separation distance of at least 20 cm/ 7 inches from any part of the product.

Models with a hatch: The supplied label shall be attached to the product according to figure below.

Husqvarna Automower® Connect
This device contains the module
FCC ID: XPY1CGM5NNN

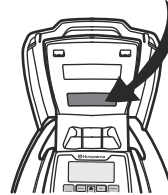

Models without a hatch: The supplied label shall be attached to the product according to figure below

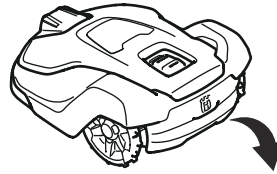

Husqvarna Automower® Connect
This device contains the module
FCC ID: XPY1CGM5NNN

Note: Changes or modifications made to this equipment not expressly approved by Husqvarna may void the FCC authorization to operate this equipment.

Note: This device complies with Part 15 of the FCC Rules [and with Industry Canada licence-exempt RSS standard(s)]. Operation is subject to the following two conditions: this device may not cause harmful interference, and this device must accept any interference received, including interference that may cause undesired operation.

Note: This equipment has been tested and found to comply with the limits for a Class B digital device, pursuant to part 15 of the FCC Rules. These limits are designed to provide reasonable protection against harmful interference in a residential installation. This equipment generates, uses and can radiate radio frequency energy and, if not installed and used in accordance with the instructions, may cause harmful interference to radio communications. However, there is no guarantee that interference will not occur in a particular installation. If this equipment does cause harmful interference to radio or television reception, which can be determined by turning the equipment off and on, the user is encouraged to try to correct the interference by one or more of the following measures:

- Reorient or relocate the receiving antenna.
- Increase the separation between the equipment and receiver.
- Connect the equipment into an outlet on a circuit different from that to which the receiver is connected.
- Consult the dealer or an experienced radio/TV technician for help.



WARNING: Cancer and Reproductive Harm - www.P65Warnings.ca.gov.



Husqvarna[®]

AUTOMOWER[®] is a trademark owned by Husqvarna AB.
Copyright[®] 2019 HUSQVARNA. All rights reserved.

www.husqvarna.com

Original instructions

1140564-95



2019-02-27

Free Manuals Download Website

<http://myh66.com>

<http://usermanuals.us>

<http://www.somanuals.com>

<http://www.4manuals.cc>

<http://www.manual-lib.com>

<http://www.404manual.com>

<http://www.luxmanual.com>

<http://aubethermostatmanual.com>

Golf course search by state

<http://golfingnear.com>

Email search by domain

<http://emailbydomain.com>

Auto manuals search

<http://auto.somanuals.com>

TV manuals search

<http://tv.somanuals.com>