

JBL

JBL® ON AIR

CONTROL® 2.4G AW (230V)

OWNER'S GUIDE



FEDERAL COMMUNICATIONS COMMISSION INTERFERENCE STATEMENT

This equipment has been tested and found to comply with the limits for a Class B digital device, pursuant to Part 15 of the FCC Rules. These limits are designed to provide reasonable protection against harmful interference in a residential installation.

This equipment generates, uses and can radiate radio frequency energy and, if not installed and used in accordance with the instructions, may cause harmful interference to radio communications. However, there is no guarantee that interference will not occur in a particular installation. If this equipment does cause harmful interference to radio or television reception, which can be determined by turning the equipment off and on, the user is encouraged to try to correct the interference by one of the following measures:

- Reorient or relocate the receiving antenna.
- Increase the separation between the equipment and receiver.
- Connect the equipment into an outlet on a circuit different from that to which the receiver is connected.
- Consult the dealer or an experienced radio/TV technician for help.

FCC Caution: To assure continued compliance, any changes or modifications not expressly approved by the party responsible for compliance could void the user's authority to operate this equipment. (Example - use only shielded interface cables when connecting to computer or peripheral devices).

FCC Radiation Exposure Statement

This equipment complies with FCC RF radiation exposure limits set forth for an uncontrolled environment. This equipment should be installed and operated with a minimum distance of 20 centimeters between the radiator and your body.

This device complies with Part 15 of the FCC Rules. Operation is subject to the following two conditions:

- (1) This device may not cause harmful interference, and
- (2) This device must accept any interference received, including interference that may cause undesired operation.

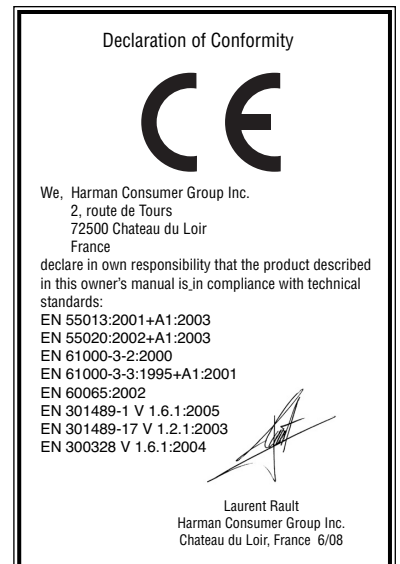
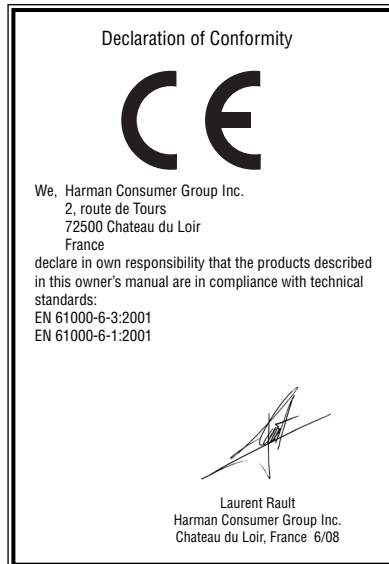

IMPORTANT SAFETY INSTRUCTIONS

CAUTION

RISK OF ELECTRIC SHOCK DO NOT OPEN

CAUTION: To reduce the risk of electric shock, do not remove cover (or back). No user-serviceable parts inside. Refer servicing to qualified service personnel.

CAUTION: To prevent electric shock, do not use this (polarized) plug with an extension cord, receptacle or other outlet unless the blades can be fully inserted to prevent blade exposure.



The lightning flash with arrowhead symbol, within an equilateral triangle, is intended to alert the user to the presence of uninsulated "dangerous voltage" within the product's enclosure that may be of sufficient magnitude to constitute a risk of electric shock to persons.



The exclamation point within an equilateral triangle is intended to alert the user to the presence of important operating and maintenance (servicing) instructions in the literature accompanying the appliance.

1. Read these instructions.
2. Keep these instructions.
3. Heed all warnings.
4. Follow all instructions.
5. Do not use this apparatus near water.
6. Clean only with a dry cloth.
7. Do not block any ventilation openings. Install in accordance with the manufacturer's instructions.
8. Do not install near any heat sources such as radiators, heat registers, stoves or other apparatus (including amplifiers) that produce heat.
9. Do not defeat the safety purpose of the polarized or grounding-type plug. A polarized plug has two blades with one wider than the other. A grounding-type plug has two blades and a third grounding prong. The wide blade or the third prong is provided for your safety. If the provided plug does not fit into your outlet, consult an electrician for replacement of the obsolete outlet.
10. Protect the power cord from being walked on or pinched, particularly at plugs, convenience receptacles and the point where they exit from the apparatus.
11. Only use attachments/accessories specified by the manufacturer.
12. Use only with the cart, stand, tripod, bracket or table specified by the manufacturer or sold with the apparatus. When a cart is used, use caution when moving the cart/apparatus combination to avoid injury from tip-over.



13. Unplug this apparatus during lightning storms or when unused for long periods of time.
14. Refer all servicing to qualified service personnel. Servicing is required when the apparatus has been damaged in any way, such as power-supply cord or plug is damaged, liquid has been spilled or objects have fallen into the apparatus, the apparatus has been exposed to rain or moisture, does not operate normally, or has been dropped.
15. Do not expose this apparatus to dripping or splashing and ensure that no objects filled with liquids, such as vases, are placed on the apparatus.
16. To completely disconnect this apparatus from the AC Mains, disconnect the power supply cord plug from the AC receptacle.
17. The mains plug of the power supply cord shall remain readily operable.
18. Do not expose batteries to excessive heat such as sunshine, fire or the like.

Figure A.
Example of Antenna Grounding as per
National Electrical Code ANSI/NFPA 70

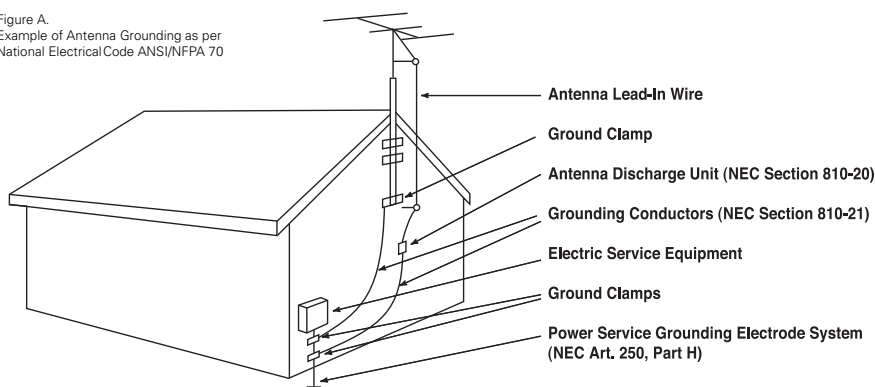

THANK YOU FOR CHOOSING JBL

For more than 60 years, JBL has been involved in every aspect of music and film recording and reproduction, from live performances to the recordings you play in your home, car or office.

We're confident that the JBL system you have chosen will provide every note of enjoyment that you expected – and that when you think about purchasing additional audio equipment for your home, car or office, you will once again choose JBL.

Please take a moment to register your product on our Web site at www.jbl.com. It enables us to keep you posted on our latest advance-ments, and helps us to better understand our customers and build products that meet their needs and expectations.

The JBL® On Air Control® 2.4G AW is an advanced wireless loudspeaker system that allows you to enjoy your favorite music in remote locations around your home, or to add surround speakers to your home theater system without running wires to the back of the room. To ensure trouble-free performance, please carefully read these instructions completely before connecting or using the system.

UNPACKING THE SYSTEM

Carefully unpack the system. If you suspect damage from transit, report it immediately to your dealer and/or delivery service. Keep the shipping carton and packing materials for future use. Open the package and verify the following contents:

Included

- 1 x Transmitter module
 - 1 x Power supply for transmitter
 - 1 x 230V 2-Prong AC power cord for transmitter power supply
 - 1 x Wall-mount bracket for transmitter with 2 x panhead M3 x 4 machine screws for attaching wall-mount bracket to transmitter
 - 4 x Small round self-adhesive feet – to be attached on transmitter's left side panel if transmitter is to be used vertically
- 1 x Active speaker/receiver (left-channel speaker)
 - 1 x Power supply for active speaker/receiver
 - 1 x Wall-mount holder for active speaker/receiver universal power supply
- 1 x Passive speaker (right-channel speaker)
- 2 x Terminal covers for active and passive speakers
- 6 x M3 x 8 self-tapping screws to attach terminal covers
- 2 x Wall-mount rotatable brackets for active and passive speakers (includes bar wrench and backup cords)
- 1 x Remote control
- 1 x Interconnect cable (1m/3.3 ft. RCA – RCA)
- 1 x Interconnect cable (1m/3.3 ft. RCA – 3,5mm (1/8-inch) mini plug)
- 10m/33 ft. x Speaker wire
- 1 x Owner's manual (multilanguage)

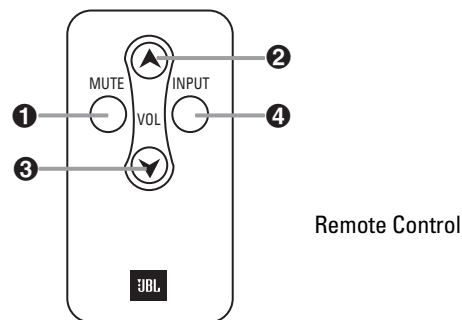

Remote Control

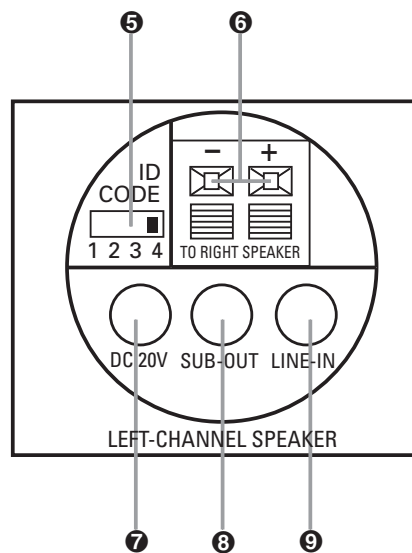

Left/Active Speaker (Rear)

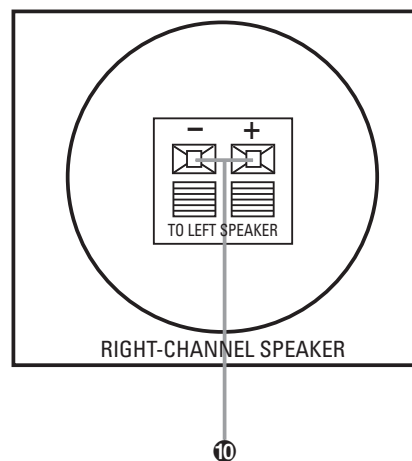

Right/Passive Speaker

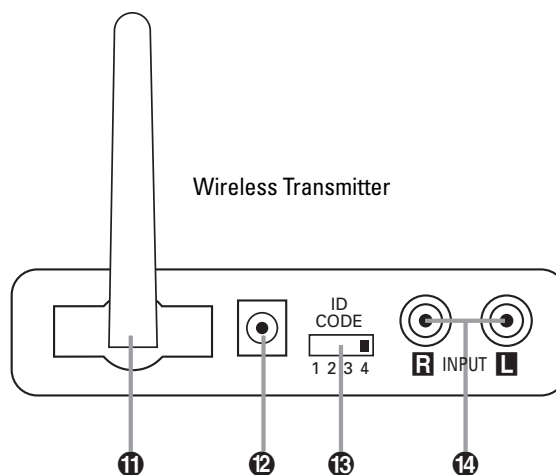

Wireless Transmitter

CONNECTIONS

Notes: For the sake of simplicity, throughout this manual we have used the term “source” when describing connections and operation. This would apply to any device such as an A/V receiver, audio component, computer or portable music player.

The JBL On Air may be connected to your source in several ways. First, determine how you would like to use the JBL On Air Control 2.4G AW; then follow the setup instructions for that application.

Application 1

Adding surround speakers to a home theater system. Continue reading the instructions for Application 1 below.

Application 2

Adding speakers to remote locations around your home.

Application 1

Adding surround speakers to a home theater system:

Determine if your source contains preamp outputs for rear/surround channels, usually indicated by RCA-type jacks on the back of the receiver labeled as “surround preout” (please refer to your source’s owner’s manual to confirm whether it includes the preamp outputs). If your receiver includes these outputs, follow the steps below. If not, connection is not recommended.

NOTE: Make sure power is turned off on all components.

Step 1.

Connect the interconnect cable (included) to the left and right surround/rear preamp outputs on the back of your source and the input on the transmitter module ⑭, as shown in Figure 1.

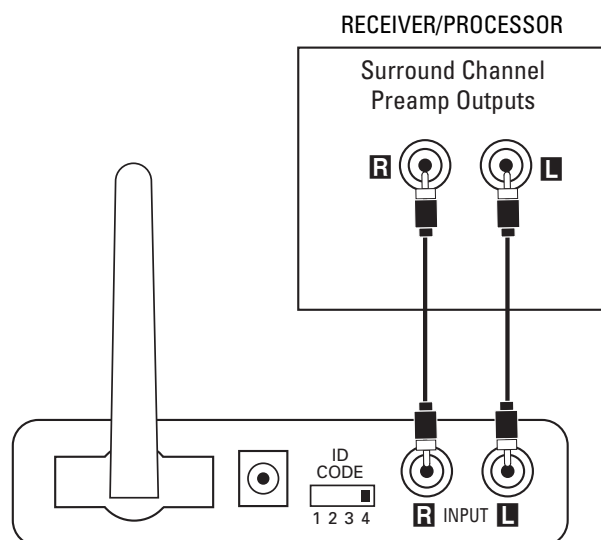

Figure 1.

Step 2.

Determine the location of the surround speakers.

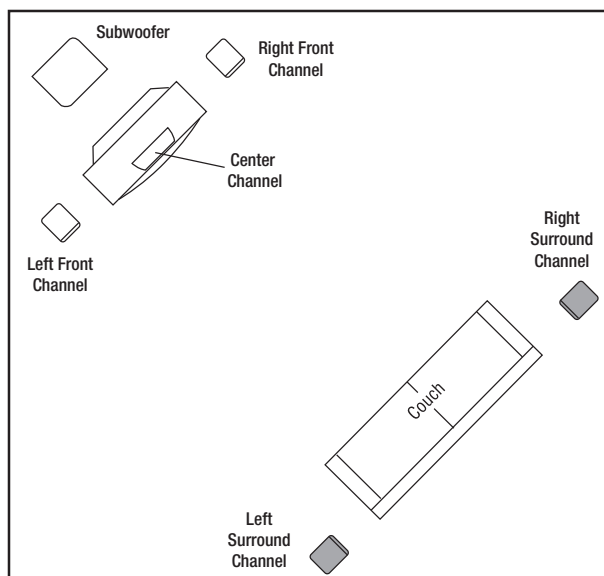
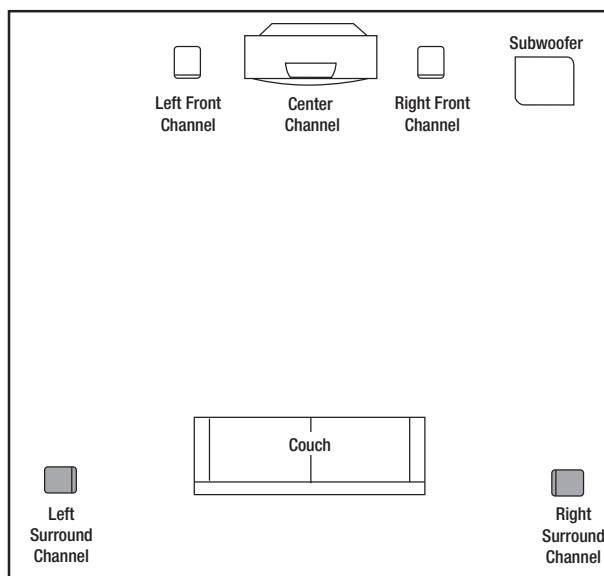

Figure 2. Place the active (left) speaker in the recommended location for the left surround speaker.

Step 3. Connect the speaker wire (included) to the push terminals on the active speaker ⑥ and the push terminals on the rear of the passive speaker ⑩.

See Figure 3. Please note that the speaker wire supplied features a polarity stripe to help distinguish its two conductors. Use this polarity stripe to ensure that you are connecting the positive (+) terminal on one speaker to the positive (+) terminal on the other, and the negative (–) to the negative (–). It does not matter whether you use the striped conductor for connecting the positive (+) terminals or the negative (–) terminals.

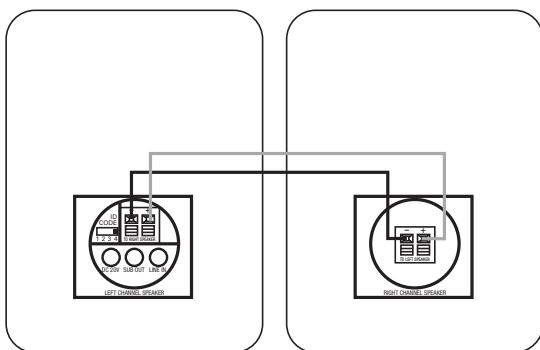

Figure 3.

Step 4. Plug the transmitter module ⑫ and active speaker ⑦ into the wall outlet, using the correct power supply and power cord. Make sure the transmitter’s antenna ⑪ is extended upwards.

Step 5. If necessary, configure your source to activate the preamp level outputs for the surround/rear channels (consult your source’s owner’s manual for specific instructions).

Make sure the ID code setting on the transmitter ⑬ is set to the same setting as that on the active speaker ⑤. See Page 8 of this manual for more information on ID codes. When connected properly, the top LED on the front of the active speaker should be green. When first plugged in, it will sometimes take several seconds for the Control 2.4G AW active speaker to initialize and “wake up.” Until then, the top LED will be in red. Once the top LED is green, the bottom LED should flash green until the transmitter and active speaker “lock in.” It will then also illuminate in solid green. This LED will light in orange if the local input on the active speaker is selected (see Page 8 under Local Input for more details).

Application 2

Adding speakers to remote locations around your home:

Audio sources that can be used in this application may be an A/V receiver or audio receiver, a portable audio player, or a computer featuring a sound card. First, determine whether your source contains RCA-type preamp outputs for the front/main channels or a 3,5mm (1/8-inch) stereo single-pin output. On an A/V or audio receiver, the preamp outputs are usually indicated by RCA-type jacks on the back of the receiver labeled as “pre-out” (please refer to your source’s owner’s manual to confirm whether it includes preamp outputs). If your source includes these RCA-type outputs, follow the steps in Connection Option A.

If your source features a 3,5 mm (1/8-inch) single-pin stereo jack, follow steps in Connection Option B. If your receiver does not feature either type of preamp outputs for the front/main channels, it cannot be used with Control 2.4G AW. Some computer sound cards feature more than one 3,5 mm(1/8-inch) single-pin jack. There is almost always one output that is called a speaker output. However, some sound cards feature a preamp output or line output in addition

to or instead of speaker outputs. If your computer does feature preamp or line outputs, we recommend that they be used instead of speaker outputs.

If you would like to connect the computer to the JBL On Air Control 2.4G AW using preamp outputs on your computer, follow the steps in Connection A.

Connection Option A

Connecting using the preamp outputs on your source:

Note: Make sure power is turned off on all components.

Step 1.

Connect the interconnect cable (included) to the left and right front/main preamp outputs or zone 2 outputs or REC outputs and the inputs on the transmitter module ⑭, as shown in Figure 4.

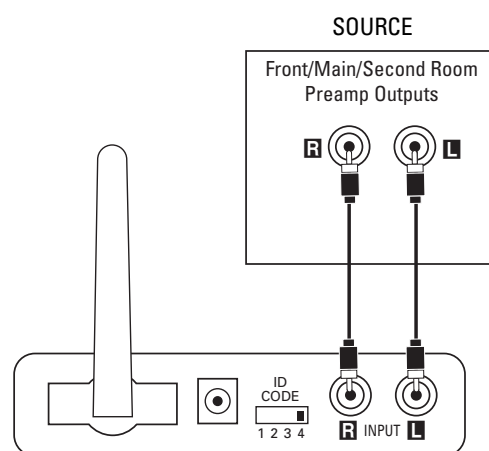

Figure 4.

Step 2. Place the active speaker in the desired location in your home near an AC outlet, as it needs to plug in to the wall.

Step 3. Connect the speaker wire (included) to the push terminals on the active speaker ⑥ and the push terminals on the rear of the passive speaker ⑩, as shown in Figure 3. Please note that the speaker wire supplied features a polarity stripe to help distinguish its two conductors. Use this polarity stripe to ensure that you are connecting the positive (+) terminal on one speaker to the positive (+) terminal on the other, and the negative (–) to the negative (–). It does not matter whether you use the striped conductor for connecting the positive (+) terminals or the negative (–) terminals.

Step 4. Plug the transmitter module ⑫ and active speaker ⑦ into the wall outlet. Make sure the transmitter’s antenna ⑪ is extended upward.

Step 5. Make sure the ID code setting on the transmitter ⑬ is set to the same setting as that on the active speaker ⑤. See Page 8 of this manual for more information on ID codes. If necessary, configure your receiver to activate the preamp level outputs for the main/front channels (consult your source’s owner’s manual for specific instructions).

When connected properly, the top LED on the front of the active speaker should be green. When first plugged in, it will sometimes take several seconds for the Control 2.4G AW active speaker to initialize and “wake up.” Until then, the top LED will be in red. Once the top LED is green, the bottom LED should flash green until the transmitter and active speaker “lock in.” It will then also light in solid green. This LED will light in orange if the local input on the active speaker is selected (see Page 8 under Local Input for more details).

Connection Option B

Connecting using the 3,5mm(1/8-inch) single-pin stereo jack on your source:

Note: Make sure power is turned off on all components.

Step 1. Connect the RCA – mini-jack cable (included) to the preamp out, line out or headphone 3,5mm (1/8-inch) output of your portable audio player and the inputs on the transmitter module ⑭, as shown in Figure 5.

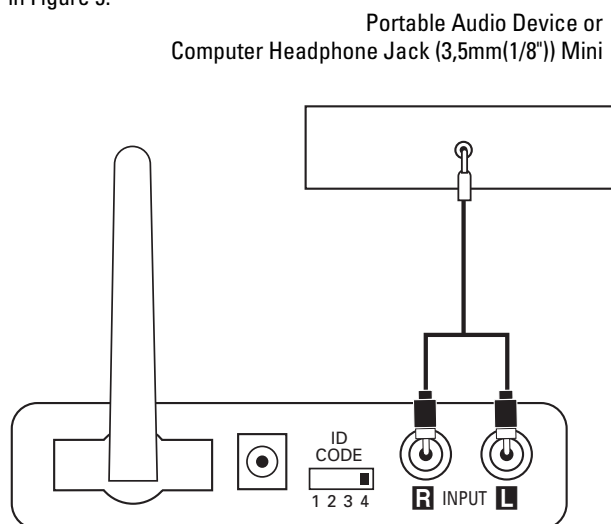

Figure 5.

Step 2. Place the active speaker in the desired location in your home near an AC outlet, as it needs to plug into the wall.

Step 3. Connect the speaker wire (included) to the push terminals on the active speaker ⑥ and the push terminals on the rear of the passive speaker ⑩, as shown in Figure 3. Please note that the speaker wire supplied features a polarity stripe to help distinguish its two conductors. Use this polarity stripe to ensure that you are connecting the positive (+) terminal on one speaker to the positive (+) terminal on the other, and the negative (–) to the negative (–). It does not matter whether you use the striped conductor for connecting the positive (+) terminals or the negative (–) terminals.

Step 4. Plug the transmitter module ⑫ and active speaker ⑦ into the wall outlet, using the correct power supply and power cord. Make sure the transmitter’s antenna ⑪ is extended upward.

Make sure the ID code setting on the transmitter ⑬ is set to the same setting as that on the active speaker ⑤. See Page 8 of this manual for more information on ID codes. When connected properly, the top LED on the front of the active speaker should be green. When first plugged in, it will sometimes take several seconds for the Control 2.4G AW active speaker to initialize and “wake up.” Until then the top LED will be in red. Once the top LED is green, the bottom LED should flash green until the transmitter and active speaker “lock in.” It will then also light in solid green. This LED will light in orange if the local input on the active speaker is selected (see Page 8 under Local Input for more details).

If you are installing the speakers outdoors, please attach the provided terminal cover to each speaker, using three M3 x 8 self-tapping screws provided.

OPERATION

Adjusting the Volume

Application 1

Adding surround speakers to a home theater system:

In this application, the output level of your Control 2.4G AW active speakers will not only be dependent on the volume setting of your A/V source, it will also need to be properly adjusted after installation and before use in order to be able to work correctly with the other speakers in your multichannel surround system. To adjust the output level, turn you A/V source on, set your A/V source's volume control about a third of the way up, and activate the speaker-level-adjustment test tone. Make sure that the Control 2.4G AW transmitter and speakers are on, both of its speakers are connected, and there is RF lock (i.e., lower LED on active speaker is solid green). Using the Control 2.4G AW remote control ② and ③ adjust the volume level of Control 2.4G AW until its output level is balanced with the rest of the speakers in your surround system. From this point on, you will not be using the remote control of your Control 2.4G AW for volume settings. You will be increasing and decreasing the output level for the entire surround sound system using your A/V source's volume control. Please note that Control 2.4G AW will retain its volume setting when it is in standby, so there is no need to set its volume level every time the system is turned on.

Application 2

Adding speakers to remote locations around your home:

Depending on the type of connection and the specific source that you are using, the volume setting on your receiver may affect the sound output level of your Control 2.4G AW. To check whether the output from your source is volume-dependent, turn the volume level on your receiver to approximately half-way. Turn on your Control 2.4G AW transmitter and active speaker. Once the lower LED on the active speaker lights in solid green, indicating that RF lock has been achieved, verify that there is sound output from the active speaker. Then increase and decrease the volume control on your receiver and observe whether this affects the sound output from your active speakers. If it does not, then the volume control on your source unit can be set at any position that you may desire as it does not affect the performance of Control 2.4G AW. If changing the volume setting on your source does affect the output from Control 2.4G AW, then you will need to always keep your source's volume control at about half-way up with audio receivers or A/V receivers, at about three-quarters of the way up when using a computer, and at maximum if using a portable audio device. From this point on, you will use the remote control included with the JBL On Air Control 2.4G AW wireless speaker system to adjust the volume ② and ③.

Local Input

The JBL On Air Control 2.4G AW wireless speaker system also includes a local input ⑨ on the rear of the active speaker. This input allows you to hook up a portable audio player directly to the speaker wherever you may happen to be. For example, you could have the system connected to your receiver as described in Application 2, listening to a local FM station and then hook up your portable music player to the local input and switch between the two different sources.

To connect portable audio player to the active speaker, simply connect the preamp out, line out or headphone jack to the line-in ⑨ on the rear of the active speaker using a 3,5mm (1/8-inch) mini-jack – 3,5 mm (1/8-inch) mini-jack cable (not included).

To switch between the two sources, push the input button ④ on the remote control.

ID Code

In the unlikely event that you experience interference when operating the system, or if you have more than one set of Control 2.4G AW transmitters and receivers in operation, you may change the channel in which the system operates. On the transmitter module and the active speaker, there is a four-position "ID Code" selector. Simply set the selectors to one of the other positions. The transmitter and active speaker must be set to the same position in order for the system to function correctly. You can also set up a maximum of two pairs of speakers to be receiving from the same transmitter by setting the channel selector on the transmitter and both of the active speakers to the same channel. Please note that the two active speakers need to be at least 10m (33 feet) apart, or reception and operating range in one or both units may be degraded.

Auto On/Standby

The JBL Control 2.4G AW will automatically enter the Standby mode after approximately 10 minutes when no signal is detected from your system. The JBL Control 2.4G AW will then power ON instantly when a signal is detected. When Mute ① is engaged, auto turn-off is deactivated.

Indicator Light Information

	Power Indicator LED (Top)	Input LED (Bottom)
Green	System is on	Transmitter and speaker are communicating (RF lock)
Blinking Green	Receiving IR command from remote control	Transmitter and speaker are not communicating (no RF lock)
Red	Standby (no signal being received)	
Orange		Local input is selected

Subwoofer Output

The JBL On Air Control 2.4G AW wireless speaker system includes a subwoofer output ⑥ on the rear of the active speaker. This output allows you to feed the low-frequency sounds to a separate powered subwoofer. A powered subwoofer will deliver deeper bass response than is possible with speakers alone.

To connect a powered subwoofer to the active speaker, simply connect the subout ⑥ on the active speaker to the line-in on the rear of the powered subwoofer using a 3,5mm (1/8-inch) stereo mini-jack – dual-RCA cable (not included*). Please note that this output is full range and not filtered or low-passed. Make sure that your powered subwoofer features a low-pass crossover network and that this crossover is indeed selected. Do not use the LFE input on a powered subwoofer as it is not filtered and you will be hearing a lot of undesirable higher frequency information from your subwoofer. * Only one stereo mini-jack/dual RCA cable is included with the system. If you are following Application 2, Connection Option B, you will need to purchase this cable.

A Word About Wireless Products

The JBL On Air Control 2.4G AW wireless speaker system utilizes advanced wireless transceivers operating in the 2.4GHz frequency band. This is the same frequency band that is used for wireless home networks and high-quality cordless phones. It also allows for the transmission of high-performance, full-spectrum sound to remote locations, wirelessly.

Like all wireless devices, the JBL On Air Control 2.4G AW wireless speaker's operating range may vary depending upon variables such as building construction methods and materials, atmospheric conditions and other sources of interference. Please consult your JBL dealer or distributor or visit us at www.jbl.com for further information or assistance.

WALL AND STAND PLACEMENT

Adjustable wall brackets are included for the two speakers and transmitter module. The included brackets are for wall-mounting only. It is not to be used for ceiling mounting. Ceiling mounting of the Control 2.4G AW transmitter and/or speakers is not recommended, regardless of bracket used.

Wall-Mounting the Speakers Using Wall Brackets Provided

Important safety note: Proper selection of mounting hardware not included herein, and proper assembly and installation of brackets, including, but not limited to, selection of appropriate weight-bearing support and bracket use with the specified speaker only is the exclusive responsibility of the customer. Manufacturer disclaims any liability for the selection of mounting hardware and/or bracket installation.

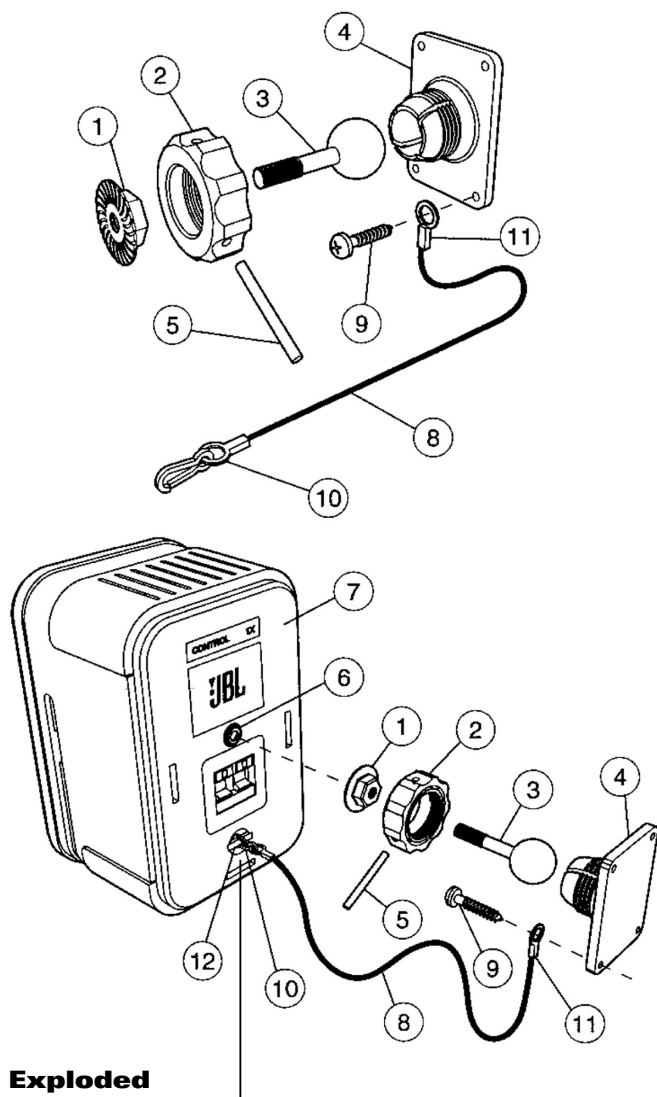

Exploded

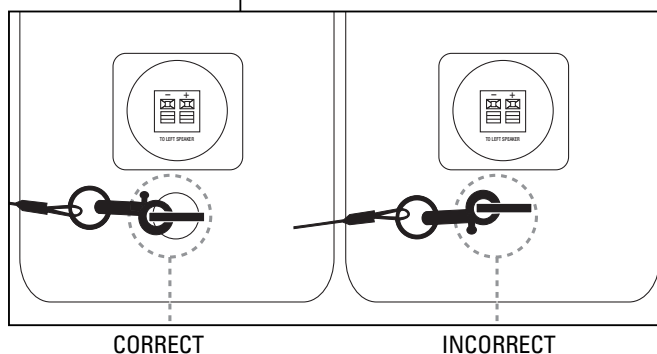

- A. Loosen and remove the molded nut (2) by turning it counter clockwise. Use the supplied metal bar (5) if necessary by inserting it in one of the holes on the molded nut (2).
- B. Pull the ball/shaft (3) out of the wall bracket (4).
- C. Slide on the molded nut (2) onto the ball/shaft (3) with threaded opening facing the ball, and thread on the metal nut (1) all the way onto the ball/shaft (3), with the nut's (1) "knurled" surface facing away from the ball.
- D. Screw on the ball/shaft (3) into the threaded 1/4"-20 insert on the back of the speaker cabinet (6) until it is fully seated against the bottom of the insert. Back out the ball-shaft assembly 1/2 of a turn and tighten the nut against the speaker. If the ball and shaft assembly is not backed out before tightening the nut, performing Step G below may dislodge the threaded insert in the speaker housing and permanently damage the speaker.
- E. Tighten the "knurled" nut (1) using a crescent wrench until it is firmly seated against the back of the speaker and has fully locked the ball/shaft (3) and the speaker cabinet together. Please note that once this nut is tightened, it may embed some marks on the back of the speaker where the attachment is made. However, these marks will be covered by the nut (1).
- F. The back-up cord (8) is provided as an additional measure to prevent the fall of the speaker in case the speaker becomes detached from the wall bracket.

One of the two lower screws (9) that attach the wall bracket (4) to the wall will need to go through the eyelet (11) at the end of the cord before going through the wall bracket hole. Mount the wall bracket (4) onto a wood stud on the wall, using #10, minimum 1-inch-long, panhead wood screws. Make sure that all 4 screws are driven into the stud, not drywall. **If the bracket needs to be mounted on drywall, the use of properly selected and installed wall-anchors and screws is essential.** Make sure that the screw head is at least 9mm (0.36 or approximately 3/8 of an inch) or larger in diameter so that it can properly hold the backup cord eyelet (11).

- G. Holding the speaker cabinet (7) with both hands, reinsert the ball portion of the ball/shaft (3) into the wall bracket (4).
- H. Hand-tighten the molded nut (2) while positioning the speaker for the intended orientation.
- I. Once the orientation of the speaker is finalized, use the metal bar (5) in one of the holes on the molded nut (2) and tighten securely.
- J. Securely attach the other end (10) of the backup cord (8) to the Control 2.4G, by engaging it through the bar (12) on the back speaker.

Also included with the system is a wall-mount holder for the active speaker's power supply. If desired, you may attach this holder to the wall and insert the speaker's power supply.

Please note that while the Control 2.4G AW is an all-weather outdoor loud-speaker, it is not waterproof. Neither the speakers nor power supply should be submerged or directly exposed to water, ice, snow or sustained moisture. Do not install the transmitter module outdoors.

Wall-Mounting the Speakers Using Third-Party Wall Brackets

Each JBL On Air Control 2.4G AW wireless speaker contains a 1/4"-20 threaded insert on the back to facilitate the use of third-party wall brackets. Please consult your JBL dealer or distributor for recommendations.

NOTES: Customer is responsible for proper selection and installation of appropriate third-party wall brackets.

The threaded insert on the bottom of the speaker is not intended for wall-bracket attachment. It is provided for use with an appropriate third-party floorstand.

Stand-Mounting the Speakers

Each JBL On Air Control 2.4G AW wireless speaker contains a 1/4"-20 threaded insert on the bottom to facilitate the use of third-party floor stands. Please consult your JBL dealer for recommendations.

NOTE: Customer is responsible for proper selection and installation of appropriate third-party wall brackets and/or floor stands.

Wall-Mounting the Transmitter Module

Step 1. Insert the two M3 x 4 machine screws through the wall bracket and into the rear of the transmitter module, as shown in Figure 6.

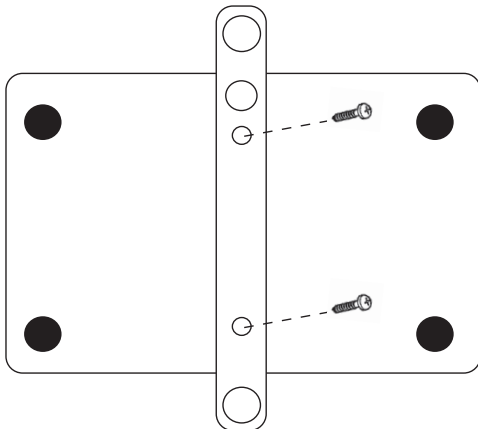

Figure 6.

Step 2. Attach the transmitter module with wall bracket to the wall using suitable hardware, and wall anchors if necessary.

Remote Control Battery Replacement

CAUTION:

When replacing the lithium battery in the remote, make sure that the replacement battery is inserted in correct polarity. Place the battery so that its positive (+) side faces up with the tray held so that the surface with the dot is facing up.

Remote-control-battery installation

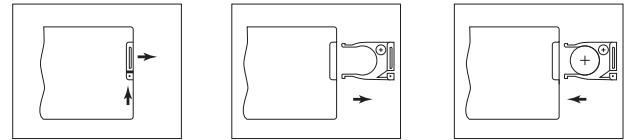

Push small tab toward battery slot.

Pull battery drawer out.

Insert new battery with "+" side up, and slide battery drawer back into remote.

CAUTION: DANGER OF EXPLOSION IF BATTERY IS INCORRECTLY REPLACED.

REPLACE ONLY WITH THE SAME OR EQUIVALENT TYPE (CR2032).

WARNING: DO NOT EXPOSE BATTERIES TO EXCESSIVE HEAT SUCH AS DIRECT SUNLIGHT, FIRE OR THE LIKE.

Dispose of dead batteries in accordance with local regulations.

MAINTENANCE AND SERVICE

The speaker and transmitter enclosures may be cleaned using a soft cloth to remove fingerprints or to wipe off dust.

All wiring connections should be inspected and cleaned or remade periodically. The frequency of maintenance depends on the metals involved in the connections, atmospheric conditions and other factors, but once per year is the minimum.

In the event that your system ever needs service, contact your local JBL dealer or distributor, or visit www.jbl.com for a service center near you.

SPECIFICATIONS

Frequency Range ($\pm 3\text{dB}$):	80Hz – 20kHz
Amplifier Output:	15 Watts per channel
Low-Frequency Driver:	100mm (4") Magnetically shielded
High-Frequency Driver:	12mm (1/2") Titanium-laminate, magnetically shielded
Operating Range:	Up to 21m (70') depending upon conditions
RF Operating Frequency:	2.4GHz

Dimensions

Speaker (H x W x D):	229mm x 156mm x 140mm (9" x 6-1/8" x 5-1/2")
Transmitter (H x W x D):	29mm x 124mm x 98mm (1-1/8" x 4-7/8" x 3-7/8")
	95mm (3-3/4") High with antenna extended

Weight

Active Speaker:	2.1kg (4.6 lb)
Passive Speaker:	2.0kg (4.3 lb)
Transmitter:	0.2kg (0.5 lb)

Features, specifications and appearance are subject to change without notice.

JBL and Control Series are trademarks of Harman International Industries, Incorporated, registered in the United States and/or other countries. Pro Sound Comes Home are trademark of Harman International Industries, Incorporated.

	PRO SOUND COMES HOME™
Harman Consumer Group, Inc., 250 Crossways Park Drive, Woodbury, NY 11797, USA 8500 Balboa Boulevard, Northridge, CA 91329, USA 2, route de Tours, 72500 Château du Loir, France 516.255.4JBL (4525) (USA only) www.jbl.com © 2008 Harman International Industries, Incorporated. All rights reserved. Part No. 406-000-05942-E	
H A Harman International® Company	

Free Manuals Download Website

<http://myh66.com>

<http://usermanuals.us>

<http://www.somanuals.com>

<http://www.4manuals.cc>

<http://www.manual-lib.com>

<http://www.404manual.com>

<http://www.luxmanual.com>

<http://aubethermostatmanual.com>

Golf course search by state

<http://golfingnear.com>

Email search by domain

<http://emailbydomain.com>

Auto manuals search

<http://auto.somanuals.com>

TV manuals search

<http://tv.somanuals.com>