



HEAVY DUTY

JHD3630BT

AM/FM/RBDS/WB/CD/USB/AUX-IN/BT/iPod Ready/SiriusXM Ready Heavy Duty Radio

Installation and Operation Manual

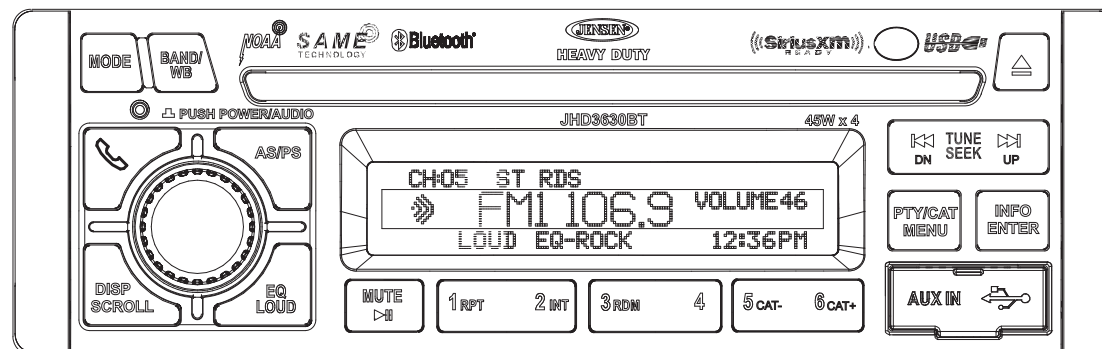

iPhone, iPod, iPod classic, iPod nano, iPod shuffle, and iPod touch are trademarks of Apple Inc., registered in the U.S. and other countries.

CONTENTS

Introduction	1
Safety Information	2
Installation	3
Wiring	4
Basic Operation	5
Tuner Operation	8
CD/MP3/USB Playback	10
Satellite Radio Operation	11
iPod Operation	14
Bluetooth Operation	15
Care and Maintenance	17
Troubleshooting	17
Specifications	18

Copyrights and Trademarks

“Made for iPod” and “Made for iPhone” mean that an electronic accessory has been designed to connect specifically to iPod or iPhone respectively, and has been certified by the developer to meet Apple performance standards. Apple is not responsible for the operation of this device or its compliance with safety and regulatory standards. Please note that the use of this accessory with iPod or iPhone may affect wireless performance.

Sirius, XM and all related marks and logos are trademarks of Sirius XM Radio Inc. and its subsidiaries. Visit www.siriusxm.com/xmlineup for updates. All programming/channel lineup/ XM service subject to change or preemption. All other marks and logos are the property of their respective owners. All rights reserved.

INTRODUCTION

System Features

Features of the Jensen JHD3630BT mobile audio system include:

- Full Dot Matrix LCD
- AM/FM US/EURO Tuner with 30 Presets (12 AM, 18 FM)
- RBDS (Radio Broadcast Data Service) with PTY Search
- SiriusXM Radio Ready
- Single In-Dash CD Player with MP3/WMA Playback Capability
- USB Playback of MP3 and WMA files
- CD ESP (Electronic Skip Protection) 30 Sec.
- iPod Ready (USB Interface)
- Weatherband Tuner with SAME Technology
- Mute
- Bluetooth (Supports A2DP, AVRCP and HFP)
- Pre-set Equalizer - 5 settings (User, Flat, Pop, Classical, Rock)
- Electronic Bass, Treble, Balance and Fader Controls
- Output Power 45W x 4
- Clock 12/24 Hour Selectable
- Public Announcement (PA) Feature with Optional Microphone (sold separately)
- IR Wireless Remote Control Ready (sold separately)
- 2-Channel Pre-amp Line Level Outputs
- 2-Wire Power with Non-Volatile Memory and Clock/Time Support
- Auxiliary Audio Input (Front 3.5mm Stereo Jack, Rear RCA)

Content List

- Jensen Heavy Duty Radio
- Hardware Kit
- Installation Manual
- Quick reference Guide

HARDWARE KIT CONTENTS

FLANGE NUTS



MOUNTING STRAP

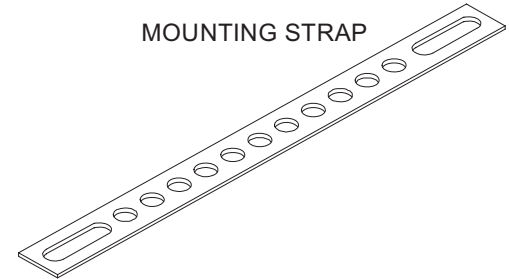

DIN SLEEVE
REMOVAL TOOL

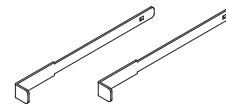

MOUNTING SCREW



MOUNTING BUSHING



SAFETY INFORMATION

When Driving

Keep the volume level low enough to be aware of the road and traffic conditions.

When Washing Your Vehicle

Do not expose the product to water or excessive moisture. Moisture can cause electrical shorts, fire or other damage.

When Parked

Parking in direct sunlight can produce very high temperatures inside your vehicle. Give the interior a chance to cool down before starting playback.

Use the Proper Power Supply

This product is designed to operate with a 12 volt DC negative ground battery system.

Protect the Disc Mechanism

Avoid inserting any foreign objects into the disc slot. Misuse may cause malfunction or permanent damage due to the precise mechanism of this unit.

CAUTION:

THIS MOBILE CD PLAYER IS A CLASS I LASER PRODUCT. THIS UNIT USES A VISIBLE/ INVISIBLE LASER BEAM WHICH COULD CAUSE HAZARDOUS RADIATION IF EXPOSED DIRECTLY. BE SURE TO OPERATE THE MOBILE CD PLAYER AS INSTRUCTED.

USE OF CONTROLS OR ADJUSTMENTS OR PERFORMANCE OR PROCEDURES OTHER THAN THOSE SPECIFIED HEREIN MAY RESULT IN HAZARDOUS RADIATION EXPOSURE.

DO NOT OPEN COVERS AND DO NOT REPAIR BY YOURSELF. PLEASE REFER SERVICING TO A QUALIFIED TECHNICIAN.

WARNING:

- TO REDUCE THE RISK OF FIRE OR ELECTRIC SHOCK, DO NOT EXPOSE THIS EQUIPMENT TO RAIN OR MOISTURE.
- TO REDUCE THE RISK OF FIRE OR ELECTRIC SHOCK AND ANNOYING INTERFERENCE, USE ONLY THE RECOMMENDED ACCESSORIES.

DISC NOTES

Depending on the recording status, conditions of the disc, and the equipment used for recording, some CD-Rs/CD-RWs may not play on this unit. For more reliable playback, please adhere to the following recommendations:

- Use CD-RWs with speed 1x to 4x and write with speed 1x to 2x.
- Use CD-Rs with speed 1x to 8x and write with speed 1x to 2x.
- Do not play a CD-RW which has been written more than 5 times.

Compatible Disc Types

Table 1: General Disc Information

Disc Type	Logo	Diameter/ Playable Sides	Playback Time
Audio CD		12 cm single side	74 minutes

NOTE: CD-R and CD-RW discs will not play unless the recording session is closed and the CD is finalized.

Disc Maintenance

- A dirty or defective disc may cause sound dropouts while playing. Before playing, wipe the disc using a clean cloth, working from the center hole towards the outside edge. Never use benzene, thinners, cleaning fluids, anti-static liquids or any other solvent.

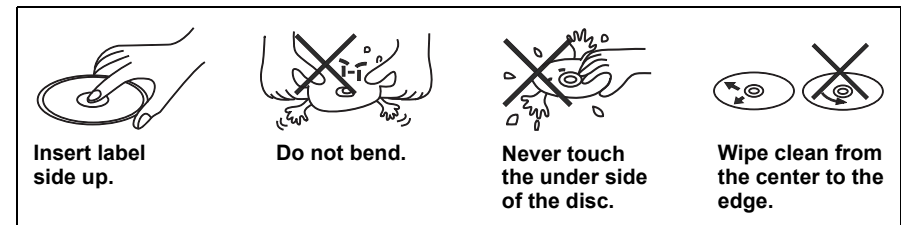

- Be sure to use only round CDs for this unit and do not use any special shape CDs. Use of special shape CDs may cause the unit to malfunction.
- Do not stick paper or tape on the disc. Do not use CDs with labels or stickers attached or that have sticky residue from removed stickers.
- Do not expose discs to direct sunlight or heat sources.

NOTE: A disc may become scratched (although not enough to make it unusable) depending on how you handle it and other conditions in the usage environment. These scratches are not an indication of a problem with the player.

INSTALLATION

This unit is designed for installation in vehicle cabs with an existing 1-DIN radio opening. In many cases, a special installation kit will be required to mount the radio to the dashboard. See the dealer where the radio was purchased for kit availability. Always check the kit application before purchasing to make sure the kit works with your vehicle.

Before You Begin

- 1. Disconnect Battery**
Before you begin, always disconnect the battery negative terminal.
- 2. Remove Transport Screws**

Important Notes

- Before final installation, test the wiring connections to make sure the unit is connected properly and the system works.
- Use only the parts included with the unit to ensure proper installation. The use of unauthorized parts can cause malfunctions.
- Consult with your nearest dealer if installation requires the drilling of holes or other modifications to your vehicle.
- Install the unit where it does not interfere with driving and cannot injure passengers during a sudden or emergency stop.
- If the installation angle exceeds 30° from horizontal, the unit might not give optimum performance.
- Avoid installing the unit where it will be subject to high temperatures from direct sunlight, hot air, or from a heater, or subject to excessive dust, dirt or vibration.

DIN Front Mount

1. Slide the mounting sleeve off of the chassis if it has not already been removed. If it is locked into position, use the removal keys (supplied) to disengage it. The removal keys are depicted in "Removing the Unit" on page 3.
2. Check the dashboard opening size by sliding the mounting sleeve into it. If the opening is not large enough, carefully cut or file as necessary until the sleeve easily slides into the opening. Do not force the sleeve into the opening or cause it to bend or bow. Check that there will be sufficient space behind the dashboard for the radio chassis.
3. Locate the series of bend tabs along the top, bottom and sides of the mounting sleeve. With the sleeve fully inserted into the dashboard opening, bend as many of the tabs outward as necessary to firmly secure the sleeve to the dashboard.
4. Place the radio in front of the dashboard opening so the wiring can be brought through the mounting sleeve.
5. Follow the wiring diagram carefully and make certain all connections are secure and insulated with crimp connectors or electrical tape to ensure proper operation.
6. After completing the wiring connections, turn the unit on to confirm operation (vehicle accessory switch must be on). If the unit does not operate, recheck all wiring until the

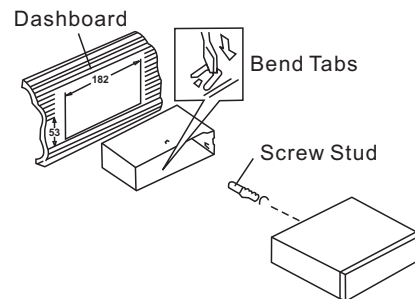

- problem is corrected. Once proper operation is achieved, turn the accessory switch off and proceed with final mounting of the chassis.
7. Carefully slide the radio into the mounting sleeve making sure it is right-side-up until it is fully seated and the spring clips lock it into place.
 8. Attach one end of the perforated support strap (supplied) to the screw stud on the rear of the chassis using the hex nut provided. Fasten the other end of the perforated strap to a secure part of the dashboard either above or below the radio using the screw and plain washer provided. Bend the strap, as necessary, to position it. Some vehicle installations provide cavity for rear support. In these applications, place the rubber bushing over the screw stud and insert the radio.

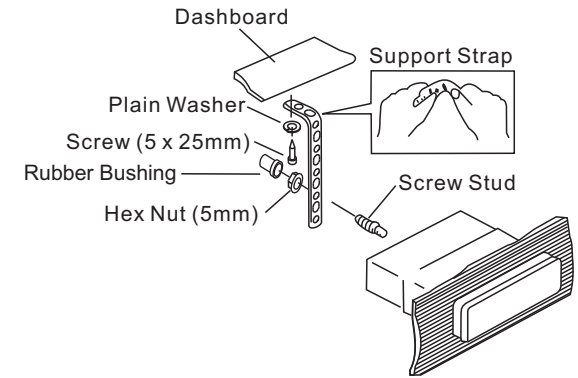

CAUTION: The perforated rear support strap or rear rubber mounting bushing must be used in the installation of the radio. Installation without either may result in damage to the radio or the mounting surface and void the manufacturer's warranty.

9. Test radio operation by referring to the operating instructions for the unit.

Removing the Unit

To remove the radio after installation, remove the plastic end caps, insert the removal keys straight back until they click, and then pull the radio out. If removal keys are inserted at an angle, they will not lock properly to release the unit.

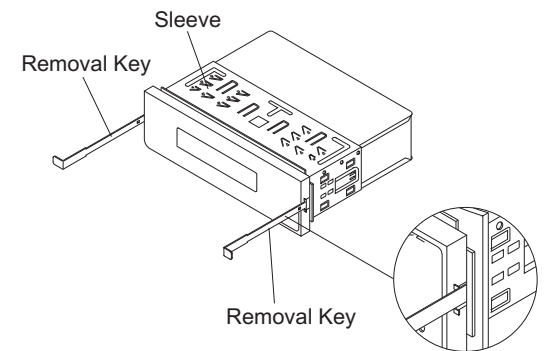

Reconnect Battery

When wiring is complete, reconnect the battery negative terminal.

WIRING

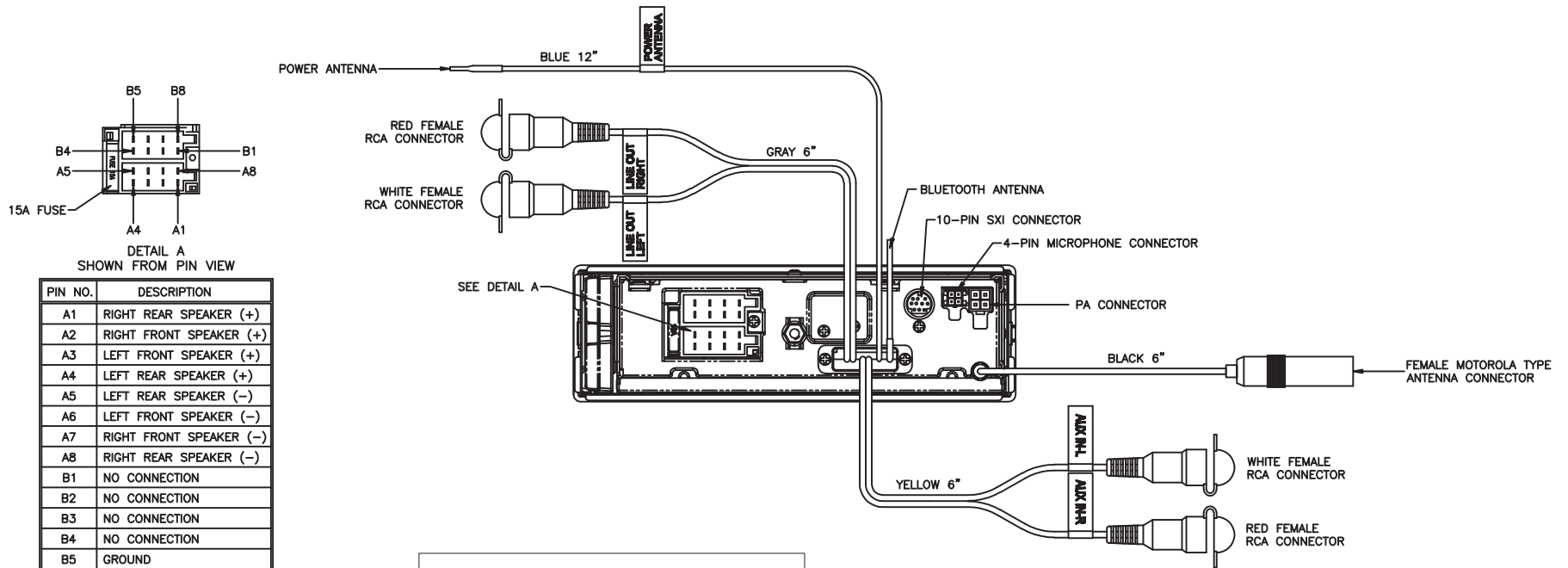

WARNING!
Do not connect the +12VDC ACC switched wire to the battery. This wire **MUST** be connected to the Accessory/Ignition wire or a +12 volts switched power source.

BASIC OPERATION

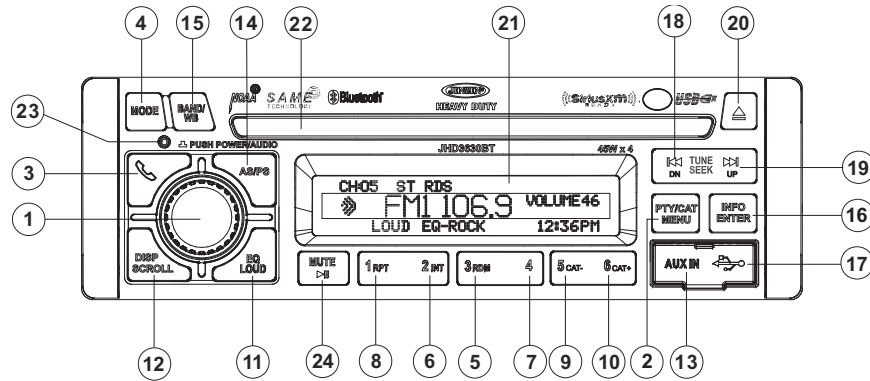

Power On/Off/Audio

Press the rotary encoder **POWER** button (1) to turn the unit on or *press and hold* to turn off. The unit will resume at the last mode selected (Tuner, Auxiliary, etc.).

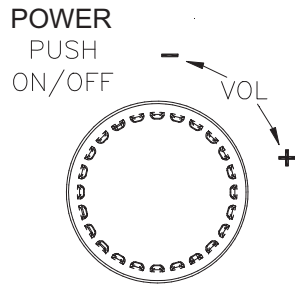

Volume Control

To increase the volume, turn the rotary encoder (1) to the right. To decrease the volume, turn the rotary encoder to the left. While adjusting the volume, the LCD displays a bar graph and numerical representation of the level.



The maximum volume setting is 40.

Mute

Press the **MUTE** button (24) to mute the audio output. Press **MUTE** again to restore the audio output to the previous level.

Mode

Press the **MODE** button (4) to select a different mode of operation, as indicated on the display panel. Available modes include the following: Tuner (AM/FM) > SXM (SiriusXM) > iPod/USB > CD > Auxiliary > BT Audio. Tuner is the default source when a prior source is no longer available.

NOTE: CD, iPod, USB or SiriusXM (SXM) mode will be skipped if the module is not installed.

NOTE: SiriusXM (SXM) mode will be skipped when the Region menu option is set to "EURO".

Reset

The reset button should be activated for the following reasons:

- initial installation of the unit when all wiring is completed
- function buttons do not operate
- error symbol on the display

Use a ball point pen or thin metal object to press the **RESET** button (23). This may be necessary should the unit display an error code.

Audio Menu

Press the **POWER/AUDIO** button (1) to access the audio menu. You can navigate through the audio menu items by pressing the **POWER/AUDIO** button repeatedly. Once the desired menu item appears on the display, adjust that option by turning the rotary encoder (1) within 5 seconds. The unit will automatically exit the audio menu after five seconds of inactivity. The following menu items can be adjusted.

Bass Level

Use the rotary encoder (1) to adjust the Bass level range from "-6" to "+6".

Treble Level

Use the rotary encoder (1) to adjust the Treble level range from "-6" to "+6".

Balance

Adjusting Balance controls the relative level between the left and right speakers in each pair. Use the rotary encoder (1) to adjust the Balance between the left and right speakers from "Left 12" to "Right 12".

Fader

Adjusting Fade controls the relative level between the front and rear speaker pairs. Use the rotary encoder (1) to adjust the Fader between the rear and front speakers from "Rear 12" to "Front 12".

System Menu

1. Press and hold the **PTY/CAT/MENU** button (2) for more than 2 seconds to enter the system menu. The first menu item, "Key Beep", will appear on the display.
2. Press the **TUNE/SEEK** |<< / >>| (18, 19) button repeatedly to navigate the system menu.
3. Press the **INFO/ENTER** button (16) to select the desired item.
4. Press the **INFO/ENTER** button again to adjust the selected menu item.

The following items can be adjusted:

- Key Beep (On / Off): Turn the audible beep On/Off (heard when functions/buttons are selected).
- LCD Backlight (1-10): Adjust LCD brightness.
- LCD Contrast (1-10): Adjust LCD contrast.
- Tuning Region (USA / EURO): Set frequency spacing for various regions.
- Power-Off Clock (Off, 1-10)
- Clock Format (12Hour / 24Hour): Select 12 or 24 hour display mode.
- Set Clock (HH : MM):
 - Press the **INFO/ENTER** button (16) to view the clock set screen.
 - Press the **INFO/ENTER** button to move to the next digit.
 - Press the **TUNE/SEEK** |<< / >>| (18, 19) buttons to adjust the selected digit.
- Rear Aux Enable (On / Off): Turn on to allow the use of auxiliary audio input at the rear of the radio chassis.
- Preset-Only Tuning (On / Off):
- SiriusXM Settings Menu (only appears when SiriusXM tuner is connected and in SiriusXM mode)
 - Clock Autoset (On / Off)
 - Time Zone1 (Atlantic / Eastern / Central / Mountain / Pacific / Alaska)
 - Daylight Saving Time (Yes / No)
 - Set Lock Code: _ _ _ _ _
 - Locked Channels: List of Channels (Locked / Unlocked)
 - SXi Firmware Version
- Weather Alert Configuration
 - Min Alert Level (All / None / Warnings / Watches)
 - Auto-On Enable (Yes / No): Select "Enabled" to turn on the radio when NOAA alerts are issued. This function only works when the +12V switched is on.
 - Alert Volume (Select Volume Level 0-40)
 - Clear SAME Codes <ENTER>
 - SAME Code 1: _ _ _ _ _
 - SAME Code 2: _ _ _ _ _
 - SAME Code 3: _ _ _ _ _
 - SAME Code 4: _ _ _ _ _
 - SAME Code 5: _ _ _ _ _
 - SAME Code 6: _ _ _ _ _
 - SAME Code 7: _ _ _ _ _
- Battery Alarm (Off / On)
- Battery Auto-Off (Off / On)
- Bluetooth Setup
 - BT: ON/OFF
 - BT HFP Volume: (Select Volume Level 0-40)
 - BT Device List <Enter>
 - BT Pair <Enter to enable>

- BT Auto Answer: ON/OFF
- Reset System Defaults <ENTER>: Press the **INFO/ENTER** button (16) to return the EEPROM to factory default set up values.

Equalizer

Press the **EQ/LOUD** button (11) to choose one of the following pre-defined bass and treble curves: USER > FLAT > CLASSICAL > ROCK > POP.

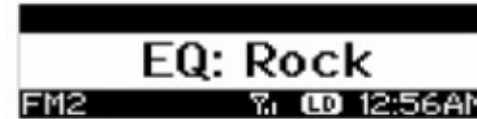

Loudness

Press and hold the **EQ/LOUD** button (11) to toggle loudness on/off. When listening to music at low volumes, this feature will boost the bass and treble ranges to compensate for the characteristics of human hearing.

Auxiliary Input

To access an auxiliary device:

1. Connect the portable audio player to either the AUX IN on the front panel (17) or at the rear of the unit.
2. Press the **MODE** button (4) to select "Auxiliary" mode. The rear AUX IN audio source will play by default until a device is inserted into the front jack.
3. Press **MODE** again to cancel "Auxiliary" mode and go to the next mode.

NOTE: The front AUX IN jack will override the rear auxiliary audio inputs.

PA Operation (microphone sold separately)

- Connect the PA Microphone with a 4-PIN connector to the 4-PIN socket on the rear of the unit.
- The unit will automatically switch to PA mode when the Mic switch is pushed "ON".
- The PA output level can be adjusted using the rotary volume encoder (1).
- With radio power off, the radio will wake up when PA mic is keyed to make an announcement. Please note that it will take a few seconds before the radio "wakes up" and PA is active. Radio will return to the off state when the PA mic is released.

Liquid Crystal Display (LCD)

The current frequency and activated functions are shown on the LCD panel (21).

NOTE: LCD panels may take longer to respond when subjected to cold temperatures for an extended period of time. In addition, the visibility of the characters on the LCD may decrease slightly. The LCD display will return to normal when the temperature increases to a normal range.

Setting the Clock

To set the clock to display the current time, turn the vehicle ignition on and turn the radio on. Enter the system menu and adjust the clock by selecting the "Set Clock" menu item.

- Press the **INFO/ENTER** button (16) to view the clock set screen.
- Press the **INFO/ENTER** button to move to the next digit.
- Press the **TUNE/SEEK** |<< / >>| (18, 19) buttons to adjust the selected digit.

When no adjustment is made for five seconds, the time will become set and normal operation will resume.

Scroll

When the information is too long to be displayed on the LCD, press the **DISP/SCROLL** button (12) to view the entire title. The information will scroll twice and then return to abbreviated text.

TUNER OPERATION

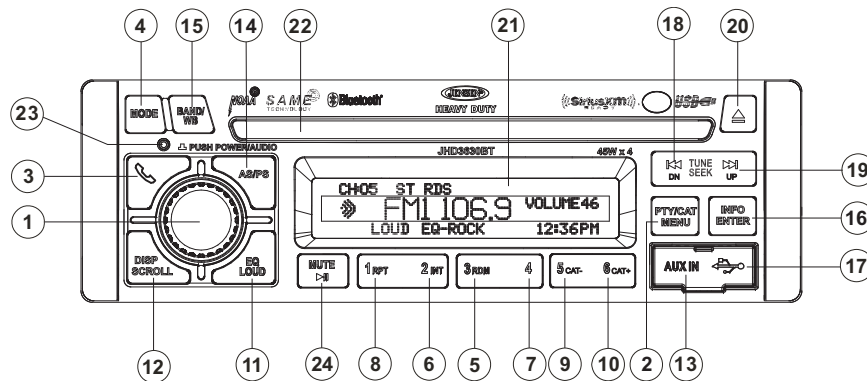

Select a Band

Press the **BAND/WB** button (15) to change between three FM bands and two AM bands. Press and hold the **BAND/WB** button to access the Weatherband (WB).

Manual Tuning

Press the **TUNE/SEEK >>|** or **<<|** buttons (19, 18) to seek stations up/down step by step.

Auto Seek Tuning

Press and hold the **TUNE/SEEK >>|** or **<<|** buttons (19, 18) to automatically seek the next or previous strong station.

NOTE: Seek tuning is not available for weather band channels. Use the up or down tuning buttons to manually select any of the seven available weather band channels.

Preset Stations

Six numbered preset buttons store and recall stations for each band.

Store a Station

Select a band (if needed), then select a station. Press and hold a preset button (5-10) for two seconds. The preset number will appear on the LCD.

Recall a Station

Select a band (if needed). Press a preset button (5-10) to select the corresponding stored station.

NOTE: Preset buttons are pre-assigned frequencies in weather band mode.

Automatically Store / Preset Scan (AS/PS)

Automatically Store

Select an AM or FM band. Press and hold the **AS/PS** button (14) for more than 2 seconds to automatically select 18 strong stations (12 for AM). "Storing Presets" appears on the screen and the new stations replace any stations already stored.

Preset Scan

Select a band. Press **AS/PS** (14) to scan stations stored in the current band. The unit will pause for 5 seconds at each preset station. Press **AS/PS** again to stop scanning when the desired station is reached.

RBDS Operation

This unit is equipped to display RBDS (Radio Broadcast Data Service) information when broadcast by the radio station.

NOTE: Radio stations broadcasting RBDS may not be available in your listening area.

In FM radio mode, press the **PTY/CAT/MENU** button (2) to list the following Program Type (PTY) options: ANY / News / Information / Sports / Talk / Rock / Classic Rock / Adult Hits / Soft Rock / Top 40 / Country / Oldies / Soft / Nostalgia / Jazz / Classical / Rhythm and Blues / Soft Rhythm & Blues / Foreign Language / Religious Music / Religious Talk / Personality / Public / College / Weather / Emergency Test / EMERGENCY!

To search for stations in a PTY category:

1. Press the **PTY/CAT/MENU** button (2) to view the current PTY category.
2. Press the **TUNE/SEEK >>|** or **<<|** buttons (19, 18) to move through the list of available categories and select the program type you wish to search.
3. After selecting the desired PTY, press the **INFO/ENTER** button (16) to search the band for broadcasts of this type. "PTY Search" is displayed while the tuner is searching.

NOTE: Performing a PTY search on "ANY" will Seek Tune and stop on any station broadcasting RBDS, regardless of the program type.

Weather Band Operation

What is the NOAA Weather Radio/Weatheradio Canada?

NOAA (National Oceanic and Atmospheric Administration) is a nationwide system that broadcasts local weather emergency information 24 hours a day via the National Weather Service (NWS) network. The U.S. network has more than 530 stations covering the 50 states as well as the adjacent costal waters, Puerto Rico, the U.S. Virgin Islands and the U.S. Pacific Territories. Each local area has its own transmitting station and there are a total of seven broadcasting frequencies used. A similar system is available in Canada under the Weatheradio Canada service administered by Environment Canada.

Tuning to Weatherband

Press and hold the **BAND/WB** button (15) to access the Weatherband. The indication "WB" will appear on the display panel, along with the current number and channel indication: "WB-1", "WB-2", "WB-3", "WB-4", "WB-5", "WB-6" or "WB-7". The seven frequencies are shown in the following table:

Table 2: WB Frequencies

Frequency (MHz)	Preset
162.400	2
162.425	4
162.450	5
162.475	3
162.500	6
162.525	-
162.550	1

The above table also shows which preset button will access the frequency. Note that one frequency cannot be accessed using a preset button. The frequency can only be reached using the tuning controls.

Use the **TUNE/SEEK >>|** or **|<<** buttons (19, 18) or the preset buttons to tune to each of the seven channels until you find the weatherband station broadcasting in your area.

How many stations can I expect to receive?

Since the broadcasts are local weather and information, the transmission power is usually very low (much less than standard AM or FM stations) so you will usually receive only one station unless you are on the edge of two or more broadcast signals. The most you will receive will be two or three, and that is rare.

Is it possible I won't receive any stations?

Depending on where you are located, there is a possibility you will receive only a very weak signal or none at all. Also, similar to AM and FM signals, weatherband signals are subject to surrounding conditions, weather, obstructions of the signal by hills or mountains, etc.

NOAA Weather Alert

The Weather Alert function adds an additional level of user safety by automatically switching from any of the available function modes to weather band for a minimum of 60 seconds if a NOAA warning tone (1050 Hz) is received/detected. If no additional warning tone is received for 60 seconds, the unit will switch back to the last known function mode. See "System Menu" on page 6 to learn how to turn the WB Alert feature on.

SAME Decoding and Filtering

Specific Area Message Encoding (SAME) data is also broadcast prior to alert broadcasts. SAME data contains information about the geographic region affected by the alert, the type of alert, and its effective time. The geographic region included in the SAME data is called the Geographical Area code and has the form PSSCCC where "P" represents a portion of the county, "SS" is a two-digit state, territory, or offshore marine area identifier and "CCC" identifies the county, province, or major metropolitan area within the state. This unit can be configured through the system setting menu with up to seven Geographical Area codes to limit the automatic tuning or power on functions described above.

SAME data also includes the type of alert being broadcast. This unit can be configured through the System Setting Menu to limit the automatic tuning or power on functions based on the type of alert.

SAME is activated by programming a 6 digit code - called a FIPS code - into your radio. The FIPS code or Federal Information Processing System code is a six digit code that identifies the states and counties (or parishes) in the United States. The first digit identifies the county subdivision. The next two digits identify the state or territory, and the last three identify the county. The FIPS code for your area can be found by calling the NWS toll free number or visiting the web site.

The phone number is 1-888-NWS-SAME (1-888-697-7263) Upon calling, an automated system will prompt you to enter your state and county. When you confirm the information, the system will provide your six digit FIPS code.

The web site is: www.nws.noaa.gov/nwr/indexnw.htm. Upon selecting your state from the chart, you will see a listing of all the counties in that state. For each county there is a listing of the SAME# (FIPS code), the location of the transmitter, the WB frequency, the call sign, the transmitter power and miscellaneous remarks.

NOTE: Because broadcast areas overlap you may want to set more than one S.A.M.E. location. If you live near the border between counties, you may want to receive alerts from more than one tower.

Your radio is capable of being programmed with up to 7 different FIPS location codes. The default code has been programmed at the factory - 000000 - to respond to all messages within your area.

CD/MP3/USB PLAYBACK

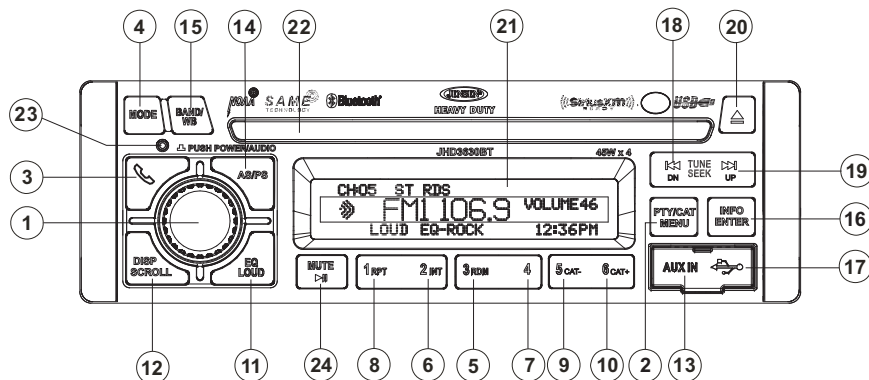

Digital File Playback

If the user inserts a data disc or connects a USB mass storage device, the radio automatically powers on, if necessary, and switches to digital file playback mode and selects that physical media. The bottom left corner of the LCD displays the name of the source. Changing modes or turning off the radio pauses playback.

Playback shall resume exactly where paused when returning to digital file playback mode.

Inserting and Ejecting a Disc

Insert a disc, label-side up, into the disc slot (22). The unit will automatically draw the disc in and play the first track on the disc, whether the power was turned on or not.

Press the eject ▲ button (20) to stop disc play and eject the disc. The unit does not have to be on to eject the disc. Disc will retract if not removed.

Inserting a USB Device

The USB connector (17) is located on the right side of the front panel, behind a protective rubber cover. Pull gently to lower the rubber cover and reveal the USB slot. Insert a USB device to switch to USB mode and begin playback.

Controlling File Playback

Selecting Tracks

Press the **TUNE/SEEK >>|** (19) or **TUNE/SEEK <<|** button (18) to advance to the next track/file. The selected track number will appear on the display. *Press and hold* the **TUNE/SEEK >>|** or **<<|** button to fast forward or fast reverse. Playback begins when the button is released.

Play/Pause Disc Playback

Press the **MUTE/>||** button (24) to suspend playback. "Pause" is displayed on the screen. Press the **MUTE/>||** button again to resume play.

Previewing Tracks

Press the **2/INT** button (6) to play the first 10 seconds of each track in the current folder sequentially. Press **2/INT** again to stop Intro Scan and resume normal play at the current track.

Repeat Play

- Press the **1/RPT** button (8) during disc play to repeat the current track.
- Press **1/RPT** again to stop repeat play.

Random Play

- Press the **3/RDM** button (5) during disc play to play all tracks in the current folder in random, shuffled order.
- Press **3/RDM** again to stop random play.

Folder Navigation (MP3 Only)

- Press the **PTY/CAT/MENU** button (2) to view a list of all songs in the current folder.
- Press the **>>| / UP** (19) and **<<| / DN** (18) buttons to navigate the list.
- Press the **INFO/ENTER** button (16) to play the highlighted song or view files in the selected folder. Continue pressing **INFO/ENTER** until the desired file is selected.
- Press the **PTY/CAT/MENU** button again to navigate up through the file structure.

The unit will automatically exit the folder navigation menu after 5 seconds of inactivity.

MP3 Specifications

Notes on MP3 Playback

- Any directory that does not include an MP3 file is skipped
- Maximum number of folders: 512 (including skipped directories)
- Maximum number of folder levels: 12
- Maximum number of MP3 files: 999
- Maximum number of characters for MP3 file name and folder name: 32
- Sampling frequency: 16KHz, 22.05KHz, 24KHz, 32KHz, 44.1KHz, 48KHz
- Bit rates: maximum 384 Kbps
- Maximum number of Characters of ID3 Tag:
 - ID3 Tag version 1.0: 32
 - ID3 Tag version 2.x: 32

File Playing Order

Files will be continually played sequentially within the current folder. To play songs in another folder, press the **PTY/CAT/MENU** button (2) twice to move up a folder level. Press the **>>| / UP** (19) and **<<| / DN** (18) buttons to navigate the list and then press the **INFO/ENTER** button (16) to access the selected song or folder.

You may be able to set the order in which MP3/WMA are to be played by writing them onto a medium such as a CD-R with their file names beginning with play sequence numbers such as "01" to "99".

SATELLITE RADIO OPERATION

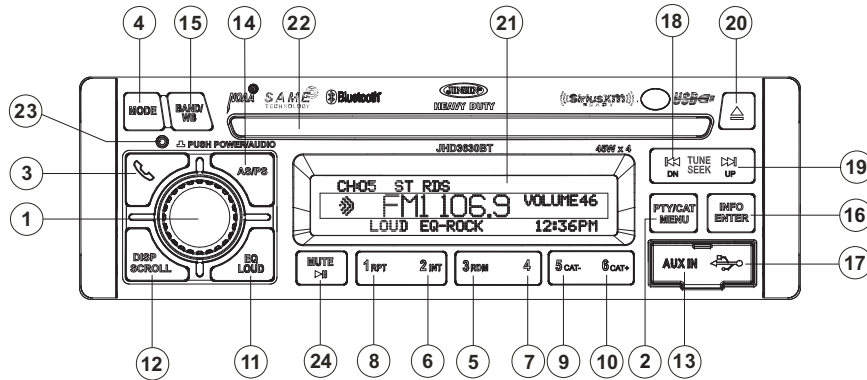

NOTE: SiriusXM is available in the US for subscribers with addresses in the continental US and is available in Canada for subscribers with a Canadian address. Required subscription plus compatible SiriusXM tuner and antenna are required and sold separately. To subscribe to SiriusXM on the internet, visit siriusxm.com, or call 888-539-7474. Have your SiriusXM ID ready (SiriusXM ID is located on the back of the SiriusXM tuner or by tuning to Channel 0). SiriusXM programming is subject to change. Visit siriusxm.com for the most complete and up-to-date channel lineup and product information. “SiriusXM” and the SiriusXM dog logo and related marks are trademarks of SiriusXM Inc. All rights reserved.

Switching to SiriusXM (Requires optional SiriusXM tuner)

Press the **MODE** button (4) to change the mode to SiriusXM mode.

Accessing your SiriusXM ID

To display your SiriusXM radio ID, use the **TUNE/SEEK** <</>> button to tune to channel “000”. The screen will display “Radio ID” with the ID displayed in the middle of the LCD screen. The SiriusXM radio ID is 8 characters long.

Selecting a Band

In SiriusXM mode, press the **BAND/WB** button (15) to access the SiriusXM user-preset channel groups in the following order: SXM1, SXM2, SXM3.

Category Tuning

1. Press the **PTY/CAT/MENU** button (2) to access Category mode.
2. While in category mode, press **5/CAT- OR 6/CAT+** buttons (9, 10) to choose a category.
3. Press the **TUNE/SEEK** <</>> buttons (18, 19) to navigate channels in that category. (The current channel number within the chosen category will always be the default first channel tuned.)
4. Press the **INFO/ENTER** button (16) to select the desired channel.

Channel Up/Down Tuning

Press the **TUNE/SEEK** <</>> buttons (18, 19) to search for a channel. *Press and hold* the **TUNE/SEEK** buttons to fast search.

Direct Tuning Mode

1. *Press and hold* the **INFO/ENTER** button (16) to enter direct tuning mode.
2. Press **TUNE/SEEK** <</>> buttons (18, 19) to change the first of three digits for the desired channel in the direct entry screen.
3. Press the **INFO/ENTER** button to confirm the entered digit and move to the second digit field.
4. Press **TUNE/SEEK** <</>> buttons to select the second digit.
5. Press the **INFO/ENTER** button to confirm the entered digit and move to the third digit field.
6. Press **TUNE/SEEK** <</>> buttons to select the third digit.
7. Press the **INFO/ENTER** button to confirm the three digit channel and tune to the selected channel.

Storing Preset Channels

The preset buttons (5-10) can be used to store 6 channels, allowing convenient access to your favorite channels.

Programming Channels

1. Select the channel you want to store in memory.
2. *Press and hold* a preset button (5-10) until the corresponding preset button number appears.
3. Repeat steps 1 and 2 to program additional channels.

Preset Recall

Press one of the six preset buttons (5-10) to directly select a preset channel stored in the current band.

Preset Scan

Press **AS/PS** button (14) to scan stations stored in all three user-preset channel groups (SXM1, SXM2 and SXM3). The unit will pause for 10 seconds at each preset station.

Preset Tuning

In Preset Tuning Mode, you can use the **TUNE/SEEK** <</>> buttons (18, 19) to access all 18 preset stations in sequential order. Access preset tuning mode through the system menu. Set Preset-Only Tuning to “ON.”

Alternate Display Mode

Press the **DISP/SCROLL** button (12) to change the display information between single and dual line text display. In dual line mode, both artist and title are available for viewing.

Press and hold the **DISP/SCROLL** button to scroll the Artist/Song Title information.





While in category tuning list mode, press the **DISP/SCROLL** button in sequence to change the display information from Channel Name, Artist, and Song Title.

Advisory Messages Reported by the SiriusXM Vehicle Tuner
Table 3: SiriusXM Advisory Messages

On-Screen Display	Advisory Message	Cause	Explanation/Solution
Check Antena	Check Antenna	The radio has detected a fault with the SiriusXM antenna. The antenna cable is either disconnected or damaged.	<ul style="list-style-type: none"> Verify that the antenna cable is connected to the SiriusXM Connect Vehicle Tuner. Inspect the antenna cable for damage and kinks. Replace the antenna if the cable is damaged.
Check Tuner	Check Tuner	<ul style="list-style-type: none"> The radio is having difficulty communicating with the SiriusXM Connect Vehicle Tuner. The tuner may be disconnected or damaged. 	<ul style="list-style-type: none"> Verify that the SiriusXM Connect Vehicle Tuner cable is securely connected to the radio SiriusXM mating connector/cable. If the problem persists, disconnect and reconnect the tuner and then contact your dealer.
No Signal	No Signal	The SiriusXM Connect Vehicle Tuner is having difficulty receiving the SiriusXM satellite signal.	<ul style="list-style-type: none"> Verify that your vehicle is outdoors with a clear view of the southern sky. Verify that the SiriusXM magnetic mount antenna is mounted on a metal surface on the outside the vehicle. Move the SiriusXM antenna away from any obstructions. Inspect the antenna cable for damage and kinks. Replace the antenna if the cable is damaged. If the problem persists, disconnect and reconnect the tuner and then contact your dealer.
Scrolling "Subscription Updated" - press any key to continue"	Subscription Updated	The radio has detected a change in your SiriusXM subscription status.	<ul style="list-style-type: none"> Press Enter to clear the message. No further action is required. Visit www.siriusxm.com or call 1-866-635-2349 if you have questions about your subscription.
Chan Unavailable	Channel Not Available	The channel that you have requested is not a valid SiriusXM channel or the channel that you were listening to is no longer available. You may also see this message briefly when first connecting a new SiriusXM Connect Vehicle tuner. Visit www.siriusxm.com for more information about the SiriusXM channel lineup.	
Ch Unsubscribed	Channel Not Subscribed	The channel that you have requested is not included in your SiriusXM subscription package or the channel that you were listening to is no longer included in your SiriusXM subscription package.	Visit www.siriusxm.com or call 1-866-635-2349 if you have questions about your subscription package or would like to subscribe to this channel.
Channel Locked	Channel Locked	The channel that you have requested is Locked by the radio Parental Control feature.	See the section on Parental Control, page 45 for more information on the Parental Control feature and how to access locked channels.
"Enter Code?" followed by ****	Enter Lock Code	User prompted to enter the lock/ unlock code.	Enter the four digit code to play the audio.

Satellite Signal Strength



The display will indicate satellite reception strength as shown below.

Signal Strength	Strength Display
No Signal	
Weak	
Good	
Excellent	

Channel Lock

Access Channel Lock through the System Menu under the “SiriusXM Satellite Radio” menu.

See “System Menu” on page 6.

1. Select “Set Lock Code” and press the **INFO/ENTER** button (16).
2. Enter the default lock code of “0000”. To set the lock code:
 - a. Press the **TUNE/SEEK** |<< / >>| (18, 19) buttons to enter the first digit of the default code.
 - b. Press the **INFO/ENTER** button to move to the next digit.
 - c. Repeat above steps to enter all 4 digits of the default code.
 - d. Press the **TUNE/SEEK** |<< / >>| (18, 19) buttons to enter the first digit of the new code.
 - e. Press the **INFO/ENTER** button to move to the next digit.
 - f. Repeat above steps to enter all 4 digits.
 - g. Repeat above steps to confirm the new code.
3. After setting a new four digit code, you can lock channels by entering the “Locked Channels” menu.
4. Upon entering the Locked Channels list, you will be prompted to enter your four digit code.
 - a. Press the **TUNE/SEEK** |<< / >>| (18, 19) buttons to enter the first digit.
 - b. Press the **INFO/ENTER** button to move to the next digit.
 - c. Repeat above steps to enter all 4 digits.
5. After entering the code, you can navigate the list using the **TUNE/SEEK** |<< / >>| buttons to highlight the channels.
6. Press the **INFO/ENTER** button (16) to Lock (indicated by a  icon) or Unlock () the selected channel.

iPod OPERATION

This unit is equipped with an iPod ready function that will allow you to control your iPod (if compatible) using the control panel buttons. The following iPod versions are supported:

- iPod nano 5G
- iPod nano 6G
- iPod classic
- iPhone4
- iPhone4S
- iPod touch 3G
- iPod touch 4G

NOTE: Earlier model iPods are not supported because they do not implement the USB control protocol. These unsupported iPod models may be connected to the radio using one of the Auxiliary Inputs.

NOTE: iPod sold separately.

Accessing iPod Mode

Connect a supported iPod or iPhone to the front panel USB connector. The iPod icon illuminates in the bottom left corner of the LCD whenever an iPod or iPhone is attached to the USB connector. Music playback begins automatically.

To enter iPod mode from any other source, press the **MODE** button (4) until "iPod" appears on the display. If the user connects an iPod containing no songs, the radio will display a message stating "No Songs" when it enters iPod mode.

Turning the iPod On/Off

The iPod power turns on automatically when an iPod is connected to the front panel USB connector, as long as the vehicle ignition is turned on. You can turn the iPod off by disconnecting it or by turning the ignition off. When the ignition is turned off, the iPod will pause and then enter sleep mode after 2 minutes. While the iPod is connected, the power cannot be turned on or off from the iPod itself.

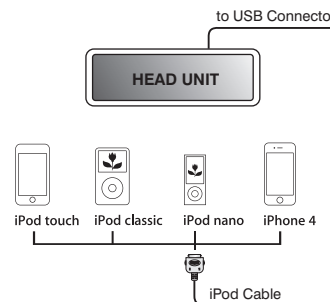

Controlling Playback

Pausing Playback

During playback, press the **MUTE/>>||** button (24) to pause the iPod player. "Pause" will appear on the LCD. Press **MUTE/>>||** again to resume playback.

Repeat Play

During playback, press the **1/RPT** button (8) to repeat the current song. "RPT" will appear on the LCD. Press **1/RPT** again to stop repeat playback.

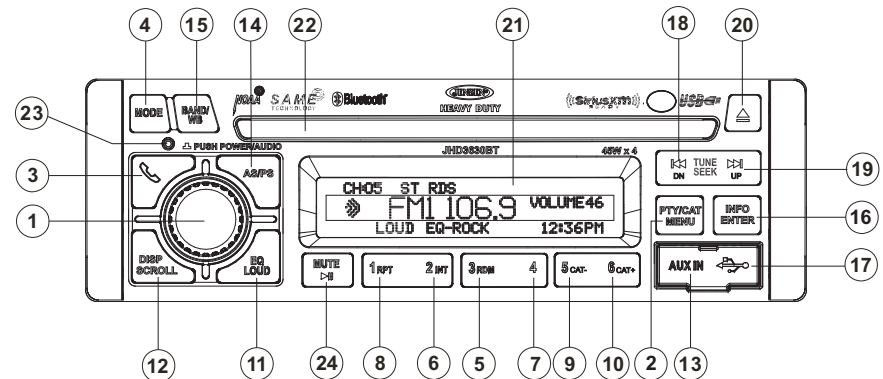

Random Play

During playback, press the **3/RDM** button (5) to play all songs in the current category in random order. Random play will begin once the current song has finished playing. "RDM" will appear on the LCD. Press **3/RDM** again to stop random playback.

Selecting Tracks

During playback, press the **TUNE/SEEK << / >>** buttons (18, 19) to play the previous or next track in the current category. Press the **TUNE/SEEK <<** button (18) once to play the song from the start position or press **TUNE/SEEK <<** twice to play the previous track. Pressing the **TUNE/SEEK <<** button (18) during the first 2 seconds of a track will play the previous track. After 2 seconds, this action return to the beginning of the current track.

Press and hold the **TUNE/SEEK << / >>** button (18, 19) to fast reverse/forward the song.

NOTE: If you press and hold the TUNE/SEEK << / >> button to change the current song to the previous/next song, you will exit fast reverse/forward mode.

Playlist Search

Press the **PTY/CAT/MENU** button (2) to access Playlist selection mode. While in Category mode, press the **TUNE/SEEK << / >>** buttons (18, 19) to choose file search by Playlist, Artist, Album, Genre, Song, Audiobook or Podcast. Press the **INFO/ENTER** button (16) to select the search mode. Use the **TUNE/SEEK << / >>** buttons to search the available files on the iPod. Press the **INFO/ENTER** button to play the selected song or file.

Alternate Display Mode

Press the **DISP/SCROLL** button (12) to change the display information between single and double line text display.

BLUETOOTH OPERATION

The JHD3630BT includes built-in Bluetooth technology that allows you to connect this head unit to Bluetooth devices for streaming audio playback.

About Bluetooth Technology

Bluetooth is a short-range wireless radio connectivity technology developed as a cable replacement for various electronic devices. Bluetooth operates in 2.4 GHz frequency range and transmits voice and data at speeds up to 1 megabit per second. Bluetooth was launched by a special interest group (SIG) comprised of Ericsson Inc., Intel Corp., Nokia Corp., Toshiba and IBM in 1998, and it is currently developed by nearly 2,000 companies worldwide. The Bluetooth word mark and logos are owned by the Bluetooth SIG, Inc. and any use of such marks is under license. Other trademarks and trade names are those of their respective owners.

Bluetooth Menu Options

NOTE: Please note that some BT menu options are only available while the unit is in BT Audio mode.

Press and hold the **PTY/CAT/MENU** button (2) to enter menu adjustment mode. Press the **SEEK/TUNE** buttons (18, 19) repeatedly to view the Bluetooth Setup Menu options. Press **ENTER** to choose the highlighted option.

- **BT ON/OFF:** Press the **ENTER** button (16) to select "BT ON" or "BT OFF". When "On", the LCD will display the BT icon (default "BT ON").
- **BT HFP Volume:** Press the **ENTER** button repeatedly to adjust the ring volume from 0-40 (default 20/previous setting).
- **BT Device List:** Press the **ENTER** button to view a list of previously paired mobile phone device models. Press the **SEEK/TUNE** buttons (18, 19) to view devices from the list. You cannot delete a device that is actively connected. Press the **ENTER** button to select the device. Press the **SEEK+** or **SEEK-** button to choose Lock/Unlock, Disconnect or Delete for this device.
 - **LOCK/UNLOCK:** The JHD3630BT can store up to 5 devices for BT connection. The devices are stored in FIFO (First In First Out) order. To prevent a device from being bumped from the list when more than 5 devices are used, you must lock the device. To Lock/Unlock a device, press the **ENTER** button to display/change the Locked or Unlocked icon.
 - **DISCONNECT:** To disconnect a paired device, press the **ENTER** button to temporarily remove the BT link. The link can be re-established through your phone menu by selecting the JHD3630BT for connection.
 - **DELETE:** To delete a device from the list, press the **ENTER** button. NOTE: Device must be disconnected to be deleted.
- **BT Pair:** Press the **ENTER** button to turn BT Pair "On" to put the unit pairing mode to search for and be discovered by BT devices.
- **BT Auto Answer:** Press the **ENTER** button to turn the Auto Answer function "On" or "Off".

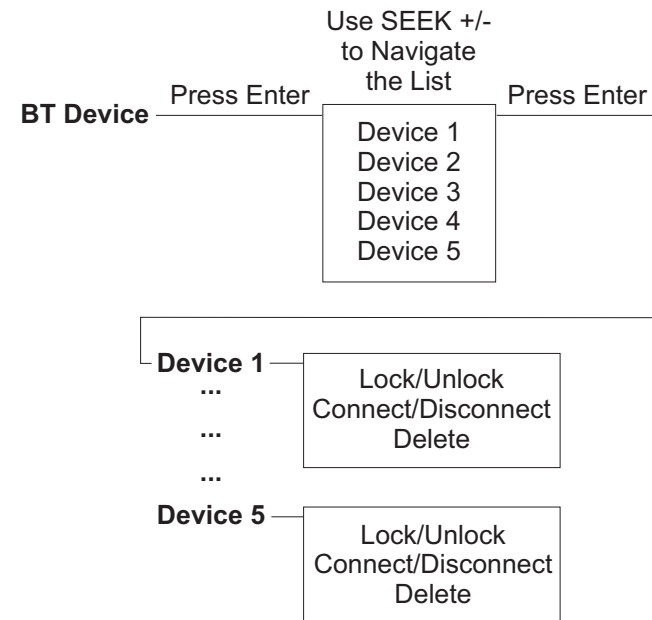

Pairing a Bluetooth Device

Before you begin, consult the owner's manual for the Bluetooth device you want to pair with the JHD3630BT.

1. Make sure the device is on and ready to receive a signal from the JHD3630BT. With the JHD3630BT in BT Audio mode, choose "BT Pair" from the JHD3630BT menu and press the **ENTER** button (16) to begin pairing. The unit is now waiting to connect to a mobile phone device. With the BT function of the mobile phone device turned on, search for a Bluetooth device.
2. When the Bluetooth device has completed its search, the mobile phone will display the Bluetooth device name (JHD3630BT).
3. Select JHD3630BT. The BT icon will appear on the radio LCD.
4. Enter the pairing password (0000), if requested.

After connecting successfully, you will be able to listen to music stored on your Bluetooth enabled device through the radio.

BT Audio (A2DP)

The A2DP music is available for Bluetooth enabled phones when the phone is connected. To access Bluetooth mode and play songs stored on your phone, press the **MODE** button (4).

While in BT mode, the BT Audio icon illuminates on the LCD.

Selecting Tracks

During playback, press the **SEEK/TUNE** buttons (18, 19) to play the previous or next track.

Pausing Playback

During playback, press the **MUTE/>>||** button (24) to pause the BT AUDIO player. "BT AUDIO PAUSE" will appear on the LCD. Press **MUTE/>>||** again to resume playback. If you change to another mode, the mobile phone audio will pause. Press the **MODE** button (4) to return to BT mode and resume mobile phone audio playback.

NOTE: If a Bluetooth device is disconnected due to the power being turned off or if the device is disconnected inadvertently, the unit will automatically search for the matching BT mobile phone when the power is restored.

Incoming/Outgoing call

While the mobile device is connected through BT, the phone number for incoming calls will appear on the LCD. The incoming ring will be output through the unit unless the unit is broadcasting a Weather Band Alert or the PA system is in use.

Answer Call

If the BT Auto Answer function is turned "Off", the user must press the "CALL" button (3) to receive and incoming call.

If the BT Auto Answer function is turned "On", the unit will automatically receive the incoming call after 5 seconds of ringtone.

Transfer Call

During the call, *press and hold* the "CALL" button transfer the call between the unit and the mobile device.

End Call

Press the "CALL" button to end a call. The unit will return to the previous mode.

Reject Incoming Call

To reject an incoming call, *press and hold* the "CALL" button.

CARE AND MAINTENANCE

- Keep the product dry. If it does get wet, wipe it dry immediately. Liquids might contain minerals that can corrode the electronic circuits.
- Keep the product away from dust and dirt, which can cause premature wear of parts.
- Handle the product gently and carefully. Dropping it can damage circuit boards and cases, and can cause the product to work improperly.
- Wipe the product with a dampened cloth occasionally to keep it looking new. Do not use harsh chemicals, cleaning solvents, or strong detergents to clean the product.
- Use and store the product only in normal temperature environments. High temperature can shorten the life of electronic devices, damage batteries, and distort or melt plastic parts.

Ignition

The most common source of noise in reception is the ignition system. This is a result of the radio being placed close to the ignition system (engine). This type of noise can be easily detected because it will vary in intensity of pitch with the speed of the engine.

Usually, the ignition noise can be suppressed considerably by using a radio suppression type high voltage ignition wire and suppressor resistor in the ignition system. (Most vessels employ this wire and resistor but it may be necessary to check them for correct operation.) Another method of suppression is the use of additional noise suppressors. These can be obtained from most CB/A radio or electronic supply shops.

Interference

Radio reception in a moving environment is very different from reception in a stationary environment (home). It is very important to understand the difference.

AM reception will deteriorate when passing under a bridge or when passing under high voltage lines. Although AM is subject to environmental noise, it has the ability to be received at great distance. This is because broadcasting signals follow the curvature of the earth and are reflected back by the upper atmosphere.

TROUBLESHOOTING

Symptom	Cause	Solution
No power	The vessel's accessory switch is not on	If the power supply is properly connected to the vessel's accessory terminal, switch the ignition key to "ACC".
	Fuse is blown	Replace the fuse.
Disc cannot be loaded or ejected	Presence of CD disc inside the player	Remove the disc in the player and insert the new one.
	Inserting the disc in upside down	Insert the compact disc with the label facing upward.
	Compact disc is extremely dirty or disc is defective	Clean the disc or try to play a new one.
	Condensation	Leave the player off for an hour or so, then try again.
No sound	Volume is too low	Adjust volume to audible level.
	Wiring is not properly connected	Check wiring connections.
The operation keys do not work	Control panel is not properly installed	Reinstall control panel.
	Built-in microcomputer is not operating properly due to noise	Press the RESET button.
Sound skips	Installation angle is more than 30 degrees	Adjust the installation angle to less than 30 degrees.
	Disc is dirty or defective	Clean the disc and try to play again or use a new disc.
Cannot tune to radio station, auto-seek does not work	Antenna cable is not connected	Insert the antenna cable firmly.
	Signals are too weak	Select a station manually.
ERROR-01 on LCD	Database or decoder error	Change to another mode.
ERROR-02 on LCD	Disc not supported	Remove disc and insert supported CDDA or CD-ROM disc.
ERROR-03 on LCD	No songs on device	Remove device and add songs.
ERROR-04 on LCD	Abnormal current to USB device	Change mode or unplug and reconnect USB device.
ERROR-05 on LCD	iPod/iPhone is not verified	Unplug and reconnect iPod/iPhone.

SPECIFICATIONS

CD

Signal to Noise Ratio	≥ 65 dB
Channel Separation	: More than 50 dB
Frequency Response	: 20 Hz - 20 kHz

FM Radio

Frequency Coverage (USA)	87.5 to 107.9 MHz
Frequency Coverage (Europe)	87.5 to 108 MHz
Sensitivity (S/N=30dB)	2.2µV
Stereo Separation	>25 dB

AM/MW

Frequency Range (USA)	530-1710 kHz
Frequency Range (Europe)	522-1620 kHz
Sensitivity (S/N=20dB)	17 dB

General

Operating Voltage	DC 12 Volts
Grounding System	Negative Ground
Speaker Impedance	4-8 ohms per channel
Tone Controls:	
Bass (at 100 Hz)	: ±10 dB
Treble (at 10 kHz)	: ±10 dB
Power Output	45W x 4
Idle/Standby Current	0A
Current Drain	10 Ampere Max
Dimensions	175 (W) x 175 (D) x 50 (H)

FCC Notes

WARNING! Changes or modifications to this unit not expressly approved by the party responsible for compliance could void the user's authority to operate the equipment.

NOTE: This equipment has been tested and found to comply with the limits for a Class B digital device, pursuant to Part 15 of the FCC Rules. These limits are designed to provide reasonable protection against harmful interference in a residential installation.

This equipment generates, uses and can radiate radio frequency energy and, if not installed and used in accordance with the instructions, may cause harmful interference to radio communications.

However, there is no guarantee that interference will not occur in a particular installation. If this equipment does cause harmful interference to radio or television reception, which can be determined by turning the equipment off and on, the user is encouraged to try to correct the interference by one or more of the following measures:

- Reorient or relocate the receiving antenna.
- Increase the separation between the equipment and receiver.
- Connect the equipment into an outlet on a circuit different from that to which the receiver is connected.
- Consult the dealer or an experienced radio/TV technician for help.



ASA Electronics Corporation

www.asaelectronics.com

www.jensenheavyduty.com

©2012 ASA Electronics Corporation

v. 100512

Free Manuals Download Website

<http://myh66.com>

<http://usermanuals.us>

<http://www.somanuals.com>

<http://www.4manuals.cc>

<http://www.manual-lib.com>

<http://www.404manual.com>

<http://www.luxmanual.com>

<http://aubethermostatmanual.com>

Golf course search by state

<http://golfingnear.com>

Email search by domain

<http://emailbydomain.com>

Auto manuals search

<http://auto.somanuals.com>

TV manuals search

<http://tv.somanuals.com>