



ENGLISH  
FRANÇAIS  
ESPAÑOL

# KD-X220

DIGITAL MEDIA RECEIVER

## INSTRUCTION MANUAL

RÉCEPTEUR MULTIMÉDIA NUMÉRIQUE

## MANUEL D'INSTRUCTIONS

RECEPTOR DE MEDIOS DIGITALES

## MANUAL DE INSTRUCCIONES

JVCKENWOOD Corporation

Please read all instructions carefully before operation to obtain the best possible performance from the unit.

Veuillez lire les instructions attentivement avant d'utiliser l'appareil afin d'obtenir les meilleures performances possibles de l'appareil.

Por favor lea detenidamente este manual para comprender a fondo todas las instrucciones y obtener un máximo disfrute de esta unidad.



**For customer Use:**

Enter below the Model No. and Serial No. which are located on the top or bottom of the cabinet. Retain this information for future reference.

Model No. \_\_\_\_\_  
Serial No. \_\_\_\_\_

# CONTENTS

BEFORE USE	2
BASICS	3
GETTING STARTED	4
USB / iPod / ANDROID	5
RADIO	7
AUX	8
Pandora®	9
iHeartRadio®	10
AUDIO SETTINGS	11
DISPLAY SETTINGS	13
MORE INFORMATION	14
TROUBLESHOOTING	15
SPECIFICATIONS	17
INSTALLATION / CONNECTION	18

# BEFORE USE

## ⚠ Warning

Do not operate any function that takes your attention away from safe driving.

## ⚠ Caution

### Volume setting:

- Adjust the volume so that you can hear sounds outside the car to prevent accidents.
- Lower the volume before playing digital sources to avoid damaging the speakers by the sudden increase of the output level.

### General:

- Avoid using the external device if it might hinder safe driving.
- Make sure all important data has been backed up. We shall bear no responsibility for any loss of recorded data.
- Never put or leave any metallic objects (such as coins or metal tools) inside the unit, to prevent a short circuit.

### Remote control (RM-RK52):

- Do not leave the remote control in hot places such as on the dashboard.
- The Lithium battery is in danger of explosion if replaced incorrectly. Replace it only with the same or equivalent type.
- The battery pack or batteries shall not be exposed to excessive heat such as sunshine, fire or the like.
- Keep the battery out of reach of children and in its original packaging when not in used. Dispose of used batteries promptly. If swallowed, contact a physician immediately.

## How to read this manual

- Operations are explained mainly using buttons on the faceplate.
- [XX] indicates the selected items.
- (→ XX) indicates references are available on the stated page.

## Maintenance

**Cleaning the unit:** Wipe off dirt on the faceplate with a dry silicone or soft cloth.

**Cleaning the connector:** Detach the faceplate and clean the connector gently with a cotton swab, being careful not to damage the connector.



Connector (on the reverse side of the faceplate)

# BASICS

## Faceplate

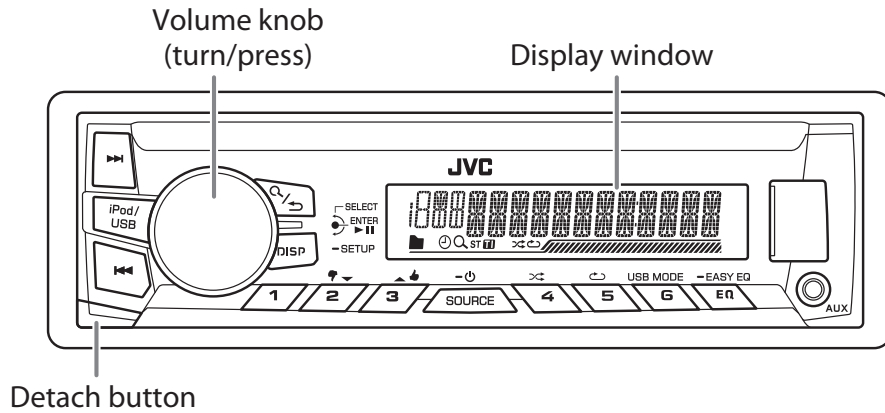

### Attach

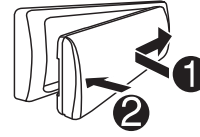

### Detach

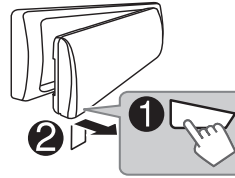

### How to reset

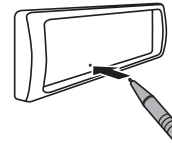

Your preset adjustments will also be erased.

## Remote control (RM-RK52)

Remote sensor (Do not expose to bright sunlight.)

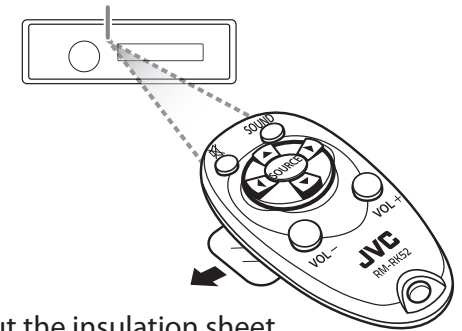

Pull out the insulation sheet when using for the first time.

### How to replace the battery

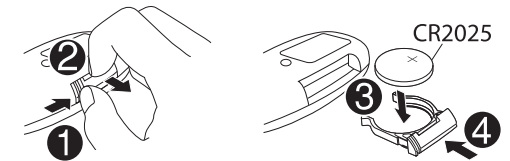

To	On the faceplate	On the remote control
Turn on the power	Press <b>SOURCE-⏻</b> . • Press and hold to turn off the power.	—
Adjust the volume	Turn the volume knob. Press the volume knob to mute the sound or pause playback. • Press again to cancel.	Press <b>VOL +</b> or <b>VOL -</b> . Press <del>⏻</del> to mute the sound or pause playback. • Press again to cancel.
Select a source	• Press <b>SOURCE-⏻</b> repeatedly. • Press <b>SOURCE-⏻</b> , then turn the volume knob within 2 seconds. • Press <b>iPod / USB</b> to select iPod or USB source directly.	Press <b>SOURCE</b> repeatedly.
Change the display information	Press <b>DISP-SETUP</b> repeatedly. (→ 15)	—

# GETTING STARTED

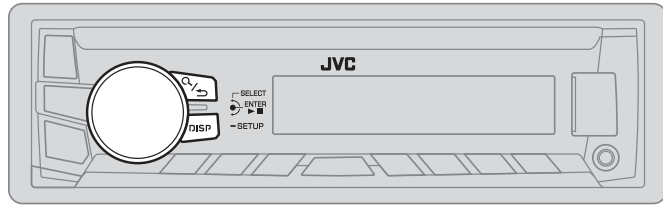

## 1 Cancel the demonstration

- 1 Press and hold **DISP-SETUP**.
- 2 Turn the volume knob to select [DEMO], then press the knob.
- 3 Turn the volume knob to select [DEMO OFF], then press the knob.
- 4 Press **DISP-SETUP** to exit.

## 2 Set the clock

- 1 Press and hold **DISP-SETUP**.
- 2 Turn the volume knob to select [CLOCK], then press the knob.
- 3 Turn the volume knob to select [CLOCK SET], then press the knob.
- 4 Turn the volume knob to make the settings, then press the knob.  
Day → Hour → Minute
- 5 Turn the volume knob to select [24H/ 12H], then press the knob.
- 6 Turn the volume knob to select [12 HOUR] or [24 HOUR], then press the knob.
- 7 Press **DISP-SETUP** to exit.

To return to the previous setting item, press **Q/↵**.

## 3 Set the basic settings

- 1 Press and hold **DISP-SETUP**.
- 2 Turn the volume knob to make a selection (see the following table), then press the knob.
- 3 Repeat step 2 until the desired item is selected or activated.
- 4 Press **DISP-SETUP** to exit.

To return to the previous setting item, press **Q/↵**.

Default: **XX**

### SETTINGS

**BEEP** **ON**: Activates the keypress tone. ; **OFF**: Deactivates.

### SRC SELECT

**AM\*** **ON**: Enables AM in source selection. ; **OFF**: Disables.

**PANDORA\*** **ON**: Enables PANDORA in source selection. ; **OFF**: Disables.

**IHEART\*** **ON**: Enables IHEARTRADIO in source selection. ; **OFF**: Disables.

**AUX\*** **BT ADAPTER**: Selects when the KS-BTA100 Bluetooth adapter is connected to the AUX jack. (→ 8) ; **ON**: Enables AUX in source selection. ; **OFF**: Disables.

### F/W UPDATE

#### SYSTEM

**F/W xxxx** **YES**: Starts upgrading the firmware. ; **NO**: Cancels (upgrading is not activated).  
For details on how to update the firmware, see:  
<<http://www.jvc.net/cs/car/>>.

### CLOCK

**CLOCK SYNC** **AUTO**: The clock time is automatically set using the Clock Time (CT) data in FM Radio Broadcast Data System signal. ; **OFF**: Cancels.

**CLOCK DISP** **ON**: The clock time is shown on the display even when the unit is turned off. ; **OFF**: Cancels.

\* Not displayed when the corresponding source is selected.

# USB / iPod / ANDROID

## Start playback

The source changes automatically and playback starts.

USB input terminal

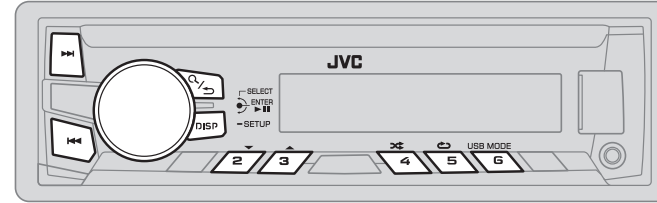
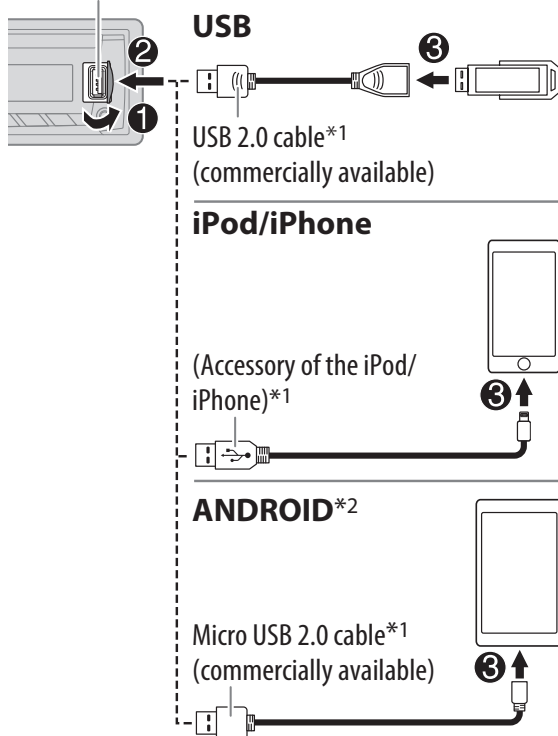

To	On the faceplate	On the remote control
Reverse / Fast-forward*3	Press and hold  ◀◀ / ▶▶ .	Press and hold ◀/▶.
Select a file	Press  ◀◀ / ▶▶ .	Press ◀/▶.
Select a folder*4	Press 3 ▲ / 2 ▼.	Press ▲ / ▼.
Repeat play*5	Press 5 ↺ repeatedly. TRACK RPT/ RPT OFF : JVC Playlist Creator (JPC) / JVC Music Control (JMC) file (➔ 14) TRACK RPT/ FOLDER RPT/ RPT OFF : MP3/WMA/WAV/FLAC file ONE RPT/ ALL RPT/ RPT OFF : iPod or ANDROID	
Random play*5	Press 4 ↻ repeatedly. FOLDER RND/ ALL RND/ RND OFF : MP3/WMA/WAV/FLAC file or JPC / JMC file SONG RND/ ALL RND/ RND OFF : iPod or ANDROID	

\*1 Do not leave the cable inside the car when not using.

\*2 When connecting an Android device, "Press [VIEW] to install JVC MUSIC PLAY APP" is shown. Follow the instructions to install the application. You can also install the latest version of JVC MUSIC PLAY application on your Android device before connecting. (➔ 14)

\*3 For ANDROID: Applicable only when [AUTO MODE] is selected. (➔ 6)

\*4 Only for MP3/WMA/WAV/FLAC files. This does not work for iPod/ ANDROID.

\*5 For iPod/ ANDROID: Applicable only when [HEAD MODE]/ [AUTO MODE] is selected. (➔ 6)

## USB / iPod / ANDROID

To	On the faceplate
Select control mode	<p>While in iPod source, press <b>6 USB MODE</b> repeatedly.</p> <p><b>HEAD MODE:</b> Control from the unit.</p> <p><b>IPHONE MODE:</b> Control from the iPod/iPhone. However, you can still play/pause or file skip from the unit.</p> <p>While in ANDROID source, press <b>6 USB MODE</b> repeatedly.</p> <p><b>AUTO MODE:</b> Control from the unit (using JVC MUSIC PLAY application).</p> <p><b>AUDIO MODE:</b> Control other media player applications from the Android device (without using JVC MUSIC PLAY application). However, you can still play/pause or file skip from the unit.</p>
Select music drive	<p>Press <b>6 USB MODE</b> repeatedly.</p> <p>The stored songs in the following start playback.</p> <ul style="list-style-type: none"><li>• Selected internal or external memory of a smartphone (Mass Storage Class).</li><li>• Selected drive of a multiple drives device.</li></ul>

### Change the playback speed of the Audiobook

While listening to the iPod and [HEAD MODE] is selected (→ Select control mode)....

- 1 Press and hold **DISP-SETUP**.
- 2 Turn the volume knob to select [IPOD], then press the knob.
- 3 Press the volume knob to select [AUDIOBOOKS].
- 4 Turn the volume knob to make a selection, then press the knob.  
**0.5× SPEED / 1× SPEED / 2× SPEED:** Select the desired playback speed of the Audiobooks sound file in your iPod/iPhone.  
(Default: Depends on your iPod/iPhone setting.)
- 5 Press **DISP-SETUP** to exit.

To return to the previous setting item, press **Q/↵**.

### Select a file from a folder/list

- 1 Press **Q/↵**.
- 2 Turn the volume knob to select a folder/list, then press the knob.
- 3 Turn the volume knob to select a file, then press the knob.

#### Quick Search

If you have many files, you can search through them quickly.

#### For MP3/WMA/WAV/FLAC or JPC / JMC file:

Turn the volume knob quickly.

#### For iPod:

You can search for a file according to the first character.

Press **3 ▲ / 2 ▼** or turn the volume knob quickly to select the desired character (A to Z/ 0 to 9/ OTHERS).

- Select "OTHERS" if the first character is other than A to Z, 0 to 9.

- To return to the previous setting item, press **Q/↵**.
- To cancel, press and hold **Q/↵**.
- For iPod, applicable only when [HEAD MODE] is selected. (→ Select control mode)
- For ANDROID, applicable only when [AUTO MODE] is selected. (→ Select control mode)

# RADIO

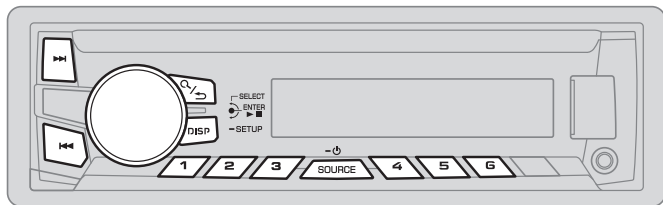

“ST” lights up when receiving an FM stereo broadcast with sufficient signal strength.

## Search for a station

- 1 Press **SOURCE**- repeatedly to select FM or AM.
- 2 Press (or press on RM-RK52) to search for a station automatically.  
(or)  
Press and hold (or press and hold on RM-RK52) until “M” flashes, then press repeatedly to search for a station manually.

## Settings in memory

You can store up to 18 stations for FM and 6 stations for AM.

### ■ Store a station

While listening to a station....

Press and hold one of the number buttons (1 to 6).  
(or)

- 1 Press and hold the volume knob until “PRESET MODE” flashes.
- 2 Turn the volume knob to select a preset number, then press the knob.  
The preset number flashes and “MEMORY” appears.

### ■ Select a stored station

Press one of the number buttons (1 to 6).  
(or)

- 1 Press .
- 2 Turn the volume knob to select a preset number, then press the knob to confirm.

## Other settings

- 1 Press and hold **DISP-SETUP**.
- 2 Turn the volume knob to select [TUNER], then press the knob.
- 3 Turn the volume knob to make a selection (see the following table), then press the knob.
- 4 Repeat step 3 until the desired item is selected/activated or follow the instructions stated on the selected item.
- 5 Press **DISP-SETUP** to exit.

To return to the previous setting item, press .

Default: **XX**

<b>RADIO TIMER</b>	Turns on the radio at a specific time regardless of the current source. <b>1 ONCE/ DAILY/ WEEKLY/ OFF:</b> Select how often the timer will be turned on. <b>2 FM/ AM:</b> Select the source. <b>3 01 to 18 (for FM)/ 01 to 06 (for AM):</b> Select the preset station. <b>4</b> Set the activation day* <sup>1</sup> and time. “” lights up when complete. Radio Timer will not activate for the following cases. <ul style="list-style-type: none"><li>• The unit is turned off.</li><li>• [OFF] is selected for [AM] in [SRC SELECT] after Radio Timer for AM is selected. (→ 4)</li></ul>
--------------------	--

\*<sup>1</sup> Selectable only when [ONCE] or [WEEKLY] is selected in step 1.

## RADIO

Default: **XX**

<b>SSM</b>	<b>SSM 01 – 06 / SSM 07 – 12 / SSM 13 – 18:</b> Automatically presets up to 18 stations for FM. "SSM" stops flashing when the first 6 stations are stored. Select <b>SSM 07 – 12 / SSM 13 – 18</b> to store the following 12 stations.
<b>IF BAND</b>	<b>AUTO:</b> Increases the tuner selectivity to reduce interference noises from adjacent FM stations. (Stereo effect may be lost.); <b>WIDE:</b> Subjects to interference noises from adjacent FM stations, but sound quality will not be degraded and the stereo effect will remain.
<b>MONO</b>	<b>ON:</b> Improves the FM reception, but the stereo effect will be lost.; <b>OFF:</b> Cancels.
<b>AREA</b>	<b>AREA US:</b> For North/Central/South America, AM/FM intervals: 10 kHz/200 kHz.; <b>AREA SA:</b> For some South American countries, AM/FM intervals: 10 kHz/50 kHz.; <b>AREA EU:</b> For any other areas, AM/FM intervals: 9 kHz/50 kHz.
<b>PTY SEARCH*2</b>	Select a PTY code (see below). If there is a station broadcasting a program of the same PTY code as you have selected, that station is tuned in.

**PTY code:** NEWS, INFORM (information), SPORTS, TALK, ROCK, CLS ROCK (classic rock), ADLT HIT (adult hits), SOFT RCK (softrock), TOP 40, COUNTRY, OLDIES, SOFT, NOSTALGA (nostalgia), JAZZ, CLASSICL (classical), R & B (rhythm and blues), SOFT R&B (soft rhythm and blues), LANGUAGE, REL MUSC (religious music), REL TALK (religious talk), PERSNLTY (personality), PUBLIC, COLLEGE, HABL ESP (Spanish talk), MUSC ESP (Spanish music), HIP HOP, WEATHER

\*2 Only for FM source.

## AUX

### Use a portable audio player

- 1 Connect a portable audio player (commercially available).

3.5 mm (1/8") stereo mini plug with "L" shaped connector (commercially available)

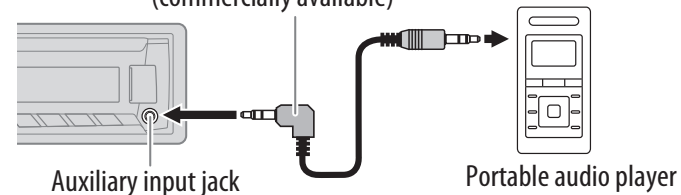

- 2 Select [ON] for [AUX] in [SRC SELECT]. (→ 4)
- 3 Press **SOURCE**-⏻ repeatedly to select **AUX**.
- 4 Turn on the portable audio player and start playback.

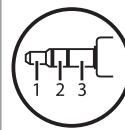

Use a 3-core plug head stereo mini plug for optimum audio output.

### Use a Bluetooth® device

- 1 Connect the Bluetooth adapter, KS-BTA100 (separately purchased).

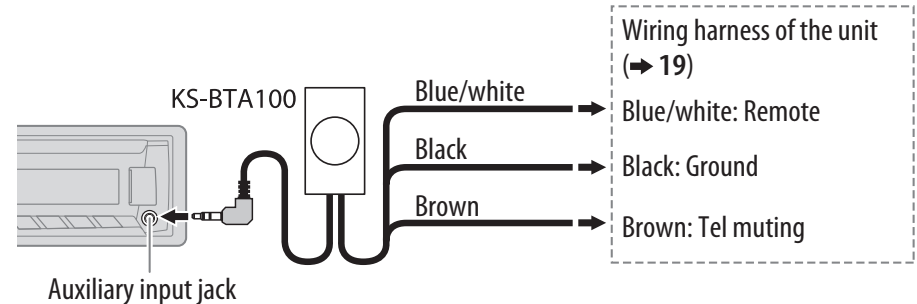

- 2 Register (pair) the Bluetooth device with KS-BTA100.
- 3 Select [BT ADAPTER] for [AUX] in [SRC SELECT]. (→ 4).
- 4 Press **SOURCE**-⏻ repeatedly to select **BT AUDIO**.
- 5 Start using the Bluetooth device.

For details, refer to the instruction manual of KS-BTA100.



# Pandora®

## Preparation:

Install the latest version of the Pandora application on your device (iPhone/ iPod touch), then create an account and log in to Pandora.





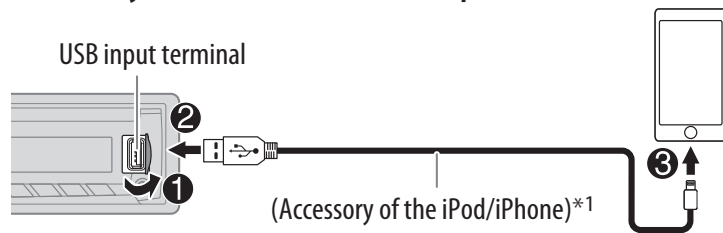

- Select [ON] for [PANDORA] in [SRC SELECT]. (→ 4)

## Start listening

- 1 Open the Pandora application on your device.
- 2 Connect your device to the USB input terminal.



The source changes to PANDORA and broadcast starts.

To	On the faceplate	On the remote control
Playback / pause	Press the volume knob.	Press  .
Skip a track	Press  .	Press  .
Thumbs up or thumbs down*2	Press <b>3</b>  / <b>2</b>  .	Press  /  .

\*1 Do not leave the cable inside the car when not using.

\*2 If thumbs down is selected, the current track is skipped.

## Create and save a new station

- 1 Press .
- 2 Turn the volume knob to select [NEW STATION], then press the knob.
- 3 Turn the volume knob to select [FROM TRACK] or [FROM ARTIST], then press the knob.

A new station is created based on the current song or artist.

- 4 Press and hold number button **1**, **4**, **5** or **6** to store.

To select a stored station, press number button **1**, **4**, **5** or **6**.

## Search for a registered station

- 1 Press .
- 2 Turn the volume knob to make a selection, then press the knob.  
[BY DATE]: According to the registered date.  
[A-Z]: Alphabetical order.
- 3 Turn the volume knob to the desired station, then press the knob.

To cancel, press and hold .

## Bookmark a song or artist information

- 1 Press and hold the volume knob.
- 2 Turn the volume knob to make a selection, then press the knob.  
[THIS TRACK]: Current song information  
[THIS ARTIST]: Current artist information  
"BOOKMARKED" appears and the information is stored to your device.  
The bookmark is available on your Pandora account but not on this unit.

# iHeartRadio®

## Preparation:

Install the latest version of iHeart Link for JVC application on your device (iPhone/ iPod touch), then create an account and log in to iHeartRadio.

- Select [ON] for [IHEART] in [SRC SELECT]. (→ 4)

## Start listening

- 1 Open the iHeart Link application on your device.
- 2 Connect your device to the USB input terminal.

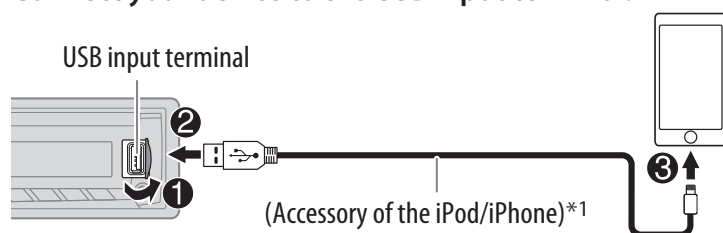

- 3 Press **SOURCE-** repeatedly to select IHEARTRADIO.  
Broadcast starts automatically

To	On the faceplate	On the remote control
Playback / pause	Press the volume knob.	Press
Skip a track for custom station	Press <b>▶▶</b> .	Press <b>▶</b> .
Thumbs up or thumbs down for custom station*2	Press <b>3 ↓ / 2 ↑</b> .	Press <b>▲ / ▼</b> .
Create a new/custom station	Press and hold the volume knob.	—
Add to favorite stations for live station	Press <b>1</b> .	—
Scan for live station	Press <b>4</b> .	—

\*1 Do not leave the cable inside the car when not using.

\*2 If thumbs down is selected, the current track is skipped.

## Search for a station

- 1 Press **Q / ↵**.
- 2 Turn the volume knob to select a category, then press the knob.
- 3 Turn the volume knob to the desired station, then press the knob.  
When a city list appears, you can skip cities in alphabetical order.

To cancel, press and hold **Q / ↵**.

## Skip cities by alphabetical order

While a city list appears during search...

- 1 Turn the volume knob quickly to enter character search.  
You can search through the list quickly according to the first character (A to Z).
- 2 Turn the volume knob or press **3 ↓ / 2 ↑** to select the character to be search for.
- 3 Press the volume knob to start searching.

To cancel, press and hold **Q / ↵**.

# AUDIO SETTINGS

To	On the faceplate
Select a preset equalizer	<p>Press <b>EQ-EASY EQ</b> repeatedly.</p> <p>Press <b>EQ-EASY EQ</b>, then turn the volume knob within 2 seconds.</p> <p>Preset equalizer: FLAT (default), HARD ROCK, JAZZ, POP, R&amp;B, TALK, USER1, USER2, VOCAL BOOST, BASS BOOST, CLASSICAL, DANCE</p>
Store your own sound settings	<ol style="list-style-type: none"> <li>1 Press and hold <b>EQ-EASY EQ</b>.</li> <li>2 Turn the volume knob to select [EASY EQ], then press the knob.</li> <li>3 Turn the volume knob to select [USER1] or [USER2], then press the knob.</li> <li>4 Turn the volume knob to make a selection, then press the knob.</li> </ol> <p>For settings, refer to step 2 of [EASY EQ].</p> <ul style="list-style-type: none"> <li>• To return to the previous setting item, press <b>Q/↵</b>.</li> <li>• To exit, press <b>EQ-EASY EQ</b>.</li> </ul>

## Other settings

- 1 Press and hold **DISP-SETUP**.
- 2 Turn the volume knob to make a selection (see the following table), then press the knob.
- 3 Repeat step 2 until the desired item is selected/activated or follow the instructions stated on the selected item.
- 4 Press **DISP-SETUP** to exit.

To return to the previous setting item, press **Q/↵**.

Default: XX

## EQ SETTING

**EQ PRESET** FLAT / HARD ROCK / JAZZ / POP / R&B / TALK / USER1 / USER2 / VOCAL BOOST / BASS BOOST / CLASSICAL / DANCE: Selects a preset equalizer.

**EASY EQ**

- 1 USER1/ USER2: Select a preset name.
- 2 Adjust your own sound settings.

SUB.W SP*1*2:	00 to +06	(Default: <u>03</u> )
SUB.W*1*3:	-08 to +08	<u>00</u>
BASS LVL:	-06 to +06	<u>00</u>
MID LVL:	-06 to +06	<u>00</u>
TRE LVL:	-06 to +06	<u>00</u>

**PRO EQ**

- 1 USER1/ USER2: Select a preset name.
- 2 BASS / MIDDLE / TREBLE: Select a sound tone.
- 3 Adjust the sound elements of the selected sound tone.

<b>BASS</b>	Frequency: 60/ 80/ 100/ 200 HZ	(Default: <u>80 HZ</u> )
	Level: -06 to +06	<u>00</u>
	Q: Q1.0/ Q1.25/ Q1.5/ Q2.0	<u>Q1.0</u>
<b>MIDDLE</b>	Frequency: 0.5/ 1.0/ 1.5/ 2.5 KHZ	(Default: <u>1.0 KHZ</u> )
	Level: -06 to +06	<u>00</u>
	Q: Q0.75/ Q1.0/ Q1.25	<u>Q1.25</u>
<b>TREBLE</b>	Frequency: 10.0/ 12.5/ 15.0/ 17.5 KHZ	(Default: <u>10.0 KHZ</u> )
	Level: -06 to +06	<u>00</u>
	Q: Q FIX	<u>Q FIX</u>

\*1 Displayed only when [SUB.W] is set to [ON]. (→ 12)

\*2 Displayed only when [SPK/PRE OUT] is set to [SUB.W/SUB.W]. (→ 12)

\*3 Displayed only when [SPK/PRE OUT] is set to [REAR/SUB.W] or [SUB.W/SUB.W]. (→ 12)

## AUDIO SETTINGS

AUDIO	
<b>BASS BOOST</b>	<b>+01 / +02:</b> Selects your preferred bass boost level. ; <b>OFF:</b> Cancels.
<b>LOUD</b>	<b>01 / 02:</b> Boosts low or high frequencies to produce a well-balanced sound at low volume. ; <b>OFF:</b> Cancels.
<b>SUB.W LEVEL</b> *4	<b>SPK-OUT</b> *5 <b>00 to +06 (+03):</b> Adjusts the output level of the subwoofer connected via speaker lead. (➔ 19) <hr/> <b>PRE-OUT</b> *6 <b>-08 to +08 (00):</b> Adjusts the output level of the subwoofer connected to the lineout terminals (REAR/SW) through an external amplifier. (➔ 19)
<b>SUB.W</b> *6	<b>ON / OFF:</b> Turns on or off the subwoofer output.
<b>SUB.W LPF</b> *4	<b>THROUGH:</b> All signals are sent to the subwoofer. ; <b>LOW 55HZ / MID 85HZ / HIGH 120HZ:</b> Audio signals with frequencies lower than 55 Hz/ 85 Hz/ 120 Hz are sent to the subwoofer.
<b>SUB.W PHASE</b> *4	<b>REVERSE (180°)/ NORMAL (0°):</b> Selects the phase of the subwoofer output to be in line with the speaker output for optimum performance. (Selectable only if a setting other than [THROUGH] is selected for [SUB.W LPF].)
<b>FADER</b>	<b>R06 — F06 (00):</b> Adjusts the front and rear speaker output balance.
<b>BALANCE</b> *7	<b>L06 — R06 (00):</b> Adjusts the left and right speaker output balance.
<b>VOL ADJUST</b>	<b>-05 — +05 (00):</b> Presets the volume adjustment level of each source (compared to the FM volume level). Before adjustment, select the source you want to adjust. ("VOL ADJ FIX" appears if FM is selected.)
<b>AMP GAIN</b>	<b>LOW POWER:</b> Limits the maximum volume level to 30. (Select if the maximum power of each speaker is less than 50 W to prevent damaging the speakers.) ; <b>HIGH POWER:</b> The maximum volume level is 50.

<b>D.T.EXP</b> (Digital Track Expander)	<b>ON:</b> Creates realistic sound by compensating the high-frequency components and restoring the rise-time of the waveform that are lost in audio data compression. ; <b>OFF:</b> Cancels.
<b>TEL MUTING</b> *8	<b>ON:</b> Mutes the sounds while using the cellular phone (not connected through KS-BTA100). ; <b>OFF:</b> Cancels.
<b>SPK/PRE OUT</b>	Selects the appropriate setting to get the desired output. (See the following table.)

\*4 Displayed only when [SUB.W] is set to [ON].

\*5 Displayed only when [SPK/PRE OUT] is set to [SUB.W/SUB.W].

\*6 Displayed only when [SPK/PRE OUT] is set to [REAR/SUB.W] or [SUB.W/SUB.W].

\*7 This adjustment will not affect the subwoofer output.

\*8 Does not work if [BT ADAPTER] is selected for [AUX] in [SRC SELECT]. (➔ 4)

### SPK/PRE OUT

Setting	Lineout terminal	Rear speaker lead	
	REAR/SW	L (left)	R (right)
<b>REAR/REAR</b>	Rear speakers output	Rear speakers output	Rear speakers output
<b>REAR/SUB.W</b>	Subwoofer output	Rear speakers output	Rear speakers output
<b>SUB.W/SUB.W</b>	Subwoofer output	Subwoofer output	(Mute)

If [SUB.W/SUB.W] is selected:

- [HIGH 120HZ] is selected in [SUB.W LPF] and [THROUGH] is not available.
- [R01] is selected in [FADER] and selectable range is [R06] to [00]

# DISPLAY SETTINGS

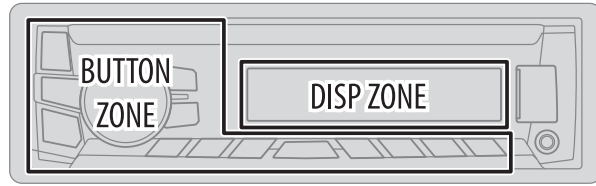

- 1 Press and hold **DISP-SETUP**.
- 2 Turn the volume knob to make a selection (see the following table), then press the knob.
- 3 Repeat step 2 until the desired item is selected/activated or follow the instructions stated on the selected item.
- 4 Press **DISP-SETUP** to exit.

To return to the previous setting item, press **Q/↩**.

Default: **XX**

## DISPLAY

- DIMMER** Selects the display and button illumination adjusted in the **[BRIGHTNESS]** setting.
- OFF:** Selects the day adjustments. ; **ON:** Selects the night adjustments. ;
- DIMMER TIME:** Adjusts the dimmer on and off time.  
Turn the volume knob to adjust the **[ON]** time, then press the knob.  
Turn the volume knob to adjust the **[OFF]** time, then press the knob.  
(Default: **[ON]:** 18:00 or 6:00 PM  
**[OFF]:** 6:00 or 6:00 AM)
- AUTO:** Changes between the day and night adjustments when you turn off or on the car headlights.\*1

**BRIGHTNESS** Sets the button, display and USB input terminal brightness for day and night separately.

- 1 **DAY / NIGHT:** Select day or night.
- 2 Select a zone for setting. (➔ **Illustration on left**)
- 3 Set the brightness level (**00** to **31**). (Default: **DAY: 31** ; **NIGHT: 15**)

**SCROLL**\*2 **ONCE:** Scrolls the display information once. ; **AUTO:** Repeats scrolling at 5-second intervals. ; **OFF:** Cancels.

**[NIGHT COLOR]** or **[DAY COLOR]** is changed by turning on or off your car's headlight.

\*1 The illumination control wire connection is required. (➔ **19**)

\*2 Some characters or symbols will not be shown correctly (or will be blanked).

# MORE INFORMATION

---

## Playable files

- Playable audio file: MP3 (.mp3), WMA (.wma), WAV (.wav), FLAC (.flac)
- Playable USB device file system: FAT12, FAT16, FAT32

Even when audio files comply with the standards listed above, playback may be impossible depending on the types or conditions of media or device.

## About USB devices

- This unit can play MP3/WMA/WAV/FLAC files stored on a USB mass storage class device.
- You cannot connect a USB device via a USB hub.
- Connecting a cable whose total length is longer than 5 m may result in abnormal playback.
- The maximum number of characters for:
  - Folder names: 64 characters
  - File names: 64 characters
  - MP3 Tag: 64 characters
  - WMA Tag: 64 characters
  - WAV Tag: 64 characters
  - FLAC Tag: 64 characters
- This unit can recognize a total of 20 480 files, 999 folders (999 files per folder including folder without unsupported files), and of 8 hierarchies.
- This unit cannot recognize a USB device whose rating is other than 5 V and exceeds 1 A.

## About iPod/iPhone

Made for

- iPod touch (2nd, 3rd, 4th, and 5th generation)
- iPod classic
- iPod nano (3rd, 4th, 5th, 6th, and 7th generation)
- iPhone 3G, 3GS, 4, 4S, 5, 5S, 5C
- It is not possible to browse video files on the "Videos" menu in **[HEAD MODE]**.
- The song order displayed on the selection menu of this unit may differ from that of the iPod/iPhone.
- If some operations are not performed correctly or as intended, visit:  
<<http://www.jvc.net/cs/car/>>.

## About Android device

- This unit supports Android OS 4.1 and above.
- Some Android devices (with OS 4.1 and above) may not fully support Android Open Accessory (AOA) 2.0.
- If the Android device supports both mass storage class device and AOA 2.0, this unit always playback via AOA 2.0 as priority.
- For more information and the latest compatible list, see: <<http://www.jvc.net/cs/car/>>.

## About Pandora

- Pandora is available only in the U.S., Australia and New Zealand.
- Because Pandora is a third-party service, the specifications are subject to change without prior notice. Accordingly, compatibility may be impaired, or some or all of the services may become unavailable.
- Some functions of Pandora cannot be operated from this unit.
- For issues using the application, please contact Pandora at [pandora-support@pandora.com](mailto:pandora-support@pandora.com).

## About iHeartRadio

- iHeartRadio® is a third-party service, therefore the specifications are subject to change without prior notice. Accordingly, compatibility may be impaired or some or all of the services may become unavailable.
- Some iHeartRadio® functionality cannot be operated from this unit.

## About JVC Playlist Creator and JVC Music Control

- This unit supports the PC application JVC Playlist Creator and Android™ application JVC Music Control.
- When you play audio file with song data added using the JVC Playlist Creator or JVC Music Control, you can search for audio file by Genres, Artists, Albums, Playlists, and Songs.
- JVC Playlist Creator and JVC Music Control are available from the following web site:  
<<http://www.jvc.net/cs/car/>>.

## MORE INFORMATION

### Change the display information

Press **DISP-SETUP** repeatedly.

<b>FM or AM</b>	Station name (PS)*1 → Frequency → Program type (PTY)*1*2 → Title*1*2 → Day/Clock → (back to the beginning) *1 For FM Radio Broadcast Data System stations only. *2 If unavailable, "NO PTY" / "NO TEXT" appears.
<b>USB</b>	Playing time → Day/Clock → Album title/Artist*3 → Track title*3 → Folder/file name → (back to the beginning) *3 If not recorded, "NO NAME" appears.
<b>USB-IPOD USB-ANDROID</b>	Playing time → Day/Clock → Album title/Artist*4 → Track title*4 → (back to the beginning) *4 If not recorded, "NO NAME" appears.
<b>PANDORA</b>	Station name → Album title/Artist → Track title → Playing time → Day/Clock → (back to the beginning)
<b>IHEART</b>	Station name → Track title*5 → Track Artist*5 → Day/Clock → (back to the beginning) *5 If unavailable, station name appears.
<b>AUX</b>	AUX ↔ Day/Clock
<b>BT AUDIO</b>	BT AUDIO ↔ Day/Clock

## TROUBLESHOOTING

	Symptom	Remedy
General	Sound cannot be heard.	<ul style="list-style-type: none"> <li>Adjust the volume to the optimum level.</li> <li>Check the cords and connections.</li> </ul>
	"MISWIRING CHECK WIRING THEN PWR ON" appears.	Turn the power off, then check to be sure the terminals of the speaker wires are insulated properly. Turn the power on again.
	"PROTECTING SEND SERVICE" appears.	Send the unit to the nearest service center.
Radio	Source cannot be selected.	Check the [SRC SELECT] setting. (→ 4)
	<ul style="list-style-type: none"> <li>Radio reception is poor.</li> <li>Static noise while listening to the radio.</li> </ul>	<ul style="list-style-type: none"> <li>Connect the antenna firmly.</li> <li>Pull the antenna out all the way.</li> </ul>
	Playback order is not as intended.	The playback order is determined by the file name (USB).
USB / iPod	Elapsed playing time is not correct.	This depends on the recording process earlier.
	"NOT SUPPORT" appears and file skips.	Check whether the file is a playable format. (→ 14)
	"READING" keeps flashing.	<ul style="list-style-type: none"> <li>Do not use too many hierarchical levels and folders.</li> <li>Reattach the USB device.</li> </ul>
	"CANNOT PLAY" flashes and/or connected device cannot be detected.	<ul style="list-style-type: none"> <li>Check whether the connected device is compatible with this unit and ensure the files are in supported formats. (→ 14)</li> <li>Reattach the device.</li> </ul>
	The iPod/iPhone does not turn on or does not work.	<ul style="list-style-type: none"> <li>Check the connection between this unit and iPod/iPhone.</li> <li>Detach and reset the iPod/iPhone using hard reset.</li> </ul>
	Correct characters are not displayed.	This unit can only display uppercase letters, numbers, and a limited number of symbols.

## TROUBLESHOOTING

	Symptom	Remedy
ANDROID	<ul style="list-style-type: none"> <li>• Sound cannot be heard during playback.</li> <li>• Sound output only from the Android device.</li> </ul>	<ul style="list-style-type: none"> <li>• Reconnect the Android device.</li> <li>• If in [AUDIO MODE], launch any media player application on the Android device and start playback.</li> <li>• If in [AUDIO MODE], relaunch the current media player application or use another media player application.</li> <li>• Restart the Android device.</li> <li>• If this does not solve the problem, the connected Android device is unable to route the audio signal to unit. (➔ 14)</li> </ul>
	Cannot playback at [AUTO MODE].	<ul style="list-style-type: none"> <li>• Make sure JVC MUSIC PLAY APP is installed on the Android device. (➔ 5)</li> <li>• Reconnect the Android device and select the appropriate control mode. (➔ 6)</li> <li>• If this does not solve the problem, the connected Android device does not support [AUTO MODE]. (➔ 14)</li> </ul>
	"NO DEVICE" or "READING" keeps flashing.	<ul style="list-style-type: none"> <li>• Switch off the developer options on the Android device.</li> <li>• Reconnect the Android device.</li> <li>• If this does not solve the problem, the connected Android device does not support [AUTO MODE]. (➔ 14)</li> </ul>
	Playback is intermittent or sound skips.	Turn off the power saving mode on the Android device.
	"CANNOT PLAY"	<ul style="list-style-type: none"> <li>• Make sure Android device contains playable audio files.</li> <li>• Reconnect the Android device.</li> <li>• Restart the Android device.</li> </ul>
	"ADD ERROR" "SEARCH ERR"	New station creation is unsuccessful.
Pandora	"CHK DEVICE"	Check the Pandora application on your device.
	"NO SKIPS"	The skip limit has been reached.
	"NO STATIONS"	No stations are found.
	"STATION LMT"	The number of registered stations has reached its limit. Retry after deleting unnecessary stations from your device.
	"UPGRADE APP"	Make sure you have installed the latest version of the Pandora application on your device.

	Symptom	Remedy
Pandora	"CONNECT ERR"	Communication is unstable.
	"RATING ERR"	Registration of thumbs up/thumbs down has failed.
	"LICENSE ERR"	You try to access from a country which Pandora is not deliverable.
iHeartRadio	Station cannot be selected.	If "Explicit Content" in [Account Settings] is checked in the web version of iHeartRADIO, custom stations become unavailable.
	"CREATE ERR"	Custom station name creation is unsuccessful.
	"SAVE ERROR"	Addition to the favorite category failed.
	"DISCONNECTED"	Check the connection to the device.
	"NO SKIPS"	The skip limit has been reached. Retry later.
	"NO STATIONS"	No stations are found.
	"NOT CONNCTD"	Link to the application is impossible.
	"UPDATE APP"	Make sure you have installed the latest version of the iHeart Link for JVC application on your device.
	"PLS LOGIN"	You haven't log in. Log in again.
	"STATION NOT AVAILABLE"	Broadcast from the station is over.
	"STATION NOT SELECTED"	No station is selected.
"STREAM ERR"	Broadcast data is interrupted.	
"THUMBS ERR"	Registration of Thumbs Up/Down has failed.	
"TIMED OUT"	The request has resulted in time-out.	

### If you have any troubles, try the following:

**1 Check TROUBLESHOOTING**

**2 Reset the unit (➔ 3)**

**3 Contact (USA only)**

**Call: 1-800-252-5722 ( or ) visit: <http://www.jvc.com>**



# SPECIFICATIONS

Tuner	FM	Frequency Range	87.9 MHz — 107.9 MHz (200 kHz step) 87.5 MHz — 108.0 MHz (50 kHz step)
		Channel Space Selection	50 kHz/200 kHz
	Usable Sensitivity (S/N = 26 dB)	8.2 dBf (0.71 $\mu$ V/75 $\Omega$ )	
	Quieting Sensitivity (DIN S/N = 46 dB)	17.2 dBf (2.0 $\mu$ V/75 $\Omega$ )	
	Frequency Response ( $\pm$ 3 dB)	30 Hz — 15 kHz	
	Signal-to-Noise Ratio (MONO)	64 dB	
	Stereo Separation (1 kHz)	40 dB	
AM	Frequency Range	530 kHz — 1 700 kHz (10 kHz step) 531 kHz — 1 611 kHz (9 kHz step)	
	Channel Space Selection	9 kHz/10 kHz	
	Usable Sensitivity (S/N = 20 dB)	29 dB $\mu$ (28.2 $\mu$ V)	
USB	USB Standard	USB 1.1, USB 2.0 (Full speed)	
	Compatible Devices	Mass storage class	
	File System	FAT12/ 16/ 32	
	Maximum Supply Current	DC 5 V $\equiv$ 1 A	
	D/A Converter	24 Bit	
	Frequency Response ( $\pm$ 1 dB)	20 Hz — 20 kHz	
	Signal-to-Noise Ratio (1 kHz)	105 dB	
	Dynamic Range	88 dB	
	Channel Separation	90 dB	
	MP3 Decode	Compliant with MPEG-1/2 Audio Layer-3	
	WMA Decode	Compliant with Windows Media Audio	
	WAV Decode	RIFF waveform Audio Format (Linear PCM only)	
	FLAC Decode	FLAC files	

Auxiliary	Frequency Response ( $\pm$ 3 dB)	20 Hz — 20 kHz
	Input Maximum Voltage	1 000 mV
	Input Impedance	30 k $\Omega$
Audio	Maximum Output Power	50 W $\times$ 4 or 50 W $\times$ 2 + 50 W $\times$ 1 (Subwoofer = 4 $\Omega$ )
	Full Bandwidth Power (at less than 1 % THD)	22 W $\times$ 4
	Speaker Impedance	4 $\Omega$ — 8 $\Omega$
	Preout Level/Load (USB)	2 500 mV/10 k $\Omega$
	Preout Impedance	$\leq$ 600 $\Omega$
General	Operating Voltage (10.5 V — 16 V allowable)	14.4 V
	Maximum Current Consumption	10 A
	Operating Temperature Range	0°C to +40°C
	Installation Size (W $\times$ H $\times$ D)	182 mm $\times$ 53 mm $\times$ 108 mm (7-3/16" $\times$ 2-1/8" $\times$ 4-5/16")
	Weight	0.58 kg (1.3 lbs)

Subject to change without notice.

**⚠ Warning**

- The unit can only be used with a 12 V DC power supply, negative ground.
- Disconnect the battery's negative terminal before wiring and mounting.
- Do not connect Battery wire (yellow) and Ignition wire (red) to the car chassis or Ground wire (black) to prevent a short circuit.
- Insulate unconnected wires with vinyl tape to prevent a short circuit.
- Be sure to ground this unit to the car's chassis again after installation.

**⚠ Caution**

- For safety's sake, leave wiring and mounting to professionals. Consult the car audio dealer.
- Install this unit in the console of your vehicle. Do not touch the metal parts of this unit during and shortly after use of the unit. Metal parts such as the heat sink and enclosure become hot.
- Do not connect the ⊖ wires of speakers to the car chassis or Ground wire (black), or connect them in parallel.
- Connect speakers with a maximum power of more than 50 W. If the maximum power of the speakers is lower than 50 W, change the [AMP GAIN] setting to avoid damaging the speakers. (→ 12)
- Mount the unit at an angle of less than 30°.
- If your vehicle wiring harness does not have the ignition terminal, connect Ignition wire (red) to the terminal on the vehicle's fuse box which provides 12 V DC power supply and is turned on and off by the ignition key.
- Keep all cables away from heat dissipate metal parts.
- After the unit is installed, check whether the brake lamps, blinkers, wipers, etc. on the car are working properly.
- If the fuse blows, first make sure the wires are not touching car's chassis, then replace the old fuse with one that has the same rating.

**Basic procedure**

- 1 Remove the key from the ignition switch, then disconnect the ⊖ terminal of the car battery.**
- 2 Connect the wires properly.**  
See Wiring connection. (→ 19)
- 3 Install the unit to your car.**  
See Installing the unit (in-dash mounting).
- 4 Connect the ⊖ terminal of the car battery.**
- 5 Reset the unit. (→ 3)**

**Installing the unit (in-dash mounting)**

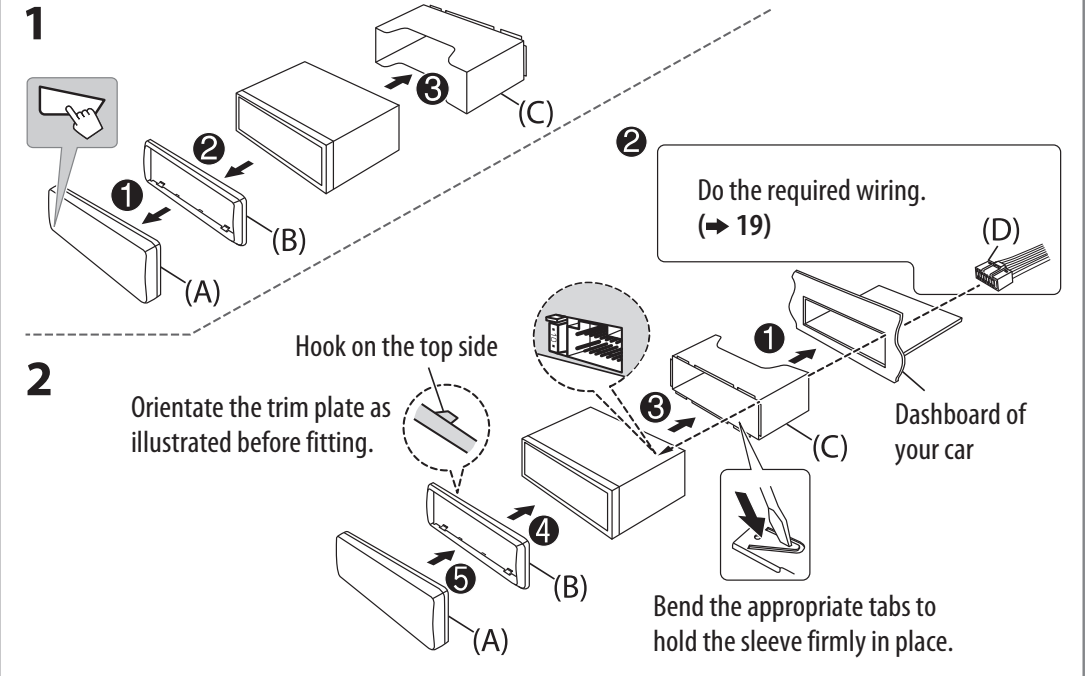

**When installing without the mounting sleeve**

**⚠ Use only the specified screws. Using wrong screws might damage the unit.**

Flat or round head screws  
(not supplied)  
M5 × 8 mm (M5 × 3/8")

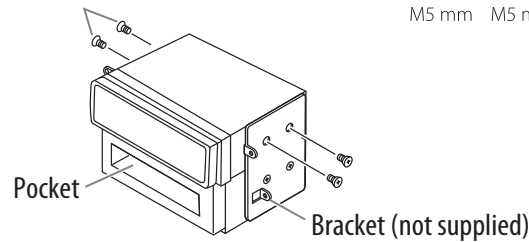
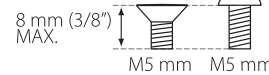

**How to remove the unit**

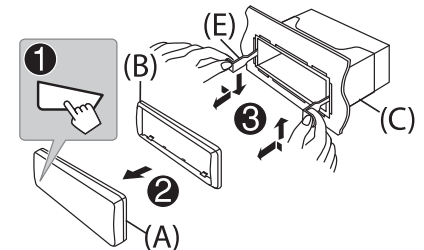

## Wiring connection

\*1 Firmly connect the ground wire of the amplifier to the car's chassis to avoid damaging the unit.

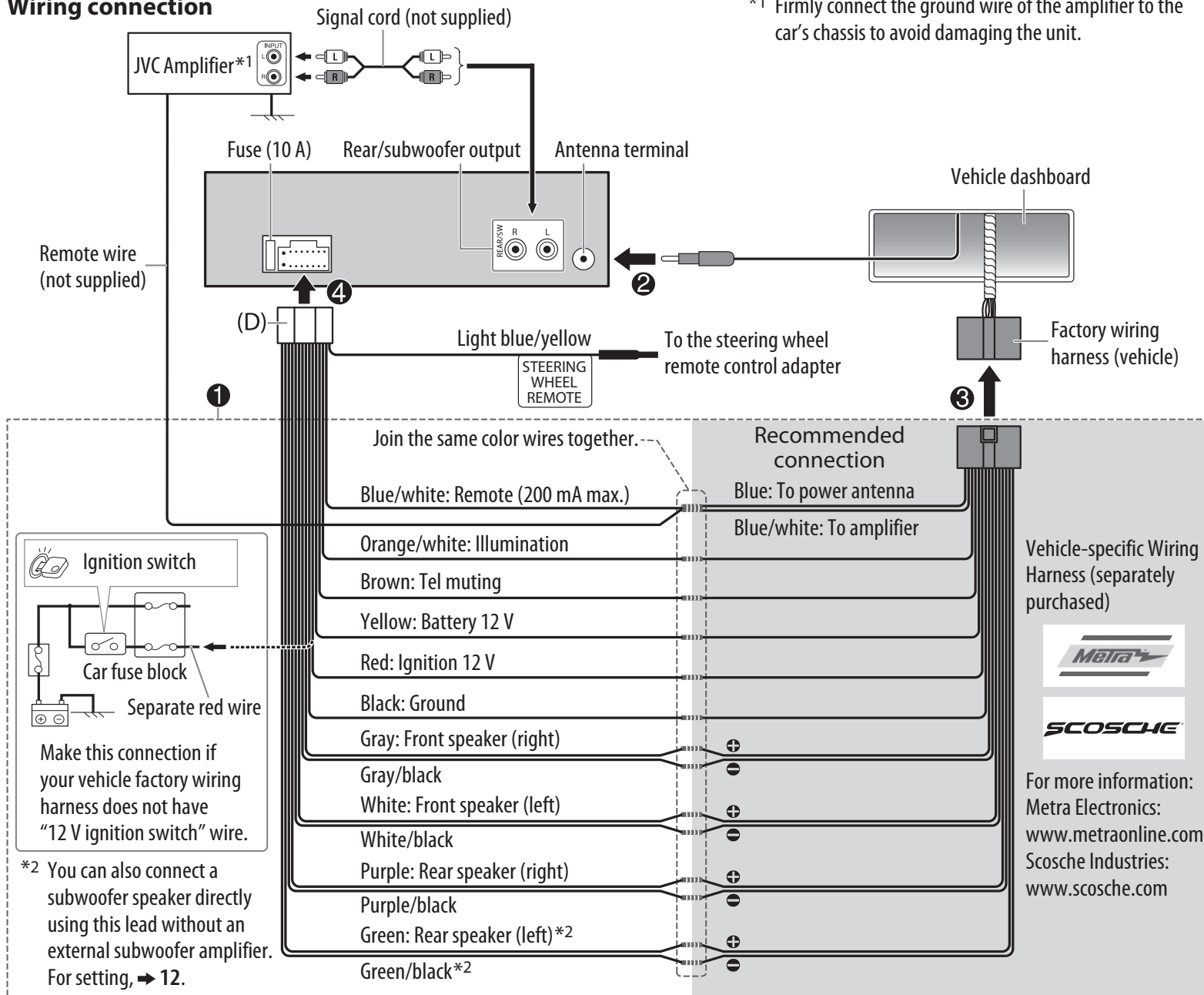

## Part list for installation

### (A) Faceplate

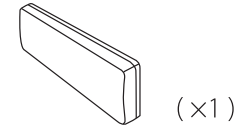

### (B) Trim plate

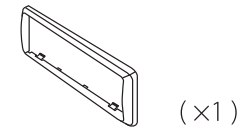

### (C) Mounting sleeve

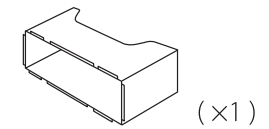

### (D) Wiring harness

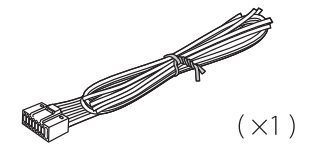

### (E) Extraction key

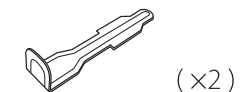

### FCC WARNING

This equipment may generate or use radio frequency energy. Changes or modifications to this equipment may cause harmful interference unless the modifications are expressly approved in the instruction manual. The user could lose the authority to operate this equipment if an unauthorized change or modification is made.

### FCC NOTE

This equipment has been tested and found to comply with the limits for a Class B digital device, pursuant to Part 15 of the FCC Rules. These limits are designed to provide reasonable protection against harmful interference in a residential installation. This equipment may cause harmful interference to radio communications, if it is not installed and used in accordance with the instructions. However, there is no guarantee that interference will not occur in a particular installation. If this equipment does cause harmful interference to radio or television reception, which can be determined by turning the equipment off and on, the user is encouraged to try to correct the interference by one or more of the following measures:

- Reorient or relocate the receiving antenna.
- Increase the separation between the equipment and receiver.
- Connect the equipment into an outlet on a circuit different from that to which the receiver is connected.
- Consult the dealer or an experienced radio/TV technician for help.

### Información acerca de la eliminación de equipos eléctricos y electrónicos al final de la vida útil (aplicable a los países que hayan adoptado sistemas independientes de recogida de residuos)



Los productos con el símbolo de un contenedor con ruedas tachado no podrán ser desechados como residuos domésticos. Los equipos eléctricos y electrónicos al final de la vida útil, deberán ser reciclados en instalaciones que puedan dar el tratamiento adecuado a estos productos y a sus subproductos residuales correspondientes. Póngase en contacto con su administración local para obtener información sobre el punto de recogida más cercano. Un tratamiento correcto del reciclaje y la eliminación de residuos ayuda a conservar los recursos y evita al mismo tiempo efectos perjudiciales en la salud y el medio ambiente.

### Informação sobre a eliminação de pilhas

Este produto não deve ser eliminado como lixo doméstico geral. Devolva a pilha usada ao revendedor ou entidade autorizada para que a mesma seja devolvida ao fabricante ou importador.

A reciclagem e a eliminação de lixo de maneira apropriada ajudarão a conservar os recursos naturais ao mesmo tempo que prevenirão os efeitos prejudiciais à nossa saúde e ao meio ambiente.

### CALIFORNIA, USA ONLY

This product contains a CR Coin Cell Lithium Battery which contains Perchlorate Material—special handling may apply. See [www.dtsc.ca.gov/hazardouswaste/perchlorate](http://www.dtsc.ca.gov/hazardouswaste/perchlorate)

### libFLAC

Copyright (C) 2000,2001,2002,2003,2004,2005,2006,2007,2008,2009 Josh Coalson  
Redistribution and use in source and binary forms, with or without modification, are permitted provided that the following conditions are met:

- Redistributions of source code must retain the above copyright notice, this list of conditions and the following disclaimer.
- Redistributions in binary form must reproduce the above copyright notice, this list of conditions and the following disclaimer in the documentation and/or other materials provided with the distribution.
- Neither the name of the Xiph.org Foundation nor the names of its contributors may be used to endorse or promote products derived from this software without specific prior written permission.

THIS SOFTWARE IS PROVIDED BY THE COPYRIGHT HOLDERS AND ONTRIBUTORS "AS IS" AND ANY EXPRESS OR IMPLIED WARRANTIES, INCLUDING, BUT NOT LIMITED TO, THE IMPLIED WARRANTIES OF MERCHANTABILITY AND FITNESS FOR A PARTICULAR PURPOSE ARE DISCLAIMED. IN NO EVENT SHALL THE FOUNDATION OR CONTRIBUTORS BE LIABLE FOR ANY DIRECT, INDIRECT, INCIDENTAL, SPECIAL, EXEMPLARY, OR CONSEQUENTIAL DAMAGES (INCLUDING, BUT NOT LIMITED TO, PROCUREMENT OF SUBSTITUTE GOODS OR SERVICES; LOSS OF USE, DATA, OR PROFITS; OR BUSINESS INTERRUPTION) HOWEVER CAUSED AND ON ANY THEORY OF LIABILITY, WHETHER IN CONTRACT, STRICT LIABILITY, OR TORT (INCLUDING NEGLIGENCE OR OTHERWISE) ARISING IN ANY WAY OUT OF THE USE OF THIS SOFTWARE, EVEN IF ADVISED OF THE POSSIBILITY OF SUCH DAMAGE.

- Microsoft and Windows Media are either registered trademarks or trademarks of Microsoft Corporation in the United States and/or other countries.
- "Made for iPod," and "Made for iPhone" mean that an electronic accessory has been designed to connect specifically to iPod, or iPhone, respectively, and has been certified by the developer to meet Apple performance standards. Apple is not responsible for the operation of this device or its compliance with safety and regulatory standards. Please note that the use of this accessory with iPod or iPhone may affect wireless performance.
- iPhone, iPod, iPod classic, iPod nano, and iPod touch are trademarks of Apple Inc., registered in the U.S. and other countries.
- Lightning is a trademark of Apple Inc.
- Pandora, the Pandora logo, and the Pandora trade dress are trademarks or registered trademarks of Pandora Media, Inc., used with permission.
- iHeartRadio® is a registered mark of Clear Channel Broadcasting, Inc. in the United States and other countries. Such marks are used under license.
- Android is trademark of Google Inc.

WHEN IT IS NOT REQUIRED  
TO DETACH THE FRONT CONTROL  
PANEL FROM THE MAIN UNIT,  
USE THE PROVIDED SCREW TO  
ATTACH THE CONTROL PANEL TO  
THE MAIN UNIT.

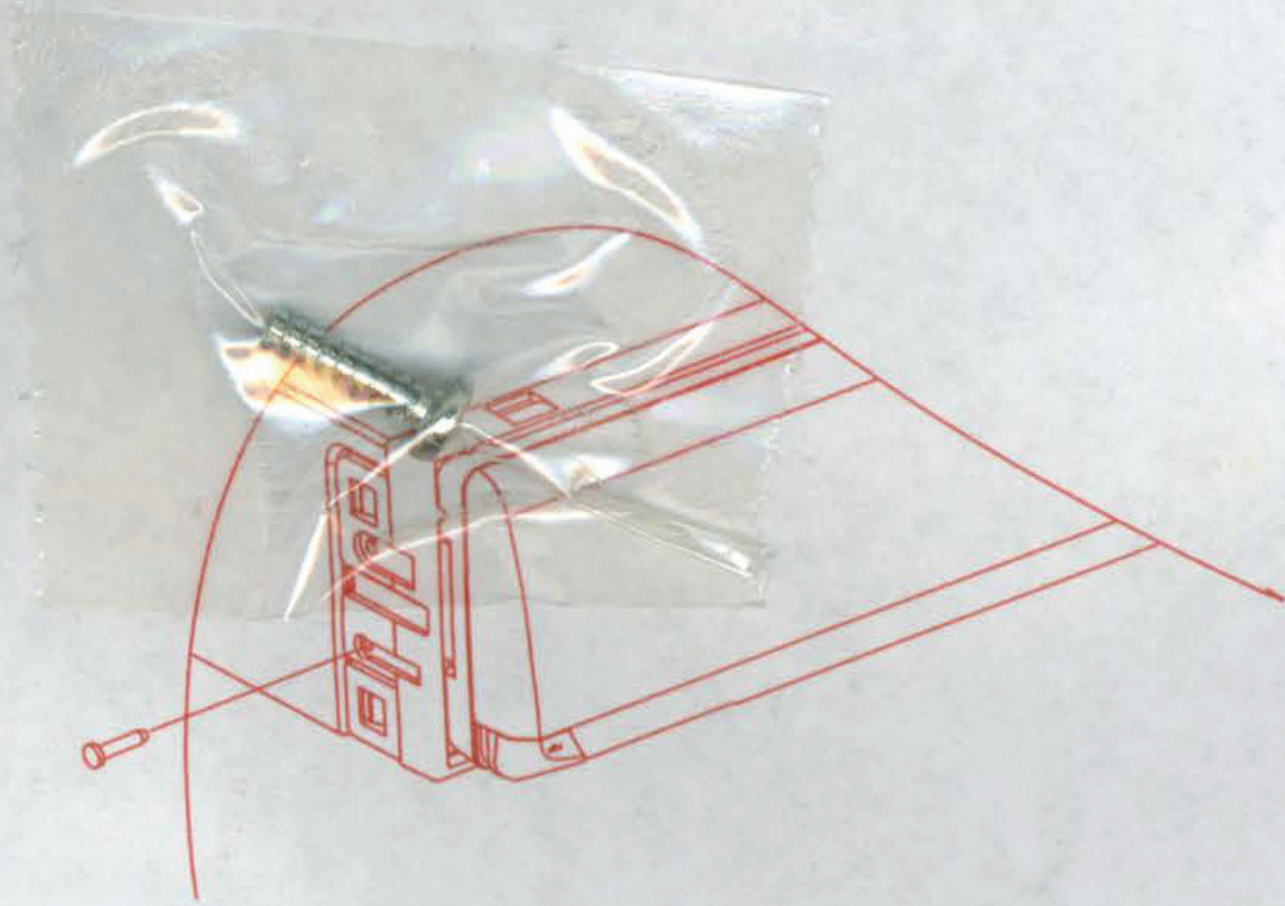

GE40401-001A

REMOVE THIS LABEL FROM CABLE BEFORE USE.  
RETIRE LA ÉTIQUETA DEL CABLE ELÉCTRICO ANTES DE USAR.  
RETIREZ CETTE ÉTIQUETTE DU CÂBLE AVANT UTILISATION.



# CAUTION

CONNECT BLACK WIRE (① GND) TO GROUND FIRST. OTHERWISE, DAMAGE TO YOUR UNIT MAY OCCUR.

INCORRECT CONNECTION CAUSES SERIOUS DAMAGE TO THIS UNIT  
PLEASE READ INSTALLATION/CONNECTION MANUAL CAREFULLY.

①

CONNECT GROUND FIRST

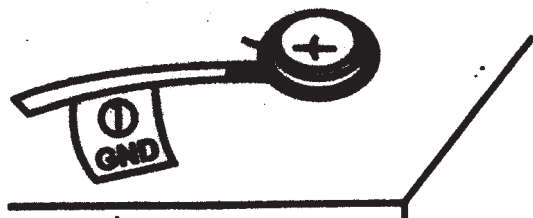

METALLIC BODY OR CHASSIS  
OF THE CAR

②

CONNECT OTHER WIRES

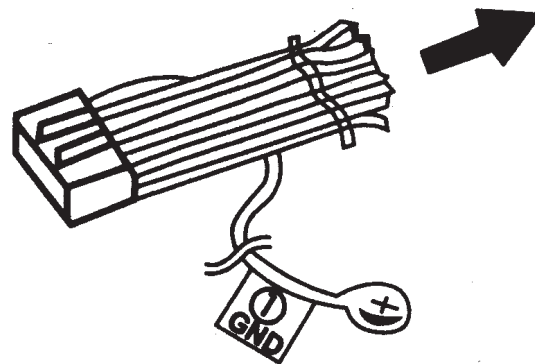

③

CONNECT ANTENNA TERMINAL

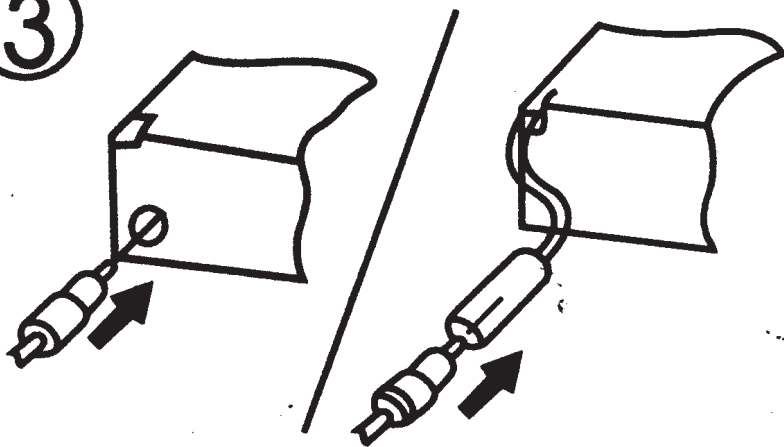

④

CONNECT POWER CORD TO  
THE UNIT

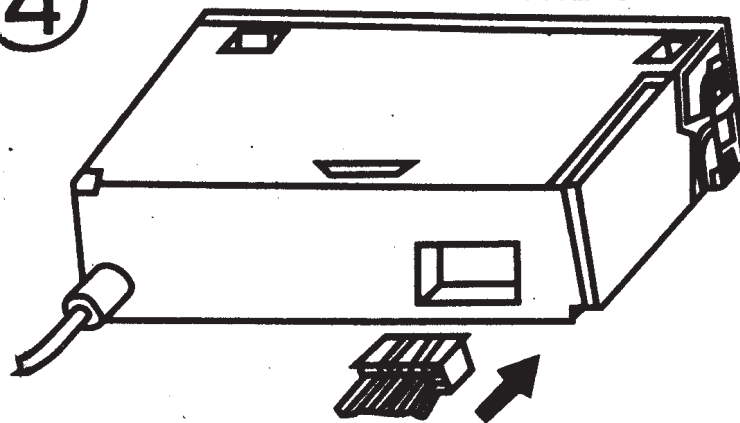

## TO OUR VALUED CUSTOMER

THANK YOU FOR PURCHASING THIS JVC PRODUCT.  
WE WANT TO HELP YOU ACHIEVE A PERFECT EXPERIENCE.

**NEED HELP ON HOW TO HOOK UP?  
NEED ASSISTANCE ON HOW TO OPERATE?  
NEED TO LOCATE A JVC SERVICE CENTER?  
LIKE TO PURCHASE ACCESSORIES?**

**JVC IS HERE TO HELP!**  
**TOLL FREE: 1 (800)252-5722**  
**<http://www.jvc.com>**

Remember to retain your Bill of Sale for Warranty Service.

**Do not attempt to service the product yourself**

### Caution

To prevent electrical shock, do not open the cabinet.  
There are no user serviceable parts inside.  
Please refer to qualified service personnel for repairs.

### PRODUCT REGISTRATION

We suggest that you register your product since it will enable us to contact you directly if it is ever necessary to correct a safety related condition in your product. You can register at [www.register.jvc.com](http://www.register.jvc.com). Please note that failure to register does not diminish any of your rights during the warranty period.

# JVC

## LIMITED WARRANTY

ONLY FOR PRODUCT PURCHASED IN U.S.A.

JVC Americas Corp. (JVC) warrants this product and all parts thereof, except as set forth below ONLY TO THE ORIGINAL RETAIL PURCHASER to be FREE FROM DEFECTIVE MATERIALS AND WORKMANSHIP from the date of original purchase for the period shown below. ("The Warranty Period")

PARTS 2 YRS / LABOR 2 YRS : Car audio ARSENAL series

PARTS 1 YR / LABOR 1 YR : All other car audio products

**THIS LIMITED WARRANTY IS VALID ONLY IN THE FIFTY (50) UNITED STATES, THE DISTRICT OF COLUMBIA AND IN THE COMMONWEALTH OF PUERTO RICO.**

### WHAT WE WILL DO:

If this product is found to be defective within the warranty period, JVC will repair or replace defective parts with new or rebuilt equivalents at no charge to the original owner. Such repair and replacement services shall be rendered by JVC during normal business hours at JVC authorized service centers. Parts used for replacement are warranted only for the remainder of the Warranty Period. All products may be brought to a JVC authorized service center on a carry-in basis. Color televisions with a screen size of 37" class or greater qualify for in-home service. In such cases, a technician will come to your home and either repair the TV there or remove and return it if it cannot be repaired in your home.

### WHAT YOU MUST DO FOR WARRANTY SERVICE:

Please do not return your product to the retailer. Instead, return your product to the JVC authorized service center nearest you. If shipping the product to the service center, please be sure to package it carefully, preferably in the original packaging, and include a brief description of the problem(s) and a copy of the proof of purchase to verify purchase date. Please call 1-800-252-5722 to locate the nearest JVC authorized service center. Service locations can also be obtained from our website <http://www.jvc.com>. If your product qualifies for in-home service, the service representative will require clear access to the product.

If you have any questions concerning your JVC Product, please contact our Customer Care Center at 800-252-5722

### WHAT IS NOT COVERED:

This limited warranty provided by JVC does not cover:

1. Products which have been subject to abuse, accident, alteration, modification, tampering, negligence, misuse, faulty installation, lack of reasonable care, or if repaired or serviced by anyone other than a service facility authorized by JVC to render such service, or if affixed to any attachment not provided with the products, or if the model or serial number has been altered, tampered with, defaced or removed;
2. Initial installation, installation and removal from cabinets or mounting systems.
3. Operational adjustments covered in the Owner's Manual, normal maintenance, video and audio head cleaning;
4. Damage that occurs in shipment, due to act of God, and cosmetic damage;
5. Signal reception problems and failures due to line power surge;
6. User Removal Memory Devices/Video Pick-up Tubes/CCD Image Sensors are covered for 90 days from the date of purchase;
7. Accessories;
8. Batteries (except that Rechargeable Batteries are covered for 90 days from the date of purchase);
9. Products used for commercial purposes, including, but not limited to rental.
10. Loss of data resultant from malfunction of hard drive or other data storage device;

There are no express warranties except as listed above.

THE DURATION OF ANY IMPLIED WARRANTIES, INCLUDING THE IMPLIED WARRANTY OF MERCHANTABILITY, IS LIMITED TO THE DURATION OF THE EXPRESS WARRANTY HEREIN. JVC SHALL NOT BE LIABLE FOR ANY LOSS OF USE OF THE PRODUCT, INCONVENIENCE, OR ANY OTHER DAMAGES, WHETHER DIRECT, INCIDENTAL OR CONSEQUENTIAL (INCLUDING, WITHOUT LIMITATION, DAMAGE TO TAPES, RECORDS OR DISCS) RESULTING FROM THE USE OF THIS PRODUCT, OR ARISING OUT OF ANY BREACH OF THIS WARRANTY. ALL EXPRESS AND IMPLIED WARRANTIES, INCLUDING THE WARRANTIES OF MERCHANTABILITY AND FITNESS FOR PARTICULAR PURPOSE, ARE LIMITED TO THE WARRANTY PERIOD SET FORTH ABOVE.

Some states do not allow the exclusion of incidental or consequential damages or limitations on how long an implied warranty lasts, so these limitations or exclusions may not apply to you. This warranty gives you specific legal rights and you may also have other rights which vary from state to state.

### JVC AMERICAS CORP.

1700 Valley Road, Wayne, New Jersey 07470

<http://www.jvc.com>

REFURBISHED PRODUCTS CARRY A SEPARATE WARRANTY, THIS WARRANTY DOES NOT APPLY. FOR DETAIL OF REFURBISHED PRODUCT WARRANTY, PLEASE REFER TO THE REFURBISHED PRODUCT WARRANTY INFORMATION PACKAGED WITH EACH REFURBISHED PRODUCT.

### For customer use:

Enter below the Model No. and Serial No. which is located either on the rear, bottom or side of the cabinet. Retain this information for future reference.

Model No. \_\_\_\_\_

Serial No. \_\_\_\_\_

Purchase date: \_\_\_\_\_

Name of dealer: \_\_\_\_\_



## WARRANTY

Warranty applies only to PRODUCT distributed in Canada by JVC Canada Inc.

JVC CANADA INC. (hereafter called "JVC") gives the following express warranty for each new JVC product distributed in Canada by JVC and sold by an authorized JVC dealer. JVC warrants that this JVC product is free, under normal use and maintenance, from any defects in material and workmanship subject to the following terms and conditions:

### 1. To Obtain Warranty Service:

- JVC product requiring service must be presented together with proof of purchase.
- The JVC product must be brought in for service to an authorized JVC Service Centre.

### 2. Limitation:

This Warranty shall not apply to:

- Repair or replacement of any cabinets, batteries, plates, connection cords, antennas, dust covers, knobs, speaker grills, speaker cones, projection screens, projection screen savers, and all accessories.
  - Any defects caused or repairs required as a result of misuse, abusive operation, negligence, improper use and/or insufficient care.
  - Any defect caused or repairs required as a result of not following the instructions in the operation manual.
  - Any JVC product tampered with, adjusted or repaired by any party other than JVC or authorized JVC Service Centre personnel.
  - Any JVC products on which the serial number has been defaced, modified or removed.
  - Maintenance, cleaning or periodic check-up
  - Conversion to foreign or domestic voltage or frequency.
  - Any JVC product without the Canadian Electrical Safety Regulations ID.
  - Any JVC products used for commercial or institutional, rental, or display purposes.  
Parts ..... 1 year (except video head - 90 days)  
Labour ... 90 days
  - Any JVC product which has been resold and no longer owned by the original purchaser.
  - Product purchased from "outside Canada", "bankruptcy" or "liquidator".
  - Any defects caused by fire, flood, lightning, power surge, or other events beyond the control of JVC.
- (m) FOR AUTO PRODUCTS**  
Warranty does not cover elimination of car static or electrical interferences, cleaning of head, adjustments, or labour cost for the removal or reinstallation of the unit for repair.

### 3. Standards:

If any defects should be found in a JVC product within the applicable terms, necessary repairs shall be made at no cost to the purchaser for parts or labour when JVC acknowledges that such defects are due to faulty material or workmanship.

### 4. Exclusion of All Other Express Warranties:

This warranty constitutes the entire express warranty given by JVC for JVC products and no dealer or service centre personnel or his, its or their agent or employee is, or are authorized to extend or enlarge this warranty on behalf of JVC.

### 5. Disclaimer of Consequential Damage:

To the extent the law permits JVC disclaims any responsibility for loss of time or use of its product, transportation costs, or any other indirect, incidental or consequential damage or inconvenience.

### WARRANTY TERM (VALID FROM THE DATE OF PURCHASE)

Product	Parts (Years)	Labour (Years)
Projection TV In-Home Service Colour TV In-Home (25" and above) D-ILA Rear Projection In-Home Service LCD TV In-Home Service (25" and above)	1	1
* In-Home service to be provided where available. Where it is not available, the purchaser must assume the responsibility and expense for the proper packing, shipment and all costs associated with the delivery of the equipment to and from the closest JVC Authorized Service Centre.		
Receivers and Home Speakers purchased separately. Front Projection and Car Audio "ARSENAL" Series	2	2
AC Adapters, Remote controls, Headphones, Microphones and Projector lamps	90 days	90 days
Wood Cone Speakers	5	5
All Other Categories	1	1

### JVC CANADA INC.

6070 kestrel Road, Mississauga, Ontario, L5T 1 S8 Canada  
TEL: (905) 670-3381 FAX: (905)670-7244 Service toll free #: 1-800-964-2650  
<http://www.jvc.ca> E-mail: [service@jvc.ca](mailto:service@jvc.ca)

### Product Registration

We suggest that you register your product since it will enable us to contact you directly if it is ever necessary to correct a safety related condition in your product. You can register at <http://www.jvc.ca/www/Support/Warranty.aspx>

### For customer use:

Enter below the Model No. and Serial No. which is located either on the rear, bottom or side of the cabinet. Retain this information for future reference.

Model No.: \_\_\_\_\_ Serial No.: \_\_\_\_\_  
Purchase date: \_\_\_\_\_ Name of dealer: \_\_\_\_\_

## GARANTIE

La garantie s'applique seulement aux PRODUITS distribués au Canada par JVC Canada Inc.

JVC CANADA INC. (ci-après appelé "JVC") énonce la garantie expresse suivante pour tout nouveau produit JVC distribué au Canada par JVC et vendu par un détaillant JVC autorisé. JVC vous garantit que ce produit est dégage, sous utilisation et entretien normal, de tout défaut matériel et de fabrication sous réserve des modalités et conditions suivantes:

### 1. Pour obtenir un service de garantie:

- Les produits JVC nécessitant un service doit être présentée avec la preuve d'achat.
- Le produit JVC doit être apporté pour service chez un centre de service JVC autorisé.

### 2. Restrictions:

Cette garantie ne s'applique pas aux:

- Réparation ou remplacement de tout cabinet, batteries, panneau avant, cordons de raccord, antennes, housses de protection, boutons, couverts de hautparleur, cônes de hautparleur, écrans de projection, protecteurs d'écran de projection et tous les accessoires.
- Tous défauts occasionnés ou réparations requises suite à une utilisation abusive, mauvaise, négligente et/ou une utilisation incorrecte.
- Tous défauts occasionnés ou réparations requises suite à l'omission de suivre les recommandations du manuel d'instruction.
- Tout produit JVC altéré, ajusté ou réparé par tout autre entreprise que JVC ou un centre de service d'entretien ou de service autorisé JVC.
- Tout produit JVC dont le numéro de série a été altéré, modifié ou enlevé.
- L'entretien, les vérifications périodiques et nettoyage.
- La conversion à une fréquence ou une tension étrangère ou domestique.
- Tout produit JVC n'ayant pas le signe d'identification qui conforme aux normes électriques Canadiennes (CSA).
- Pour tout produit utilisé à des fins commerciales, institutionnelles, de location ou utilisé à des fins d'étalage.  
Pièces ..... 1 An (Excepté les têtes vidéo- 90 jours)  
Main d'oeuvre ... 90 Jours
- Tout produit JVC ayant été revendu et qui n'est plus la propriété de l'acheteur original.
- Produit acheté à "l'extérieur du Canada", provenant d'une "faillite" ou d'un "liquidateur".
- Tout dommage causé par le feu, une inondation, un éclair, une surtension ou tout autre événement hors du contrôle de JVC.

### (m) POUR LES PRODUITS D'AUTOMOBILE

La garantie ne couvre pas l'élimination d'interférences statiques ou électriques de la voiture, le nettoyage de tête, les ajustements et les coûts de main d'œuvre associés à l'enlèvement ou à la réinstallation de l'unité pour réparation.

### 3. Critères:

Si un produit JVC s'avérait défectueux, selon les conditions applicables, les réparations nécessaires seront effectués sans coûts additionnels à l'acheteur pour les pièces et la main d'œuvre lorsque JVC reconnaît que de tels défauts sont causés par une défectuosité de matériel ou de fabrication.

### 4. Exclusion de toutes autres garanties expresses :

Cette garantie constitue l'entière garantie expresse donnée par JVC pour les produits JVC. Nul représentant ou employé d'un détaillant ou d'un service d'entretien n'est autorisé à prolonger cette garantie au nom de JVC.

### 5. Dénégation des dommages indirects:

Dans la mesure permise par la loi, JVC nie toute responsabilité pour perte de temps ou d'usage de ses produits, des coûts de transport ou tout autre dommage ou inconvénient indirect, accidentel et conséquent.

### CONDITIONS DE GARANTIE (VALABLE À PARTIR DE LA DATE D'ACHAT)

Produit	Pièces (Années)	Main-D'oeuvre (Années)
Écrans de projection Service à Domicile Écrans de TV Couleur Service à Domicile (25" et plus) TV projection arrière D-ILA Service à Domicile Écrans de LCD Service à Domicile (25" et plus)	1	1
* Service à domicile fourni par un détaillant disponible. S'il n'y a pas de service JVC disponible à proximité, l'acheteur doit assumer la responsabilité et les coûts pour un emballage adéquat, l'expédition, ainsi que tous les coûts associés à la livraison de l'équipement chez et depuis le détaillant JVC autorisé le plus près pour un service d'entretien.		
Récepteurs et Hauts-Parleurs achetés séparément, Projecteur Avant et Audio d'Auto de Série "ARSENAL"	2	2
Adaptateurs AC, Télécommande, Casque D'écoute, Microphones et Lampe de Projecteur	90 Jours	90 Jours
Enceinte à Cône en Bois	5	5
Toutes les autres catégories	1	1

### JVC CANADA INC.

6070 kestrel Road, Mississauga, Ontario, L5T 1 S8 Canada  
TEL: (905) 670-3381 FAX: (905)670-7244 Service toll free #: 1-800-964-2650  
<http://www.jvc.ca> E-mail: [service@jvc.ca](mailto:service@jvc.ca)

### Enregistrement du produit

Nous vous conseillons d'enregistrer votre produit, car il nous permettra de vous contacter directement si jamais elle est nécessaire pour corriger un problème lié à la sécurité de votre produit. Vous pouvez vous inscrire à <http://www.jvc.ca/www/Support/Warranty.aspx>

### Pour l'utilisation des clients:

Entrez ci-dessous le numéro de modèle et le numéro de série qui se trouve soit à l'arrière, en bas ou sur le côté de l'armoire. Conservez ces informations pour référence future.

No. de modèle: \_\_\_\_\_ No. de série: \_\_\_\_\_  
Date d'achat: \_\_\_\_\_ Nom du revendeur: \_\_\_\_\_



## Free Manuals Download Website

<http://myh66.com>

<http://usermanuals.us>

<http://www.somanuals.com>

<http://www.4manuals.cc>

<http://www.manual-lib.com>

<http://www.404manual.com>

<http://www.luxmanual.com>

<http://aubethermostatmanual.com>

Golf course search by state

<http://golfingnear.com>

Email search by domain

<http://emailbydomain.com>

Auto manuals search

<http://auto.somanuals.com>

TV manuals search

<http://tv.somanuals.com>