

Kenmore

INSTRUCTIONS

ZIG•ZAG SEWING MACHINE MODEL 1357/1525/1660/1947

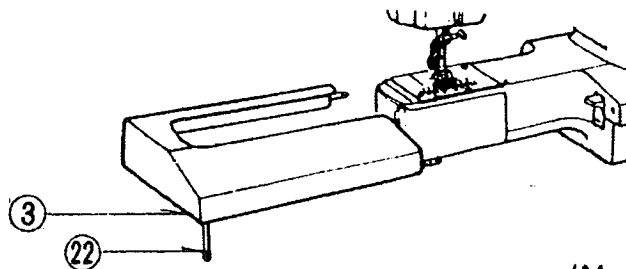
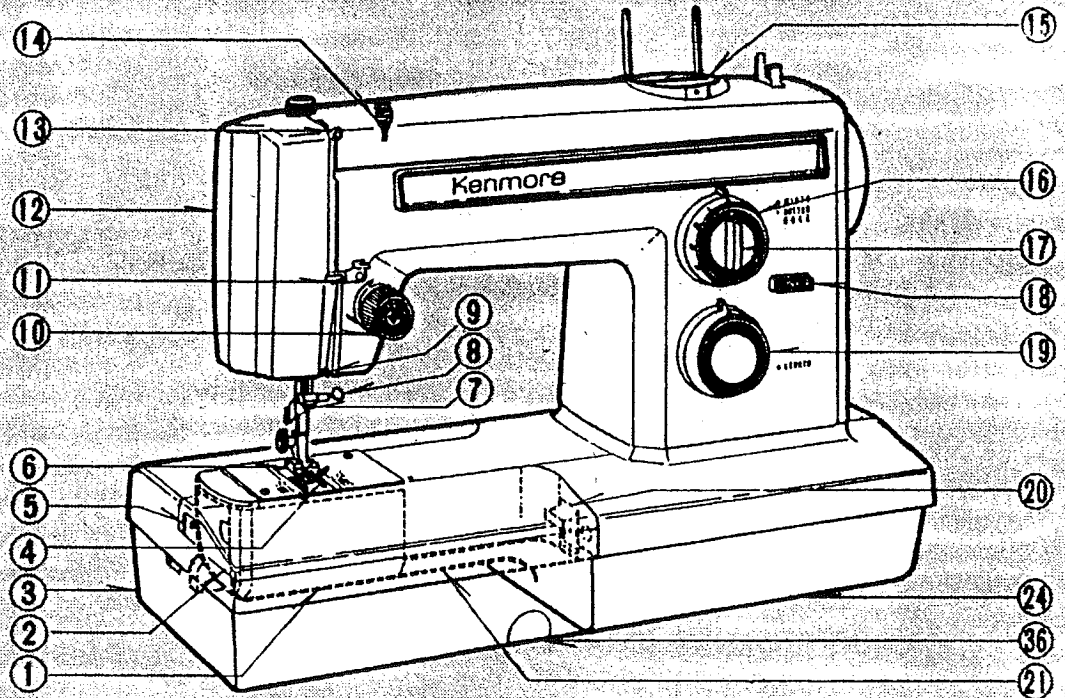

TABLE OF CONTENTS

1. KNOWING YOUR SEWING MACHINE	
Identifying Parts	2, 3
Installing Machine	4, 5
Converting to Free-arm Sewing	6
Winding the Bobbin	7
Threading the Bobbin Case	8
Threading of Top Thread	9
USING THE CONTROLS	
Adjusting Top Tension	10
Adjusting Bobbin Tension	10
Stitch Width Control	11
Stitch Length Control	11
Reverse Stitch Control	12
Special Stitch Modifier and Buttonhole Control	12
Special Stitch Dial	13, 14
Pressure Regulator	15
Feed Dog Control	16
Sewing Light	16
Needle Plate Inserts	17
Seam Guides	17
ACCESSORIES	
Needles	18
Needle, Thread and Fabric Chart	19
Buttonhole Guide	19
Buttonhole Attachment	20
Presser Feet	21
2. STARTING TO SEW	22
GARMENT CONSTRUCTION STITCHES	
Straight Stitching	23, 24
Zigzag Stitching	25
Stretch Stitching	26 - 29
SPECIAL FINISHING STITCHES	
Buttonhole Making	30 - 35
Blind Hemming	36
Satin Stitching, Appliquing	37
Zipper Application	38
Mending, Darning	39
Button Sewing, Bar Tacking	40
Free-arm Sewing	41
3. CHECKING PERFORMANCE PROBLEMS	42, 43
4. CARING FOR THE MACHINE	
Cleaning Feed Dogs and Shuttle	44
Oiling Under Arm Cover Plate	45
Oiling Underside	46, 47
Oiling in Face Cover Plate	47
Parts List	48, 49

1. KNOWING YOUR MACHINE

FRONT VIEW



(Model 1525)

- | | |
|--------------------------------|---|
| 1. Shuttle cover | 12. Face cover plate |
| 2. Base front cover | 13. Take-up lever |
| 3. Base | 14. Upper thread guide |
| 4. Zigzag stitch needle plate | 15. Special stitch dial |
| 5. Front cover release button | 16. Stitch width control |
| 6. Presser foot | 17. Special stitch modifier and
buttonhole control |
| 7. Thread guide | 18. Reverse stitch lever |
| 8. Needle clamp screw | 19. Stitch length control |
| 9. Thread guide | 20. Feed dog control |
| 10. Top thread tension control | 21. Free arm |
| 11. Face cover thread guide | 22. Support leg |

BACK VIEW

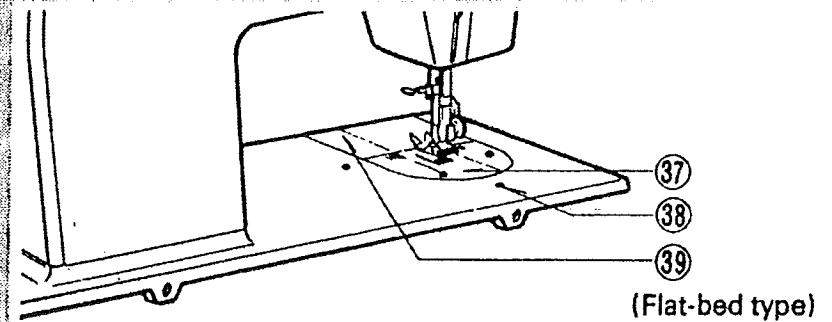
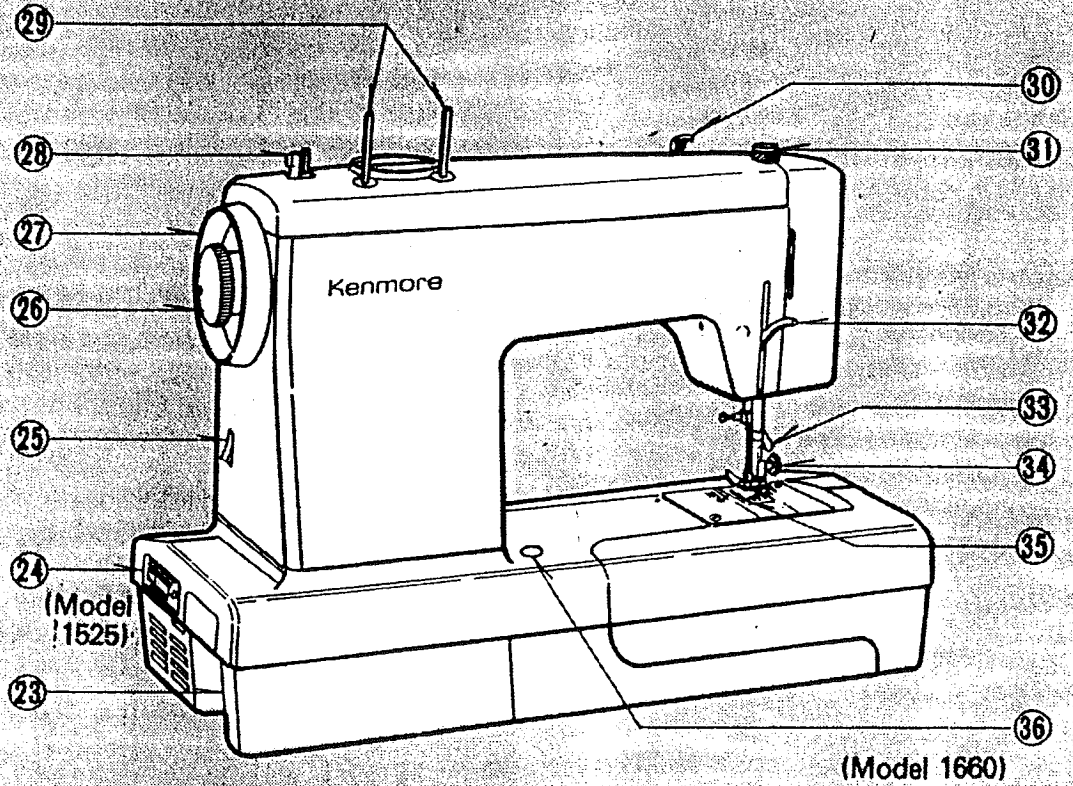

- | | |
|--------------------------------|------------------------------|
| 23. Electric cord receptacle | 32. Presser foot lever |
| 24. Nomenclature plate | 33. Thread cutter |
| 25. Light and power switch | 34. Presser foot thumb screw |
| 26. Clutch knob | 35. Feed dogs |
| 27. Hand wheel | 36. Base release button |
| 28. Bobbin winder | 37. Needle plate |
| 29. Spool pins | 38. Guide pin hole |
| 30. Bobbin winder tension disc | 39. Hand hole cover plate |
| 31. Pressure regulator | |

INSTALLING MACHINE (Free-arm type)

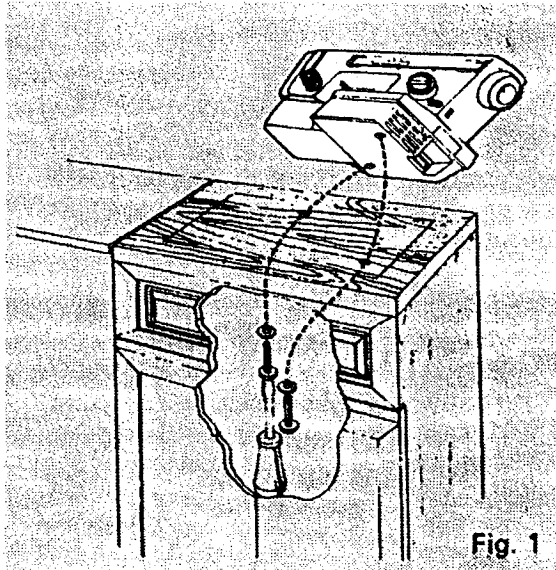

Fig. 1

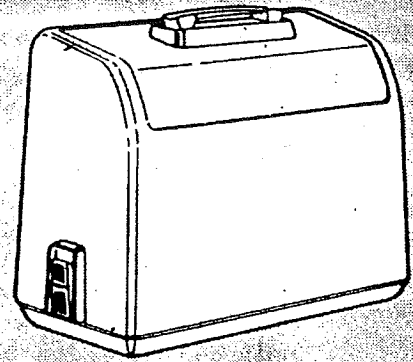

Fig. 3

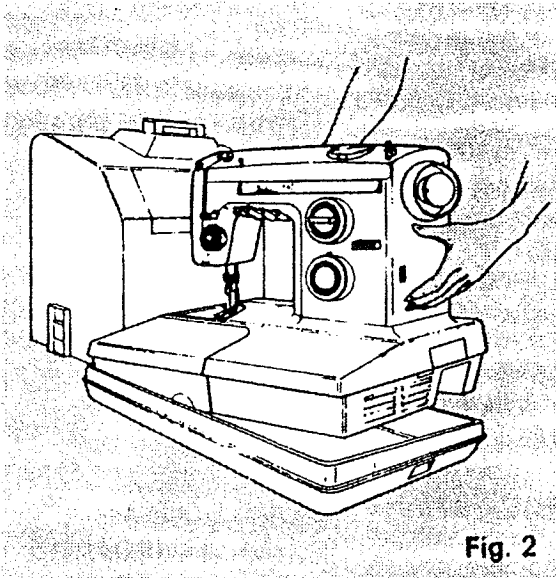

Fig. 2

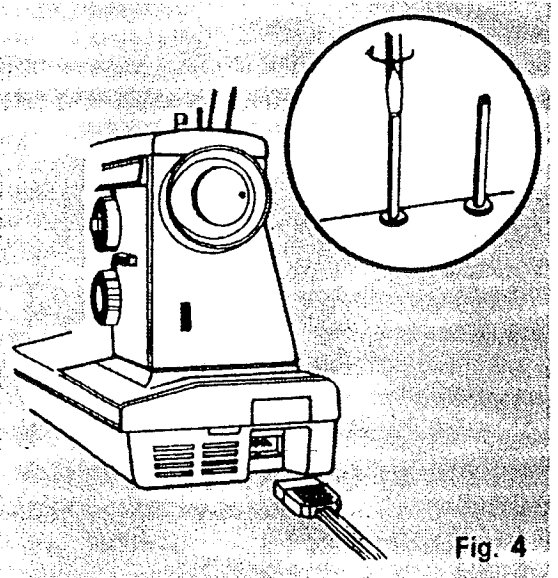

Fig. 4

1. To install the machine in cabinet, position machine head on cabinet platform so that holes on bottom of machine match those on board. Insert washers and screws and tighten into place. (Fig. 1)
2. A separate base and cover is available to carry the machine when needed. The base must be removed when machine is used.
To install machine in carrying case, set machine into base, with word FRONT in base facing you. (Fig. 2)
Place cover on machine with word

"SEARS" on handle facing you. The case slopes in the same direction of the machine. (Fig. 3)

3. Push the speed control plug onto three-prong connector. Plug machine cord into any 110-120 volt wall outlet. Turn on power by pushing light and power switch. (Fig. 4)
4. Spool pins are packed in accessory box. Screw thread spool pins in place securely with a screw driver. Position nylon discs as shown in illustration.

INSTALLING MACHINE (Flat bed type)

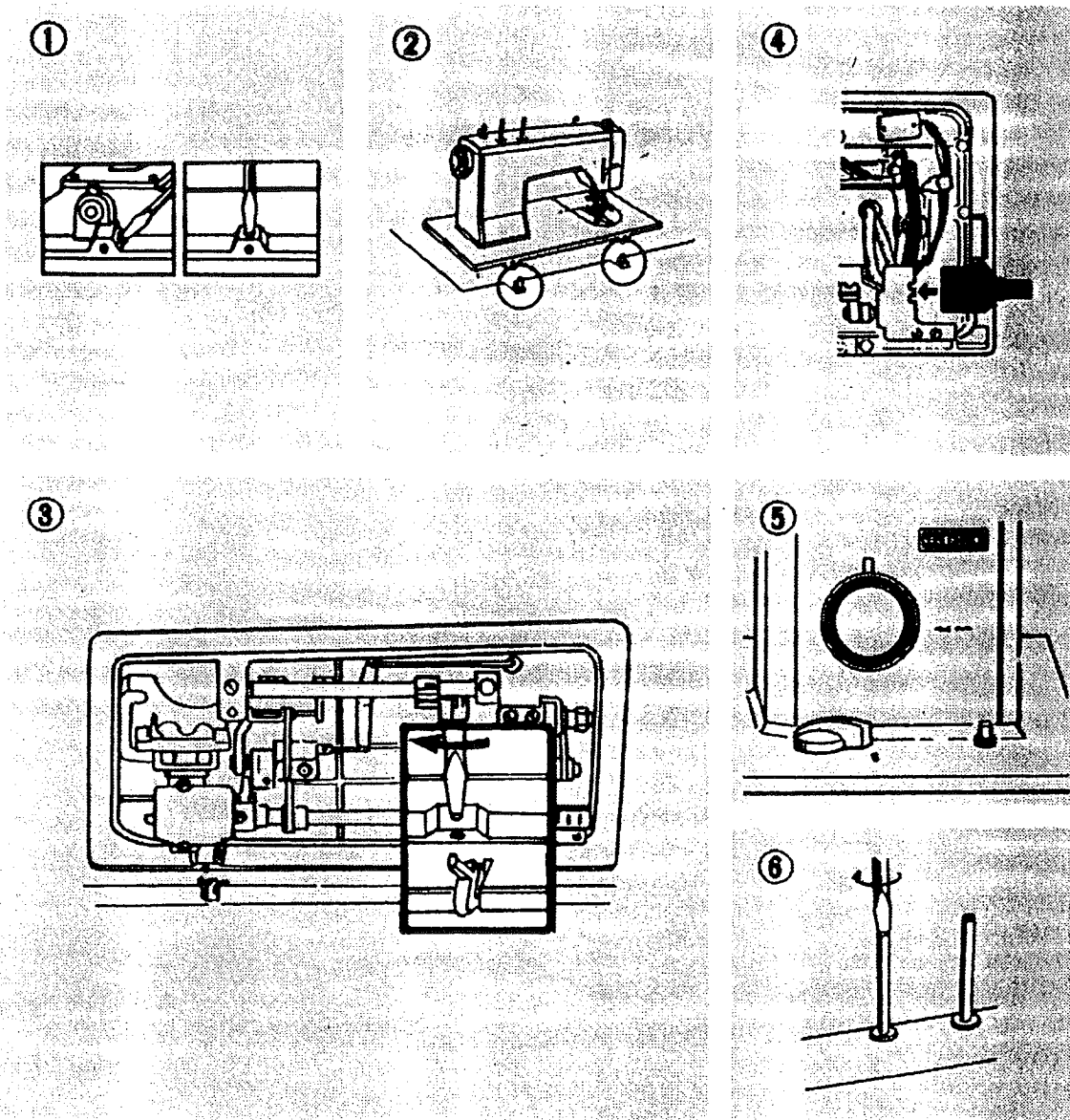

1. Loosen the two hinge screws under holes in the rear edge of the machine bed.
2. Raise hinge pins in the cabinet or case. Slip machine head onto pins.
3. Tighten hinge screws securely.
4. Push the speed control plug into three-prong connector under the bed plate. Lower machine head to front cabinet flap.
5. Plug machine cord into any 110-120 volt wall outlet. Turn on power by pushing light and power switch.
6. Spool pins are packed in accessory box. Screw thread spool pins in place securely with a screw driver. Position nylon discs as shown in illustration.

CONVERTING TO FREE-ARM SEWING

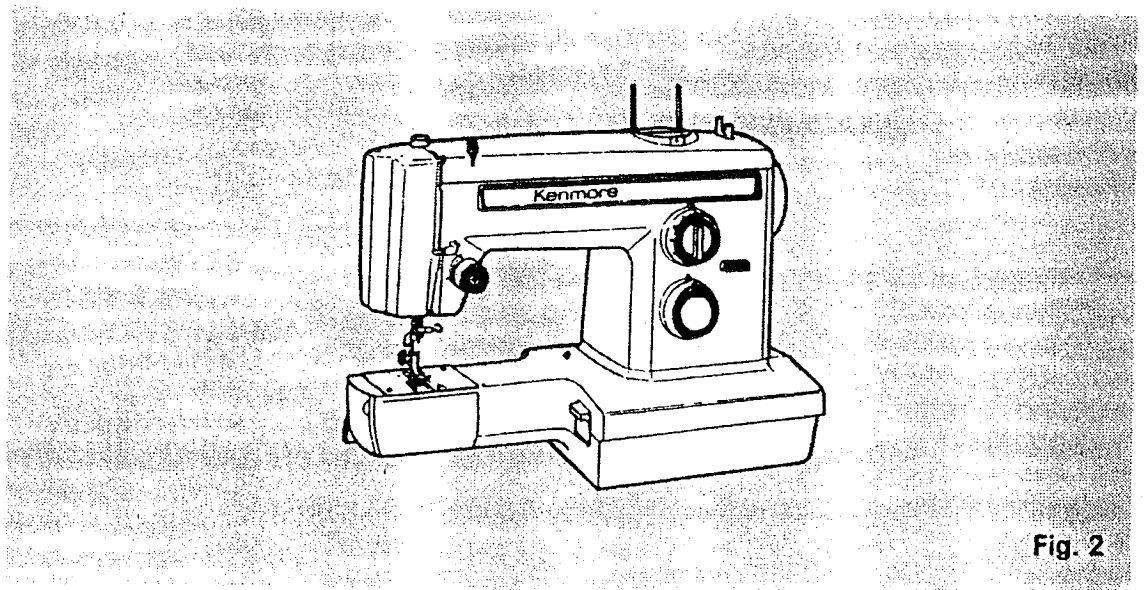
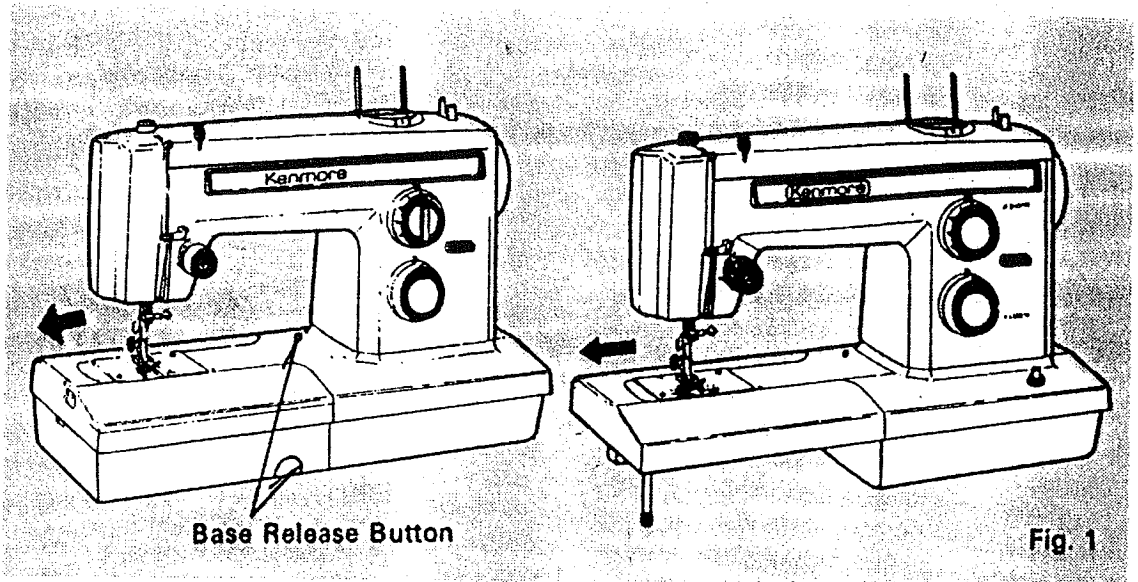

1. Remove the base from the machine by pushing the release button (if applicable) and pulling the base to the left. (Fig. 1, 2)

2. To replace the base, simply slide it along the free arm to its original position. (Fig. 1)

Note: Base cannot be removed or replaced unless shuttle cover is closed.

WINDING THE BOBBIN

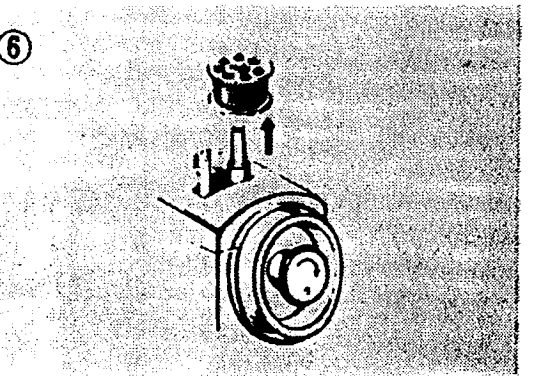
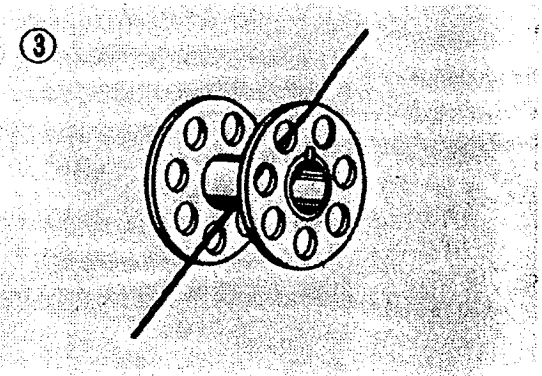
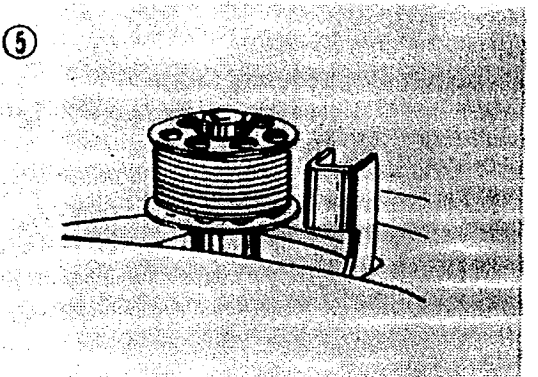
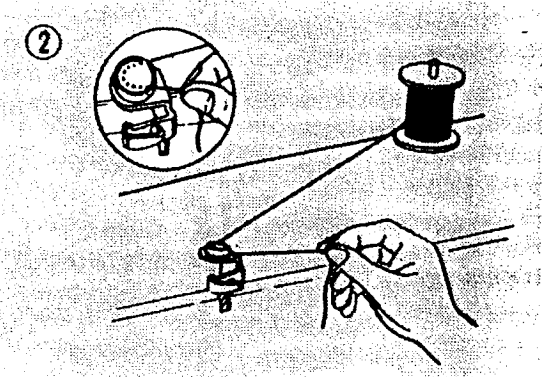
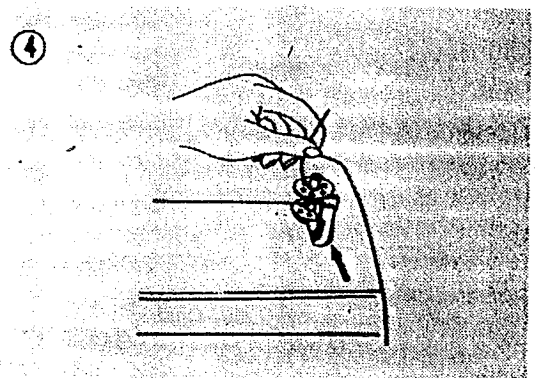
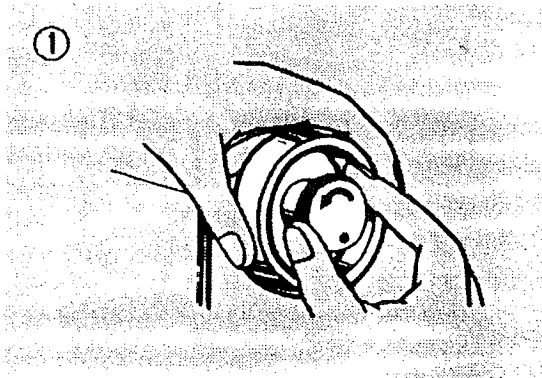

1. Release clutch by turning clutch knob toward you.
2. Draw thread from spool through bobbin winder tension disc as shown.
3. Pull end of thread through hole in bobbin as shown.
4. Place bobbin onto bobbin winder shaft with end of thread coming from the top of the bobbin. Push

bobbin winder latch against bobbin until it clicks. Holding onto end of thread, start machine. When bobbin is slightly filled, snip off end of thread.

5. Start machine. Wind thread until bobbin winder latch releases.
6. Tighten clutch knob and remove bobbin.

THREADING THE BOBBIN CASE

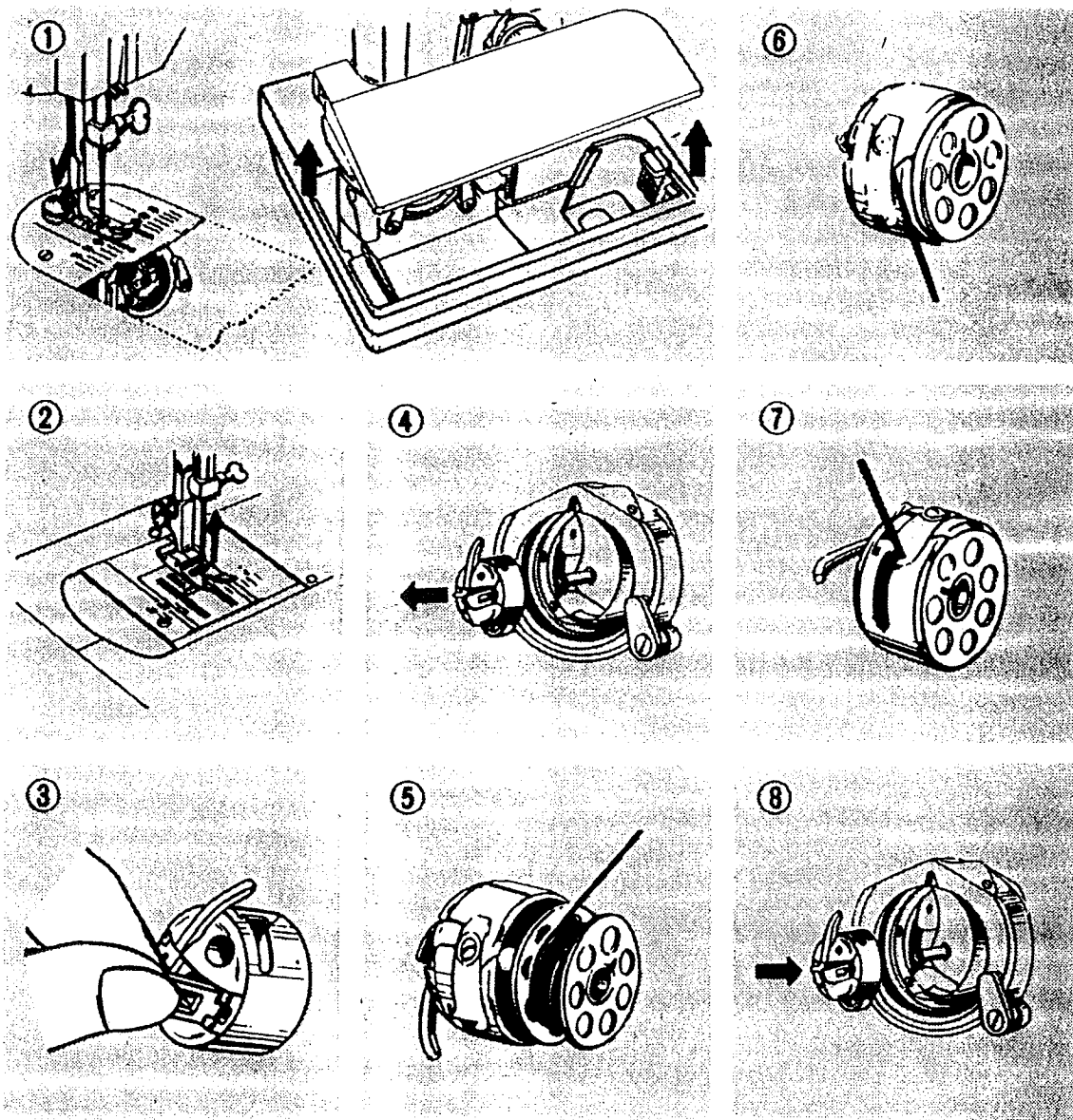

1. Remove base front cover by pushing the release button on the left side. Open the shuttle cover.
2. Raise needle to its highest position by rotating hand wheel toward you.
3. To remove bobbin case from shuttle, pull open latch of bobbin case.
4. Pull bobbin case straight out of shuttle.
5. Insert bobbin into bobbin case making sure thread is coming from bobbin as shown.
6. Pull thread through slot of case as shown.
7. Pull thread under tension spring.
8. Holding latch open, position case into shuttle, and release latch. Case should lock into place when latch is released.

THREADING OF TOP THREAD

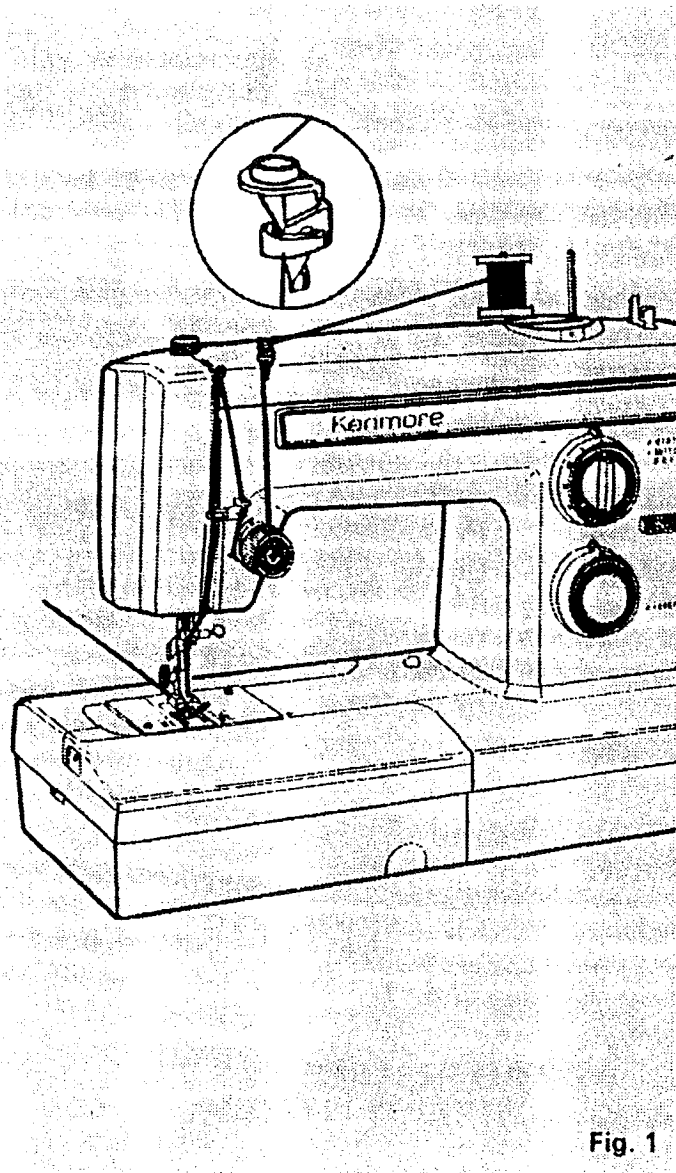

Place thread on spool pin as shown with thread coming from the back of the spool. Draw thread through the top thread guide. Holding the spool stationary with right hand, pull the end of the thread between the tension discs as shown. Pull the spring wire loop up and past the top hook until the thread can be slipped into the hook (See Fig. 2). When the thread is released, the spring wire loop will return to position

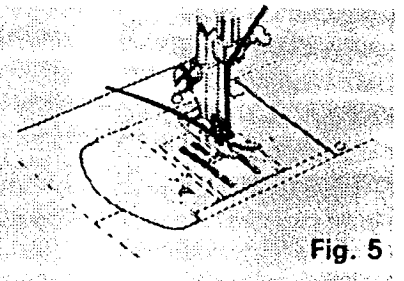
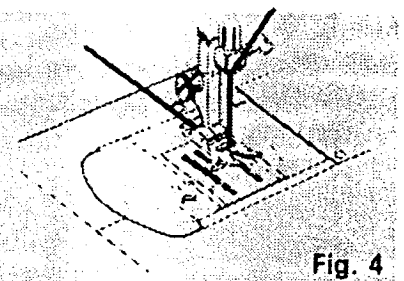
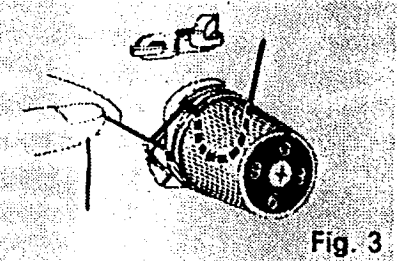
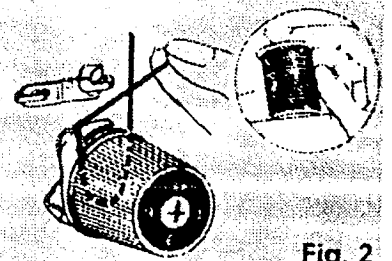

(See Fig. 3) with thread in proper place. Release spool of thread and continue to thread machine exactly as shown. Needle must always be threaded in direction as shown in Fig. 4.

Hold needle thread loosely in left hand and rotate hand wheel toward you one complete turn. Bring bobbin thread up by pulling upper thread. (Fig. 5).

CONTROLS

STRAIGHT STITCHING

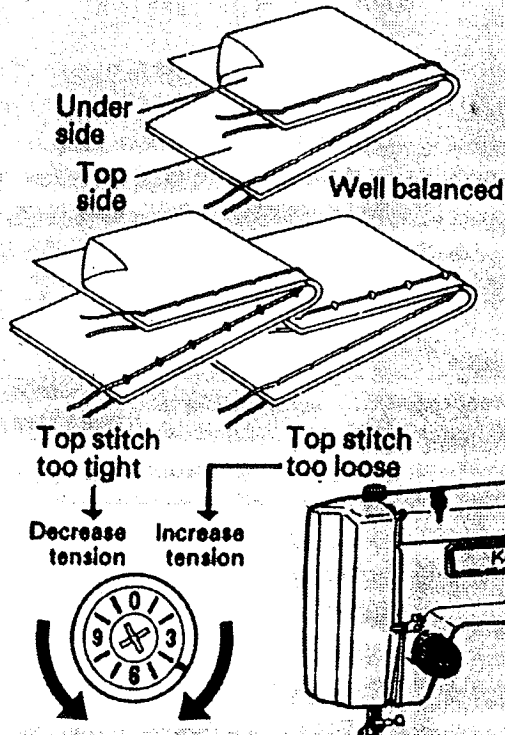

ZIGZAG STITCHING

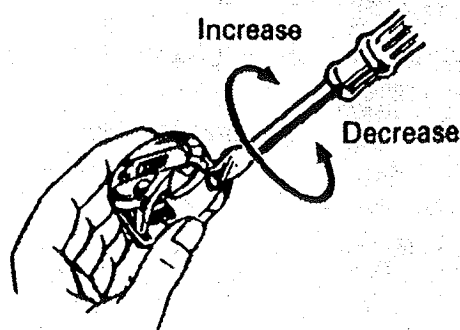
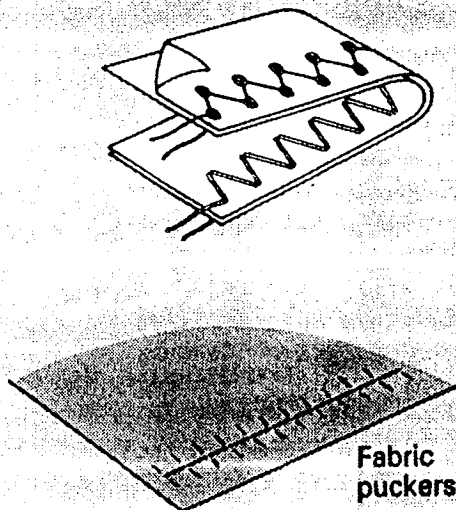

ADJUSTING TOP THREAD TENSION

STRAIGHT STITCHING

The good looking appearance of your stitching is largely determined by the balanced tension of both top and bobbin threads. The tension is well balanced when these two threads 'lock' in the middle of layers of fabric you are sewing.

If, when you start to sew, you find that the stitching is irregular, you will need to adjust the tension control.

Make any adjustments with presser foot 'down'.

1. If the threads are locking on the top surface with the top thread lying flat, the top stitch is too tight. Tension can be decreased by turning the tension control to lower numbers.
2. If the reverse is happening with the threads on the underside of the fabric, the tension is too loose. This can be corrected by turning the tension control to higher numbers.

ZIGZAG STITCHING

The top thread may appear on the bottom depending on the thread, fabric, type of stitch and sewing speed, but the bobbin thread must never appear on the top of the fabric.

ADJUSTING BOBBIN THREAD TENSION

BOBBIN THREAD TENSION REQUIRES ADJUSTMENT LESS FREQUENTLY THAN THE TOP THREAD TENSION.

If the tension is well balanced, but the fabric puckers badly, both top and bobbin thread tensions may be too tight and have to be adjusted.

When adjusting the tension on the bobbin case, make only slight adjustments with a screwdriver.

STITCH WIDTH CONTROL

This control regulates the width of the stitch you select. THE HIGHER THE NUMBER - THE WIDER THE STITCH. You may vary your zigzag stitch width by adjusting this control to the setting you desire.

This control must be on Red Dot in order to do straight stitching. Turn only the outer rim of this control to set the stitch width. The center of the control dials the special stitches the machine is capable of sewing.

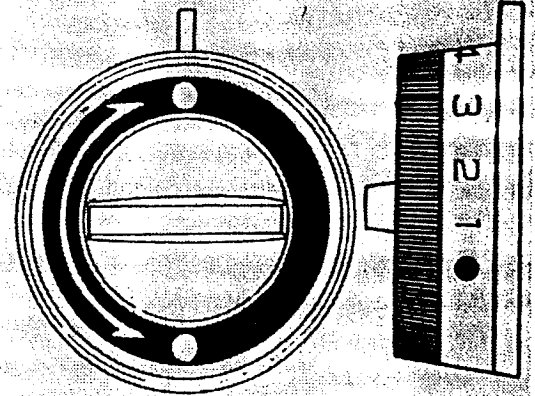

STITCH LENGTH CONTROL

The stitch length control regulates the length of the stitch you select. THE HIGHER THE NUMBER - THE SHORTER THE STITCH.

The number on stitch length control indicates the approximate number of stitches per inch. The stitch setting you use will be determined by the thickness of the fabric you are sewing.

A longer stitch setting should be used for thicker fabric or more layers of fabric. The middle range of the control is the 10-12 stitch per inch range which is the most commonly used.

A basting stitch is made by using the longest possible stitch setting - 6 stitches per inch. The red marking  on the control is the setting used for the shortest stitches such as in Satin Stitching.

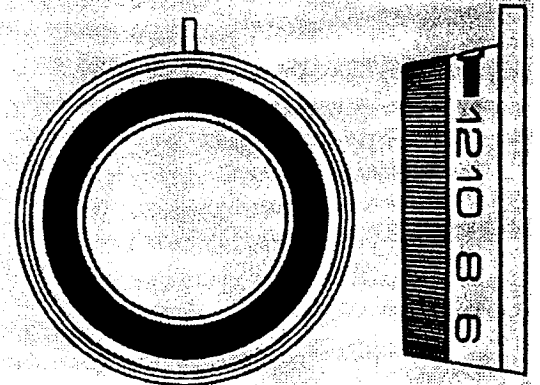



REVERSE STITCH CONTROL

It is best to begin and end seams with a few stitches taken in reverse. This is called back tacking. Back tacking fastens the ends of the seams firmly and prevents raveling.

When reverse stitching is needed, turn the control clockwise and hold there during sewing. The fabric will immediately start feeding backwards and seam will be fastened.

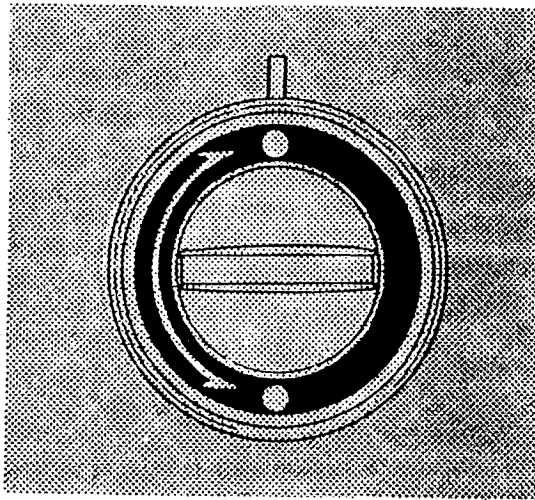

SPECIAL STITCH MODIFIER AND BUTTONHOLE CONTROL

This control gives you the means of varying the stitches on the Special Stitch Dial. When the pointer is turned to the Red Dot, the machine sews forward only. When the pointer is turned to the White Dot, the forward designs are varied by the machine sewing in a forward and reverse manner. Carefully read directions given in the next section of the book in order to accomplish the various stitches correctly.

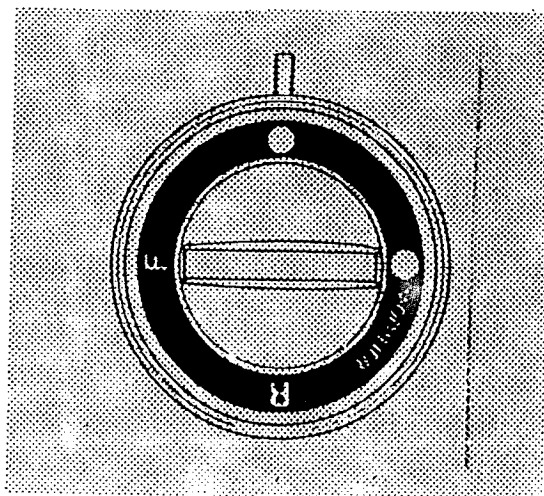

This control is also used in making buttonholes (Model 1525 only). Detailed instructions are given in the next section of the book.

SPECIAL STITCH DIAL

There are certain types of utility stitches you will use often in your home sewing. This control enables you to just dial the stitch you need for the task at hand.

All stitches printed in red on the dial must be sewn with the Special Stitch Modifier set at the Red Dot.

To make the stitches printed in black on this dial, the Special Stitch Modifier must be set at the White Dot.

THE RED DOT SETTING

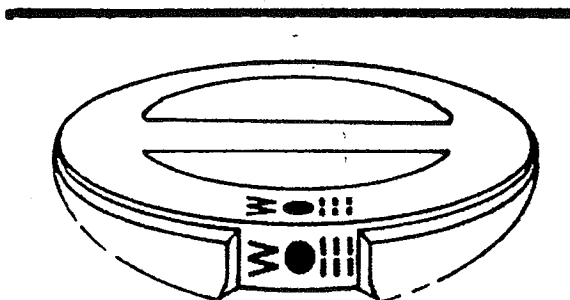

The setting illustrated above is the one used for most of your stitching. At this setting you may straight stitch, stretch stitch and make a simple zig zag stitch. As each stitch is dependent upon the settings of your other controls, carefully read the directions in the next section of the book for the various stitches.

BLIND STITCH AND OVERLOCK STRETCH STITCH

Blind hems are made by using the setting illustrated with the Stitch Modifier set on the Red Dot. When the Modifier is set on the White Dot, overcast stretch stitching is made.

SPECIAL BOX STITCH AND ELASTIC STRETCH

The setting illustrated is used for special edge finishing and special stretch stitch for sewing elastic such as sportswear, girdles and other garments that require stretch. See next section of this book for detailed use of the stitches.

SPECIAL MENDING STITCH AND SMOCKING STRETCH ☼☼

You will find that much of your sewing is in the mending category. For this reason you have been provided with a stitch for the repair of tears. It is accomplished with the illustrated setting and the Modifier set at the Red Dot. When the Modifier is turned to the White Dot a Smocking Stitch results. For directions see the next section of this book.

SERGING OR PINE LEAF STRETCH ☼☼

Serging or pine leaf stretch is used for seam finishing on all types of fabrics. It is a stitch used in the garment industry. It forms a good looking seam, stitching and overcasting the edges. This stitch is useful for seaming of swimwear, stretch ski pants and other types of knit sportswear. Modifier must be set on the White Dot.

If Modifier is set on the red dot, a Shell Stitch can be made on nylon tricot.

BUTTONHOLE SETTING

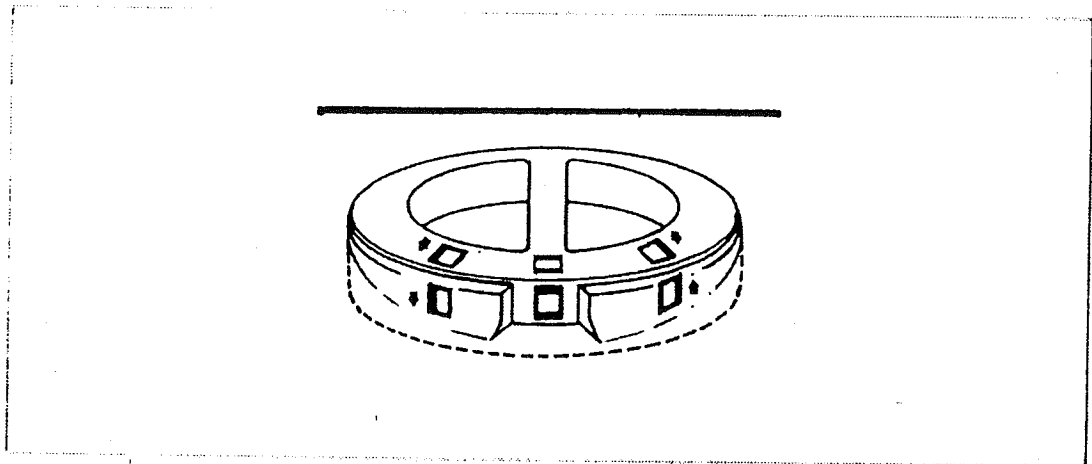

The three settings illustrated are used in making a bar tacked buttonhole. Detailed instructions are given in the next section of the book.

OTHER ADJUSTMENTS OF MACHINE IN SEWING

In addition to the obvious controls of your machine, there are other small regulators and controls to aid you in using your sewing machine.

PRESSURE REGULATOR

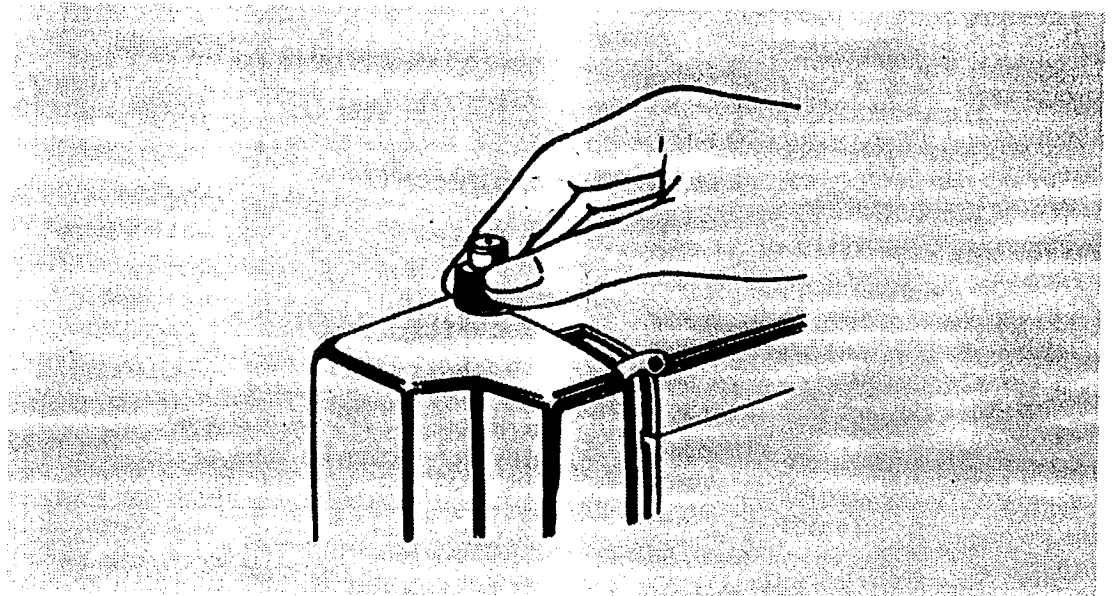

Push down the outer ring of the pressure regulator. This will release the pressure on the presser foot. (See above).
To increase the pressure, push down inner pin until a suitable pressure is obtained.

Insufficient pressure may cause poor feeding of the fabric, skipped stitches, or difficulty in guiding the fabric. If feed dogs or presser foot marks appear on the fabric, reduce the pressure.

When sewing multiple thickness or heavy fabric, reduce the pressure. Increase pressure when sewing lighter weight fabrics.

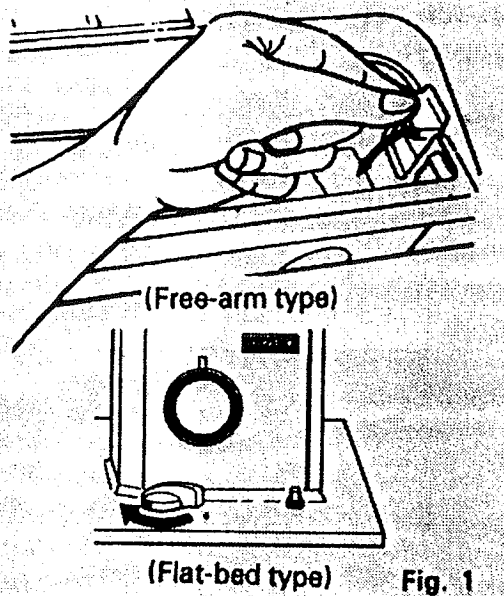

FEED DOG CONTROL

There are a few times when you want to control the feeding of the fabric yourself. Remove the base cover from the base. Pull down the feed dog control or turn to the left as shown in Fig. 1. The feed dogs will drop. You may then determine the movement of the fabric yourself.

For most of your stitching, the feed dog control should be in the up position.

Whenever you raise or lower the feed dogs, be sure to have the presser foot in the up position.

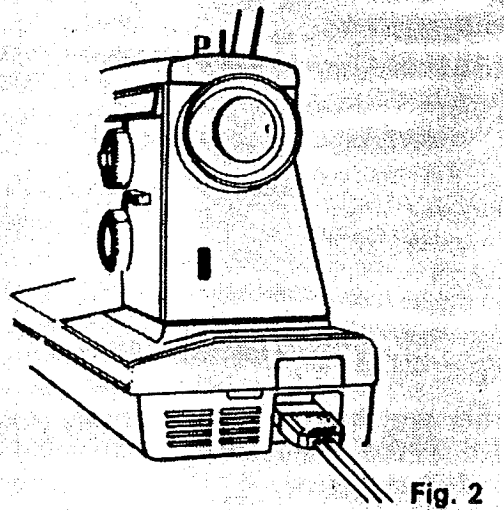

SEWING LIGHT

The light and power switch shown in Fig. 1 and 2 provides the electric current for the motor as well as for the light. In order to operate the machine, this switch must be on. To turn on the light, depress the upper side of the switch. If you are interrupted while sewing and must leave the machine unattended, just turn off the switch and the machine cannot be started accidentally.

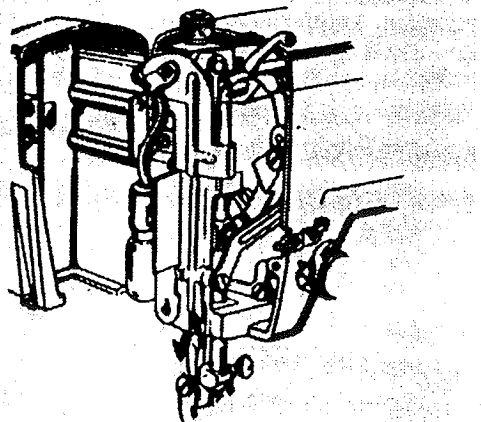

The sewing light is located inside the face cover plate as shown. To replace the bulb, turn light off, and swing the face cover plate open. Push up on the bulb slightly and turn bulb clockwise. Remove bulb from socket. Push in new bulb and turn counter-clockwise.

NEEDLE PLATE INSERTS

(Free-arm type)

You are provided with two needle plate inserts:

- A. Needle plate with wide oval hole for all zigzag stitching.
- B. Needle plate with round hole for regular straight stitching and straight stretch stitch sewing.

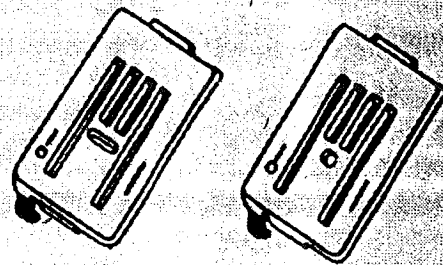

Fig. 1

CHANGING NEEDLE PLATE INSERTS

1. Raise needle to its highest position and raise presser foot.
2. Swing shuttle cover open.
3. Push a spring under the plate as shown to release the needle plate insert.
4. Remove needle plate insert by placing thumb under edge of plate.
5. Replace the needle plate insert positioning as shown in Fig. 3.
6. Push needle plate insert down to lock into place. Reposition the shuttle cover.

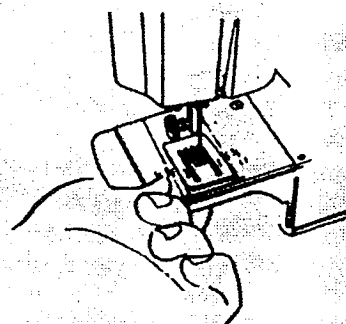

Fig. 2

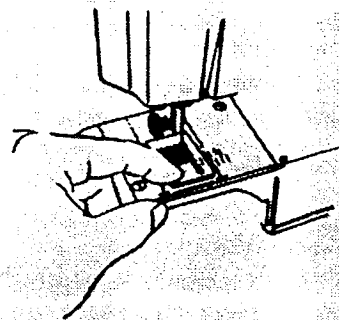

Fig. 3

SEAM GUIDES

Seam guides are printed on either side of the needle plate to aid you in guiding your fabric. THE GUIDE LINE EXTENDING ABOVE THE RIGHT SIDE OF THE NEEDLE PLATE IS THE "ALL IMPORTANT" 5/8" SEAM LINE.

The cornering guides are convenient when turning a square corner 5/8" from the fabric edge. See next section of this book for directions.

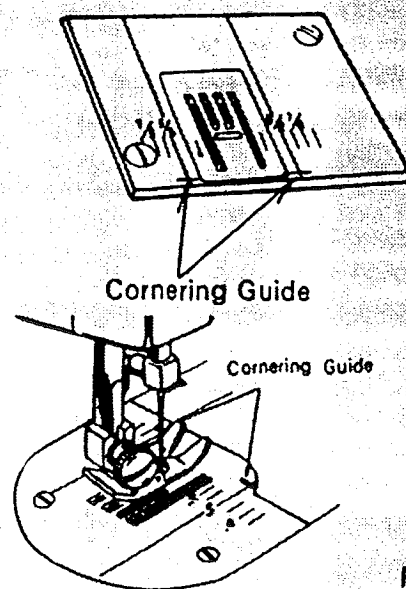
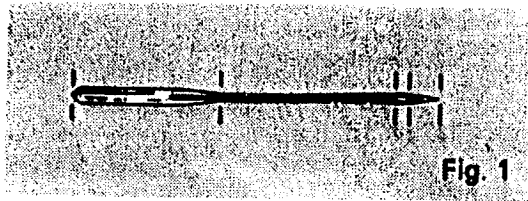

Fig. 4

ACCESSORIES



NEEDLES

Use KENMORE needles. The size of the needle should conform with the size of the thread and both should be suitable to the fabric (See next page).

Never use a bent needle or one with a blunt point.

Fig. 1. shows you the exact length of your needle. Be sure you never use one in your machine that is not this exact length.

You will find among your accessories a "Q NEEDLE" with blue shank. This special needle is to be used when sewing certain knits and certain difficult synthetic fabrics. If you experience skipped stitches in any of your sewing, use

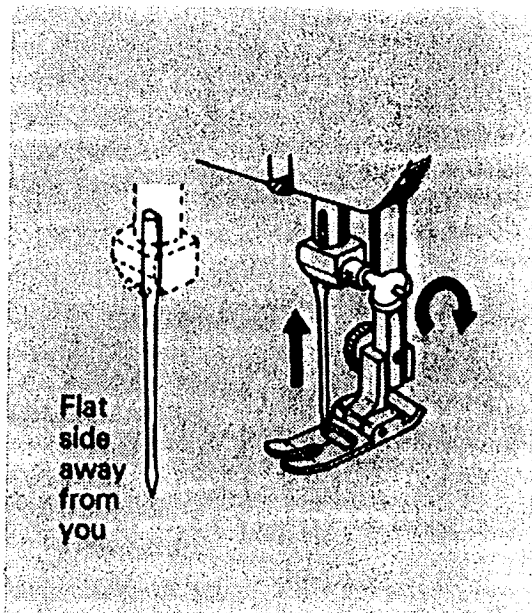

PLACEMENT OF NEEDLE

Raise needle bar to its highest position by turning the hand wheel toward you. Loosen the needle clamp screw. Holding the needle with the flat side away from you, slip the needle into the needle bar. When it is in as far as it will go, tighten the needle clamp screw with a screwdriver.

If you have a double needle for decorative stitching, it is inserted in the same manner as the single needle.

NEEDLE, THREAD AND FABRIC CHART

THREAD SIZE	NEEDLE SIZE	FABRIC
Polyester Core/Cotton Wrap Fine Mercerized Cotton Polyester Synthetic Silk A	9 or 11	Lightweight: Batiste, Dimity, Chiffon, Silks, Synthetic Jerseys, Fine Lace, Organza, Crepe, Taffetta, Voile, Organdy
50 Mercerized Cotton Polyester Synthetic Silk A	14	Medium Weight: Cotton, Cotton Blends, Percale, Gingham, Shantung, Pique, Seersucker, Satin, Knits, Vinyl, Suitings, Linen, Wool Crepe, Leather
50 Mercerized Cotton Mercerized Heavy Duty Polyester Synthetic Silk A	14 or 16	Medium Heavy Weight: Corduroy, Denim, Wool, Sailcloth, Wool Flannel, Gabardine, Velvets, Leather
Heavy Duty Mercerized Cotton Polyester Synthetic Silk A	18	Heavy Weight: Coatings, Upholstery, Cotton Duck, Heavy Twills, Canvas
Silk Buttonhole Twill	16, 18 or "Q NEEDLE"	Decorative Top-stitching on all
Polyester Synthetic 50 Mercerized Cotton	"Q SET" ("Q NEEDLE" and "Q FOOT")	Synthetic Knits and Stretch Fabrics: Polyester Double Knits, Nylon Tricot, Jersey, Stretch Terry, Spandex, Cire Tricot

BUTTONHOLE GUIDE

(Model 1525, 1947)

You have been provided with a buttonhole guide to aid you in making buttonholes. By using this guide, you will accurately make identical size buttonholes every time.

The guide just slips onto the regular zigzag foot as illustrated.

Details in using this attachment are given in the next section. Follow those directions carefully for perfectly formed buttonholes.

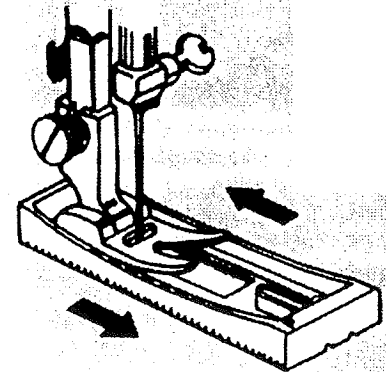

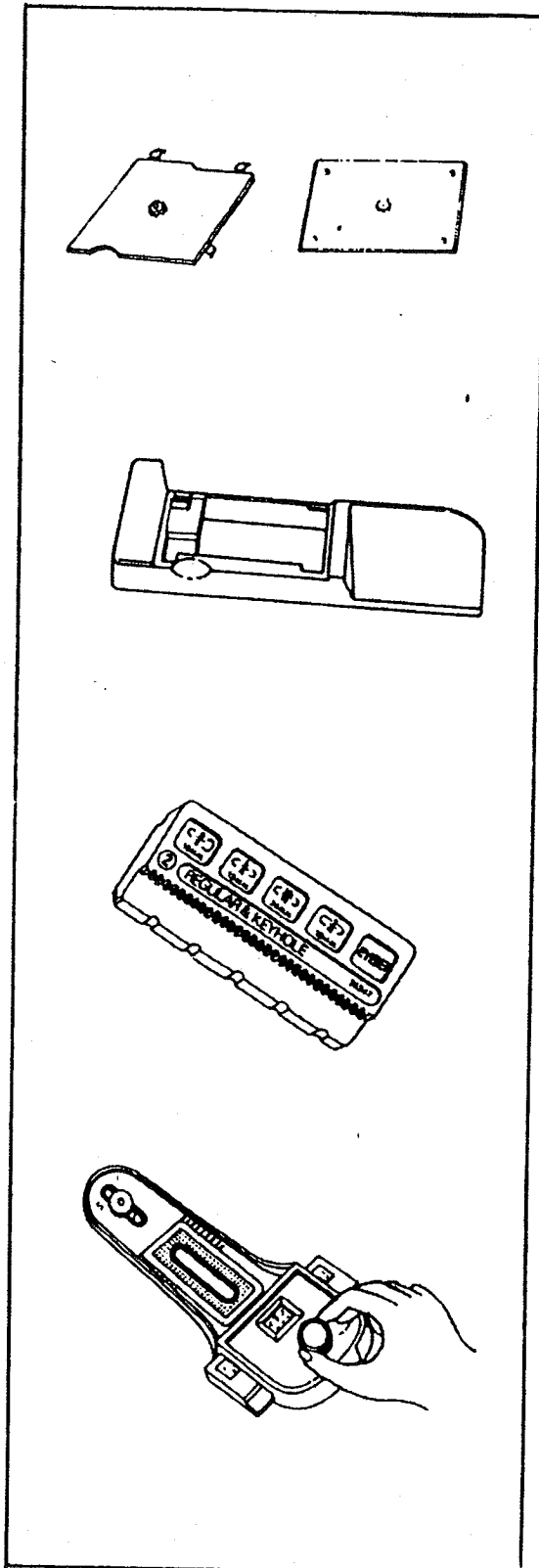

BUTTONHOLE ATTACHMENT

You will find the following parts in your Buttonhole Attachment Box:

1. Cover Plate with pinion gear in the center.
2. Buttonhole adapter to be used instead of base cover when buttonhole attachment is used. (Model 1660 only)
3. Guide Plate with Guide Pin that fits in guide pin hole on the machine bed just behind the needle plate, and with Template Holder.
4. A set of 5 templates is furnished with each attachment. Each template is marked showing the type and length of each buttonhole.
5. Desired size of buttonhole is selected by turning template advance knob. Length of buttonhole appears in window on top side of guide plate.

Details in using this attachment are given, in the next section. Follow those directions carefully for perfectly formed buttonholes.

PRESSER FEET

To change the various presser feet, raise the presser bar to its highest position by lifting the presser foot lever. Loosen the presser foot thumb screw, choose the proper foot, insert from the front.

Tighten the screw using the large screw driver to make certain the foot is secure.

To aid you in the placement of heavy fabrics under the presser foot, the lever can raise the foot beyond the normal "up" position. This is also an aid in changing your presser feet.

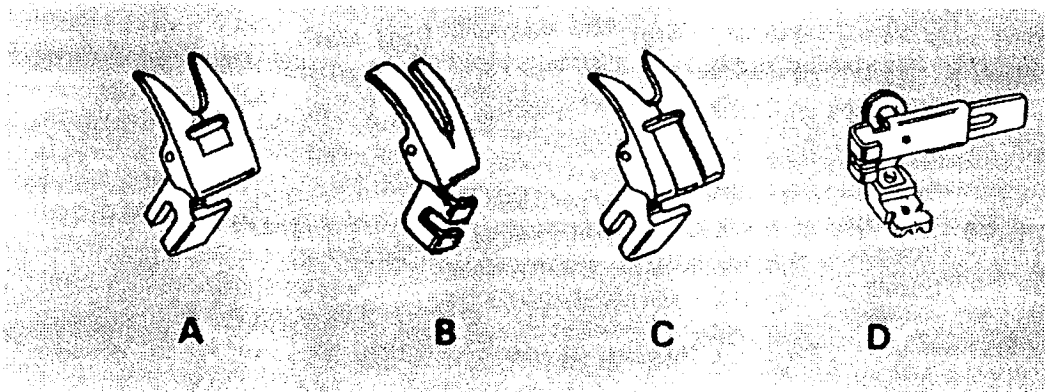
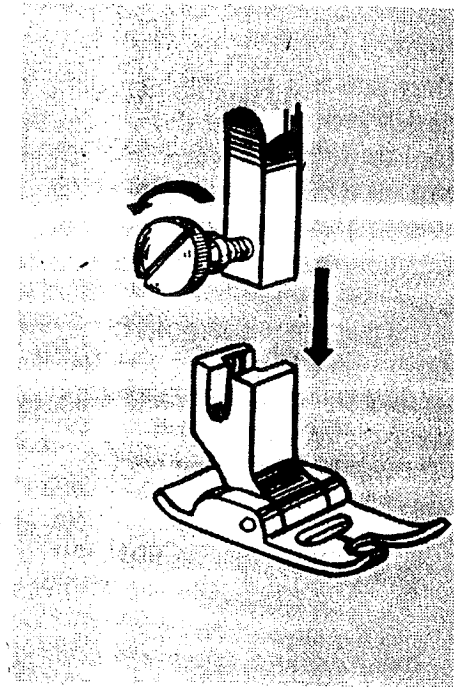

You have been given a variety of presser feet:

- A. Zigzag Foot
- B. Straight Stitch Foot
- C. Satin Stitch Foot
- D. Zipper Foot

2. STARTING TO SEW

Now that you are familiar with the controls on your machine and with the accessories provided for the machine, you are ready to start to sew with your new Kenmore sewing machine. Below are some good habits to follow each time you sit down to sew:

1. Test the needle - it should be straight, properly set and sharp on the point. It should be the correct size for the fabric and thread being used. Do not be afraid to change your needle frequently. Many of the new fabrics made of synthetic blends tend to dull the needles more easily than fabrics made of natural fibers.
2. Before placing the material on the machine, see that the ends of the threads have been drawn about 4 inches to the rear of the machine.
3. Test the machine stitch on a scrap of fabric you plan to use. The fabric should be double thickness. Adjust the machine for the length of stitch and tension suitable to your fabric.
4. Fabric should be placed under the presser foot with the bulk of the material to the left of the needle and the right edge of the material placed on the 5/8" seam marking on the needle plate when making a simple seam.
5. Run the machine at a slow even speed. The more pressure you put on the speed control, the faster the machine will sew.
6. Fasten each seam by back tacking at the beginning and end of the seam.
7. Always finish sewing each seam with the needle at its highest point.
8. Guide the fabric gently with your hand in front of the needle. Never pull or hold the fabric in such a way that the normal feeding is altered.
9. When turning the hand wheel manually, always turn it toward you.

GARMENT CONSTRUCTION STITCHES

STRAIGHT STITCHING

Set your machine just as shown in the illustration in order to straight stitch. It is important each dial have the following settings.

SETTINGS

Special Stitch Dial - $\Sigma \bullet III$
Stitch Width Control - Red Dot
Stitch Length Control - 12 to 6
Special Stitch Modifier - Red Dot
Straight Stitch Foot
Straight Stitch Needle Plate

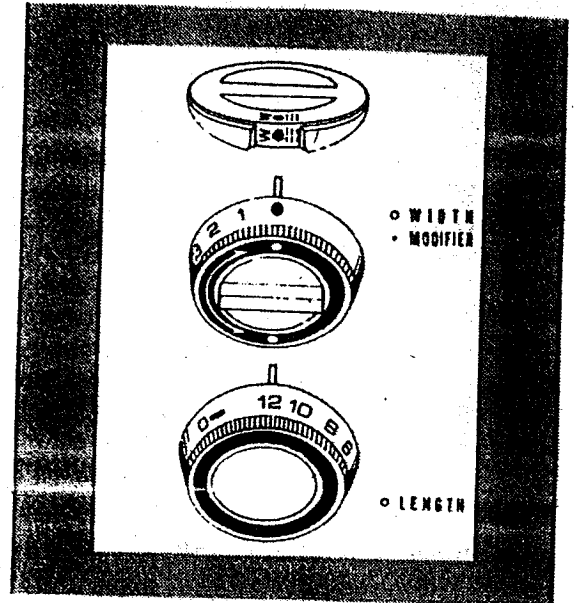

You will find in garment construction that you are doing two types of sewing - temporary and permanent.

1. Temporary stitching - Usually the longest stitch possible and often done on a single layer of fabric. The various types of temporary stitching are:

- Basting
- Stay stitching
- Guide line marking

2. Permanent stitching - This is the actual stitching that holds the garment together. Much of this stitching is visible on the outside of the garment and therefore must be good looking.

The best length stitch to use for medium weight fabrics is 10-12 stitches per inch. This is in the middle range of the Stitch Length Control.

You must remember to lengthen the stitch for heavier fabrics, multiple layers of fabric and thicker seams. Some of these seams are:

- Common two layer seams
- Curved two layer seams
- Top stitched three layer seams
- Top stitched four layer seams

When you have two seams crossing each other with considerable thickness, sew slowly and carefully so the seam will be as strong as possible in this area.

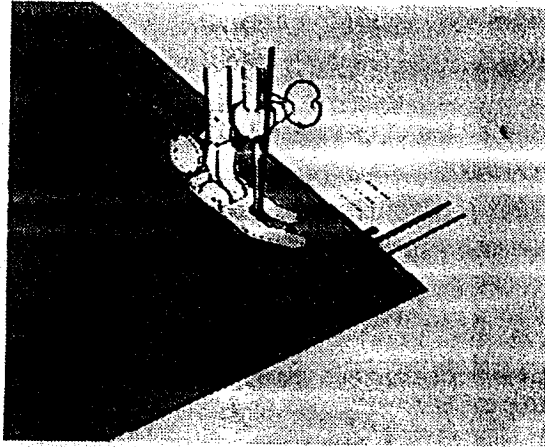

FASTENING A SEAM

Be sure both threads are drawn back under the presser foot. Lower needle into fabric about 1/2 inch from beginning of seam. Turn the reverse stitch control clockwise and stitch in reverse until needle reaches beginning of seam. Release control and complete seam. When you reach the end, turn the control clockwise and sew back over 1/2 inch of completed seam.

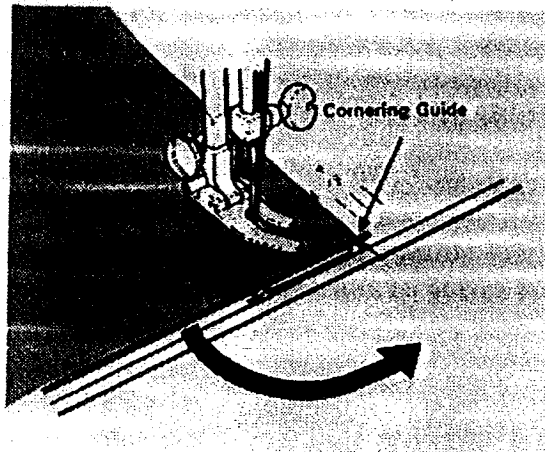

TURNING A SQUARE CORNER

To turn a square corner 5/8" from the fabric edge, stop stitching with the needle tip piercing the fabric, when reaching the cornering guide as shown. Raise the presser foot, turn fabric. New stitching line will align with 5/8" seam guide on side of needle plate. Lower the presser foot and begin stitching in new direction.

ZIGZAG STITCHING

SETTINGS

Special Stitch Dial - W ● III
Stitch Width Control - 1 to 4
Stitch Length Control - Any Number
Special Stitch Modifier - Red Dot
Zigzag Presser Foot
Zigzag Needle Plate

This type of stitching greatly expands the use of your machine. This is the feature that enables you to overcast seams, blind hem, applique, buttonhole, monogram, and make all the pretty embroidery designs by machine. Simply use the settings indicated in the illustration for the simple zigzag. Follow directions given in the following pages for more specific uses.

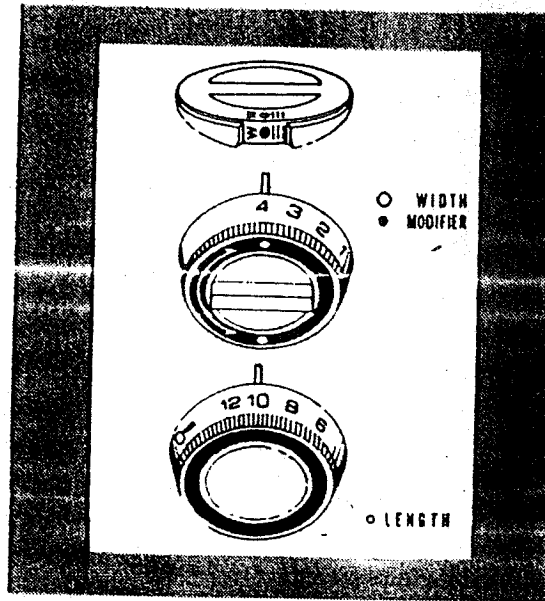

OVERCASTING

This is one of the more frequently used zigzag stitches in garment construction. You may want to overcast along the raw edge of each seam allowance or fold the raw edge toward the garment and stitch.

Fig. 1 shows the raw edge finished.
Fig. 2 illustrates the folded edge stitched.

Stitch so the needle pierces the fabric just short of the outside edge. Raw or worn edges of older garments can be overcast to prevent further raveling.

Fig. 1

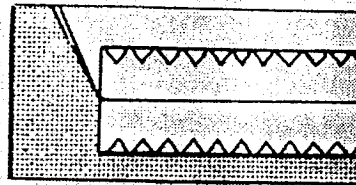
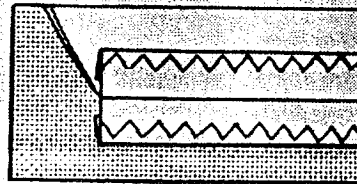
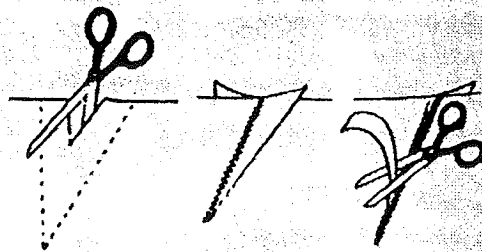

Fig. 2



INTERFACING DARTS

To reduce bulk of interfacing darts, cut interfacing down center between dart lines. Overlap cut edges, matching dart lines. Zigzag stitch along marking line from point to wide end of dart. Trim both raw edges close to stitching.



STRETCH STITCHING

The stitches shown below are all for use with stretch and knit fabrics. These are special stitches built in to the machine for your quick selection.

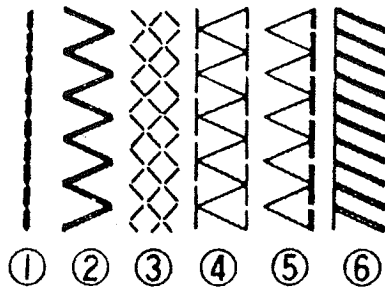

1. Straight Stretch
2. Rick - Rack Stretch
3. Smocking Stretch
4. Elastic Stretch
5. Overcast Stretch
6. Serging or Pine Leaf Stretch

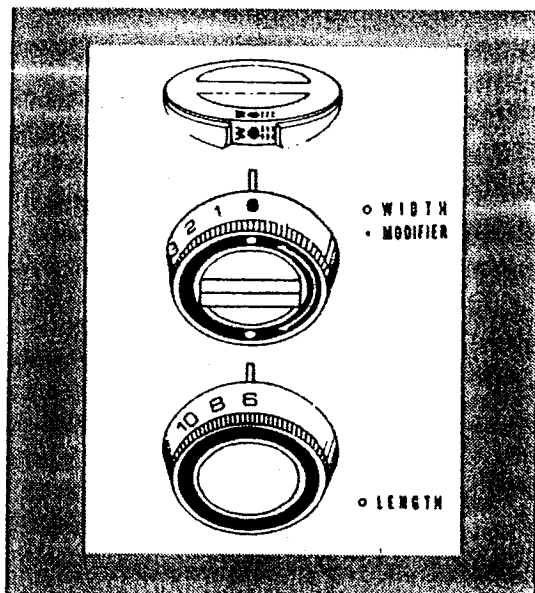

STRAIGHT STRETCH STITCHING

SETTINGS

Special Stitch Dial - 3 ● III
 Stitch Width Control - Red Dot
 Stitch Length Control - 6
 Special Stitch Modifier - White Dot
 Straight Stitch Foot
 Straight Stitch Needle Plate

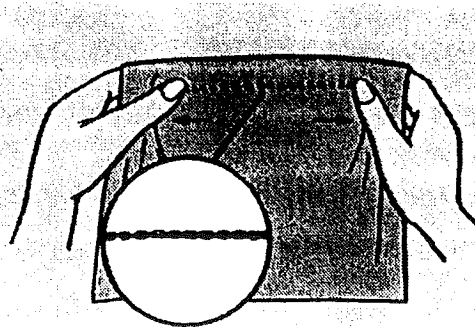

Use this stretch stitch with knitted fabric and other fabrics that stretch. Sew as you do with regular straight stitch seaming. The seam may be pressed open as with any regular seam, but will stretch if necessary.



This is also a good stitch to use on curved seams regardless of the type of fabric. Any seam that will receive a great deal of strain when worn should be sewn with the stretch stitch. Use in children's shorts and slacks as well as adult sports clothes.

RICK-RACK STRETCH STITCHING

SETTINGS

Special Stitch Dial -  
 Stitch Width Control - 1 to 4
 Stitch Length Control - 6
 Special Stitch Modifier - Red Dot
 Zigzag Presser Foot
 Zigzag Needle Plate

Sew on stretch fabrics in any area that you might use a zig zag stitch. This stitch can be used as a decorative top stitch as well.

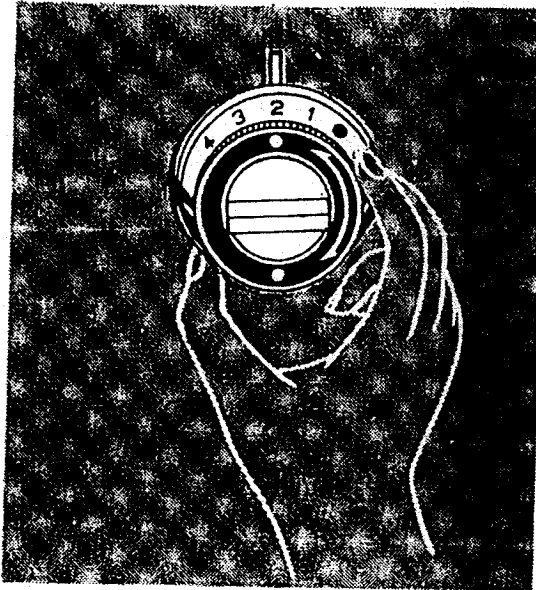

SMOCKING STRETCH STITCHING

SETTINGS

Step 1. Make a straight line of gathers across the fabric that you wish to smock.
 Step 2. Special Stitch Dial - 
 Stitch Width Control - 3 to 4
 Stitch Length Control - 6
 Special Stitch Modifier - Red Dot
 Zigzag Presser Foot
 Zigzag Needle Plate

With a narrow strip of fabric directly under the line of gathering, stitch over the gathers. The design will be a series of small diamonds.

When smocking a garment, the stitching should be done before the piece is sewn into the garment.

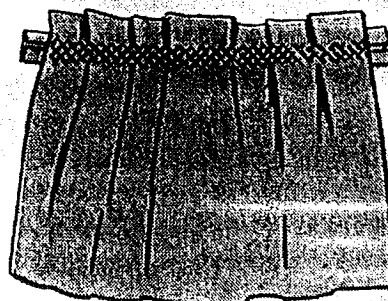
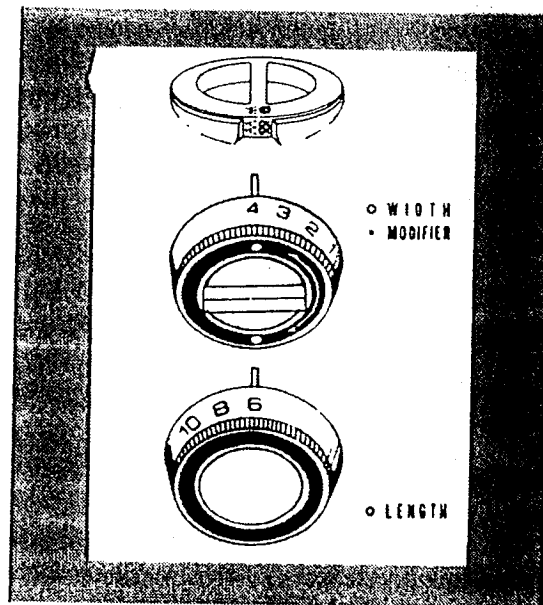

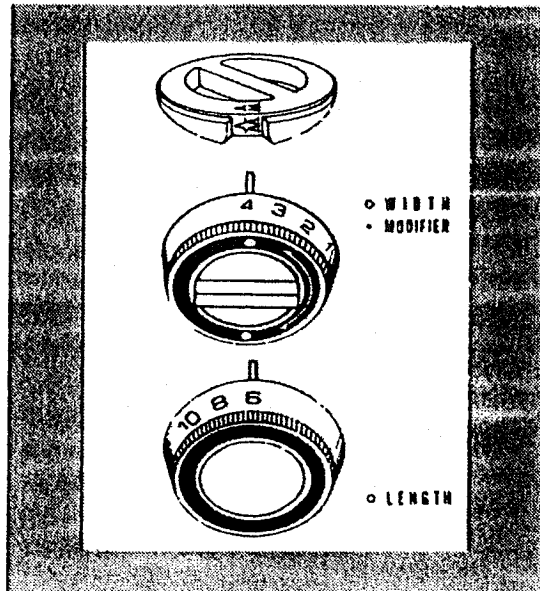

OVERCAST STRETCH STITCHING

SETTINGS

Special Stitch Dial - \swarrow
 Stitch Width Control - 4
 Stitch Length Control - 6
 Special Stitch Modifier - White Dot
 Zigzag Presser Foot
 Zigzag Needle Plate

This is the same type of stitch used by the garment industry in making sportswear. It is used for seams of 3/8" to 1/4". The seam is formed and finished in one operation. It must be used when you are making swimwear, ski pants and other garments that require stretch.

Fig. 1 shows the raw edge finished.

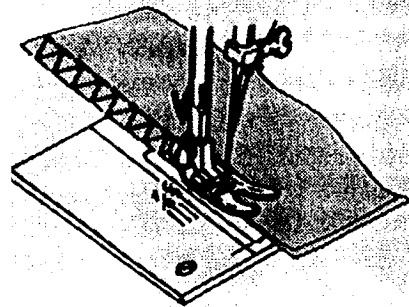

Fig. 1

Stitch so the needle pierces the fabric just short of the outside edge.

Raw or worn edges of older garments can be overcast to prevent further raveling.

ELASTIC STRETCH STITCHING

SETTINGS

Special Stitch Dial - \swarrow
 Stitch Width Control - 4
 Stitch Length Control - 6
 Special Stitch Modifier - White Dot
 Zigzag Presser Foot
 Zigzag Needle Plate

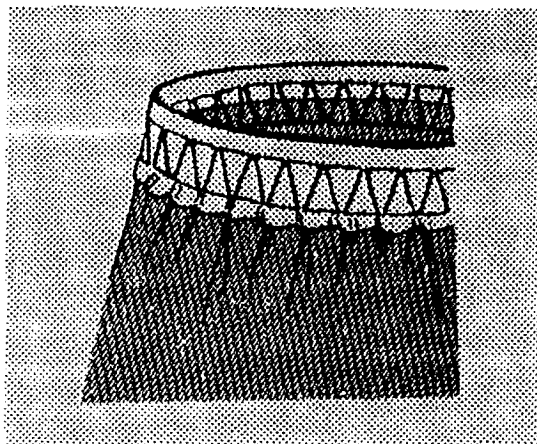

This is a good stitch to use in making or repairing lingerie. The stitch is decorative as well as useful. Simply stitch the elastic into place around the waist of the garment, making sure that the elastic is evenly spaced. To do this mark the correct length piece into quarters and match these markings with center front and back of the garment as well as side seams.

SERGING OR PINE LEAF STRETCH STITCHING

SETTINGS

Special Stitch Dial - \Rightarrow
Stitch Width Control - 4
Stitch Length Control - 6
Special Stitch Modifier - White Dot
Zigzag Presser Foot
Zigzag Needle Plate

The serging or pine leaf stretch stitch is equally useful with woven and knitted fabrics. This stitch can be used in making elastic swimwear, as well as overcasting a neat edge on the seams.

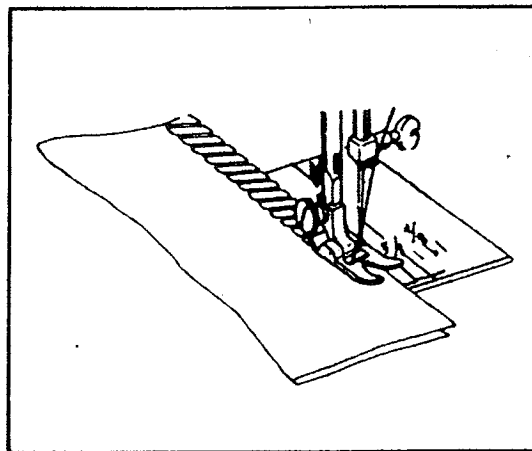
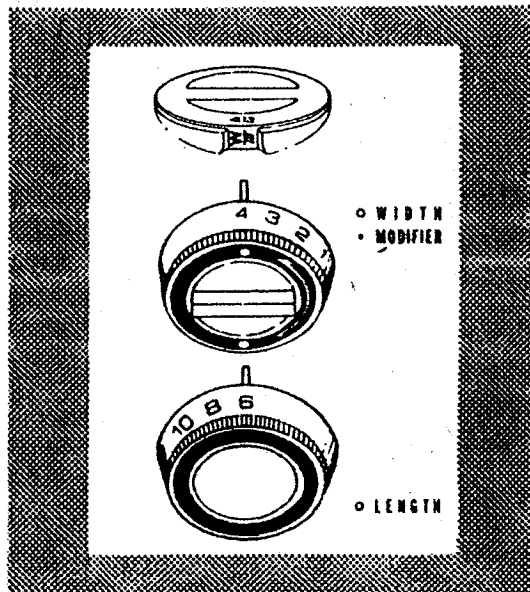

SHELL STITCHING

This stitch used on the edge of nylon tricot makes a lovely Shell finish. Use the following settings:

SETTINGS

Special Stitch Dial - \Rightarrow
Stitch Width Control - 4
Stitch Length Control - 10
Special Stitch Modifier - Red Dot
Zigzag Presser Foot
Zigzag Needle Plate

When sewing this stitch, allow needle to just clear the right edge of the fabric when it zig zags.

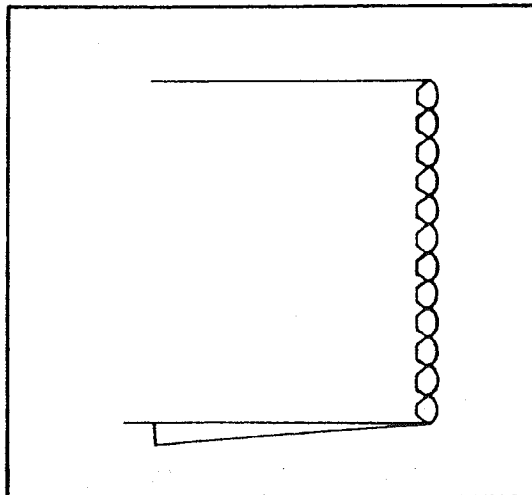

SPECIAL FINISHING STITCHES

After the basic construction of your garment is finished, there are still many finishing touches to be done. To aid your completion of your garment, the Kenmore has been designed to do the following tasks that formerly had to be done by hand.

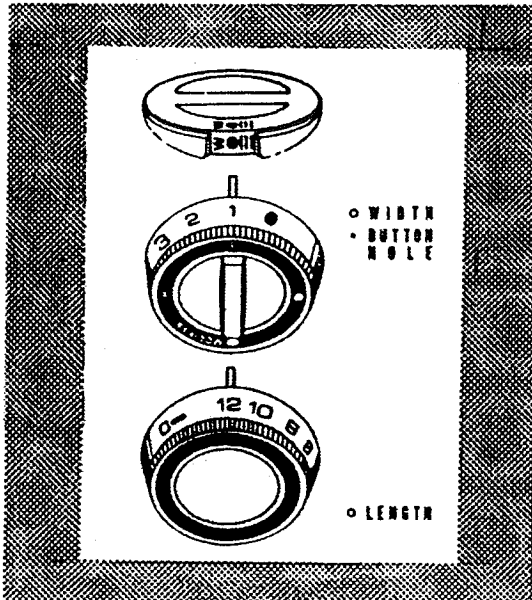

BUTTONHOLE MAKING (Model 1525)

SETTINGS

Special Stitch Dial - ∞ III
 Stitch Width Control - 1 to $1\frac{1}{2}$
 Stitch Length Control - 12
 Buttonhole Control - F
 Buttonhole Guide
 Zigzag Presser Foot
 Zigzag Needle Plate

1. Carefully mark the buttonhole length on your garment. Mount the buttonhole guide onto the presser foot so that rear edge of presser foot is at the rear end of the guide, with upper thread as shown. Place the fabric with buttonhole marked, under the buttonhole guide.

Without lowering the foot, let the needle pierce the fabric at the beginning of the buttonhole. Lower presser foot.

Reproduction of the identical size buttonholes is facilitated with the aid of the graduations on the left side of the buttonhole guide.

These graduations are $\frac{1}{8}$ " apart. Always start buttonhole with foot positioned at rear end of the guide. After first buttonhole is made, always stitch forward to point on front of guide as with first buttonhole. Graduations act as reference mark.

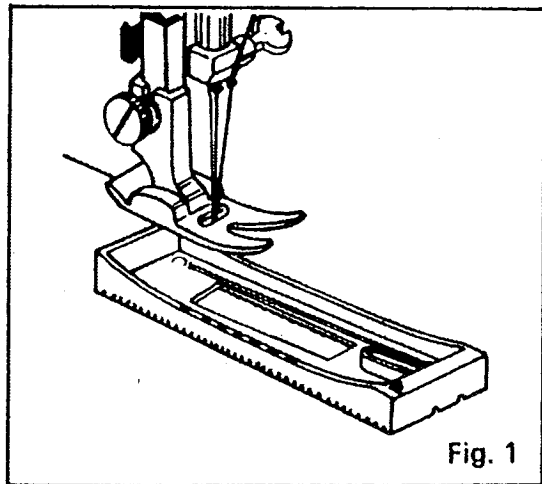

Fig. 1

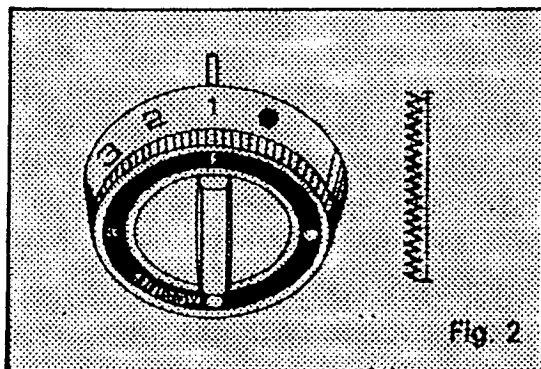
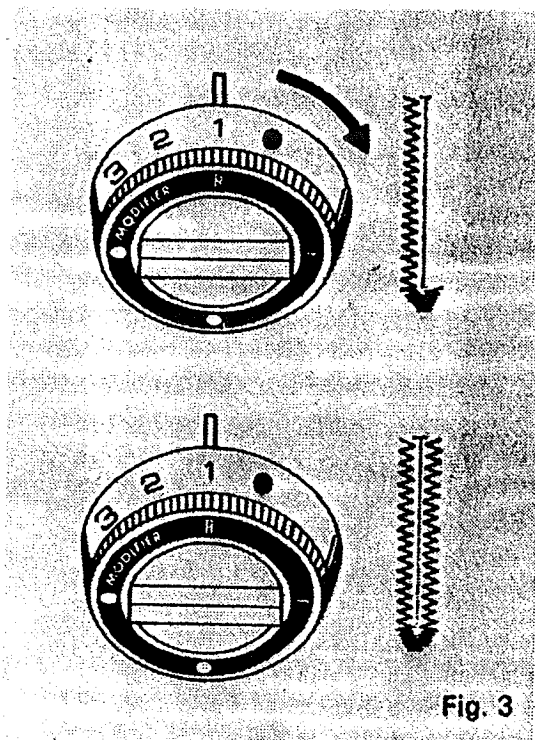

Fig. 2

2. With the buttonhole control at F, stitch forward until you approach the front marking of your buttonhole.

3. Turn the control to "R" stitching back to the beginning of the buttonhole. The speed with which the control is turned determines the number of stitches at the end of the buttonhole. The slower the control is turned while sewing, the more stitches formed.



4. Turn the control back to F to finish buttonhole.

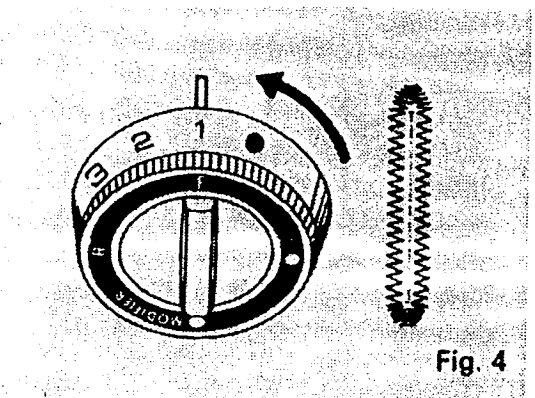

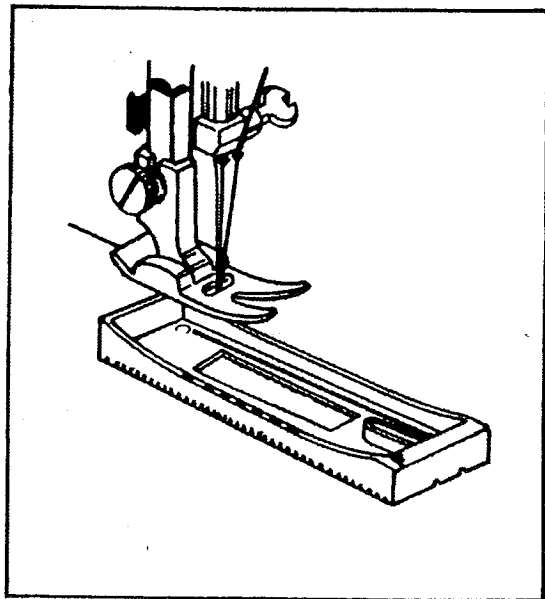
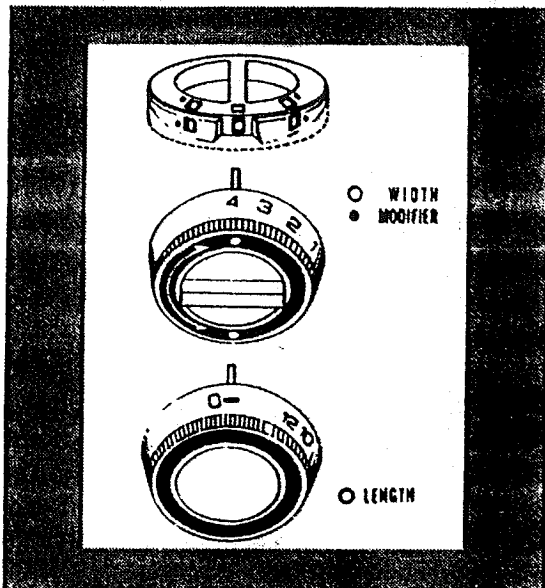

BUTTONHOLE MAKING

(Model 1947)

SETTINGS

- Step 1. Special Stitch Modifier - Red Dot
 Step 2. Special Stitch Dial - □
 Stitch Width Control - 4
 Stitch Length Control - Red Zone
 Zigzag Presser Foot
 Zigzag Needle Plate

1. Carefully mark the buttonhole length on your garment. Mount the buttonhole guide onto the presser foot so that rear edge of presser foot is at the rear end of the guide, with upper thread as shown. Place the fabric with buttonhole marked, under the buttonhole guide.

Without lowering the foot, let the needle pierce the fabric at the beginning of the buttonhole. Lower presser foot.

Reproduction of the identical size buttonholes is facilitated with the aid of the graduations on the left side of the buttonhole guide.

These graduations are 1/8" apart. Always start buttonhole with foot positioned at rear end of the guide. After first buttonhole is made, always stitch forward to point on front of guide as with first buttonhole. Graduations act as reference mark.

2. Set special stitch dial at □ and bartack several times at the marked beginning of the buttonhole. Stop sewing at the left stitch. Raise needle to its highest position by turning handwheel toward you manually.

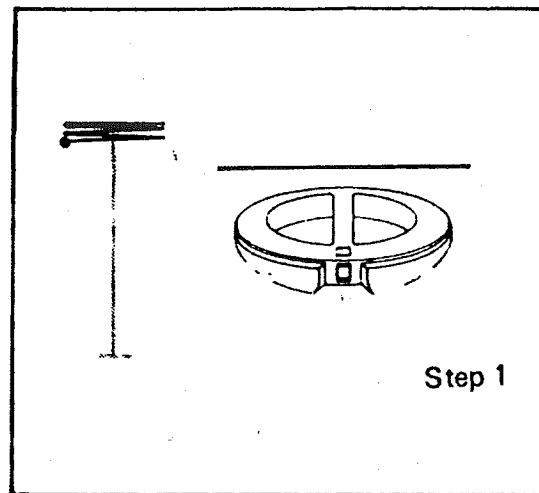

3. Set special stitch dial at ◐. Stitch forward until you approach the front marking of the buttonhole. Stop sewing at the left stitch and raise needle to its highest position as in Step 1.

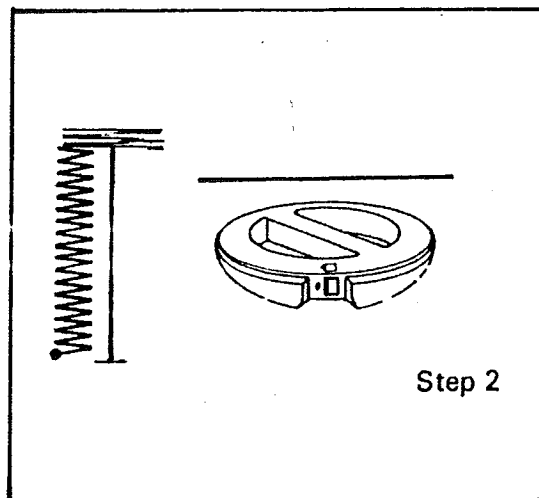

4. Set special stitch dial at □ again and bartack several times. Raise needle at its highest position as in Steps 1 and 2.

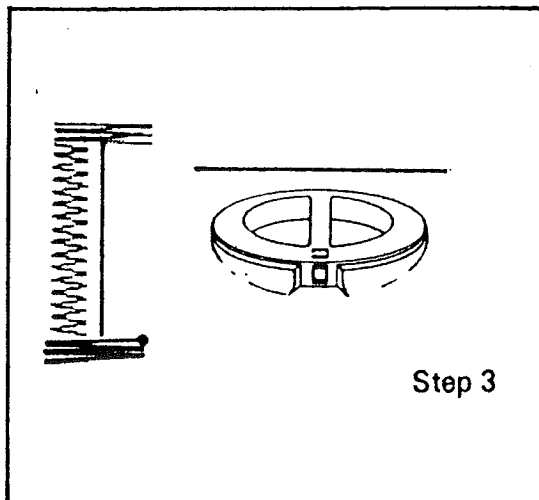

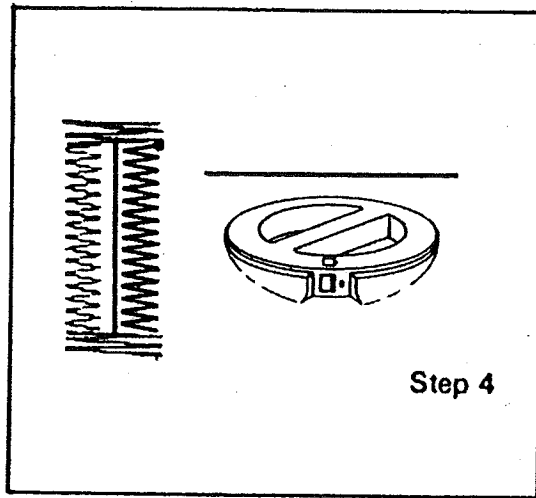

5. Set special stitch dial at \square and continue sewing until needle reaches beginning of your buttonhole.

If the forward stitching does not exactly match the reverse stitching, slightly adjust the stitch length control during forward sewing.

Always make a practice buttonhole on a scrap of fabric you plan to use. Try the buttonhole with the button you will use.

Always use an interfacing in area of garment where buttonholes are placed. Tissue paper or regular interfacing can be used. Tear paper away after stitching, if it is used.

For heavier weight fabrics, loosen your top tension slightly and use a wider stitch width setting.

BUTTONHOLE MAKING

(Model 1660, 1357)

SETTINGS

Special Stitch Dial - $\approx \bullet III$
Stitch Width Control - 1 to 1
Stitch Length Control - 0
Special Stitch Modifier - Red Dot
Feed Dogs - Down
Buttonhole Foot
Zigzag Needle Plate

1. Turn hand wheel so needle is down. Remove base front cover by pushing release button. Open shuttle cover. Insert buttonhole adapter minus cover plate with pinion gear. Insert cover plate at 45 degree angle. Snap into plate.
2. Screw guide pin into the guide pin hole on the machine bed directly behind the needle plate.
3. Insert a template into the slot of template holder by lifting the bottom portion of the Template Holder. Select the proper size buttonhole by turning the Template Advance Knob. Pull guide plate all the way forward so that guide pin is at S. This will enable you to start at one end of the buttonhole. Drop guide plate into place over gear on cover plate.
4. Pick up bobbin thread through guide plate by turning hand wheel and drawing thread to back of machine. Place fabric between presser foot and guide plate. Line up edge of fabric with marked indentation on guide. See Fig. 4. If you wish all buttonholes to be $3/4$ inch from edge of garment, line up fabric with $3/4$ inch marking each time you start sewing a buttonhole.

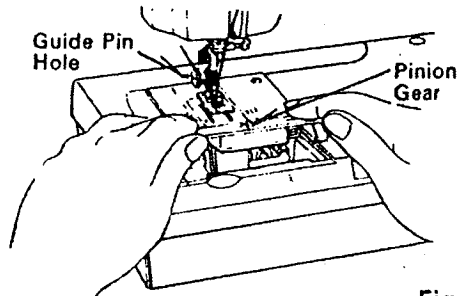

Fig. 1

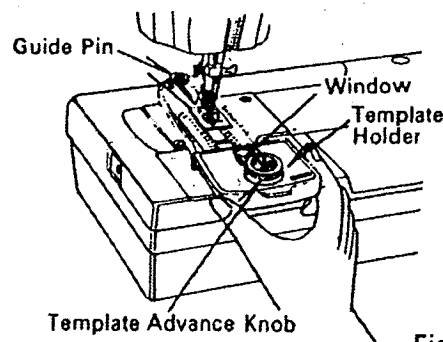

Fig. 2

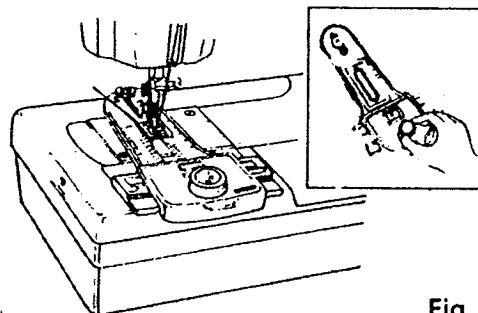

Fig. 3

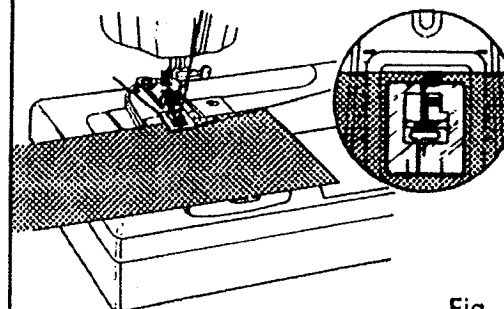

Fig. 4

BLIND HEMMING

SETTINGS

Special Stitch Dial - \llcorner
Stitch Width Control - 2 to 3
Stitch Length Control - 12 to 8
Special Stitch Modifier - Red Dot
Zigzag foot or edgestitcher if available
Zigzag Needle Plate

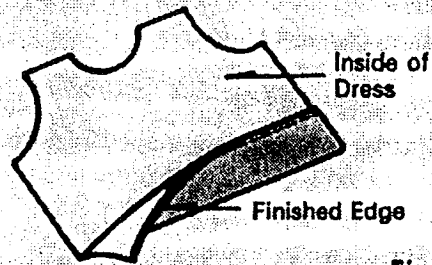

Fig. 1

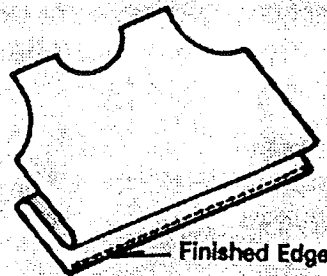

Fig. 2

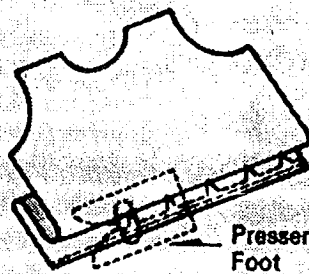

Fig. 3

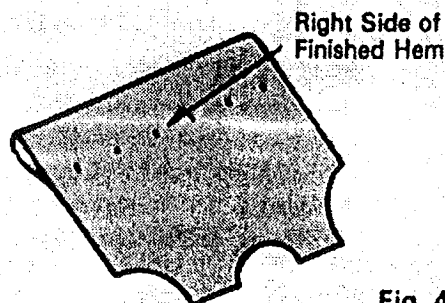

Fig. 4

1. Finish edge of hem anyway you desire. Turn up hem appropriate width. (Fig. 1)

2. Fold garment away from hem leaving 1/8" of hem edge extending. (Fig. 2)

3. Place garment under presser foot in such a manner that straight stitches will be sewn on extended edge. The zigzag stitch should just catch the fold of the garment. (Fig. 3)

4. Press both sides of the finished hem. The right side of the garment will show only the blind stitches. (Fig. 4)

SATIN STITCHING

SETTINGS

Special Stitch Dial - $\approx \bullet \parallel$
Stitch Width Control - 1 to 4
Stitch Length Control - Red Zone
Special Stitch Modifier - Red Dot
Satin Stitch Foot
Zigzag Needle Plate

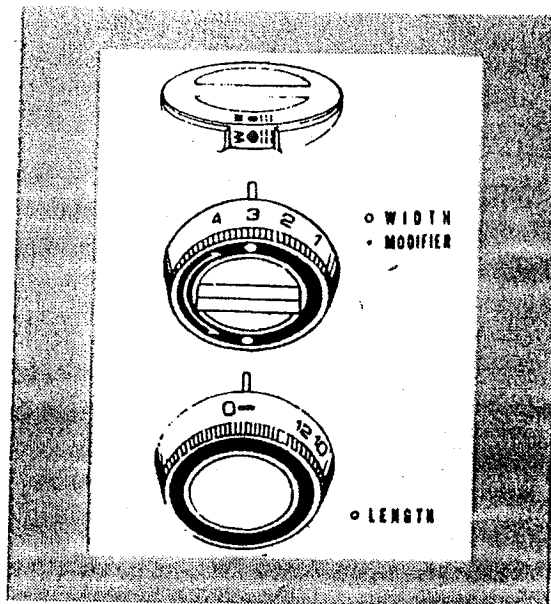

Closely spaced zigzag stitches are called satin stitches. This is an attractive stitch used for appliqueing, monogramming, buttonhole making.

Whenever you are using this stitch, it is well to remember to loosen the tension of the top thread slightly. The wider the stitch you make, the looser the tension should be.

If you are stitching on a very soft fabric, it is well to use a backing of tissue paper or interfacing for a well formed stitch. Puckering of the material will be eliminated and the bobbin thread will not be visible on the right side of the fabric.

As with all special stitches, it is best to make a sample design on your fabric before starting the design on the garment.

APPLIQUEING

SETTINGS

Same as with Satin Stitching

Select an applique design to be applied to your garment and baste it in place. Satin stitch around the raw edge of the applique completely covering the edge. You may want to do this with a contrasting color of thread or self color.

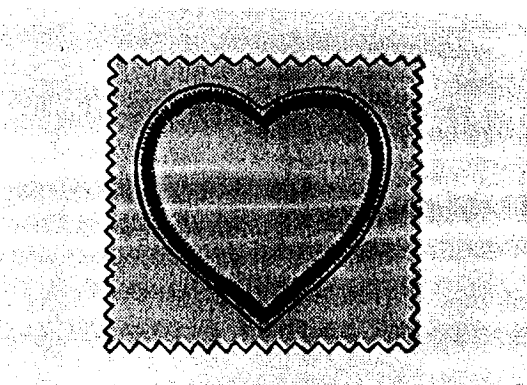

ZIPPER APPLICATION

SETTINGS

Special Stitch Dial - $\infty \bullet III$
Stitch Width Control - Red Dot
Stitch Length Control - 12 to 10
Special Stitch Modifier - Red Dot
Zipper Foot
Straight Stitch Needle Plate

REGULAR ZIPPER

The foot is adjustable for use on the right or left side of the needle when sewing the regular type of zipper. Adjust the foot so the needle clears the side notch on the foot. See Fig. 1. Carefully follow directions given on the zipper package.

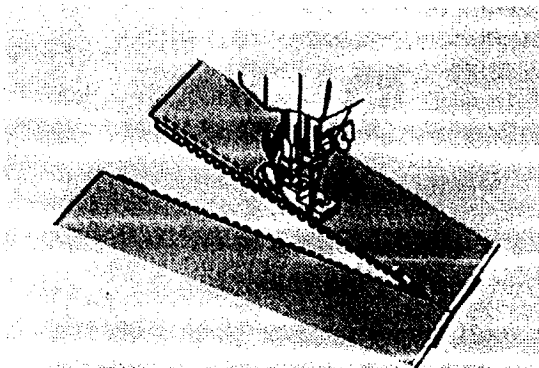

Fig. 1

INVISIBLE ZIPPER

Adjust the foot so the needle is sewing through the center hole of the foot and one groove of the foot is riding on the teeth of the zipper. See Fig. 2. Follow the zipper manufacturer's instructions.

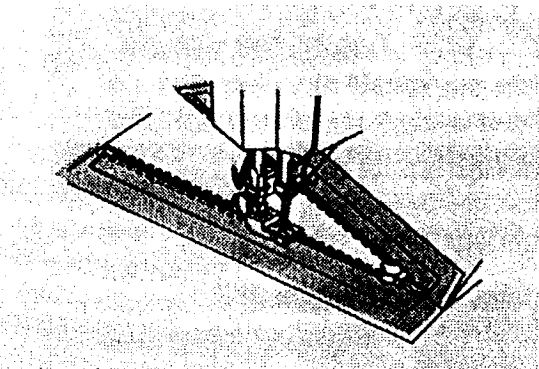

Fig. 2

After zipper has been inserted, finish sewing seam by shifting foot to side position sewing through side notch.

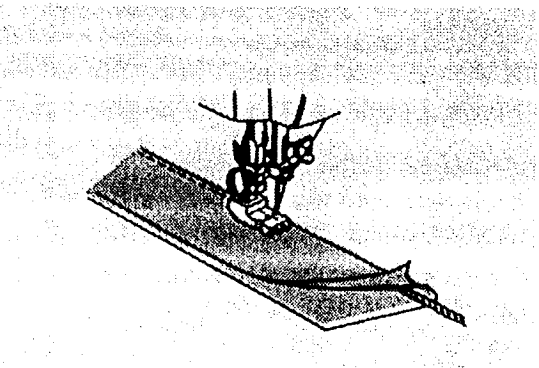

Fig. 3

CORDING

Foot can also be used to make cording for slipcovers etc. Cover a cord with a strip of bias fabric and sew as shown in Fig. 3.

MENDING

SETTINGS

Special Stitch Dial - ☼☼
Stitch Width Control - 4
Stitch Length Control - Red Zone
Special Stitch Modifier - Red Dot
Zigzag Presser Foot
Zigzag Needle Plate

To repair a straight or three-cornered tear, position the tear under the needle in such a way that the stitching catches both sides of the tear. When mending a three-cornered tear, stitch from each end to the center. It is well to use a piece of fabric under the tear for reinforcement.

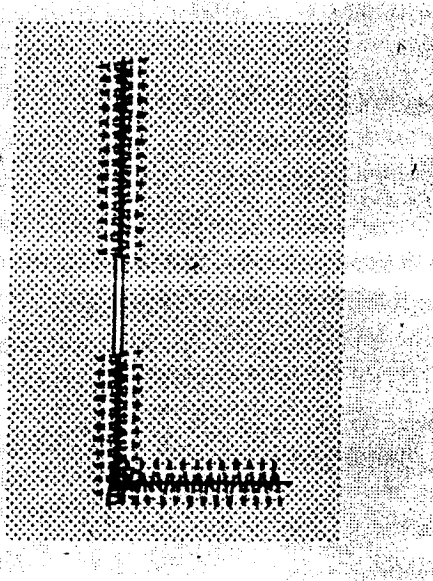

DARNING

SETTINGS

Special Stitch Dial - ☼●|||
Stitch Width Control - Red Dot
Special Stitch Modifier - Red Dot
Feed Dogs - Up
No Presser Foot

Remove presser foot, stretch fabric between embroidery hoops with hole centered. Draw the bobbin thread up through the fabric by holding the top thread and taking one stitch at the spot where you wish to start darning. Lowering the presser bar, start sewing at a slow to medium speed. Move the fabric back and forth with a steady rhythm to cover the darning area. When it is covered, turn the fabric and sew another layer of stitching across the first layer of stitching.

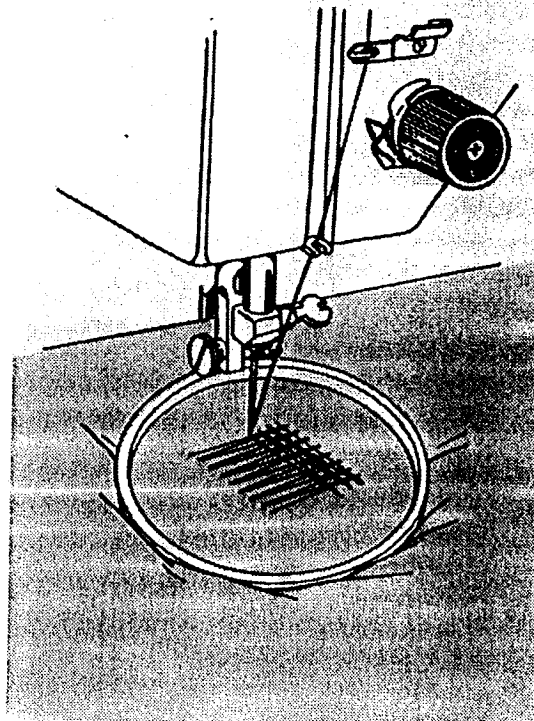

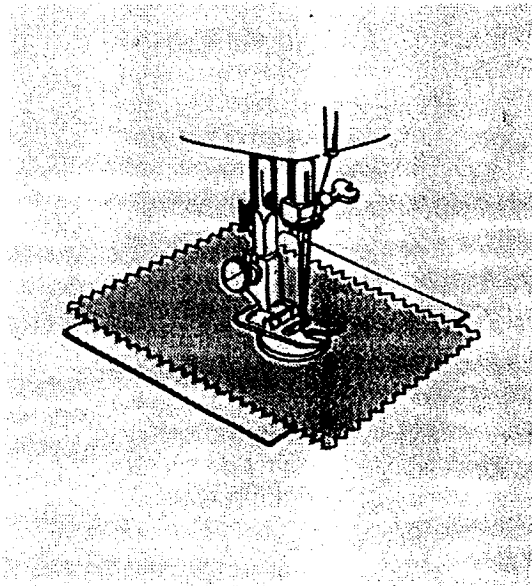

BUTTON SEWING

SETTINGS

Special Stitch Dial - ☞●|||
 Feed Dogs - Down
 Zigzag Presser Foot
 Zigzag Needle Plate

1. Align two holes of button with slot of presser foot and lower foot to hold the button securely.
2. Turn hand wheel manually until needle point is just above button.
3. Adjust stitch width control so needle will enter left hole of the button.
4. Turn hand wheel again by hand so needle enters second hole. Re-adjust stitch width if necessary. Stitch a number of times.
5. Finish sewing with an extra two inches of thread remaining. Draw these threads to reverse side of garment and tie.

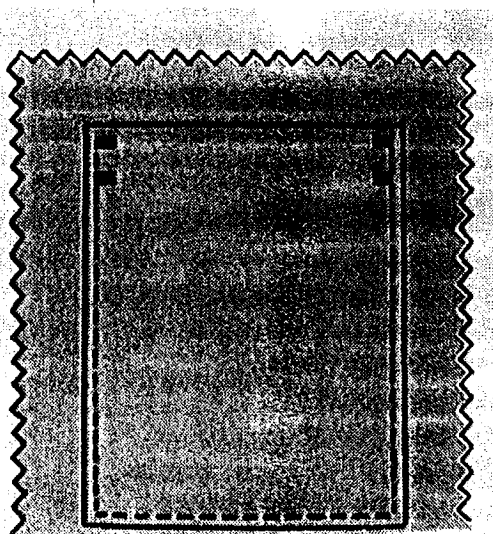

BAR TACKING

SETTINGS

Special Stitch Dial - ☞●|||
 Stitch Width Control - 1 to 4
 Stitch Length Control - Red Zone
 Buttonhole Control - Red Dot
 Zigzag Presser Foot
 Zigzag Needle Plate

This stitch is similar to a very short satin stitch and is used to reinforce points of strain such as corners of pockets and straps on lingerie.

Sew 4 to 6 zigzag stitches.

FREE-ARM SEWING

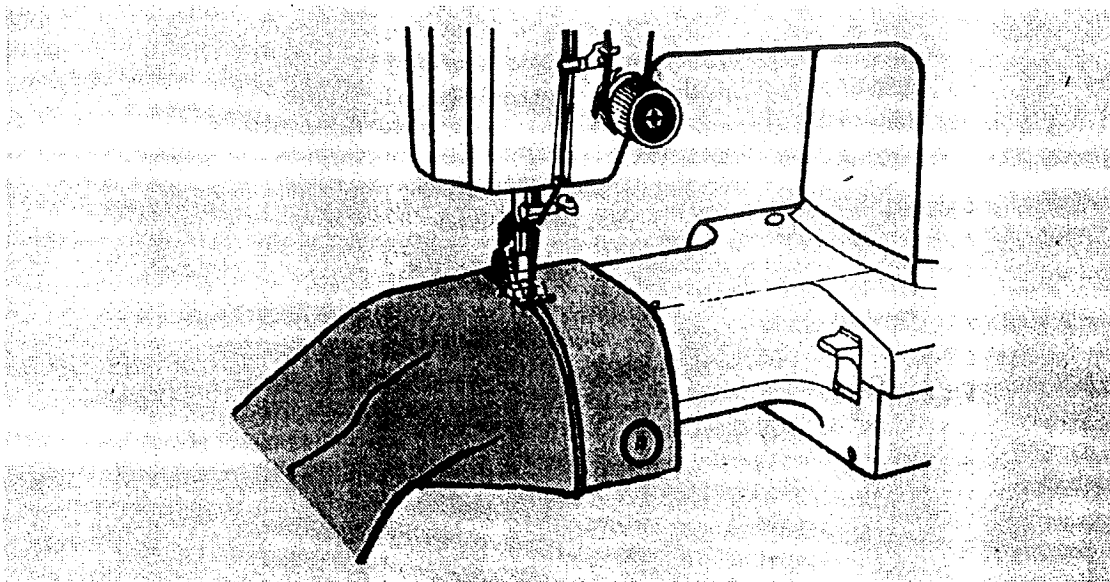

This sewing machine can be used like a flat bed machine, but easily converts to free arm machine by removing the base.

The free arm enables you to sew tubular types of pieces more easily. Just slip the sleeve or pants leg on the free arm as shown above.

You will find many uses for this free arm feature such as:

1. Mend elbows and knees of garments more easily.
2. Sew in sleeves more easily. This is especially true when sewing smaller garments.
3. Applique, embroider or hem around edges of cuffs or pants legs.
4. Sewing in elastic casings in skirts or pants at the waistline.



Checking Performance Problems WHAT TO DO

PROBLEM	PROBABLE CAUSE	CORRECTION
Irregular Stitches	<p>Incorrect size needle. Improper threading. Loose upper thread tension. Pulling fabric. Light pressure on presser foot. Loose presser foot. Unevenly wound bobbin. Nicks or burrs on shuttle. Nicks or burrs at hole of needle plate.</p>	<p>Choose correct size needle for thread and fabric. Rethread machine. Tighten upper thread tension. Do not pull fabric; guide it gently. Increase pressure on presser foot. Reset presser foot. Rewind bobbin. Replace shuttle, or polish off burrs completely. Replace needle plate, or polish off burrs completely.</p>
Breaking Needle	<p>Pulling fabric. Incorrect size needle. Incorrect setting of needle. Loose presser foot.</p>	<p>Do not pull fabric; guide it gently. Choose correct size needle for thread and fabric. Reset needle. Reset presser foot.</p>
Bunching of Thread	<p>Upper and lower threads not drawn back under presser foot before starting seam.</p>	<p>When starting a seam be sure to draw both threads under and back of presser foot about 4" and hold until a few stitches are formed.</p>
Puckering	<p>Incorrect thread tension(s). Light pressure on presser foot. Using two different sizes or kinds of thread. Bent or blunt needle. Loose presser foot. Fabric too sheer or too soft.</p>	<p>Reset thread tension(s). Increase pressure on presser foot. Upper thread and bobbin thread should be same size and kind. Insert new needle. Reset presser foot. Use underlay of tissue paper.</p>

PROBLEM	PROBABLE CAUSE	CORRECTION
Skipping Stitches	Incorrect size needle. Certain knits and synthetics. Bent or blunt needle. Incorrect setting of needle. Tight upper thread tension. Light pressure on presser foot.	Choose correct size needle for thread and fabric. Use "Q NEEDLE". Insert new needle. Reset needle. Loosen upper thread tension. Increase pressure on presser foot.
Breaking Upper Thread	Starting to stitch too fast. Improper threading. Tight upper thread tension. Incorrect size needle. Sharp eye in needle. Nicks or burrs on shuttle. Nicks or burrs at hole of needle plate.	Start to stitch at a medium speed. Rethread machine. Loosen upper thread tension. Choose correct size needle for thread and fabric. Insert new needle. Replace shuttle, or polish off burrs completely. Replace needle plate, or polish off burrs completely.
Breaking Bobbin Thread	Improper bobbin case threading. Tight bobbin thread tension. Lint in bobbin case or shuttle.	Check bobbin case threading. Loosen bobbin thread tension. Clean bobbin case and shuttle.
Fabric not Moving	Feed dog down. Light pressure on presser foot. Thread knotted under fabric.	Raise feed dog. Increase pressure on presser foot. Place both threads back under presser foot before beginning to stitch.
Machine Jamming Knocking Noise	Thread caught in shuttle.	Disassemble and clean shuttle.

4. CARING FOR THE MACHINE

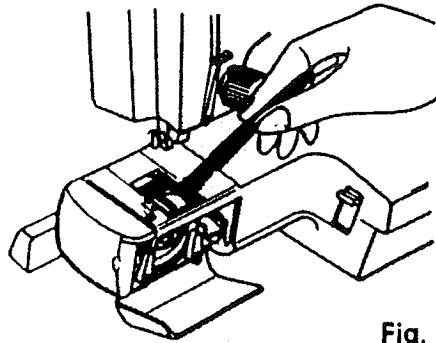

Fig. 1

CLEANING AND OILING

Fig. 1 Cleaning the feed dogs with a brush.

To insure the best possible operation of your machine, it is necessary to keep the essential parts clean at all times. Using a small brush, remove the lint that accumulates in the shuttle area and around the feed dogs.

Fig. 2 Parts of the Shuttle Assembly

To Clean the Shuttle Area:

1. This area must be kept free of dust, lint and occasional tangled thread. Raise the needle bar to its highest point and remove the bobbin case.
2. Push levers of shuttle race aside and lift shuttle race cover and shuttle out.
3. Clean the shuttle race with small brush.
4. Put a drop of oil on the center pin of the shuttle and shuttle race. (see arrows)

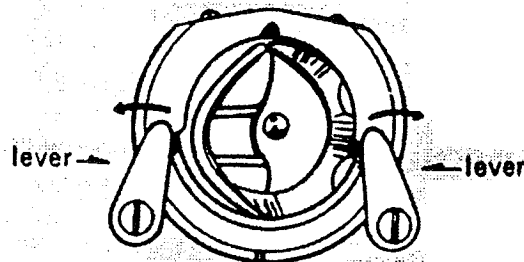

Shuttle Assembly

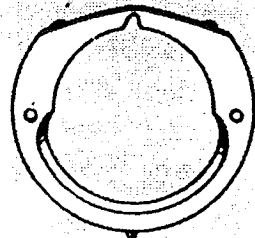

Shuttle Race Cover

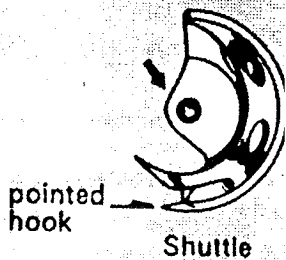

Shuttle

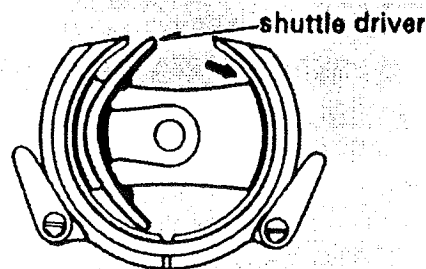

Shuttle Race

To Replace Shuttle Assembly:

1. Position shuttle race as illustrated so that shuttle driver is forming half moon on the left side of the machine.
2. Hold shuttle by center pin and position shuttle so as to form a half moon on the right side. Pointed hook will be on the bottom.
3. Place shuttle race cover into place over shuttle assembly.

Fig. 2

OILING UNDER ARM COVER PLATE

Remove arm cover plate to oil points indicated in top of machine head. To remove cover plate, insert a screw driver into the spacing between arm casting and top cover plate and lift the cover plate as illustrated below.

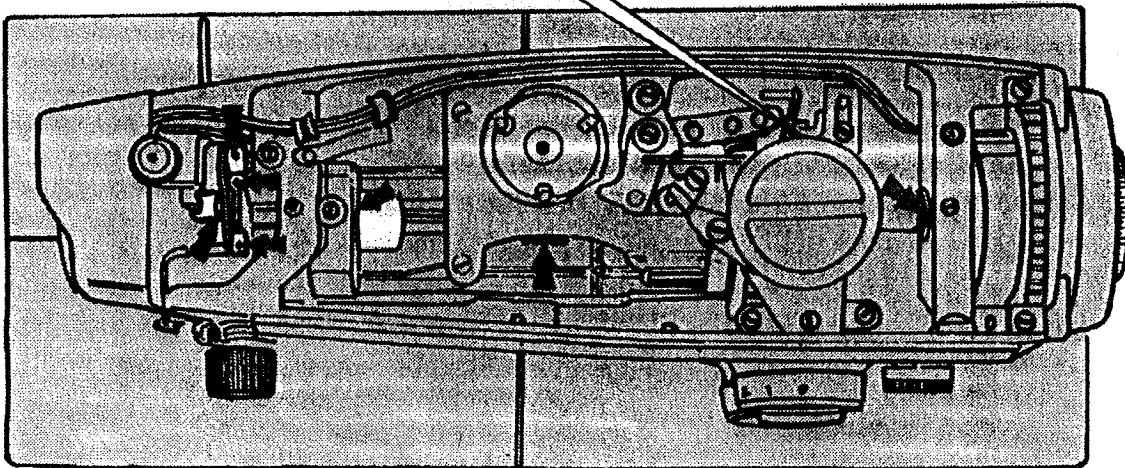
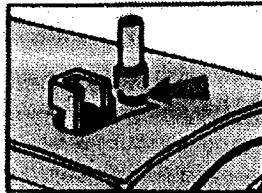
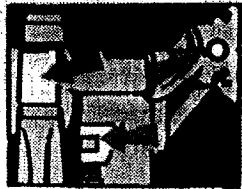
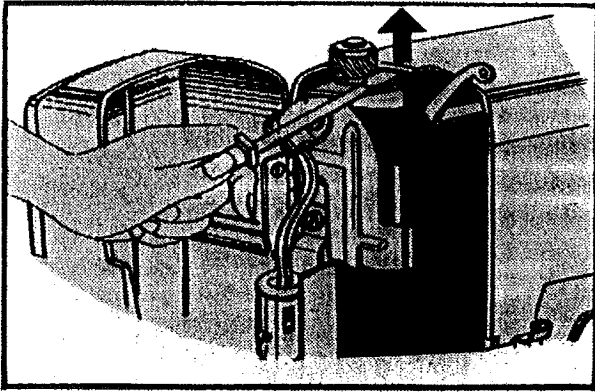

OILING UNDERSIDE

Tilt machine head back and remove bottom cover to oil points indicated on underside of machine. To remove bottom cover, remove screws (A), (B), (C), (D) and (E) as shown below.

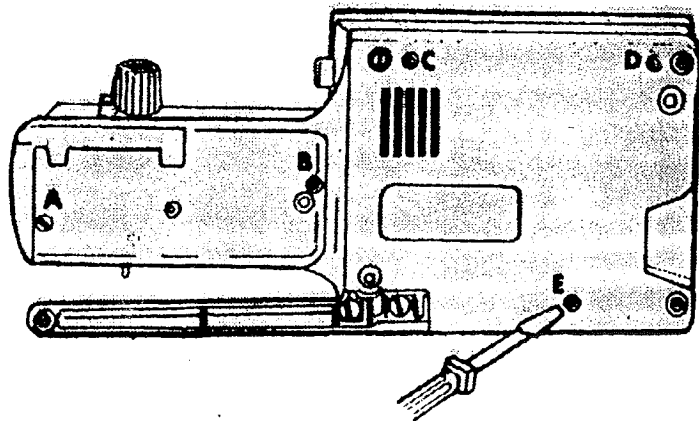
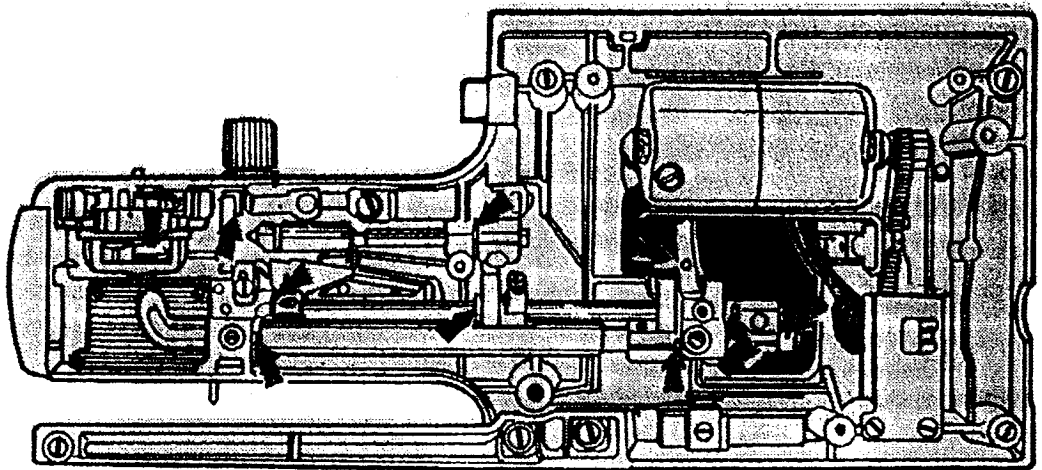

OILING UNDERSIDE

Tilt machine head back to oil points indicated on underside of machine.

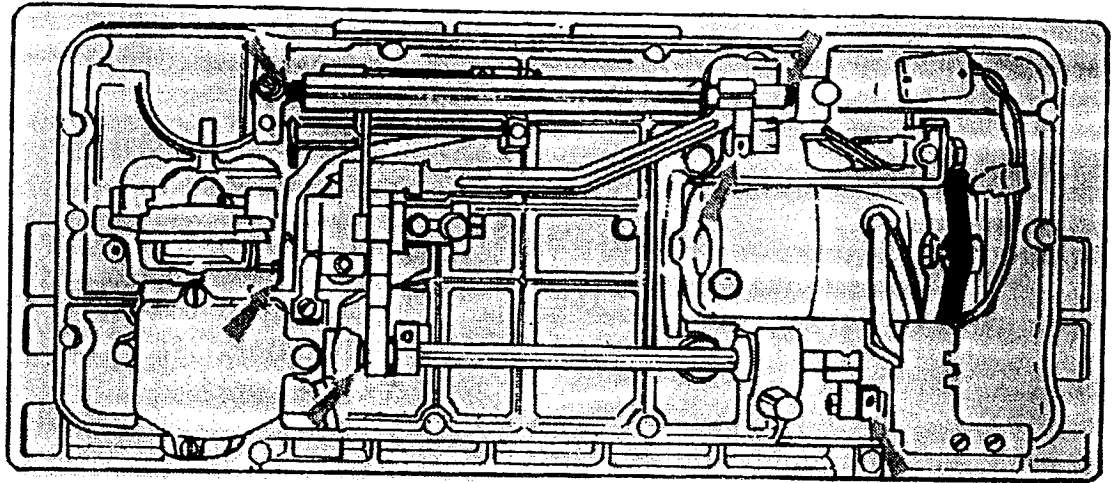

OILING IN FACE COVER PLATE

Swing hinged face cover plate open and oil points indicated in illustration.

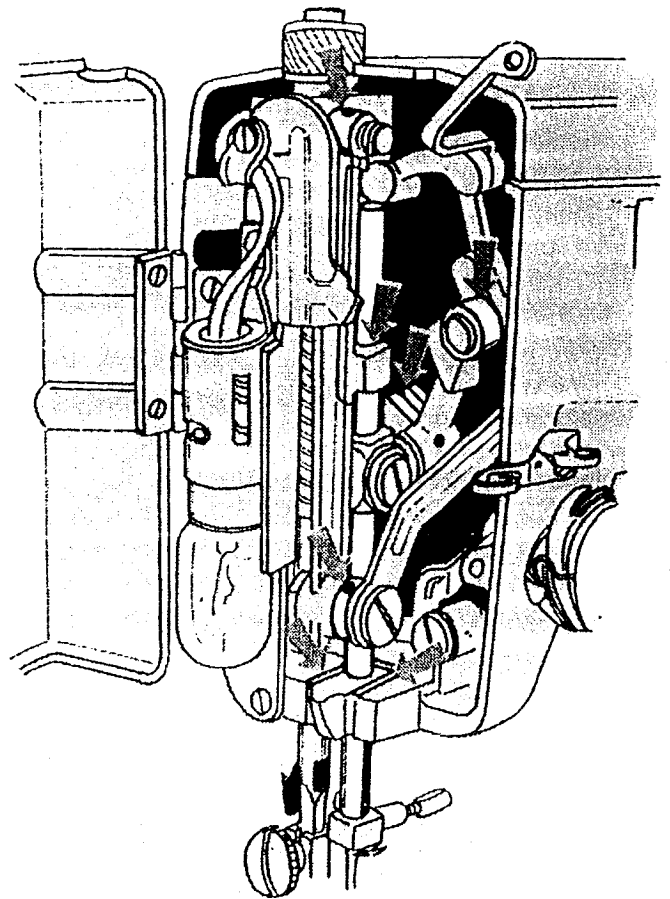

PARTS LIST

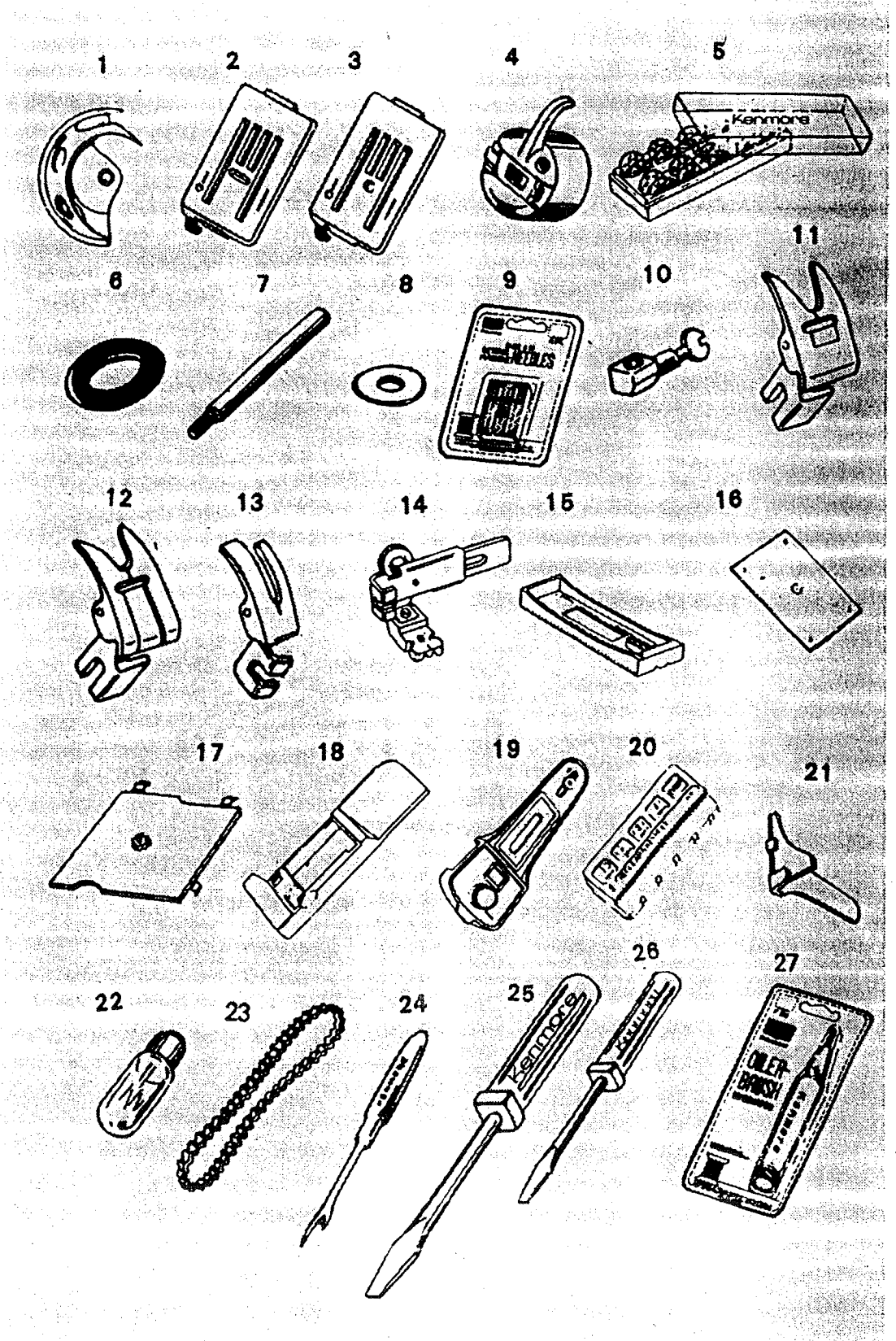

PARTS LIST

All parts listed herein may be ordered from any Sears, Roebuck and Co. or Simpsons-Sears Limited store or service center.

WHEN ORDERING REPAIR PARTS, ALWAYS GIVE THE FOLLOWING INFORMATION:

- | | |
|-----------------|---------------------|
| 1. PART NUMBER | 2. PART DESCRIPTION |
| 3. MODEL NUMBER | 4. NAME OF ITEM |

If the parts you need are not stocked locally, your order will be electronically transmitted to a Sears Repair Parts Distribution Center for expedited handling.

Ref. No.	Part No.	Description
1	47	Shuttle
2	38295	Needle plate insert ... Zigzag stitch
3	38296	Needle plate insert ... Straight stitch
4	6510	Bobbin case
5	*6862	Bobbin box with 10 bobbins
6	1939	Bobbin winder rubber ring
7	8286	Thread spool pin
8	2273	Nylon disc
9	*6740	No. 9 Single needles in orange case
	*6741	No. 11 Single needles in yellow case
	*6742	No. 14 Single needles in red case
	*6743	No. 16 Single needles in green case
	*6744	No. 18 Single needles in blue case
	*6746	"Q NEEDLES"™ in chocolate case
10	36353	Needle clamp with screw
11	40390	Standard zigzag foot
12	6870	Satin stitch foot
13	6873	Straight stitch foot
14	6757	Zipper foot
15	41620	Buttonhole guide
16	40530	Buttonhole cover plate
17	36214	Buttonhole cover plate
18	48274	Buttonhole adapter
19	41664	Buttonhole guide plate
20	35346	Buttonhole template (No. 1)
	35347	Buttonhole template (No. 2)
21	6864	Needle threader
22	6797	Light bulb
23	41152	Motor belt
	41014	Motor belt
24	6830	Buttonhole opener
25	41670	Large screw driver
26	41669	Small screw driver
27	*6889	Oil and lint brush

*These items are not furnished with the machine, but may be ordered per instructions above.

SEWING MACHINE

Now that you have purchased your Sewing Machine, should a need ever exist for repair parts or service, simply contact any Sears Service Center and most Sears, Roebuck and Co. or Simpsons-Sears Limited Stores. Be sure to provide all pertinent facts when you call or visit.

The model number of your Sewing Machine will be shown on your nomenclature plate on the back of your Sewing Machine. See Section 1, page 3 for location.

WHEN ORDERING REPAIR PARTS, ALWAYS GIVE THE FOLLOWING INFORMATION:

***MODEL NUMBER *NAME OF ITEM *PART DESCRIPTION**

If the parts you need are not stocked locally, your order will be electronically transmitted to a Sears Repair Parts Distribution Center for handling.

**SEARS, ROEBUCK AND CO., Chicago, IL 60684 U.S.A. and
SIMPSONS-SEARS LIMITED, Toronto, Ontario, Canada**

Free Manuals Download Website

<http://myh66.com>

<http://usermanuals.us>

<http://www.somanuals.com>

<http://www.4manuals.cc>

<http://www.manual-lib.com>

<http://www.404manual.com>

<http://www.luxmanual.com>

<http://aubethermostatmanual.com>

Golf course search by state

<http://golfingnear.com>

Email search by domain

<http://emailbydomain.com>

Auto manuals search

<http://auto.somanuals.com>

TV manuals search

<http://tv.somanuals.com>