

# Owner's Manual



## POWER MISER™ 12 GAS WATER HEATER

FOR POTABLE WATER HEATING ONLY.  
NOT SUITABLE FOR SPACE HEATING.  
NOT FOR USE IN MOBILE HOMES.

### MODEL NO.

153.331712HA 75 Gallon High Altitude  
153.331740 75 Gallon

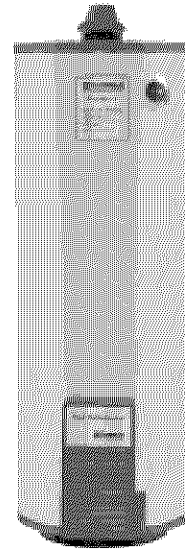

- Safety Instruction
- Installation
- Operation
- Care and Maintenance
- Troubleshooting
- Parts List



### For Your Safety

AN ODORANT IS ADDED TO THE GAS  
USED BY THIS WATER HEATER.

**WARNING:** If the information in these instructions is not followed exactly, a fire or explosion may result causing property damage, personal injury or death.

### ⚠ WARNING

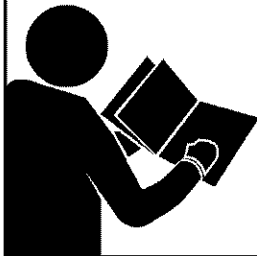

Read and understand instruction manual and safety messages before installing, operating or servicing this water heater.

Failure to follow instructions and safety messages could result in death or serious injury.

Instruction manual must remain with water heater.

— Do not store or use gasoline or other flammable vapors and liquids in the vicinity of this or any other appliance.

#### — WHAT TO DO IF YOU SMELL GAS:

- Do not try to light any appliance.
- Do not touch any electrical switch; do not use any phone in your building.
- Immediately call your gas supplier from a neighbor's phone. Follow the gas supplier's instructions.
- If you cannot reach your gas supplier, call the fire department.

— Installation and service must be performed by a qualified installer, service agency or the gas supplier.

### ADVERTENCIA

Si no puede leer o entender el inglés y necesita el manual instructivo y/o etiquetas en español puede obtenerlos llamando al 1-800-821-2017. NO TRATE DE INSTALAR O OPERAR ESTE CALENTADOR DE AGUA si no entiende la información en las etiquetas o en el manual instructivo. No hacer caso de esta advertencia podría resultar en la MUERTE O GRAVES LESIONES CORPORALES.

Sears, Roebuck and Co., Hoffman Estates, IL 60179 U.S.A





# SAFE INSTALLATION, USE AND SERVICE

Your safety and the safety of others is extremely important in the installation, use and servicing of this water heater.

Many safety-related messages and instructions have been provided in this manual and on your own water heater to warn you and others of a potential injury hazard. Read and obey all safety messages and instructions throughout this manual. It is very important that the meaning of each safety message is understood by you and others who install, use or service this water heater.



This is the safety alert symbol. It is used to alert you to potential personal injury hazards. Obey all safety messages that follow this symbol to avoid possible injury or death.

	<b>DANGER</b> indicates an imminently hazardous situation which, if not avoided, could result in death or injury.
	<b>WARNING</b> indicates a potentially hazardous situation which, if not avoided, could result in death or injury.
	<b>CAUTION</b> indicates a potentially hazardous situation which, if not avoided, may result in minor or moderate injury.
	<b>CAUTION</b> used without the safety alert symbol indicates a potentially hazardous situation which, if not avoided, could result in property damage.

All safety messages will generally tell you about the type of hazard, what can happen if you do not follow the safety message and how to avoid the risk of injury.

## IMPORTANT DEFINITIONS

- **Gas Supplier:** The natural gas or propane utility or service who supplies gas for utilization by the gas burning appliances within this application. The gas supplier typically has responsibility for the inspection and code approval of gas piping up to and including the natural gas meter or propane storage tank of a building. Many gas suppliers also offer service and inspection of appliances within the building.

# SAFETY PRECAUTIONS

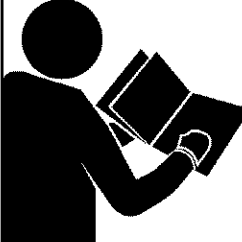

**⚠ WARNING**

Read and understand instruction manual and safety messages before installing, operating or servicing this water heater.

Failure to follow instructions and safety messages could result in death or serious injury.

Instruction manual must remain with water heater.



**⚠ WARNING**

**Fire Hazard**

For continued protection against risk of fire:

- Do not install water heater on carpeted floor.
- Do not operate water heater if flood damaged.

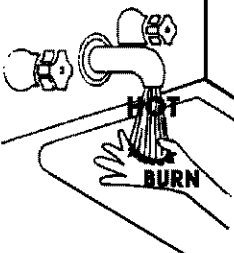

**⚠ DANGER**

Water temperature over 125°F (52°C) can cause severe burns instantly resulting in severe injury or death.

Children, the elderly, and the physically or mentally disabled are at highest risk for scald injury.

Feel water before bathing or showering.

Temperature limiting valves are available.

Read instruction manual for safe temperature setting.

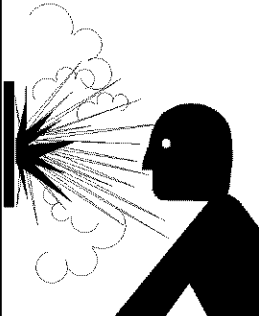

**⚠ WARNING**

**Explosion Hazard**

- Overheated water can cause water tank explosion.
- Properly sized temperature and pressure relief valve must be installed in opening provided.

**⚠ WARNING**

**Fire or Explosion Hazard**

- Do not expose water heater control to excessive gas pressure.
- Use only gas shown on rating plate.
- Maintain required clearances to combustibles.
- Keep ignition sources away from faucets after extended period of non-use.

Read instruction manual before installing, using or servicing water heater.

**⚠ WARNING**

**Breathing Hazard - Carbon Monoxide Gas**

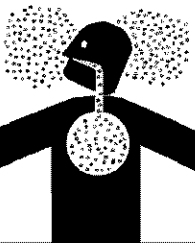

- Install vent system in accordance with codes.
- Do not operate water heater if flood damaged.
- High altitude orifice must be installed for operation above 3,300 feet (1,006 m) (or above 5,500 (1,676 m) feet for high altitude models).
- Do not operate if soot buildup.
- Do not obstruct water heater air intake with insulating jacket.
- Do not place chemical vapor emitting products near water heater.
- Gas and carbon monoxide detectors are available.

Breathing carbon monoxide can cause brain damage or death. Always read and understand instruction manual.

**⚠ DANGER**

**Fire or Explosion Hazard**

- Do not store or use gasoline or other flammable vapors and liquids in the vicinity of this or any other appliance.



FLAMMABLE

Flammable Vapors

**CAUTION**

**Improper installation and use may result in property damage.**

- Do not operate water heater if flood damaged.
- Inspect and replace anode.
- Install in location with drainage.
- Fill tank with water before operation.
- Be alert for thermal expansion.

Refer to instruction manual for installation and service.

# TABLE OF CONTENTS

SAFE INSTALLATION, USE AND SERVICE .....	2
SAFETY PRECAUTIONS .....	3
TABLE OF CONTENTS .....	4
CUSTOMER RESPONSIBILITIES .....	5
PRODUCT SPECIFICATIONS .....	5
MATERIALS AND BASIC TOOLS NEEDED .....	6
Material Needed .....	6
Basic Tools .....	6
TYPICAL INSTALLATION .....	7
INSTALLATION INSTRUCTIONS .....	8-17
Removing the Old Water Heater .....	8
Facts to Consider About the Location .....	9-10
Insulation Jackets .....	10
Combustion Air and Ventilation Appliances in Unconfined Spaces .....	11
Combustion Air and Ventilation Appliances in Confined Spaces .....	11,12
Water Piping .....	12,13
T & P Valve and Pipe Insulation .....	13
Temperature Pressure Relief Valve .....	13,14
Filling the Water Heater .....	14,15
Venting .....	15,16
Gas Piping .....	16,17
Sediment Trap .....	17
OPERATING INSTRUCTIONS .....	18-19
Lighting & Operating Label .....	18
Temperature Regulation .....	19
SERVICE AND ADJUSTMENT .....	20-22
Tank (Sediment) Cleaning .....	20
Venting System Inspection .....	20
Burner Inspection .....	20
Burner Cleaning .....	20
Housekeeping .....	20,21
Anode Rod Inspection .....	21
Temperature-Pressure Relief Valve Operation .....	21
Draining .....	21,22
Drain Valve Washer Replacement .....	22
Service .....	22
TROUBLESHOOTING GUIDE .....	23-26
Start Up Conditions .....	23-24
Thermal Expansion .....	23
Strange Sounds .....	23
Draft Hood Operation .....	23,24
Condensation .....	24
Smoke/Odor .....	24
Operational Conditions .....	24-25
Smelly Odor .....	24
Air in Hot Water Faucets .....	24
High Temperature Shut-Off System .....	24
Leakage Checkpoints .....	25
Troubleshooting Guide .....	26
PARTS ORDER LIST .....	27
WARRANTY .....	28

## CUSTOMER RESPONSIBILITIES

**Thank You** for purchasing a Kenmore water heater. Properly installed and maintained, it should give you years of trouble free service. If you should decide that you want the new water heater professionally installed by Sears call 1-800-4-MY-HOME®. They will arrange for prompt, quality installation by Sears authorized contractors.

### Abbreviations Found In This Instruction Manual:

- CSA - Canadian Standards Association
- ANSI - American National Standards Institute
- NFPA - National Fire Protection Association
- ASME - American Society of Mechanical Engineers
- GAMA - Gas Appliance Manufacturers Association
  
- This gas-fired water heater is design certified by CSA INTERNATIONAL under American National Standard/CSA Standard for Gas Water Heaters ANSI Z21.10.1 • CSA 4.1 (current edition).
  
- Read the "Safety Precautions" section, page 3 of this manual first and then the entire manual carefully. If you don't follow the safety rules, the water heater will not operate properly. It could cause DEATH, SERIOUS BODILY INJURY AND/OR PROPERTY DAMAGE.

This manual contains instructions for the installation, operation, and maintenance of the gas-fired water heater. It also contains warnings through out the manual that you must read and be aware of. All warnings and all instructions are essential to the proper operation of the water heater and your safety. Since we cannot put everything on the first few pages, **READ THE ENTIRE MANUAL BEFORE ATTEMPTING TO INSTALL OR OPERATE THE WATER HEATER.**

- The installation must conform with these instructions and the local code authority having jurisdiction. In the absence of local codes, installations shall comply with the following:

**In the United States:** The National Fuel Gas Code ANSI Z223.1/NFPA 54. This publication is available from the Canadian Standards Association, 8501 East Pleasant Valley Rd, Cleveland Ohio 44131, or The National Fire Protection Association, 1 Batterymarch Park, Quincy, MA 02269.

- If after reading this manual you have any questions or do not understand any portion of the instructions, call the Sears Service Center.
  
- Carefully plan the place where you are going to put the water heater. Correct combustion, vent action, and vent pipe installation are very important in preventing death from possible carbon monoxide poisoning and fires. See figure 1.  
  
Examine the location to ensure the water heater complies with the *Facts to Consider About the Location* section in this manual.
  
- For California installation this water heater must be braced, anchored, or strapped to avoid falling or moving during an earthquake. See instructions for correct installation procedures. Instructions may be obtained from your local dealer, wholesaler, public utilities or California Office of the State Architect, 400 P Street, Sacramento, CA 95814.
  
- Massachusetts Code requires this water heater to be installed in accordance with Massachusetts 248-CMR 2.00: State Plumbing Code and 248-CMR 5.00.
  
- Complies with SCAQMD rule #1121 and districts having equivalent NOx requirements.

## PRODUCT SPECIFICATIONS

MODEL NUMBER	TANK CAPACITY IN GALS (LTRS)	TYPE OF GAS	BTU RATE	RECOVERY RATE GALS. PER HOUR @ 90°F RISE	MINIMUM VENT PIPE INCHES (mm)	DIAMETER INCHES (mm)	DIMENSIONS IN INCHES (mm) HEIGHT TO JACKET TOP
153.331712HA	75 (284)	NATURAL	55,000	59.2	4" (102)	24" (610)	60" (1,524)
153.331740	75 (284)	NATURAL	55,000	59.2	4" (102)	24" (610)	60" (1,524)

# MATERIALS AND BASIC TOOLS NEEDED

## Materials Needed

To simplify the installation Sears has available the installation parts shown below. You may or may not need all of these material, depending on your type of installation.

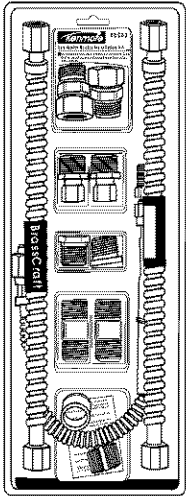

**WATER HEATER INSTALLATION KIT WITH FLEXIBLE CONNECTORS FOR 3/4" (19.05 mm) OR 1/2" (12.7 mm) THREADED OR COPPER PLUMBING**

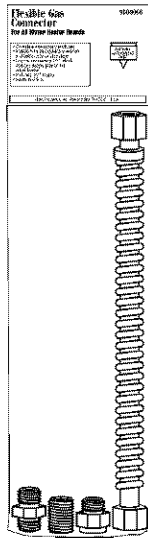

**FLEXIBLE WATER HEATER GAS CONNECTOR WITH FITTINGS**

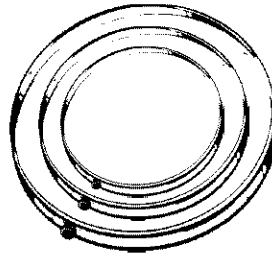

**DRAIN PANS AVAILABLE IN 20" (508 mm) DIAMETER FOR WATER HEATERS HAVING A DIAMETER 18" (457 mm) OR LESS, 24" (610mm) DIAMETER FOR WATER HEATERS HAVING A DIAMETER 22" (559 mm) OR LESS AND AVAILABLE IN 28" (711 mm) DIAMETER FOR WATER HEATERS HAVING A DIAMETER 26" (660 mm) OR LESS**

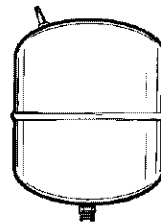

**EXPANSION TANKS FOR THERMAL EXPANSION CONDITIONS AVAILABLE IN 2 GALLONS (7.6 LITERS) AND 5 GALLONS (18.9 LITERS) CAPACITY THROUGH LOCAL SEARS STORE OR SERVICE CENTER**

## Basic Tools

You may or may not need all these tools, depending on your type of installation. These tools can be purchased at your local Sears Store.

- Pipe Wrenches (2) 14" (356 mm)
- Screwdriver
- Tin Snips
- 6' (1.82 m) Tape or Folding Ruler
- Garden Hose
- Drill
- Pipe Dope or Teflon Tape

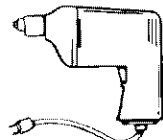

**DRILL**



**SLOT-HEAD SCREWDRIVER**

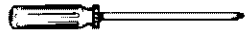

**PHILLIPS SCREWDRIVER**

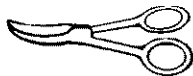

**TIN SNIPS**



**ROLL OF TEFLON TAPE (USE ONLY ON WATER HEATER CONNECTIONS)**

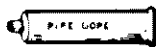

**PIPE DOPE (SQUEEZE TUBE) USE FOR WATER AND GAS CONNECTIONS**



**GARDEN HOSE**



**6 FOOT TAPE**



**PIPE WRENCH**

## Additional Tools Needed When Sweat Soldering

- Tubing Cutters or Hacksaw
- Propane Tank
- Soft Solder
- Solder Flux
- Emery Cloth
- Wire Brushes



**TUBING CUTTER**



**PROPANE TORCH**



**HACKSAW**



**ROLL OF EMERY CLOTH**



**3/4" (19 mm) WIRE BRUSH**



**1/2" (13 mm) WIRE BRUSH**



**ROLL OF LEAD-FREE SOFT SOLDER**



**SOLDER FLUX**

# TYPICAL INSTALLATION

## GET TO KNOW YOUR WATER HEATER - GAS MODELS

- |                              |                                     |                                |
|------------------------------|-------------------------------------|--------------------------------|
| A Vent Pipe                  | J Drip Leg (Sediment Trap)          | S Flue Baffle                  |
| B Draft Hood                 | K Inner Door                        | T Thermostat                   |
| C Anode                      | L Outer door                        | U Drain Valve                  |
| D Hot Water Outlet           | M Union                             | V Pilot and Main Burner        |
| E Outlet                     | N Inlet Water Shut-off Valve        | W Flue                         |
| F Flexible Water Connections | O Cold Water Inlet                  | X Drain Pan                    |
| G Gas Supply                 | P Inlet Dip Tube                    | Y Thermostat Shield (optional) |
| H Manual Gas Shut-off Valve  | Q Temperature-Pressure Relief Valve |                                |
| I Ground Joint Union         | R Rating Plate                      |                                |

\* INSTALL IN ACCORDANCE WITH LOCAL CODES.

\* DRIP LEG AS REQUIRED BY LOCAL CODES.

TO VENT TERMINATION ON ROOF

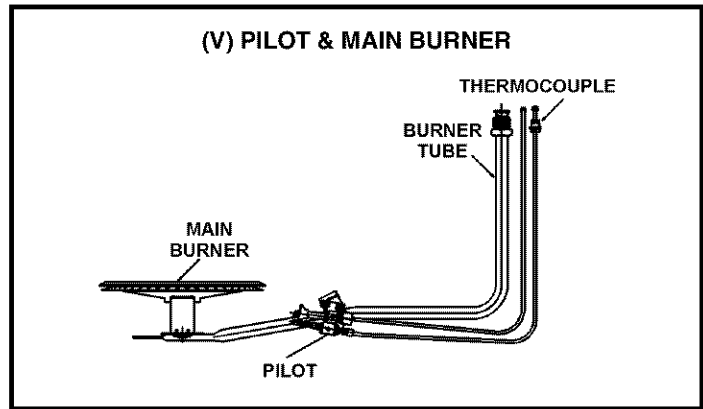
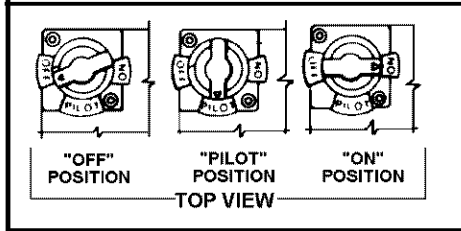
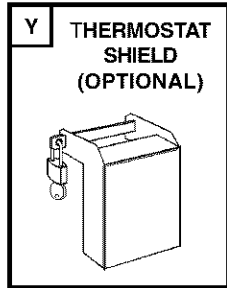
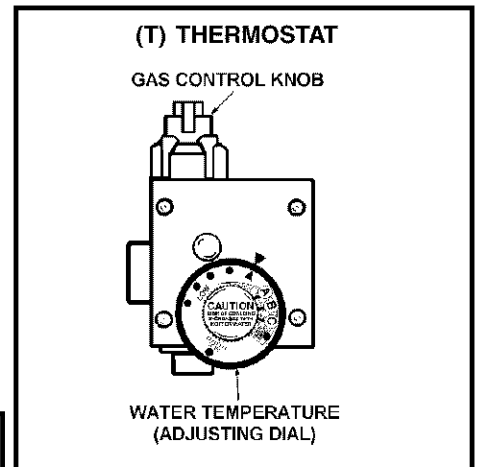
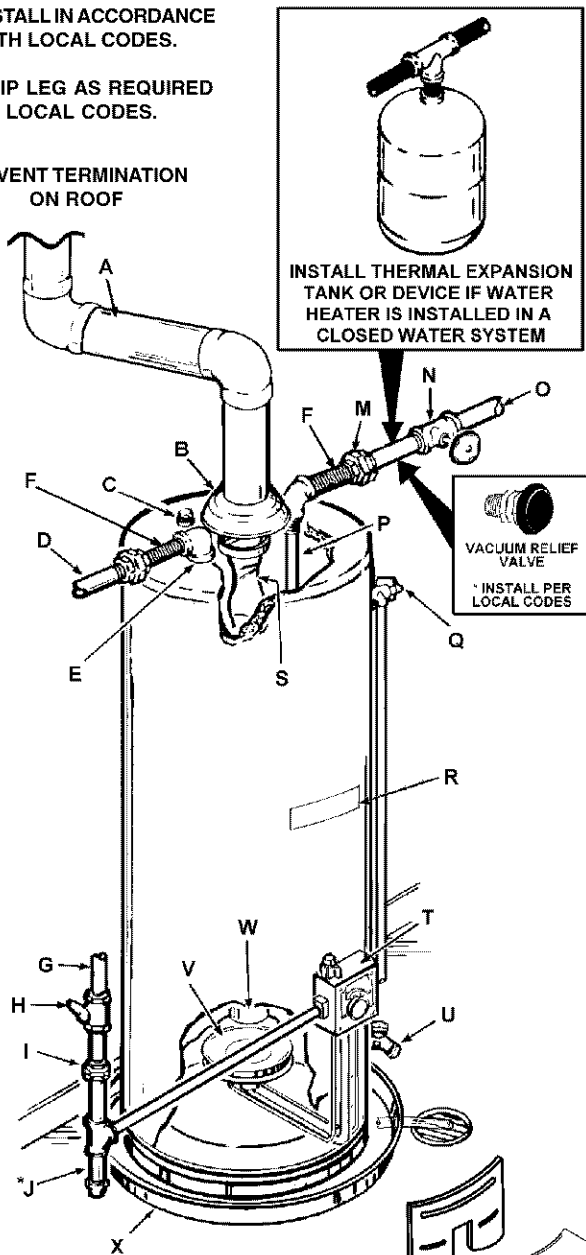

\* REMOVE DOORS TO LIGHT PILOT. REPLACE DOORS.

\* ALL PIPING MATERIALS TO BE SUPPLIED BY CUSTOMERS.

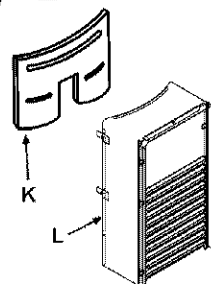

FIGURE 1.

# INSTALLATION INSTRUCTIONS

## Removing the Old Water Heater

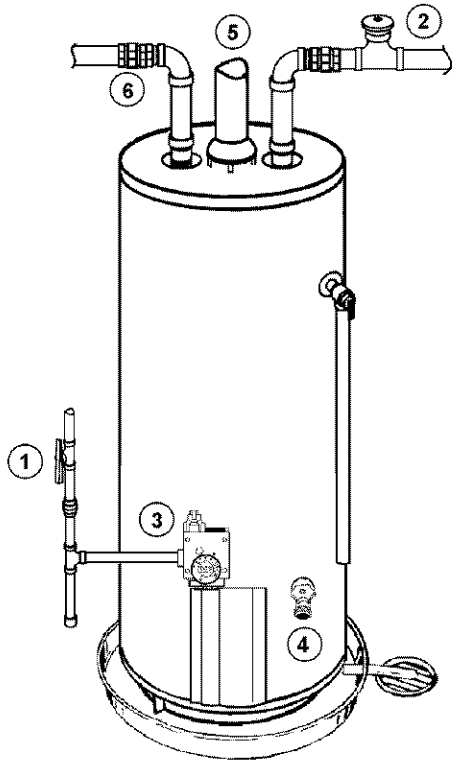

FIGURE 2.

1. Turn "OFF" the gas supply to the water heater.

If the main gas line Shut-off valve serving all gas appliances is used, also shut "OFF" the gas at each appliance. Leave all gas appliances shut "OFF" until the water heater installation is completed, see Figures 2 and 3.

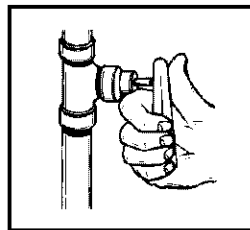

FIGURE 3.

2. Turn "OFF" the water supply to the water heater at the water shut-off valve or water meter. Some installations require that the water be turned off to the entire house, see Figures 2 and 4.

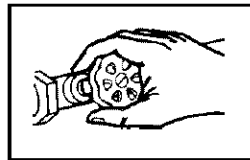

FIGURE 4.

3. Check again to make sure the gas supply is "OFF" to the water heater. Then disconnect the gas supply connection from the gas control valve.

⚠ DANGER

- Burn hazard
- Hot water discharge.
- Keep hands clear of drain valve discharge.

4. Attach a hose to the water heater drain valve and put the other end in a floor drain or outdoors. Open the water heater drain valve. Open a nearby hot water faucet which will relieve pressure in the water heater and speed draining. The water passing out of the drain valve may be extremely hot. To avoid being scalded, make sure all connections are tight and that the water flow is directed away from any person, see Figures 2 and 5.

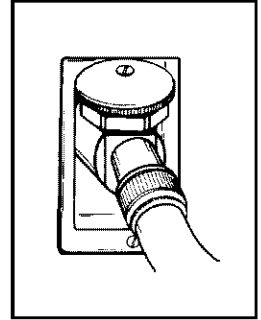

FIGURE 5.

5. Disconnect the vent pipe from the draft hood where it connects to the water heater. In most installations the vent pipe can be lifted off after any screw or other attached devices are removed. Dispose of the draft hood. The new water heater has a draft hood which must be used for proper operation.
6. If you have copper piping to the water heater, the two copper water pipes can be cut with a hacksaw approximately four inches away from where they connect to the water heater, see Figure 6. This will avoid cutting off pipes too short. Additional cuts can be made later if necessary. Disconnect the temperature-pressure relief valve drain line. When the water heater is drained, disconnect the hose from the drain valve. Close the drain valve. The water heater is now completely disconnected and ready to be removed.

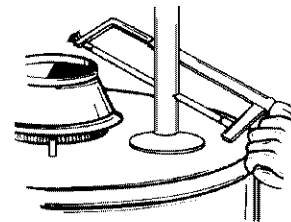

FIGURE 6.

If you have galvanized pipes to the water heater, loosen the two galvanized pipes with a pipe wrench at the union in each line. Also disconnect the piping remaining to the water heater, see Figure 7. These pieces should be saved since they may be needed when reconnecting the new water heater. Disconnect the temperature-pressure relief valve drain line. When the water heater is drained, disconnect the hose from the drain valve. Close the drain valve. The water heater is now completely disconnected and ready to be removed. Mineral buildup or sediment may have accumulated in the old water heater. This causes the water heater to be much heavier than normal and this residue, if spilled out, could cause staining.

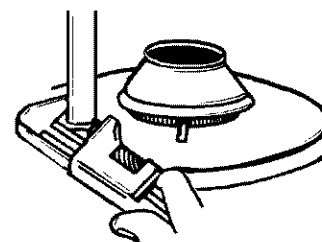

FIGURE 7.



## Facts to Consider About the Location

Carefully choose an indoor location for the new water heater, because the placement is a very important consideration for the safety of the occupants in the building and for the most economical use of the appliance. **This water heater is not for use in manufactured (mobile) homes or outdoor installation.**

Whether replacing an old water heater or putting the water heater in a new location, the following critical points must be observed:

- Select a location indoors as close as practical to the gas vent or chimney to which the water heater vent is going to be connected, and as centralized with the water piping system as possible.
- Selected location must provide adequate clearances for servicing and proper operation of the water heater.

<b>CAUTION</b>	
<b>Property Damage Hazard</b>	
• All water heaters eventually leak	
• Do not install without adequate drainage.	

Installation of the water heater must be accomplished in such a manner that if the tank or any connections should leak, the flow will not cause damage to the structure. For this reason, it is not advisable to install the water heater in an attic or upper floor. When such locations cannot be avoided, a suitable drain pan should be installed under the water heater. Drain pans are available at your local Sears or hardware store. Such a drain pan must have a minimum length and width of at least 2 inches (51 mm) greater than the water heater dimensions and must be piped to an adequate drain. The pan must not restrict combustion air flow.

Water heater life depends upon water quality, water pressure and the environment in which the water heater is installed. Water heaters are sometimes installed in locations where leakage may result in property damage, even with the use of a drain pan piped to a drain. However, unanticipated damage can be reduced or prevented by a leak detector or water shut-off device used in conjunction with a piped drain pan. These devices are available from some plumbing supply wholesalers and retailers, and detect and react to leakage in various ways:

- Sensors mounted in the drain pan that trigger an alarm or turn off the incoming water to the water heater when leakage is detected.
- Sensors mounted in the drain pan that turn off the water supply to the entire home when water is detected in the drain pan.
- Water supply shut-off devices that activate based on the water pressure differential between the cold water and hot water pipes connected to the water heater.
- Devices that will turn off the gas supply to a gas water heater while at the same time shutting off its water supply.

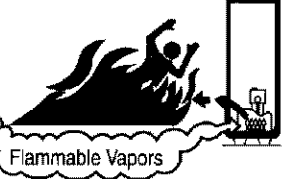
<b>⚠ DANGER</b>	
<b>Fire or Explosion Hazard</b>	
• Do not store or use gasoline or other flammable vapors and liquids in the vicinity of this or any other appliance.	
	
Flammable Vapors	

INSTALLATIONS IN AREAS WHERE FLAMMABLE LIQUIDS (VAPORS) ARE LIKELY TO BE PRESENT OR STORED (GARAGES, STORAGE AND UTILITY AREAS, ETC.): Flammable liquids (such as gasoline, solvents, propane [LP or butane, etc.] and other substances such as adhesives, etc.) emit flammable vapors which can be ignited by a gas water heater's pilot light or main burner. The resulting flashback and fire can cause death or serious burns to anyone in the area, as well as property damage. If installation in such areas is your only option, then the installation must be accomplished in a way that the pilot flame and main burner flame are elevated from the floor at least 18 inches. While this may reduce the chances of flammable vapors, from a floor spill being ignited, gasoline and other flammable substances should never be stored or used in the same room or area containing a gas water heater or other open flame or spark producing appliances. NOTE: Flammable vapors may be drawn by air currents from other areas of the structure in the appliance.

Also, the water heater must be located and/or protected so it is not subject to physical damage by a moving vehicle.

<b>⚠ WARNING</b>	
<b>Fire Hazard</b>	
	For continued protection against risk of fire:
	• Do not install water heater on carpeted floor.
	• Do not operate water heater if flood damaged.

This water heater must not be installed directly on carpeting. Carpeting must be protected by metal or wood panel beneath the appliance extending beyond the full width and depth of the appliance by at least 3 inches (76.2mm) in any direction, or if the appliance is installed in an alcove or closet, the entire floor must be covered by the panel. Failure to heed this warning may result in a fire hazard.

<b>⚠ WARNING</b>	
<b>Fire or Explosion Hazard</b>	
Read instruction manual before installing, using or servicing water heater.	
	
• Improper use may result in fire or explosion.	
• Maintain required clearances to combustibles.	

Minimum clearances between the water heater and combustible construction are 1 inch (25 mm) at the sides and rear, 4 inches (102 mm) at the front, and 6 inches (153 mm) from the vent pipe, see Figure 8. Clearance from the top of the jacket is 18 inches (457 mm) on most models. Note that a lesser dimension may be allowed on some models, refer to the label attached adjacent to the gas control valve on the water heater.

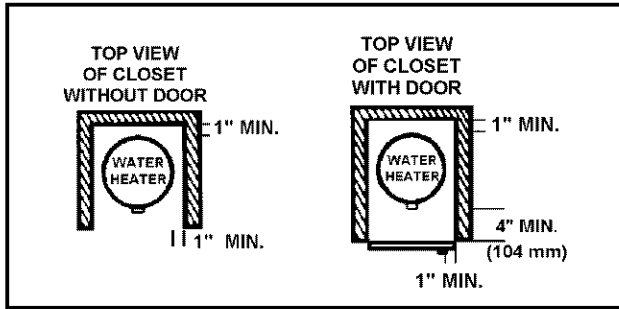

FIGURE 8.

<b>⚠ WARNING</b>	
<b>Breathing Hazard - Carbon Monoxide Gas</b>	
	<ul style="list-style-type: none"> <li>• Install water heater in accordance with the instruction manual and NFPA 54.</li> <li>• To avoid injury, combustion and ventilation air must be taken from outdoors.</li> <li>• Do not place chemical vapor emitting products near water heater.</li> </ul>
<p>Breathing carbon monoxide can cause brain damage or death. Always read and understand instruction manual.</p>	

A gas water heater cannot operate properly without the correct amount of air for combustion, see Figure 9. Do not install in a confined area such as a closet, unless you provide air as shown in the *Locating The New Water Heater* section. Never obstruct the flow of ventilation air. If you have any doubts or questions at all, call your gas supplier. Failure to provide the proper amount of combustion air can result in a fire or explosion and cause death, serious bodily injury, or property damage.

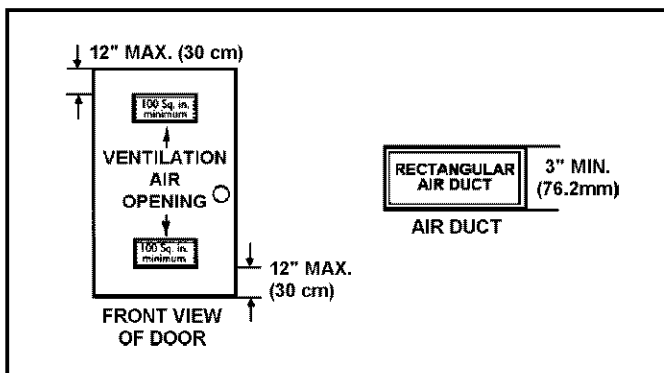

FIGURE 9.

If this water heater will be used in beauty shops, barber shops, cleaning establishments, or self-service laundries with dry cleaning equipment, it is imperative that the water heater or water heaters be installed so that combustion and ventilation air be taken from outside these areas.

Propellants of aerosol sprays and volatile compounds, (cleaners, chlorine based chemicals, refrigerants, etc.) in addition to being highly flammable in many cases, will also change to corrosive hydrochloric acid when exposed to the combustion products of the water heater. The results can be hazardous, and also cause product failure.

## Insulation Blankets

Insulation blankets available to the general public for external use on gas water heaters are not necessary with Kenmore products. The purpose of an insulation blanket is to reduce the standby heat loss encountered with storage tank heaters. Your Kenmore water heater meets or exceeds the National Appliance Energy Conservation Act standards with respect to insulation and standby loss requirements, making an insulation blanket unnecessary.

<b>⚠ WARNING</b>	
<b>Breathing Hazard - Carbon Monoxide Gas</b>	
	<ul style="list-style-type: none"> <li>• Do not obstruct water heater air intake with insulating blanket.</li> <li>• Gas and carbon monoxide detectors are available.</li> <li>• Install water heater in accordance with the instruction manual.</li> </ul>
<p>Breathing carbon monoxide can cause brain damage or death. Always read and understand instruction manual.</p>	

## ⚠ WARNING

Should you choose to apply an insulation blanket to this heater, you should follow these instructions (See Figure 1 for identification of components mentioned below). Failure to follow these instructions can restrict the air flow required for proper combustion, potentially resulting in fire, asphyxiation, serious personal injury or death.

- **Do not** apply insulation to the top of the water heater, as this will interfere with safe operation of the draft hood.
- **Do not** cover the outer door, thermostat or temperature & pressure relief valve.
- **Do not** allow insulation to come within 2" (50.8 mm) of the floor to prevent blockage of combustion air flow to the burner.
- **Do not** cover the instruction manual. Keep it on the side of the water heater or nearby for future reference.
- **Do** obtain new warning and instruction labels from Sears for placement on the blanket directly over the existing labels.
- **Do** inspect the insulation blanket frequently to make certain it does not sag, thereby obstructing combustion air flow.

## Combustion Air and Ventilation for Appliances Located in Unconfined Spaces

**UNCONFINED SPACE** is space whose volume is not less than 50 cubic feet per 1,000 Btu per hour (4.8 m<sup>3</sup> per kW) of the aggregate input rating of all appliances installed in that space. Rooms communicating directly with the space in which the appliances are installed, through openings not furnished with doors, are considered a part of the unconfined space.

In unconfined spaces in buildings, infiltration may be adequate to provide air for combustion, ventilation and dilution of flue gases. However, in buildings of tight construction (for example, weather stripping, heavily insulated, caulked, vapor barrier, etc.), additional air may need to be provided using the methods described in *Combustion Air and Ventilation for Appliances Located in Confined Spaces*.

## Combustion Air and Ventilation for Appliances Located in Confined Spaces

**CONFINED SPACE** is a space whose volume is less than 50 cubic feet per 1,000 Btu per hour (4.8 m<sup>3</sup> per kW) of the aggregate input rating of all appliances installed in that space.

### A. ALL AIR FROM INSIDE BUILDINGS:

(See Figure 9 on page 10 and Figure 10 below)

The confined space shall be provided with two permanent openings communicating directly with an additional room(s) of sufficient volume so that the combined volume of all spaces meets the criteria for an unconfined space. The total input of all gas utilization equipment installed in the combined space shall be considered in making this determination. Each opening shall have a minimum free area of one square inch per 1,000 Btu per hour (22 cm<sup>2</sup>/kW) of the total input rating of all gas utilization equipment in the confined space, but not less than 100 square inches (645 cm<sup>2</sup>). One opening shall commence within 12 inches (30 cm) of the top and one commencing within 12 inches (30 cm) of the bottom of the enclosures.

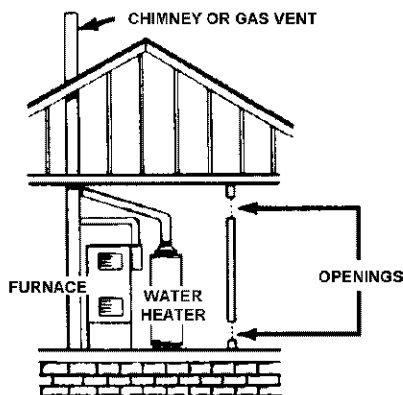

FIGURE 10.

### B. ALL AIR FROM OUTDOORS: (See Figures 9, 11, 12 and 13)

The confined space shall be provided with two permanent openings, one commencing within 12 inches (30 cm) of the top and one commencing within 12 inches (30 cm) from the bottom of the enclosure. The openings shall communicate directly, or by ducts, with the outdoors or spaces (crawl or attic) that freely communicate with the outdoors.

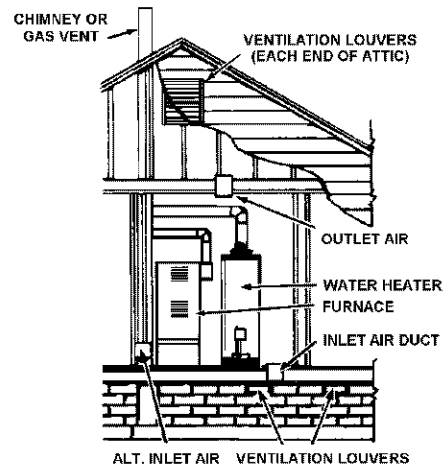

FIGURE 11.

- When directly communicating with the outdoors, each opening shall have a minimum free area of 1 square inch per 4,000 Btu per hour (5.5 cm<sup>2</sup>/kW) of total input rating of all equipment in the enclosure. See Figure 12.
- When communicating with the outdoors through vertical ducts, each opening shall have a minimum free area of 1 square inch per 4,000 BTU per hour (5.5 cm<sup>2</sup>/kW) of total input rating of all equipment in the enclosure. See Figure 12.

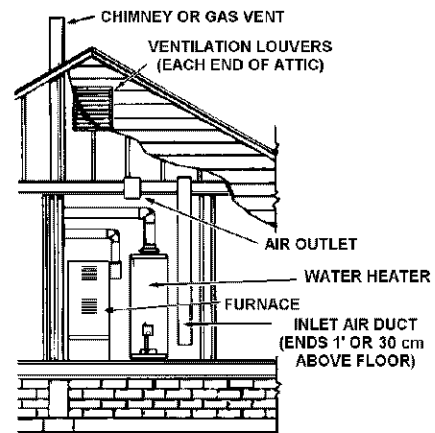

FIGURE 12.

- When communicating with the outdoors through horizontal ducts, each opening shall have a minimum free area of 1 square inch per 2,000 BTU per hour (11 cm<sup>2</sup>/kW) of total input rating of all equipment in the enclosure. See Figure 13.

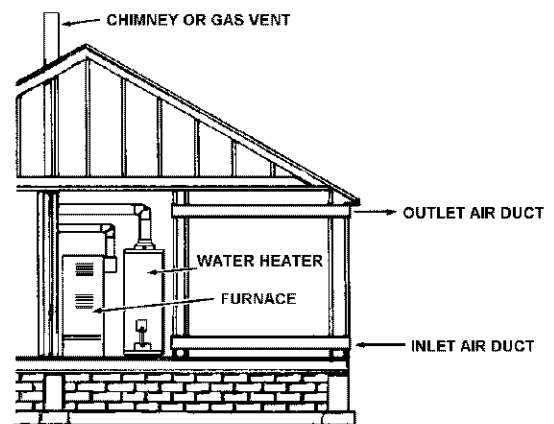

FIGURE 13.

- When ducts are used, they shall be of the same cross-sectional area as the free area of the openings to which they connect. The minimum short side dimension of rectangular air ducts shall not be less than 3 inches (76.2 mm). See Figure 13.
- Louvers and Grilles: In calculating free area, consideration shall be given to the blocking effect of louvers, grilles or screens protecting openings. Screens used shall not be smaller than 1/4 inch (6.4 mm) mesh. If the free area through a design of louver or grille is known, it should be used in calculating the size opening required to provide the free area specified. If the design and free area is not known, it may be assumed that wood louvers will be 20-25 percent free area and metal louvers and grilles will have 60-75 percent free area. Louvers and grilles shall be fixed in the open position or interlocked with the equipment so that they are opened automatically during equipment operation.
- Special Conditions Created by Mechanical Exhausting or Fireplaces: operation of exhaust fans, ventilation systems, clothes dryers or fireplaces may create conditions requiring special attention to avoid unsatisfactory operation of installed gas utilization equipment.

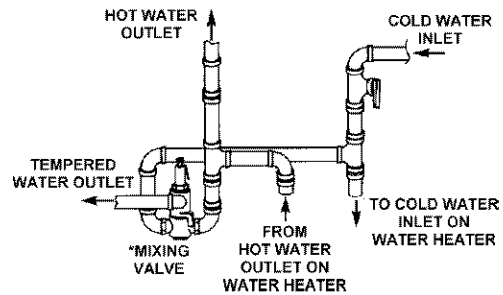

FIGURE 14.

 <b>WARNING</b>
<b>Toxic Chemical Hazard</b>
<ul style="list-style-type: none"> <li>• Do not connect to non-potable water system.</li> </ul>

This water heater shall not be connected to any heating systems or component(s) used with a non-potable water heating appliance.

All piping components connected to this unit for space heating applications shall be suitable for use with potable water.

Toxic chemicals, such as those used for boiler treatment shall not be introduced into this system.

Water supply systems may, because of such events as high line pressure, frequent cut-offs or the effects of water hammer among others, have installed devices such as pressure reducing valves, check valves, back flow preventers, etc. to control these types of problems. When these devices are not equipped with an internal by-pass, and no other measures are taken, the devices cause the water system to be closed. As water is heated, it expands (thermal expansion) and closed systems do not allow for the expansion of heated water.

The water within the water heater tank expands as it is heated and increases the pressure of the water system. If the relieving point of the water heater's temperature-pressure relief valve is reached, the valve will relieve the excess pressure. **The temperature-pressure relief valve is not intended for the constant relief of thermal expansion.** This is an unacceptable condition and must be corrected. It is recommended that any devices installed which could create a closed system have a by-pass and/or the system have an expansion tank to relieve the pressure built by thermal expansion in the water system. Refer to the *Thermal Expansion* section under *Troubleshooting Guide* or contact local plumbing authority or local Sears Service Center on how to control this situation.

**NOTE: To protect against untimely corrosion of hot and cold water fittings, it is strongly recommended that di-electric unions or couplings be installed on this water heater when connected to copper pipe.**

<b>CAUTION</b>
<b>Property Damage Hazard</b>
<ul style="list-style-type: none"> <li>• Avoid water heater damage.</li> <li>• Install thermal expansion tank if necessary.</li> <li>• Do not apply heat to cold water inlet.</li> <li>• Contact qualified installer or Sears Service Center.</li> </ul>

## Water Piping

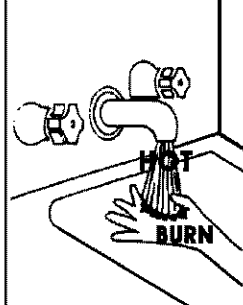
 <b>DANGER</b>	<p>Water temperature over 125°F (52°C) can cause severe burns instantly resulting in severe injury or death.</p> <p>Children, elderly, and the physically or mentally disabled are at highest risk for scald injury.</p> <p>Feel water before bathing or showering.</p> <p>Temperature limiting valves are available.</p> <p>Read instruction manual for safe temperature setting.</p>
	

### HOTTER WATER CAN SCALD:

Water heaters are intended to produce hot water. Water heated to a temperature which will satisfy space heating, clothes washing, dish washing, cleaning and other sanitizing needs can scald and permanently injure you upon contact. Some people are more likely to be permanently injured by hot water than others. These include the elderly, children, the infirm, or physically/mentally handicapped. If anyone using hot water in your home fits into one of these groups or if there is a local code or state law requiring a certain temperature water at the hot water tap, then you must take special precautions. In addition to using the lowest possible temperature setting that satisfies your hot water needs, a means such as a \*mixing valve, shall be used at the hot water taps used by these people or at the water heater. Mixing valves are available at plumbing supply or hardware stores. See Figure 14. Valves for reducing point of use temperature by mixing cold and hot water are also available. Follow manufacturer's instructions for installation of the valves. Before changing the factory setting on the thermostat, read the *Temperature Regulation* section in this manual.

Figure 15 shows the typical attachment of the water piping to the water heater. The water heater is equipped with 3/4" NPT water connections.

**NOTE:** If using copper tubing, solder tubing to an adapter before attaching the adapter to the cold water inlet connection. Do not solder the cold water supply line directly to the cold water inlet. It will harm the dip tube and damage the tank.

- Look at the top cover of the water heater. The water outlet is marked "HOT". Put two or three turns of teflon tape around the threaded end of the threaded-to-sweat coupling and around both ends of the 3/4" NPT threaded nipple. Using flexible connectors, connect the hot water pipe to the hot water outlet on the water heater.
- Look at the top of the water heater. The cold water inlet is marked "COLD". Put two or three turns of teflon tape around the threaded end of the threaded-to-sweat coupling and around both ends of the 3/4" NPT threaded nipple. Using flexible connectors, connect the cold water pipe to the cold water inlet of the water heater.

**NOTE:** This water heater is super insulated to minimize heat loss from the tank. Further reduction in heat loss can be accomplished by insulating the hot water lines from the water heater.

**INSTALLATION COMPLETED USING INSTALLATION KIT**

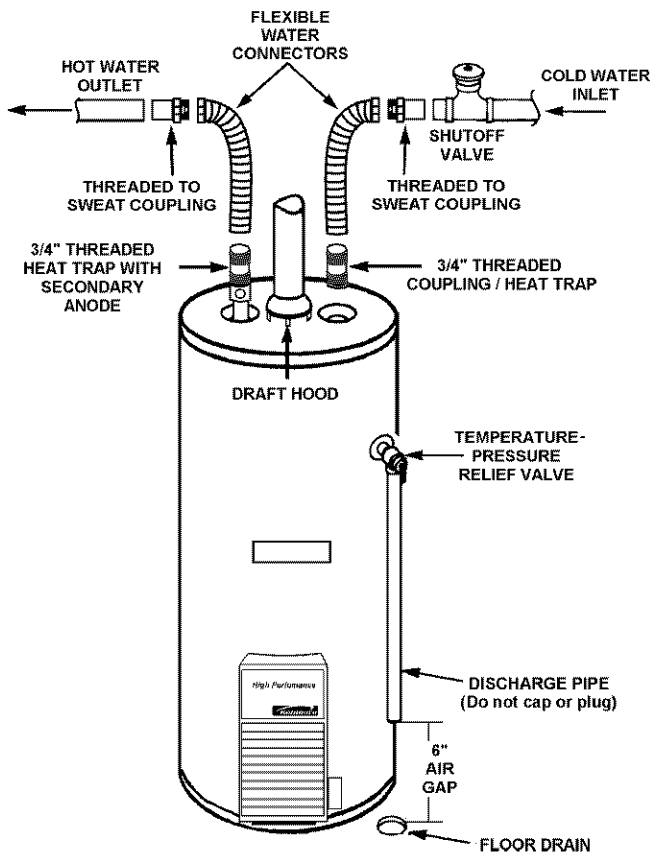

**FIGURE 15.**

**T & P Valve and Pipe Insulation**

Remove insulation for T & P valve and pipe connections from carton.

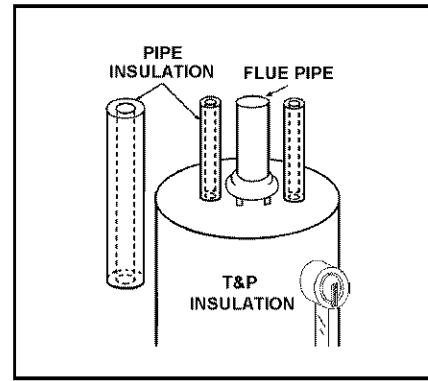

**FIGURE 15A.**

Fit pipe insulation over the incoming cold water line and the hot water line. Make sure that the insulation is against the top cover of the heater.

Fit T & P valve insulation over valve. Make sure that the insulation does not interfere with the lever of the T & P valve.

Secure all insulation using tape.

**Temperature-Pressure Relief Valve**

	<p><b>⚠ WARNING</b></p> <p><b>Explosion Hazard</b></p>
	<ul style="list-style-type: none"> <li>• Temperature-pressure relief valve must comply with ANSI Z21.22 and ASME code.</li> <li>• Properly sized temperature-pressure relief valve must be installed in opening provided.</li> <li>• Can result in overheating and excessive tank pressure.</li> <li>• Can cause serious injury or death.</li> </ul>

This heater is provided with a properly certified combination temperature - pressure relief valve by the manufacturer.

The valve is certified by a nationally recognized testing laboratory that maintains periodic inspection of production of listed equipment of materials as meeting the requirements for Relief Valves and Automatic Gas Shut-off Devices for Hot Water Supply Systems, ANSI Z21.22 and the code requirements of ASME.

If replaced, the valve must meet the requirements of local codes, but not less than a combination temperature and pressure relief valve certified as indicated in the above paragraph.

The valve must be marked with a maximum set pressure not to exceed the marked hydrostatic working pressure of the water heater (150 psi = 1,035 kPa) and a discharge capacity not less than the water heater input rate as shown on the model rating plate.

For safe operation of the water heater, the relief valve must not be removed from its designated opening nor plugged.

The temperature-pressure relief valve must be installed directly into the fitting of the water heater designed for the relief valve. Position the valve downward and provide tubing so that any discharge will exit only within 6 inches (153 mm) above, or at any distance below the structural floor, see Figure 16. Be certain that no contact is made with any live electrical part. The discharge opening must not be blocked or reduced in size under any circumstances. Excessive length, over 30 feet (9.14 m), or use of more than four elbows can cause restriction and reduce the discharge capacity of the valve.

No valve or other obstruction is to be placed between the relief valve and the tank. Do not connect tubing directly to discharge drain unless a 6 inch air gap is provided. To prevent bodily injury, hazard to life, or property damage, the relief valve must be allowed to discharge water in quantities should circumstances demand. If the discharge pipe is not connected to a drain or other suitable means, the water flow may cause property damage.

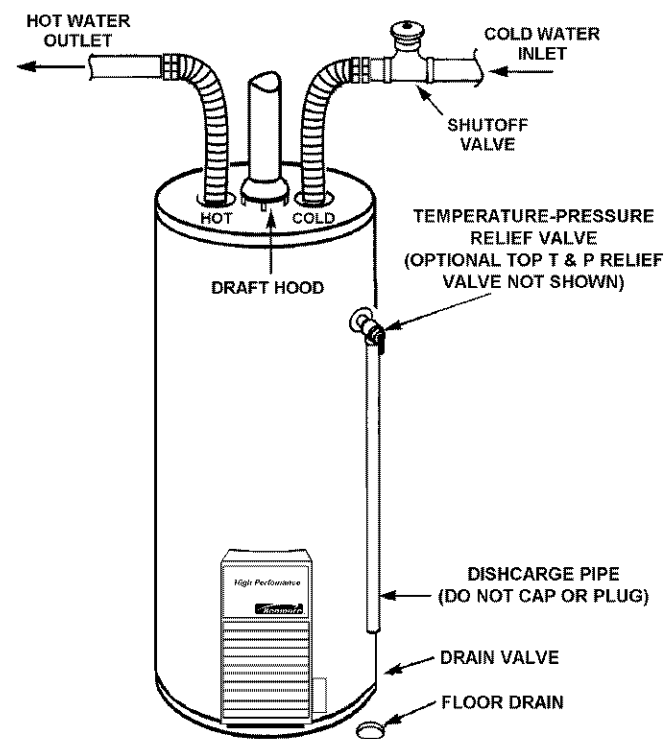

FIGURE 16.

<b>CAUTION</b>
<b>Water Damage Hazard</b>
<ul style="list-style-type: none"> <li>• Temperature-pressure relief valve discharge pipe must terminate at adequate drain.</li> </ul>

The Discharge Pipe:

- Shall not be smaller in size than the outlet pipe size of the valve, or have any reducing couplings or other restrictions.
- Shall not be plugged or blocked.
- Shall be of material listed for hot water distribution.

- Shall be installed so as to allow complete drainage of both the temperature-pressure relief valve, and the discharge pipe.
- Shall terminate at an adequate drain.
- Shall not have any valve between the relief valve and tank.

<b>⚠ DANGER</b>	<p>Water temperature over 125°F (52°C) can cause severe burns instantly resulting in severe injury or death.</p> <p>Children, the elderly, and the physically or mentally disabled are at highest risk for scald injury.</p> <p>Feel water before bathing or showering.</p> <p>Temperature limiting valves are available.</p> <p>Read instruction manual for safe temperature setting.</p>

The temperature-pressure relief valve must be manually operated at least once a year. Caution should be taken to ensure that (1) no one is in front of or around the outlet of the temperature-pressure relief valve discharge line, and (2) the water manually discharged will not cause any bodily injury or property damage because the water may be extremely hot.

If after manually operating the valve, it fails to completely reset and continues to release water, immediately close the cold water inlet to the water heater, follow the draining instructions, and replace the temperature-pressure relief valve with a new one.

### Filling the Water Heater

<b>CAUTION</b>
<b>Property Damage Hazard</b>
<ul style="list-style-type: none"> <li>• Avoid water heater damage.</li> <li>• Fill tank with water before operating.</li> </ul>

Never use this water heater unless it is completely full of water. To prevent damage to the tank, the tank must be filled with water. Water must flow from the hot water faucet before turning "ON" gas to the water heater.

To fill the water heater with water:

- Close the water heater drain valve by turning the handle to the right (clockwise). The drain valve is on the lower front of the water heater.
- Open the cold water supply valve to the water heater. **NOTE: The cold water supply valve must be left open when the water heater is in use.**
- To insure complete filling of the tank, allow air to exit by opening the nearest hot water faucet. Allow water to run until a constant flow is obtained. This will let air out of the water heater and the piping.

- Check all water piping and connections for leaks. Repair as needed.

## Venting

**VENT DAMPERS** - Any vent damper, whether it is operated thermally or otherwise must be removed if its use inhibits proper drafting of the water heater.

**Thermally Operated Vent Dampers:** Gas-fired water heaters having thermal efficiency in excess of 80% may produce a relatively low flue gas temperature. Such temperatures may not be high enough to properly open thermally operated vent dampers. This would cause spillage of the flue gases and may cause carbon monoxide poisoning.

Vent dampers must bear evidence of certification as complying with the current edition of the American National Standard ANSI Z21.66/CGA 6.14, respectively, cover electrically and mechanically actuated vent dampers). Before installation of any vent damper, consult your local Sears Service Center or the local gas supplier for further information.

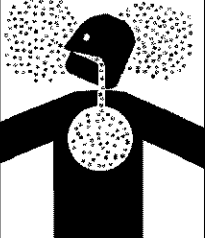
<b>⚠ WARNING</b>	
<b>Breathing Hazard - Carbon Monoxide Gas</b>	
	<ul style="list-style-type: none"> <li>• Vent dampers must be certified in accordance with ANSI Z21.66/CGA 6.14.</li> <li>• Vent damper must permit proper drafting of water heater.</li> <li>• Install properly sized venting.</li> <li>• Do not install without venting outdoors.</li> <li>• Do not install without draft hood.</li> <li>• If common vented install in accordance with NFPA 54.</li> <li>• Be alert for obstructed or deteriorated vent system to avoid serious injury or death.</li> </ul>
Breathing carbon monoxide can cause brain damage or death. Always read and understand instruction manual.	

To insure proper venting of this gas-fired water heater, the correct vent pipe diameter must be utilized. Any additions or deletions of other gas appliances on a common vent with this water heater may adversely affect the operation of the water heater. Consult your gas supplier if any such changes are planned.

For proper venting in certain installations, a larger diameter vent pipe may be necessary. Consult your local Sears Service Center or gas supplier to aid you in determining the proper venting for your water heater from the vent tables in the current edition of the National Fuel Gas Code ANSI Z223.1/NFPA 54.

Periodically check the venting system for signs of obstruction or deterioration and replace if needed.

The combustion and ventilation air flow must not be obstructed.

The water heater with draft hood installed must be connected to a chimney or listed vent pipe system, which terminates to the outdoors. Never operate the water heater unless it is vented

to the outdoors and has adequate air supply to avoid risks of improper operation, explosion or asphyxiation.

- For proper draft hood attachment, the draft hood legs may be angled slightly inward.
- Place the draft hood legs in the receiving holes on the top of the water heater. The legs will snap in the holes to give a tight fit.
- Place the vent pipe over the draft hood. With the vent pipe in position, drill a small hole through both the vent pipe and draft hood. Secure them together with a sheet metal screw. See Figure 17.

Obstructed or deteriorated vent systems may present serious health risk or asphyxiation.

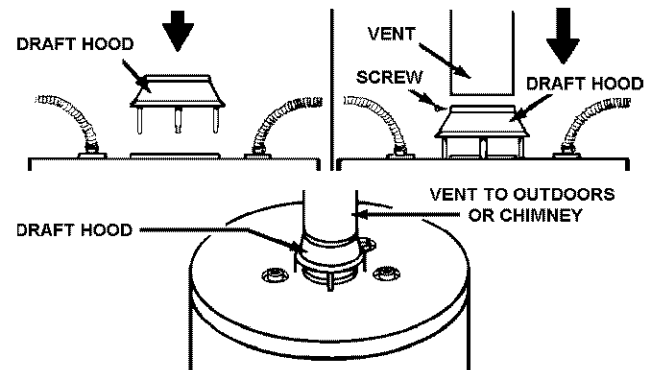

FIGURE 17.

The vent pipe from the water heater must be no less than the diameter of the draft hood outlet on the water heater and must slope upward at least 1/4 inch per linear foot (21 mm per meter). See Figure 18.

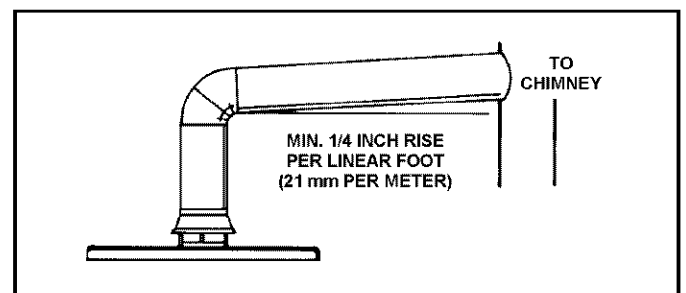
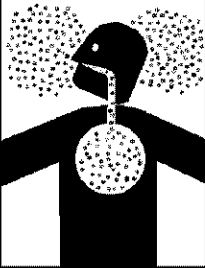

FIGURE 18.

All vent gases must be completely vented to the outdoors of the structure (dwelling). Install only the draft hood provided with the new water heater and no other draft hood.

Vent pipes must be secured at each joint with sheet metal screws.

There must be a minimum of 6 inches (153 mm) clearance between single wall vent pipe and any combustible material. Fill and seal any clearance between single wall vent pipe and combustible material with mortar mix, cement, or other noncombustible substance. For other than single wall, follow vent pipe manufacturer's clearance specifications. To insure a tight fit of the vent pipe in a brick chimney, seal around the vent pipe with mortar mix cement.

<b>⚠ WARNING</b>	
<b>Breathing Hazard - Carbon Monoxide Gas</b>	
	<ul style="list-style-type: none"> <li>• Flue gases may escape if vent pipe is not connected.</li> <li>• Do not store corrosive chemicals in vicinity of water heater.</li> <li>• Chemical corrosion of flue and vent system can cause serious injury or death.</li> <li>• Contact a qualified installer or service agency.</li> </ul>
<p>Breathing carbon monoxide can cause brain damage or death. Always read and understand instruction manual.</p>	

Failure to have required clearances between vent piping and combustible material will result in a fire hazard.

Be sure vent pipe is properly connected to prevent escape of dangerous flue gases which could cause deadly asphyxiation.

Chemical vapor corrosion of the flue and vent system may occur if air for combustion contains certain chemical vapors. Spray can propellants, cleaning solvents, refrigerator and air conditioner refrigerants, swimming pool chemicals, calcium and sodium chloride, waxes, bleach and process chemicals are typical compounds which are potentially corrosive.

## Gas Piping

<b>⚠ WARNING</b>	
<b>Fire and Explosion Hazard</b>	
	<ul style="list-style-type: none"> <li>• Do not use water heater with any gas other than the gas shown on the rating plate.</li> <li>• Excessive pressure to gas control valve can cause serious injury or death.</li> <li>• Turn off gas lines during installation.</li> <li>• Contact qualified installer or service agency.</li> </ul>

Make sure the gas supplied is the same type listed on the model rating plate. The inlet gas pressure must not exceed 14 inch water column (3.5kPa) for natural and propane gas (L.P.) gas. The minimum inlet gas pressure listed on the rating plate is for the purpose of input adjustment. If the gas control valve is subjected to pressures exceeding 1/2 pound per square inch (3.5kPa), the damage to the gas control valve could result in a fire or explosion from leaking gas.

If the main gas line shut-off serving all gas appliances is used, also turn "OFF" the gas at each appliance. Leave all gas appliances shut "OFF" until the water heater installation is complete.

A gas line of sufficient size must be run to the water heater. Consult the current edition of National Fuel Gas Code ANSI Z223.1/NFPA 54 and your gas supplier concerning pipe size.

There must be:

- A readily accessible manual shut off valve in the gas supply line serving the water heater, and
- A drip leg (sediment trap) ahead of the gas control valve to help prevent dirt and foreign materials from entering the gas control valve.
- A flexible gas connector or a ground joint union between the shut off valve and control valve to permit servicing of the unit.

Be sure to check all the gas piping for leaks before lighting the water heater. Use a soapy water solution, not a match or open flame. Rinse off soapy solution and wipe dry.

The minimum inlet gas pressure shown on the rating plate is that which will permit firing at the rated input.

<b>⚠ WARNING</b>	
<b>Breathing Hazard - Carbon Monoxide Gas</b>	
	<ul style="list-style-type: none"> <li>• High altitude orifice must be installed for operation above 3,300 ft. (1,006 m) or 5,500 ft. (1,676 m) for a high altitude models.</li> <li>• Contact a qualified installer or service agency.</li> </ul>
<p>Breathing carbon monoxide can cause brain damage or death. Always read and understand instruction manual.</p>	

If a standard model is installed above 3,300 feet (1,006 m) or a high altitude model is installed above 5,500 feet (1,676 m) the input rating should be reduced at the rate of 4 percent for each 1,000 feet (305 m) above sea level which requires replacement of the burner orifice in accordance with National Fuel Gas Code ANSI Z223.1/NFPA 54. Contact your local Sears Service Center or local gas supplier for further information.

Failure to replace the standard orifice with a high altitude orifice when installed at elevations above 3,300 feet (1,006 m) or above 5,500 feet (1,676 m) for high altitude model) could result in improper and inefficient operation of the appliance, producing carbon monoxide gas in excess of safe limits, which could result in serious injury or death. Contact your local Sears Service Center or local gas supplier for any specific changes which may be required in your area.

<b>⚠ WARNING</b>	
<b>Fire and Explosion Hazard</b>	
	<ul style="list-style-type: none"> <li>• Use joint compound or tape compatible with propane.</li> <li>• Leak test before operating heater.</li> <li>• Disconnect gas piping and shut-off valve before pressure testing system.</li> </ul>



Use pipe joint compound or teflon tape marked as being resistant to the action of petroleum (Propane [L.P.]) gases.

The appliance and its gas connection must be leak tested before placing the appliance in operation.

The appliance and its individual shut-off valve shall be disconnected from the gas supply piping system during any pressure testing of that system at test pressures in excess of 1/2 pound per square inch (3.5kPa). It shall be isolated from the gas supply piping system by closing its individual manual shut-off valve during any pressure testing of the gas supply piping system at test pressures equal to or less than 1/2 pound per square inch (3.5kPa).

Connecting the gas piping to the gas control valve of the water heater can be accomplished by either of the two methods shown in Figures 19 and 20.

### Sediment Traps

	<h2>⚠ WARNING</h2>
	<p><b>Fire and Explosion Hazard</b></p> <ul style="list-style-type: none"> <li>• Contaminants in gas lines can cause fire or explosion.</li> <li>• Clean all gas piping before installation.</li> <li>• Install drip leg in accordance with NFPA 54.</li> </ul>

Contaminants in the gas lines may cause improper operation of the gas control valve that may result in fire or explosion. Before attaching the gas line be sure that all gas pipe is clean on the inside. To trap any dirt or foreign material in the gas supply line, a drip leg (sometimes called a sediment trap) must be incorporated in the piping. The drip leg must be readily accessible. Install in accordance with the *Gas Piping* section.

Refer to the current edition of the National Fuel Gas Code, ANSI Z223.1/NFPA 54.

A sediment trap shall be installed as close to the inlet of the water heater as practical at the time of water heater installation. The sediment trap shall be either a tee fitting with a capped nipple in the bottom outlet or other device recognized as an effective sediment trap. If a tee fitting is used, it shall be installed in conformance with one of the methods of installation, shown in Figures 19 and 20.

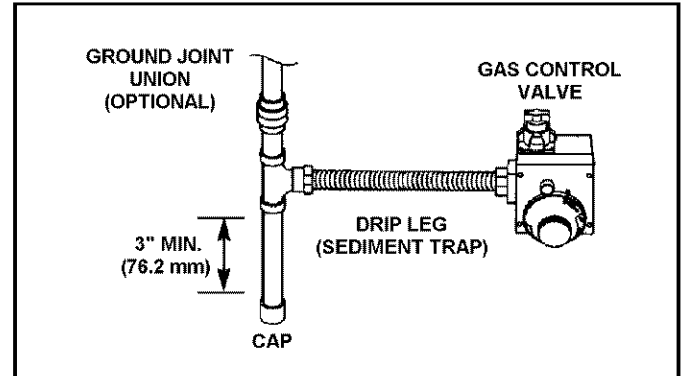

FIGURE 19. GAS PIPING WITH FLEXIBLE CONNECTOR.

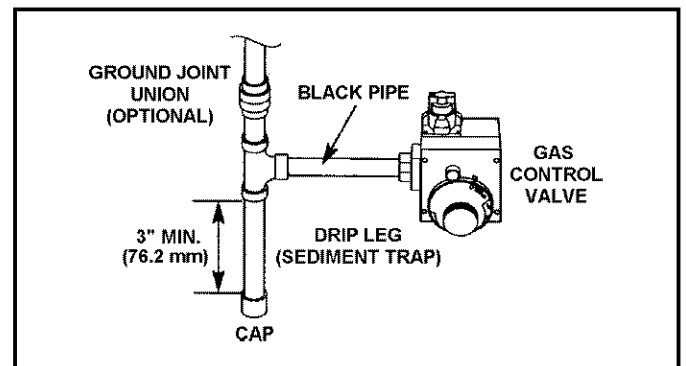

FIGURE 20. GAS PIPING WITH ALL BLACK IRON PIPE TO GAS CONTROL.

# OPERATING INSTRUCTIONS

Lighting label as it appears above the thermostat on the water heater

## FOR YOUR SAFETY READ BEFORE LIGHTING



**WARNING:** If you do not follow these instructions exactly, a fire or explosion may result causing property damage, personal injury or loss of life.



- A. This appliance has a pilot which must be lighted by hand. When lighting the pilot, follow these instructions exactly.
  - B. **BEFORE LIGHTING** smell all around the appliance area for gas. Be sure to smell next to the floor because some gas is heavier than air and will settle on the floor.
  - C. Use only your hand to push in or turn the gas control knob. Never use tools. If the knob will not push in or turn by hand, don't try to repair it, call a qualified service technician. Force or attempted repair may result in a fire or explosion.
  - D. Do not use this appliance if any part has been under water. Immediately call a qualified service technician to inspect the appliance and to replace any part of the control system and any gas control which has been under water.
- WHAT TO DO IF YOU SMELL GAS:**
- Do not try to light any appliance.
  - Do not touch any electric switch; do not use any phone in your building.
  - Immediately call your gas supplier from a neighbor's phone. Follow the gas supplier's instructions.

## LIGHTING INSTRUCTIONS

1.  **STOP!** Read the safety information above on this label.
2. Remove outer door.
3. Set the thermostat to lowest setting by turning the water temperature dial clockwise (↻) to its lowest temperature setting (with arrow on dial) as shown.
4. Turn gas control knob clockwise (↻) to "OFF" position. Knob cannot be turned from "PILOT" to "OFF" unless knob is depressed slightly. **DO NOT FORCE.**
5. Wait five (5) minutes to clear out any gas. If you then smell gas, **STOP!** Follow "B" in the safety information above on this label. If you don't smell gas, go to next step.
6. Remove (or open) inner door located below gas control unit.
7. Find pilot - follow metal tube from gas control. The pilot is located in front of the burner.
8. If you don't smell gas, turn knob on gas control counter clockwise (↺) to "PILOT" position.
9. Push the control knob all the way and hold down. Immediately light the pilot with a match. Continue to hold control knob in for about (1) minute after the pilot is lit. Release knob and it will pop back up. Pilot should remain lit. If it goes out, repeat Steps 3 through 8.
  - If knob does not pop up when released, stop and immediately call your service technician or gas supplier.
  - If the pilot will not stay lit after several tries, depress and turn the gas control knob clockwise (↻) to "OFF" and call your service technician or gas supplier.
10. Replace (or close) inner door. Replace outer door if door does not cover gas control on/off knob or temperature adjustment knob.
11. At arms length away, turn gas control knob counterclockwise (↺) to the full "ON" position.  
**WARNING: Do not use gas control knob to regulate gas flow.**
12. At arms length away, set the thermostat to desired setting. The mark (▲) indicative of approximate 120°F is preferred starting point. If hotter water is desired, see instruction manual and "warning" below.
13. Replace the outer door if not replaced in Step 10.

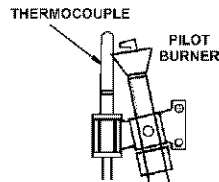
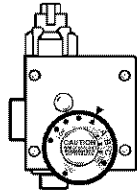

**Hotter water increases the risk of scald injury. Before changing temperature setting see instruction manual.**

## TO TURN OFF GAS TO APPLIANCE

1. Set the thermostat to lowest setting by turning the water temperature dial clockwise (↻) to its lowest temperature setting (with arrow on dial) as shown.
2. Turn gas control knob clockwise (↻) to "OFF" position. Knob cannot be turned from "PILOT" to "OFF" unless knob is depressed slightly. **DO NOT FORCE.**
3. Replace outer door (if removed).

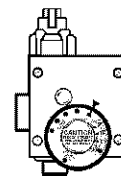

## Temperature Regulation

Short repeated heating cycles caused by small hot water uses can cause temperatures at the point of use to exceed the thermostat setting by up to 30°F (16.7°C). If you experience this type of use you should consider using lower temperature settings to reduce scald hazards.

Any water heater's intended purpose is to heat water. Hot water is needed for cleansing, cleaning, and sanitizing (bodies, dishes, clothing). Untempered hot water can present a scald hazard. Depending on the time element, and the people involved (adults, children, elderly, infirm, etc.) scalding may occur at different temperatures.

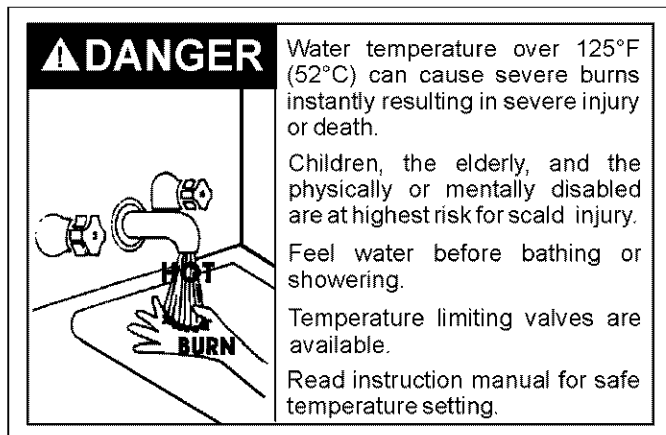

**HOTTER WATER CAN SCALD:** Water heaters are intended to produce hot water. Water heated to a temperature which will satisfy space heating, clothes washing, dish washing, and other sanitizing needs can scald and permanently injure you upon contact. Some people are more likely to be permanently injured by hot water than others. These include the elderly, children, the infirm, or physically/mentally handicapped. If anyone using hot water in your home fits into one of these groups or if there is a local code or state law requiring a certain temperature water at the hot water tap, then you must take special precautions. In addition to using the lowest possible temperature setting that satisfies your hot water needs, a means such as a mixing valve, shall be used at the hot water taps used by these people or at the water heater. Mixing valves are available at plumbing supply or hardware stores. Follow manufacturer's instructions for installation of the valves. Before

changing the factory setting on the thermostat, read the *Temperature Regulation* section in this manual. See Figures 21 and 22.

Never allow small children to use a hot water tap, or to draw their own bath water. Never leave a child or handicapped person unattended in a bathtub or shower.

**NOTE:** A water temperature range of 120°F-140°F (49°C-60°C) is recommended by most dishwasher manufacturers.

The thermostat of this water heater has been factory set at its lowest position (PILOT LIGHTING). It is adjustable and must be reset to the desired temperature setting to reduce the risk of scald injury. The mark (▲) indicative of approximately 120°F (49°C) is preferred starting point. Some states have a requirement for a lower setting.

Turn the water temperature dial clockwise (↻) to decrease the temperature, or counterclockwise (↺) to increase the temperature.

Should overheating occur or the gas supply fail to shut off, turn off the manual gas control valve to the appliance.

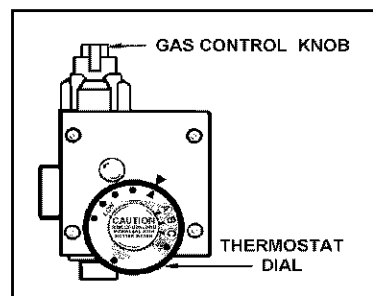

FIGURE 21.

Temperature Settings	Time to Produce 2nd & 3rd Degree Burns on Adult Skin
VERY HOT= approx. 160°F (71°C)	About 1/2 second
C = approx. 150°F (66°C)	About 1-1/2 seconds
B = approx. 140°F (60°C)	Less than 5 seconds
A = approx. 130°F (54°C)	About 30 seconds
▲ = approx. 120°F (49°C)	More than 5 minutes
LOW = approx. 80°F (27°C)	-----

FIGURE 22.

# SERVICE AND ADJUSTMENT

## Tank (Sediment) Cleaning

Sediment build-up on the tank bottom may create varying amount of noise, and if left in the tank will cause permanent tank failure. In some water areas, you may not be able to drain all sediment deposits by simply draining the tank. In these cases Mag-Erad (part no. 23600) can be used to help remove the sediment deposits. This may be ordered from the Sears Service Center. For ordering, refer to the *Parts Order List* section.

## Vent System Inspection

**⚠ WARNING**

**Carbon Monoxide and Fire Hazard**

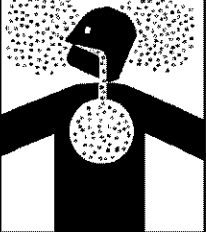

- Flue gases may escape if vent pipe is not connected.
- Be alert for obstructed, sooted or deteriorated vent system to avoid serious injury or death.
- Do not store corrosive chemicals in vicinity of water heater.
- Chemical corrosion of flue and vent system can cause serious injury or death

Breathing carbon monoxide can cause brain damage or death. Always read and understand instruction manual.

At least once a year a visual inspection should be made of the venting system. You should look for:

- Obstructions which could cause improper venting. The combustion and ventilation air flow must not be obstructed.
- Damage or deterioration which could cause improper venting or leakage of combustion products.
- Rusted flakes around top of water heater.

Be sure the vent piping is properly connected to prevent escape of dangerous flue gasses which could cause deadly asphyxiation.

Obstructions and deteriorated vent systems may present serious health risk or asphyxiation.

Chemical vapor corrosion of the flue and vent system may occur if air for combustion contains certain chemical vapors. Spray can propellants, cleaning solvents, refrigerator and air conditioner refrigerants, swimming pool chemicals, calcium and sodium chloride, waxes, bleach and process chemicals are typical compounds which are potentially corrosive.

If when inspecting the vent system you find sooting or deterioration, something is wrong. Call the local gas supplier to correct the problem and clean or replace the flue and venting before resuming operation of the water heater.

## Burner Inspection

Flood damage to a water heater may not be readily visible or immediately detectable. However, over a period of time a flooded water heater will create dangerous conditions which can cause **DEATH, SERIOUS BODILY INJURY, OR PROPERTY DAMAGE**. Contact a Sears Service Center to replace a flooded water heater. Do not attempt to repair the unit! It must be replaced!

At least once a year a visual inspection should be made of the main burner and pilot burner. See Figure 23.

You should check for sooting. Soot is not normal and will impair proper combustion.

Soot build-up indicates a problem that requires correction before further use. Turn "OFF" gas to water heater and leave off until repairs are made, because failure to correct the cause of the sooting can result in a fire causing death, serious injury, or property damage.

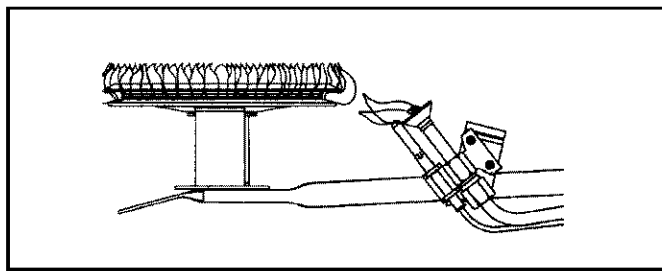

FIGURE 23.

## Burner Cleaning

In the event your burner needs cleaning, following these instructions:

If inspection of the burner shows that cleaning is required, turn the gas control knob clockwise ( ↻ ) to the "OFF" position, depressing slightly.

**NOTE: The knob cannot be turned from "PILOT" to "OFF" unless knob is depressed slightly. DO NOT FORCE.**

Loose deposits on or around the burner can be removed by carefully using the hose of a vacuum cleaner inserted through the access door of the water heater. If the burner needs to be removed for additional cleaning, call the Sears Service Center to remove and clean the burner and correct the problem that required the burner to be cleaned.

## Housekeeping

Vacuum around base of water heater for dust, dirt, and lint on a regular basis.

**INSTALLED IN SUITABLE AREA:** To insure sufficient ventilation and combustion air supply, proper clearances from the water heater must be maintained. See *Facts to Consider About the Location* section. Combustible materials such as clothing, cleaning materials, or flammable liquids, etc. must not be placed against or adjacent to the water heater because they could catch on fire.

	<b>⚠ DANGER</b>
	<b>Fire and Explosion Hazard</b> <ul style="list-style-type: none"> <li>• Do not obstruct combustion air openings at the bottom of the water heater.</li> <li>• Do not use or store flammable vapor products such as gasoline, solvents or adhesives in the same room or area near water heater or other appliance.</li> <li>• Can cause serious injury or death.</li> </ul>

## Anode Rod Inspection

<b>CAUTION</b>
<b>Property Damage Hazard</b>
<ul style="list-style-type: none"> <li>• Avoid water heater damage.</li> <li>• Inspection and replacement of anode rod required.</li> </ul>

The anode rod is used to protect the tank from corrosion. Most hot water tanks are equipped with an anode rod. The submerged rod deteriorates to protect the tank. Instead of corroding the tank, water ions attack and eat away the anode rod. This does not affect the water's taste or color. The rod must be maintained to keep the tank in operating condition.

Anode deterioration depends on water conductivity, not necessarily water condition. A corroded or pitted anode rod indicates high water conductivity and should be checked and/or replaced more often than an anode rod that appears to be intact. Replacement of a depleted anode rod can extend the life of your water heater. Inspection should be conducted by calling the Sears Service Center for an authorized contractor. At a minimum, the anode(s) should be checked annually after the warranty period.

## Temperature-Pressure Relief Valve Operation

The temperature-pressure relief valve must be manually operated at least once a year.

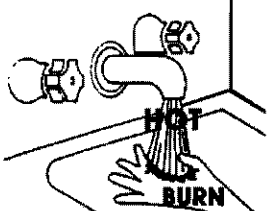
	<ul style="list-style-type: none"> <li>• Burn hazard</li> <li>• Hot water discharge.</li> <li>• Keep clear of relief valve discharge outlet.</li> </ul>
---	---

When checking the temperature-pressure relief valve operation, make sure that (1) no one is in front of or around the outlet of

the temperature-pressure relief valve discharge line, and (2) that the water discharge will not cause any property damage, as the water may be extremely hot, see Figure 24.

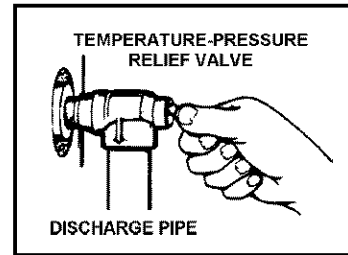
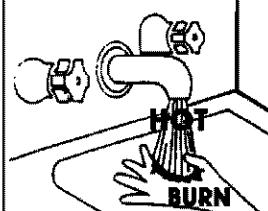

FIGURE 24.

If after manually operating the valve, it fails to completely reset and continues to release water, immediately close the cold water inlet to the water heater, follow the draining instructions, and replace the temperature-pressure relief valve with a new one.

If the temperature-pressure relief valve on the appliance weeps or discharges periodically, this may be due to thermal expansion. You may have a check valve installed in the water line or a water meter with a check valve. Consult the Sears Service Center for further information. Do not plug the temperature-pressure relief valve.

## Draining

	<ul style="list-style-type: none"> <li>• Burn hazard</li> <li>• Hot water discharge.</li> <li>• Keep hands clear of drain valve discharge.</li> </ul>
--	---

The water heater should be drained if being shut down during freezing temperatures. Also periodic draining and cleaning of sediment from the tank may be necessary.

1. Turn the gas control knob to the "OFF" position.
2. CLOSE the cold water inlet valve to the water heater.
3. OPEN a nearby hot water faucet and leave open to allow for draining.
4. Connect a hose to the drain valve and terminate to an adequate drain.
5. OPEN the water heater drain valve to allow for tank draining.

**NOTE:** If the water heater is going to be shut down and drained for an extended period, the drain valve should be left open with hose connected allowing water to terminate to an adequate drain.

6. Close the drain valve.
7. Follow instructions in the *Filling The Water heater* section.

8. Follow the lighting instructions in the *Lighting* section to restart the water heater.

## **Drain Valve Washer Replacement**

---

(See Figure 25)

1. Turn "OFF" gas supply to water heater.
2. Follow "Draining" instructions.
3. Turning counter clockwise ( ↺ ), remove the hex cap below the screw handle.
4. Remove the washer and put the new one in place.
5. Screw the handle and cap assembly back into the drain valve and retighten using a wrench. **DO NOT OVER TIGHTEN.**
6. Follow instructions in the *Filling The Water Heater* section.
7. Check for leaks.
8. Follow the lighting instructions in the *Lighting* section to restart the water heater.

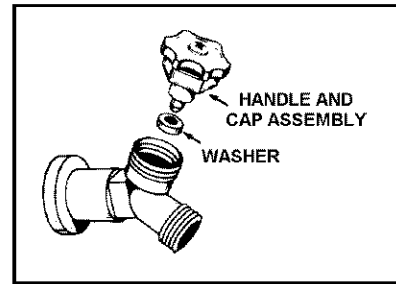

**FIGURE 25.**

## **Service**

---

Before calling for repair service, read the *Start Up Conditions* and *Operational Conditions* found in the *Troubleshooting Guide* of this manual.

If a condition persists or you are uncertain about the operation of the water heater, let the Sears Service Center check it out.

Contact Sears Service Center at:

1-800-4-MY-HOME (1-800-469-4663).

# TROUBLESHOOTING GUIDE

## Start Up Conditions

### Thermal Expansion

CAUTION

Property Damage Hazard

- Avoid water heater damage.
- Install thermal expansion tank or device if necessary.
- Contact qualified installer or service agency.

Water supply system may, because of such events as high line pressure, frequent cut-offs, and the effects of water hammer have installed devices such as pressure reducing valves, check valves, back flow preventers, etc., to control these types of problems. When these devices are not equipped with an internal by-pass, and no other measures are taken, the devices cause the water system to be closed. As water is heated, it expands (thermal expansion) and closed systems do not allow for the expansion of heated water.

The water within the water heater tank expands as it is heated and increases the pressure of the water system. If the relieving point of water heater's temperature-pressure relief valve is reached, the valve will relieve the excess pressure. **The temperature-pressure relief valve is not intended for the constant relief of thermal expansion.** This is an unacceptable condition and must be corrected.

It is recommended that any devices installed which could create a closed system have a by-pass and/or the system have an expansion tank or device to relieve the pressure built by thermal expansion. Thermal expansion tanks are available from Sears stores and through the Sears Service Centers. Contact the local plumbing inspector, water supplier and/or the Sears Service Center for assistance in controlling these situations. See Figure 26.

### Thermal Expansion Tank Specifications

Model Number	Tank Capacity In Gallons	Dimensions in Inches		Pipe Fitting On Tank
		Diameter	Length	
153.331020	2	8 (203 mm)	12-3/4 (323 mm)	3/4" Male
153.331050	5	11 (279 mm)	14-3/4 (375 mm)	3/4" Male

### Expansion Tank Sizing Chart

Expansion Tank Capacity Needed	Inlet* Water Pressure	Water Heater Capacity (Gallons)				
		30	40	50	66	80
	40 psi	2	2	2	5	5
50 psi	2	2	2	5	5	
60 psi	2	2	5	5	5	
70 psi	2	2	5	5	5	
80 psi	2	5	5	5	5	

\*Highest recorded inlet water pressure in a 24 hour period or regulated water pressure.

**NOTE:** Expansion tanks are pre-charged with a 40 psi air charge. If the inlet water pressure is higher than 40 psi, the expansion tank's air pressure must be adjusted to match that pressure, but must not be higher than 80 psi.

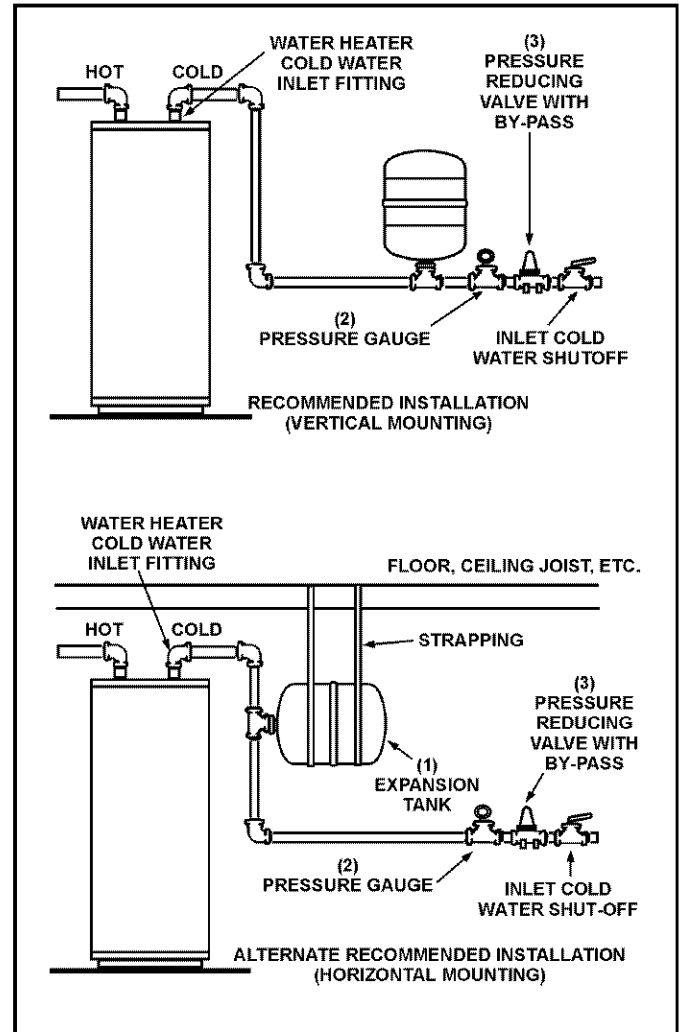

FIGURE 26.

## Strange Sounds

Possible noises due to expansion and contraction of some metal parts during periods of heat-up and cool-down do not represent harmful or dangerous conditions.

Condensation causes sizzling and popping within the burner area during heating and cooling periods and should be considered normal. See *Condensation* section.

## Draft Hood Operation

Check draft hood operation by performing a worst case depressurization of the building. With all doors and windows closed, and with all air handling equipment and exhaust fans operating such as furnaces, clothes dryers, range hoods and bathroom fans, a match flame should still be drawn into the draft hood of the water heater with its burner firing. If the flame

is not drawn toward the draft hood, shut off water heater and make necessary air supply changes to correct.

## Condensation

Whenever the water heater is filled with cold water, some condensate will form while the burner is on. A water heater may appear to be leaking when in fact the water is condensation. This usually happens when:

- A new water heater is filled with cold water for the first time.
- Burning gas produces water vapor. In water heaters, particularly high efficiency models where flue temperatures are lower.
- Large amounts of hot water are used in a short time and the refill water in the tank is very cold.

Moisture from the products of combustion condense on the cooler tank surfaces and form drops of water which may fall onto the burner or other hot surfaces to produce a “sizzling” or “frying” noise.

Excessive condensation can cause pilot outage due to water running down the flue tube onto the main burner and putting out the pilot.

Because of the suddenness and amount of water, condensation water may be diagnosed as a “tank leak”. After the water in the tank warms up (about 1-2 hours), the condition should disappear.

Do not assume the water heater is leaking until there has been enough time for the water in the tank to warm up.

An undersized water heater will cause more condensation. The water heater must be sized properly to meet the family's demands for hot water including dishwashers, washing machines and shower heads.

Excessive condensation may be noticed during the winter and early spring months when incoming water temperatures are at their lowest.

Good venting is essential for a gas fired water heater to operate properly as well as to carry away products of combustion and water vapor.

## Smoke / Odor

It is not uncommon to experience a small amount of smoke and odor during the initial start-up. This is due to burning off of oil from metal parts, and will disappear in a short while.

## Operational Conditions

### Smelly Odor

In each water heater there is installed at least one anode rod (see parts section) for corrosion protection of the tank. Certain water conditions will cause a reaction between this rod and the water. The most common complaint associated with the anode rod is one of a “rotten egg smell”. This odor is derived

from hydrogen sulfide gas dissolved in the water. The smell is the result of four factors which must all be present for the odor to develop:

- a concentration of sulfate in the supply water.
- little or no dissolved oxygen in the water.
- a sulfate reducing bacteria within the water heater. (This harmless bacteria is non-toxic to humans.)
- an excess of active hydrogen in the tank. This is caused by the corrosion protective action of the anode.

Smelly water may be eliminated or reduced in some water heater models by replacing the anode(s) with one of less active material, and then chlorinating the water heater tank and all hot water lines. Contact Sears Service for further information concerning an Anode Replacement Kit #9001453 and this Chlorination Treatment.

If the smelly water persists after the anode replacement and chlorination treatment, we can only suggest that chlorination or aeration of the water supply be considered to eliminate the water problem.

**Do not remove the anode leaving the tank unprotected. By doing so, all warranty on the water heater tank is voided.**

### “AIR” In Hot Water Faucets

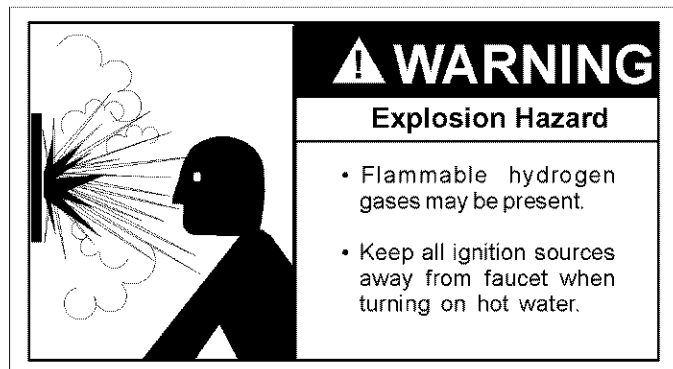

**HYDROGEN GAS:** Hydrogen gas can be produced in a hot water system that has not been used for a long period of time (generally two weeks or more). Hydrogen gas is extremely flammable and explosive. To prevent the possibility of injury under these conditions, we recommend the hot water faucet, located farthest away, be opened for several minutes before any electrical appliances which are connected to the hot water system are used (such as a dishwasher or washing machine). If hydrogen gas is present, there will probably be an unusual sound similar to air escaping through the pipe as the hot water faucet is opened. There must be no smoking or open flame near the faucet at the time it is open.

### High Temperature Shut Off System

This water heater is equipped with an automatic gas shut-off system. This system works when high water temperatures are present. Turn “OFF” the entire gas supply to the water heater. The high temperature shut-off is built into the gas control valve. It is non-resettable. If the high temperature shut-off activates, the gas control valve must be replaced. Contact your gas supplier.



## Operational Conditions (Continued)

### Leakage Checkpoints

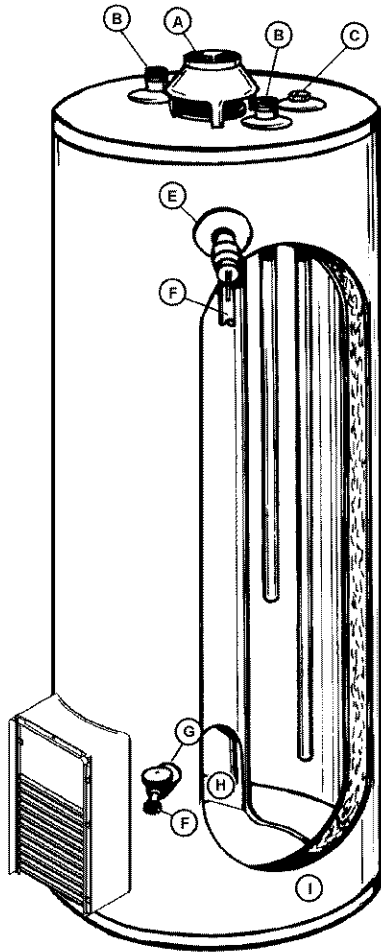
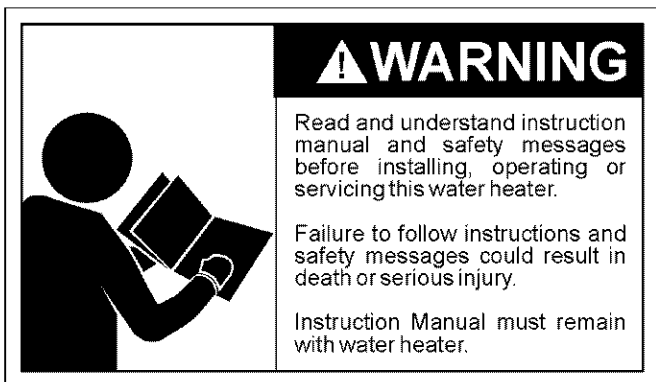

FIGURE 27.



Read this manual first. Then before checking the water heater make sure the gas supply has been turned "OFF", and never turn the gas "ON" before the tank is completely full of water.

Never use this water heater unless it is completely filled with water. To prevent damage to the tank, the tank must be filled with water. Water must flow from the hot water faucet before turning "ON" gas to the water heater, see Figure 27.

- A. Water at the draft hood is water vapor which has condensed out of the combustion products. This is caused by a problem in the vent. Contact the gas utility.
- B. \*Condensation may be seen on pipes in humid weather or pipe connections may be leaking.
- C. \*The anode rod fitting may be leaking.
- D. Small amounts of water from temperature-pressure relief valve may be due to thermal expansion or high water pressure in your area.
- E. \*The temperature-pressure relief valve may be leaking at the tank fitting.
- F. Water from a drain valve may be due to the valve being slightly opened.
- G. \*The drain valve may be leaking at the tank fitting.
- H. Combustion products contain water vapor which can condense on the cooler surfaces of the tank. Droplets form and drip onto the burner or run on the floor. This is common at the time of start-up after installation and when incoming water is cold.
- I. Water in the water heater bottom or on the floor may be from condensation, loose connections, or the relief valve. DO NOT replace the water heater until a full inspection of all possible water sources is made and necessary corrective steps taken.

Leakage from other appliances, water lines, or ground seepage should also be checked.

- \* To check where threaded portion enters tank, insert cotton swab between jacket opening and fitting. If cotton is wet, follow "Draining" instructions in the *Periodic Maintenance* section and then remove fitting. Put pipe dope or teflon tape on the threads and replace. Then follow *Filling the Water Heater* instructions in the *Installing the New Water Heater* section.

## TROUBLESHOOTING GUIDE (Continued)

These guidelines should be used by a qualified service agent.  
Call Sears Service at 1-800-4-MY-HOME (1-800-469-4663) for assistance.

Problem	Cause	Solution
<b>WATER LEAKS</b>	Improperly sealed, hot or cold supply connection, relief valve, drain valve, or thermostat threads.	Tighten threaded connections.
	Leakage from other appliances or water lines.	Inspect other appliances near water heater.
	Condensation of flue products.	Refer to CONDENSATION.
<b>LEAKING T&amp;P VALVE</b>	Thermal expansion in closed water system.	Install thermal expansion tank (DO NOT plug T&P valve).
	Improperly seated valve.	Check relief valve for proper operation (DO NOT plug T&P valve).
<b>HOT WATER ODORS</b>	High sulfate or mineral content in water supply.	Drain and flush heater thoroughly, then refill.
	Bacteria in water supply.	Chlorinate or aerate water supply.
<b>PILOT OUTAGE</b>	Dirty pilot burner.	Clean pilot assembly.
	Thermocouple tip is not in contact with pilot flame.	Insert thermocouple correctly.
	Thermocouple malfunction.	Replace thermocouple.
	Thermocouple malfunction.	Check thermostat.
<b>PILOT WILL NOT LIGHT</b>	Gas knob dial not positioned correctly.	Refer to LIGHTING INSTRUCTIONS.
	Pilot orifice clogged.	Clean or replace pilot orifice.
	Pinched or clogged pilot tube.	Replace pilot tube.
	Main gas supply off.	Turn on main gas shutoff valve.
<b>NOT ENOUGH OR NO HOT WATER</b>	Heater not lit or thermostat not on.	Refer to LIGHTING INSTRUCTIONS.
	Thermostat set too low.	Refer to TEMPERATURE REGULATION.
	Heater undersized.	Reduce the hot water use.
	Low gas pressure.	Contact dealer.
	Incoming water is unusually cold.	Allow more time for heater to re-heat.
	Leaking hot water pipes or fixtures.	Have a plumber check and repair leaks.
<b>WATER TOO HOT</b>	High temperature limit switch activated.	Contact Sears Service Center to determine cause.
	Thermostat set too high.	Refer to HIGH TEMPERATURE REGULATION.
<b>WATER HEATER SOUNDS: SIZZLING - RUMBLING</b>	Condensation dripping on burner.	Refer to CONDENSATION.
	Sediment at bottom of heater tank.	Clean sediment from tank. Refer to DRAINING instructions in Maintenance section of manual.
<b>SOOTING</b>	Improper combustion.	Refer to COMBUSTION AIR AND VENTILATION requirements on pages 10 to 12.

# PARTS ORDER LIST

## POWER MISER™ 12 GAS WATER HEATER

### MODEL NO'S

153.331712HA	75 U.S. Gal. (284 Litres) High Altitude
153.331740	75 U.S. Gal. (284 Litres)

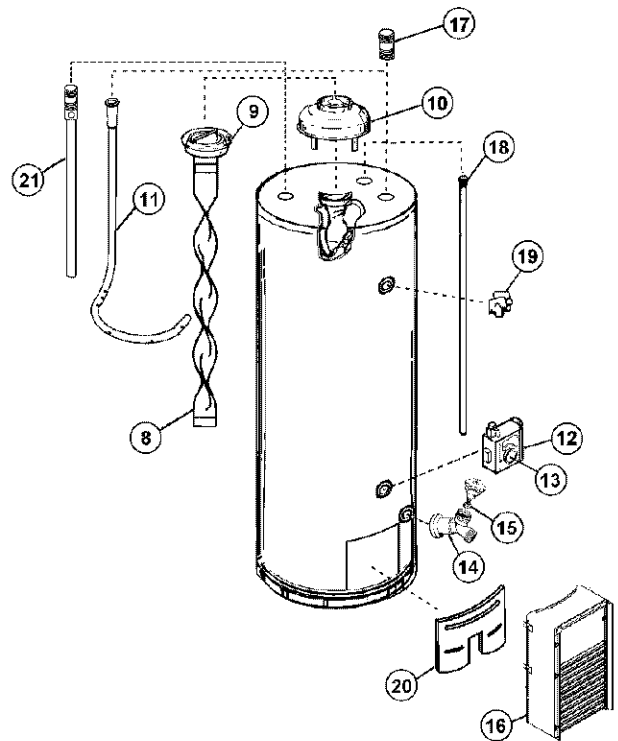
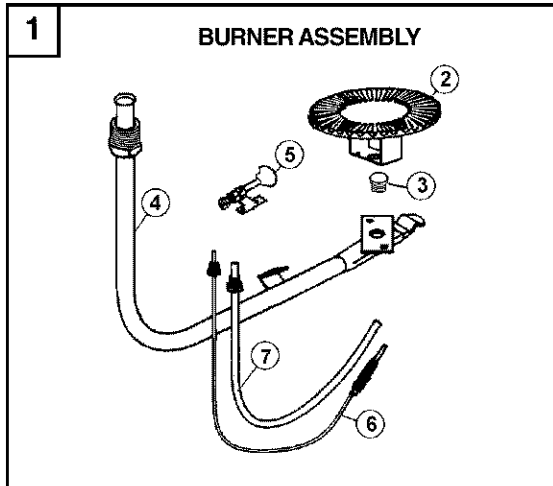

Key No.	Part Description	Model Numbers	
		153.331712HA	153.331740
1	Burner Assembly (Includes items 2-7)	9003927	9003927
2	Burner Head	9002411	9002411
3	Burner Orifice	0230160 (#31)	0230144 (#29)
4	Burner Tube	9002621	9002621
5	Pilot Assembly	9000285	9000285
6	Thermocouple	9000283	9000283
7	Pilot Tubing w/Fittings	9000278	9000278
8	Flue Baffle	9001452	9001452
9	Flue Restrictor	9000297	9000297
10	Draft Hood	9000274	9000274
11	Inlet Tube	9002444	9002444
12	Gas Control Valve	F145-1277	F145-1277
13	Temperature Adjustment Knob	F145-1280	F145-1280
14	Drain Valve	9002402	9002402
15	Drain Valve Washer	9001584	9001584
16	Outer Door	9002494	9002494
17	Nipple w/Heat Trap	9003719	9003719
18	Anode Rod	9000734	9000734
19	Temperature-Pressure Relief Valve	9003895	9003895
20	Inner Door	9000281	9000281
21	Secondary Anode Rod w/Heat Trap	9003967	9003967
*	Instruction Manual	184770-000	184770-000

\* Not Shown.

Now that you have purchased your gas water heater, should a need ever exist for repair parts or service, simply contact any Sears Service Center or call 1-800-4-MY-HOME (1-800-469-4663). Be sure to provide all pertinent facts when you call or visit.

All parts listed may be ordered from any Sears Service Center and by calling 1-800-366-PART (1-800-366-7278). If the parts you need are not stocked locally, your order will be electronically transmitted to a SEARS Repair Parts Distribution Center for handling.

WHEN ORDERING REPAIR PARTS, ALWAYS GIVE THE FOLLOWING INFORMATION:

- MODEL NUMBER
- SERIAL NUMBER
- TYPE GAS (NATURAL OR PROPANE (L.P.))
- PART DESCRIPTION

THIS IS A REPAIR PARTS LIST, NOT A PACKING LIST.

## FULL ONE YEAR WARRANTY ON WATER HEATER

For one year from the date of purchase, when your Sears Kenmore water heater is installed and operated in a single-family residence in accordance with the instructions in this manual, Sears will:

1. Repair defects in material or workmanship in this water heater, free of charge.
2. Furnish and install a new current model water heater of equal capacity and quality, free of charge, if a leak occurs in the tank.

## LIMITED WARRANTY ON TANKS THAT LEAK

After one year and through 12 years from date of purchase for water heaters used in a single-family residence, if a leak occurs in the tank, Sears will furnish a new current model water heater of equal capacity and quality. You will be charged for any installation.

## LIMITED WARRANTY ON PARTS

After one year and through 12 years from the date of purchase, when your Sears Kenmore water heater is used in a single-family residence and is installed and operated in accordance with the information in this manual, if a part fails due to materials or workmanship, Sears will furnish a replacement free of charge. You will be charged for labor.

If the water heater is subject to commercial, institutional, industrial or use in residences of two families or more, the above warranty coverage for tanks that leak is effective for 2 years from the date of purchase and the above parts warranty is effective for 1 year from the date of purchase.

To obtain warranty service, SIMPLY CALL 1-800-4-MY-HOME® (1-800-469-4663). This warranty applies only while this product is in use in the United States.

This warranty gives you specific legal rights and you may also have other rights which vary from state to state.

Sears, Roebuck and Co., Dept. 817 WA, Hoffman Estates, IL 60179

**The price of your water heater does not include a free checkup service call.** On water heater installations arranged by Sears, Sears warrants the installation.

A charge will be made on service calls due to poor or incomplete installation. These include:

- |                         |                               |                 |
|-------------------------|-------------------------------|-----------------|
| a. Adjusting thermostat | c. Leaks in pipes or fittings | e. Condensation |
| b. Lighting pilot       | d. Improper venting           |                 |

## MASTER PROTECTION AGREEMENTS

*Congratulations* on making a smart purchase. Your new Kenmore® product is designed and manufactured for years of dependable operation. But like all products, it may require preventive maintenance or repair from time to time. That's when having a Master Protection Agreement can save you money and aggravation.

Purchase a Master Protection Agreement now and protect yourself from unexpected hassle and expense.

The Master Protection Agreement also helps extend the life of your new product. Here's what's included in the Agreement:

- **Expert Service** by our 12,000 professional repair specialist.
- **Unlimited service and no charge** for parts and labor on all covered repairs.
- **"No-lemon" guarantee** - replacement of your covered product if four or more product failures occur within twelve months.
- **Product replacement** if your covered product can't be fixed.
- **Annual Preventive Maintenance Check** at your request - no extra charge.

- **Fast help by phone** - phone support from a Sears technician on products requiring in-home repair, plus convenient repair scheduling.
- **Power surge protection** against electrical damage due to power fluctuations.
- **Rental reimbursement** if repair of your covered product takes longer than promised.

Once you purchase the Agreement, a simple phone call is all that it takes for you to schedule service. You can call anytime day or night, or schedule a service appointment online.

Sears has over 12,000 professional repair specialists, who have access to over 4.5 million quality parts and accessories. That's the kind of professionalism you can count on to help prolong the life of your new purchase for years to come. Purchase your Master Protection Agreement today!

**Some limitations and exclusions apply. For prices and additional information call 1-800-827-6655.**

## SEARS INSTALLATION SERVICE

*For Sears professional installation* of home appliances, garage door openers, water heaters, and other major home items, in the U.S.A., call **1-800-4-MY-HOME®**.

# SEARS

For in-home major brand repair service  
Call 24 hours a day, 7 days a week (U.S.A. and Canada)

**1-800-4-MY-HOME®**

(1-800-469-4663)  
[www.sears.com](http://www.sears.com)

The model number of your water heater is found on the model rating plate on the front of the water heater.

**Sears, Roebuck and Co., Hoffman Estates, IL 60179 U.S.A**

## Free Manuals Download Website

<http://myh66.com>

<http://usermanuals.us>

<http://www.somanuals.com>

<http://www.4manuals.cc>

<http://www.manual-lib.com>

<http://www.404manual.com>

<http://www.luxmanual.com>

<http://aubethermostatmanual.com>

Golf course search by state

<http://golfingnear.com>

Email search by domain

<http://emailbydomain.com>

Auto manuals search

<http://auto.somanuals.com>

TV manuals search

<http://tv.somanuals.com>