

# SEARS

## Owner's Manual

Model Nos.

14071  
14072  
14074  
14075

Model and Serial  
Number Plate

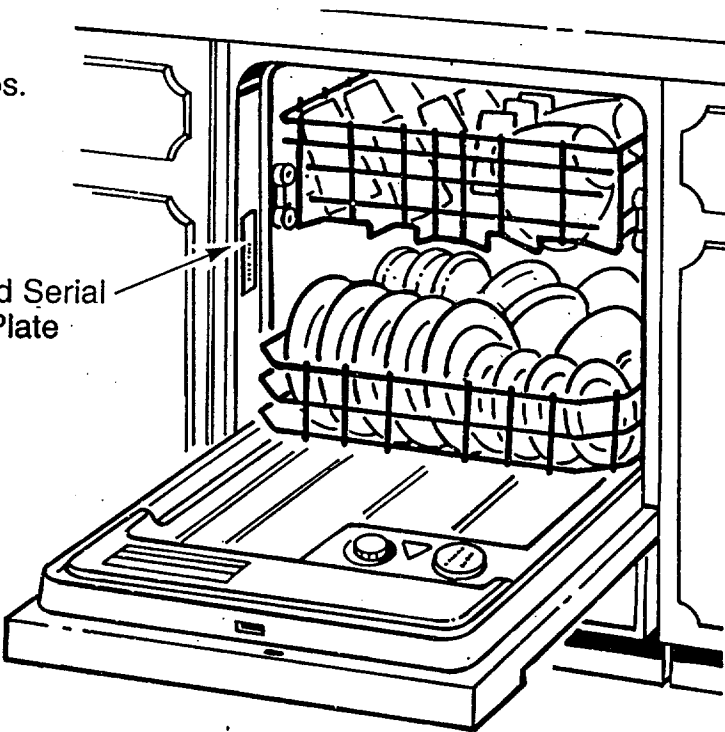

## **Kenmore** AUTOMATIC DISHWASHER

**CAUTION:** Read and follow all Safety Rules and Operating Instructions before first use of this product.

**Sears, Roebuck and Co., Hoffman Estates, IL 60179 U.S.A.**

165D3592P059  
SR5558-1

42 CG  
Printed in U.S.A.

**SAFETY**

**ASSEMBLY**

**OPERATION**

**MAINTENANCE**

**PARTS LIST**

## CONTENTS

Warranty .....	Below	Rinse Agent Dispenser .....	9
Important Safety Instructions .....	3	Proper Loading .....	10
Important Parts of Your Dishwasher ..	4	User Maintenance Instructions .....	12
What Your Dishwasher Needs .....	5	Care and Cleaning .....	12
Special Tips .....	6	Air Gap .....	12
Operating Instructions .....	7-8	Color Panels .....	13
Detergent Dispenser .....	9	Problems and Solutions .....	14-17
Detergent Usage Guide .....	9	Sears Service .....	20

## WARRANTY

### **Full One-Year Warranty on Dishwasher**

For one year from the first day of use in your home, Sears will repair, free of charge, defects in material or workmanship which appear in this dishwasher.

### **Full Ten-Year Warranty Against Leaks in the Tub and Inner Door Panel**

For ten years from the first day of use in your home, if a leak should occur as a result of failure of the tub or inner door panel due to cracking, chipping, or peeling, Sears will replace, free of charge, the tub or inner door panel.

If the dishwasher is subjected to other than private family use, the above warranty coverage is effective for only 90 days.

Warranty service is available by contacting the nearest Sears Service Center/Department in the United States. This warranty applies only while this product is in use in the United States.

This warranty gives you specific legal rights, and you may also have other rights which vary from state to state.

The model number of your automatic dishwasher is found on the serial plate fastened to the tub wall just inside the dishwasher door.

All repair parts are available for immediate purchase or special order when you visit your nearest Sears Service Center, or the Service Department at most Sears Stores. To request service or order parts by phone, call the toll free number listed on the back cover.

When requesting service or ordering, always provide the following information:

- Product Type
- Part Number
- Model Number
- Part Description

**Sears, Roebuck and Co.,  
Dept. 817WA,  
Hoffman Estates, IL 60179**

## IMPORTANT SAFETY INSTRUCTIONS

### **⚠ WARNING:**

Please follow these basic precautions, including the following:

- Read all instructions before using your dishwasher.
- Only use detergents and rinse agents recommended for use in a dishwasher.
- Store detergents and rinse agents in a cool dry place out of children's reach.
- Do not tamper with controls.
- Do not operate dishwasher unless all enclosure panels are properly in place.
- Always disconnect electrical power to dishwasher before attempting to service it. We recommend having a qualified technician service your appliance.
- Remember, use dishwasher for its intended purpose only.
- Do not wash plastic items unless marked "Dishwasher Safe" or equivalent. If unmarked, check manufacturer's recommendations.
- This dishwasher must be properly installed in accordance with the Installation Instructions before it is used.
- To avoid risk of electrical shock, the dishwasher must be electrically grounded before it is operated.
- If you did not receive Installation Instructions with your dishwasher, you can get a copy by contacting your Sears Service Center.
- Do not touch heating unit during or immediately after use. Allow time to cool.
- Load sharp or pointed tableware with handles up (points down) to avoid injury when reaching into dishwasher.
- Load sharp items and knives so they aren't likely to damage door seal.
- Do not sit or stand on or abuse dishwasher door or dishracks.
- Do not allow children to play in or on dishwasher.
- When discarding old dishwasher, be sure to remove door to prevent accidental entrapment.
- Do not install the dishwasher on carpeted floor.

### **GROUNDING INSTRUCTIONS**

- Connect to a properly rated, protected sized power-supply circuit to avoid electrical overload.
- This appliance must be connected to a grounded metal, permanent wiring system; or an equipment-grounding conductor must be run with the circuit conductors and connected to the equipment-grounding terminal or lead of the appliance.

### **⚠ WARNING:**

The improper connection of the equipment-grounding conductor can result in a risk of electric shock. Check with a qualified electrician or service representative if you are in doubt whether the appliance is properly grounded.

### **⚠ WARNING:**

Under certain conditions, hydrogen gas may build up in a hot water system that has not been used for two weeks or more. **HYDROGEN GAS IS EXPLOSIVE.** To prevent injury or damage, before using dishwasher, turn on all hot water faucets and allow water to run for several minutes. This will allow gases to escape. As the gas is flammable, do not smoke or use an open flame or appliance near faucets while they are open.

**NOTE:** Do not store or use combustible materials, gasoline or other flammable vapors and liquids in the vicinity of this or any other appliance.

## SAVE THESE INSTRUCTIONS

# IMPORTANT PARTS OF YOUR DISHWASHER

Appearance will vary according to the model number

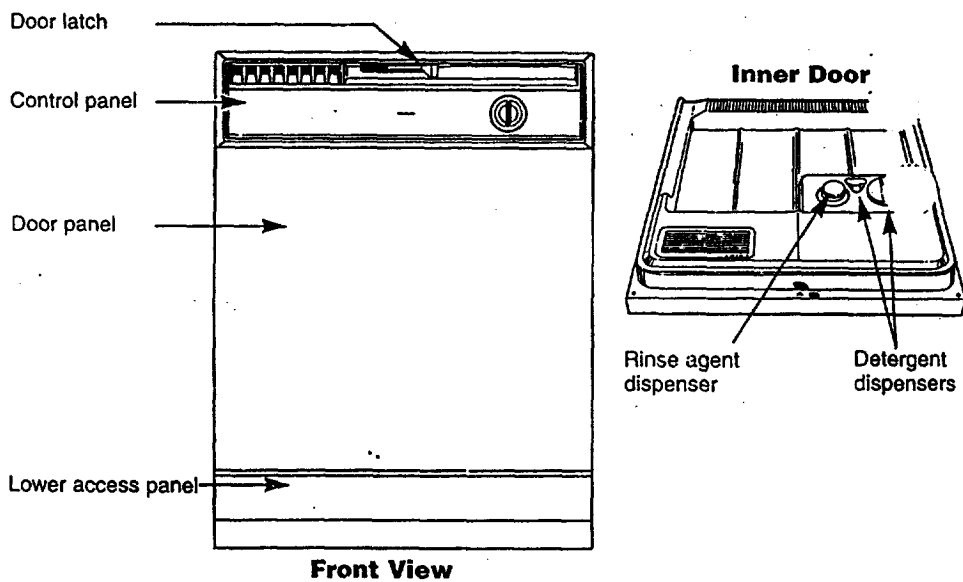
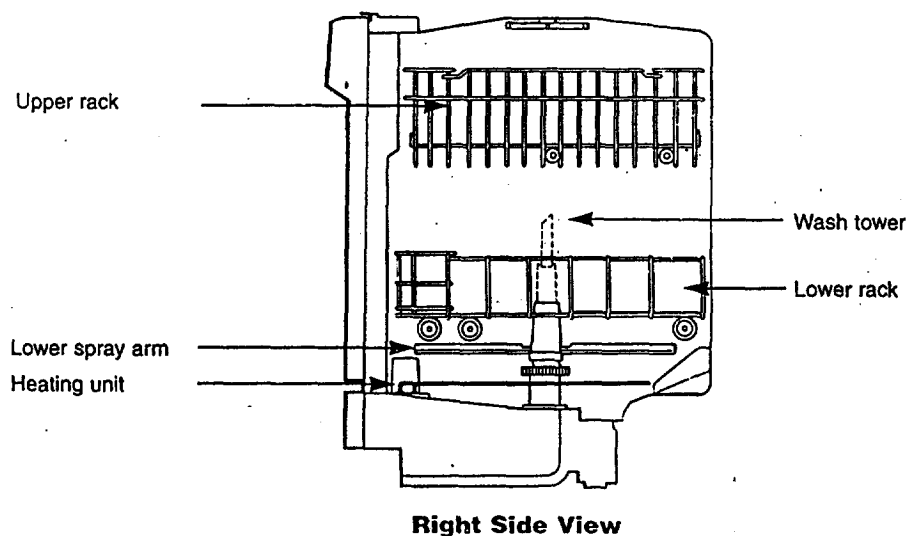

## PARTES IMPORTANTES DE SU LAVADORA DE PLATOS

La apariencia varía según el número de modelo

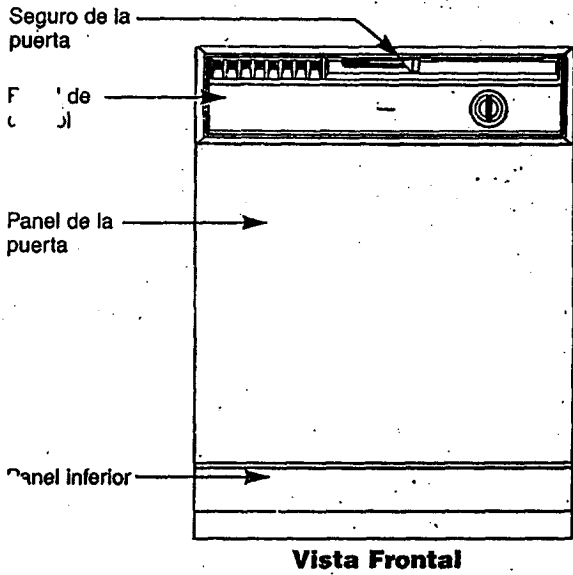
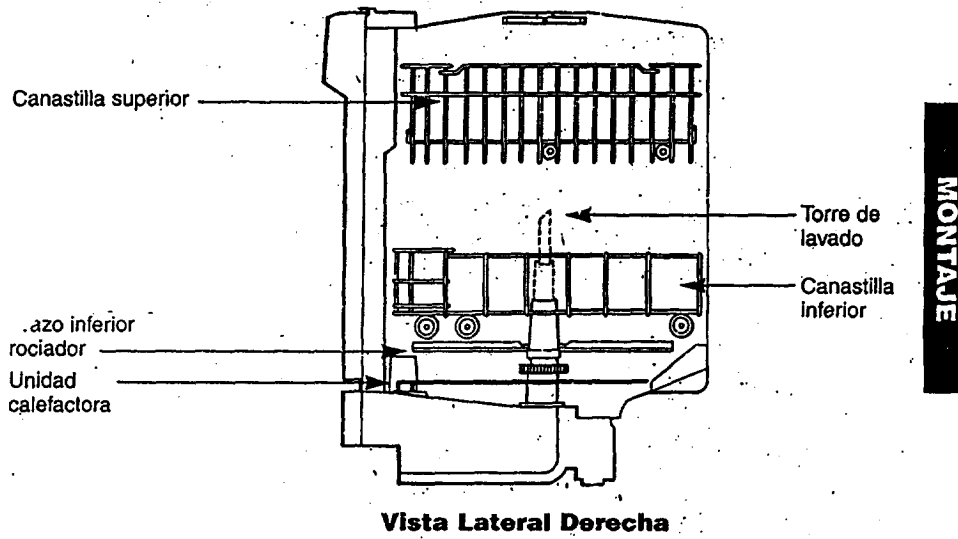

## LO QUE SU LAVADORA DE PLATOS NECESITA PARA FUNCIONAR

### Agua Caliente

Para limpiar y secar los platos usted necesita agua caliente. Para ayudarle a usted a obtener agua a una temperatura apropiada, su lavadora de platos calienta el agua automáticamente en el ciclo de lavado. Se necesita agua a temperatura elevada para disolver la grasa y activar los detergentes en polvo. Para un buen lavado y secado, el agua que entra debe tener una temperatura de por lo menos 120°F. Para evitar daño a los platos, el agua entrante no debe exceder los 150°F.

Compruebe la temperatura de su agua con un termómetro para caramelo o carne.

Abra la llave del agua caliente más cercana a la lavadora de platos. Ponga el termómetro en un vaso y deje que el agua corra continuamente dentro del vaso hasta que la temperatura deje de subir.

No ponga a funcionar la lavadora de platos durante o inmediatamente después de otro uso abundante de agua caliente, tal como el lavado de ropa o un baño.

### Presión del Agua

La presión del suministro de agua deberá estar entre 15 y 120 libras por pulgada cuadrada.

Para determinar si usted tiene suficiente presión, ponga un recipiente con una capacidad de un cuarto de galón debajo de la llave de agua caliente más cercana a la lavadora de platos y abra la llave al máximo. Si el recipiente se llena en menos de 9 segundos, la presión del agua está dentro de un margen aceptable. Cerciórese de que todas las demás llaves de agua estén cerradas durante esta prueba.



### Condiciones del Agua

En las áreas donde el agua es muy dura (12 granos o más), pudiera hacerse necesaria la instalación de un suavizador de agua para asegurar el rendimiento apropiado de su lavadora de platos. Si usted no sabe el grado de dureza de su suministro de agua, póngase en contacto con su departamento local de agua o traiga una muestra a su tienda Sears para hacer una prueba.



### Detergentes

Use solamente detergentes especiales para uso en lavadoras de platos automáticas. NUNCA use en su lavadora de platos detergentes de lavar ropa, jabones líquidos u otros limpiadores caseros. Algunos detergentes serán más eficaces que otros, de acuerdo con las condiciones de su agua. Almacene el detergente en un lugar fresco y seco.



### Agentes de Enjuague

Los agentes de enjuague hacen que el agua corra sobre los platos más rápidamente que lo usual. Esto disminuye las manchas de agua y hace que el secado sea más rápido también.

Los agentes de enjuague se pueden obtener ya sea en forma líquida o sólida. El dispensador de su lavadora de platos usa la forma líquida.



# OPERATING INSTRUCTIONS

Appearance may vary

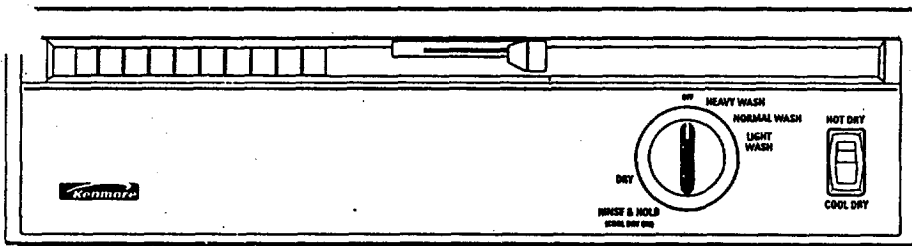

## STARTING YOUR DISHWASHER

- Load the dishwasher (see pages 10 and 11).
- Add detergent (see page 9).
- Close the door but do not latch it.
- If dishwasher drains into a food waste disposer, operate disposer until it is empty.
- Turn on hot water faucet nearest dishwasher and let it run until the water is hot.
- Turn the Dial to the desired wash cycle. Then latch the door to start the dishwasher.

## SELECT THE CYCLE

### HEAVY WASH

For heavily soiled dishes and pots and pans.

Cycle Time: Approx. 93 minutes  
Water Usage: Approx. 9.5 gallons



Rinse Rinse Rinse Wash Rinse Rinse Rinse Dry Off

### NORMAL WASH

For normally soiled dishes.

Cycle Time: Approx. 89 minutes  
Water Usage: Approx. 8.0 gallons

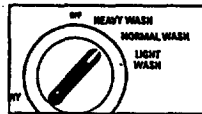

Rinse Rinse Wash Rinse Rinse Rinse Dry Off

### LIGHT WASH

For pre-rinsed or lightly soiled dishes and dishes that have been stored.

Cycle Time: Approx. 86 minutes  
Water Usage: Approx. 6.6 gallons



Rinse Wash Rinse Rinse Rinse Dry Off

### RINSE & HOLD

For rinsing dishes that will be washed later.  
**DO NOT USE DETERGENT.**

Cycle Time: Approx. 12 minutes  
Water Usage: Approx. 3.9 gallons



Rinse Rinse Rinse Off Select COOL DRY no-heat drying option.

OPERATION

## SELECT OPTIONS

### HOT DRY Option

Turns drying heating unit on for fast drying.

### COOL DRY Option

Turns heating unit off for entire drying period. To shorten drying time, open dishwasher door slightly.

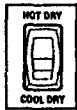

## HOW TO ADD A DISH DURING A CYCLE

- Add dishes any time during RINSE & HOLD cycle.
- With other wash cycles, you can add dishes at any time BEFORE the detergent cup has opened.

Here's how to add a forgotten dish:

1. Push door latch to the left. Washing will stop.
2. Wait a few seconds until the water calms. Then open the door.
3. Add dishes you've forgotten.

## NORMAL SIGHTS AND SOUNDS

- You'll see water vapor coming through the vents by the door latch during drying and when water is being pumped out.
- You'll hear occasional sounds while your dishwasher is running:
  - Soft food disposer shredding action.
  - Drain valve opening to pump water out.
  - Timer control as cycle progresses.
  - Detergent cup opening.
  - Pump motor starting.
  - The motor stops during drying.

## PREPARING DISHES FOR WASHING

- Prerinsing of normal food soil is not necessary.
- Scrape off bones, seeds, skins, toothpicks and other hard soils.
- Remove hard shelled vegetables, meat trimmings, leafy vegetables, and excessive amounts of oil or grease.
- Remove foods with high acid content—they can discolor stainless steel.
- Remove large quantities of any food.
- When using the HEAVY WASH cycle, less preparation is required. This cycle can wash heavily-soiled dishes and remove dried-on and baked-on soils from pots, pans and casseroles. However, items with burned-on soils may not come clean.

## ENERGY AND WATER SAVING TIPS

- Wash full loads.
- Use your dishwasher during off-peak hours.
- Use the LIGHT WASH cycle whenever possible.
- Select COOL DRY option when you don't need dry dishes in a hurry.
- Don't prerinse normally soiled dishes.
- Load correctly to ensure good washing action.



## DETERGENT DISPENSER

You'll find two detergent dispensers on the inside door of your dishwasher.

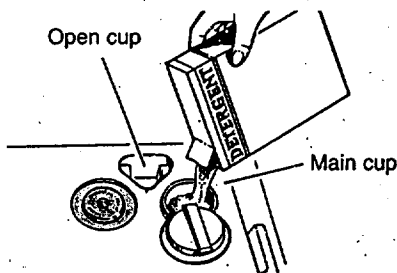

Do not add detergent until you are ready to start the cycle. Use fresh detergent.

The dispenser will automatically release detergent at the correct times during the cycle.

Always close the main cup tightly. When it is firmly latched you will hear a clicking sound. It is not necessary to overtighten.

Grasp handle, rotate and close tightly

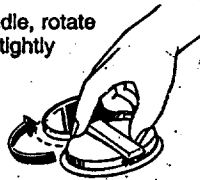

Close the main cup.

**NOTE:** To open the detergent dispenser after it has been closed, unlatch the door and rotate the Dial a full turn to the OFF position. When the closed cup contains soap it is best that the door be in a partially open position before rotating the Dial. This will help reduce the amount of detergent and rinse aid agent spillage into the tub.

### Detergent Usage Guide (powder or liquid)

Cycles	Soft Water (0 to 3 grains)	Moderately Hard Water (4 to 8 grains)	Hard Water (9 to 12 grains)	Very Hard Water (over 12 grains)
Light Wash	Main Cup 1 tablespoon	Main Cup Half Full	Main Cup Completely Full	Water Softener Recommended
Heavy Wash Normal Wash	Each Cup 1 tablespoon	Each Cup Half Full	Each Cup Completely Full	Water Softener Recommended
Rinse & Hold	No Detergent	No Detergent	No Detergent	Water Softener Recommended

## RINSE AGENT DISPENSER

### To fill the dispenser:

Unscrew the cap. Note the FULL line on the tip of the cap. Add the liquid rinse agent until it just reaches the top of the FULL line. Replace the cap. The dispenser automatically releases the rinse agent into the final rinse water.

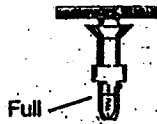

Fill as needed, but do not overfill.

## PROPER LOADING

### UPPER RACK (appearance will vary)

The upper rack is best for glasses, cups and saucers. Cups and glasses fit best along the sides. This is also the place for dishwasher safe plastics. Make sure small plastic items are lodged in tightly so they can't fall onto the heating unit. Arrange stemware so that it cannot move easily. Don't let the glasses touch each other.

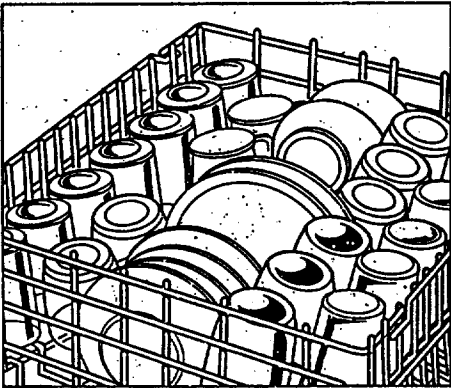

The upper rack is handy for all kinds of odd shapes. Saucepans, mixing bowls and other items should be placed face down. When loading dishwasher-safe plastics make sure each plastic item is secured over two fingers. This will insure good washing results.

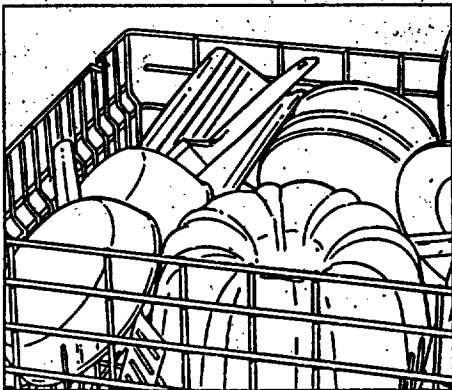

**LOWER RACK** (appearance will vary)

**NOTE:** Do not load large platters or trays on right corner of lower rack. They may prevent detergent from circulating in the wash cycle.

The lower rack is best used for plates, saucers, and cookware. Large items such as broiler pans and racks should go in the lower rack along the edge. Load platters, pots and bowls along the sides, in corners, or in the back. For best washing results, all items should be positioned with the soiled side of the dish facing the center of the rack.

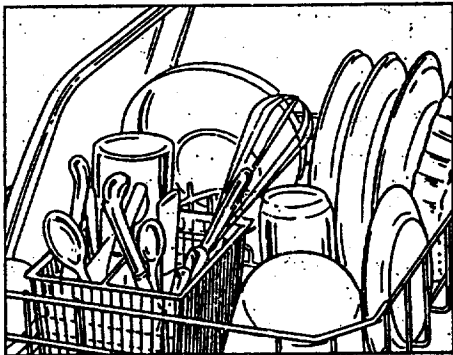

**Keep center area clear in the lower rack.**

The Wash Tower rises through the center of the lower rack during the wash and rinse portions of the cycle. Don't block it or load tall things next to it. Also, be careful not to let a portion of an item such as a pot or dish handle extend through the bottom rack. This could block the wash arm and cause poor washing results.

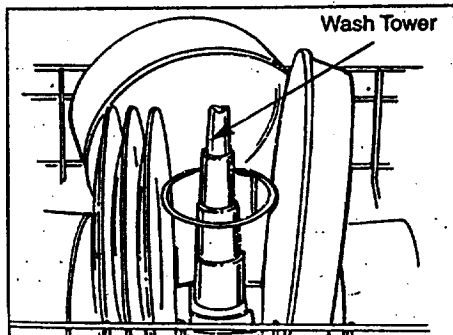

Put flatware in the removable basket with fork and knife handles up to protect your hands. Place spoons in the basket with handles down. Mix knives, forks and spoons so they don't nest together. Distribute evenly.

Small plastic items, such as measuring spoons and lids from small containers, are not recommended for automatic dishwashing. If placed in dishwasher, they should go in bottom of utensil basket with silverware on top.



**CAUTION**

Take out anything that may fall or extend through the bottom of the utensil basket.

## USER MAINTENANCE INSTRUCTIONS

### CARE OF SURFACES

- Clean control panel with lightly dampened cloth. Dry thoroughly.  
**DO NOT** use abrasives or sharp objects—they could damage the control panel.
- Clean outside cabinet finish with a good appliance polish wax. **DO NOT** use scouring pads, harsh or gritty cleaners.
- Interior is self-cleaning with normal use. If it should ever need cleaning, use a mild cleansing powder. If hard water causes lime build-up, clean as follows:
  - Pour 2 cups white vinegar into empty dishwasher. **DO NOT** use detergent.
  - Operate machine on **NORMAL WASH** cycle.

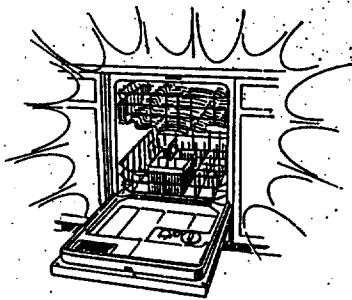

### CARE OF AIR GAP

If an air gap was installed for your built-in dishwasher, check to make sure it is clean. Air gaps are usually mounted on the countertop and can be inspected by removing the cover. The air gap is not part of your dishwasher and is not covered by Sears warranty.

Drain air gap

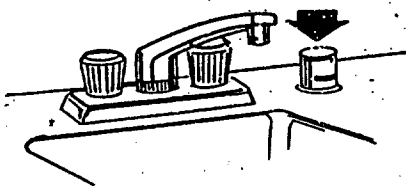

### PROTECTION AGAINST FREEZING

If dishwasher is left in an unheated place during the winter:

- Shut off water and electrical power.
- Remove access panel.
- Disconnect water lines from valve. Drain into a flat pan.
- Drain collection chamber at rear of unit below filter by disconnecting hose to pump.
- Remove plastic pump cover in tub bottom and use sponge to soak up any remaining water.
- Reconnect water lines to valve and hoses to pump.

Pump cover screws

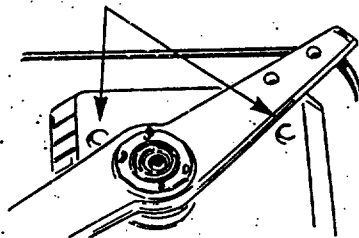

### PREPARATION FOR MOVING

- Disconnect electrical power.
- Turn off water supply, disconnect water and drain lines.
- Tape racks in place; close door securely and tape it shut.
- Wrap with blankets and, if using a hand truck, lift dishwasher from side in upright position only.

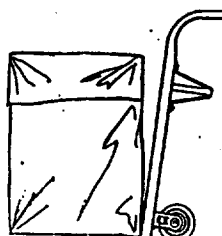

## COLOR PANELS

### OPTIONAL ACCESSORIES

You can change the door and lower access panel appearance of your dishwasher by ordering one of these optional accessories:

- Color Panels
- 1/4" Wood Panel Trim Kit

These accessories are available from:

Dri-View Manufacturing  
4706 Allmond Avenue  
Louisville, KY 40209

Specify accessory number when ordering.

### DESCRIPTIONS OF OPTIONAL ACCESSORIES

**Color Panels**— Replacement door and lower access panels are available in the following colors:

- GPF400A (Almond)
- GPF400B (Black)
- GPF400W (White)

**Wood Panel Trim Kit**—This accessory contains trim and instructions for you to simply and install a 1/4" thick decorative wood door and lower access panel:

- 22-16071 (White)
- 22-16075 (Black)
- 22-16078 (Almond)

**NOTE:** The 22-16072 dishwasher door spring kit must also be ordered and installed when the door panel weighs four lbs. or more:

## COMMON DISHWASHING PROBLEMS AND SOLUTIONS

PROBLEM	CAUSED BY	SOLUTION
Dishwasher will not start	<ul style="list-style-type: none"> <li>•Dishwasher not receiving electricity</li> <li>•Dial not in correct position for cycle selected</li> <li>•Turning the Dial too far</li> </ul>	<ul style="list-style-type: none"> <li>•Check house fuse or circuit breaker.</li> <li>•Make sure Dial is turned far enough and cycle button is fully pushed in.</li> <li>•Be careful you do not turn the Dial any farther than necessary. There is a delay between start-up and water fill so you will not hear any wash action right away.</li> </ul>
Dishwasher will not fill with water	<ul style="list-style-type: none"> <li>•Turning the Dial too far</li> <li>•No water supply</li> <li>•Water inlet valve clogged</li> </ul>	<ul style="list-style-type: none"> <li>•See the solution above.</li> <li>•Make sure water supply valve under sink is turned on.</li> <li>•Water valve supply line may be clogged with sediment. Clean out.</li> </ul>
Unusual noise	<ul style="list-style-type: none"> <li>•Improper loading</li> </ul>	<ul style="list-style-type: none"> <li>•Utensils may not be secure on rack pins, or something small may have dropped from the rack. Water is causing utensils to rattle. Make sure everything is securely placed in dishwasher.</li> </ul>
Dishwasher leaks	<ul style="list-style-type: none"> <li>•Dishwasher not level</li> <li>•Top mech sudsing</li> <li>•Spilled rinse agent</li> <li>•Dishwasher door interferes with surrounding cabinets</li> </ul>	<ul style="list-style-type: none"> <li>•Level dishwasher as described in Installation Instructions. Don't place dishwasher on carpet.</li> <li>•Improper detergent. <b>Use automatic dishwasher detergent only or try a different brand or less detergent.</b></li> <li>•If hand dishwashing detergent is used by mistake, pour one measuring cup of vegetable oil in bottom of tub and run dishwasher through a complete NORMAL WASH cycle with recommended amount of automatic dishwashing detergent.</li> <li>•<b>To remove suds from tub:</b> Open dishwasher. Let suds evaporate. Add 1 gallon of cold water to tub. Close and latch dishwasher. Pump out water by slowly turning Dial until a drain period is reached. Repeat if necessary.</li> <li>•Spilled rinse agent can cause foam during washing. This can lead to overflowing. Wipe up accidental spill of rinse agent with a damp cloth.</li> <li>•Make sure door does not touch cabinets when opening or closing. Use levelling legs to level dishwasher.</li> </ul>

PROBLEM	CAUSED BY	SOLUTION
Dishes not dry	<ul style="list-style-type: none"> <li>• Water is not hot</li> <li>• COOL DRY option selected</li> <li>• Improper loading</li> <li>• Rinse agent dispenser empty</li> </ul>	<ul style="list-style-type: none"> <li>• Raise water heater thermostat to 140°F if necessary.</li> <li>• Do not select COOL DRY option. Allow dishes to dry in heated air.</li> <li>• Load dishes so items drain properly. Avoid overloading.</li> <li>• Fill rinse agent dispenser if empty.</li> </ul>
Spotting and filming	<ul style="list-style-type: none"> <li>• Hard water</li> <li>• Water is not hot</li> <li>• COOL DRY option selected</li> <li>• Not enough or poor quality detergent</li> <li>• Old detergent</li> <li>• No rinse agent</li> </ul>	<ul style="list-style-type: none"> <li>• Fill detergent cups to capacity. Use dishwasher detergent with highest available phosphorous content. May be necessary to install a water softener.</li> <li>• Raise water heater thermostat to 140°F.</li> <li>• Drying without heat may cause some spotting. Do not select COOL DRY option.</li> <li>• Use more fresh automatic dishwasher detergent. Use detergent with highest available phosphorous content, especially if you have hard water.</li> <li>• Use only fresh, automatic dishwasher detergent. Store tightly closed in a cool, dry place. Discard old, lumpy or separated detergent. Do not fill detergent dispenser until ready to wash.</li> <li>• Fill rinse agent dispenser.</li> </ul> <p><b>To remove stubborn spots and film from glassware:</b></p> <ol style="list-style-type: none"> <li>1. Remove all metal utensils from the dishwasher.</li> <li>2. Do not add detergent.</li> <li>3. Select HEAVY WASH cycle.</li> <li>4. Start the dishwasher and allow to run for 18 to 20 minutes. The dishwasher will now be in the main wash.</li> <li>5. Then open the door and pour 2 cups (500 ml) white vinegar into bottom of dishwasher.</li> <li>6. Close the door and allow to complete the cycle.</li> </ol> <p><b>If vinegar rinse doesn't work:</b> Repeat as above, except use 1/4 cup (60 ml) of citric acid crystals instead of vinegar. (Most drugstores carry citric acid crystals.)</p>

MAINTENANCE

<b>PROBLEM</b>	<b>CAUSED BY</b>	<b>SOLUTION</b>
Etching—permanent filming which cannot be removed	<ul style="list-style-type: none"> <li>• Too much detergent in soft water.</li> <li>• Improper loading</li> </ul>	<ul style="list-style-type: none"> <li>• Reduce amount of dishwasher detergent. Use detergent with lower phosphorous content.</li> <li>• Make sure dishes and glassware are loaded properly to permit water spray to rinse all surfaces. Do not overload.</li> </ul>
Water left in bottom of tub	<ul style="list-style-type: none"> <li>• Normal amount of water</li> </ul>	<ul style="list-style-type: none"> <li>• It is normal for a small amount of clean water to remain in bottom of tub after each cycle.</li> <li>• Clean the drain air gap. See User Maintenance Instructions.</li> </ul>
Dishes and interior of dishwasher brown or yellow	<ul style="list-style-type: none"> <li>• Iron or manganese in water</li> </ul>	<ul style="list-style-type: none"> <li>• Install an iron or manganese filter in home water supply.</li> </ul>
Film build-up on lower front of tub	<ul style="list-style-type: none"> <li>• Some detergent did not dissolve</li> </ul>	<ul style="list-style-type: none"> <li>• Use fresh, automatic dishwasher detergent. Use detergent with highest available phosphorous content, especially if you have hard water. Raise water heater thermostat to 140°F if necessary. Run water at sink until hot before starting dishwasher. Remove film with dishwashing detergent and warm water.</li> </ul>
Silverware stained	<ul style="list-style-type: none"> <li>• Undissolved detergent contacting wet silverware</li> <li>• Acidic or salty food soils</li> </ul>	<ul style="list-style-type: none"> <li>• Avoid spilling dry detergent on wet silverware. Clean with silver polish.</li> <li>• Use RINSE &amp; HOLD cycle. Certain foods left on silverware for extended periods of time may cause pitting.</li> </ul>
Bronze tarnish on silver plate	<ul style="list-style-type: none"> <li>• Silver plate worn off exposing base metal—takes on bronze hue</li> </ul>	<ul style="list-style-type: none"> <li>• Remove tarnish with silver polish.</li> </ul>
Black or gray marks on dish	<ul style="list-style-type: none"> <li>• Metal utensils rubbing against dishes during wash</li> </ul>	<ul style="list-style-type: none"> <li>• Load metal utensils so they do not rub against dishes. Marks may be removed with mild abrasive cleanser and plastic scouring pad.</li> </ul>
Dishware chipped or broken	<ul style="list-style-type: none"> <li>• Improper loading</li> </ul>	<ul style="list-style-type: none"> <li>• Do not overload. Load glasses in upper rack only. See Loading section for tips.</li> </ul>
Dishwasher odor	<ul style="list-style-type: none"> <li>• Soiled dishes held too long in dishwasher</li> <li>• Vinyl rack coating</li> </ul>	<ul style="list-style-type: none"> <li>• Use RINSE &amp; HOLD cycle if dishes will not be washed at end of day.</li> <li>• Plastic odor will be gone after several weeks use.</li> </ul>



<b>PROBLEM</b>	<b>CAUSED BY</b>	<b>SOLUTION</b>
Motor hums	<ul style="list-style-type: none"> <li>•Dishwasher has not been used on a regular basis</li> </ul>	<ul style="list-style-type: none"> <li>•If you do not use your dishwasher often, set it to fill and pump out once every week.</li> <li>•This will help keep the seal moist and the garbage disposer clear.</li> </ul>
Staining of tub interior	<ul style="list-style-type: none"> <li>•Some detergents contain colorant (pigment or dyes)</li> <li>•Some tomato-based foods can stain</li> </ul>	<ul style="list-style-type: none"> <li>•This will discolor the tub interior with extended use. Check the detergent dispenser for signs of any discoloration. If dispenser is discolored, change to detergent without any colorant.</li> <li>•Using the RINSE &amp; HOLD cycle after adding dish to the load can decrease the level of staining.</li> </ul>
Vapor at the vent	<ul style="list-style-type: none"> <li>•Water vapor comes through the vent by the door latch during drying and when water is being pumped out</li> </ul>	<ul style="list-style-type: none"> <li>•This is a normal occurrence.</li> </ul>
Detergent cup lid won't latch after adding detergent	<ul style="list-style-type: none"> <li>•Dial not in OFF position</li> </ul>	<ul style="list-style-type: none"> <li>•Dial must be in OFF position for cup lid to close and latch properly. If you unlatch the door and open it to dry your dishes, the Dial does not advance to OFF by itself.</li> </ul>

## NOTES

**NOTES.**

For the repair or replacement parts you need  
delivered directly to your home  
Call 7 am – 7 pm, 7 days a week

**1-800-366-PART**  
(1-800-366-7278)

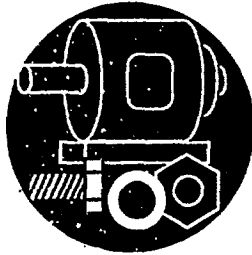

For in-home major brand repair service  
Call 24 hours a day, 7 days a week

**1-800-4-MY-HOME<sup>SM</sup>**  
(1-800-469-4663)



For the location of a  
Sears Parts and Repair Center in your area  
Call 24 hours a day, 7 days a week

**1-800-488-1222**



For information on purchasing a Sears  
Maintenance Agreement or to inquire  
about an existing Agreement  
call 9 am – 5 pm, Monday–Saturday

**1-800-827-6655**



When requesting service or ordering  
parts, always provide the following  
information:

- Product Type
- Model Number
- Part Number
- Part Description

**SEARS**  
**REPAIR SERVICES**  
*America's Repair Specialists*

## Free Manuals Download Website

<http://myh66.com>

<http://usermanuals.us>

<http://www.somanuals.com>

<http://www.4manuals.cc>

<http://www.manual-lib.com>

<http://www.404manual.com>

<http://www.luxmanual.com>

<http://aubethermostatmanual.com>

Golf course search by state

<http://golfingnear.com>

Email search by domain

<http://emailbydomain.com>

Auto manuals search

<http://auto.somanuals.com>

TV manuals search

<http://tv.somanuals.com>