



Self-Cleaning Electric Range

Use & Care Guide

Cocina eléctrica con autolimpieza

Manual de uso y cuidado

Models, Modelos 665.95012 665.95014 665.95002 665.95004
 665.92012 665.92014 665.92002 665.92004

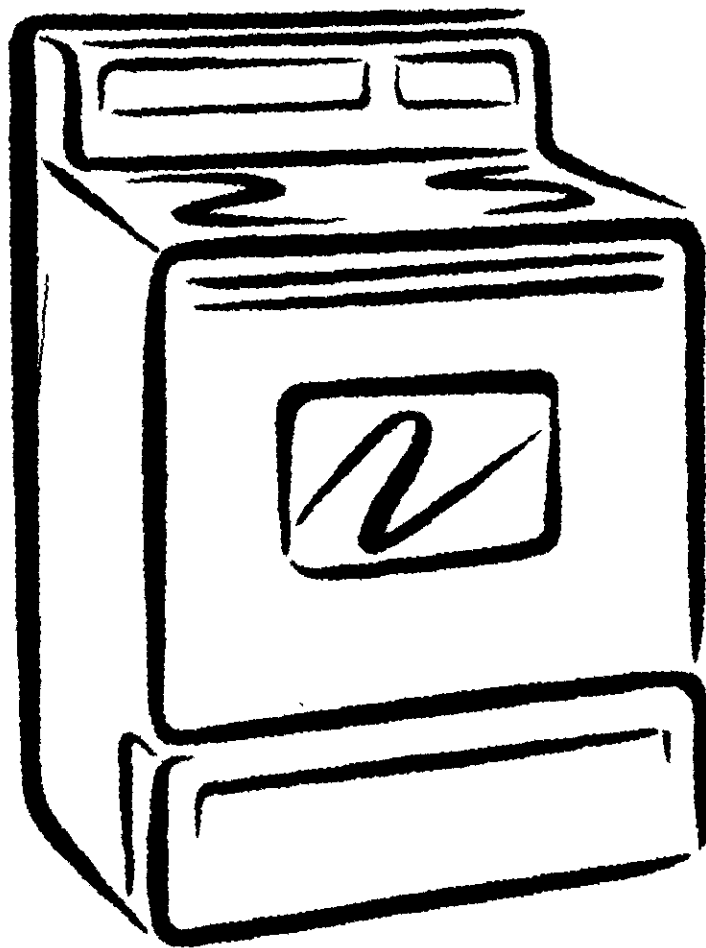

ENGLISH ESPAÑOL

Super Capacity with ULTRABAKE™ System
Capacidad extra con el Sistema ULTRABAKE™

TABLE OF CONTENTS

WE SERVICE WHAT WE SELL	3
WARRANTY	3
RANGE SAFETY	4
The Anti-Tip Bracket.....	4
PARTS AND FEATURES	7
COOKTOP USE	8
Control Knobs	8
Radiant Glass	8
Dual Cooking Zone.....	9
SURESIMMER™	10
Home Canning.....	10
Cookware	10
ELECTRONIC OVEN CONTROL	11
Display	11
Start/Enter	11
Off/Cancel.....	11
Clock.....	11
Tones	11
Fahrenheit and Celsius.....	12
Timer	12
Oven Lockout	12
Oven Temperature Control.....	12
OVEN USE	13
Aluminum Foil	13
Positioning Racks and Bakeware	13
STURDIGLIDE™ Oven Racks	13
Bakeware.....	14
Oven Vent	14
Baking and Roasting	14
Broiling.....	15
Timed Oven Control	16
12-Hour Shut-Off.....	16
RANGE CARE	17
Self-Cleaning Cycle.....	17
General Cleaning	18
Oven Light	19
Oven Door	20
Storage Drawer.....	20
TROUBLESHOOTING	21

WE SERVICE WHAT WE SELL

Your purchase has added value because you can depend on Sears Home Central® for service. With over 12,000 trained repair specialists and access to over 4.2 million parts and accessories, we have the tools, parts, knowledge and skills to ensure our pledge: We Service What We Sell.

Sears Maintenance Agreements

Your Kenmore appliance is designed, manufactured and tested to provide years of dependable operation. Yet any major appliance may require service from time to time. The Sears Maintenance Agreement offers you an outstanding service program, affordably priced.

The Sears Maintenance Agreement

- Is your way to buy tomorrow's service at today's price.
- Eliminates repair bills resulting from normal wear and tear.
- Provides for non-technical and instructional assistance.
- Even if you don't need repairs, provides an annual Preventive Maintenance Check, at your request, to ensure that your appliance is in proper running condition.

Some limitations apply. For more information, call 1-800-827-6655.

WARRANTY

FULL ONE-YEAR WARRANTY ON ALL PARTS

For one year from the date of purchase, when this range is installed and operated according to instructions provided in the Installation Instructions and Use & Care Guide, Sears will repair this range, free of charge, if defective in material or workmanship.

LIMITED FIVE-YEAR WARRANTY ON RADIANT GLASS COOKTOP AND COOKTOP COOKING ELEMENTS

After the first year and until five years from the date of purchase, when the range is installed and operated in accordance with the instructions provided in the Installation Instructions and Use & Care Guide, Sears will repair or replace parts for the radiant glass cooktop as listed below due to defective materials or workmanship. Customer assumes any labor costs.

- Cracking of the radiant glass cooktop due to thermal shock
- Wear-off of the pattern on the radiant glass cooktop
- Cracking of the rubber seal between the radiant glass cooktop and the porcelain edge
- Burn-out of any of the radiant glass cooktop cooking elements

WARRANTY RESTRICTION

If the range is subject to other than private family use, the above warranty coverage is effective for only 90 days.

WARRANTY SERVICE

WARRANTY SERVICE IS AVAILABLE BY CONTACTING THE NEAREST SEARS SERVICE CENTER IN THE UNITED STATES. This warranty applies only while the product is in use in the United States. This warranty gives you specific legal rights and you may also have other rights which vary from state to state.

For Sears warranty information in the United States call 1-800-469-4663.

Sears, Roebuck and Co.
D/817WA, Hoffman Estates, IL 60179

PRODUCT RECORD

In the space below, record your complete model number, serial number, and purchase date. You can find this information on the model and serial number label, located as shown in the Parts and Features section of this book. Have this information available to help you quickly obtain assistance or service when you contact Sears concerning your appliance.

Model number 665

Serial number _____

Purchase date _____

Save these instructions and your sales receipt for future reference.

RANGE SAFETY

Your safety and the safety of others are very important.

We have provided many important safety messages in this manual and on your appliance. Always read and obey all safety messages.



This is the safety alert symbol.

This symbol alerts you to potential hazards that can kill or hurt you and others.

All safety messages will follow the safety alert symbol and either the word "DANGER" or "WARNING." These words mean:

⚠ DANGER

You can be killed or seriously injured if you don't immediately follow instructions.

⚠ WARNING

You can be killed or seriously injured if you don't follow instructions.

All safety messages will tell you what the potential hazard is, tell you how to reduce the chance of injury, and tell you what can happen if the instructions are not followed.

The Anti-Tip Bracket

The range will not tip during normal use. However, the range can tip if you apply too much force or weight to the open door without the anti-tip bracket fastened down properly.



⚠ WARNING

Tip Over Hazard

A child or adult can tip the range and be killed.

Connect anti-tip bracket to rear range foot.

Reconnect the anti-tip bracket, if the range is moved.

See the installation instructions for details.

Failure to follow these instructions can result in death or serious burns to children and adults.

Anti-Tip Bracket

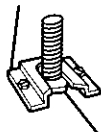

Range Foot

Making sure the anti-tip bracket is installed:

- Slide range forward.
- Look for the anti-tip bracket securely attached to floor.
- Slide range back so rear range foot is under anti-tip bracket.

IMPORTANT SAFETY INSTRUCTIONS

WARNING: To reduce the risk of fire, electrical shock, injury to persons, or damage when using the range, follow basic precautions, including the following:

- **WARNING:** TO REDUCE THE RISK OF TIPPING OF THE RANGE, THE RANGE MUST BE SECURED BY PROPERLY INSTALLED ANTI-TIP DEVICES. TO CHECK IF THE DEVICES ARE INSTALLED PROPERLY, SLIDE RANGE FORWARD, LOOK FOR ANTI-TIP BRACKET SECURELY ATTACHED TO FLOOR, AND SLIDE RANGE BACK SO REAR RANGE FOOT IS UNDER ANTI-TIP BRACKET.
- **CAUTION:** Do not store items of interest to children in cabinets above a range or on the back-guard of a range – children climbing on the range to reach items could be seriously injured.
- Proper Installation – Be sure the range is properly installed and grounded by a qualified technician.
- Never Use the Range for Warming or Heating the Room.
- Do Not Leave Children Alone – Children should not be left alone or unattended in area where the range is in use. They should never be allowed to sit or stand on any part of the range.
- Wear Proper Apparel – Loose-fitting or hanging garments should never be worn while using the range.
- User Servicing – Do not repair or replace any part of the range unless specifically recommended in the manual. All other servicing should be referred to a qualified technician.
- Storage in or on the Range – Flammable materials should not be stored in an oven or near surface units.
- Do Not Use Water on Grease Fires – Smother fire or flame or use dry chemical or foam-type extinguisher.
- Use Only Dry Potholders – Moist or damp potholders on hot surfaces may result in burns from steam. Do not let potholder touch hot heating elements. Do not use a towel or other bulky cloth.
- DO NOT TOUCH SURFACE UNITS OR AREAS NEAR UNITS – Surface units may be hot even though they are dark in color. Areas near surface units may become hot enough to cause burns. During and after use, do not touch, or let clothing or other flammable materials contact surface units or areas near units until they have had sufficient time to cool. Among those areas are the cooktop and surfaces facing the cooktop.
- Use Proper Pan Size – The range is equipped with one or more surface units of different size. Select utensils having flat bottoms large enough to cover the surface unit heating element. The use of under-sized utensils will expose a portion of the heating element to direct contact and may result in ignition of clothing. Proper relationship of utensil to burner will also improve efficiency.
- Never Leave Surface Units Unattended at High Heat Settings – Boilover causes smoking and greasy spillovers that may ignite.
- Make Sure Reflector Pans or Drip Bowls Are in Place – Absence of these pans or bowls during cooking may subject wiring or components underneath to damage.
- Protective Liners – Do not use aluminum foil to line surface unit drip bowls or oven bottoms, except as suggested in the manual. Improper installation of these liners may result in a risk of electric shock, or fire.
- Glazed Cooking Utensils – Only certain types of glass, glass/ceramic, ceramic, earthenware, or other glazed utensils are suitable for range-top service without breaking due to the sudden change in temperature.
- Utensil Handles Should Be Turned Inward and Not Extend Over Adjacent Surface Units – To reduce the risk of burns, ignition of flammable materials, and spillage due to unintentional contact with the utensil, the handle of a utensil should be positioned so that it is turned inward, and does not extend over adjacent surface units.
- Do Not Soak Removable Heating Elements – Heating elements should never be immersed in water.
- Do Not Cook on Broken Cooktop – If cooktop should break, cleaning solutions and spillovers may penetrate the broken cooktop and create a risk of electric shock. Contact a qualified technician immediately.
- Clean Cooktop With Caution – If a wet sponge or cloth is used to wipe spills on a hot cooking area, be careful to avoid steam burn. Some cleaners can produce noxious fumes if applied to a hot surface.
- Use Care When Opening Door – Let hot air or steam escape before removing or replacing food.
- Do Not Heat Unopened Food Containers – Build-up of pressure may cause container to burst and result in injury.

SAVE THESE INSTRUCTIONS

IMPORTANT SAFETY INSTRUCTIONS

- Keep Oven Vent Ducts Unobstructed.
- Placement of Oven Racks – Always place oven racks in desired location while oven is cool. If rack must be moved while oven is hot, do not let potholder contact hot heating element in oven.
- DO NOT TOUCH HEATING ELEMENTS OR INTERIOR SURFACES OF OVEN – Heating elements may be hot even though they are dark in color. Interior surfaces of an oven become hot enough to cause burns. During and after use, do not touch, or let clothing or other flammable materials contact heating elements or interior surfaces of oven until they have had sufficient time to cool. Other surfaces of the appliance may become hot enough to cause burns – among these surfaces are oven vent openings and surfaces near these openings, oven doors, and windows of oven doors.

For self-cleaning ranges –

- Do Not Clean Door Gasket – The door gasket is essential for a good seal. Care should be taken not to rub, damage, or move the gasket.
- Do Not Use Oven Cleaners – No commercial oven cleaner or oven liner protective coating of any kind should be used in or around any part of the oven.
- Clean Only Parts Listed in Manual.
- Before Self-Cleaning the Oven – Remove broiler pan and other utensils.

For units with ventilating hood –

- Clean Ventilating Hoods Frequently – Grease should not be allowed to accumulate on hood or filter.
- When flaming foods under the hood, turn the fan on.

SAVE THESE INSTRUCTIONS

The California Safe Drinking Water and Toxic Enforcement Act requires the Governor of California to publish a list of substances known to the State of California to cause cancer, birth defects, or other reproductive harm, and requires businesses to warn of potential exposure to such substances.

WARNING: This product contains a chemical known to the State of California to cause cancer, birth defects, or other reproductive harm.

This appliance can cause low-level exposure to some of the substances listed, including benzene, formaldehyde, carbon monoxide, and toluene.

PARTS AND FEATURES

This manual covers several different models. The range you have purchased may have some or all of the items listed. The locations and appearances of the features shown here may not match your model.

Control Panel

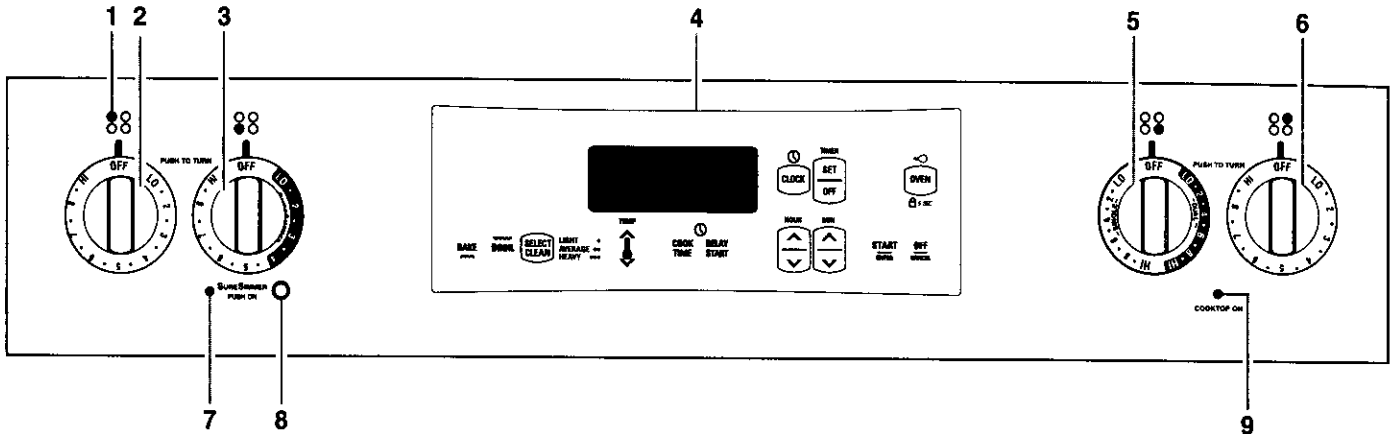

- 1. EASYGLANCE™ Hot Surface Indicator Light
- 2. Left Rear Control
- 3. Left Front Control (SURESIMMER™ on some models)

- 4. Electronic Oven Control
- 5. Right Front Control (Dual Cooking Zone on some models)

- 6. Right Rear Control
- 7. SURESIMMER Indicator Light (on some models)

- 8. SURESIMMER Button (on some models)
- 9. Cooktop On Indicator Light

Range

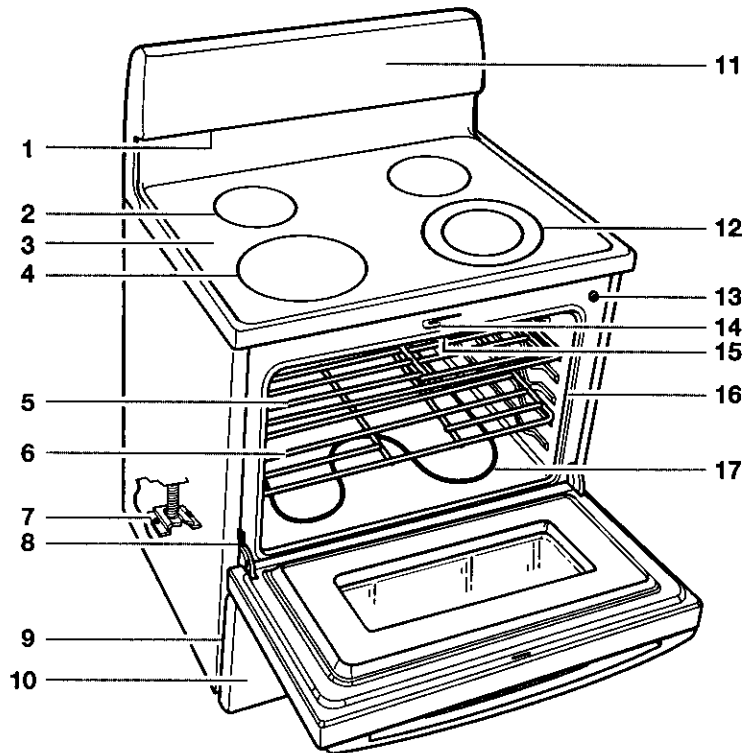

- 1. Oven Vent
- 2. Surface Cooking Area
- 3. Radiant Glass Cooktop
- 4. SURESIMMER Cooking Zone (on some models)
- 5. STURDIGLIDE™ Half-Rack with removable insert (on some models)

- 6. STURDIGLIDE™ Oven Rack with integrated handle (on some models)
- 7. Anti-Tip Bracket
- 8. Door Stop Clip
- 9. Model and Serial Number Plate (behind left side of storage drawer)

- 10. Storage Drawer
- 11. Control Panel
- 12. Dual Cooking Zone (on some models)
- 13. Automatic Oven Light Switch

- 14. Self-Clean Latch
- 15. Broil Element (not shown)
- 16. Gasket
- 17. Bake Element

COOKTOP USE

Control Knobs

! WARNING



Fire Hazard

**Turn off all controls when done cooking.
Failure to do so can result in death or fire.**

The control knobs can be set anywhere between HI and OFF. Push in and turn to setting. The surface cooking area locator shows which element is turned on. Use the following chart as a guide when setting heat levels.

SETTING	RECOMMENDED USE
HI	<ul style="list-style-type: none">Start food cooking.Bring liquid to a boil.
6-8 [MED- HI]	<ul style="list-style-type: none">Hold a rapid boil.Quickly brown or sear food.
5 [MED]	<ul style="list-style-type: none">Maintain a slow boil.Fry or sauté foods.Cook soups, sauces and gravies.
2-4 [MED- LO]	<ul style="list-style-type: none">Stew or steam food.Simmer.
LO	<ul style="list-style-type: none">Keep food warm.
SURESIMMER™	
LO	<ul style="list-style-type: none">For a low simmer or when using lids.Melt chocolate or butter.
4	<ul style="list-style-type: none">For a high simmer or when simmering without lids.

REMEMBER: When range is in use or during the Self-Cleaning cycle, the entire cooktop area may become hot.

Radiant Glass

The surface cooking area will glow red when an element is on. It will cycle on and off, at all settings, to maintain the selected heat level.

Wiping off the cooktop before and after each use will help keep it free from stains and provide the most even heating. For more information, see "General Cleaning" section.

- Do not store jars or cans above the cooktop. Dropping a heavy or hard object on the cooktop could crack it.
- Do not leave a hot lid on the cooktop. As the cooktop cools, air can become trapped between the lid and the cooktop, and the ceramic glass could break when the lid is removed.
- Clean up sugary spills and soils as soon as hot surface indicator light goes off. If not wiped up while warm, surface pitting can occur.
- Lift pots and pans on and off the cooktop. Sliding pots, pans and skillets that have aluminum or copper bases could leave permanent scratches and marks on the cooktop.
- Do not cook popcorn in prepackaged aluminum containers on the cooktop. It could leave aluminum marks that cannot be removed completely.
- Do not allow objects that could melt, like plastic or aluminum foil, to touch any part of the entire cooktop.
- Do not use the cooktop as a cutting board.
- Use cookware about the same size as the surface cooking area. Cookware should not extend more than 1 in. (2.5 cm) outside the area.

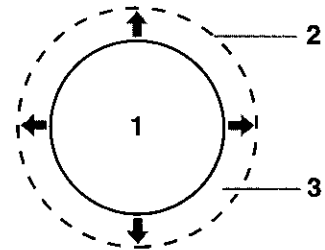

1. Surface Cooking Area
2. Cookware/Canner
3. 1" (2.5 cm) Maximum Overhang

- Use flat-bottomed cookware for best heat conduction and energy efficiency. Cookware with rounded, warped, ribbed or dented bottoms could cause uneven heating and poor cooking results.
- Determine flatness by placing the straight edge of a ruler across the bottom of the cookware. While rotating the ruler, no space or light should be visible between it and the cookware.
- Cookware designed with slightly indented bottoms or small expansion channels can be used.
- Make sure the bottoms of pots and pans are clean and dry before using them. Residue and water can leave deposits when heated.
- Do not cook foods directly on the cooktop.

EASYGLANCE™ Hot Surface Indicator Light

The Hot Surface Indicator light is located above each control knob. Unlike the COOKTOP ON Light, the Easy Glance hot surface indicator light will glow as long as that surface cooking area is too hot to touch, even after the surface cooking area(s) is turned off.

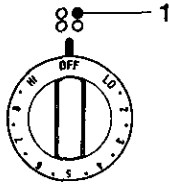

1. EASYGLANCE Hot Surface Indicator Light

COOKTOP ON Light

The COOKTOP ON indicator light is located on the right side of the control panel. The light will glow when any surface control knob is turned on.

The indicator light will go off when all control knobs have been turned off, even when one or more surface cooking areas are still hot.

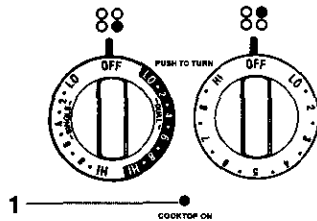

1. COOKTOP ON light

Dual Cooking Zone

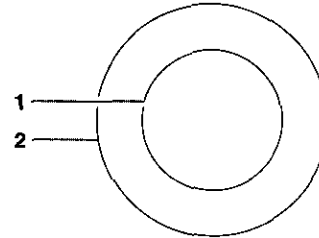

1. Single size (6 in. [15.24 cm])
2. Dual size (10 in. [25.4 cm])

The Dual Cooking Zone offers flexibility depending on the size of the cookware. Single size can be used in the same way as a regular element. The dual size combines both the single and outer element and is recommended for larger size cookware.

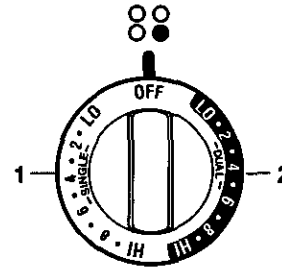

1. Single
2. Dual

To Use SINGLE :

1. Push in and turn the right front control knob clockwise from the OFF position to the SINGLE zone anywhere between HI and LO.
2. Push in and turn knob to OFF when finished.

To Use DUAL :

1. Push in and turn the right front control knob counterclockwise from the OFF position to the DUAL zone anywhere between HI and LO.
2. Push in and turn knob to OFF when finished.

SURESIMMER™

The SURESIMMER feature is an adjustable heat setting for more precise simmering. It is the left front surface cooking area or element. When the SURESIMMER feature is not on, the left front surface cooking area or element will function as usual.

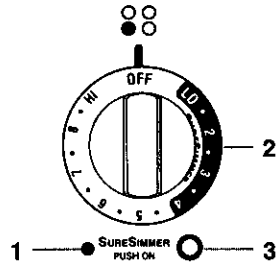

1. Indicator Light
2. SURESIMMER Setting
3. On/Off Button

To Use:

1. Push the SURESIMMER button to ON.
The light will glow when SURESIMMER is on.
2. Turn and set the left front knob to the SURESIMMER setting between **LO** and **4**. Do not turn past 4.

Home Canning

When canning for long periods, alternate the use of surface cooking areas, elements or surface burners between batches. This allows time for the most recently used areas to cool.

- Center the canner on the grate or largest surface cooking area or element. Canners should not extend more than 1 in. (2.5 cm) outside the cooking area.
- Do not place canner on two surface cooking areas, elements or surface burners at the same time.
- On ceramic glass models, only use flat-bottomed canners.
- On coil element models, the installation of a Canning Unit Kit is recommended. If not installed, the life of the coil element will be shortened. See back cover for ordering instructions.
- For more information, contact your local U.S. Government Agricultural Department Extension Office. Companies who manufacture home canning products can also offer assistance.

Cookware

IMPORTANT: Never leave empty cookware on a hot surface cooking area, element or surface burner.

Ideal cookware should have a flat bottom, straight sides, a well-fitting lid and the material should be of medium-to-heavy thickness.

Cookware material is a factor in how quickly and evenly heat is transferred, which affects cooking results. A non-stick finish has the same characteristics as its base material. For example, aluminum cookware with a non-stick finish will take on the properties of aluminum.

Use the following chart as a guide for cookware material characteristics.

COOKWARE	CHARACTERISTICS
*Aluminum	<ul style="list-style-type: none"> ■ Heats quickly and evenly. ■ Suitable for all types of cooking. ■ Medium or heavy thickness is best for most cooking tasks.
Cast iron	<ul style="list-style-type: none"> ■ Heats slowly and evenly. ■ Good for browning and frying. ■ Maintains heat for slow cooking. ■ Rough surfaces may scratch cooktop.
Ceramic or Ceramic glass	<ul style="list-style-type: none"> ■ Follow manufacturer's instructions. ■ Rough surfaces may scratch cooktop. ■ Heats slowly, but unevenly. ■ Ideal results on low to medium heat settings.
*Copper	<ul style="list-style-type: none"> ■ Heats very quickly and evenly.
Earthenware	<ul style="list-style-type: none"> ■ Follow manufacturer's instructions. ■ Use on low heat settings.
Porcelain enamel-on-steel or cast iron	<ul style="list-style-type: none"> ■ See stainless steel or cast iron.
Stainless steel	<ul style="list-style-type: none"> ■ Heats quickly, but unevenly. ■ A core or base of aluminum or copper on stainless steel provides even heating.

*Aluminum and copper may be used as a core or base in cookware. When used as a base it can leave permanent marks on the cooktop or grates.

ELECTRONIC OVEN CONTROL

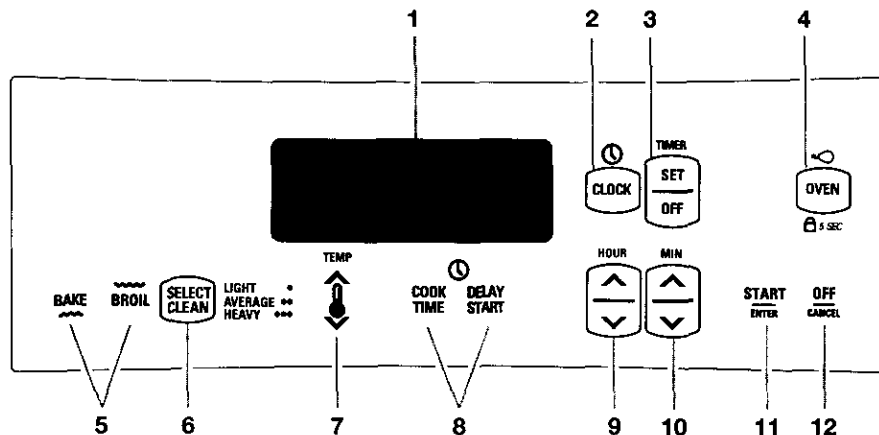

- | | | |
|----------------------------|---|-----------------|
| 1. Display | 5. Oven Selectors | 9. HOUR |
| 2. CLOCK | 6. SELECT CLEAN™ Self-Clean
(on some models) | 10. MINUTE |
| 3. TIMER | 7. Temperature Setting | 11. START/ENTER |
| 4. Oven Light/Oven Lockout | 8. Timed Cooking | 12. OFF/CANCEL |

Display

When power is first supplied to the appliance, everything on the display will light up for 5 seconds. Then the time of day and "PF" will appear on the display.

Any other time "PF" appears, a power failure occurred. To remove "PF" and to reset the clock, press OFF/CANCEL.

When the oven is in use, this display shows time, temperature and what command pads have been pressed.

When the oven is not in use, the display will show the time of day.

Start/Enter

The START/ENTER pad begins any oven function except the Timer. If not pressed within 5 seconds after pressing a pad, "START?" will appear on the display as a reminder. If not pressed within 5 minutes after pressing a pad, the display will show the time of day and the programmed function will be cancelled.

Off/Cancel

The OFF/CANCEL pad stops any oven function except for the Clock, Timer and Cooktop or Oven Lockouts.

After pressing OFF/CANCEL, the display will show the time of day or, if the minute timer is also being used, the time remaining.

Clock

This is a 12 hour clock and does not show a.m. or p.m.

To Set:

1. Press CLOCK.
2. Press the HOUR/MIN "up" or "down" arrow pads until the correct time of day shows on the display.
3. Press CLOCK or START/ENTER.

Tones

Tones are audible signals, indicating the following:

One tone

- Valid pad press
- Oven is preheated
- Function has been entered

Three tones

- Invalid pad press

Four tones

- End-of-cycle
- Reminder, repeating each minute after the end-of-cycle tones

Error Tones

Error tones indicate a problem with the electronic oven control. An error code will appear in the display.

Tone Volume

The volume can be adjusted between high and low.

To Change: Press and hold DELAY START for 5 seconds. A short tone will sound and either "Snd HI" or "Snd Lo" will appear on the display. Press and hold DELAY START again for 5 seconds to change to desired setting.

To remove "Snd on", "Snd OFF", "rEP on", "Snd HI" or "Snd Lo" press any pad, and the time of day will appear on the display.

Reminder Tones

Reminder tones are four 1-second tones which indicate that the set time has expired for a timer or a timed oven control function.

Timer

To Turn Tones Off/On: Press and hold SET/OFF for 5 seconds. A short tone will sound and "rEP OFF" will appear on the display. Repeat to turn back on.

Timed Cooking

To Turn Tones Off/On: Press and hold COOK TIME. A short tone will sound and "Snd OFF" will appear on the display. Repeat to turn back on.

Fahrenheit and Celsius

The temperature is preset at Fahrenheit, but can be changed to Celsius.

To Change: Press and hold BROIL for 5 seconds. A short tone will sound and the temperatures displayed will switch to "C". Repeat to change back to Fahrenheit.

Timer

The Timer can be set in minutes and seconds or hours and minutes and counts down the set time. The Timer does not start or stop the oven.

To Set:

1. Press TIMER SET.
 2. Press the HOUR/MIN "up" or "down" arrow pads until the correct length of time shows on the display.
 3. Press START/ENTER or TIMER SET.
The Timer will begin counting down after the Timer is started. The display will count down in hours and minutes if remaining time is one hour or more, and in minutes and seconds if remaining time is less than one hour.
When the set time ends four 1-second tones, if enabled, will sound, then reminder tones will sound every minute.
 4. Press TIMER OFF anytime to cancel the Timer and/or stop reminder tones.
-

Oven Lockout

The Oven Lockout prevents unintended use of the control panel command keypads. The oven can only be locked out when the oven is not in use or the oven control has not been set.

The oven will remain locked out after a power failure if it was locked before the power failure.

To Lock/Unlock Oven:

Press and hold OVEN for 5 seconds. A single tone will sound and "Loc on" will appear on the display. After 5 seconds, "Loc on" will disappear from the display, and "Loc" and a picture of a lock will appear.

Three tones will sound when the oven is locked and any command pad other than CLOCK, TIMER, START/ENTER, OFF/CANCEL or OVEN has been pressed.

To unlock oven, press and hold OVEN for 5 seconds. "Loc OFF" will appear on the display and a picture of a lock will disappear from the display.

Oven Temperature Control

IMPORTANT: Do not use a thermometer to measure oven temperature because opening the oven door and element or burner cycling may give incorrect readings.

The oven provides accurate temperatures; however, it may cook faster or slower than your previous oven, so the temperature calibration can be adjusted. It can be changed in Fahrenheit or Celsius.

A minus sign means the oven will cook cooler by the adjustment amount. No sign means the oven will cook warmer by the adjustment amount. Use the following chart as a guide.

ADJUSTMENT °F (ADJUSTMENT °C)	COOKS FOOD
10°F (6°C)	...a little more
20°F (12°C)	...moderately more
30°F (18°C)	...much more
-10°F (-6°C)	...a little less
-20°F (-12°C)	...moderately less
-30°F (-18°C)	...much less

To Adjust Oven Temperature Calibration:

1. Press and hold BAKE for 5 seconds until the oven display shows the current calibration, for example, "0° CAL".
2. Press the TEMP "up" or "down" arrow pad to increase or to decrease the temperature in 10°F (6°C) amounts. The adjustment can be set between 30°F (18°C) and -30°F (-18°C).
3. Press START/ENTER.

OVEN USE

Aluminum Foil

IMPORTANT: Do not line the oven bottom with any type of foil, liners or cookware because permanent damage will occur to the oven bottom finish.

- Do not cover entire rack with foil because air must be able to move freely for best cooking results.
- To catch spills, place foil on rack below dish. Make sure foil is at least 1 in. (2.5 cm) larger than the dish and that it is turned up at the edges.
- When convection cooking, do not cover food with aluminum foil.

Positioning Racks and Bakeware

IMPORTANT: Never place food or bakeware directly on the oven door or bottom. Permanent damage will occur to the porcelain finish.

RACKS

Position racks before turning the oven on. Do not move racks with bakeware on them. Make sure racks are level. To move a rack, pull it out to the stop position, raise the front edge, then lift out. Use the following illustration and chart as a guide.

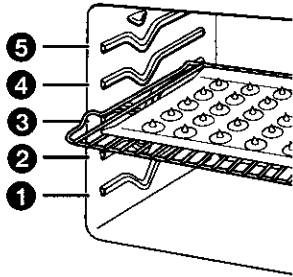

FOOD	RACK POSITION
Frozen pies, large roasts, turkeys, angel food cakes	1 or 2
Bundt cakes, most quick breads, yeast breads, casseroles, meats	2
Cookies, biscuits, muffins, cakes, non-frozen pies	2 or 3

BAKEWARE

To cook food evenly, hot air must be able to circulate. Allow 2 in. (5 cm) of space around bakeware and oven walls. Use the following chart as a guide.

NUMBER OF PAN(S)	POSITION ON RACK
1	Center of rack.
2	Side by side or slightly staggered.
3 or 4	Opposite corners on each rack. Make sure that no bakeware piece is directly over another.

STURDIGLIDE™ Oven Racks

Rack with Integrated Handle

The integrated handle area makes pulling out the rack easy. The opening is large enough for a potholder or oven mitt.

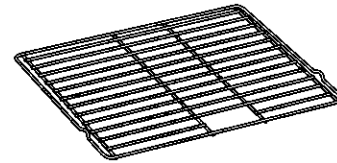

Half-Rack with Removable Insert

The half-rack with removable insert is a space maximizer. When the two are attached, they make a full rack. The insert can also be used on the counter for a cooling rack.

Do not place more than 25 pounds on the half-rack.

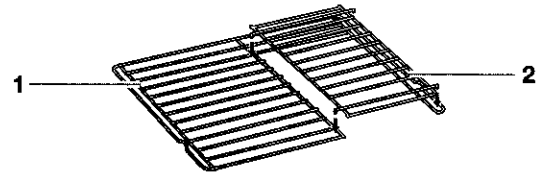

1. Half-Rack
2. Removable Insert

To Position Racks:

1. Place a full rack on position 1 or 2, and the half-rack on position 3 or 4.
2. Place large items on the right side of the full rack.
3. Place deeper, covered dishes on the left side of the full rack.
4. Place shallow dishes on the half-rack.
5. When finished cooking, carefully remove items.

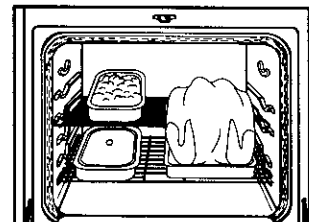

Bakeware

The bakeware material affects cooking results. Follow manufacturer's recommendations and use the bakeware size recommended in the recipe. Use the following chart as a guide.

BAKEWARE/ RESULTS	RECOMMENDATIONS
Light colored aluminum <ul style="list-style-type: none"> ■ Light golden crusts ■ Even browning 	<ul style="list-style-type: none"> ■ Use temperature and time recommended in recipe.
Dark aluminum and other bakeware with dark, dull and/or non-stick finish <ul style="list-style-type: none"> ■ Brown, crisp crusts 	<ul style="list-style-type: none"> ■ May need to reduce baking temperatures 25°F (15°C). ■ Use suggested baking time. ■ For pies, breads and casseroles, use temperature recommended in recipe. ■ Place rack in center of oven.
Insulated cookie sheets or baking pans <ul style="list-style-type: none"> ■ Little or no bottom browning 	<ul style="list-style-type: none"> ■ Place in the bottom third of oven. ■ May need to increase baking time.
Stainless steel <ul style="list-style-type: none"> ■ Light, golden crusts ■ Uneven browning 	<ul style="list-style-type: none"> ■ May need to increase baking time.
Stoneware <ul style="list-style-type: none"> ■ Crisp crusts 	<ul style="list-style-type: none"> ■ Follow manufacturer's instructions.
Ovenproof glassware, ceramic glass or ceramic <ul style="list-style-type: none"> ■ Brown, crisp crusts 	<ul style="list-style-type: none"> ■ May need to reduce baking temperatures 25°F (15°C).

Oven Vent

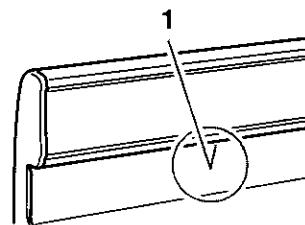

1. Oven Vent

The oven vent releases hot air and moisture from the oven, and should not be blocked or covered. Doing so will cause poor air circulation, affecting cooking and cleaning results. Never set plastics, paper or other items that could melt or burn near the oven vent.

Baking and Roasting

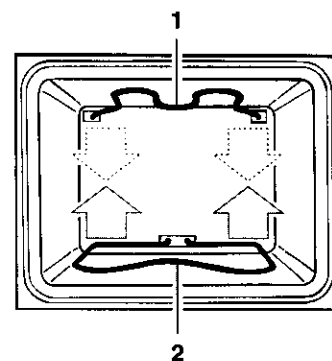

1. Broil element
2. Bake element

ULTRABAKE™ Temperature Management System

The ULTRABAKE system electronically regulates the oven heat levels during preheat and bake to maintain a precise temperature range for optimal cooking results. The bake and broil elements cycle on and off in intervals. This feature is automatically activated when the oven is in use.

If the oven door is opened during baking and roasting, the broil element will turn off immediately and the bake element will turn off in 2 minutes. They will come back on once the door is closed.

To Bake or Roast:

Before baking and roasting, position the racks according to the "Positioning Racks and Bakeware" section. When roasting, it is not necessary to wait for the oven to preheat before putting food in, unless recommended in the recipe.

1. Press **BAKE**.

Press the TEMP "up" or "down" arrow pad to enter a temperature other than 350°F (177°C). The bake range can be set between 170°F and 500°F (77°C and 260°C).

2. Press **START/ENTER**.

A preheat time will count down and "PrE HEAT" will appear on the oven display if the actual oven temperature is under 170°F (77°C).

When the actual oven temperature reaches 170°F (77°C), the timer will continue counting down. The temperature setting can be changed any time after pressing START/ENTER.

While the oven is in the preheat mode, the set temperature can be seen for 5 seconds by pressing **BAKE**.

When the set temperature is reached, if tones are enabled, one tone will sound.

3. Press **OFF/CANCEL** when finished cooking.

Broiling

- Use only the broiler pan and grid provided with the range. It is designed to drain juices and help prevent spatter and smoke.
- For proper draining, do not cover the grid with foil. The bottom of the pan may be lined with aluminum foil for easier cleaning.
- Trim excess fat to reduce spattering. Slit the remaining fat on the edges to prevent curling.
- Pull out oven rack to stop position before turning or removing food. Use tongs to turn food to avoid the loss of juices. Very thin cuts of fish, poultry or meat may not need to be turned.
- After broiling, remove the pan from the oven when removing the food. Drippings will bake on the pan if left in the heated oven, making cleaning more difficult.

Broiling uses direct radiant heat to cook food. Before broiling, position rack according to Broiling chart. It is not necessary to preheat the oven before putting food in unless recommended in the recipe. Position food on grid in the broiler pan, then place it in the center of the oven rack.

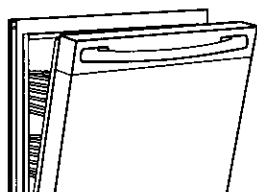

To Broil:

1. Open oven door to the broil stop position to ensure proper broiling temperature.
2. Press **BROIL**.
3. Press **START/ENTER**.
The temperature setting can be changed any time before or after pressing **START/ENTER**.
4. Press **OFF/CANCEL** when finished.

Precision Broiling

Changing the temperature when Precision Broiling allows more precise control while cooking. The lower the temperature, the slower the cooking. Thicker cuts and unevenly shaped pieces of meat, fish and poultry may cook better at lower broiling temperatures.

To Precision Broil:

1. Press **BROIL**.
2. Press the **TEMP** "down" arrow pad to lower the temperature in 5°F amounts. The broil range is 300°F to 500°F (149°C to 200°C).
3. Press **START/ENTER**.
4. Press **OFF/CANCEL** when finished.

Broiling chart

For best results, place food 3 in. (7 cm) or more from the broil element. Times are guidelines only and may need to be adjusted for individual tastes. Recommended rack positions are numbered from the bottom (1) to the top (5). For diagram, see the "Positioning Racks and Bakeware" section.

FOOD	RACK POSITION	TEMP	TOTAL MINUTES	
			Side 1	Side 2
Steak				
1 in. (2.5 cm) thick				
medium rare	4	500°F	13-17	6-7
medium	4	(260°C)	14-15	7-8
well done	4		16-18	8-9
Steak				
1½ in. (3.8 cm) thick	3	475°F	20-22	17-20
well done		(246°C)		
Flank Steak				
1½ in. (3.8 cm) thick	4	475°F	12-13	7-8
well done		(246°C)		
*Ground meat patties				
¾ in. (2 cm) thick	4	500°F	13-14	7-8
well done		(260°C)		
Pork chops				
1 in. (2.5 cm) thick	3	450°F	15-16	11-12
		(232°C)		
Ham slice				
[precooked] ½ in. (1.25 cm) thick	4	500°F	8-10	4-5
		(260°C)		
Frankfurters				
	4	500°F	5-7	3-4
		(260°C)		
Lamb chops				
1 in. (2.5 cm) thick	4	400°F	12-14	7-8
		(204°C)		
Chicken				
bone-in pieces	2	425°F	23-26	18-22
boneless	4	(218°C)	11-16	11-16
Fish				
½ in. (1.25 cm) thick	4	350°F	8-10	4-5
1 in. (2.5 cm) thick	3	450°F	18-19	11-14
		(232°C)		

* Place up to 9 patties, equally spaced, on broiler pan grid.

Timed Oven Control

⚠ WARNING

Food Poisoning Hazard

Do not let food sit in oven more than one hour before or after cooking.

Doing so can result in food poisoning or sickness.

The Timed Oven Control allows the oven to be set to turn on at a certain time of day, cook for a set length of time, and/or shut off automatically. Delay start should not be used for foods such as breads and cakes because they may not bake properly.

To Set a Cook Time:

Before setting, make sure the clock is set to the correct time of day. See "Clock" section.

1. Press **BAKE**.
Press the TEMP "up" or "down" arrow pad to set a temperature other than 350°F (177°C).
2. Press **COOK TIME**.
3. Press the HOUR/MIN "up" or "down" arrow pads to enter the length of time to cook.
4. Press **START/ENTER**.

The start time and stop time countdown will appear on the oven display. The display will count down the baking/roasting time in hours and minutes (if cook time is more than 1 hour), or in minutes and seconds (if cook time is less than 1 hour).

The temperature of time settings can be changed any time after pressing **START/ENTER** by repeating steps 1 and 3.

When the stop time is reached, the oven will shut off automatically and "End" and **COOK TIME** will appear on the oven display.

Four tones will sound, then four 1-second reminder tones will sound every minute thereafter.

5. Press **OFF/CANCEL** or open the oven door to remove "End" from display. The time of day will appear on the display.

To Set a Cook Time and Stop Time [Delay Start]:

1. Press **BAKE**.
Press the TEMP "up" or "down" arrow pad to set a temperature other than 350°F (177°C).
2. Press **COOK TIME**.
3. Press the HOUR/MIN "up" or "down" arrow pads to enter the length of time to cook.
4. Press **DELAY START**.
5. Press the HOUR/MIN "up" or "down" arrow pads to enter the time of day to start.
6. Press **START/ENTER**.

The start time is automatically calculated and displayed. "DELAY" and the stop time will also appear on the oven display.

When the start time is reached, the oven will automatically turn on.

Press the TEMP "up" or "down" arrow pad to set a temperature other than 350°F (177°C).

Four tones will sound, then four 1-second reminder tones will sound every minute.

7. Press **OFF/CANCEL** or open the oven door to remove "End" from display. The time of day will appear on the display.

To Recall Programmed Timed Settings:

To Recall Set	Press	Displayed 5 Seconds
Cook Time	COOK TIME*	set length of cook time
Delay Start	DELAY START	set delay start time
Temperature	BAKE	set temperature

*If cook time has begun, when **DELAY START** is pressed, the display will show the time it started. When **COOK TIME** is pressed, the display will remove the seconds from the remaining countdown time.

To Change Programmed Timed Settings:

To Change Set	Press	Setting Displayed
Cook Time	COOK TIME	Press HOUR/MIN "up/down" arrow Press START/ENTER
Delay Start*	DELAY START	Press HOUR/MIN "up/down" arrow Press START/ENTER
Temperature	BAKE	Press TEMP "up/down" arrow Press START/ENTER

*Cannot change the set delay start time once it has been reached.

12-Hour Shut-Off

The oven control is set to automatically shut the oven off 12 hours after the oven turns on. This will not interfere with any timed or delayed cook function.

The oven light will come on when the oven door is opened. To keep the light on continuously, turn the light on by pressing **OVEN**.

To Override:

For longer cooking periods that require oven usage longer than 12 hours, press and hold **CLOCK** for 5 seconds. A single tone will sound and "12H OFF" will appear on the display. The oven will remain on until turned off.

To Reset:

Press and hold **CLOCK** for 5 seconds. A single tone will sound and "12H on" will appear on the display.

RANGE CARE

Self-Cleaning Cycle (on some models)

⚠ WARNING



Burn Hazard

Do not touch the oven during the Self-Cleaning cycle.

Keep children away from oven during Self-Cleaning cycle.

Do not use commercial oven cleaners in your oven.

Failure to follow these instructions can result in burns, or illness from inhaling dangerous fumes.

IMPORTANT: The health of some birds is extremely sensitive to the fumes given off during the Self-Cleaning cycle. Exposure to the fumes may result in death to certain birds. Always move birds to another closed and well ventilated room.

Self-clean the oven before it becomes heavily soiled. Heavy soil results in longer cleaning and more smoke.

Keep the kitchen well-ventilated during the Self-Cleaning cycle to help get rid of heat, odors, and smoke.

Do not block the oven vent(s) during the Self-Cleaning cycle. Air must be able to move freely. See "Oven Vent(s)" section.

Do not clean, rub, damage or move the oven door gasket. The door gasket is essential for a good seal.

Prepare Oven:

- Remove the broiler pan, grid, cookware and bakeware and, on some models, the temperature probe from the oven.
- Remove any foil from the oven because it may burn or melt, damaging the oven.
- Remove oven racks to keep them shiny and easy to slide. See "General Cleaning" section for more information.
- Hand clean inside door edge and the 1½ in. (3.8 cm) area around the inside oven cavity frame, being careful not to move or bend the gasket. This area does not get hot enough during self-cleaning to remove soil. Do not let water, cleaner, etc. enter slots on door frame. Use a damp cloth to clean this area.
- Wipe out any loose soil to reduce smoke and avoid damage. At high temperatures, foods react with porcelain. Staining, etching, pitting or faint white spots can result. This will not affect cooking performance.

Prepare Cooktop and Storage Drawer:

- Remove plastic items from the cooktop because they may melt.
- Remove all items from the storage drawer.

How the Cycle Works

IMPORTANT: The heating and cooling of porcelain on steel in the oven may result in discoloring, loss of gloss, hairline cracks and popping sounds.

The SELECT CLEAN™ Self-Cleaning cycle uses very high temperatures and dissolves soil to a powdery ash.

SELECT CLEAN will set the clean time automatically, once the soil level is set.

The soil level can be manually set to light, average or heavy soil levels by continuously pressing SELECT CLEAN.

The oven will automatically shut off once it is clean. The door will not unlock until the oven cools.

Once the oven has completely cooled, remove ash with a damp cloth.

The oven light will not work during the Self-Cleaning cycle.

To Set SELECT CLEAN (on some models):

- Press **once** for **light** soils, and "SoilL" will appear on the display.
- Press **two** times for **average** soils, and "SoilA" will appear on the display.
- Press **three** times for **heavy** soils, and "SoilH" will appear on the display.

To Set CLEAN:

- Press **CLEAN**. This will automatically set a **3 hours 30 minutes Self-Cleaning cycle**.
- Press the HOUR/MIN "up" or "down" arrow pads to set a Self-Cleaning cycle longer or shorter than the 3 hours 30 minutes cycle.

To Start Self-Clean:

Before self-cleaning, make sure the door is closed completely or it will not lock and the cycle will not begin.

1. Set SELECT CLEAN (on some models) or CLEAN.
2. Press START/ENTER.
The oven door will lock in 6 seconds and "LOCKED", the start time and stop time will appear on the display. The door will not unlock until the oven cools. The cycle time includes a 30 minute cool down time
When the cycle is complete and the oven cools, "End" will appear on the display and "LOCKED" will disappear.
3. Press any pad to remove "End" or open the oven door.
4. Close door.
The time of day will appear on the display.

To Delay Start Self-Clean:

Before delay starting Self-Clean, make sure the clock is set to the correct time of day. See "Clock" section. Also, make sure the door is closed completely or it will not lock and the cycle will not begin.

1. Set SELECT CLEAN (on some models) or CLEAN.
2. Press DELAY START.
Press the HOUR/MIN "up" or "down" arrow pad to set time of day to start the Self-Cleaning cycle.
3. Press START/ENTER.
The start time is automatically calculated and displayed. The door will automatically lock and "LOCKED", "DELAY" and the stop time will also appear on the display.
When the start time is reached, the oven will automatically turn on.
When the cycle is complete and the oven cools, "End" will appear on the display and "LOCKED" will disappear.
4. Press any pad to remove "End" or open the oven door.
5. Close door.
The time of day will appear on the display.

To Stop Self-Clean any time:

Press OFF/CANCEL, and "cln", "ON", "cool" and "LOCKED" will appear on the display until the oven cools. Then "End" will appear and the door will unlock.

General Cleaning

IMPORTANT: Before cleaning, make sure all controls are off and the oven and cooktop are cool. Always follow label instructions on cleaning products.

Soap, water and a soft cloth or sponge are suggested first unless otherwise noted.

EXTERIOR PORCELAIN ENAMEL SURFACES (on some models)

Food spills containing acids, such as vinegar and tomato, should be cleaned as soon as the entire appliance is cool. These spills may affect the finish.

- Glass cleaner, mild liquid cleaner or non-abrasive scrubbing pad:

Gently clean around the model and serial number plate because scrubbing may remove numbers.

RADIANT GLASS

Do not use steel wool, abrasive powder cleansers, chlorine bleach, rust remover or ammonia because damage may occur.

Always wipe with a clean, wet cloth or sponge and dry thoroughly to prevent streaking and staining.

Cooktop Cleaning Creme is recommended regularly to help prevent scratches, pitting and abrasions and to condition the cooktop, and can be purchased as an accessory at Sears Retail Stores in the range department. Ask for stock number 22-40079 or call Sears PartsDirect at 1-800-366-7278 and give the following information: 1) Division 22, 2) PLS-022, 3) Part no. 40079.

A Cooktop Scraper is also recommended for stubborn soils, and can be ordered as an accessory. The Cooktop Scraper uses razor blades. **Store razor blades out of the reach of children.**

Light to moderate soil

- Paper towels or clean damp sponge:

Clean while the cooktop is still warm. You may want to wear oven mitts while doing so.

Sugary spills (jellies, candy, syrup)

- Cooktop Scraper:

Clean while the cooktop is still warm. You may want to wear oven mitts while doing so.

- Cooktop Cleaning Creme and clean damp paper towel:

Clean as soon as cooktop has cooled down. Rub creme into surface with a damp paper towel or soft cloth. Continue rubbing until white film disappears.

Heavy soil, dark streaks, specks and discoloration

- Cooktop Cleaning Creme or non-abrasive cleanser:

Rub product into soil with a damp paper towel or soft cloth. Continue rubbing until white film disappears.

Burned-on soil

- Cooktop Cleaning Creme and Cooktop Scraper:

Rub creme into soil with damp paper towel. Hold scraper as flat as possible on surface and scrape. Repeat for stubborn spots. Polish entire cooktop with creme and paper towel.

Metal marks from aluminum and copper

■ Cooktop Cleaning Creme:

Clean as soon as cooktop has cooled down. Rub creme into surface with a damp paper towel or soft cloth. Continue rubbing until white film disappears. The marks will not totally disappear but after many cleanings become less noticeable.

Tiny scratches and abrasions

■ Cooktop Cleaning Creme:

Rub creme into surface with a damp paper towel or soft cloth. Continue rubbing until white film disappears. Scratches and abrasions do not affect cooking performance and after many cleanings become less noticeable.

COOKTOP CONTROLS

Do not use steel wool, abrasive cleansers or oven cleaner.

Do not soak knobs.

When replacing knobs, make sure knobs are in the OFF position.

On some models, do not remove seals under knobs.

■ Soap and water or dishwasher:

Pull knobs straight away from control panel to remove.

SURFACE UNDER COOKTOP (on some models)

Do not remove the cooktop to avoid product damage.

OVEN DOOR EXTERIOR

■ Glass cleaner and paper towels or non-abrasive plastic scrubbing pad:

Apply glass cleaner to soft cloth or sponge, not directly on panel.

CONTROL PANEL

Do not use abrasive cleaners, steel-wool pads, gritty wash cloths or some paper towels. Damage may occur.

■ Glass cleaner and soft cloth or sponge:

Apply glass cleaner to soft cloth or sponge, not directly on panel.

OVEN CAVITY

Do not use oven cleaners.

Food spills should be cleaned when oven cools. At high temperatures, foods react with porcelain and staining, etching, pitting or faint white spots can result.

■ Self-Cleaning cycle:

See "Self-Cleaning Cycle" first.

OVEN AND ROASTING RACKS

■ Self-Cleaning cycle:

See "Self-Cleaning Cycle" first. Racks will discolor and become harder to slide. After cleaning, a light coating of vegetable oil applied to the rack guides will help them slide.

■ Steel wool pad

BROILER PAN AND GRID

Do not clean in the Self-Cleaning cycle.

■ Mildly abrasive cleanser:

Scrub with wet scouring pad.

■ Solution of ½ cup (125 mL) ammonia to 1 gallon (3.75 L) water:

Soak for 20 minutes, then scrub with scouring or steel wool pad.

■ Oven cleaner:

Follow product label instructions.

Porcelain enamel only, not chrome

■ Dishwasher

STORAGE DRAWER

Make sure drawer is cool and empty before cleaning.

For more information, see "Storage Drawer" section.

■ Mild detergent

Oven Light

The oven light is a standard 40-watt appliance bulb. It will come on when the oven door is open. It will not work during the Self-Cleaning cycle. When the oven door is closed, press the OVEN pad to turn on and off.

Before replacing, make sure the oven and cooktop are cool and the control knobs are off.

To Replace:

1. Unplug range or disconnect power.
2. Turn the glass bulb cover in the back of the oven counterclockwise to remove.

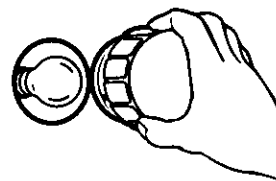

3. Turn bulb counterclockwise to remove from socket.
4. Replace bulb, then bulb cover by turning clockwise.
5. Plug in range or reconnect power.

Oven Door

For normal range use, it is not suggested to remove the oven door. However, if necessary, follow these instructions. The oven door is heavy.

Before Removing:

1. Use a putty knife or screwdriver and insert it at the bottom corner of the door stop clip.

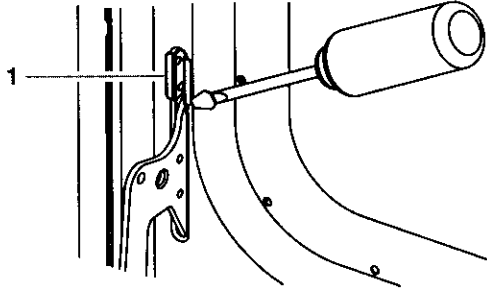

1. Door Stop Clip

2. Pry door stop clip free and remove from front frame hinge slot. Take care not to scratch finish.
3. Repeat procedure for other door stop clip.

To Remove:

1. Open the oven door. Insert door removal pins, included with your range, into both hinge hangers. Do not remove the pins while the door is removed from the range.

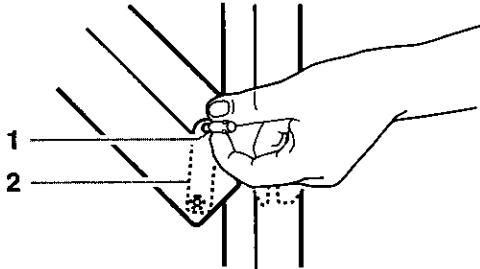

1. Removal Pins
2. Hinge Hangers

2. Carefully close the door until it rests against the door removal pins.
3. Grasp the door on the sides with your fingers on the front of the door and your thumbs on the inside surface.
4. Pull door straight up, then toward you. Hinge hangers will slide out of front frame hinge slot. Do not remove door removal pins until the door is replaced on the range.

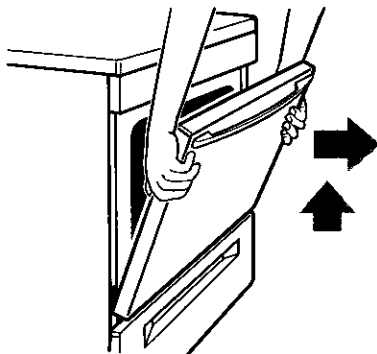

To Replace:

1. Grasp the door on the sides with your fingers on the front of the door and your thumbs on its inside surface.
2. Hold oven door so that the top edge of each hinge hanger is horizontal. Insert hinge hangers into the front frame hinge slots.
3. Tilt top of door toward range. Slide hinge hangers down onto front frame support pins. Make sure the hinge hangers are fully seated and engaged on the support pins.

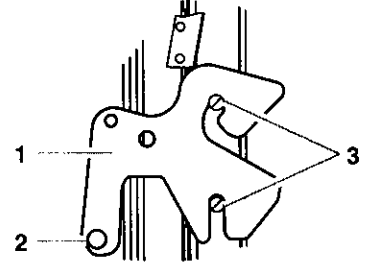

1. Hinge Hanger
2. Door Frame Hinge
3. Support Pins

4. Insert the door stop clip with the angular surface at the top of the frame hinge slot, then push in the bottom of the clip until flanges are flush with the front frame.

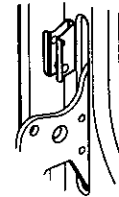

5. Open the door completely and remove the door removal pins. Save door removal pins for future use.
6. Close the door.

Storage Drawer

The storage drawer can be removed. Before removing, make sure drawer is cool and empty.

To Remove:

1. Pull drawer straight out to the first stop.
2. Lift up the back of the drawer and pull out.

To Replace:

1. Fit the ends of the drawer rails into the guides in the cavity.
2. Slide the drawer closed.

TROUBLESHOOTING

Try the solutions suggested here first in order to avoid the cost of an unnecessary service call.

Nothing will operate

- **Is the power supply cord unplugged?**
Plug into a grounded outlet.
 - **Has a household fuse been blown or has the circuit breaker been tripped?**
Replace the fuse or reset the circuit.
-

Cooktop will not operate

- **Is the control knob set correctly?**
Push in knob before turning to a setting.
 - **On some Radiant Glass models, is the "Cooktop Lockout" set?**
See "Cooktop Lockout" section.
 - **On coil element models, is the element inserted properly?**
See "Coil Elements and Burner Bowls" section.
-

Left front surface cooking area will not operate

- **Cannot boil on left front surface cooking area?**
Press the SURESIMMER™ button to OFF. Turn left front control knob to HI for a rapid boil.
 - **SURESIMMER will not simmer?**
Turn left front control knob on between the SURESIMMER LO and 4 settings, while pressing the SURESIMMER button on.
 - **SURESIMMER surface cooking area does not get hot enough?**
Turn left front control knob to 4 while pressing the SURESIMMER button on.
-

Excessive heat around cookware on cooktop

- **Is the cookware the proper size?**
Use cookware about the same size as the surface cooking area, element or surface burner. Cookware should not extend more than 1 in. (2.5 cm) outside the cooking area.
-

Cooktop cooking results not what expected

- **Is the proper cookware being used?**
See "Cookware" section.
 - **Is the control knob set to the proper heat level?**
See Cooktop "Control Knobs" section.
 - **Is the appliance level?**
Level the appliance. See the Installation Instructions.
 - **On coil element models, is the element inserted properly?**
See "Coil Elements and Burner Bowls" section.
-

Oven will not operate

- **Is the electronic oven control set correctly?**
See "Electronic Oven Control" section.
 - **Has a delay start been set?**
See "Timed Oven Control" section.
-

- **On some models, is the Oven Lockout set?**
See "Oven Lockout" section.
 - **On some models, is the 12-Hour Shut-off set?**
See "12-Hour Shut-Off" section.
-

Oven temperature too high or too low

- **Does the oven temperature calibration need adjustment?**
See "Oven Temperature Control" section.
-

Display shows messages

- **Is the display showing "PF", "PF id=27" or "PF id=30"?**
There has been a power failure. Clear the display. See "Display(s)" section. On some models, reset the clock, if needed. See "Clock" section.
 - **Is the display showing a letter followed by a number?**
Clear the display. See "Display(s)" section. If it reappears, contact a Sears trained repair specialist. See back cover.
-

Self-Cleaning cycle will not operate

- **Is the oven door open?**
Close the oven door all the way.
 - **Has the function been entered?**
See "Self-Cleaning Cycle" section.
 - **On some models, has a delay start Self-Clean cycle been set?**
See "Self-Cleaning Cycle" section.
 - **Has a delay start been set?**
See "Timed Oven Control" section.
 - **On double oven models, is one oven self-cleaning?**
When one oven is self-cleaning, the other oven cannot be set to self-clean.
-

Oven cooking results not what expected

- **Is the appliance level?**
Level the appliance. See the Installation Instructions.
- **Is the proper temperature set?**
Double-check the recipe in a reliable cookbook.
- **Is the proper oven temperature calibration set?**
See "Oven Temperature Control" section.
- **Was the oven preheated?**
See "Baking and Roasting" section.
- **Is the proper bakeware being used?**
See "Bakeware" section.
- **Are the racks positioned properly?**
See "Positioning Racks and Bakeware" section.
- **Is there proper air circulation around bakeware?**
See "Positioning Racks and Bakeware" section.
- **Is the batter evenly distributed in the pan?**
Check to make sure batter is level in the pan.
- **Is the proper length of time being used?**
Adjust cooking time.
- **Has the oven door been opened while cooking?**
Oven peeking releases oven heat and can result in longer cooking times.
- **Are baked items too brown on the bottom?**
Move rack to higher position in the oven.
- **Are pie crust edges browning early?**
Use aluminum foil to cover the edge of the crust.

Free Manuals Download Website

<http://myh66.com>

<http://usermanuals.us>

<http://www.somanuals.com>

<http://www.4manuals.cc>

<http://www.manual-lib.com>

<http://www.404manual.com>

<http://www.luxmanual.com>

<http://aubethermostatmanual.com>

Golf course search by state

<http://golfingnear.com>

Email search by domain

<http://emailbydomain.com>

Auto manuals search

<http://auto.somanuals.com>

TV manuals search

<http://tv.somanuals.com>