

Use & Care Guide
Manual de Uso y Cuidado
English / Español

Model/Modelo: 790.9256*

Kenmore[®]

Electric Range

Estufa eléctrica

* = color number, número de color

P/N 808530002 Rev. B

Sears Brands Management Corporation
Hoffman Estates, IL 60179 U.S.A.
www.kenmore.com
www.sears.com



Table of Contents

Before You Call 31

Cooking Recommendations.....	9
Before Setting Surface Controls.....	12
Using Proper Cookware	12
Setting Surface Controls.....	14
Before Setting Oven.....	16
Oven Controls	17
Care and Cleaning	25

KENMORE LIMITED WARRANTY

WITH PROOF OF SALE the following warranty coverage applies when this appliance is correctly installed, operated and maintained according to all supplied instructions.

One Year on Appliance

FOR ONE YEAR from the date of sale this appliance is warranted against defects in material or workmanship. A defective appliance will receive free repair or replacement at option of seller.

Lifetime on Cooktop Gas Burners and Cooktop Electric Elements

FOR AS LONG AS IT IS USED from the date of sale, a free replacement will be supplied for a defective cooktop gas burner or cooktop electric element. If the defect appears within the first year, a new burner or element will be installed at no charge. If the defect appears after the first year, a new burner or element will be supplied but not installed at no charge. This Lifetime warranty covers only the burners or elements, and does not apply to any other related component or mechanism. You are responsible for the labor cost of burner or element glass installation after the first year from the date of sale.

For warranty coverage details to obtain free repair or replacement, visit the web page: www.kenmore.com/warranty

All warranty coverage applies for only 90 DAYS from the sale date if this appliance is ever used for other than private household purposes.

This warranty covers ONLY defects in material and workmanship, and will NOT pay for:

1. Cracks in a ceramic glass cooktop that are not a result of thermal shock.
2. Stains and scratches on a ceramic glass cooktop resulting from accident or improper operation or maintenance.
3. Discoloration of cooktop surfaces resulting from normal use.
4. Expendable items that can wear out from normal use, including but not limited to filters, belts, bags or screw-in base light bulbs.
5. A service technician to clean or maintain this appliance, or to instruct the user in correct appliance installation, operation and maintenance.
6. Service calls to correct appliance installation not performed by Sears authorized service agents, or to repair problems with house fuses, circuit breakers, house wiring, and plumbing or gas supply systems resulting from such installation.
7. Damage to or failure of this appliance resulting from installation not performed by Sears authorized service agents, including installation that was not in accord with electrical, gas or plumbing codes.
8. Damage to or failure of this appliance, including discoloration or surface rust, if it is not correctly operated and maintained according to all supplied instructions.
9. Damage to or failure of this appliance, including discoloration or surface rust, resulting from accident, alteration, abuse, misuse or use for other than its intended purpose.
10. Damage to or failure of this appliance, including discoloration or surface rust, caused by the use of detergents, cleaners, chemicals or utensils other than those recommended in all instructions supplied with the product.
11. Damage to or failure of parts or systems resulting from unauthorized modifications made to this appliance.
12. Service to an appliance if the model and serial plate is missing, altered, or cannot easily be determined to have the appropriate certification logo.

Disclaimer of implied warranties; limitation of remedies

Customer's sole and exclusive remedy under this limited warranty shall be product repair or replacement as provided herein. Implied warranties, including warranties of merchantability or fitness for a particular purpose, are limited to one year on the appliance and for as long as used on cooktop gas burners or cooktop electric elements, or the shortest period allowed by law. Seller shall not be liable for incidental or consequential damages. Some states and provinces do not allow the exclusion or limitation of incidental or consequential damages, or limitation on the duration of implied warranties of merchantability or fitness, so these exclusions or limitations may not apply to you.

This warranty applies only while this appliance is used in the United States.

This warranty gives you specific legal rights, and you may also have other rights which vary from state to state.

Sears Brands Management Corporation, Hoffman Estates, IL 60179

IMPORTANT SAFETY INSTRUCTIONS

Read all instructions before using this appliance.

This manual contains important safety symbols and instructions. Please pay attention to these symbols and follow all instructions given.

Do not attempt to install or operate your appliance until you have read the safety precautions in this manual. Safety items throughout this manual are labeled with a **WARNING** or **CAUTION** statement based on the risk type.

Warnings and important instructions appearing in this guide are not meant to cover all possible conditions and situations that may occur. Common sense, caution, and care must be exercised with installing, maintaining, or operating your appliance.

DEFINITIONS

⚠ This is the safety alert symbol. It is used to alert you to potential personal injury hazards. Obey all safety messages that follow this symbol to avoid possible injury or death.

⚠ WARNING - Indicates a potentially hazardous situation which, if not avoided, may result in death or serious injury.

⚠ CAUTION - Indicates a potentially hazardous situation which, if not avoided, may result in minor or moderate injury.

IMPORTANT - Indicates installation, operation, maintenance, or valuable information that is not hazard related.

NOTE - Indicates a short, informal reference – something written down to assist the memory or for future reference.

⚠ WARNING

Tip Over Hazard



- A child or adult can tip the range and be killed.
- Verify the anti-tip device has been installed to floor or wall.

- Ensure the anti-tip device is re-engaged to floor or wall when the range is moved.
- Do not operate the range without the anti-tip device in place and engaged.
- Failure to follow these instructions can result in death or serious burns to children and adults.



Range

leveling leg

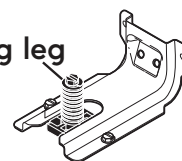

Anti-tip
bracket

To check if the anti-tip bracket is installed properly, use both arms and grasp the rear edge of the range back. Carefully attempt to tilt range forward. When properly installed, the range should not tilt forward.

Refer to the anti-tip bracket installation instructions supplied with your range for proper installation.

IMPORTANT SAFETY INSTRUCTIONS

Read all instructions before using this appliance.

IMPORTANT INSTRUCTIONS FOR UNPACKING AND INSTALLATION

IMPORTANT - Read and follow the below instructions and precautions for unpacking, installing, and servicing your appliance:

Remove all tape and packaging before using the appliance. Destroy the carton and plastic bags after unpacking the appliance. Never allow children to play with packaging material. Do not remove the wiring label and other literature attached to the appliance. Do not remove model/serial number plate.

Cold temperatures can damage the electronic control. When using this appliance for the first time, or when the appliance has not been used for an extended period of time, be sure the appliance has been in temperatures above 32°F (0°C) for at least 3 hours before turning on the power to the appliance.

Never modify or alter the construction of the appliance by removing the leveling legs, panels, wire covers, anti-tip brackets/screws, or any other part of the appliance.

Be sure to have an appropriate foam-type fire extinguisher available, visible, and easily accessible located near the appliance.

GROUNDING INSTRUCTIONS

⚠ WARNING - Avoid fire hazard or electrical shock. Failure to follow this warning may cause serious injury, fire, or death.

⚠ WARNING - Avoid fire hazard or electrical shock. Do not use an adapter plug, use an extension cord, or remove grounding prong from the power cord. Failure to follow this warning may cause serious injury, fire, or death.

Proper Installation—Be sure your appliance is properly installed and grounded by a qualified technician. In the United States, install in accordance with the National Fuel Gas Code ANSI Z223.1/NPFA No. 54, latest edition and National Electrical Code NFPA No. 70 latest edition, and local electrical code requirements. In Canada, install in accordance with CAN/CGA B149.1 and CAN/CGA B149.2 and CSA Standard C22.1, Canadian Electrical code, Part 1-latest editions and local electrical code requirements. Install only per installation instructions provided in the literature package for this appliance.

For personal safety, this appliance must be properly grounded. For maximum safety, the power cord must be securely connected to an electrical outlet or junction box that is the correct voltage, is correctly polarized and properly grounded, and protected by a circuit breaker in accordance with local codes.

It is the personal responsibility of the consumer to have the appropriate outlet or junction box with the correct, properly grounded wall receptacle installed by a qualified electrician. It is the responsibility and obligation of the consumer to contact a qualified installer to assure that the electrical installation is adequate and is in conformance with all local codes and ordinances.

See the installation instructions packaged with this appliance for complete installation and grounding instructions.

IMPORTANT INSTRUCTIONS FOR USING THE APPLIANCE

⚠ WARNING - **Storage In or On Appliance**—Flammable materials should not be stored in an oven or microwave, near surface burners or elements, or in the storage or warmer drawer (if equipped). This includes paper,

Save these instructions for future reference.

IMPORTANT SAFETY INSTRUCTIONS

Read all instructions before using this appliance.

plastic, and cloth items, such as cookbooks, plastic ware, and towels, as well as flammable liquids. Do not store explosives, such as aerosol cans, on or near the appliance.

⚠ WARNING - Do not leave children alone - Children should not be left alone or unattended in the area where appliance is in use. They should never be allowed to sit or stand on any part of the appliance, including the storage drawer, lower broiler drawer, warmer drawer, or lower double oven.

⚠ WARNING - Do not store items of interest to children in the cabinets above the appliance or on the backguards of ranges. Children climbing on or near the appliance to reach items could be seriously injured.

⚠ WARNING - Do not allow children to climb or play around the appliance. The weight of a child on an open oven door may cause the appliance to tip, resulting in serious burns or other injury. An open drawer when hot may cause burns.

⚠ WARNING - Stepping, leaning, or sitting on the door or drawers of this appliance can result in serious injuries and also cause damage to the appliance.

⚠ WARNING - Never cover any slots, holes or passages in the oven bottom or cover and entire rack with materials such as aluminum foil. Doing so blocks air flow through the oven and may cause carbon monoxide poisoning. Aluminum foil linings may also trap heat, causing a fire hazard.

⚠ WARNING - Do not use oven or warmer drawer (if equipped) for storage.

⚠ WARNING - Never use your appliance as a space heater to heat or warm the room. Doing so may result in carbon monoxide poisoning and overheating of the appliance.

⚠ CAUTION - When heating fat or grease, watch it closely. Grease may catch fire if it becomes too hot.

⚠ CAUTION - Do not use water or flour on grease fires. Smother fire or flame or use dry chemical or foam-type extinguisher. Cover the fire with a pan lid or use baking soda.

⚠ CAUTION - Use dry potholders. Moist or damp potholders on hot surfaces may result in burns from steam. Do not let potholders touch hot cooking areas. Do not use towels or other bulky cloths.

⚠ CAUTION - Do not heat unopened food containers - Build-up of pressure may cause container to burst and result in injury.

⚠ CAUTION - Wear proper apparel - Loose-fitting or hanging garments should never be worn while using the appliance. Do not let clothing or other flammable materials contact hot surfaces.

⚠ CAUTION - Do not touch surface burners or elements, areas near these burners or elements, interior surfaces of the oven, or the warmer drawer (if equipped). Surface burners and elements may be hot even though they appear cool. Areas near surface burners and elements may become hot enough to cause burns. During and after use, do not touch, or let clothing or other flammable materials touch these areas until they are cool. These areas may include the cooktop, surfaces facing the cooktop, oven vent areas, oven door, and oven window.

⚠ CAUTION - Do not attempt to operate the appliance during a power failure. If the power fails, always turn off the appliance. If the appliance is not turned off and the power resumes, electric surface elements may resume operation when power is restored. Once the power resumes, reset the clock and the oven function.

Save these instructions for future reference.

IMPORTANT SAFETY INSTRUCTIONS

Read all instructions before using this appliance.

IMPORTANT INSTRUCTIONS FOR USING YOUR RADIANT COOKTOP

Know which knob or key controls each surface heating area. Place cookware with food on the cooking area before turning it on. Turn the cooking area off before removing the cookware.

Cookware handles should be turned inward and not extend over adjacent surface elements — To reduce the risk of burns, ignition of flammable materials, and spillage due to unintentional contact with the utensil, the handle of the cookware should be positioned so that it is turned inward, and does not extend over other cooking areas.

Use proper pan size - This appliance is equipped with one or more surface units of different sizes. Select cookware with flat bottoms that match the surface unit size. Using the proper cookware on the cooking area will improve efficiency.

Glazed cooking utensils— Only certain types of glass, glass/ceramic, ceramic, earthenware, or other glazed utensils are suitable for cooktop service without breaking due to the sudden change in temperature. Check the manufacturer's recommendations for cooktop use.

Improper cookware may break due to sudden changes in temperature. Check the cookware manufacturer's recommendations for cooktop use.

Never leave surface elements unattended. Boil-overs may cause smoking and greasy spills that may ignite. A pan that has boiled dry could be damaged and may damage the cooktop.

Do not use a searing grill meant for use with a broiler pan on the cooktop. The searing grill is not designed for use on the cooktop. Doing so may result in a fire.

When you are flaming foods under a ventilating hood, turn on the fan.

IMPORTANT SAFETY INSTRUCTIONS

Read all instructions before using this appliance.

IMPORTANT INSTRUCTIONS FOR USING YOUR COIL COOKTOP

Make sure reflector pans or drip bowls are in place - absence of these pans or bowls during cooking may subject wiring or components underneath to damage.

Carefully check the reflector pans, drip bowls, and coils for packaging material. Remove all packaging material before using the cooktop.

Protective Liners - Do not use aluminum foil to line surface drip bowls. Improper use of these liners may result in a risk of electric shock or fire.

Do not immerse or soak removable heating elements—Heating elements should never be immersed in water. Heating elements clean themselves during normal operation.

Do not use decorative surface burner covers. If an element is accidentally turned on, the decorative cover will become hot and possibly melt. Burns will occur if the hot covers are touched. Damage may also be done to the cooktop.

Do not allow grease to accumulate around surface burners and drip bowls.

IMPORTANT INSTRUCTIONS FOR USING YOUR OVEN

Protective liners—Do not use aluminum foil, aftermarket oven liners, or any other materials or devices to line oven bottom, oven racks, or any other part of the appliance. Only use aluminum as recommended for baking, such as lining cookware or as a cover placed on food. Any other use of protective liners or aluminum foil may result in a risk of electric shock or fire or a short circuit.

Use care when opening oven door, lower oven door, or warmer drawer (some models). Stand to the side of the appliance when opening the door of a hot oven. Let hot air or steam escape before you remove or replace food in the oven.

Keep oven vent ducts unobstructed. Touching surfaces in this area when the oven is on may cause severe burns. Do not place plastic or heat-sensitive items on or near the oven vent. These items can melt or ignite.

Placement of oven racks - Always place oven racks in desired location while oven is cool. If rack must be moved while oven is hot, do not let potholder contact hot burner or element in oven. Use potholders and grasp the rack with both hands to reposition. Remove all cookware and utensils before moving the rack.

Do not use a broiler pan without its insert. Broiler pans and inserts allow dripping fat to drain away from the high heat of the broiler. Do not cover the broiler insert with aluminum foil; exposed fat and grease could ignite.

Do not cook food on the oven bottom. Always cook in proper cookware and always use the oven racks.

IMPORTANT INSTRUCTIONS FOR CLEANING YOUR APPLIANCE

CAUTION - Before manually cleaning any part of the appliance, be sure all controls are turned off and the appliance is cool. Cleaning a hot appliance can cause burns.

Clean the appliance regularly to keep all parts free of grease that could catch fire. Do not allow grease to accumulate. Greasy deposits in the fan could catch fire.

IMPORTANT SAFETY INSTRUCTIONS

Read all instructions before using this appliance.

Always follow the manufacturer's recommended directions for use of kitchen cleaners and aerosols. Be aware that excess residue from cleaners and aerosols may ignite causing damage and injury.

Clean ventilating hoods frequently - Grease should not be allowed to accumulate on hood or filter. Follow the manufacturer's instructions for cleaning vent hoods.

IMPORTANT INSTRUCTIONS FOR SELF CLEANING OVENS

Do not clean the oven door gasket. The door gasket is essential for a good seal. Care should be taken not to rub, damage, or move the gasket.

Do not use oven cleaners. No commercial oven cleaner or oven liner protective coating of any kind should be used in or around any part of the appliance.

Use the self clean cycle to clean only the parts listed in this manual.

Before using self clean, remove the broiler pan, any food, utensils, and cookware from the oven, storage drawer or warming drawer (if equipped). Remove oven racks unless otherwise instructed.

Some birds are extremely sensitive to the fumes given off during the self clean cycle of any oven. Move birds to another well-ventilated room.

IMPORTANT INSTRUCTIONS FOR SERVICE AND MAINTENANCE

Do not repair or replace any part of the appliance unless specifically recommended in the manuals. All other servicing should be done only by a qualified technician. This reduces the risk of personal injury and damage to the appliance.

Always contact your dealer, distributor, service agent, or manufacturer about problems or conditions you do not understand.

Ask your dealer to recommend a qualified technician and an authorized repair service. Know how to disconnect the power to the appliance at the circuit breaker or fuse box in case of an emergency.

Remove the oven door from any unused oven if it is to be stored or discarded.



Do not touch a hot oven light bulb with a damp cloth. Doing so could cause the bulb to break. Handle halogen lights (if equipped) with paper towels or soft gloves. Disconnect the appliance or shut off the power to the appliance before removing and replacing the bulb.

Important Safety Notice - The California Safe Drinking Water and Toxic Enforcement Act requires the governor of California to publish a list of substances known to cause cancer, birth defects, or other reproductive harms, and requires businesses to warn customers of potential exposures to such substances.

Cooking Recommendations

Bakeware

The material of bakeware affects how evenly and quickly it transfers heat from the pan to the food.

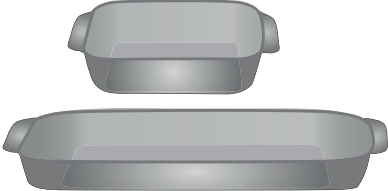
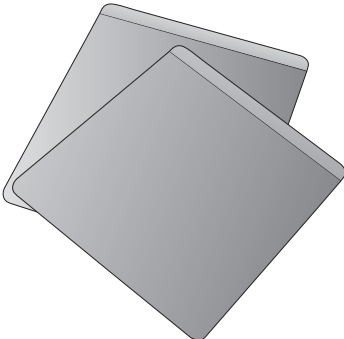
Material	Attributes	Recommendation
<p>Shiny metal bakeware</p> 	<p>Shiny, aluminum, and non-coated bakeware is the best for even heating. It is suitable for all baked goods.</p>	<p>Recommended cooking temperatures and times are based on shiny metal bakeware.</p>
<p>Dark metal bakeware</p> 	<p>Dark bakeware cooks hotter than shiny bakeware.</p>	<p>Reduce the cooking temperature by 25° F (13-14° C) when using dark bakeware.</p>
<p>Glass bakeware</p> 	<p>Glass bakeware cooks hotter than shiny bakeware.</p> <p>Glass is convenient, as the same piece of bakeware can be used for cooking, serving, and storing food.</p>	<p>Reduce the cooking temperature by 25° F (13-14° C) when using glass bakeware.</p>
<p>Insulated bakeware</p> 	<p>Insulated bakeware cooks cooler than shiny bakeware.</p> <p>Insulated bakeware is designed for baking in gas ovens.</p>	<p>Increase the cooking temperature by 25° F (13-14° C) when using insulated bakeware.</p>

Cooking Recommendations

Cooking Conditions

Conditions in your kitchen can affect the performance of your appliance when cooking food.

Condition	Attributes	Recommendation
Aging cookware	As pans age and become discolored, cooking times may need to be reduced slightly.	If food is too dark or overcooked, use the minimum cook time in the recipe or packaging. If food is too light or undercooked, use the middle to maximum cook time in the recipe or packaging.
High altitude	Air is drier and air pressure is lower. Water boils at a lower temperature, and liquids evaporate faster. Foods may take longer to bake. Doughs may rise faster.	Adjust cooking temperature, cooking time, or recipes as needed. Increase amount of liquid in baking recipes. Increase cook time on cooktop. Cover dishes to reduce evaporation. Increase bake time or oven temperature. Reduce amount of baking soda or baking powder in recipe. Reduce rising time or punch down dough and allow it to rise twice.

Cooking Results

Small adjustments may fix a problem with food not being as done as you like or more done than you like.

Result	Recommendation
Food too light	Use the middle to maximum cook time recommended on packaging or recipe.
Food too dark	Use the minimum cook time recommended on packaging or recipe.

Cooking Tips

Use these additional tips to get the best results from your appliance.

Cooking	Tips
Baking	
Rack placement	Follow the instructions in " Controles del horno " on starting on page 18 . When using only one rack, place the rack so the food is in the center of the oven.
Preheat	Fully preheat the oven before baking items like cookies, cakes, biscuits and breads. Insert food immediately after the beep.
Checking food	Use the window and oven light when checking food. Opening the door may reduce baking performance.
Food placement	Allow at least 2 inches (5 cm) of space between bakeware for proper air circulation.

Cooking	Tips
Broiling / Roasting	
Broiling pan	<p>For best results when broiling, use a broil pan with a broil pan insert designed to drain the fat from the food, help avoid spatter, and reduce smoking. The broiler pan will catch grease spills, and the insert helps prevent grease splatters.</p> <p>If a broiler pan and insert are not supplied with this appliance, they may be purchased from Sears. Call 1-844-553-6667 and order broiler pan kit 5304442087.</p>

Before Setting Surface Controls

Using Proper Cookware

The size and type of cookware used will influence the heat setting needed for best cooking results. Be sure to follow the recommendations for using proper cookware as illustrated in [Figure 1](#) and [Figure 2](#).

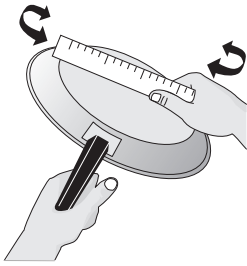

Check for flatness by rotating a ruler across the bottom of the cookware (see [Figure 1](#)). Cookware should have flat bottoms that make good contact with the entire surface of the heating element (see [Figure 2](#)).

Figure 1: Testing cookware

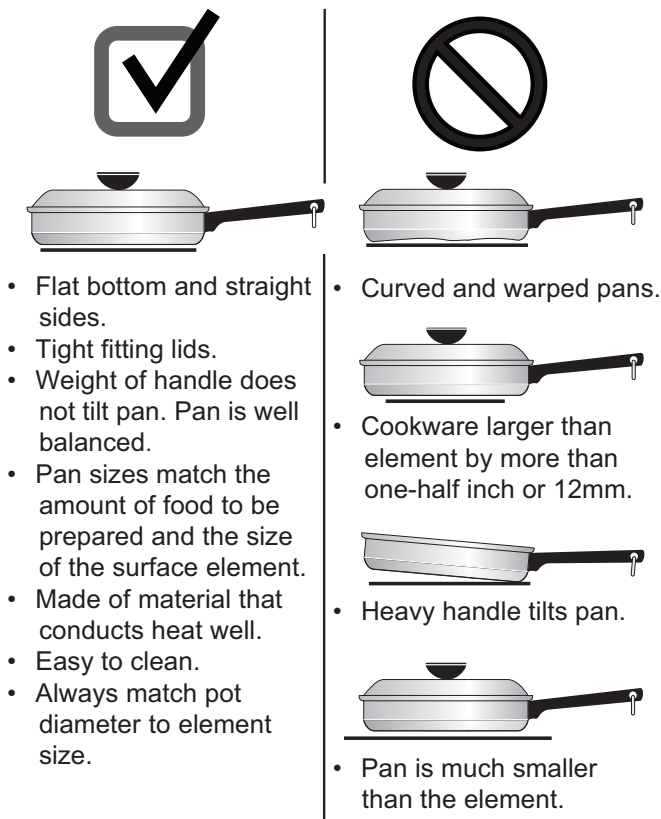

Figure 2: Proper cookware

Cookware Material Types

The cookware material determines how evenly and quickly heat is transferred from the surface element to the pan bottom. The most popular materials available are:

- **Aluminum** - Excellent heat conductor. Some types of food will cause it to darken (Anodized aluminum cookware resists staining and pitting).
- **Copper** - Excellent heat conductor but discolors easily (see Aluminum).
- **Stainless** - Slow heat conductor with uneven cooking results. Durable, easy to clean, and resists staining.
- **Cast Iron** - A slow heat conductor, but will retain heat very well. Cooks evenly once cooking temperature is reached.
- **Porcelain-enamel on metal** - Heating characteristics will vary depending on base material.
- **Glass** - Slow heat conductor.

IMPORTANT: Do not place empty aluminum, glass, or porcelain-enamel coated cookware on the element. The melting point of cookware made with these materials may be reached quickly, especially if left empty. If the cookware melts it will damage the cooktop. Follow all the cookware manufacturer's recommendations for use and care of cookware.

IMPORTANT: NEVER place or straddle a cooking utensil over two different surface cooking areas at the same time. Incorrect use may damage the cooktop.

About the Radiant Surface Elements

The element temperature rises gradually and evenly. As the temperature rises, the element will glow red. To maintain the selected setting the element will cycle on and off. The heating element retains enough heat to provide a uniform and consistent heat during the off cycle.

For efficient cooking, turn the element off several minutes before cooking is complete. This will allow residual heat to complete the cooking process.

⚠ CAUTION Surface elements may appear to have cooled after they have been turned off. **The element surface may still be hot**, and burns may occur if the element or surrounding area is touched before it has cooled to a safe temperature.

⚠ CAUTION **Do not** place flammable items such as plastic salt and pepper shakers, spoon holders, or plastic wrapping on top of the range when it is in use. These items could melt or ignite. Potholders, towels, or wooden spoons could catch fire if placed too close to the surface elements.

⚠ CAUTION **Do not** use aluminum foil to line surface drip bowls or reflector pans. Improper installation of these liners may result in risk of electric shock or fire.

Important notes:

- Radiant elements have a limiter that allows the element to cycle on and off, even at the HI setting.
- Be sure to read detailed instructions for coil cooktop cleaning in the [“Care and Cleaning”](#) section and [“Before You Call”](#) checklist section of this *Use and Care Guide*.
- **Do not** allow aluminum foil, or any material that can melt, to make contact with the cooking element. If these items melt on the cooktop, they will damage the cooktop.

Element On and Hot Surface Indicator Lights

The ELEMENT ON indicator light will turn on when one or more elements are turned on.

A quick glance at this indicator light when cooking is finished is an easy check to be sure all surface elements are turned off.

The HOT SURFACE indicator light will turn on when the burner is hot enough to cause burns and will remain on after the burner is turned off until the surface has cooled to a safe temperature.

ELEMENT ON 

Figure 3: Element indicator light

Setting Surface Controls

Radiant surface elements

To operate the radiant element:

1. Place correctly sized cookware on the radiant surface element.
2. Push in and turn the surface control knob in either direction (Figure 1) to the desired setting (refer to the “Suggested radiant surface element settings” table, Table 1).
3. When cooking is complete, turn the radiant surface element OFF before removing the cookware.

Start most cooking operations on a higher setting and then turn to a lower setting to finish cooking. The surface control knobs do not have to be set exactly on a particular spot. Use the graphics provided as a guide and adjust the control knob as needed (see Figure 1). A glowing red surface heating area extending beyond the bottom edge of the cookware indicates the cookware is too small for the surface heating area.

Suggested radiant surface element settings

The suggested settings found in Table 1 below are based on cooking with medium-weight aluminum pans with lids. Settings may vary when using other types of pans.

Settings	Type of Cooktop
High (HI - 9)	Start most foods, bring water to a boil, pan broiling
Medium High (7 - 8)	Continue a rapid boil, fry, deep fat fry
Medium (5 - 6)	Maintain a slow boil, thicken sauces and gravies or steam vegetables
Medium Low (2 - 4)	Keep foods cooking, poach, stew
Low (1)	Low temperature cooking
Low (LO)	Keep warm, melt

Table 1: Suggested settings for radiant elements

Important note: Do not allow aluminum foil or ANY material that can melt to make contact with the radiant surface element. If these items melt on the cooktop, they will damage the cooktop.

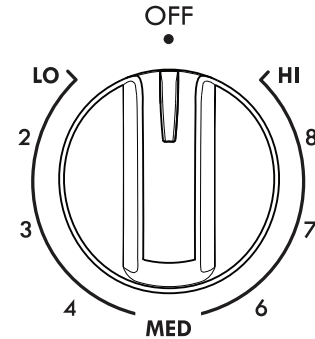

Figure 1: Surface control knob

CAUTION Radiant surface elements may appear to have cooled after they have been turned off. **The element may still be hot** and burns may occur if the element is touched before it has cooled sufficiently.

CAUTION Do not place flammable items such as plastic salt and pepper shakers, spoon holders, or plastic wrappings on top of the range when it is in use. These items could melt or ignite. Potholders, towels, or wooden spoons could catch fire if placed too close to the surface elements.

CAUTION Do not use aluminum foil to line surface drip bowls or reflector pans. Improper installation of these liners may result in risk of electric shock or fire.

Important notes:

- The size and type of utensil used and the amount and type of food being cooked will influence the setting needed for best cooking results.
- The Element ON indicator lights will glow when one or more elements are turned ON. A quick glance at these indicator lights when finished cooking is an easy check to be sure all control knobs are turned OFF. The Hot Surface indicator light will remain on AFTER the control knob is turned to the “OFF” position and will stay on until the heating surface area has cooled sufficiently.

Home Canning

Be sure to read and observe all the following points when home canning with your appliance. Check with the USDA (United States Department of Agriculture) Web site and be sure to read all the information they have available as well as follow their recommendations for home canning procedures.

- Use only a completely flat bottom canner with no ridges that radiate from the bottom center when home canning. Heat is spread more evenly when the bottom surface is flat. Use a straight-edge to check canner bottom.
- Make sure the diameter of the canner does not exceed 1 inch beyond the surface element markings or burner.
- It is recommended to use smaller diameter canners on electric coil and ceramic glass cooktops and to center canners on the burner grates.
- Start with hot tap water to bring water to boil more quickly.
- Use the highest heat setting when first bringing the water to a boil. Once boiling is achieved, reduce heat to lowest possible setting to maintain that boil.
- Use tested recipes and follow instructions carefully. Check with your local Cooperative Agricultural Extension Service or a manufacturer of glass jars for the latest canning information.
- It is best to can small amounts and light loads.
- Do not leave water bath or pressure canners on high heat for an extended amount of time.

Before Setting Oven

Oven Vent Location

The oven is vented as shown below. When the oven is on, warm air is released through the vent. This venting is necessary for proper air circulation in the oven and good baking results. Do not block oven vent. Never close off the openings with aluminium foil or any other material. Steam or moisture may appear near the oven vent. This is normal.

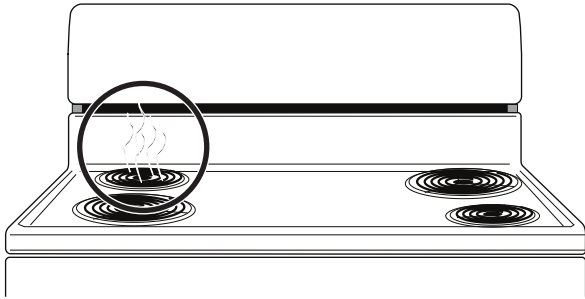

Figure 1: Oven vent

⚠ WARNING -Protective Liners — **Do not** use aluminum foil or any other material or liners to line the oven bottom, walls, racks or any other part of the range. Doing so will alter the heat distribution, produce poor baking results, and possibly cause permanent damage to the oven interior. Improper installation of these liners may result in risk of electric shock or fire.

⚠ CAUTION - Always use pot holders or oven mitts when using the oven. When cooking, the oven interior, oven exterior, oven racks, and cooktop will become very hot which can cause burns.

⚠ CAUTION - To prevent possible damage to the oven, do not attempt to close the oven door until all the oven racks are fully positioned back inside the oven cavity

Types of oven racks

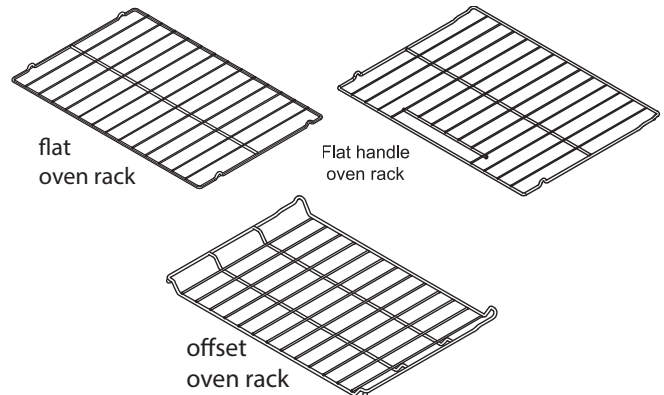

Figure 2: Oven rack types

- **Flat oven racks** may be used for most cooking needs and may be placed in most oven rack positions.
- The **offset oven rack** (some models) provides additional step down positions from the standard flat rack design. The offset design positions the base of the rack about $\frac{1}{2}$ of a rack position lower than the flat rack and may be used in most oven rack positions. To maximize oven cooking space, place the bottom oven rack in the lowest rack position for baking or roasting large cuts of meat.

Removing, replacing, and arranging flat or offset oven racks

Always arrange the oven racks when the oven is cool.

To remove - Pull the oven rack straight forward until it reaches the stop position. Lift up front of oven rack slightly and slide out.

To replace - Place the oven rack on the rack guides on both sides of oven walls. Tilt the front of oven rack upward slightly and slide the oven rack back into place. Be sure oven racks are level before using.

Oven Controls

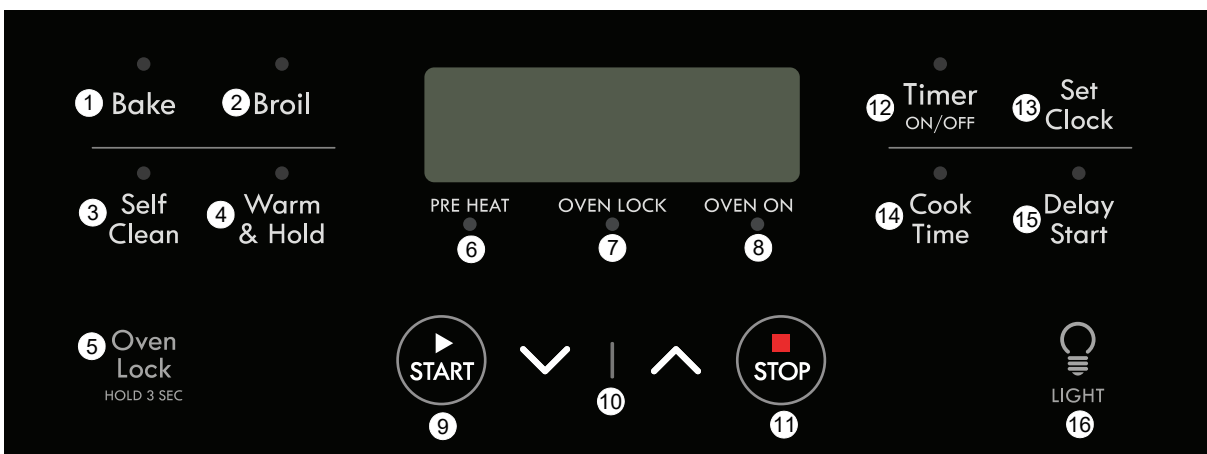



1. **Bake** - Selects Bake function.
2. **Broil** - Selects Broil function.
3. **Self Clean** - Use to select 2, 3, or 4hr Self-Clean cycle.
4. **Warm & Hold** - Use to keep cooked food warm and at serving temperature for up to 3 hours.
5. **Oven Lock** - Use to lock oven door and oven functions.
6. **PREHEAT indicator light** - Is on when oven is preheating. Stays on until the oven reaches the desired temperature.
7. **OVEN LOCK indicator light** - Is on when door locks or unlocks and when oven lockout is active.
8. **OVEN ON indicator light** - Glows each time the oven cycles on to maintain the set oven temperature.
9. **START** - Use to start all cooking functions.
10. **Up / Down arrows** - Use with the function keys to accept settings and adjust temperature and times.
11. **STOP** - Cancels any active oven function except clock and timer.
12. **Timer Set/Off** - Use to set and cancel the timer and to set the Continuous Bake feature.
13. **Set Clock** - Use with arrow keys to set time of day.
14. **Cook Time** - Use to set a specific amount of time needed for cooking. Automatically cancels cooking process at end of set time.
15. **Delay Start** - Use with Bake and Self Clean functions to program a delayed start bake or delayed start self clean cycle.
16. **LIGHT** - Use to turn internal oven light on and off.

Setting Clock

When the appliance is first powered up or when the power supply to the appliance has been interrupted, **12:00** will flash in the display. The time of day must first be set before operating the oven.



To set the clock

1. Press **Set Clock** once. **CLO** appears in display.
2. Press  or  and the time appears in the display. Continue to hold arrow key until the correct time of day appears in the display.
3. Press **START** to accept time of day.

Important note:

The time of day cannot be changed when the oven is set for cooking.

Silent or audible control mode



1. Press and hold **Delay Start** until the control beeps once (about 3 seconds). The present mode appears as **OFF** (silent operation) or **ON** (for audible operation).
2. Use  or  to toggle between audible or silent modes. To save press **START** when the desired mode of operation appears in the display

Oven Controls

Changing Temperature Display (°F or °C)

The electronic oven control is set to display °F (Fahrenheit) when shipped from the factory. The display may be changed to show either Fahrenheit or °C (Celsius) oven temperatures.

To change temperature display mode from °F to °C or from °C to °F

1. Press **Broil**. **HI** appears in the display.
2. Press and hold **Broil** until **F** or **C** appears in the display.
3. Press either  or  to toggle between **F** or **C** mode choices.
4. Press **START** to accept change. The display will return to the time of day.

Important note:

The temperature display mode cannot be changed when the oven is set for cooking.

Oven Lock

The **OVEN LOCK** feature allows you to lock the oven portion of the appliance while the oven is not in use.

To activate OVEN LOCK feature:

1. Be sure the door is completely closed.
2. Press and hold **OVEN LOCK** for 3 seconds. **Loc** will appear in the display. The **OVEN LOCK** indicator light will flash while the motor driven door latch begins locking the oven door. Do not open the door during this time. Allow 15 seconds for the door to completely lock. Once oven door is locked, the time of day will appear in the display.

To cancel the OVEN LOCK feature

1. Press and hold **OVEN LOCK** for 3 seconds. The **OVEN LOCK** indicator light will flash and the motor driven door latch will begin to unlock. Do not open the door at this time. The door will unlock completely in about 15 seconds.
2. The oven control keys will be available and the oven door can be opened again.

Important notes:

- To avoid possible damage to the oven door latch mechanism, do not attempt to open or close the oven door whenever the **OVEN LOCK** indicator light is flashing.
- If a control key is pressed when the **OVEN LOCK** is active, **Loc** will appear in the display as a reminder that the oven keys are inactive when the **OVEN LOCK** feature is active.

Changing between continuous bake setting or 12-Hour Energy Saving feature

The oven control has a factory-preset 12-Hour Energy Saving feature that will turn the oven off automatically if the oven is left on for more than 12 hours. The control may be programmed to override this feature to continuously bake.

To set continuous bake mode or 12hr Energy Saving:



Press and hold **Timer Set/Off** until the control beeps once (about 6 seconds). **-- hr** will appear in display. The control is set for **continuous bake**. Press **Clean** key to toggle between **continuous bake** and **12hr Energy Saving**.



To save the selected mode press **START**. The display will return to idle.

Setting Timer

The timer may be set from 1 minute up to 11 hours and 59 minutes.

To set the timer

1. Press **Timer Set/Off**.
2. Press and hold  to increase the time. Release  when the desired time appears in the display.
3. Press **START** and timer will begin to count down.
4. When the set time has run out, the Timer will sound with 3 beeps and will continue to beep 3 times every 60 seconds until **Timer Set/Off** is pressed.

To change time remaining in Timer, press and hold  or  to increase or decrease any time remaining.

To cancel the Timer before at any time, press **Timer Set/Off** once.

Important notes:





- The timer does not start or stop the cooking process. It serves as an extra timer in the kitchen that will beep when the set time has run out. The timer may be used alone or when any other oven function is active.
- The indicator light located above **Timer Set/Off** will glow when the timer is active.
- The timer will display hours and minutes until 1 hour remains. When less than 1 hour remains, the display will count down in minutes and seconds. Once the timer has less than 1 minute remaining only seconds will display.
- If the timer is active when oven cooking, the minute timer will show in the display by default. To view information of any other active oven function, press the key once for the active function to view status.

Setting Bake

Use the bake function whenever the recipe calls for baking using normal temperatures. A reminder tone will sound when the set bake temperature is reached. Bake may be programmed for any temperature from 170°F to 550°F (77°C to 288°C). The factory preset bake temperature is 350°F (177°C).



⚠ CAUTION Always use pot holders or oven mitts when using the oven. When cooking the oven interior, oven racks and cook-top will become very hot which can cause burns.

To set Bake

1. Arrange oven racks and close oven door.
2. Press **Bake**. — — —° appears in display.
3. Within 15 seconds, press  or . The display will show the default oven temperature of 350°F (177°C). By pressing  or , the oven temperature may be adjusted in 5°F increments (1°C if the control is set to display Celsius).
4. Press **START** when desired temperature appears, the oven will begin heating to the selected temperature. When the oven temperature reaches the set temperature, the PRE-HEAT indicator light will turn off and the oven control will beep 3 times.

To cancel bake at anytime Press .

To change the oven temperature after Bake has started

1. Press **Bake**. The current set oven temperature will display.
2. Press  or  to increase or decrease the current set temperature to the new oven temperature.

Important notes:

- The oven will bake no longer than 12 hours. If you wish to bake for a longer period, see **Changing between continuous bake setting or 12-Hour Energy Saving mode** for detailed information.
- Dark or dull pans absorb more heat than shiny bakeware, resulting in dark or over-browning of foods. It may be necessary to reduce the oven temperature or cook time to prevent over-browning of some foods. Dark pans are recommended for pies; shiny pans are recommended for cakes, cookies and muffins.

Baking tips

- Fully preheat the oven before cooking items like cookies, biscuits and breads.
- When using any single rack, position the rack so that the food is in the center of the oven.
- For best results when baking cakes using two oven racks, place racks in positions 3 and 6. (Figure 2)
- Dark or dull bakeware absorbs more heat than shiny bakeware. It may be necessary to reduce oven temperature and cook time to prevent overbrowning of some foods. Dark bakeware is recommended for pies. Shiny bakeware is recommended for cakes, cookies, and muffins.
- For best results when baking cakes or cookies using 2 oven racks, place cookware in rack positions 3 & 6 and pans as shown in Figure 1

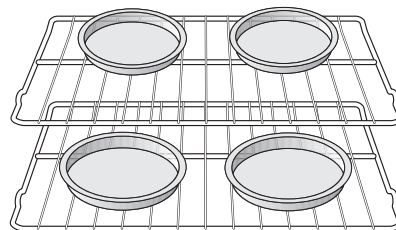

Figure 1: Baking on multiple levels

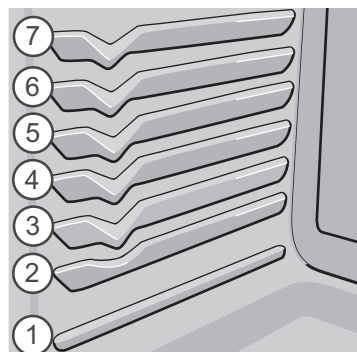

Fig. 2 Oven rack positions







Oven Controls

Setting Cook Time

Use Cook Time to set the amount of time needed for baking. The oven will turn on immediately and stop automatically after the set cook time ends.



⚠ WARNING FOOD POISONING HAZARD. Do not let food sit for more than one hour before or after cooking. Doing so can result in food poisoning or sickness.

To program the oven to begin baking immediately and to shut off automatically

1. Be sure that the clock displays the correct time of day.
2. Arrange oven racks and close oven door.
3. Press **Bake**. **350 °** appears in display.
4. Within 15 seconds, press  or . The display will show the default oven temperature of 350°F (177°C). By pressing  or , the temperature may be adjusted in 5°F increments (1°C if the control is set to display Celsius). Press **START** to accept.
5. Press **Cook Time::00** will appear in display.
6. Press  or  to reach the desired cook time.
7. Press **START** to accept. When the oven temperature reaches the set temperature, the **PREHEAT** indicator light turns off and the oven control will beep once.
8. To cancel at anytime press .

When the cook time runs out **End** will appear in the display. The oven control will beep 3 times every minute as a reminder until **STOP** is pressed.

To change the oven temperature or cook time after baking has started

1. Press **Bake** (for oven temperature) or **Cook Time**.
2. To adjust temperature or cook time press  or  and release when the desired temperature or cook time setting appears in the display.

Important notes:

- Cook Time and Delay Start may be set with Bake but are not available for use with Broil.
- While baking with Cook Time, press **Cook Time** to display any cook time remaining.
- Cook Time and Delay Start can be set with Bake or Convection (on some models). Cook Time and Delay Start will not operate with Broil function.
- The maximum Cook Time or Delay Start setting is 11 hours and 59 minutes.









Setting Delay Start

Delay Start allows you to set a delayed starting time to the oven baking or cleaning functions.

⚠ WARNING FOOD POISONING HAZARD. Do not let food sit for more than one hour before or after cooking. Doing so can result in food poisoning or sickness. Foods that can easily spoil such as milk, eggs, fish, meat or poultry, should be chilled in the refrigerator first. Even when chilled, they should not stand in the oven for more than 1 hour before cooking begins, and should be removed promptly when finished cooking.



⚠ CAUTION Always use pot holders or oven mitts when using the oven. When cooking the oven interior, oven racks and cook-top will become very hot which can cause burn

To program oven for a delayed starting time and to shut off automatically

1. Be sure that the clock displays the correct time of day.
2. Arrange oven racks and close oven door.
3. Press **Bake**. **350 °** appears in display.
4. Within 15 seconds, press  or . By pressing  or , the oven temperature may be adjusted in 5°F increments (1°C if the control is set to display Celsius). When desired temperature is reached press **START** to accept.
5. Press **Cook Time::00** will appear in display.
6. Press the  or  to set the desired cook time. Then press **START** to accept.
7. Press **Delay Start**. The time of day will appear in the display. Press  or  until the desired starting time appears in the display and press **START**.
8. The oven will turn on at the set delayed starting time and begin heating. When the oven temperature reaches the set temperature, the **PREHEAT** indicator light will turn off and the oven control will beep 3 times.

To cancel at anytime press .

To change the oven temperature or cook time after baking has started

1. Press **Bake** (for oven temperature) or **Cook Time**.
2. Press  or  and release when the desired temperature or cook time setting appears in the display.

When the cook time runs out:

End will appear in the display. The oven control will beep 3 times every minute until  is pressed.

Setting Broil

Use the broil function to cook meats that require direct exposure to flame heat for optimum browning results. The Broil function is factory preset to broil at 550°F. The suggested broil settings are recommendations only. Increase or decrease broiling times, or move to a different rack position to suit for doneness.

To set Broil

1. Arrange the oven racks when cool. For optimum browning results, preheat oven for 2 minutes before adding food.
2. Position cookware in oven. Leave door open at broil stop position.

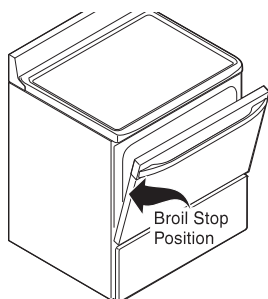





Fig. 3 Door open for broiling

3. Press **Broil**. **HI** will appear in display.
4. Press  or  until the desired broil setting level appears in the display. Press  for **HI** broil or  for **LO** broil setting.
5. Press **START**. Broil on one side until food is browned. Turn and broil food on other side. When finished broiling press **STOP**.

CAUTION Always use pot holders or oven mitts when using the oven. When cooking the oven interior, oven racks and cook-top will become very hot which can cause burns.

WARNING Should an oven fire occur, close the oven door and turn the oven off. If the fire continues, use a fire extinguisher. Do not put water or flour on fire. Flour may be explosive.

Important notes:

- Always arrange oven racks when the oven is cool.
- For best results when broiling, use a broil pan with broil pan insert designed to drain the fat from the food and help avoid spatter and reduce smoking. If a broiler pan and insert are not supplied with this appliance, they may be purchased from Sears. Call 1-844-553-6667 and order broiler pan kit 5304442087.
- When broiling, always pull the oven rack out to the stop position before turning or removing food..

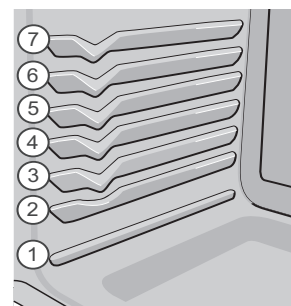
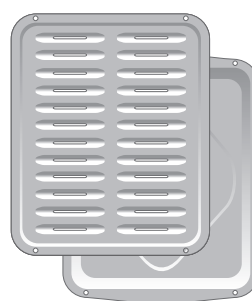

Fig. 4 Broiler pan and insert Fig. 5 Rack positions

Table 1: Suggested Broil Settings

Food	Rack Position	Setting	Cook time in minutes		Doneness
			1st side	2nd side	
Steak, 1 inch thick	6th or 7th*	Hi	8	6	Medium
Steak, 1 inch thick	5th or 6th*	Hi	10	8	Medium-well
Steak, 1 inch thick	5th or 6th*	Hi	11	10	Well
Pork Chops, 3/4 inch thick	5th	Hi	12	8	Well
Chicken, bone-in	5th	Lo	25	15	Well
Chicken, boneless	5th	Lo	10	8	Well
Fish	5th	Hi	as directed		Well
Shrimp	4th	Hi	as directed		Well
Hamburger, 1 inch	5th or 6th	Hi	12	10	Medium

Cook times are suggestions and should only be used as a guide.

Oven Controls

Warm & Hold™





Warm & Hold will keep cooked foods warm and ready for serving for up to 3 hours after cooking has finished. After 3 hours the Warm & Hold will shut off automatically. Warm & Hold should only be used with foods that are already at serving temperatures. Warm & Hold will maintain the oven temperature at 170° F (77°C).

Example - To set Warm & Hold:

- If needed, arrange oven racks and place cooked food in oven.
- Press **Warm & Hold**. **Hld** will appear in the display. If no other keys are touched within 25 seconds the request for Warm & Hold will clear.
- Press **START**. Warm & Hold will automatically turn off after 3 hours.

To turn Warm & Hold off at any time press .

To set Warm & Hold to start after a Timed Bake automatically

1. Press **Bake**. Press  or  to set temperature.
2. Press **START**.
3. Press **Cook Time**. Press  or  to set time.
4. Press **START**.
5. Press **Warm & Hold**.
6. Press **START**. Warm & Hold is set to turn on automatically after the Timed Bake or Delay Timed Bake has finished. The Warm & Hold indicator light will glow indicating that the Warm & Hold feature is set to start when the timed bake is finished.

Operating Oven Light

The oven light will automatically turn on when the oven door is opened.

Press **OVEN LIGHT** on the control panel to turn the oven light on or off whenever the oven door is closed. Oven light will not operate during the self clean cycle.

The oven light is located at the upper left rear wall of the oven interior and is covered with a glass shield held in place by a wire holder. The glass shield protects the bulb from high temperatures and should always be in place when the oven is in use.



To replace the interior oven light see **Replacing oven light** in the **Care and Cleaning** section.

Adjusting oven temperature



Your appliance has been factory calibrated and tested to ensure an accurate baking temperature. For the first few uses, follow your recipe times and temperature recommendations carefully. If you think the oven is cooking too hot or too cool for your recipe times, you may adjust the **UPO** (user programmable offset) so the oven cooks hotter or cooler than the oven temperature displayed.

The oven temperature may be increased as much as +35 °F (+19 °C) or decreased -35 °F (-19 °C) from the factory calibrated settings.

To adjust oven temperature

1. Press **Bake**. and hold for 3 seconds. The UPO value will appear in the display with a degree sign.
2. The display now indicates the amount of degrees offset from the original factory temperature setting. If the control still has the original factory calibration, the display will read 0.
3. The temperature may be adjusted up or down 35 °F (19°C), in 1°F increments by pressing and holding  or . Adjust until the desired amount of temperature offset appears in the display and press **START** to save.
4. If the **STOP** key is pressed during the programming mode, the UPO value will remain unchanged.

Important notes:

- Oven temperature adjustments made will not change the Broil or Self-Clean operating temperatures.
- Do not use oven thermometers such as those found in grocery stores to check the temperature settings inside your oven. These oven thermometers may vary as much as 20 to 40 °F degrees from actual temperatures.
- The oven temperature adjustment may be made if your oven control has been set to display °C (Celsius) temperatures. Minimum and maximum settings for Celsius is plus (+) or minus (-) 19 °C.
- If the display mode is set for Celsius, adjustments made will be in 1 °C increments on each press of  or .

Self Clean

A self cleaning oven cleans itself with high temperatures (well above normal cooking temperatures) which eliminate soils completely or reduces them to a fine powdered ash you can wipe away afterwards with a damp cloth.

The Self Clean function allows you to select 3 different cleaning times from 2, 3 or 4 hours. A 3-hour cleaning time is best used for normal cleaning; 2-hour time for light soils and a 4-hour clean time for heavier stubborn soils.

Read before starting Self Clean

Be sure to read all following caution and important statements before starting a self clean cycle

⚠ WARNING Do not leave small children unattended near appliance. During self clean cycle the outside of the oven can become very hot and cause burns if touched.

⚠ WARNING Do not line the oven walls, racks, oven bottom or any part of the range with aluminum foil. This will cause permanent damage to the oven interior and destroy heat distribution, and will melt to the oven interior.

⚠ WARNING Do not force the oven door open. This will damage the automatic door locking system. Use caution when opening the oven door after the self clean cycle ends. The oven may still be very hot and cause burns. To avoid possible burns stand to side of oven when opening door to allow steam or hot air to escape.

The health of some birds is extremely sensitive to fumes given off during the self clean cycle of any range. Move birds to a well ventilated room.

Important notes:

- Completely remove all oven racks and any accessories from oven cavity to avoid damage to oven racks. If the oven racks are not removed they may discolor. Remove all items from the oven and cooktop including cookware, utensils and any aluminum foil. Aluminum foil will not withstand high temperatures from a self clean cycle and will melt.
- Do not use oven cleaners or oven protective coatings in or around any part of the oven interior. Clean any soil from the oven frame, the door liner outside the oven door gasket and the small area at the front center of the oven bottom (Figure 6). These areas heat sufficiently to burn soil on. Clean using soap and water prior to starting Self Clean.

- Remove any excessive spills. Any spills on the oven bottom should be wiped up and removed before starting a self clean cycle. To clean use hot, soapy water and a cloth. Large spills can cause heavy smoke or fire when subjected to high temperatures. Do not allow food spills with high sugar or acid content (such as milk, tomatoes, sauerkraut, fruit juices or pie fillings) to remain on the surface as they may leave a dull spot even after cleaning.

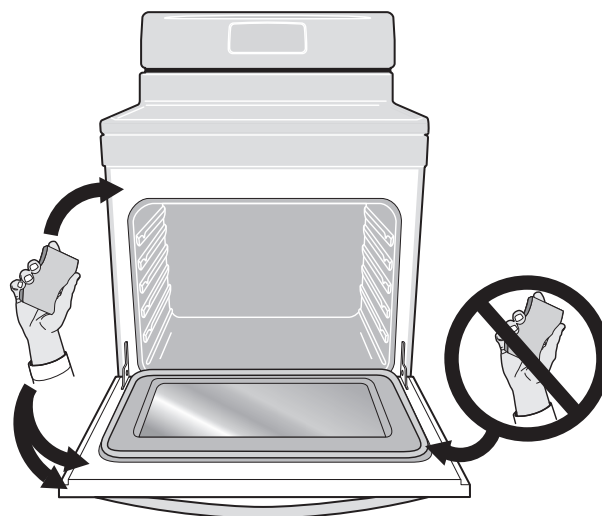

Fig. 6 Areas to clean and to avoid

- Do not clean the oven door gasket (figure). The woven material in the gasket is essential for a good seal. Care should be taken not to rub, damage or remove the oven door gasket. Doing so could cause damage to the door gasket and compromise the performance of the oven.



Important notes:

- The kitchen area should be well ventilated using an open window, ventilation fan or exhaust hood during the 1st self clean cycle. This will help eliminate the normal odors associated with the 1st self clean cycle.
- Do not attempt to open the oven door when the OVEN LOCK indicator light is flashing. Allow about 15 seconds for the motorized door latch mechanism to completely lock or unlock the oven door.
- When the clean time finishes the oven door will remain locked until the range has cooled sufficiently. In addition to the clean time that was programmed, you must allow about 1 additional hour for the oven to cool before you will be able to open the oven door.
- The Self Clean function will not operate whenever a radiant surface element is ON or the oven lockout is active.

Oven Controls

Setting Self Clean

To set Select Clean to start immediately:

1. Be sure the oven is empty and all oven racks are removed. Remove all items from the cooktop. Be sure the oven door is completely closed.
2. Press **Self Clean**. **3:00** appears in the display.
3. Press  to change to a 2 hour clean time. To select a 4 hour clean time press  : **4:00** appears in the display.
4. After selecting the clean time press **START** to activate the self clean. The **OVEN LOCK** indicator light will light and **CLn** will appear in the display.

When Self Clean begins the cleaning cycle, the motorized door latch mechanism will automatically start to lock the oven door and the **OVEN LOCK** indicator light will flash. Do not open the oven door when the **OVEN LOCK** indicator light is flashing. Allow about 15 seconds for the oven door to completely lock.

Once the oven door has locked the **OVEN LOCK** indicator light will glow steady. When **CLn** will appear in the display Self Clean is active.



⚠ CAUTION Use caution when opening the oven door after self cleaning. The oven may still be **VERY HOT** and can cause burns. To avoid possible burns stand to the side of the oven when opening the oven door to allow hot air or steam to escape.

When Self Clean is finished:

1. The time of day will appear in the display window and the **OVEN LOCK** indicator light will continue to glow.
2. Once the oven has cooled down (about 1 hour) the oven control will beep and the **OVEN LOCK** indicator light will turn off. The oven door may now be opened.
3. When the oven interior has completely cooled, wipe away any residue or powdered ash with a damp cloth or paper towel.

Delayed Start Self Clean:

To start Delay Start Self Clean:

1. Be sure the oven is empty and all oven racks are removed. Remove all items from the cooktop. Be sure oven door is completely closed.
2. Be sure the clock shows the correct time of day.
3. Press **Delay Start**.
4. Press and hold  to scroll to the time desired to start the self clean cycle. Press **START** when the desired start time is displayed.
5. Press **Self Clean**. **3:00** appears in the display.
6. To select a 2 hour clean time press  ; **2:00** appears in the display. To select a 4 hour clean time press  ; **4:00** appears in the display.
7. After selecting the desired clean time press **START**. Self Clean is set to activate. The **OVEN LOCK** indicator light will turn on and the oven door will lock in advance of the starting time. Once the starting time is reached **CLn** will appear in the display.

If it becomes necessary to stop Self Clean when active

1. Press .
2. If Self Clean has heated the oven to a high temperature, allow enough time for the oven to cool and for the **OVEN LOCK** indicator light to turn off. When this indicator light turns off the oven door may be opened.
3. Restart Self Clean if needed.

Important notes:

- If Self Clean is active and a power failure occurs, the oven may not have thoroughly cleaned. This would depend on how much cleaning time had elapsed before the power failure. If needed after power is restored, set Self Clean again.

Care and Cleaning

Remove spills and any heavy soiling as soon as possible. Regular cleaning will reduce the difficulty of major cleaning later.

⚠ CAUTION Before cleaning any part of the appliance, be sure all controls are turned off and the appliance is cool.

⚠ CAUTION If ammonia or appliance cleaners are used, they must be removed and the appliance must be thoroughly rinsed before operating. Follow manufacturer's instructions and provide adequate ventilation.

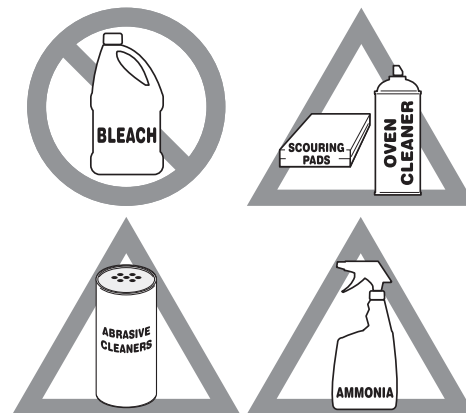

Figure 1: Use cleaners with caution

Surface or Area	Cleaning Recommendation
Aluminum and vinyl	Using a soft cloth, clean with mild dish detergent and water. Rinse with clean water, dry and polish with a soft, clean cloth.
Painted and plastic control knobs Painted body parts Painted decorative trims	Using a soft cloth, clean with mild dish detergent and water or a 50/50 solution of vinegar and water. Rinse with clean water, dry and polish with a soft, clean cloth. Glass cleaners may be used, but do not apply directly to surface; spray onto cloth and wipe.
Control panel	Using a soft cloth, clean with mild dish detergent and water or a 50/50 solution of vinegar and water. Do not spray liquids directly on the oven control and display area. Do not use large amounts of water on the control panel - excess water on the control area may cause damage to the appliance. Do not use other liquid cleaners, abrasive cleaners, scouring pads, or paper towels - they will damage the finish.
Control knobs	Using a soft cloth, clean with mild dish detergent and water or a 50/50 solution of vinegar and water. To remove control knobs: turn to the OFF position, grasp firmly, and pull off the shaft. To replace knobs after cleaning, line up the OFF markings and push the knobs into place.
Stainless Steel	Using a soft cloth, clean with mild dish detergent and water or a 50/50 solution of vinegar and water. Rinse with clean water, dry with a soft clean cloth. Do not use cleaners containing abrasives, chlorides, chlorine, or ammonia.
Easy Clean Stainless Steel Black Stainless Steel	Using a soft cloth, clean with mild dish detergent and water or a 50/50 solution of vinegar and water. Rinse with clean water, dry with a soft clean cloth. Do not use appliance cleaner, stainless steel cleaner, or cleaner containing abrasives, chlorides, chlorine, or ammonia. These cleaners may damage the finish.
Porcelain-enameled broiler pan and insert Porcelain door liner Porcelain body parts	Rinse with clean water and a damp cloth. Scrub gently with a soapy, non-abrasive scouring pad to remove most spots. Rinse with a 50/50 solution of clean water and ammonia. If necessary, cover difficult spots with an ammonia-soaked paper towel for 30 to 40 minutes. Rinse and wipe dry with a clean cloth. Remove all cleaners or future heating could damage the porcelain. Do not allow food spills with a high sugar or acid content (milk, tomatoes, sauerkraut, fruit juices or pie filling) to remain on porcelain surfaces. These spills may cause a dull spot even after cleaning.
Self-cleaning oven interior	Before setting a self-clean cycle, clean soils from the oven frame, areas outside the oven door gasket, and the small area at the front center of the oven bottom. See "Self Clean" on page 23.

Care and Cleaning

Surface or Area	Cleaning Recommendation
Oven door	<p data-bbox="542 239 1503 428">Use mild dish detergent and water or a 50/50 solution of vinegar and water to clean the top, sides, and front of the oven door. Rinse well. Glass cleaner may be used on the outside glass of the door. Ceramic smoothtop cleaner or polish may be used on the interior door glass. Do not immerse the door in water. Do not spray or allow water or cleaners to enter the door vents. Do not use oven cleaners, cleaning powders, or any harsh abrasive cleaning materials on the outside of the oven door.</p> <p data-bbox="542 443 1503 506">Do not clean the oven door gasket. The oven door gasket is made of a woven material which is essential for a good seal. Do not rub, damage, or remove this gasket.</p>
Coil surface elements and drip bowls	See "Surface elements and drip bowls" on page 27 .

Surface elements and drip bowls

Your cooking product includes a new generation of electric coil element. This electric coil element design follows/supports a change made to the UL Standard for Household Electric Ranges related to cooktop surface temperature detection. If ordering replacement electric coil elements, you must refer to the parts catalog to obtain the correct part number for the electric coil element that was designed to function with the specific model that was purchased.

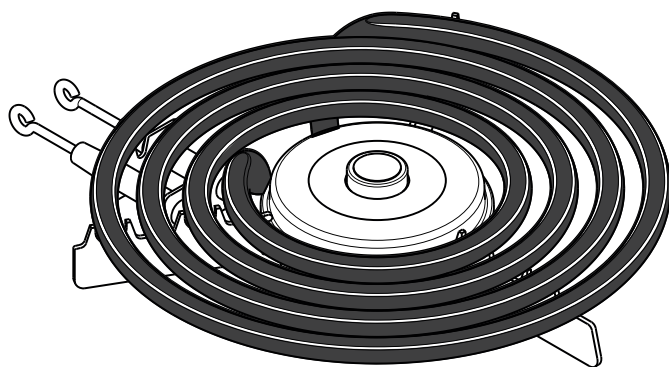

Figure 2: Coil element

CAUTION Make sure drip bowls are in place - Absence of these bowls during cooking may subject wiring or components underneath to damage.

CAUTION Never immerse a surface element in water.

CAUTION Be sure the range is cool before removing surface elements or drip bowls. Be careful not to bend terminal ends when replacing surface elements after cleaning.

CAUTION Protective liners—Do not use aluminum foil to line surface drip bowls or reflector pans. Improper installation of these liners may result in risk of electric shock or fire. Surface elements may be unplugged and removed to make cleaning the drip pans easier. The surface elements clean themselves when they are turned on. Food spilled on a hot element will burn off. Food spilled on a cool element may be cleaned with a damp cloth—any remaining soil will burn off the next time the element is used.

To remove the surface elements and drip bowls:

1. Lift the edge of the drip bowl across from the terminal end. Lift the surface element and drip bowl together just enough to clear the cooktop.
2. While holding the drip bowl and surface element, gently pull the terminal end out from terminal plug. Do not remove the hold-down clip (if equipped) from the drip bowl.

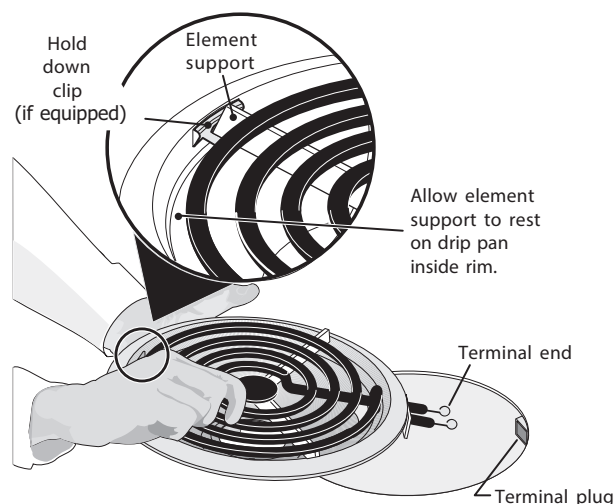

Figure 3: Removing coil and drip bowl

Cleaning drip bowls

Wash in hot, soapy water. Rinse and dry while still warm. Hard to remove, burned-on soil can be removed by soaking the drip bowls for about 20 minutes in a lightly diluted liquid cleanser or a solution of ammonia and water (1/2 cup ammonia to 1 gallon of water). A nylon scrubber may be used after soaking. Do not use abrasive cleaners or steel wool, they will scratch the surface. Always rinse with clean water and polish dry with a soft cloth.

To replace drip bowls and surface elements:

1. Slide the terminal end on the element through the opening in the drip bowl.
2. Align the element support to rest on the rim inside the drip bowl. If your drip bowl is equipped with a hold-down clip, align the element support opposite the terminal end with the slot in the hold-down clip, and snap into place.
3. After the element is positioned in the drip bowl, line up the terminal end with the terminal plug as shown.
4. Hold the surface element and drip bowl together as level as possible and firmly push the terminal end into the terminal plug. Make sure element terminal is seated properly into terminal plug. Make sure the surface element is level to reduce the hazard of cookware sliding off the element.

Care and Cleaning

Aluminum Foil and Utensils

⚠ WARNING Never cover any slots, holes, or passages in the oven bottom or cover an entire oven rack with materials such as aluminum foil. Aluminum foil linings may trap heat, causing a fire hazard.

⚠ WARNING Protective Liners — Do not use aluminum foil to line the oven bottom. Improper installation of these liners may result in risk of electric shock or fire.

Important notes:

- Aluminum foil - Use of aluminum foil on a hot cooktop can damage the cooktop. Do not use thin aluminum cooking utensils or allow aluminum foil to touch the surface elements under any circumstances.
- Aluminum utensils - The melting point of aluminum is much lower than that of other metals. Care must be taken when aluminum pots or pans are used on the cooktop. If aluminum pans are allowed to boil dry when using the cooktop, not only will the utensil be damaged or destroyed, but it may fuse to or permanently damage the coil or cooktop.

Cleaning under bake element (some models)

The bake element is located in the lower oven cavity. For some models, if the lower bake element is visible it may be tilted up for easier access to the oven bottom for cleaning. Remove the oven racks before raising the element. Be careful not to raise the element more than 4 or 5 inches from the resting position.

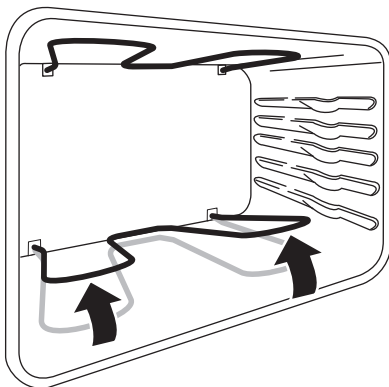

Figure 4: Lift bake element

Cleaning under cooktop (some models)

⚠ CAUTION When lowering the lift-up range cooktop, grasp the sides with fingertips only. Be careful not to pinch fingers. Do not drop or bend the range cooktop when raising or lowering. This could damage the cooktop surface.

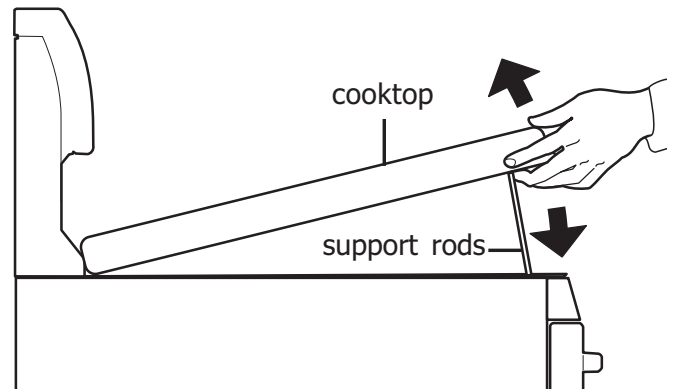

Figure 5: Lifting cooktop

To raise the cooktop for cleaning (some models)

1. Grasp the sides and lift from the front (See [Figure 5](#)). Lift-up rods will support the top in a raised position. Only lift the cook top far enough to allow the support rods to snap into place.
2. Clean underneath using a clean cloth and hot, soapy water.

To lower, hold the cooktop up and gently push back on each rod to release the notched support. Hold the cooktop while slowly sliding the lift rods down into the range frame.

Removing and Replacing the Oven Door:

⚠ CAUTION The door is heavy. For safe, temporary storage, lay the door flat with the inside of the door facing down.

To remove the oven door

1. Open oven door completely, horizontal with floor (See [Figure 6](#)).
2. Pull the door hinge locks on both left and right door hinges down from the oven frame completely towards the oven door (See [Figure 7](#)). A tool such as a small flat-blade screwdriver may be required.
3. Firmly grasp both sides of oven door along the door sides. Do not use the oven door handle (See [Figure 8](#)).
4. Close the door to approximately 10 degrees from the door frame (See [Figure 8](#)).
5. Lift the oven door hinge arms over the roller pins located on each side of the oven frame (See [Figure 9](#)).

To replace the oven door:

1. Firmly grasp both sides of oven door along the door sides. Do not use the oven door handle (See [Figure 8](#)).
2. Holding the oven door at the same angle as the removal position, seat the hook of the hinge arm over the roller pins located on each side of the oven door frame (See [Figure 8](#) and [Figure 9](#)). The hook of the hinge arms must be fully seated onto the roller pins.
3. Fully open the oven door, horizontal with floor (See [Figure 6](#)).
4. Push the door hinge locks up towards and into the oven frame on both left and right oven door hinges to the locked position (See [Figure 7](#)).
5. Close the oven door.

Important note: Special door care instructions - Most oven doors contain glass that can break. Do not hit the glass with pots, pans, or any other object. Scratching, hitting, jarring, or stressing the glass may weaken its structure, causing an increased risk of breakage at a later time. Do not close the oven door until all of the oven racks are fully in place.

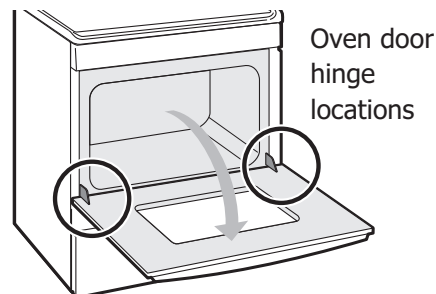

Figure 6: Door hinge location

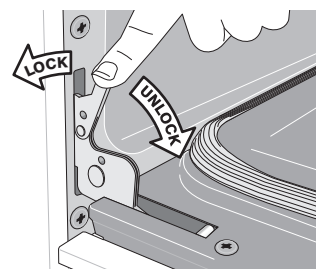

Figure 7: Door hinge locks

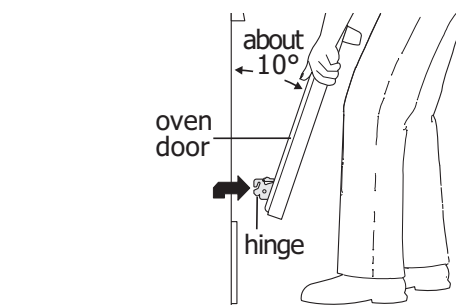

Figure 8: Holding door for removal

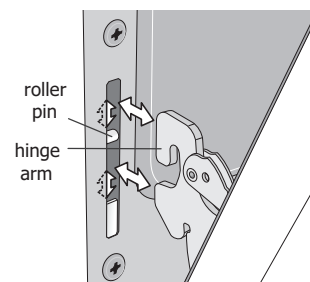

Figure 9: Replacement and location of hinge arm and roller pin

Care and Cleaning

Replacing the Oven Light

⚠ CAUTION Be sure the oven is unplugged and all parts are cool before replacing the oven light.

Replacing the oven interior light bulb:

The interior oven light is located at the rear of the oven cavity (Figure 10).

1. Turn electrical power off at the main source or unplug the appliance.
2. Replace the bulb with a new appliance bulb.
3. Turn the power back on again at the main source (or plug the appliance back in).
4. Be sure to reset the time of day on the clock.

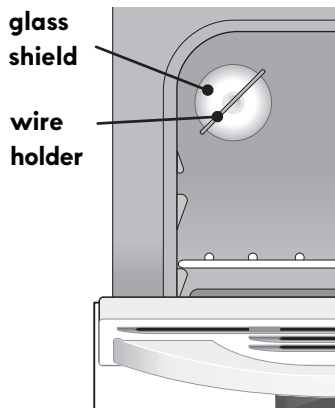

Figure 10: Oven light

To remove and replace storage drawer (some models)

Use the storage drawer for storing cooking utensils. The drawer can be removed to facilitate cleaning under the range. Use care when handling the drawer.

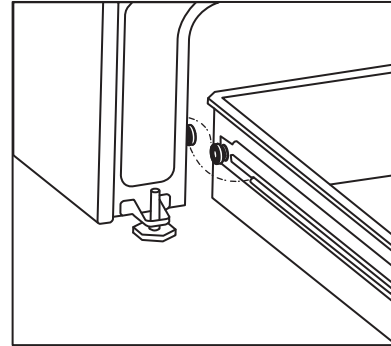

Figure 11: Open storage drawer

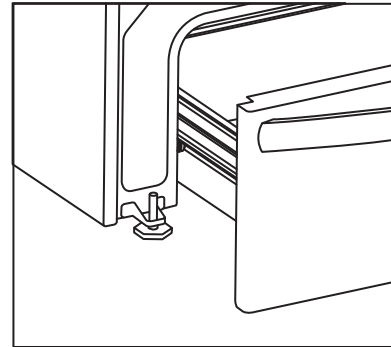

Figure 12: Closed storage drawer

Before You Call

Solutions to Common Problems:

Before you call for service, review the following list. It may save you time and expense. Possible solutions are provided with the problem listed.

Problem	Cause / Solution
Entire appliance does not operate.	Appliance not connected. Make sure power cord is plugged properly into outlet. Check your fuse box or breaker box to make sure the circuit is active. Electrical power outage. Check house lights to be sure. Call your local electric company for service outage information.
Oven Problems	
Poor baking results.	Many factors affect baking results. Use proper oven rack position. Center food in the oven and space pans to allow air to circulate. Preheat the oven to the set temperature before placing food in the oven. Try adjusting the recipe's recommended temperature or baking time. See "Adjusting oven temperature" on page 22 if you feel the oven is too hot or too cool.
Flames inside oven or smoking from oven vent.	Excessive spills in oven. Grease or food spilled onto the oven bottom or oven cavity. Wipe up excessive spills before starting the oven. If flames or excessive smoke are present when using broil, see "Setting Broil" on page 21 .
Oven smokes excessively when broiling.	Incorrect setting. Follow the "Setting Broil" instructions on page 21 . Meat too close to the broil element or burner. Reposition the broil pan to provide proper clearance between the meat and broil element or burner. Remove excess fat from meat. Cut remaining fatty edges to prevent curling, but do not cut into lean. Grease build up on oven surfaces. Regular cleaning is necessary when broiling frequently. Grease or food splatters will cause excessive smoking.
Oven control panel beeps and displays any F or E code error.	Oven control has detected a fault or error condition. To clear the error, press the OFF key on the control panel. Once the error code is cleared, try the bake or broil function. If the F or E code error repeats, turn off the power to appliance, wait 5 minutes, and then repower the appliance. Set the clock with correct time of day. Try the bake or broil function again. If the fault recurs, press the OFF key to clear.
Oven portion of appliance does not operate.	The time of day is not set. The clock must be set in order to operate the oven. See "Setting Clock" on page 17 . Be sure the oven controls are set properly for the desired function. See "Oven Controls" starting on page 17 and review instructions for the desired cooking function in this manual or see "Entire appliance does not operate." in this checklist.
Cooktop Problems	
Surface element is too hot or not hot enough.	Incorrect surface control setting. Adjust power level setting.
Surface element does not heat or does not heat evenly.	Be sure the correct surface control knob is turned on for the element needed. Cookware is light weight or warped. Use only flat, evenly balanced, medium or heavyweight cookware. Flat pans heat better than warped pans. Cookware materials and weight of the material affect heating. Heavy and medium-weight pans heat evenly. Because lightweight pans heat unevenly, foods may burn easily.
Drip bowls are pitting or rusting.	Foods with acids, such as tomatoes, will cause corrosion if allowed to stand in/on bowls. When cool, remove and wash drip bowls as soon as possible after a spill. Normal environment - Houses located along sea coasts are exposed to salt air. Protect bowls as much as possible from direct exposure to salt air.

Before You Call

Problem	Cause / Solution
Drip bowls have changing or distorting colors.	Bottom of cookware extends beyond surface element and touches cooktop surface. This can cause high enough temperatures to discolor drip bowls. DO NOT use cookware of this type. Pan sizes should match the size of the element. Replacement drip bowls may be purchased from your appliance dealer.
Self Clean Problems	
Self clean does not work	Oven control not set properly. See "Self Clean" on page 23
Oven racks discolored or do not slide easily	Oven racks left in oven cavity during self clean. Remove oven racks from oven cavity before starting a self-clean cycle. Clean by using a mild abrasive cleaner following manufacturer's instructions. Rinse with clean water, dry, and replace in oven.
Soil not completely removed after self clean	Self clean was interrupted. Review instructions on "Self Clean" on page 23 . Excessive spills on oven bottom. Remove excessive spills before starting self clean. Failure to clean soil from the oven frame, the door liner outside the oven door gasket, and the small area at the front center of the oven bottom. These areas are not in the self-cleaning area, but get hot enough to burn on residue. Clean these areas before starting the self-cleaning cycle. Burned-on residue can be cleaned with a stiff nylon brush and water or a nylon scrubber. Be careful not to damage the oven gasket
Other Problems	
Appliance is not level.	Be sure the floor is level, strong, and stable enough to adequately support the range. If the floor is sagging or sloping, contact a carpenter to correct the situation. Poor installation. Place the oven rack in the center of the oven. Place a level on the oven rack. Adjust the leveling legs at the base of the appliance until the rack is level. Kitchen cabinet alignment may make range appear not level. Be sure cabinets are square and have sufficient room for appliance clearance.
Cannot move appliance easily. Appliance must be accessible for service.	Cabinets not square or are built in too tightly. Contact the builder or installer to make the appliance accessible. Carpet interferes with appliance. Provide sufficient space so the appliance can be lifted over carpet. Installation over carpet is not advised. See the installation instructions for guidelines specific to your appliance.
Oven light does not work.	Be sure the oven light is secure in the socket. See "Replacing the Oven Light" on page 30 .

Kenmore®

Customer Care Hotline

To schedule in-home repair service
or order replacement parts

Para pedir servicio de reparación
a domicilio, y ordenar piezas

1-844-553-6667

www.kenmore.com



Free Manuals Download Website

<http://myh66.com>

<http://usermanuals.us>

<http://www.somanuals.com>

<http://www.4manuals.cc>

<http://www.manual-lib.com>

<http://www.404manual.com>

<http://www.luxmanual.com>

<http://aubethermostatmanual.com>

Golf course search by state

<http://golfingnear.com>

Email search by domain

<http://emailbydomain.com>

Auto manuals search

<http://auto.somanuals.com>

TV manuals search

<http://tv.somanuals.com>