

OWNER'S MANUAL

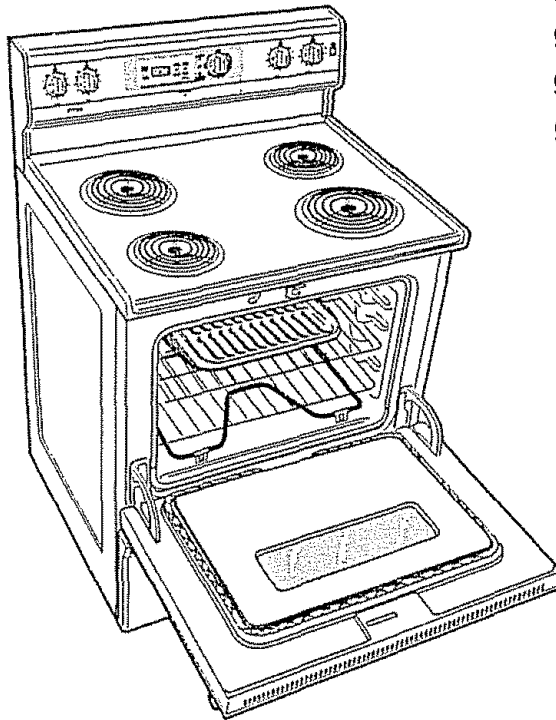

30" ELECTRIC SELF-CLEANING FREE-STANDING RANGE



MODEL NO.

911. 92391
911. 92485
911. 92486
911. 94391
911. 94398
911. 93471
911. 93478
911. 94485
911. 94486

CAUTION:

Before using this range,
read this manual and
follow all its Safety Rules
and Operating
Instructions.

- Safety Instructions
- Operation
- Care and Cleaning
- Problem Solving

Sears, Roebuck and Co., Hoffman Estates, IL 60179 U.S.A.

229C4020 **P118** (SR-10323)



ELECTRIC FREE-STANDING

Table of Contents

SAFETY INSTRUCTIONS

Range Safety 3-6
 Stability Device 3

OPERATION

Features of Your Range 7
 Removal of Packaging Tape . 7
 Cooking Elements 8
 Control Settings 8
 Home Canning 8
 Hour/Minute Arrow Pad 9
 Display 9
 Indicator Lights 9
 Black Out The Display 9
 F-Codes 9
 Power On 9
 Automatic Oven Shut-off 9
 To Set the Clock 10
 To Set the Timer 10
 To Reset The Timer 10
 To Cancel The Timer 10
 Oven Cooking Tips 11-14
 Strong Smell or Odor 11
 Aluminum Foil 11
 Oven Vent 11
 Preheating 11
 Temperature Sensor 11
 No Peeking 11
 Bakeware 12
 Bakeware Placement 12
 Oven Racks 12
 Oven Control 13
 Hide-A-Way Handle 13

To Set Bake 14
 Element Cycling 14
 Oven Temperature
 Adjustment 13, 25
 Broiling 15

CARE AND CLEANING

Self-Cleaning 16-17
 Control Panel 18
 Broiler Pan and Grid 18
 Walls of The Oven 18
 Cooktop and Burner Box
 Bottom 18
 Painted Surface 18
 Control Knobs 19
 Replacing Oven Light Bulb . 19
 Storage Drawer 20
 Lift Up Cooktop 21
 Cooktop Units 21
 Oven Racks 22
 Oven Door 22

SERVICE

Before Calling for
 Service 23, 24
 Temperature Adjustment 25
 Warranty 27
 Consumer Service
 Numbers 28

For your convenience and future reference, please write down your model and serial number in the space provided. They are located behind the storage drawer.

MODEL NUMBER:

SERIAL NUMBER:



IMPORTANT SAFETY INSTRUCTIONS

SAVE THESE INSTRUCTIONS

Read all instructions before using this appliance. When using gas or electrical appliances, basic safety precautions should be followed, including the following:

STABILITY DEVICE



! WARNING

- All Ranges Can Tip
- Injury To Persons Could Result
- Install Anti-tip Device Packed With Range
- See Installation Instructions

Tools you will need:

- Phillips head screwdriver
- 1 3/8" open end or adjustable wrench

1. Remove the bracket from the prepack located inside the oven.
2. Decide whether the bracket will be installed on the right or left side of range location.
3. If the bracket side of the range is adjacent to a cabinet, place the bracket against back wall and cabinet as shown in Figure 1.
If there is no adjacent cabinet, determine where the location of the range side (painted outside panel) will be. Place the bracket with its outside edge at this location and against back wall. See Figure 2.
4. Determine whether you will anchor the bracket to the floor or wall. Make sure this location is clear of electrical wiring or plumbing.

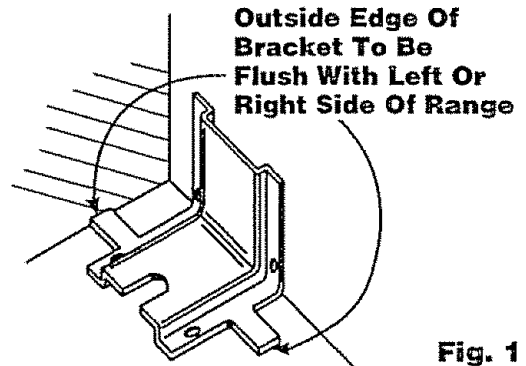

Fig. 1

5. Fasten the bracket securely with the screws provided. Screws are self-drilling in wood, plywood, particle and chip board, and most metal framing. If attaching to masonry, you can buy suitable screws and anchors at hardware stores. Use a masonry drill to drill the required holes

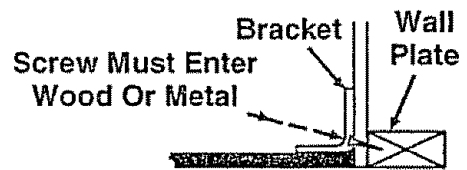

Fig. 2

Attachment To Wall

6. Using the wrench, back out the four leg levelers at least two turns. See your installation guide for more leveling information before positioning range.
7. Slide the range into place. Be sure rear leg leveler fully engages the slot in the bracket. If range cannot be moved back far enough for rear leg leveler to enter bracket, move bracket forward as required and attach to floor in new location.



IMPORTANT SAFETY INSTRUCTIONS

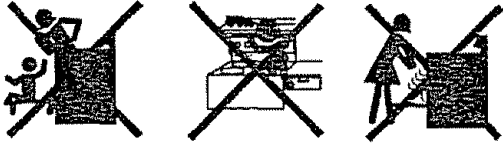

WARNING! To prevent accidental tipping of the range from abnormal usage, including excessive loading of the oven door, attach the range to the wall or floor by installing the Anti-Tip device supplied. If the range is moved for cleaning, servicing or any reason, be sure the Anti-Tip device is re-engaged properly when the range is slid back in the opening. Failure to do so could result in the range tipping or personal injury. To inspect the anti-tip device, remove the storage drawer and look to see if the rear leg leveler fully engages the slot in the bracket.

Important: To insure safety for yourself, family and home, please read your Owner's Manual carefully. Keep it handy for reference. Pay close attention to Safety Sections. **BE SURE** your appliance is installed and grounded by a qualified technician.

- **DO NOT** leave children alone or unattended near an appliance in use.
- **TEACH CHILDREN** not to play with controls or any part of the appliance, and not to sit, climb or stand on the door, or any other part of the appliance.

CAUTION: NEVER STORE items of interest to children on the backguard or in cabinets above the appliance. Children climbing on the appliance could be seriously injured.

- **KEEP THIS** book for later use.
- **NEVER USE** your appliance for warming or heating the room.
- **NEVER TRY** to repair or replace any part of the appliance unless instructions are given in this manual. All other work should be done by a qualified technician.
- **ALWAYS KEEP** combustible wall coverings, curtains, dish cloths, towels, potholders, and other linens a safe distance from the appliance.
- **NEVER HEAT** unopened food containers. Pressure buildup can cause the container to burst and cause injury.
- **NEVER LEAVE** jars or cans of fat or drippings in your oven.
- **ALWAYS KEEP** the oven and surface unit areas free from things that will burn. Food, wooden utensils, and grease buildup could catch fire. Plastic utensils could melt and canned foods could explode. Your appliance should never be used as a storage area.
- **ALWAYS KEEP** your appliance clear of things that will burn (gasoline and other flammable vapors or liquids).
- **NEVER TRY** to clean a hot surface. Some cleaners produce noxious fumes, and wet cloths or sponges could cause steam burns.
- **NEVER WEAR** loose fitting clothing when using your appliance.
- **NEVER USE** a towel or other bulky cloth as a potholder, and make sure the potholder is dry. Moist potholders and wet cloths or sponges could cause steam burns. **DO NOT** let potholders touch hot heating elements.



IMPORTANT SAFETY INSTRUCTIONS

- **DO NOT** touch heating elements, surfaces near them, or interior oven surfaces. These may be hot enough to cause burns even though they are dark in color. During and after use, do not touch or let clothing or flammable material contact the elements or hot surfaces until they have had time to cool. Other surfaces near the oven vent openings, oven door and window, and cooktop surfaces may also be hot enough to cause burns.

COOKTOP SAFETY

- **ONLY SOME** kinds of glass or ceramic cookware can be used for cooktop cooking. Make sure the cookware you choose to use is designed for cooktop cooking without breaking due to the sudden temperature change.
- **ALWAYS USE** care when touching cooktop elements. They will retain heat after the range has been turned off.
- **NEVER BLOCK** the oven air vent under the right rear element.
- **COOKWARE USED** for cooktop cooking should be flat on the bottom and large enough to cover the heating area being used. Undersized utensils expose the heating element and may result in direct contact or ignition of clothing.
- **ALWAYS USE** drip bowls to prevent wiring and component damage. **Do not** use aluminum liners or foil in drip bowls. Improper use may result in risk of electrical shock or fire.

- **NEVER LEAVE** surface units unattended at high settings. Boilovers result in smoking or greasy spills which could catch fire.
- **ALWAYS TURN** utensil handles inward and away from other surface units to reduce the risk of burns, ignition, unintended contact, and spillage.
- **NEVER** put heating elements in water.

OVEN SAFETY

- **PLACE OVEN RACKS** in the desired position while the oven is cool. If racks must be moved while oven is hot, do not let potholder contact the hot oven element.
- **AFTER BROILING**, always take the broiler pan and grid out of the oven and clean them. Leftover grease in the broiler pan could catch fire the next time you use your oven.
- **ALWAYS USE** care when opening the oven door. Let hot air and steam escape before moving foods.
- **NEVER USE** aluminum foil to line the oven bottom. Improper use of foil could result in the risk of electrical shock and fire.



IMPORTANT SAFETY INSTRUCTIONS

SELF-CLEAN SAFETY

- **CLEAN ONLY** the parts listed in this manual. Follow all cleaning instructions. Be sure to remove broiler pan and grid before the self-clean cycle.
- **NEVER RUB**, move or damage the door gasket on self-cleaning ranges
- **NEVER TRY** to clean utensils, cookware, removable parts, or broiler pan and grid in the self-clean cycle.
- **DO NOT USE** oven cleaners - No commercial oven cleaner, or protective coating of any kind, should be used in or around any part of the oven.
- **NEVER FORCE** the latch handle open while oven is hot.

IMPORTANT SAFETY NOTICE!

The California Safe Drinking Water and Toxic Enforcement Act requires the governor of California to publish a list of substances known to the state to cause birth defects or other reproductive harm and requires businesses to warn their customers of potential exposure to such substances. The fiberglass insulation in a self-cleaning oven will give off a very small amount of carbon monoxide during the cleaning cycle. Exposure can be minimized by venting with an open door or window or using a ventilation fan or hood.



CAUTION:
Never line the drip bowls with aluminum foil. Foil can block the normal heat flow and damage the range. Always use cookware and woks that are flat on the bottom and the same size as the cooking element being used. Cookware should not extend more than 1" beyond the edge of the cooking element.

READ AND UNDERSTAND THIS INFORMATION NOW!

Be sure everyone in your home knows what to do in case of fire. Never use water on a grease fire; it will only spread the flames.

COOKTOP GREASE FIRE: Never pick up a flaming pan...

1. Turn off the surface elements.
2. Smother the flame with a tightly fitting lid. Use baking soda or a dry chemical, foam, or halon type extinguisher.

OVEN FIRE: Do not try to move the pan!

1. Close the oven door and turn controls off
2. If fire continues, carefully open the door, throw baking soda on the fire, or use a dry chemical, foam, or halon type extinguisher



OPERATION

FEATURES OF YOUR RANGE

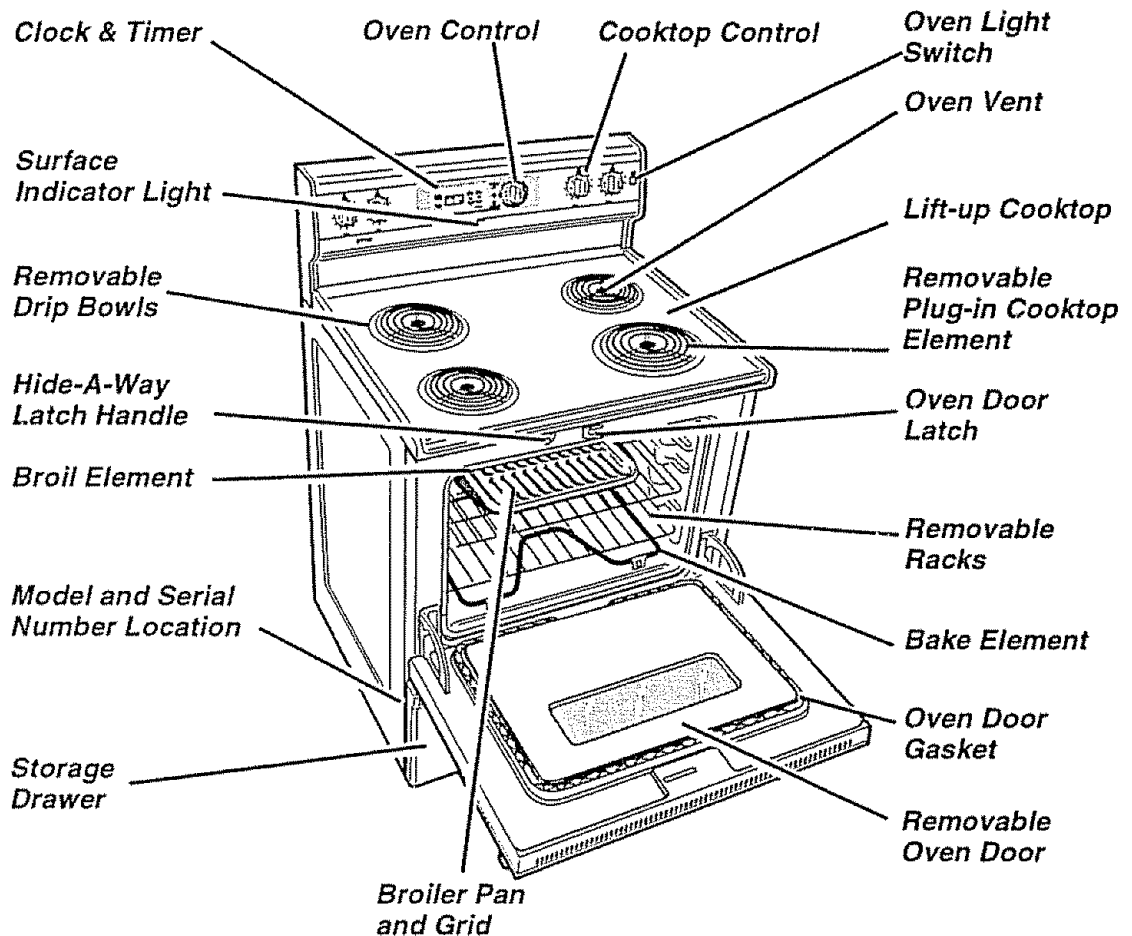

REMOVAL OF PACKAGING TAPE

To remove the adhesive left from packaging tape, use household dishwashing liquid, mineral oil or cooking oil. With a soft cloth rub into the area and allow to soak. Rinse and dry well. Repeat procedure using an appliance polish to insure no damage is done to the appliance. **This should be done before the range is turned on for the first time. The tape cannot be removed once the range has heated.** Packaging tape can be found in the following areas: Cooktop Surface, Door Handle, Oven Area, Control Panel Area and Door Trim Area.



OPERATION

Cooktop Cooking

COOKING ELEMENTS

The sign near each control knob shows you which element is turned on by that knob.

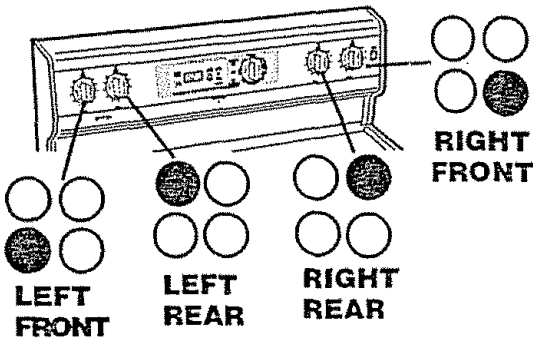

CONTROL SETTINGS

- HI** Used for quick starts, such as bringing water to a boil.
- MED** Used for slow boiling and sautéing.
- LO** Used for steaming foods or keeping cooked foods at serving temperature.

1. Push down to turn the knob.

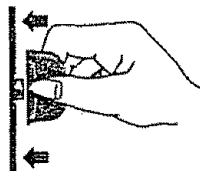

2. Set on or between marks for desired heat

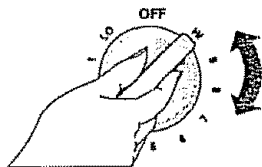

When any surface unit is on, the surface unit indicator light will be on.

HOME CANNING TIPS

Water-bath or pressure canners and large diameter pots extending more than 1" beyond the edge of the cooktop element may be used for canning. **However**, do not use large diameter canners, pots or pans for anything other than boiling water. Most syrup or sauce mixtures, and all types of frying, cook at temperatures much higher than boiling water. Such temperatures could eventually harm the cooktop surfaces surrounding the surface units.

OBSERVE THE FOLLOWING POINTS WHEN CANNING

1. Be sure the canner is centered over the element.
2. Make sure the canner is flat on the bottom.
3. Use recipes and procedures from reputable sources. These are available from manufacturers such as Ball® and Kerr®, and the Department of Agriculture Extension Service.
4. Use caution while canning, to prevent burns from steam or heat.



OPERATION

Clock, Timer & Oven Control



Your new range **CLOCK**, **TIMER** and **OVEN** operations are simple and easy to understand.

HOUR/MINUTE ARROW PAD

The **HOUR/MIN** arrow pads allow you to set the exact time you need

DISPLAY

The display in the center of your control will show:

1. The time of day **CLOCK**.
2. The amount of time you choose when using the **TIMER**.
3. The temperature selection as you turn the oven control knob.

INDICATOR LIGHTS

Your control has individual indicator lights that will show you the operations you have chosen.

As you read through your manual, you will find what each of these indicators is used for and how they will help you in understanding your new control.

TO BLACK OUT THE DISPLAY

Your new control has the special feature of blacking out the display (have nothing showing in the display). To activate this feature:

If the time of day is showing in the display, press the **CLOCK** pad once.

To bring back the display from the time of day black-out, press the **CLOCK** pad twice

F-CODES

If the display flashes an **"F"** followed by a number and beeps continuously, you have a function error code. Note the number after the **"F"**. Turn the oven control knob to the **OFF** position. Allow the oven to cool for about 1 hour and retry the oven operation. If the problem repeats call for service. Advise the technician what the flashing code was.

POWER ON

When the power to your range is turned on for the first time, the display will flash the time when the power was turned off. You can set the clock at this point, or press the Clock pad to stop the flashing.

AUTOMATIC OVEN SHUT-OFF

As a safety feature, this oven will automatically shut off if it has been left on for more than 12 hours. This feature can be disabled. See page 14.



OPERATION Clock and Timer



The **CLOCK** and **TIMER** are set by using the touch pads. The **TIMER** will not control any oven operation.

TO SET THE CLOCK



1. Press the **CLOCK** pad twice to make the display flash.



2. Press the **HOUR/MINUTE UP** or **DOWN** pads to set the time of day. The colon will flash while you are setting the time.



The clock will automatically start keeping time within one minute or you may press the **CLOCK** pad for immediate start.

TO SET THE TIMER

The **TIMER** is only a minute timer. It will not control oven operations. The maximum time you may set is 11 hours and 59 minutes.



1. Press the **TIMER ON/OFF** pad. "0:00" and the Timer indicator light will flash.



2. Press the **HOUR/MINUTE UP** or **DOWN** arrow pads to set the time you prefer to use. The colon will flash while you are setting the time



After releasing the arrow pad, the timer indicator light and the colon will blink

three to five times, the timer will start the count down. The Timer Indicator Light will remain on until countdown reaches "0".

When the timer has started the countdown, you may press the **CLOCK** pad to return to the current time of day.

At the end of the countdown, the control will beep and the Timer Indicator Light will flash. Press the **TIMER ON/OFF** pad

TO RESET THE TIMER

If you have selected an amount of time, but decide to change it:

If the countdown is showing in the display, press the **MINUTE/HOUR UP** or **DOWN** arrow pad. Select the desired time.

If the time of day clock or temperature is showing in the display, press the **TIMER ON/OFF** pad. Then, press either the **MINUTE/HOUR UP** or **DOWN** arrow pad. Select the desired time.

TO CANCEL THE TIMER

If you wish to cancel the **TIMER**, press the **TIMER ON/OFF** pad once. If the countdown is not showing, press the **TIMER ON/OFF** pad twice.



OPERATION

Oven Cooking Tips

STRONG SMELL OR ODOR

It is normal to have some odor when using your oven for the first time. To help eliminate this odor, **ventilate the room by opening a window or using a vent hood.**

ALUMINUM FOIL

IMPORTANT: Never cover the oven bottom or oven rack with aluminum foil. Improper use can cause poor heat flow, poor baking results, and may damage the oven finish.

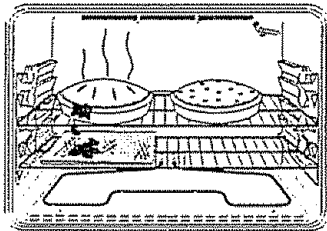

OVEN VENT

The oven vent is located under the right rear element. This area could become very hot during oven use. **Never block this vent.**

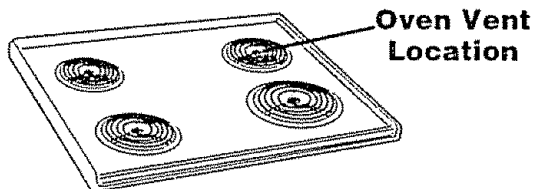

PREHEATING

Preheating is bringing the oven temperature up to the temperature you will be using during baking. Let the oven preheat thoroughly when recipes call for preheating.

OVEN TEMPERATURE SENSOR

In the back of the oven you will notice a small tube. This is a heat sensor that maintains the temperature of the oven. Never move or bend this tube.



NO PEEKING

Opening the door often to check foods will cause heat loss and poor baking results.



OPERATION Oven Cooking Tips

BAKEWARE

FLAT COOKIE SHEETS, without sides, allow air to circulate all around the cookies for even browning.

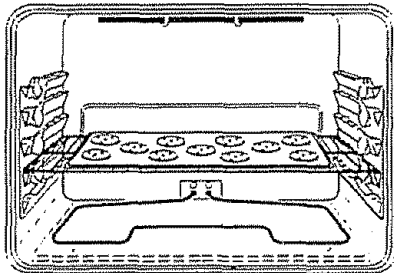

SHINY PANS reflect heat, and are perfect for cakes and quick breads that a light golden brown crust

GLASS, DARK NON-STICK OR DARKENED BY AGE BAKEWARE, absorb heat, and can be used for yeast breads, pie crust or foods that need a brown crust. The oven temperature when using these pans should be reduced by 25°F.

BAKEWARE PLACEMENT

If baking with more than one pan, place the pans so each has at least 1 to 1 1/2" of air space around it. Place pans so one is not directly above the other.

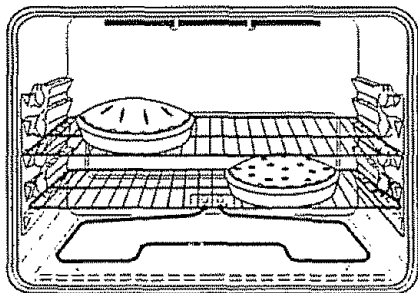

OVEN RACKS

The oven racks are designed with stop locks, a convenience as well as a safety precaution. The guides have a bump to prevent the racks from tilting when racks are pulled out of the oven.

Bump in rack guide

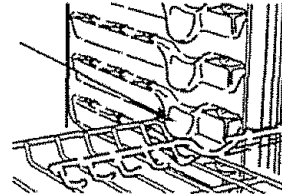

Your oven has four (4) rack positions. Above the top guide cannot be used for a rack position.

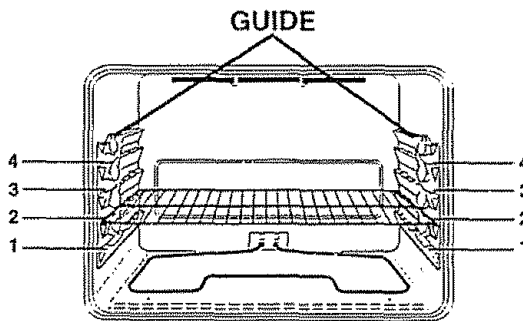

Always place oven racks in the proper position while oven is cool.



OPERATION Oven Cooking Tips

OVEN TEMPERATURE ADJUSTMENT

You may feel that your new oven cooks differently than the oven it replaced. We recommend that you use your new oven a few weeks to become more familiar with it, following the times given in your recipes as a guide. See Do It Yourself Temperature Adjustment in the back of this manual to make the adjustment if you feel your oven is too hot or too cool for your cooking preference.

OVEN CONTROL

Your oven control has a selector knob for choosing **BAKE**, **BROIL**, or **CLEAN**. There are also three indicator lights:

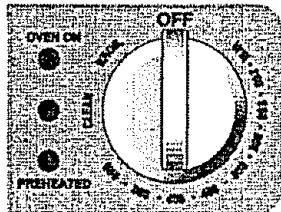

- **PREHEATED Indicator Light** — turns on and stays on when oven has reached selected bake temperature.
- **OVEN ON Indicator Light** — turns on and stays on when bake, broil, or clean function has been chosen.
- **CLEAN Indicator Light** — turns on for self-clean. If the **CLEAN** Indicator Light flashes, you should check for one of the following:

1. The door handle is latched during a baking or broiling function;
2. The door handle is not latched during a self-clean function.

HIDE-A-WAY HANDLE

Your new range is equipped with a hide-away-handle (used for self-clean only) that can be hidden under the maintop when it is in the unlocked position.

1. Be sure the handle is in the unlocked position and raise the cooktop.
2. Push the handle into the latch cover until it stops.
3. Lower the cooktop.

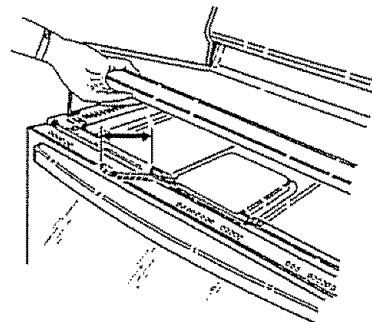

Never latch the oven door during baking or broiling.

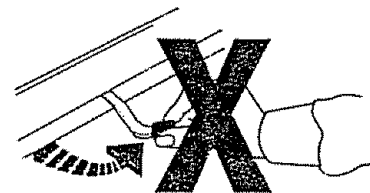



OPERATION

Oven Cooking tips

TO SET BAKE

1. Turn the **OVEN CONTROL KNOB** to selected temperature from WM to 550°F. As the knob turns the control display will show the changing temperatures. When the display shows your selected temperature release the control knob. The temperature will remain in the display for 5 seconds then return to the time of day. To recall the temperature display press the **MINUTE** down arrow pad
2. The **“OVEN ON”** indicator light will glow.
3. When the oven has reached the selected temperature, a series of short tones will sound, and the **“PREHEATED”** and **“OVEN ON”** indicator lights will glow.
4. The **“PREHEATED”** and **“OVEN ON”** indicator lights will remain on until baking is complete and the control knob is turned to the **OFF** position

ELEMENT CYCLING

The Oven Temperature Sensor continuously senses and controls the temperature inside the oven. To keep a constant set temperature, the elements will cycle or turn on and off during cooking.

DISABLE THE 12 HOUR SHUT-OFF

1. With the oven control in the **OFF** position, press and hold the **MINUTE UP** and **DOWN** arrow pads, at the same time, until **“ON”** or **“OFF”** shows in the display.
2. Holding the **MINUTE UP** and **DOWN** arrow pads, at the same time again, will alternate between 12 hour shut-off on or off.



OPERATION Broiling

Broiling is cooking by direct heat from the upper element. The oven door should remain open to the broil stop position during broiling.

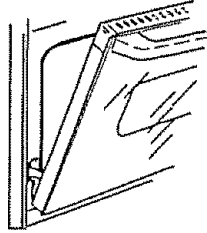

It is not necessary to preheat the oven when broiling. Use the broiler pan and grid that came with your range. Both are designed for proper drainage of fat and liquids.



If foil is used it must be molded tightly to the grid and slits cut into the foil to match

those of the grid. This allows fats and liquids to drain into the broiler pan, preventing fire and excessive smoke.

Always remove the pan and grid from the oven.

Storing or forgetting a soiled broiler pan in the oven is a potential smoke or fire hazard.



The U.S. Department of Agriculture notes that meat cooked rare is popular, but meat cooked to only 140°F (rare) means that some food poisoning organisms may survive.

The closer you place foods to the broil element, the faster foods brown on the outside yet remain red to pink in the center.

Moving meats away from the element will allow the meat to cook to the center while browning on the outside. Cook side 1 at least 2 minutes longer than side 2. If your oven is connected to 208 volts, you may want to use a higher rack position and/or broil foods longer.

The size, weight, thickness, starting temperature and your preference of the doneness of the meat will affect broiling. This chart is based on meats at refrigerator temperature.

FOOD	RACK POSITION	TOTAL TIME (MIN.)
Steak 1" thick	3	9-11
Ground beef patties 1" thick	3	16-18
Pork Chops-1/2" thick	3	27-29
Fish (fillets)	3	11-13
Chicken (pieces)	2	45-55

HOW TO SET BROIL

TO SET BROIL:

1. Set the **OVEN CONTROL KNOB** to **BROIL**.
2. The "**OVEN ON**" indicator light will glow.
3. When broiling is finished, turn the **OVEN CONTROL KNOB** to the "**OFF**" position.



Self-Cleaning Cycle

PREPARING YOUR OVEN FOR A SELF-CLEAN CYCLE

1. Remove the broiler pan and grid, oven racks, utensils and any foil that may be in the oven.
2. Soil on the front frame, 1" inside the oven, and outside the door gasket will need to be cleaned by hand.

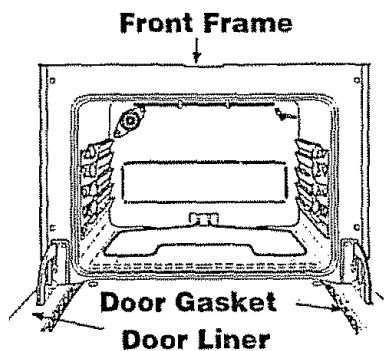

Clean these areas with hot water, soap-filled steel wool pads or cleansers such as Soft Scrub® to remove any soil. Rinse well with clean water and dry.

3. Wipe up any heavy spillovers on the oven bottom.
4. Do not clean the door gasket. The fiberglass material of the oven door gasket cannot withstand abrasion. It is essential for the gasket to remain intact. If you notice it becoming worn, frayed or displaced on the door, it should be replaced.

CARE AND CLEANING

OVEN DOOR GASKET

The door gasket is designed to have a 5-6" gap at the bottom of the door. This allows for proper air circulation.

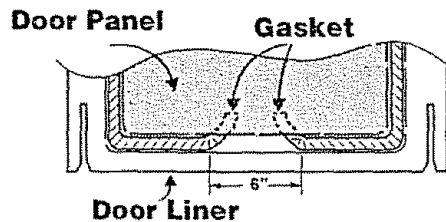

It is normal for your oven door to give the appearance of not having a good seal against the range. This is due to the gasket. The location of the gasket on the oven door maintains a good seal and prevents any heat loss.



Utensils should never be left in the oven during a self-clean cycle.

The oven racks may be cleaned during the self-clean cycle, but will lose their luster and become hard to slide. If you choose to leave them in during the cycle, wiping them down with vegetable oil after the cycle will help them slide easier.

For the first clean cycle, vent the room with an opened window or hood vent. This will reduce the odor when heating new parts.



CARE AND CLEANING Self-Cleaning Cycle

HOW TO SET A CLEAN CYCLE

1. For best results, follow the steps in **PREPARING YOUR OVEN.**
2. If your handle is hidden, lift the cooktop and pull the handle out as far as it will go.
3. Slide the handle to the right. Do not force the handle. If it does not slide easily, you have not pulled it out from the latch cover as far as it will go. Repeat Step 2.

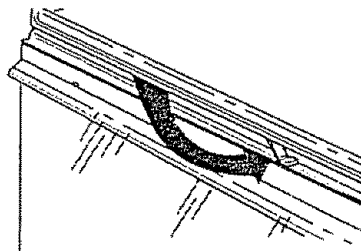
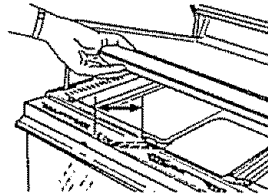

4. Turn the oven control knob to **"CLEAN"**. The **"CLEAN"** and **"OVEN ON"** indicator lights will glow.
5. The handle will lock when high temperatures are reached.
6. The clean cycle lasts 4 hours and 20 minutes, this includes cool down time. The **"OVEN ON"** and **"CLEAN"** indicator lights will blink at the end of the clean cycle.
7. After the cycle is finished, turn the oven control knob to the off position.
8. When the temperature has cooled, the door latch handle will easily slide to the left.

TO STOP A CLEAN CYCLE

Turn the oven control knob to the off position. You will need to wait for the oven temperature to drop below the lock temperature (approx. 1 hour) before attempting to open the door. The indicator light will not blink if the cycle is interrupted.

AFTER THE CYCLE

After the cycle, you may notice some white ash in the oven. Just wipe it up with a damp cloth or sponge.



If white spots remain, scrub them with a soap-filled steel wool pad. Be sure to rinse thoroughly. These are usually deposits of salt that cannot be removed during the cycle.

If for any reason you are not satisfied with the cleaning results, just repeat the cycle.



CARE AND CLEANING *Cleaning*

CONTROL PANEL

CLEANING MATERIALS

- Dishwashing detergent
- Warm water
- Soft cloth

Do not use abrasive cleaners, industrial cleaners, or bleach.

BROILER PAN AND GRID

CLEANING MATERIALS

- Dishwashing detergent
- Warm water
- Soap-filled steel wool pad
- Commercial oven cleaner

TO CLEAN

Allow the pan to soak. Sprinkle the grid with dishwashing detergent and cover with a damp cloth or paper towel and let stand. Scour as needed. Wash, rinse, and dry well. You may also place both the pan and grid in the dishwasher.

WALLS OF THE OVEN

Clean only as touch up between clean cycles. Use dishwashing liquid, warm water or soap-filled steel wool pad. Rinse well after cleaning and dry.

NEVER USE OVEN CLEANERS IN OR AROUND ANY PART OF THE OVEN.

When cleaning, be sure not to bend or displace the temperature sensor located on the back wall of the oven.

COOKTOP AND BURNER BOX BOTTOM

CLEANING MATERIALS

- Dishwashing detergent
- Warm water
- Paper towel
- Ammonia
- Abrasive cleaner
- Scouring pad

TO CLEAN

Clean after each use. If acidic foods (hot fruit filling, milk, tomatoes, sauerkraut or sauces with vinegar or lemon juice) spill, use a dry paper towel to wipe up as much as possible. When surface has cooled thoroughly clean cooktop.

PAINTED SURFACES

CLEANING MATERIALS

- Dishwashing detergent
- Warm water
- Paper towels

TO CLEAN

Do not use oven cleaners, cleansing powder, or harsh abrasives. If marinades, tomato sauce, basting materials, etc., should spill, wipe up as much as possible. When surfaces have cooled thoroughly clean painted areas.



CARE AND CLEANING

Removable Parts

CONTROL KNOBS

CLEANING MATERIALS

- Dishwashing detergent
- Warm water
- Soft cloth

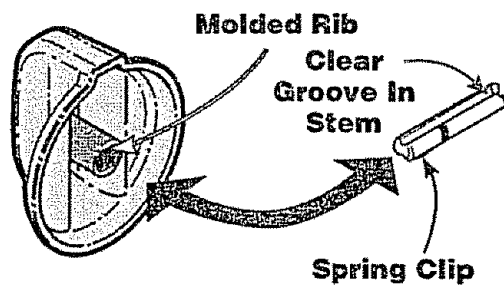

TO REMOVE

1. Be sure the control knob is in the off position.
2. Pull straight off the stem. Using a piece of string can make removing the knob easier. Slip the string under and around the knob, pulling straight out.

TO CLEAN

Wash the knob thoroughly with soapy water. Dry completely with a soft cloth. **DO NOT let the knob soak.**

TO REPLACE

1. Check the back of the knob.
2. The molded rib of the knob is designed to fit perfectly onto the knob stem.
3. Align the molded rib to the clear groove in the knob stem. Push the knob back as far as it will go.

REPLACING THE OVEN LIGHT BULB



CAUTION: Be sure the oven light switch is in the off position. Do not touch a hot light bulb with wet hands or a wet cloth. Wait until the bulb has cooled and use a dry cloth. Never touch the live collar of the bulb. If you are replacing a broken light bulb, make sure the power supply is off.

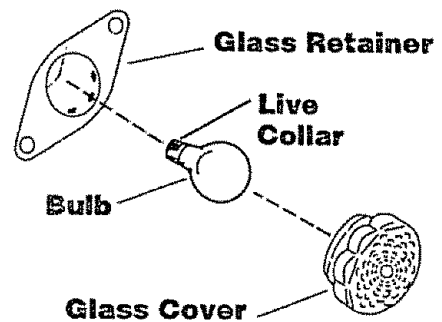

TO REPLACE

1. Unscrew glass cover and remove.
2. Unscrew the light blub.
3. Replace the bulb with a 3 1/2" 40 watt appliance bulb.
4. Replace the cover.



CARE AND CLEANING

Removable Parts

REMOVABLE STORAGE DRAWER

CLEANING MATERIALS

- Dishwashing detergent
- Damp cloth
- Warm water

TO REMOVE

1. Pull the drawer out until it stops.

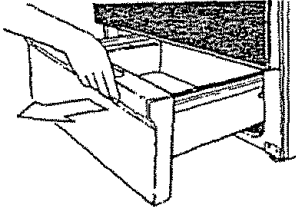

2. Lift the front of the drawer until the stop guide of the drawer clears the stop guide on the base rail.

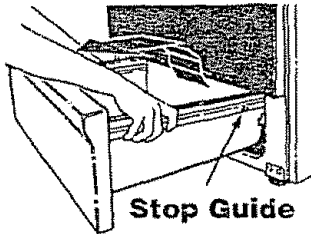

3. Lift the drawer up and over the drawer stop

TO CLEAN

Wipe the inside and outside with warm soapy water and a damp cloth or sponge. Do not use harsh abrasives or scouring pads on the drawer.

TO REPLACE

1. Lift the front of the drawer stop and lower the stop of the drawer through the opening of the base rail.

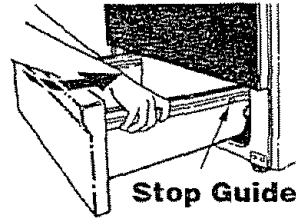

2. Lower the front of the drawer and push back the drawer until it stops.
3. Lift up on the front of the drawer until the stop guide of the drawer clears the stop guide of the base rail. Slide the drawer into place.



CAUTION: The drawer gives you space for keeping cookware and bakeware. Plastics and flammable materials should not be kept in this drawer. Do not overload the storage drawer. If the drawer is too heavy, it may slip off the base rail when opened.



CARE AND CLEANING Removable Parts

LIFT UP COOKTOP

Support Rod

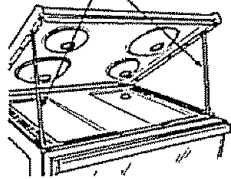

1. Grasp the edge of the cooktop and lift up.
2. Holding the cooktop with one hand, lift the support rod(s) up and rest the edge of the cooktop on it.
3. When cleaning is finished, lower the support rod(s) and the cooktop.

 **CAUTION: When working in this area, be careful not to bump into the support rod(s). The porcelain enamel surface of the cooktop can chip if dropped.**

REMOVABLE COOKTOP UNIT

Element

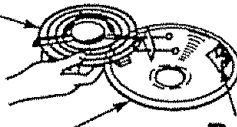

Reflector Bowls

Receptacle

TO REMOVE

1. Be sure the controls are in the off position and the elements are cool before attempting to remove them.
2. Grasp the element and lift slightly, just enough to clear the drip bowl and pull it straight out.

 **CAUTION: Do not lift the element more than 1". Lifting the element more than 1" can damage the receptacle, causing the element not to lie flat when it is plugged back in.**

3. Lift out the drip bowl.

TO CLEAN THE DRIP BOWL

For brown food stains — use dishwashing detergent, warm water, plastic scouring pads, mild abrasive cleaners, soap-filled scouring pads or ammonia. Clean drip bowls after each use. Rinse and dry well. Foods that are not removed can cause permanent stains that cannot be removed. For heavily soiled bowls, place an ammonia-soaked paper towel over the bowl to loosen the soil, then gently scrub the bowl with a plastic scouring pad.

For blue-gold heat stains — use a metal polish. These stains are caused by overheating, and are usually permanent. To help minimize this effect, avoid excessive use of high heat settings and use flat bottom pans that do not extend more than 1" from the edge of the cooking element.

 **CAUTION: Do not operate the cooktop elements without the drip bowl in place. Scorching of the cooktop, burning of wiring insulation and loss of energy will occur.**

TO REPLACE THE UNIT

1. Place the drip bowl into the opening and make sure the receptacle is visible.
2. Slide the element firmly back into the receptacle and lower it onto the drip bowl.



CARE AND CLEANING

Removable Parts

REMOVABLE OVEN RACKS

CLEANING MATERIALS

- Dishwashing detergent
- Warm water
- Scouring pad or soap-filled steel wool pad

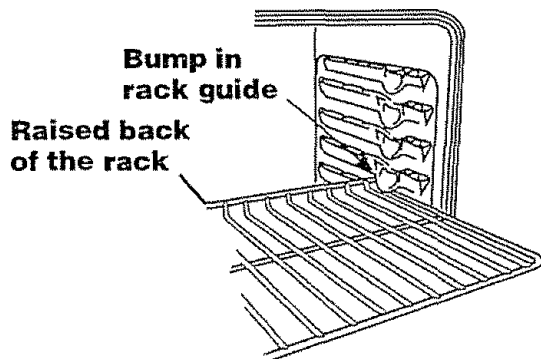

TO REMOVE

1. Pull the racks out to the stop lock position.
2. Pull up the front of the rack and slide under the bump of the rack guide.

TO CLEAN

Clean with warm water and detergent. For hard to remove stains, gently scrub with a scouring pad or a soap-filled steel wool pad. Rinse well.

TO REPLACE

1. Place the raised back of the rack onto the rack guides.
2. Lift the front of the rack until the raised back slides under the bump of the rack guides.
3. Slide the rack all the way back

REMOVABLE OVEN DOOR

Broil Stop Position

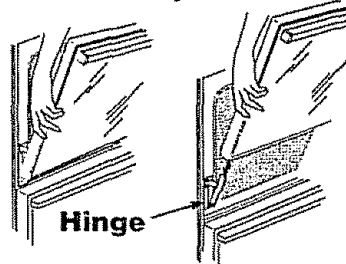

TO REMOVE

1. Open the door to the broil stop position.
2. Grasp the door at each side and lift up and off the hinges. **DO NOT LIFT DOOR BY THE HANDLE.**



CAUTION: When the door is removed and the hinge arms are at the broil stop position, as a precaution, cover the hinge arms with toweling or an empty paper towel roll. Do not bump or try to move the hinge arms while working in the oven area. They could snap back causing injury to the hands or damage the porcelain finish of the front frame.

TO REPLACE

1. Make sure the hinge arms are in the broil stop position.
2. Lift the door by the sides.
3. Line up the slots at the bottom edge of the door with the hinge arms.
4. Slide the door down onto the hinge arms as far as it will go.
5. Close the door.



BEFORE CALLING FOR SERVICE

To save you time and money, before making a service call, check the list below for any problem you may feel you have with the performance of your range. If the problem is something you cannot repair, use the Consumer Service Numbers located at the back of this manual. **When making any calls, have the model number, repair parts list, use and care manual and the date of purchase available.**

PROBLEM	POSSIBLE CAUSE	POSSIBLE SOLUTION
Range will not work; totally inoperative.	No power to range	a. Check the household circuit breaker or fuse box b. Check to make sure the range is plugged in.
Foods do not bake properly.	a. Improper rack or pan placement. b. Oven vent blocked or covered c. Improper use of foil. d. Improper temperature setting for utensil used e. Recipe not followed. f. Improper oven control calibration. g. Range and oven rack not level.	a. Maintain uniform air space around pans and utensils. See oven cooking section b. Keep vent clear. c. Racks should not be covered during baking d. Reduce temperature 25 degrees for glass or dull/darkened pans. e. Check recipe and measurement. f. Check the temperature adjustment following this section. g. Check the installation instructions for leveling
Oven temperature seems inaccurate.	Oven control calibration.	See oven temperature adjustment section.
Oven light does not work.	a. Light switch is in off position. b. Bulb needs replacing.	a. Check switch setting. b. Check or replace light bulb.



BEFORE CALLING FOR SERVICE

PROBLEM	POSSIBLE CAUSE	POSSIBLE SOLUTION
Foods do not broil properly.	<ul style="list-style-type: none">a. Improper rack position.b. Oven preheated.c. Improper use of foil.d. Oven door closed during broiling.e. Low voltage (208 volts)f. Improper broiling time	<ul style="list-style-type: none">a. Check broil pan placement; see broiling section.b. Do not preheat when broiling.c. Check broiling section.d. Open door to broil stop positione. Use higher rack position and/or longer cooking time.f. Check broiling chart in broiling section.
Oven smokes.	<ul style="list-style-type: none">a. Dirty oven.b. Improper use of aluminum foil.c. Broiler pan containing grease left in the oven.	<ul style="list-style-type: none">a. Check for heavy spillover.b. Use of foil not recommended.c. Clean pan and grid after each use.
Cooktop will not work, oven is ok.	<ul style="list-style-type: none">a. Elements unplugged.b. Control set improperly.	<ul style="list-style-type: none">a. Check the elements; make sure they are properly plugged into the receptacleb. Push knob in while turning to temperature setting.
Oven will not work, Cooktop ok.	<ul style="list-style-type: none">a. Control set improperly.b. Door latched.c. Door not latched for clean.	<ul style="list-style-type: none">a. Check the control and oven cooking sections.b. Be sure to unlatch the door after the self-clean cycle is finished and the oven has cooled.c. Be sure to retrieve hidden latch handle and slide to the right.
Oven door accidentally locked while baking or broiling.	Do not force the lock handle. Temperatures above the locking temperature will prevent the lock handle from sliding to the unlock position.	Turn the control knob to the off position. Allow the oven to cool until the temperature inside drops below the lock temperature and the handle slides easily.
Cleaning results were poor.	<ul style="list-style-type: none">a. Clean cycle interrupted.b. Oven was heavily soiled	<ul style="list-style-type: none">a. Allow the oven to clean its full cycle.b. Heavy spillovers should be cleaned before the cycle is set.



“DO IT YOURSELF” TEMPERATURE ADJUSTMENT

You may feel that your new oven cooks differently than the oven it replaced. We recommend that you use your new oven a few weeks to become more familiar with it, following the times given in your recipes as a guide.

If you think your new oven is too hot (burning foods) or not hot enough (foods are undercooked) you can adjust the temperature yourself. The appearance and texture of foods is a better indicator of oven accuracy than an oven thermometer, to check the temperature setting of your new oven. These thermometers can vary by 20-40 degrees. In addition, the oven door must be opened to read these thermometers. Opening the door will change the temperature of the oven.

To decide how much to change the temperature, set the oven temperature 25 degrees higher (if foods are undercooked) or 25 degrees lower (if foods are burning) than the temperature in your recipe, then bake. The results of this “test” should give you an idea of how much the temperature should be changed.

TO MAKE THE ADJUSTMENT

1. While the control knob is in the off position, press and hold, at the same time, the **HOUR UP** and **DOWN** arrow pads until the display shows a two digit number.
2. Press the **HOUR UP** arrow pad to increase the temperature from the original setting up to +35° F hotter
or
Press the **HOUR DOWN** arrow pad to decrease the temperature from the original setting down to -35° F cooler.
3. When this adjustment has been made the display will return to the time of day

This adjustment will remain in memory until these steps are repeated, and a new temperature is selected. It will remain in memory even after a power failure.

This adjustment will not affect the Broil or Clean temperatures.

NOTES



RANGE WARRANTY

FULL ONE YEAR WARRANTY ON THE FUNCTIONING OF ALL PARTS EXCEPT GLASS PARTS

If, within one year from the date of installation, any part, other than a glass part, fails to function properly due to a defect in material or workmanship, Sears will repair or replace it, free of charge.

FULL 30-DAY WARRANTY ON GLASS PARTS AND FINISH OF PORCELAIN ENAMEL, PAINTED OR BRIGHT METAL FINISHED PARTS

If, within 30 days from the date of installation, any glass part or the finish on any porcelain enamel, painted or bright metal part is defective in material or workmanship, Sears will replace the part, free of charge.

FULL 90-DAY WARRANTY ON MECHANICAL ADJUSTMENTS

For 90 days from the date of installation, Sears will provide, free of charge, any mechanical adjustments necessary for proper operation of the range, except for normal maintenance.

If the range is subjected to other than private family use, the above warranty coverage is effective for only 90 days.

WARRANTY SERVICE IS AVAILABLE BY CONTACTING THE NEAREST SEARS SERVICE CENTER/ DEPARTMENT IN THE UNITED STATES

This warranty applies only while this product is in use in the United States. This warranty gives you specific legal rights, and you may also have other rights which vary from state to state.

Sears Roebuck and Co. Dept. 817 WA Hoffman Estates, IL 60179

To further add to the value of your Range, Buy a Sears Maintenance Agreement.

Years of Ownership Coverage	1st Year	2nd Year	3rd Year
1 Replacement of Defective Parts other than Porcelain or Glass	W	MA	MA
2 Mechanical Adjustment	90 DAYS W	MA	MA
3 Porcelain and Glass Parts	30 DAYS W	MA	MA
4 Annual Preventive Maintenance Check at your request	MA	MA	MA

W - Warranty MA - Maintenance Agreement

Kenmore Ranges are designed, manufactured and tested for years of dependable operation. Yet, any modern appliance may require service from time to time. The Sears Warranty plus the Sears Maintenance Agreement provides protection from unexpected repair bills and assures you of enjoying maximum range efficiency.

The chart above compares the warranty and Maintenance Agreement and shows you the benefits of a Sears Range Maintenance Agreement.

Contact your Sears Sales Associate or Local Sears Service Center today and purchase a Sears Maintenance Agreement.



**For the repair or replacement parts you need
delivered directly to your home**

Call 7 am - 7 pm, 7 days a week

1-800-366-PART

(1-800-366-7278)

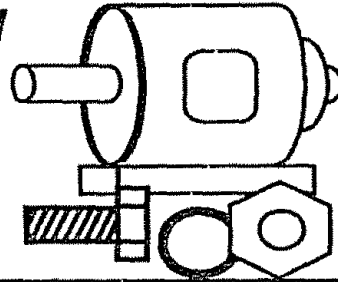

For in-home major brand repair service

Call 24 hours a day, 7 days a week

1-800-4-REPAIR

(1-800-473-7247)

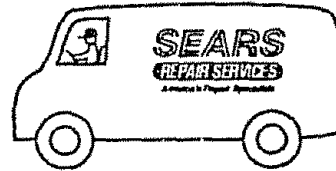

**For the location of a
Sears parts and Repair Center in your area**

Call 24 hours a day, 7 days a week

1-800-488-1222

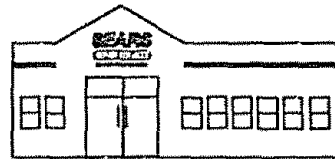

**For information on purchasing a Sears
Maintenance Agreement or to inquire
about an existing Agreement**

Call 9 am - 5 pm, Monday-Saturday

1-800-827-6655

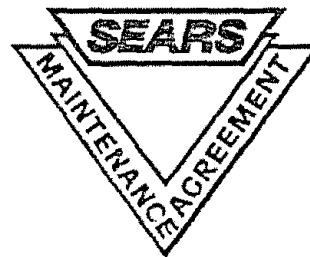

America's Repair Specialists

Free Manuals Download Website

<http://myh66.com>

<http://usermanuals.us>

<http://www.somanuals.com>

<http://www.4manuals.cc>

<http://www.manual-lib.com>

<http://www.404manual.com>

<http://www.luxmanual.com>

<http://aubethermostatmanual.com>

Golf course search by state

<http://golfingnear.com>

Email search by domain

<http://emailbydomain.com>

Auto manuals search

<http://auto.somanuals.com>

TV manuals search

<http://tv.somanuals.com>