

Use & Care Guide
Manual de Uso y Cuidado
English / Español

Model/Modèle: 790.7542*, 7544*

Kenmore Elite[®]

Double Oven Gas Range

Estufa de gas con un doble horno

* = color number, número de color

P/N 808575103 Rev. B

Sears Brands Management Corporation
Hoffman Estates, IL 60179 U.S.A.
www.kenmore.com

Sears Canada Inc.
Toronto (Ontario) Canada M5B 2C3
www.sears.ca



Table of Contents

| | | | |
|---|----|--|----|
| KENMORE ELITE LIMITED WARRANTY | 2 | Setting Broil | 23 |
| Before Setting Surface Controls | 9 | Setting Convection Bake | 24 |
| Home Canning | 11 | Setting Convection Roast | 27 |
| Setting Surface Controls..... | 12 | Adjusting Oven Temperatures (UPO) | 32 |
| Setting Surface Burners | 12 | Self Clean | 33 |
| Before Setting Oven Controls | 13 | Care & Cleaning | 36 |
| Removing, Replacing, and Arranging Oven Racks | 13 | Cleaning the Cooktop and Surface Burners | 37 |
| Oven Controls | 14 | Cleaning surface burner heads | 38 |
| Setting Bake | 18 | Before You Call..... | 41 |
| | | Oven Baking | 41 |
| | | Solutions to Common Problems | 42 |

KENMORE ELITE LIMITED WARRANTY

FOR ONE YEAR from the date of sale this appliance is warranted against defects in material or workmanship when it is correctly installed, operated and maintained according to all supplied instructions.

WITH PROOF OF SALE, a defective appliance will receive free repair or replacement at option of seller.

For warranty coverage details to obtain free repair or replacement, visit the web page: www.kenmore.com/warranty

This warranty applies for only 90 DAYS from the sale date in the United States, and is void in Canada, if this appliance is ever used for other than private household purposes.

This warranty covers ONLY defects in material and workmanship, and will NOT pay for:

1. Cracks in a ceramic glass cooktop that are not a result of thermal shock.
2. Stains and scratches on a ceramic glass cooktop resulting from accident or improper operation or maintenance.
3. Discoloration of cooktop surfaces resulting from normal use.
4. Expendable items that can wear out from normal use, including but not limited to filters, belts, bags or screw-in base light bulbs.
5. A service technician to clean or maintain this appliance, or to instruct the user in correct appliance installation, operation and maintenance.
6. Service calls to correct appliance installation not performed by Sears authorized service agents, or to repair problems with house fuses, circuit breakers, house wiring, and plumbing or gas supply systems resulting from such installation.
7. Damage to or failure of this appliance resulting from installation not performed by Sears authorized service agents, including installation that was not in accord with electrical, gas or plumbing codes.
8. Damage to or failure of this appliance, including discoloration or surface rust, if it is not correctly operated and maintained according to all supplied instructions.
9. Damage to or failure of this appliance, including discoloration or surface rust, resulting from accident, alteration, abuse, misuse or use for other than its intended purpose.
10. Damage to or failure of this appliance, including discoloration or surface rust, caused by the use of detergents, cleaners, chemicals or utensils other than those recommended in all instructions supplied with the product.
11. Damage to or failure of parts or systems resulting from unauthorized modifications made to this appliance.
12. Service to an appliance if the model and serial plate is missing, altered, or cannot easily be determined to have the appropriate certification logo.

Disclaimer of implied warranties; limitation of remedies

Customer's sole and exclusive remedy under this limited warranty shall be product repair or replacement as provided herein. Implied warranties, including warranties of merchantability or fitness for a particular purpose, are limited to one year or the shortest period allowed by law. Seller shall not be liable for incidental or consequential damages. Some states and provinces do not allow the exclusion or limitation of incidental or consequential damages, or limitation on the duration of implied warranties of merchantability or fitness, so these exclusions or limitations may not apply to you.

This warranty applies only while this appliance is used in the United States or Canada*.

This warranty gives you specific legal rights, and you may also have other rights which vary from state to state.

* In-home repair service is not available in all Canadian geographical areas, nor will this warranty cover user or servicer travel and transportation expenses if this product is located in a remote area (as defined by Sears Canada Inc.) where an authorized servicer is not available.

Sears Brands Management Corporation, Hoffman Estates, IL 60179

Sears Canada Inc., Toronto, Ontario, Canada M5B 2C3

IMPORTANT SAFETY INSTRUCTIONS

Read all instructions before using this appliance.

This manual contains important safety symbols and instructions. Pay attention to these symbols and follow all instructions given.

Do not attempt to install or operate your appliance until you have read the safety precautions in this manual. Safety items throughout this manual are labeled with a **WARNING** or **CAUTION** statement based on the hazard type.

DEFINITIONS

⚠ This is the safety alert symbol. It is used to alert you to potential personal injury hazards. Obey all safety messages that follow this symbol to avoid possible injury or death.

⚠ WARNING - Indicates a potentially hazardous situation which, if not avoided, may result in death or serious injury.

⚠ CAUTION - Indicates a potentially hazardous situation which, if not avoided, may result in minor or moderate injury.

Important: Indicates installation, operation, maintenance, or valuable information that is not hazard related.

⚠ WARNING Do Not Leave Children Alone - Children should not be left alone or unattended in the area where appliance is in use. They should never be allowed to sit or stand on any part of the appliance, including the storage drawer, lower broiler drawer, warmer drawer, or lower double oven.

⚠ CAUTION Wear proper apparel. Loose-fitting or hanging garments should never be worn while using this appliance. Do not let clothing or other flammable materials come into contact with hot surfaces.

⚠ WARNING If the information in this manual is not followed exactly, a fire or explosion may result causing property damage, personal injury or death.

FOR YOUR SAFETY:

- Do not store or use gasoline or other flammable vapors and liquids in the vicinity of this or any other appliance.
- **WHAT TO DO IF YOU SMELL GAS:**
 - Do not try to light any appliance.
 - Do not touch any electrical switch; do not use any phone in your building.
 - Immediately call your gas supplier from a neighbor's phone. Follow the gas supplier's instructions.
 - If you cannot reach your gas supplier, call the fire department.
- Installation and service must be performed by a qualified installer, servicer or the gas supplier.

⚠ WARNING Storage In or On Appliance— Flammable materials should not be stored in an oven, near surface units or in the storage drawer, warmer drawer or lower oven. This includes paper, plastic, and cloth items, such as cookbooks, plastic ware, and towels, as well as flammable liquids. Do not store explosives, such as aerosol cans, on or near the oven.

⚠ WARNING Never cover any slots, holes, or passages in the oven bottom or cover an entire oven rack with materials, such as aluminum foil. Doing so blocks air flow through the oven and may cause carbon monoxide poisoning. Aluminum foil linings may trap heat, causing a fire hazard.

IMPORTANT SAFETY INSTRUCTIONS

Read all instructions before using this appliance.

⚠ WARNING

Tip Over Hazard

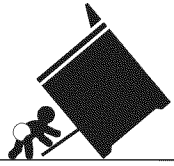

- A child or adult can tip the range and be killed.
- Verify the anti-tip device has been installed to floor or wall.

- Ensure the anti-tip device is re-engaged to floor or wall when the range is moved.
- Do not operate the range without the anti-tip device in place and engaged.
- Failure to follow these instructions can result in death or serious burns to children and adults.

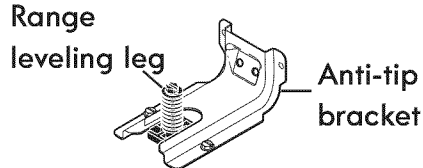

To check if the anti-tip bracket is installed properly, use both arms and grasp the rear edge of the range back. Carefully attempt to tilt range forward. When properly installed, the range should not tilt forward.

Refer to the anti-tip bracket installation instructions supplied with your range for proper installation.

Air curtain or other overhead range hoods, which operate by blowing a downward air flow on to a range, shall not be used in conjunction with gas ranges other than when the hood and range have been designed, tested and listed by an independent test laboratory for use in combination with each other.

⚠ WARNING Stepping, leaning, or sitting on the door or drawers of a range can result in serious injuries and also cause damage to the appliance. Do not allow children to climb or play around the range. The weight of a child on an open over door may cause the range to tip, resulting in serious burns or other injury.

⚠ CAUTION Do not heat unopened food containers. Build-up of pressure may cause container to burst and result in injury.

⚠ CAUTION When heating fat or grease, watch it closely. Grease may catch fire if it becomes too hot.

⚠ CAUTION Do not use water or flour on grease fires. Smother fire or flame or use dry chemical or foam-type extinguisher. Cover the fire with a pan lid or use baking soda.

⚠ CAUTION Use dry potholders. Moist or damp potholders on hot surfaces may result in burns from steam. Do not let potholders touch hot cooking areas. Do not use towels or other bulky cloths.

⚠ CAUTION Do not store items of interest to children in the cabinets above a range or on the backguard of the range. Children climbing on the range to reach items could be seriously injured.

Important: Important Safety Notice - The California Safe Drinking Water and Toxic Enforcement Act requires the governor of California to publish a list of substances known to cause cancer, birth defects, or other reproductive harms, and it requires businesses to warn customers of potential exposures to such substances.

IMPORTANT SAFETY INSTRUCTIONS

Read all instructions before using this appliance.

⚠ CAUTION Read and follow the below instructions and precautions for unpacking, installing, and servicing your appliance:

- Remove all tape and packaging before using the range. Destroy the carton and plastic bags after unpacking the range. Never allow children to play with packaging material.
- Proper Installation—Be sure your appliance is properly installed and grounded by a qualified technician in accordance with the National Fuel Gas Code ANSI Z223.- latest edition, or in Canada CAN/CGA B149.1, and CAN/CGA B149.2, and the National Electrical Code ANSI/NFPA No.70-latest edition, or in Canada CSA Standard C22.1, Canadian Electrical Code, Part 1, and local code requirements. Install only per installation instructions provided in the literature package for this range.
- User Servicing—Do not repair or replace any part of the appliance unless specifically recommended in the manuals. All other servicing should be done only by a qualified technician. This reduces the risk of personal injury and damage to the range.
- Ask your dealer to recommend a qualified technician and an authorized repair service. Sears is the recommended servicer for this appliance. Know how to disconnect the power to the range at the circuit breaker or fuse box in case of an emergency.
- Never modify or alter the construction of an range by removing the leveling legs, panels, wire covers, anti-tip brackets/screws, or any other part of the range.
- Remove the oven door from any unused range if it is to be stored or discarded.

- For electric ignition models only: Do not attempt to operate the range during a power failure. If the power fails, always turn off the range. If the range is not turned off and the power resumes, the range will begin to operate again. Once the power resumes, reset the clock and oven function.
- Cold temperatures can damage the electronic control. When using this appliance for the first time, or when the appliance has not been used for an extended period of time, be sure the appliance has been in temperatures above 32°F (0°C) for at least 3 hours before turning on the power to the appliance.
- Be sure to have an appropriate foam-type fire extinguisher available, visible, and easily located near the appliance.

IMPORTANT INSTRUCTIONS FOR USING YOUR OVEN

- Never use your appliance for warming or heating the room. Doing so may result in carbon monoxide poisoning.
- Use care when opening oven door, lower oven door, or warmer drawer (some models). Stand to the side of the range when opening the door of a hot oven. Let hot air or steam escape before you remove or replace food in the oven.
- Keep oven vent ducts unobstructed. The oven vent is located below the backguard. Touching surfaces in this area when the oven is on may cause severe burns. Do not place plastic or heat-sensitive items on or near the oven vent. These items can melt or ignite.
- Do not cook food on the oven bottom. Always cook in proper bakeware and always use the oven racks.

Save these instructions for future reference.

IMPORTANT SAFETY INSTRUCTIONS

Read all instructions before using this appliance.

- Placement of Oven Racks - Always place oven racks in desired location while oven is cool. If rack must be moved while oven is hot, use extreme caution and do not let potholder contact hot heating element in oven. Use potholders and grasp the rack with both hands to reposition. Remove all bakeware and utensils before moving the rack.
- Do not use a broiler pan without its insert. Broiler pans and inserts allow dripping fat to drain away from the high heat of the broiler. Do not cover the broiler insert with aluminum foil; exposed fat and grease could ignite.
- Protective Liners - Do not use aluminum foil to line surface unit drip bowls or oven bottoms, except as suggested in the manual. Improper installation of these liners may result in a risk of electric shock, or fire. These items will melt if put on the oven bottom.

IMPORTANT INSTRUCTIONS FOR USING YOUR COOKTOP

⚠ WARNING Use Proper Flame Size — Adjust flame size so it does not extend beyond the edge of the utensil. The use of undersized utensils will expose a portion of the burner flame to direct contact and may result in ignition of clothing. Proper relationship of utensil to flame will also improve efficiency.

- Know which knob controls each surface heating unit. Place a pan of food on the surface burner before turning it on, and turn the burner off before removing the pan.
- When flaming foods under a ventilating hood, turn the fan on.
- Use proper pan size — This appliance is equipped with one or more surface units of different sizes. Select utensils having flat bottoms large enough to cover the

burner. The use of undersized utensils will expose a portion of the flame to direct contact and may result in ignition of clothing. Proper relationship of utensil to burner will also improve efficiency.

- Utensil handles should be turned inward and not extend over adjacent surface burners — To reduce the risk of burns, ignition of flammable materials, and spillage due to unintentional contact with the utensil, the handle of the utensil should be positioned so that it is turned inward, and does not extend over adjacent surface units.
- Never leave surface burners unattended at high heat settings — Boilovers cause smoking and greasy spillovers that may ignite, or a pan that has boiled dry may melt.
- Glazed cooking utensils — Only certain types of glass, glass/ceramic, ceramic, earthenware, or other glazed utensils are suitable for cook top service without breaking due to the sudden change in temperature. Check the manufacturer's recommendations for cook top use.
- Improper cookware may break due to sudden changes in temperature. Check the cookware manufacturer's recommendations for cooktop use.
- Do not use decorative surface burner covers. If a burner is accidentally turned on, the decorative over will become hot and possibly melt. Burns will occur if the hot covers are touched. Damage may also be done to the cooktop.
- Always turn knob to the full LITE position when igniting top burners. Visually check that burner has lit. Then adjust the flame so it does not extend beyond the edge of the utensil.

IMPORTANT SAFETY INSTRUCTIONS

Read all instructions before using this appliance.

IMPORTANT INSTRUCTIONS FOR CLEANING YOUR RANGE

⚠ CAUTION Before manually cleaning any part of the range, be sure all controls are turned off and the range is cool. The range may be hot and can cause burns.

- Clean the range regularly to keep all parts free of grease that could catch fire. Pay particular attention to the area around each surface burner. Do not allow grease to accumulate.
- Always follow the manufacturer's recommended directions for use of kitchen cleaners and aerosols. Be aware that excess residue from cleaners and aerosols may ignite causing damage and injury.
- Clean ventilating hoods frequently. Grease should not be allowed to accumulate on the hood or filter. Follow the manufacturer's instructions for cleaning hoods.

IMPORTANT INSTRUCTIONS FOR CLEANING YOUR SELF-CLEANING OVENS

- Clean only the parts listed in this manual. Before using self-clean, remove the broiler pan, any food, utensils, and bakeware from the oven. Remove oven racks unless otherwise instructed.
- Do Not Use Oven Cleaners. No commercial oven cleaner or oven liner protective coating of any kind should be used in or around any part of the oven.
- Do Not Clean Door Gasket. The door gasket is essential for a good seal. Care should be taken not to rub, damage, or move the gasket.
- Some birds are extremely sensitive to the fumes given off during the self-clean cycle of any oven. Move birds to another well-ventilated room.

⚠ CAUTION DO NOT TOUCH SURFACE HEATING UNITS, OR SURFACE COOKING BURNERS, AREAS NEAR THESE SURFACE HEATING UNITS, OR INTERIOR SURFACE OF THE OVEN. Both surface burners and oven heating elements may be hot even though they are dark in color. Areas near surface cooking units may become hot enough to cause burns. During and after use, do not touch, or let clothing or other flammable materials touch these areas until they have had sufficient time to cool. Among these areas are the cook top, surfaces facing the cook top, the oven vent openings and surfaces near these openings, oven door and oven door window.

CONVERSION TO L.P. GAS

⚠ WARNING Personal injury or death from electrical shock may occur if the conversion to L.P. gas is not made by a qualified installer or electrician.

⚠ WARNING Any additions, changes or conversions required in order for this appliance to satisfactorily meet the application needs must be made by a qualified technician.

This appliance allows for conversion to Liquefied Petroleum (L.P.) Gas.

If L.P. conversion is needed, contact your local L.P. Gas provider for assistance. The L.P. conversion kit is provided with this appliance and is located on the lower REAR (back side) panel of the range. Before installing the kit be sure to read the L.P. Installation Instructions and follow them carefully when making the installation.

IMPORTANT SAFETY INSTRUCTIONS

Read all instructions before using this appliance.

GROUNDING INSTRUCTIONS

⚠ WARNING Avoid fire hazard or electrical shock. Do not use an adapter plug, an extension cord, or remove grounding prong from electrical power cord. Failure to follow this warning can cause serious injury, fire or death.

This appliance is equipped with a 3-prong grounding plug for your protection against shock hazard and should be plugged directly into a properly grounded receptacle. Do not cut or remove the grounding prong from this plug.

For personal safety, the range must be properly grounded. For maximum safety, the power cord must be plugged into an electrical outlet that is correctly polarized and properly grounded.

If a 2-prong wall receptacle is the only available outlet, it is the personal responsibility of the consumer to have it replaced with a properly grounded 3-prong wall receptacle installed by a qualified electrician.

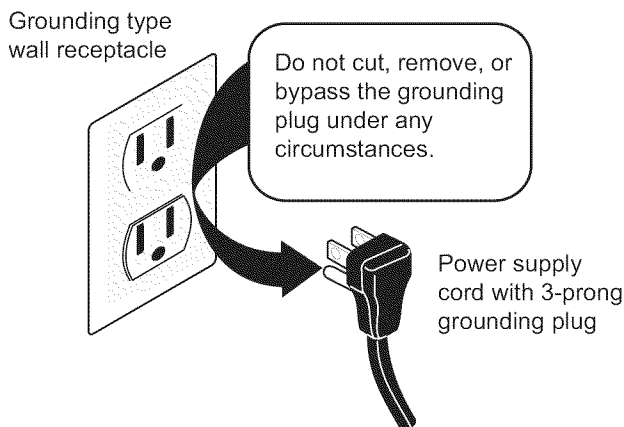

Figure 1: Grounding type wall receptacle

See the installation instructions packaged with this range for complete installation and grounding instructions.

PRODUCT RECORD

In this space below, record the date of purchase, model and serial number of your product. You will find the model and serial number printed on an identification plate. See Figure 2 for serial plate location.

Model No. _____

Serial No. _____

Date of Purchase _____

Save sales receipt for future reference.

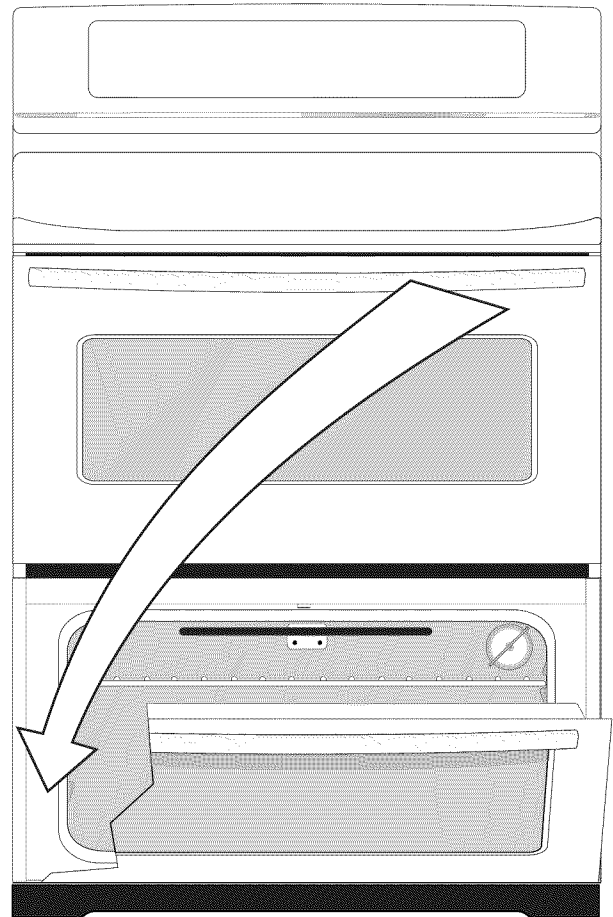

Figure 2: Serial plate location

To locate the serial plate, open the lower oven door. The serial plate is attached to the side of the oven frame.

Save these instructions for future reference.

Before Setting Surface Controls

Check burner cap placement before operating the surface burners

⚠ WARNING To prevent flare-ups and avoid creation of harmful by-products, do not use the cooktop without all burner caps properly installed to insure proper ignition and gas flame size.

It is very important to be sure that all surface burner caps and burner grates are properly installed and in the correct locations before operating the cooktop burners.

Important notes:

- Always keep surface burner caps in place whenever using a surface burner.
- When placing the burner caps, be sure that all burner caps are seated firmly and rest level on top of burner heads.
- For proper flow of gas and ignition of burners do not allow spills, food, cleaning agents or any other material to enter the gas orifice port opening.
- Burner heads are fixed. Do not try to remove them.

On round style burners, the burner cap lip (Figure 3) should fit snug into the center of burner head and rest level.

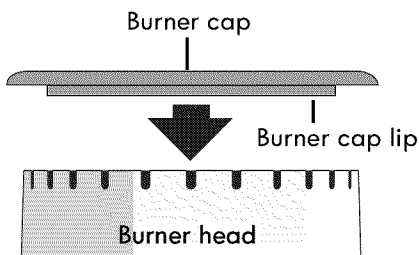

Figure 3: Burner cap lip placement

Refer to Figure 4 for correct and incorrect burner cap placement.

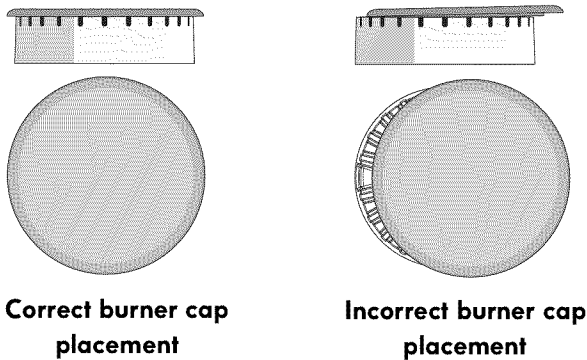

Figure 4: Correct & Incorrect Burner cap placement

Once in place, you may check the fit by gently sliding the burner cap from side to side to be sure it is centered and firmly seated (Figure 5). When the burner cap lip makes contact inside the center of the burner head you will be able to hear the burner cap click. Please note that the burner cap should NOT move off the center of the burner head when sliding from side to side.

Check and be sure that all oval style (some models) burner caps are correctly in place on oval burner heads.

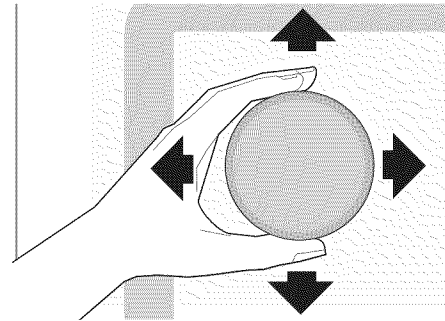

Figure 5: Checking the fit

Dual Burner cap placement

⚠ WARNING To prevent flare-ups and avoid creation of harmful by-products, do not use the cooktop without all burner caps properly installed to insure proper ignition and gas flame size.

Dual burner head (some models)

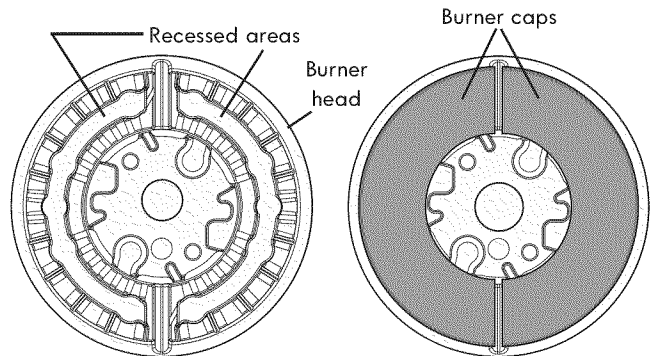
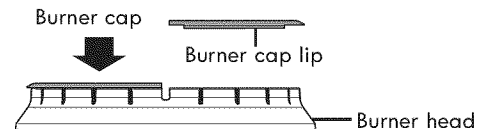

Figure 6: Dual burner cap placement

Before Setting Surface Controls

Installing Burner Grates

⚠ CAUTION Surface burners may appear to have cooled after they have been turned off. The surface burner may still be hot and burns may occur if the surface burner is touched before it has cooled sufficiently.

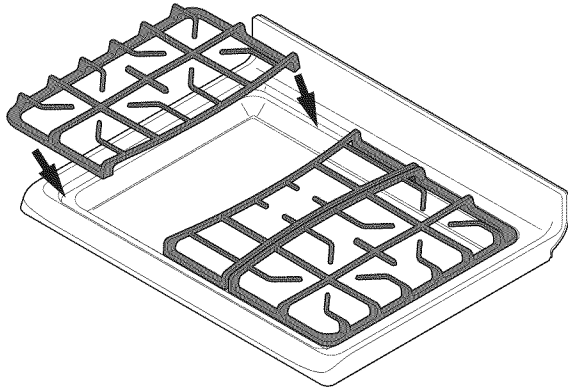

Figure 7: Burner grates placement

Make sure the burner grates are properly placed on the cooktop before using the surface burners. The grates are designed to rest inside the recess on the cooktop.

To install burner grates, place grates flat-side down and align into the cooktop recess. Grates should rest flush against each other and against the sides of the recess (Figure 7).

Using proper cookware

⚠ CAUTION Do not place flammable items such as plastic salt and pepper shakers, spoon holders or plastic wrappings on the cooktop when it is in use. These items could melt or ignite. Potholders, towels or wooden spoons could catch fire if placed too close to the range cooktop.

Important:

Do not place aluminum foil, or any material that can melt on the range cooktop. If these items melt they may damage the cooktop.

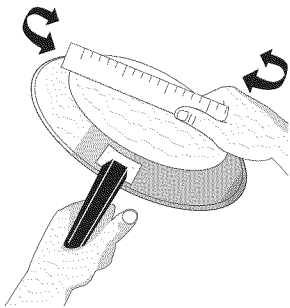

Figure 8: Testing cookware

For best cooking results, cookware should have flat bottoms that rest level on the surface burner grate. Before using cookware, check for flatness by rotating a ruler across the bottom of the cookware (Figure 8).

Important:

The size and type of utensil used, and the amount and type of food being cooked will influence the burner flame setting needed for best cooking results.

Cookware Material Types

The cookware material determines how evenly and quickly heat is transferred from the surface burner to the pan bottom. The most popular materials available are:

Aluminum - Excellent heat conductor. Some types of food will cause it to darken (Anodized aluminum cookware resists staining and pitting).

Copper - Excellent heat conductor but discolors easily (See Aluminum).

Stainless - Slow heat conductor with uneven cooking results. Is durable, easy to clean and resists staining.

Cast Iron - A slow heat conductor however will retain heat very well. Cooks evenly once cooking temperature is reached.

Porcelain-enamel on metal - Heating characteristics will vary depending on base material.

Glass - Slow heat conductor.

Using a Wok (not supplied)

⚠ CAUTION Do not use a wok if it is equipped with a metal ring that extends beyond the burner unit. Because this ring traps heat, the surface unit and cooktop surface could be damaged.

Woks with flat bottoms suitable for use on your cooktop are available in most cookware or hardware stores. Round bottomed woks (with a support ring that does not extend beyond the burner unit) may also be used. The metal ring was designed to support the wok safely when it is filled with large amounts of liquids (soup making) or fat (frying).

Wire trivets: Do not use wire trivets. Cookware bottoms must be in direct contact with the grates.

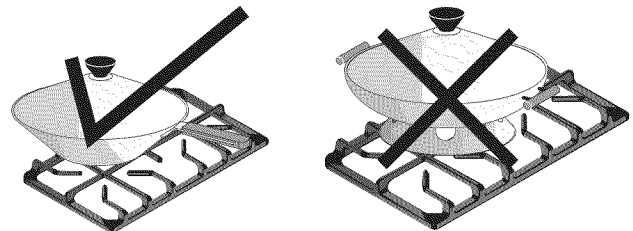

Figure 9: Wok recommendations

Setting Proper Burner Flame Size

CAUTION Never extend the flame beyond the outer edge of the cooking utensil. A higher flame wastes energy, and increases your risk of being burned by the flame.

The color of the flame is the key to proper burner adjustment. A good flame is clear, blue and hardly visible in a well-lighted room. Each cone of flame should be steady and sharp. Adjust or clean burner if flame is yellow-orange.

For most cooking: start on the highest setting and then turn to a lower setting to complete the process. Use the recommendations in Table 1 as a guide for determining proper flame size for various types of cooking.)

For deep fat frying: use a thermometer and adjust the surface knob accordingly. If the fat is too cool, the food will absorb the fat and be greasy. If the fat is too hot, the food will brown so quickly that the center will be under cooked. Do not attempt to deep fat fry too much food at once as the food will neither brown or cook properly.

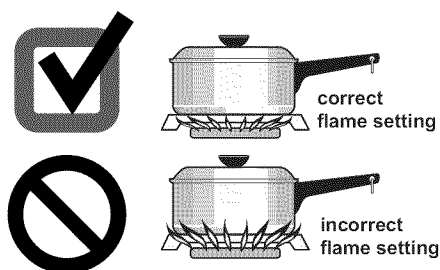

Figure 10: Correct and incorrect flame settings

Table 1: Flame size recommendations

| Flame Size* | Type of Cooking |
|--------------|---|
| High flame | Start most foods; bring water to a boil; pan broiling |
| Medium flame | Maintain a slow boil; thicken sauces; gravies; steaming |
| Low flame | Keep foods cooking; poach; stewing |

*These settings are based for medium-weight metal or aluminum pans with lids. Settings may vary when using cookware made from different materials.

Important note:

Specialty pans such as lobster pots, griddles and pressure cookers may be used but must conform to the above recommended cookware requirements.

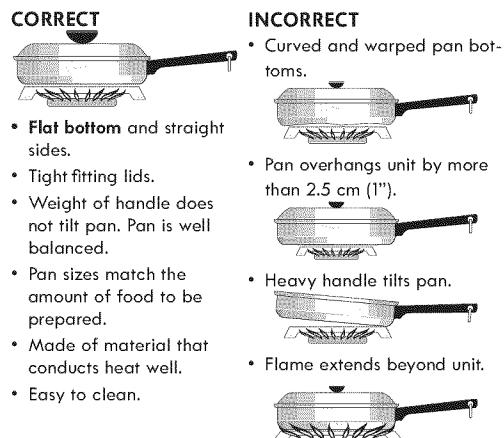

Figure 11: Cookware recommendations

Home Canning

CAUTION Canning can generate large amounts of steam. Use extreme caution to prevent burns. Always raise the lid to vent steam away from you. Safe canning requires that harmful micro-organisms are destroyed and the jars are sealed completely. When canning in a water bath canner, a gentle but steady boil must be maintained continuously for the required time.

Be sure to read and observe all the following points when home canning with your appliance. Check with the USDA (United States Department of Agriculture) Web site and be sure to read all the information they have available as well as follow their recommendations for home canning procedures.

- Use only quality flat bottom canners when home canning. Use a straight-edge to check canner bottom.
- Use only a completely flat bottom canner with no ridges that radiate from the bottom center when home canning. Heat is spread more evenly when the bottom surface is flat.
- Start with hot tap water to bring water to boil more quickly.
- Use the highest heat seating when first bringing the water to a boil. Once boiling is achieved, reduce heat to lowest possible setting to maintain that boil.
- Use tested recipes and follow instructions carefully. Check with your local Cooperative Agricultural Extension Service or a manufacturer of glass jars for the latest canning information.
- It is best to can small amounts and light loads.
- Do not leave water bath or pressure canners on high heat for an extended amount of time.
- Alternate surface units between each batch to allow the units and surrounding surfaces to cool down. Try to avoid canning on the same burner unit all day.

Setting Surface Controls

Setting Surface Burners

Your gas appliance may be equipped with different sized surface burners. The ability to heat food quicker and in larger volumes increases as the burner size increases. It is important to select cookware that is suitable for the amount and type of food being prepared.

The smaller **SIMMER** burner (on some models) is best suited for simmering delicate sauces, etc.

The standard size burners may be used for most surface cooking needs. Some models are equipped with a center burner.

The larger **POWER** burners (on some models) are recommended for bringing large quantities of liquid to temperature and when preparing larger quantities of food.

To set surface burners:

⚠ CAUTION Do not place flammable items such as plastic salt and pepper shakers, spoon holders or plastic wrappings on the cooktop when it is in use. These items could melt or ignite. Potholders, towels or wooden spoons could catch fire if placed too close to the range cooktop.

⚠ CAUTION Do not place aluminum foil, or ANY material that can melt on the range cooktop. If these items melt they may permanently damage the cooktop surface.

⚠ CAUTION When operating the oven, it is possible for residual heat from the oven to build-up and over time to eventually transfer to the surface control knobs located directly above the oven door.

1. Place cooking utensil on center of surface burner grate. Be sure the cooking utensil sets stable on the burner grate.
2. Push the desired surface control knob in and turn counterclockwise out of the OFF position (Figure 12).
3. Release the surface control knob and rotate to the LITE position. Visually check that the burner has lit.
4. Once the burner has a flame, push the control knob in and turn counterclockwise to the desired flame size. Use the control knob markings and adjust the flame as needed.

Important note:

- Do not cook with the surface control knob left in the LITE position. The electronic ignitor will continue to spark if the control knob setting remains in the LITE position.
- When setting any surface control knob to the LITE position, all electronic surface ignitors will spark at the same time. However, only the surface burner you are setting will ignite.
- Never place or straddle a cooking utensil over two different surface cooking areas at the same time unless the utensil or cookware was designed for that purpose, such as a griddle. This can cause uneven heating results.

Important: In the event of an electrical power outage, the surface burners can be lit manually. To light a surface burner, hold a lit match to the burner head, then slowly turn the surface control knob to LITE. After burner lights, turn knob to desired setting. Use caution when lighting surface burners manually.

Turboboil Flex

Your appliance is equipped with the turboboil flex boiling burner. It allows you to bring liquids to a boil, as well as maintain liquids consistently at a low, warm simmer.

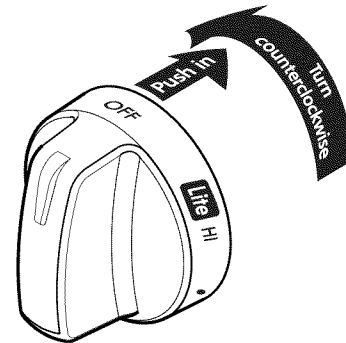

Figure 12: Surface control knob

Before Setting Oven Controls

Oven Vent Location

The oven vent is located under the control panel. When the oven is on, warm air passes through this vent. This venting is necessary for proper air circulation in the oven and good baking results. Do not block oven vent. Doing so may cause cooking failures, fire, or damage to the appliance. Steam or moisture may appear near the oven vent. This is normal.

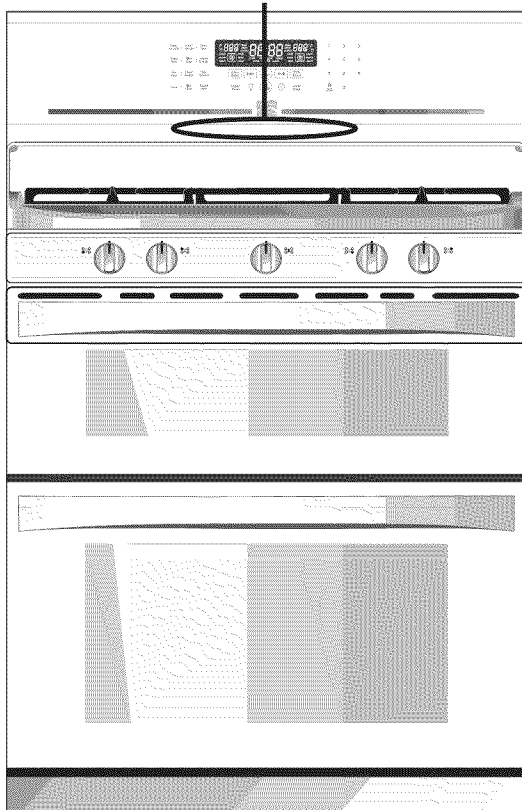

Figure 13: Oven vent location

Removing, Replacing, and Arranging Oven Racks

⚠ WARNING Protective Liners — Do not line the oven walls, racks, bottom, or any other part of the oven with aluminum foil. Doing so will alter heat distribution, produce poor baking results, and may cause permanent damage to the oven interior. During self clean temperatures, the oven will be hot enough to melt foil. Only use aluminum foil as recommended in this manual. Improper installation of these liners may result in risk of electric shock or fire.

⚠ CAUTION Always use pot holders or oven mitts when using the oven. When cooking, the oven interior and exterior, as well as the oven racks, will become very hot which can cause burns.

To Arrange: Always arrange the oven racks when the oven is cool (prior to operating the oven).

To Remove: Pull the oven rack straight forward until it reaches the stop position. Lift up front of oven rack slightly and slide out.

To Replace: Place the oven rack on the rack guides on both sides of oven walls. Tilt the front of oven rack upward slightly and slide the oven rack back into place. Be sure oven racks are level before using.

Important: This model comes with lubricated porcelain oven racks, which can remain in the oven during the self-clean cycle. Do not clean this vegetable oil lubrication off the racks. It is important that the sides of the oven racks always have a light coating of vegetable oil. To maintain optimal rack performance, re-apply a thin layer of vegetable oil to the sides of the rack after every self-clean cycle or when the rack becomes difficult to slide.

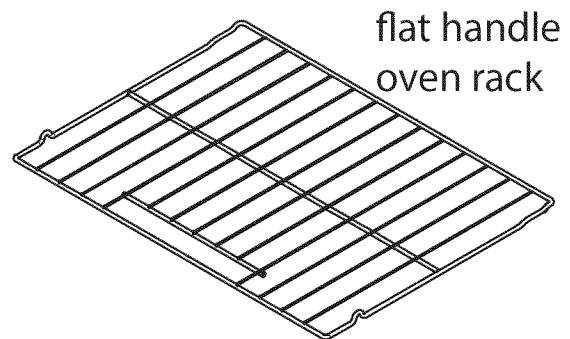

Figure 14: Oven rack type

Oven Rack Description

Flat oven racks (or the flat handle oven rack) may be used for most cooking needs and may be placed in most oven rack positions.

Air Circulation in the Oven

For best baking results allow 2-4" (5-10 cm) between the bakeware and the right and left side of the oven cavity's walls for proper air circulation and be sure pans and bakeware do not touch each other, the oven door, sides or back of the oven cavity. Hot air must be able to circulate around the bakeware in the oven for even heat to reach around the food.

Oven Controls

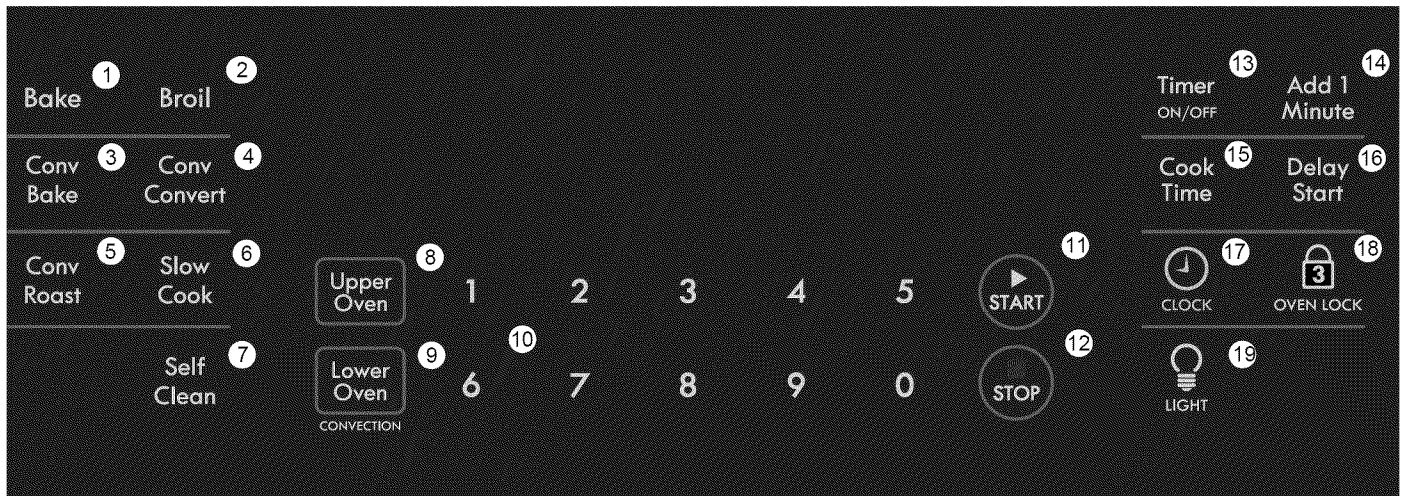

1. **Bake** - Use to start a normal bake function.
2. **Broil** - Use to select the broil function.
3. **Conv Bake** - Use to obtain the best culinary results when baking with multiple pans and racks.
4. **Conv Convert** - Use to convert a standard baking recipe temperature to a temperature for convection baking.
5. **Conv Roast** - Use to select the convection roasting function, best for cooking tender cuts of beef, lamb, pork, and poultry.
6. **Slow Cook** - Use to cook food slowly, at lower temperatures.
7. **Self Clean** - Use to select the function that cleans the oven with high temperatures, which eliminate soils completely.
8. **Upper Oven** - Use to enable the cooking modes functions for the upper oven.
9. **Lower Oven** - Use to enable the cooking modes functions for the lower oven.
10. **0 thru 9 Numeric Keys** - Use to enter temperatures and cooking times, and use to enter time of day when setting clock.
11. **START** - Use to start all oven functions.
12. **STOP** - Use to stop any cooking function except time of day and timer.
13. **Timer ON/OFF** - Use to set or cancel the minute timer. The minute timer does not start or stop cooking.
14. **Add 1 Minute** - Each press of this feature adds one minute of time to an active timer. Pressing **Add 1 Minute** will start timer when timer is idle.
15. **Cook Time** - Use to set a specific amount of time needed for cooking.

16. **Delay Start** - Use to set a delay cooking feature or delay self clean.
17. **Set Clock** - Use with numeric keys to set the time of day.
18. **OVEN LOCK** - Use to lock oven door and the control panel
19. **LIGHT** - Use to turn oven light ON and OFF

Important Things to Know Before Setting any Basic Oven Cooking Function

Important: This appliance has been factory pre-set to start any Bake, Conv Bake, or Conv Roast function with the oven set temperature automatically set for 350°F. However if desired, the oven set temperature may be adjusted at any time during the cooking process. You may also choose to add a cook time or delay start with any of the functions listed above.

Temperature Visual Display

Your appliance is equipped with a temperature visual display. When a cooking mode is set, the actual temperature will be shown in the display and will rise as the unit preheats. When the unit has reached its target temperature, a chime will sound to remind you to place the food in the oven. This feature will be active with some cooking modes: bake, convection bake and convection roast.

Important note: The lowest temperature that can be displayed is 100°F.

Minimum and Maximum Control Settings

All of the features listed have minimum and maximum time and temperature settings that may be entered into the control. An entry acceptance beep will sound each time a key is touched. An entry error tone (three short beeps) will sound if the entry of the temperature or time is below the minimum allowable setting or above the maximum setting for the cooking feature. The error tone will also sound any time a key is pressed if the entry is determined to be an invalid selection.

Table 2: Minimum and maximum control settings

| Feature | Min. Temp. or Time | Max. Temp. or Time |
|-----------------|--------------------|--------------------|
| Bake | 170°F (77°C) | 550°F (288°C) |
| Broil | 400°F (205°C) | 550°F (288°C) |
| Timer | 0:01 Min | 11 Hrs. 59 Mins. |
| Self Clean | 2 Hours | 4 Hours |
| Conv Bake | 300°F (148°C) | 550°F (288°C) |
| Conv Roast | 300°F (148°C) | 550°F (288°C) |
| Slow Cook | LO 225°F (107°C) | HI 275°F (135°C) |
| Cook Time | 0:01 Min. | 11 Hrs. 59 Mins. |
| Delay time 12hr | 1:00 Hr./Min. | 12 Hrs. 59 Mins. |
| Delay time 24hr | 0:00 Hr./Min. | 23 Hrs. 59 Mins. |
| Clock 12hr | 1:00 | 12:59 |
| Clock 24hr | 0:00 | 23:59 |

Choosing and Setting an Oven

Both the upper and lower ovens may be set to cook at the same time using different functions. For example, you may want to use the convection bake function in the lower oven while broiling in the upper oven at the same time. First, select which oven you want to set or modify by pressing either **Upper Oven** or **Lower Oven**. Then, follow the instructions in this guide to set the desired cooking functions.

The display will indicate which oven is currently available to be set by displaying **UPPER** or **LOWER** on the control.

If **UPPER** is displayed but you wish to set or change the settings for the lower oven, press **Lower Oven** once to change the oven selection. Then make the setting/changes. You may toggle between either oven and make setting changes at any time.

Important: Convection features are available only in the lower oven, and the broil feature is available only in the upper oven.

Setting The Clock

When the appliance is powered up for the first time or when the electric supply to the appliance has been interrupted, the display will flash 12:00 (Figure 15). Before any function of the oven can be set, **STOP** must be pressed. This will set the clock at 12:00. The time of day must first be set before operating the oven.

To set clock to 1:30:

1. Press **CLOCK**. CLO will appear in the display (Figure 15).



Figure 15: CLO appearing in the display

2. Press **1 3 0** using the numeric keys to set the time of day to 1:30 (Figure 16).



Figure 16: Setting time of day to 1:30

3. Press **START**, and the time of day will appear in the display (Figure 17).



Figure 17: Time of day of 1:30 appears

Important note:

The clock cannot be changed when a Cook Time, Self Clean, Delay Start, or cooking feature is active.

Setting 12 hour or 24 hour display mode

The clock display mode allows you to select 12 hour or 24 hour modes. The factory pre-set clock display mode is 12 hours.

To set 12 hour or 24 hour display mode:

1. Press and hold **CLOCK** for 6 seconds until **12 Hr** or **24 Hr** appears in the display.
2. Press **Self Clean** to toggle between **12 Hr day** or **24 Hr day** display modes (Figure 18).
3. Press **START** to accept choice.

Oven Controls



Figure 18: 12 Hr dAY (L) and 24 Hr dAY (R) settings

Reset the correct time as described in "Setting The Clock" on page 15. Note that if the 24 hour time of day mode was chosen, the clock would now display a time from 0:00 through 23:59.

Setting Timer

The timer serves as an extra timer in the kitchen that will beep when the set time has run out. It does not start or stop cooking. This feature can be used during any of the other oven control functions, except during a Self Clean. Refer to Table 2 on page 15 for time amount settings. The timer may be set from a minimum time of 1 minute to a maximum of 11 hours and 59 minutes.

Important note:

- When the timer is set for more than 1 hour, it will display hours and minutes until 1 hour remains. When less than 1 hour remains, the display counts down in minutes and seconds. With less than 1 minute remaining, only seconds will display.
- If the timer is active during a cooking process, the timer will show in the display.

To set timer for 5 minutes:

1. Press **Timer ON/OFF** (Figure 19).

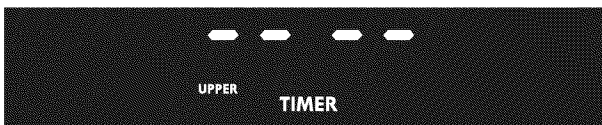

Figure 19: Set timer display

2. Enter 5 using numeric key. Press **START** and the time will begin to count down in the display (Figure 20).



Figure 20: Timer display for 5 minutes

Important note: If **START** is not pressed, the timer will return to the time of day after 30 seconds.

3. When set time ends, **END** and **TIMER** will show in the display, and the control will sound with three beeps every 7 second until **Timer ON/OFF** is pressed (Figure 21).



Figure 21: Set timer display indicating an End function

- To cancel the timer when active, press **Timer ON/OFF** again.

Add 1 Minute

Use **Add 1 Minute** to set additional minutes to the timer. Each press of the key will add 1 minute. If **Add 1 Minute** is pressed when the timer is not active, the timer will activate and begin counting down from 1 minute.

To add 2 minutes to the timer:

- Press **Add 1 Minute** twice.

Changing Between Continuous Bake Setting or 12 Hour Energy Saving

The oven control has a factory preset built-in 12 Hour Energy Saving feature that will turn off the oven if the oven is left on for more than 12 hours. The control may be programmed to override this feature to bake continuously.

To change between continuous bake or 12 Hour Energy Saving feature:

1. Press and hold **Timer ON/OFF** for 6 seconds (Figure 22).

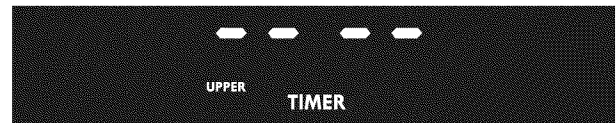

Figure 22: Indication for Timer ON/OFF

2. After 6 seconds, **12 Hr OFF** or **StAY On** will appear in the display, and the control will beep once (Figure 23). **12 Hr Off** indicates the control is set for the 12 Hour Energy Saving mode, and **Stay On** indicates the control is set for Continuous Bake feature.



Figure 23: 12 hr energy saving (L) and continuous setting (R)

3. Press **Self Clean** to toggle between 12 Hour OFF or Stay On feature (Figure 23).

- Press **START** to accept choice, and the display will return to the time of day (Figure 24). Or press **STOP** to reject the change.



Figure 24: Display returning to time of day

Changing Oven Temperature Display - Fahrenheit (°F) or Celsius (°C):

The oven control is preset for temperatures in °F when shipped from the factory. The control can be changed to display either °F or °C. Broil and Self Clean control the °F or °C modes.

Important: Both ovens will be changed at the same time.

To change the display to °F or °C:

- Press and hold **Broil** for 6 seconds. A beep will sound, 550 will appear and **BROIL** will flash in the display.
- After 6 seconds, a beep will be heard, and F (or C) will appear in the display (Figure 25).



Figure 25: Display showing Fahrenheit (L) and Celsius (R)

- Press **Self Clean** to toggle between °F and °C temperature display modes.
- Press **START** to accept choice or **STOP** to reject it.

Setting Silent or Audible Control mode

Silent mode allows the oven control to operate without audible tones. The control may be programmed for silent operation and later reset to operate with all the normal audible tones.

To set for silent or audible mode:

- Press and hold **Delay Start** for 6 seconds (Figure 26).

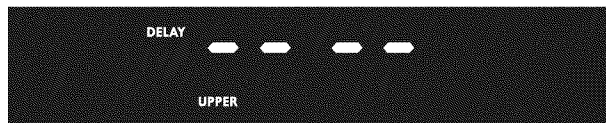

Figure 26: Display when setting silent or audible

- After 6 seconds, **bEEP On** will appear in the display. Press **Self Clean** to toggle between **bEEP On** or **bEEP OFF** (Figure 27).



Figure 27: bEEP On (L) and bEEP OFF (R) operation

- Press **START** to accept choice or **STOP** to reject it.

Important note:

The control will always beep once a timer operation finishes and when a set temperature has been reached, even if the control is set to silent operation.

Setting Oven Controls Lockout

The oven lockout feature automatically locks the oven door and prevents the oven from being turned on. It does not disable the clock, timer, or the interior oven lights. The ovens can be locked individually.

To activate the oven lockout features:

- Be sure the oven door is completely closed. Press **Upper Oven** or **Lower Oven**.
- Press and hold **OVEN LOCK** for 3 seconds. After 3 seconds, **DOOR** and **LOCKED** will flash and **Loc** will appear in the display. Once the oven door is locked the **DOOR** and **LOCKED** indicator will stop flashing and remain in the display. Allow 15 seconds for the oven door to lock.

To cancel the oven lockout feature:

- Press **Upper Oven** or **Lower Oven**.
- Press and hold **OVEN LOCK** for 3 seconds. The motor door latch will begin unlocking the oven door automatically. Do not open the oven door. Allow about 15 seconds for the oven door to completely unlock.
- When the **Loc** message no longer displays, the oven door may be opened, and the oven control keys will be available for use.

Important note:

- To avoid damage to the oven door latching mechanism, do not attempt to open or close the oven door whenever the **Loc** message is displayed.
- If a control key is pressed when oven lockout is active, the control will triple beep indicating the key action is not available when the oven lockout feature is active.
- Because you can set the oven lockout individually, the lower oven can be used when the upper oven lockout feature is on.

Oven Controls

Operating Oven Lights

The interior oven lights will automatically turn on when the oven door is opened. The oven light will not operate during a self clean cycle. Press **LIGHT** to turn the interior oven lights on and off whenever the oven door is closed. The interior oven lights are located on the rear wall of the oven interior and are covered with a glass shield. The glass shield protects the bulb from high temperatures and should always be in place whenever the oven is in use.

Important: For best baking results, do not leave oven light on while cooking.

To replace the interior oven light in the upper oven, see "Replacing the Round Halogen Oven Light" on page 39. To replace the interior oven light in the lower oven, see "Replacing the Rectangle Halogen Oven Light" on page 39.

Setting Bake

Use the bake feature whenever the recipe calls for baking using normal temperatures. A reminder tone will sound indicating when the set bake temperature is reached and to place the food in the oven.

Bake may be set for any oven temperature between 170°F (77°C) to 550°F (288°C).

To set **Bake** for oven temperature of 350°F (177°C):

⚠ CAUTION Always use pot holders or oven mitts when using the oven. When cooking, the oven interior, oven exterior, oven racks, and cooktop will become very hot which can cause burns.

⚠ CAUTION Do not bake food directly on the oven bottom. To avoid damaging the oven interior and surfaces, always bake food in the oven using bakeware positioned on an oven rack.

1. Arrange interior oven racks and place food in oven.
2. Press **Upper Oven** or **Lower Oven**.
3. Press **Bake**. 350° will appear in the display (Figure 28).



Figure 28: Setting bake

4. Press **START**. The actual oven temperature will be displayed (Figure 29). A beep will sound once the oven temperature reaches 350°F.



Figure 29: Actual oven temp displays while setting bake

5. To cancel Bake at any time, press **STOP**.

To change the bake temperature from 350°F to 425°F:

1. After the oven has already been set to bake at 350°F, press **Bake**.
2. Press **4 2 5**. 425° will appear in the display (Figure 30).



Figure 30: 425° appears in the display

3. Press **START**. The actual oven temperature will be displayed and a beep will sound once the oven temperature reaches 425°F.
4. To cancel Bake at any time, press **STOP**.

Important note:

If the oven was recently heated from prior cooking and has remained heated, the bake burner symbol may not show in the display immediately.

Important: If bake is active without a cook time setting, the oven will remain on for 12 hours before turning off automatically unless it is cancelled. To bake longer than 12 hours, see "Changing Between Continuous Bake Setting or 12 Hour Energy Saving" on page 16 for instructions.

Table 3: Rack Position Recommendations

| Food | Lower | Upper |
|---|--------|--------|
| Cookies, muffins, cakes, and pies | | |
| To bake on 1 flat rack | 2 | 2 |
| To bake on 2 flat racks | 1 & 3 | N/A |
| Frozen pies, angel food cake, yeast, bread, casseroles, small cuts of meat or poultry | 1 or 2 | 1 or 2 |
| Turkey, roast, or ham | 1 | N/A |
| Pizza | 1 | 1 |

Important note:

Do not put food into oven until preheat is complete. Bake will stay on continuously until the oven reaches the target temperature.

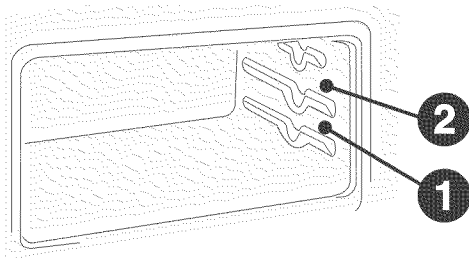

Figure 31: Upper oven rack positions

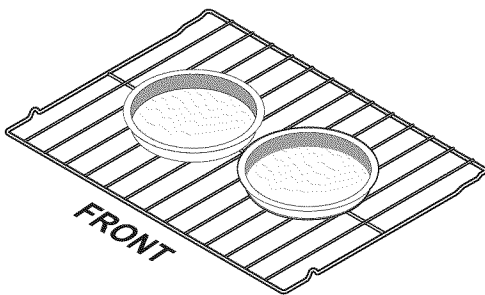

Figure 32: Upper oven pan spacing

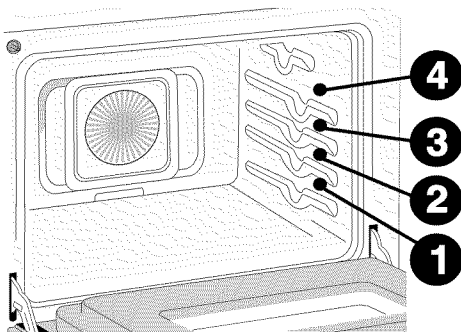

Figure 33: Lower oven rack positions

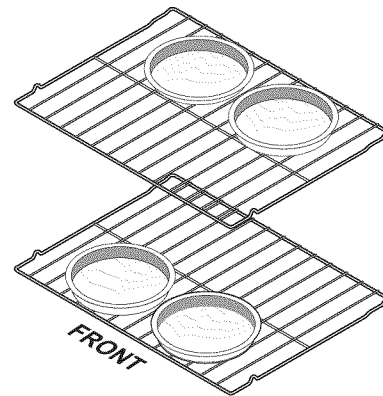

Figure 34: Lower oven, multi rack pan spacing

For best results:

- Fully preheat the oven before baking items like cookies, cakes, biscuits, or breads.
- When using a single rack for baking, position the rack so that the food is in the center of the oven. If using a single rack in the upper oven, use position 2.
- For best results when baking cakes using two oven racks, place bakeware on oven rack positions 1 and 3 (Figure 33) and place pans as shown in Figure 34.
- Use positions 1 and 3 when baking cookies on multiple pans in the lower oven.
- Allow at least 2 inches (5 cm) of space between the right and left side of the bakeware and the oven cavity's wall for proper air circulation (Figure 32).
- Dark or dull pans and glass absorb more heat than shiny bakeware resulting in dark or over browning of foods. To prevent this it may be necessary to reduce the oven temperature or cook time to prevent over browning of some foods. Dark pans are recommended for pies. Shiny pans are recommended for cakes, cookies and muffins.
- Do not open the oven door too often. Opening the door will reduce the temperature in the oven.
- For cakes, pastries, and breads, use the convection bake function for best results when using multiple racks.

Oven Controls

Setting Cook Time

Cook time is used when a recipe calls for a specific temperature and cook time. It allows the oven to be set to cook for a set length of time and shut off automatically. The maximum cook time is 11 hours, 59 minutes. This feature can be used with bake, convection bake, convection roast, and slow cook.

To program oven to bake with oven default temperature of 350°F (177°C) and to shut-off after 30 minutes:

⚠ WARNING Food Poisoning Hazard. Do not let food sit for more than one hour before or after cooking. Doing so can result in food poisoning or sickness. Foods that can easily spoil such as milk, eggs, fish, meat, or poultry should be chilled in the refrigerator first. Even when chilled, they should not stand in the oven for more than 1 hour before cooking begins and should be removed promptly when finished cooking.

⚠ CAUTION Use the automatic timer when cooking cured or frozen meats and most fruits and vegetables.

1. Be sure the clock is set for the correct time of day.
2. Arrange interior oven rack(s) and place the food in the oven.
3. Press **Upper Oven** or **Lower Oven**.
4. Press **Bake** (Figure 35).



Figure 35: Setting bake for cook time

5. Press **START**. The actual oven temperature will be displayed (Figure 36).



Figure 36: Actual oven temperature appears

6. Press **Cook Time** (Figure 37).

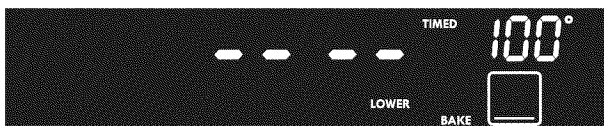

Figure 37: Cook time display

7. Enter 3 0 using numeric keys (Figure 38).



Figure 38: Entering 30 for cook time

8. Press **START** to accept. The display returns to the time of day (Figure 39).



Figure 39: Display returns to the time of day

Important note:

After the timed bake feature has been activated, press Cook Time to display the bake time remaining. Once a time baked has started, a beep will sound when the oven temperature reaches the set temperature.

9. Press **STOP** when baking has finished or at any time to cancel the feature.

When the programmed cook time ends:

1. End will appear in the display window, and the oven will shut-off automatically (Figure 40).



Figure 40: End appearing in display

2. The oven control will beep three times every 30 seconds as a reminder until **STOP** is pressed.

Setting Delay Start

Bake, Cook Time, and Delay Start control the Delay Start feature, which sets a delayed starting and stopping time to the oven cooking or cleaning functions. Prior to setting a delay start, be sure the time of day is set correctly.

Delay Start may be used with Convection Bake, Convection Roast, Convection Convert, Bake, Slow Cook, and Self Clean. Delay Start or Cook Time will not operate with the Broil function.

Important note:

- Delay Start may be set using a 24 hr clock. To set clock for 24 Hr operation, see “Setting 12 hour or 24 hour display mode” on page 15 for more information.
- If your clock is set for normal 12 hour display mode, the Delayed Time Bake or Delayed Timed Convection Bake cycle can never be set to start more than 12 hours in advance.

To program oven for a Delay Start beginning at 5:30, to shut-off automatically after 30 minutes, and for baking at 350°F (177°C):

⚠ WARNING Food Poisoning Hazard. Do not let food sit for more than one hour before or after cooking. Doing so can result in food poisoning or sickness. Foods that can easily spoil such as milk, eggs, fish, meat, or poultry should be chilled in the refrigerator first. Even when chilled, they should not stand in the oven for more than 1 hour before cooking begins and should be removed promptly when finished cooking

1. Be sure the clock is set for the correct time of day.
2. Arrange interior oven rack(s) and place the food in the oven.
3. Press **Upper Oven** or **Lower Oven**.
4. Press **Bake** (Figure 41).



Figure 41: Setting bake for Delay Start

5. Press **START**. The actual oven temperature will be displayed (Figure 42).



Figure 42: Actual oven temperature appearing in display

6. Press **Cook Time** (Figure 43).

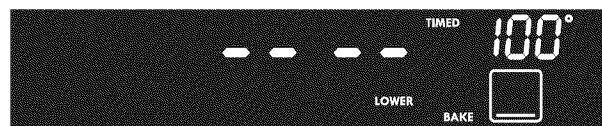

Figure 43: Display for setting cook time

7. Enter 30 using numeric keys (Figure 44).

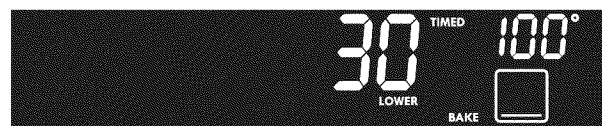

Figure 44: Entering 30 in the display

8. Press **START** to accept. The display returns to the time of day (Figure 45).



Figure 45: Display returning to time of day

9. Press **Delay Start** (Figure 46).

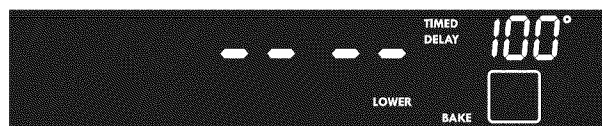

Figure 46: Display after pressing Delay Start

10. Enter 5 3 0 on the numeric keypad, the desired start time (Figure 47).



Figure 47: Display for 5 3 0 entered

11. Press **START**. The current time of day will appear in the display (Figure 48).



Figure 48: Time of day returning to display

Oven Controls

12. When the desired start time is reached, the oven icon will appear in the display, and the oven will start to bake at the previously selected temperature.
13. Press **STOP** when baking has completed or at any time to cancel Delay Start.

When the set bake time runs out:

1. **End** will appear in the display window, and the oven will shut off automatically (Figure 49).



Figure 49: End appearing in the display

2. The oven control will beep, and End will remain in the display until **STOP** is pressed.

Setting Broil

Use the broil function to cook meats that require direct exposure to radiant heat for optimum browning results. The Broil feature is factory preset to broil at 550°F. The Broil function temperature may be set at any temperature between 400°F (205°C) and 550°F (288°C). **Broil is only available in the upper oven.**

The suggested broil settings in Table 4 are recommendations only. Depending on cooking preferences, you can increase or decrease cooking times or move food to a different rack position. If the food you are broiling is not listed in the table, follow the instructions provided in your cookbook and watch the item closely.

⚠ WARNING Should an oven fire occur, close the oven door and turn the oven off. If the fire continues, use a fire extinguisher. Do not put water or flour on the fire. Flour may be explosive.

⚠ CAUTION Always use pot holders or oven mitts when using the oven. When cooking, the oven interior, exterior, oven racks, and oven will become very hot which can cause burns.

Important note:

- Always arrange oven racks when oven is cool. **Be sure to close oven door when broiling.**
- For best results when broiling, use quality broil pan along with a broil pan insert. A broil pan is designed to drain the fat from food, helping to reduce smoking and avoid splatter. Do not use the pan without the insert. Do not cover the insert with foil. The exposed grease could ignite.
- When broiling, always pull the oven rack out to the stop position before turning or removing food.

Table 4: Suggested broil settings^{1, 2}

| Food | Upper Oven Rack Position | Setting | Cook Time in minutes | | Internal Temp Setting | Preparation |
|-----------------------|--------------------------|-------------|----------------------|----------|-----------------------|-------------|
| | | | 1st side | 2nd side | | |
| Steak 1" thick | 1st | 550°F/288°C | 6:00 | 4:00 | 135°F/57°C | Rare |
| Steak 1" thick | 1st | 550°F/288°C | 7:00 | 5:00 | 160°F/71°C | Medium |
| Steak 1" thick | 1st | 550°F/288°C | 8:00 | 7:00 | 170°F/77°C | Well |
| Pork chops 3/4" thick | 1st | 550°F/288°C | 8:00 | 6:00 | 170°F/77°C | Well |
| Chicken (bone in) | 2nd | 450°F/232°C | 20:00 | 10:00 | 170°F/77°C | Well |
| Chicken (boneless) | 1st | 450°F/232°C | 8:00 | 6:00 | 170°F/77°C | Well |
| Fish | 1st | 500°F/260°C | 13:00 | n/a | 170°F/77°C | Well |
| Shrimp | 2nd | 550°F/288°C | 5:00 | n/a | 170°F/77°C | Well |
| Hamburger 1" thick | 1st | 550°F/288°C | 9:00 | 7:00 | 145°F/63°C | Medium |
| Hamburger 1" thick | 1st | 550°F/288°C | 10:00 | 8:00 | 170°F/77°C | Well |

1. The U.S. Department of Agriculture states, "Rare fresh beef is popular, but you should know that cooking it to only 140°F (60°C) means some food poisoning organisms may survive." (Source: Safe Food Book, Your Kitchen Guide, USDA Rev. June 1985.) The lowest temperature recommended by the USDA is 145°F (63°C) for medium rare fresh beef. For beef medium 160°F, well done 170°F.
2. Broiling is direct heat cooking and will produce some smoke. If smoke is excessive, place food further away from the element. Always watch food carefully to prevent burning.

To set Broil with the default broil oven temperature of 550°F:

1. Arrange the oven racks when cool. For optimum browning results, preheat oven for 2 minutes before adding food.
2. Press **Upper Oven**.
3. Press **Broil**.
4. Press **START**. Place the food in the oven, and be sure to close the oven door when broiling.
5. Broil on one side until food is browned; turn and broil other side until done to your satisfaction.
6. When finished broiling, press **STOP**. Always pull the rack out to the stop position before turning or removing food.
7. To cancel Broil at any time, press **STOP**.

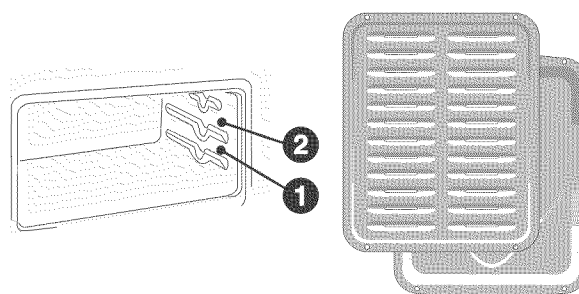

Figure 50: Broil rack positions (L) and broil pan with insert (R)

If a broiler pan and insert are not supplied with this appliance you may purchase them. Call Sears at 1-800-4-MY-HOME (1-800-469-4663) and order broiler pan kit 5304442087.

Setting Convection Bake

Convection functions use a fan to circulate the oven's heat uniformly and continuously around the oven (Figure 51). This improved heat distribution allows for fast, even baking and browning results. It also gives better baking results when using two oven racks at the same time. Heated air flows around the food from all sides, sealing in juices and flavors. Breads and pastry brown more evenly. Most foods baked in a standard pan will bake faster and more evenly with the convection feature. Multiple rack baking may slightly increase bake time for some foods, but the overall result is time saved.

Convection Bake is available only in the lower oven, and it may be set for any oven temperature between 300°F (148°C) to 550°F (288°C).

Important: The convection bake feature is best used when the recipe instructions have been written especially for convection baking. If the recipe instructions are for baking and you wish to use convection baking, follow the "Setting Convection Convert" instructions on page 26. Convection convert will automatically adjust the oven temperature so that convection baking will provide the best possible results.

Benefits of convection bake:

- Superior multiple oven rack performance
- Foods bake more evenly
- No special pans or bakeware required
- Foods can bake up to 25 to 30% faster.

Convection bake may be set with the following options:

- Convection convert
- Cook time

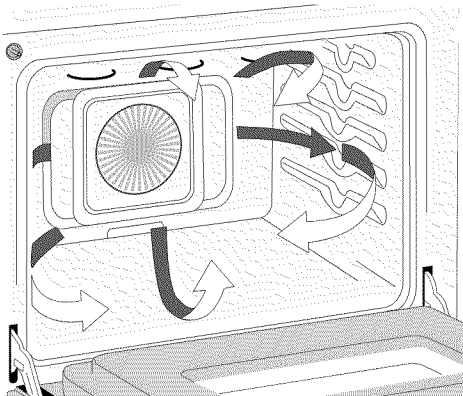

Figure 51: Air circulation in the convection function

To set Convection Bake with the default oven set temperature of 350°F (177°C):

CAUTION Always use pot holders or oven mitts when using the oven. When cooking, the oven interior, oven exterior, oven racks, and cooktop will become very hot which can cause burns.

CAUTION Do not bake food directly on the oven bottom. To avoid damaging the oven interior and surfaces, always bake food in the oven using bakeware positioned on an oven rack.

1. Arrange oven racks and place food in the oven.
2. Press **Lower Oven**.
3. Press **Conv Bake** (Figure 52).



Figure 52: Display for setting convection bake

4. Press **START**. The actual oven temperature will be displayed.



Figure 53: Actual oven temperature displays

5. A beep will sound once the oven temperature reaches 350°F (177°C). The convection fan will start as soon as convection bake has been into the cycle for six minutes (Figure 54).



Figure 54: Display for convection fan starting

6. Press **STOP** to cancel Convection Bake at any time.

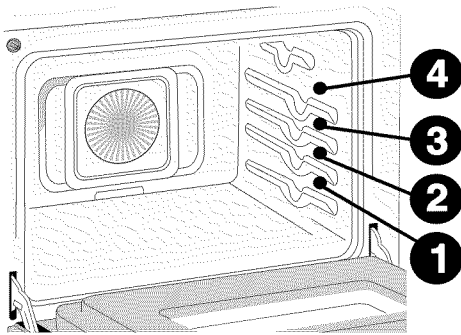

Figure 55: Lower oven rack positions

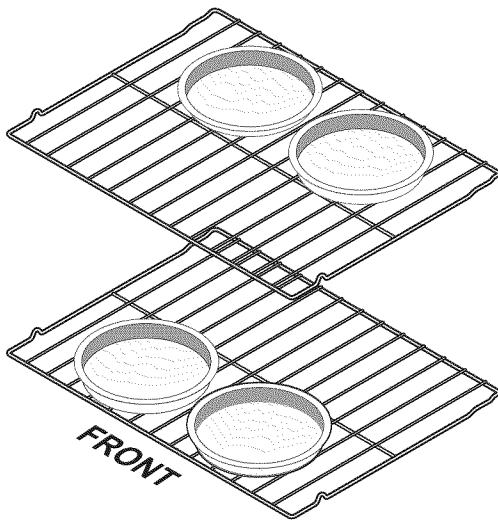

Figure 56: Lower oven, multi rack convection pan spacing

Convection Baking/Convert Tips

- Fully preheat the oven before baking items like cookies, biscuits, and breads.
- When using any single oven rack, position the rack in the oven so that the food is in the center of the oven.
- When baking cakes using two oven racks, place bakeware in positions 1 and 3 (Figure 55) and place pans as shown in Figure 56.
- Allow at least 2 inches (5 cm) of space between bakeware and the right and left side of the oven cavity for proper air circulation.
- Cookies and biscuits should be baked on pans with no sides or very low sides to allow air to circulate around the food.
- Dark or dull bakeware absorbs more heat than shiny bakeware, resulting in dark or overbrowned foods. It may be necessary to reduce oven temperature or bake time to prevent overbrowning of some foods. Dark bakeware is recommended for pies. Shiny bakeware is recommended for cakes, cookies, and muffins.
- Do not open the oven door often. Opening the door will reduce the temperature in the oven and may increase bake time.
- Reduce oven temperature 25°F (14°C) from recipe's recommended oven temperature. Follow the remainder of the recipe's instructions using the minimum recommended bake time.
- For cakes, pastries, and breads, use the convection bake function for best results when using multiple racks.
- The convection fan on a gas range will not begin rotating until Convection Bake has been into the cycle for six minutes.

Oven Controls

Setting Convection Convert

Use convection convert (only in the lower oven) to automatically convert any normal baking recipe into a convection bake recipe. The control uses the normal recipe settings and adjusts to a lower temperature for convection baking. When set properly, this feature is designed to display the actual converted (reduced) temperature in the display. Convection convert can only be used with convection bake.

Benefits of convection convert:

- Superior multiple oven rack performance
- Some foods bake faster, saving time and energy
- No special bakeware required

Important: When using convection convert, bake time reductions may vary depending on the open temperature setting. Convection convert reduces original temperatures by 25°F (14°C).

Important note:

- When using Convection Convert feature, Cook Time reductions may vary depending on the oven set temperature.
- The convection fan will begin rotating once Convection Bake, Convection Roast, or Convection Convert have been into the cycle for six minutes.
- If the oven door is opened when any convection function is active, the convection fan will stop rotating until the oven door is closed.

To program oven for Convection Convert with recipe temperature of 350°F (177°C):

⚠ CAUTION Always use pot holders or oven mitts when using the oven. When cooking, the oven interior, oven exterior, oven racks, and cooktop will become very hot which can cause burns.

⚠ CAUTION Do not bake food directly on the oven bottom. To avoid damaging the oven interior and surfaces, always bake food in the oven using bakeware positioned on an oven rack.

1. Arrange oven racks and place food in oven.
2. Press **Lower Oven**.
3. Press **Conv Bake** (Figure 57).



Figure 57: Display for setting convec convert

4. Press **START**. (If a cook time or delay start is desired, enter the times now.)

5. Press **Conv Convert**. **CONV BAKE** and the oven temperature adjustment will appear in the display, for this example **325°**. The set bake temperature will convert to a lower temperature and begin baking process. A beep will sound once the adjusted oven temperature is reached (Figure 58).



Figure 58: CONV BAKE appears in display

Important note:

When used with a cook time, convection convert will display **CF** for check food when the bake time is 75% complete (Figure 59). The minimum amount of cook time using convection convert with Cook Time is 20 minutes.



Figure 59: CF appears in the display

When the bake time has completely finished, the control will display **End** (Figure 60) and will sound three long beeps every 30 seconds until **STOP** is pressed.



Figure 60: End appears in the display

6. To cancel Convection Convert at any time, press .

Important: Set Cook Time before pressing **Conv Convert** in Step 5.

Setting Convection Roast

The Convection Roast function is available in the lower oven only. It combines a cook cycle with the convection fan to roast meats and poultry. Meats cooked using the Convection Roast function will be juicier, and poultry will be crisp on the outside while staying tender and moist on the inside. Heated air circulates around the meat from all sides, gently browning the exterior and sealing in the juices and flavors. Use this mode when cooking speed is desired.

Convection Roast may be set for any oven temperature between 300°F (148°C) to 550°F (288°C).

To set Convection Roast with an oven set temperature of 375°F (191°C):

⚠ CAUTION Always use pot holders or oven mitts when using the oven. When cooking, the oven interior and oven racks will become very hot which can cause burns. Do not cover the broiler pan/insert with aluminum foil; the exposed grease could ignite.

⚠ WARNING Should an oven fire occur, close the oven door and turn the oven off. If the fire continues, throw baking soda on the fire or use a fire extinguisher. Do not put water or flour on fire. Flour may be explosive, and water can cause a grease fire to spread and cause personal injury.

1. Arrange oven racks and place food in oven.
2. Press **Lower Oven**.
3. Press **Conv Roast** (Figure 61).



Figure 61: Display for setting Convec Roast

4. Enter the desired roasting temperature (3 7 5) using the numeric keypad.
5. Press **START**. The actual oven temperature will be displayed. The convection fan and element will start with a delay of approximately 6 minutes (Figure 62).



Figure 62: Actual oven temperature displays

6. To cancel Convection Roast at any time, press **STOP**.

Important note:

- The convection fan will begin rotating once Convection Bake, Convection Roast, or Convection Convert have been into the cycle for six minutes.
- If the oven door is opened when any convection function is active, the convection fan will stop rotating until the oven door is closed.

Roasting Rack Instructions (if equipped):

When preparing meats for convection roasting, use broiler pan and insert along with the roasting rack. The broiler pan will catch grease spills and the insert will prevent grease splatters. The roasting rack will allow the heat to circulate around the meat.

1. Place the oven rack on bottom or next to the bottom oven rack position.
2. Place the insert/grid on the broiler pan. Make sure the insert is securely seated on top of the broiler pan. Do not use the broiler pan without the insert. Do not cover the insert with aluminum foil.
3. Next, place the roasting rack on the insert/grid. Make sure the roasting rack is securely seated on the grid in the broiler pan. The roasting rack allows the heated air to circulate under the food for even cooking and helps to increase browning on the underside.
4. Place meat (fat side up) on insert (Figure 63). Place prepared food on oven rack and slide into oven.

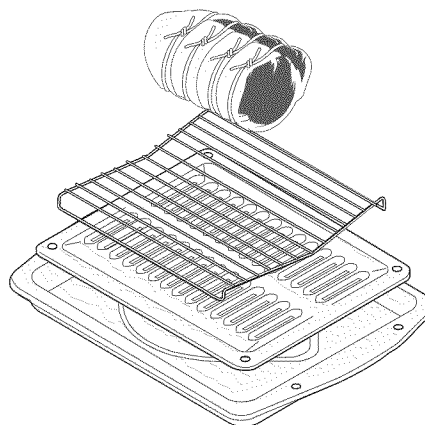

Figure 63: Meat, insert placement

Oven Controls

Table 5: Convection roasting temperature and time recommendations

| Meat | | Weight | Oven Temp | Internal Temp | Minutes per lb. |
|---------|---------------------------------|---------------|---------------------------|---------------------------|-----------------|
| Beef | Standing rib roast ¹ | 4 to 6 lbs. | 350°F (177°C) | 160°F (71°C) ¹ | 25-30 |
| | Ribeye roast ¹ | 4 to 6 lbs. | 350°F (177°C) | 160°F (71°C) ¹ | 25-30 |
| | Tenderloin roast ¹ | 2 to 3 lbs. | 400°F (204°C) | 160°F (71°C) ¹ | 15-25 |
| Poultry | Turkey whole ² | 12 to 16 lbs. | 325°F (163°C) | 180°F (82°C) | 8-10 |
| | Turkey whole ² | 16 to 20 lbs. | 325°F (163°C) | 180°F (82°C) | 10-15 |
| | Turkey whole ² | 20 to 24 lbs. | 325°F (163°C) | 180°F (82°C) | 12-16 |
| | Chicken | 3 to 4 lbs. | 350°F-375°F (177°C-191°F) | 180°F (82°C) | 12-16 |
| Pork | Ham roast, fresh | 4 to 6 lbs. | 325°F (163°C) | 160°F (71°C) | 30-40 |
| | Shoulder blade roast | 4 to 6 lbs. | 325°F (163°C) | 160°F (71°C) | 20-30 |
| | Loin | 3 to 4 lbs. | 325°F (163°C) | 160°F (71°C) | 20-25 |
| | Pre-cooked ham | 5 to 7 lbs. | 325°F (163°C) | 160°F (71°C) | 30-40 |

- For beef, medium 160°F. Well done 170°F. The U.S. Department of Agriculture states, "Rare fresh beef is popular, but you should know that cooking it to only 140°F (60°C) means some food poisoning organisms may survive." (Source: Safe Food Book, Your Kitchen Guide, USDA Rev. June 1985.) The lowest temperature recommended by the USDA is 145°F (63°C) for medium rare fresh beef. For beef medium 160°F, well done 170°F.
- Stuffed turkey requires additional roasting time. Shield legs and breast with foil to prevent over browning and drying of the skin. Stuffing should be about 165°F.

Convection Roasting tips:

- Preheating for convection roast will not be necessary for most meats and poultry.
- Arrange oven racks so the food is in the center of the oven.
- Since convection roast cooks faster, you can reduce cook times by 25% from the recommended time of your recipe (check the food at this time). Then if needed, increase cook time until the desired doneness is obtained.
- Do not cover foods when dry roasting - covering will prevent the meat from browning properly.
- Be sure to carefully follow your recipe's temperature and time recommendations or refer to the convection roast recommendations in Table 5.
- Use the broiler pan and insert, as well as the roasting rack (Figure 63) (some models). The broiler pan will catch grease spills, and the insert will help prevent splatters. The roasting rack will hold the meat.
- Do not use the broiler pan without the grid or cover the grid with aluminum foil.
- Always pull the rack out to the stop position before removing food.
- It is not recommended to roast chicken on a roasting rack. Use a deep pan instead on rack position 1.

Setting Slow Cook

The Slow Cook feature cooks foods more slowly and at lower oven temperatures for longer periods of time. Slow Cook is ideal for roasting beef, pork, and poultry. Slow cooking meats may result in the exterior of meats becoming dark but will not burn the outside as it seals in the meat's juices.

Two Slow Cook settings are available: high (Hi) or low (Lo). The high setting is best for cooking foods between 4 and 5 hours. The low setting is best for cooking foods up to 9 hours or longer.

Tips for best results when using Slow Cook:

- Completely thaw all frozen foods before cooking.
- Place rack so food is in the center of the oven. Position racks to accommodate the size of various bakeware when cooking multiple food items.
- Do not open the oven door often or leave the door open when checking foods. If the oven heat escapes often, the Slow Cook time may need to be extended.
- Cover to keep foods moist or use a loose or vented type cover to allow foods to turn crisp or brown.
- Cook times will vary depending on the weight, fat content, bone, and the shape of the roast.
- Preheating the oven will not be necessary when using the Slow Cook feature.
- Add any cream or cheese sauces during the last hour of cooking.
- Use the recipe's recommended food temperature and a food thermometer to determine when the food is done.

Important note:

- Slow Cook may be used with additional settings of Cook Time and Delay Start.
- The maximum cook time for Slow Cook function is 11 hours and 59 minutes unless the control has been changed to the continuous bake mode.

To set Slow Cook:

⚠ WARNING Food Poisoning Hazard. Do not let food sit for more than one hour before or after cooking. Doing so can result in food poisoning or sickness. Foods that can easily spoil such as milk, eggs, fish, meat, or poultry should be chilled in the refrigerator first. Even when chilled, they should not stand in the oven for more than 1 hour before cooking begins and should be removed promptly when finished cooking.

⚠ CAUTION Always use pot holders or oven mitts when using the oven. When cooking, the oven interior, oven exterior, oven racks, and cooktop will become very hot which can cause burns.

1. Position bakeware in oven and close oven door.
2. Press **Upper Oven** or **Lower Oven**.
3. Press **Slow Cook**. SLO and HI will appear in the display indicating the default temperature setting is for high (Figure 64).



Figure 64: SLO and HI appears in display

4. If a low setting is needed, press **Slow Cook** again. Lo will appear in the display (Figure 65).



Figure 65: Lo appears in the display

5. Press **START** to activate Slow Cook (Figure 66).



Figure 66: Slow Cook activated

6. To cancel Slow Cook at any time, press **STOP**.

Oven Controls

Setting the Sabbath feature (for use on the Jewish Sabbath and Holidays)



For further assistance, guidelines for proper usage, and a complete list of models with the Sabbath feature, please visit the web at www.star-k.org.

This appliance provides special settings for use when observing the Jewish Sabbath/Holidays. Sabbath mode disables all audible tones or visual display changes on the oven control. Bake heating is the only cooking feature available while in the Sabbath mode. Oven controls are locked during Sabbath mode.

You must first set the Bake feature and temperature(s) needed for the oven, as well as the Cook Time and Delay Start options (if needed). Any settings made prior to setting the Sabbath mode will be visible in the displays. The Cook Time option, if set prior to the Sabbath mode, will give one audible alert at the end of Cook Time.

The Sabbath mode will override the factory preset 12 Hour Energy Saving mode, and the appliance will stay on until the cooking features are cancelled. If any of the cooking features are cancelled when the appliance is in the Sabbath mode, no audible or visual indicators will be available to verify the cancellation.

If the oven interior lights are needed, be sure to activate them prior to setting the Sabbath mode. Once the oven light is turned on and the Sabbath mode is active, the oven light will remain on until the Sabbath mode is turned off and the oven lights are turned off. The oven door will not activate the interior oven lights when the oven door is opened or closed.

It is recommended that any oven temperature modification made within an active Sabbath mode be followed with two presses of the **START** key. This will ensure the oven remains on even if an attempt is made to set the oven temperature outside of its temperature range. If the oven temperature is set outside of the temperature range, the oven will default to the nearest available temperature. Try to set the desired oven temperature again.

To program oven to Bake with default oven temperature of 350°F and activate the Sabbath feature:

WARNING Food Poisoning Hazard. Do not let food sit for more than one hour before or after cooking. Doing so can result in food poisoning or sickness. Foods that can easily spoil such as milk, eggs, fish, meat, or poultry should be chilled in the refrigerator first. Even when chilled, they should not stand in the oven for more than 1 hour before cooking begins and should be removed promptly when finished cooking.

CAUTION Always use pot holders or oven mitts when using the oven. When cooking, the oven interior, oven exterior, oven racks, and cooktop will become very hot which can cause burns.

1. Be sure the clock is set with the correct time of day.
2. Arrange oven racks, place bakeware in oven, and close oven door.
3. Press **Upper Oven** or **Lower Oven**.
4. Press **Bake** (Figure 67).



Figure 67: Bake appearing in the display

5. Press **START**. The actual oven temperature will appear in the display (Figure 68).



Figure 68: Actual oven temperature appearing in the display

6. If Cook Time or Delay Start are not needed, skip this step and continue to Step 7. If a Cook Time or Delay Start are desired enter the times at this point. Refer to the "Setting Cook Time" on page 20 and "Setting Delay Start" on page 21 for detailed instructions. Remember the oven will shut down after using Cook Time or Delay Start and therefore may only be used once during the Sabbath/Jewish Holidays. The maximum Delay Start time is 11 hours and 59 minutes.
7. The oven will turn on and begin heating. If you desire to set both of the ovens on for Sabbath, you should set both at this time. If you just want one oven on, continue to Step 8.
8. Press and hold **Cook Time** and **Delay Start** simultaneously for about 3 seconds to set the Sabbath feature. Once the feature is set, **SAb** will appear in the display indicating the oven is properly set for the Sabbath feature (Figure 69).



Figure 69: SAb appearing in the display

To turn the oven off and keep the Sabbath feature active:

- Press **STOP**.

To turn off the Sabbath feature:

Press and hold both **Cook Time** and **Delay Start** simultaneously for at least 3 seconds to turn the Sabbath feature off. (This also turns off the oven.) The control will provide an acceptance tone, and **SAb** will disappear from the display. The oven is no longer programmed for the Sabbath feature.

Important note:

- Do not attempt to activate any other oven function except Bake while the Sabbath feature is active. The following keys will function correctly when the Sabbath feature is active: 0-9 number keys, Bake, Upper Oven, Lower Oven, **START**, and **STOP**. All other keys should not be used once the Sabbath feature is active.
- You may change the oven temperature once baking has started. Select the oven by pressing **Upper Oven** or **Lower Oven**. Press **Bake**, use the numeric keys to enter the oven temperature change (170°F to 550°F), and press **START** twice (for Jewish Holidays only).
- Remember that the oven control will no longer provide audible tones or display any further changes when the Sabbath feature is active.
- If a Delay Start time longer than 11 hours and 59 minutes is desired, set the oven control for the 24 hour day display mode setting. For detailed instructions see "Setting 12 hour or 24 hour display mode" on page 15.

What to do during a power failure or power interruption after the Sabbath feature was activated:

Should you experience a power failure or interruption, the oven will shut-off. When power is restored the oven will not turn back on automatically. The oven will remember that it is set for the Sabbath, and the oven display will show the message **SF** for Sabbath failure.

The food may be safely removed from the oven while still in the Sabbath feature, however the oven cannot be turned back on until after the Sabbath/Holidays. After the Sabbath observance turn off the Sabbath feature. Press and hold both **Cook Time** and **Delay Start** keys for at least 3 seconds simultaneously to turn the Sabbath feature off. **SF** will disappear from the display and the oven may be used with all normal functions.

Restoring Factory Default Settings

Your appliance was set with predetermined (default) oven control settings. The following options may have been modified since the appliance was new:

- 12 or 24 hr display mode
- Continuous bake or 12 Hour Energy Savings mode
- Silent or audible control
- Oven temperature display (Fahrenheit or Celsius)
- Oven temperature adjustments (UPO)

To restore oven control to factory default settings:

⚠ CAUTION If you choose to restore any of the options by using this method, all user settings will be restored to the factory default settings. This includes the oven temperature offset that will reset to (0) zero.

1. Press and hold **7** on numeric keys until acceptance tone sounds (about 6 seconds).

Important: Three quick beeps will sound. This is not the sound you are looking for. Continue to hold until acceptance tone sounds.

2. Press **START**. The control has been reset with the default settings.

Oven Controls

Adjusting Oven Temperatures (UPO)

Your appliance has been factory calibrated and tested to ensure accurate baking temperatures. For the first few uses, follow your recipe times and temperature recommendations carefully. If you think the oven is cooking too hot or too cool for your recipe times, you may adjust the control so the oven cooks hotter or cooler than the oven temperature displayed.

To adjust the oven temperature:

1. Press **Upper Oven** or **Lower Oven**.
2. Press and hold **Bake** for about 6 seconds. The factory offset temperature of **0 (zero)** should appear in the display along with **UPPER** or **LOWER**, indicating in which cavity the oven temperature will be adjusted (Figure 70).



Figure 70: UPO appearing in the display

3. To increase the temperature use the numeric keypad to enter the desired change. For example purposes, enter 30°F , which is **3 0** (Figure 71). The temperature may be increased as much as 35°F (19°C).



Figure 71: Increasing temperature by 35°F

4. To decrease the temperature, use the numeric keypad to enter the desired change. For example purposes, enter -30°F , which is **3 0** (Figure 72). Press **Self Clean**. The temperature may be decreased as much as -35°F (-19°C).



Figure 72: Decreasing temperature by 35°F

5. Press **START** to accept change. Press **STOP** to reject the change if necessary.

Important note:

- Each oven cavity can be set with its own unique UPO setting.
- Oven temperature adjustments will not change the Broil or Self Clean function temperatures.

- If the temperature shows an adjustment of -20°F , and a $+20^{\circ}\text{F}$ adjustment is needed, toggle between the minus (-) or plus (+) in the display by pressing **Self Clean**.
- Do not use oven thermometers such as those found in grocery stores to check the temperature settings inside your oven. These oven thermometers may vary as much as 20 to 40°F degrees from actual temperatures.

Self Clean

A self cleaning oven cleans with very high temperatures well above normal cooking temperatures. The high temperature eliminates soils completely or reduces them to a fine powdered ash you can wipe away afterwards with a damp cloth.

Important: You cannot program both ovens for Self Clean at the same time.

Before starting Self Clean:

⚠ CAUTION Do not leave small children unattended near the appliance. During the self cleaning cycle, the outside of the oven can become very hot to touch and can cause burns.

⚠ CAUTION Do not line the oven walls, racks, bottom, or any other part of the oven with aluminum foil. Doing so will destroy heat distribution, produce poor baking results, and cause permanent damage to the oven interior. Aluminum foil will melt to the interior of the oven.

⚠ CAUTION The health of some birds is extremely sensitive to the fumes given off during the self cleaning cycle of any oven. Move birds to another well-ventilated room.

⚠ CAUTION Do not force the door open while self clean is active. This can damage the automatic door locking system. Use caution when opening the oven door after self cleaning. The oven may still be very hot and can cause burns. To avoid possible burns stand to the side of the oven when opening the oven door to allow hot air or steam to escape.

Important note:

- If you are planning to use the oven directly after a Self Clean cycle, remember to allow the oven to cool down and the oven door to unlock. This normally takes about an hour. So, a three hour Self Clean cycle will actually take about four hours to complete.
- Allow the oven to cool before cleaning.
- Wear rubber gloves when cleaning any exterior parts of the oven manually.
- This model comes with lubricated porcelain oven racks, which can remain in the oven during the self-clean cycle. Do not clean this vegetable oil lubrication off the racks. It is important that the sides of the oven racks always have a light coating of vegetable oil. To maintain optimal rack performance, re-apply a thin layer of vegetable oil to the sides of the rack after every self-clean cycle or when the rack becomes difficult to slide.
- Remove all items from the oven and cooktop, including bakeware, utensils and any aluminum foil. Aluminum foil will not withstand high temperatures from a self clean cycle and will melt.
- Do not use oven cleaners or oven protective coatings in or around any part of the oven interior.

- Clean any soil from the oven frame, the door liner outside the oven door gasket and the small area at the front center of the oven bottom (Figure 73). These areas heat sufficiently to burn soil on. Clean using soap and water prior to starting Self Clean.
- Do not clean the oven door gasket (Figure 73). The woven material of the oven door gasket is essential for a good seal. Care should be taken not to rub, damage, or remove the gasket. Do not use any cleaning materials on the oven door gasket. Doing so could cause damage to the door gasket.
- Remove any excessive build up caused by spills. Any spill on the oven bottom should be wiped up and removed before starting a self clean cycle. To clean, use hot, soapy water and a cloth. Large spill residue can cause heavy smoke or fire when subjected to high temperatures. Do not allow food spills with a high sugar or acid content (such as milk, tomatoes, sauerkraut, fruit juices, or pie filling) to remain on the surface as they may leave a dull spot even after cleaning.

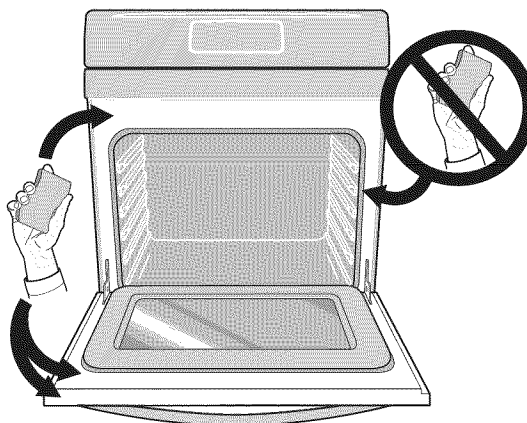

Figure 73: Oven door area to clean and not clean (gasket)

To start an immediate Self-Cleaning cycle or to set a Delay Start time of 4:30 and shut off automatically (example provided is a default 3 hour Self Clean Cycle):

1. Be sure the oven is empty, oven racks are removed, the clock is set with the correct time of day, and oven door is completely closed.
2. Press **Upper Oven** or **Lower Oven**.
3. Press **Self Clean**. **CLEAN** will flash and **3:00** will show in the display (Figure 74). The control will automatically clean for a 3 hour period (default self-cleaning cycle time). IF a 2 or 4 hour clean time is desired, press **2 0 0** for 2 hours or **4 0 0** for a 4-hour clean time. Set the cleaning time based on the amount of soil. A 3 hour cleaning time is recommended for normal cleaning, 2 hours for light cleaning, and 4 hours for heavy cleaning.

Oven Controls



Figure 74: 3:00 showing in the display

4. Press **START**. **DOOR** and **LOCKED** will flash. The **CLEAN** icon and letters **CLn** will remain in the display.
5. As soon as Self Clean becomes active, a motor driven lock mechanism will begin locking the oven door automatically. Once the door has been locked, **DOOR** and **LOCKED** will stop flashing and remain on. Also, the oven icon will appear in the display. Allow about 15 seconds for the oven door to lock.

Important: If the optional delay Self-Cleaning cycle is desired, continue and finish these steps. But if Self Clean is started immediately, skip these remaining steps and continue to the **When Self Clean is Finished**-portion of these instructions.

6. Press **Delay Start** (Figure 75).

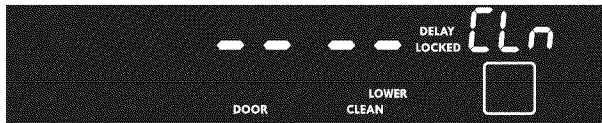

Figure 75: Display for using Delay Start with Self Clean

7. Enter the desired start time, using 4 3 0 (Figure 76).



Figure 76: Entering Delay Start start time

8. Press **START**. **CLEAN**, **DELAY**, **LOCKED**, and **DOOR** will be displayed (Figure 77).



Figure 77: CLEAN, DELAY, LOCKED, and DOOR in display

9. The control will start the self-cleaning at the set start time, for the period of time previously selected. At that time, the **DELAY** will go out.

When Self Clean is finished:

CAUTION Use caution when opening the oven door after self cleaning. The oven may still be very hot and can cause burns. To avoid possible burns, stand to the side of the oven when opening the oven door to allow hot air or steam to escape. The oven interior may appear to have cooled after it has been turned off. The oven may still be hot, and burns may occur if it is touched before it has cooled.

CAUTION Do not force the oven door open when self-clean is active. This can damage the automatic door-locking system. Use caution when opening the door after self-clean cycle is complete; the oven may still be very hot.

1. **Hot** will appear in display. The time of day, **DOOR**, **LOCKED**, and **CLEAN** icons will remain in the display.
2. Once the oven has cooled down (about 1 hour), and **DOOR** and **LOCKED** icons are no longer displayed, the oven door can then be opened.
3. When the oven interior has completely cooled, wipe away any residue or powdered ash with a damp cloth or paper towel.

Important note:

- The kitchen area should be well ventilated. Use an open window, ventilation fan, or exhaust hood during the first self clean cycle to help eliminate the normal odors associated the initial clean cycle.
- When the clean time finishes, the oven door will remain locked until the oven has cooled sufficiently. In addition to the clean time that was programmed, allow about 1 hour for the oven to cool before opening the oven door. The Self Clean function will not operate when the oven lockout is active.

If it becomes necessary to stop Self Clean when active:

1. Press STOP.
2. The oven door can only be opened after the oven has cooled down for approximately 1 hour and DOOR and LOCKED are no longer displayed.
3. Before restarting Self Clean, be sure to read important notes below.

Important note:

- When Self Clean is active, you may check the amount of clean time remaining by pressing the **Self Clean** key once.
- If your clock is set with the (default) 12 hr display mode, the Delay Start for a Self Clean can only be programmed to start up to 11 hours and 59 minutes after the time showing in the display (be sure to set the clock to current time before programming a delay start). To set a Delay Start Self Clean to begin 12 or more hours (maximum is 23 hours and 59 minutes) after the time of setting, be sure to first set the control in the 24 Hr display mode.
- If Self Clean was active and then interrupted by a power failure or cancelled before the oven was thoroughly cleaned, it may be necessary to run another Self Clean cycle.
- If the oven temperature was high enough when Self Clean was interrupted the oven control may not allow another Self Clean cycle to be set for up to 4 hours.

Care & Cleaning

Table 6: Cleaning recommendations

| Surface Type | Recommendation |
|--|---|
| Control knobs Painted body parts Painted decorative trim Aluminum, plastic, or vinyl trim | For general cleaning, use hot, soapy water and a cloth. For more difficult soils and built-up grease, apply a liquid detergent directly onto the soil. Leave on soil for 30-60 minutes. Rinse with a damp cloth and dry. Do not use abrasive cleaners on any of these materials; they can scratch. To remove control knobs, turn to OFF position. Grasp firmly and pull straight off the shaft. To replace knobs after cleaning, line up the flat sides of both knob and shaft, then push knob into place. |
| Control panel Control keypad membrane Decorative trim (some models) | Before cleaning the control panel, turn all controls off, activate oven lockout (on some models), and if needed remove any knobs from panel. Do not use abrasive cleaners on any of these materials; they can scratch. Clean using hot, soapy water and a cloth or sponge. Be sure to squeeze excess water from cloth or sponge before wiping control panel, especially when wiping around the controls area. Excess water in or around the controls may cause damage to the appliance. When rinsing, use clean water and a cloth or sponge and be sure to squeeze excess water from cloth or sponge before wiping the control panel. |
| Porcelain enamel parts and door liner | Gentle scrubbing with a soapy non-abrasive scouring pad will remove most spots. Rinse with a 1:1 solution of clear water and ammonia. If necessary, cover difficult spots with an ammonia-soaked paper towel for 30 to 40 minutes. Rinse with clean water and a damp cloth, and then scrub with a soap-filled non-abrasive scouring pad. Rinse and wipe dry with a clean cloth. Do not allow food spills with high sugar or acid content (milk, tomatoes, sauerkraut, fruit juices, or pie filling) to remain on the surface; they may cause a dull spot even after cleaning. |
| Oven interior | For oven interior remove excessive spillovers from oven cavity bottom before starting Self Clean. Clean any soils from oven frame and door liner outside the oven door gasket. For very important cleaning precautions be sure to read all the instructions in the "Self Clean" section of the Oven Controls chapter on page 33. |
| Porcelain coated oven racks | Some ovens come with lubricated porcelain oven racks, which can remain in the oven during the self-clean cycle. Do not clean this oil lubrication off the racks. It is important that the sides of the oven racks always have a light coating of oil. To maintain optimal rack sliding performance, periodically apply a thin layer of food safe oil (mineral or vegetable oil) to the sides of the rack. |
| Oven door | Use soap and water to thoroughly clean the top, sides, and front of the oven door. Rinse well. You may use a glass cleaner on the outside glass of the oven door. Do not immerse the door in water. Do not spray or allow water or the glass cleaner to enter the door vents. Do not clean oven door gasket. The oven door gasket is made of a woven material, on Self-Cleaning models, which is essential for a good seal. Take care not to rub, damage or remove this gasket. |
| Cooktop surface Surface burners Burner grates | Do not use spray oven cleaners on the cooktop. See "Cleaning the Cooktop and Surface Burners" instructions on page 37. |
| Stainless Steel (some models) | Only use cleaners and polishes that are specifically manufactured for cleaning stainless steel. Always rub in direction of metal grain to avoid damaging. Do not use cleaners with high concentrations of chlorides or chlorine. Do not use harsh scrubbing cleaners. Polish with a lint-free cloth. Always be sure to wipe excess cleaner/polish off from the metal surface as bluish stains may occur during future oven heating that cannot be removed. Clean heavier soils with hot, soapy water and a cloth or sponge. Rinse and dry using clean water and a cloth. |

General Care & Cleaning

The cooktop is designed to make cleaning easier. Because the gas burners are sealed, cleanups are easy when spillovers are cleaned up immediately. Correct and consistent cleaning is essential to maintaining your porcelain enamel cooktop. If food spills and grease spatters are not removed, they may burn onto the surface of the cooktop and cause permanent discoloration.

⚠ WARNING Do not use a cooktop cleaner on a hot cooktop. The fumes can be hazardous to your health and can chemically damage the cooking surface.

⚠ CAUTION Before manually cleaning any part of the range, be sure all controls are turned off and the range is cool. The range may be hot and can cause burns.

⚠ CAUTION Ammonia must be rinsed before operating the oven. Provide adequate ventilation.

⚠ CAUTION Do not use commercial oven cleaners on the cooktop.

Aluminum foil and utensils

⚠ WARNING Never cover any slots, holes, or passages in the oven bottom or cover an entire oven rack with materials such as aluminum foil. Doing so blocks air flow through the oven and may cause carbon monoxide poisoning. Aluminum foil linings may trap heat, causing a fire hazard.

⚠ WARNING Protective Liners — Do not use aluminum foil to line the oven bottom. Only use aluminum foil as recommended in this manual. Improper installation of these liners may result in risk of electric shock, or fire.

- Aluminum foil - Use of aluminum foil on a hot cooktop can damage the cooktop. Do not use thin aluminum cooking utensils or allow aluminum foil to touch the surface burners under any circumstances.
- Aluminum utensils - The melting point of aluminum is much lower than that of other metals. Care must be taken when aluminum pots or pans are used on the cooktop. If aluminum pans are allowed to boil dry when using the cooktop, the utensil will be damaged or destroyed.

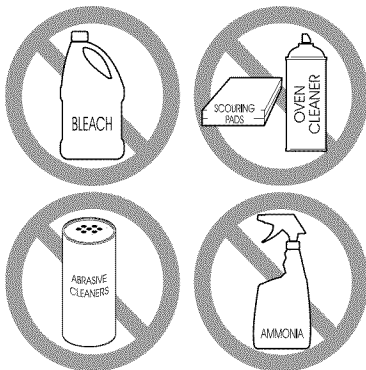

Figure 78: Do not use commercial cleaners

Cleaning the Cooktop and Surface Burners

⚠ CAUTION To avoid possible burns, do not attempt any of the cooktop cleaning instructions provided before turning OFF all of the surface burners and allow them to completely cool.

⚠ CAUTION Any additions, changes or conversions required in order for this appliance to satisfactorily meet the application needs must be made by an authorized qualified agency.

⚠ CAUTION To avoid possible burns, do not attempt to operate the surface burners without the burner caps.

Routinely clean the cooktop. Wipe with a clean, damp cloth and wipe dry to avoid scratches.

Keeping the surface burner head ports and slots clean will prevent improper ignition and an uneven flame.

Important note:

Your appliance is shipped with the burner heads and burner caps in the correct locations. Before using your gas appliances be sure to following installation instructions before operating and remove all packing tape from the cooktop area.

Cleaning recessed and contoured areas of cooktop

If a spill occurs on or in the recessed or contoured areas, blot up spill with an absorbent cloth. Rinse with a clean, damp cloth and wipe dry.

Cleaning surface burner grates

- Clean only after the grates are completely cool.
- Use nonabrasive plastic scrubbing pad and mild abrasive cleanser or clean in the dishwasher.
- Food soils containing acids may affect the finish. Clean immediately after the grates are cool.
- Thoroughly dry grates immediately following cleaning.

Cleaning burner caps

- Remove caps from burner heads after they have cooled.
- Clean heavy soils with a plastic scrubbing pad and absorbent cloth.
- Thoroughly dry burner caps immediately following cleaning including the bottom and inside of cap.
- Do not use abrasive cleaners. They can scratch porcelain.
- Do not clean burner caps in the dishwasher.
- Do not operate surface burners without burner caps properly in place. Read important notes.

Care & Cleaning

Cleaning surface burner heads

For proper gas flow it may be necessary to clean the burner head and slots. To clean, first use a clean DAMP cloth to soak up any spills. Remove any food from between the burner slots using a small nonabrasive brush like a toothbrush and afterwards wipe up using a damp cloth. For stubborn soils located in the slots, use a small-gauge wire or needle to clean.

Any spill on or around the electrode must be carefully cleaned. Take care not to hit the electrode with any thing hard or it could be damaged.

Important note:

Small food particulars on or around the electrode could stop the burner from lighting.

To clean the burner head ignition ports

Each burner head has a small ignition port located as shown. Should you experience ignition problems it may be that this port hole is partially blocked with soil. With the burner head in place, use a small wire gauge needle or the end of a paper clip to clear the ignition port (Refer to Figure 79; round style shown; oval burner on some models not shown).

Important notes:

- The surface burner heads are secured to the cooktop and must be cleaned in place on the cooktop.
- Always keep the surface burner caps in place whenever a surface burner is in use.
- When replacing the burner caps, be sure the burner caps are seated firmly on top of the burner heads. Improper flame size and uneven heating may result when any surface burners are turned on and the burner caps are not seated correctly.
- For proper flow of gas and ignition of burners do not allow spills, food, cleaning agents or any other material to enter the gas orifice port opening.

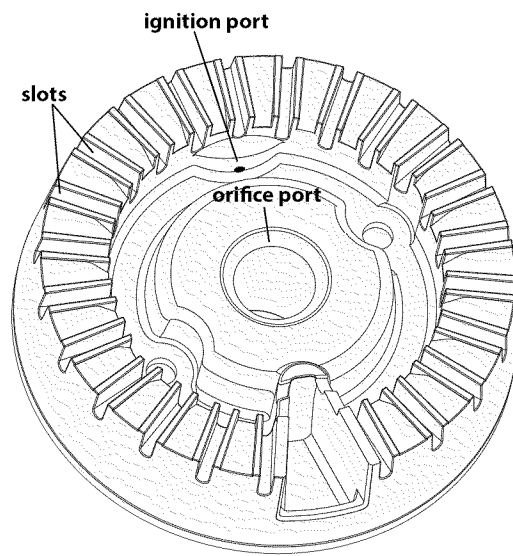

Figure 79: Cooktop burner head

Replacing the Round Halogen Oven Light

The round halogen oven light is located in the upper oven, at the rear of the oven cavity and is covered with a glass shield held by a wire holder (Figure 80). The glass shield protects the light bulb and must be in place whenever the oven is in use (Figure 81).

To replace the upper oven round halogen light:

⚠ CAUTION Be sure the range is unplugged and all parts are cool before replacing oven light. Wear a leather-faced glove for protection against possible broken glass.

1. Turn electrical power off at the main source.
2. Remove light shield by turning a quarter turn counter-clockwise (Figure 81).
3. Replace bulb with a new T-4 type Halogen 25 watt appliance bulb.

Important: Do not allow your fingers to touch the new bulb when replacing. This will shorten the life of the bulb. Use a paper towel or cotton glove while handling the new bulb when installing.

4. Replace glass shield by rotating clockwise. The glass shield must be in place whenever the oven is in use.
5. Turn power back on again at the main source (or plug the appliance back in).
6. The clock will then need to be reset. To reset, see "" on page 16.

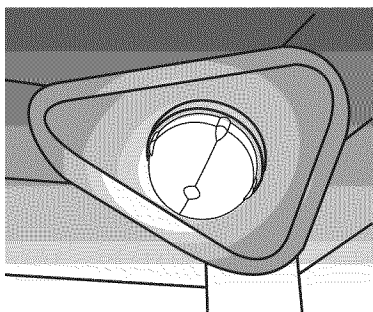

Figure 80: Upper oven round halogen light

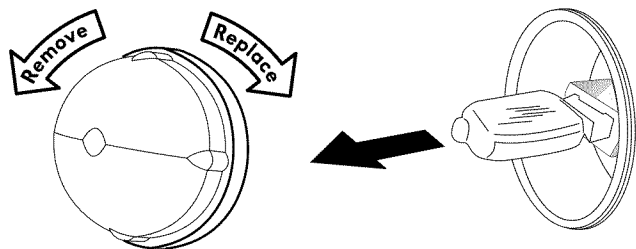

Figure 81: Replacing the upper oven round halogen light

Replacing the Rectangle Halogen Oven Light

The rectangle halogen oven light is located in the lower oven and will turn on automatically when the oven door is opened. The oven light may be turned on when the door is closed by pressing LIGHT on the control panel.

Important: The lamp is covered with a glass shield. The glass shield can be removed to be cleaned manually or to change the oven light.

To replace the lower oven rectangle halogen light:

⚠ CAUTION Be sure the range is unplugged and all parts are cool before replacing oven light. Wear a leather-faced glove for protection against possible broken glass.

1. Turn power off at the main source or unplug the appliance.
2. To remove the glass shield, pull the back side of the shield toward the inside of the oven in a manner to lift it up from the oven side. The glass shield should come out easily by pushing a little toward front of the oven (Figure 82).
3. Replace bulb with a new T-4 type Halogen 25 watt appliance bulb.

Important: Do not allow your fingers to touch the new bulb when replacing. This will shorten the life of the bulb. Use a paper towel or cotton glove while handling the new bulb when installing.

4. Replace glass shield over the bulb. The glass shield must be in place whenever the oven is in use.
5. Turn power back on again at the main source (or plug the appliance back in).
6. The clock will then need to be reset. To reset, see "" on page 16.

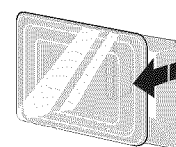

Lift backside of glass shield and remove it.

Figure 82: Lower oven halogen light glass shield

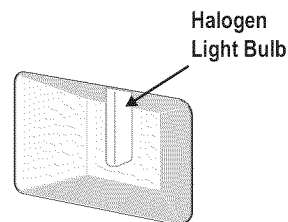

Figure 83: Lower oven halogen light bulb

Care & Cleaning

Removing and replacing the lift-off oven door

⚠ CAUTION To avoid possible injury when removing or replacing the oven door, follow the instructions below carefully and always hold the oven door with both hands positioned away from the door hinge area.

⚠ CAUTION The door is heavy. For safe, temporary storage, lay the door flat with the inside of the door facing down.

To remove the oven door:

1. Open oven door completely (horizontal with floor - Figure 84).
2. Pull the door hinge locks on both left and right door hinges down from the oven frame completely towards the oven door (Figure 85). A tool such as a small flat-blade screwdriver may be required.
3. Firmly grasp both sides of oven door along the door sides (Do not use the oven door handle - Figure 86).
4. Close the door to the broil stop position (the oven door will stop into this position just before fully closing).
5. With the oven door in the broil stop position, lift the oven door hinge arms over the roller pins located on each side of the oven frame (Figure 87).

To replace oven door:

1. Firmly grasp both sides of oven door along the door sides (Do not use the oven door handle - Figure 86).
2. Holding the oven door at the same angle as the removal position, seat the hook of the hinge arm over the roller pins located on each side of the oven door frame (Figure 87). The hook of the hinge arms must be fully seated onto the roller pins.
3. Fully open the oven door (horizontal with floor - Figure 84).
4. Push the door hinge locks up towards and into the oven frame on both left and right oven door hinges (Figure 85) to the locked position; then, close the oven door.

Special care instructions

Most oven doors contain glass that can break. Follow these recommendations:

- Do not close the oven door until all the oven racks are fully in place inside the oven cavity.
- Do not hit the glass with pots, pans, or any other object.
- Scratching, hitting, jarring, or stressing the glass may weaken its structure causing an increased risk of breakage at a later time.

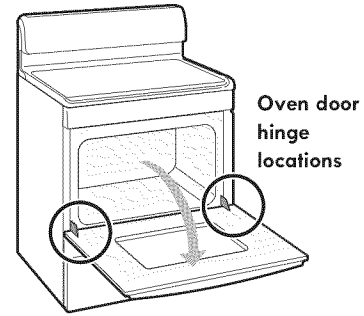

Figure 84: Oven hinge locations

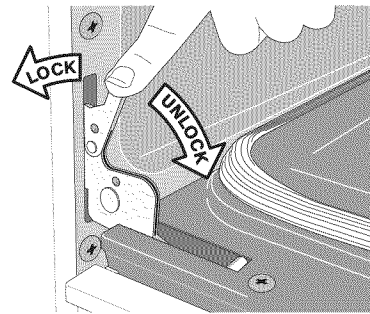

Figure 85: Hinge lock/unlock positions

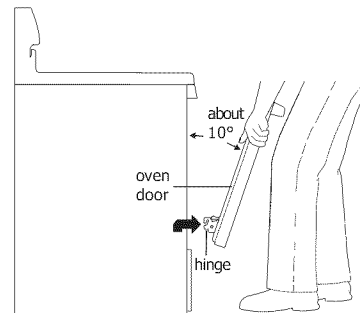

Figure 86: How to remove door

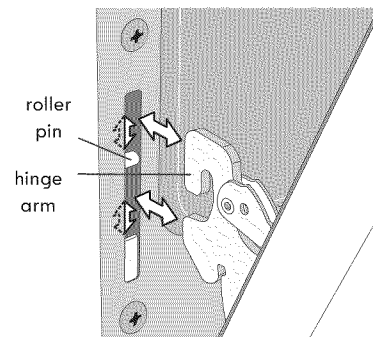

Figure 87: Hinge pin locations

Before You Call

Oven Baking

For best cooking results, heat the oven before baking cookies, breads, cakes, pies, pastries, et cetera. There is no need to preheat the oven for roasting meat or baking casseroles.

The cooking times and temperatures needed to bake a product may vary slightly from your previously owned appliance.

Baking Problems and Solutions

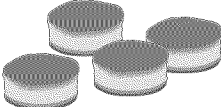
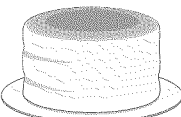
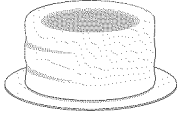
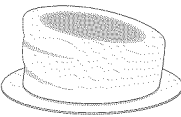
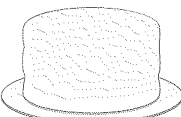
| Baking Problems | Causes | Corrections |
|--|---|---|
| <p>Cookies and biscuits burn on the bottom.</p>  | <ul style="list-style-type: none">• Cookies and biscuits put into oven before the preheating time is completed.• Oven rack is overcrowded.• Dark pans absorb heat too fast. | <ul style="list-style-type: none">• Allow oven to preheat to desired temperature before placing food in oven.• Choose pan sizes that will permit 2" to 4" of air space (5.1 cm or 10.2 cm) on all sides when placed in the oven.• Use a medium weight baking sheet. |
| <p>Cakes too dark on top or bottom</p>  | <ul style="list-style-type: none">• Cakes put in oven before preheating time is completed.• Rack position too high or too low.• Oven too hot. | <ul style="list-style-type: none">• Allow oven to preheat to the selected temperature before placing food in the oven.• Use proper rack position for baking needs.• Set oven temperature 25°F (13°C) lower than recommended. |
| <p>Cakes not done in center</p>  | <ul style="list-style-type: none">• Oven too hot.• Incorrect pan size.• Pan not centered in oven. | <ul style="list-style-type: none">• Set oven temperature 25°F (13°C) lower than recommended.• Use pan size suggested in recipe.• Use proper rack position and place pan so there is 5.1 cm to 10.2 cm (2" to 4") of space on all sides of pan. |
| <p>Cakes not level.</p>  | <ul style="list-style-type: none">• Oven not level.• Pan too close to oven wall or rack overcrowded.• Pan warped.• Oven light left on during baking | <ul style="list-style-type: none">• Place a marked glass measuring cup filled with water on the center of the oven rack. If the water level is uneven, refer to the installation instructions for leveling the oven.• Be sure to allow 5.1 cm to 10.2 cm (2" to 4") of clearance on all sides of each pan in the oven.• Do not use pans that are dented or warped.• Do not leave oven light on while baking. |
| <p>Foods not done when cooking time is over.</p>  | <ul style="list-style-type: none">• Oven too cool.• Oven overcrowded.• Oven door opened too frequently. | <ul style="list-style-type: none">• Set oven temperature 25°F (13°C) higher than suggested and bake for the recommended time.• Be sure to remove all pans from the oven except the ones to be used for baking.• Open oven door only after shortest recommended baking time. |

Solutions to Common Problems

Before you call for service, review the following list. It may save you time and expense. Possible solutions are provided with the problem listed:

| Problem | Solution |
|---|---|
| Poor baking results | <ul style="list-style-type: none">• Many factors affect baking results. Make sure the proper oven rack position is used. Center food in the oven and space pans to allow air to circulate. Allow the oven to preheat to the set temperature before placing food in the oven. Try adjusting the recipe's recommended temperature or baking time. If you feel the oven is too hot or cool, see "Adjusting Oven Temperatures (UPO)" on page 32. In addition, be sure to make adjustments for cookware types. |
| Appliance is not level. | <ul style="list-style-type: none">• Be sure floor is level, strong, and stable enough to adequately support range.• If floor is sagging or sloping, contact a carpenter to correct the situation.• Poor installation. Place oven rack in center of oven. Place a level on the oven rack. Adjust leveling legs at base of appliance until the rack is level.• Kitchen cabinet alignment may make range appear not level. Be sure cabinets are square and have sufficient room for appliance clearance. |
| Cannot move appliance easily. Appliance must be accessible for service. | <ul style="list-style-type: none">• Cabinets not square or are built in too tightly. Contact builder or installer to make appliance accessible.• Carpet interferes with appliance. Provide sufficient space so appliance can be lifted over carpet.• Gas line is hard-plumbed. Have a flexible CSA International approved metal appliance connector installed. |
| Entire appliance does not operate. | <ul style="list-style-type: none">• Make sure power cord is plugged properly into outlet.• Electrical power outage. Check house lights to be sure. Call your local electric company for service outage information. In addition, service wiring is not complete. Call 1-800-4-MY-HOME® for assistance (See back cover).• House fuse has blown or circuit breaker has tripped immediately following installation. House fuse may not be full engaged. Check fuse and screw or engage circuit breaker securely.• House fuse has blown or circuit breaker has tripped after the oven has been installed and previously operating. Call your local electric company for service outage information. Call 1-800-4-MY-HOME® for assistance (See back cover). |
| Oven portion of appliance does not operate. | <ul style="list-style-type: none">• Be sure regulator gas valve is turned to ON. See installation instructions.• The time of day is not set. The time of day must first be set in order to operate the oven. See "" on page 16.• Be sure the oven controls are set properly for the desired function. See the "Oven Controls" chapter starting on page 14 and review instructions for the desired cooking function in this manual or see "Entire appliance does not operate" in this checklist. |
| Oven light does not work. | <ul style="list-style-type: none">• Be sure the oven light is secure in the socket. Also see "Replacing the Round Halogen Oven Light" on page 39. |
| Fan noise during cooking operation | <ul style="list-style-type: none">• A cooling fan may automatically turn on and off to cool internal parts. This is normal, and the fan may continue to run even after oven is turned off. |

| | |
|---|--|
| Oven smokes excessively when broiling. | <ul style="list-style-type: none"> • Incorrect setting. Follow the “Setting Broil” instructions in Oven Controls chapter on page 23. • Meat too close to the broiler. Reposition the broil rack to provide proper clearance between the meat and the broiler. Preheat the broiler for searing. • Meat not properly prepared. Remove excess fat from meat. Cut remaining fatty edges to prevent curling, but do not cut into lean. • Grease has built up on oven surfaces. Regular cleaning is necessary when broiling frequently. Old grease or food spatters cause excessive smoking. • Grid on broiler pan wrong side up. Grease does not drain into broiler pan. Always place the grid on the broiler pan with the ribs up and the slots down to allow grease to drip into the pan. • Broiler pan used without grid or grid cover with foil. Do not use the broiler pan without the grid or cover the grid with foil. |
| Flames inside oven or smoking from oven vent. | <ul style="list-style-type: none"> • Excessive spillovers in oven. For example, this will happen for pie spillovers or large amounts of grease left on the oven bottom. Wipe up excessive spillovers before starting oven. If flames or excessive smoke are present, follow the “Setting Broil” instructions in Oven Controls chapter on page 23. |
| Oven control panel beeps and displays any F code error. | <ul style="list-style-type: none"> • Oven control has detected a fault or error condition. Press STOP to clear the error code. Try Bake or Broil function. If the F code error repeats, remove power from appliance, wait 5 minutes, and then repower appliance and set clock with the correct time of day. Try Bake or Broil function again. If the fault recurs, press STOP to clear and call 1-800-4-MY-HOME® for assistance (See back cover). |
| “d-O” is displayed | <ul style="list-style-type: none"> • The door was left open and control set for self-cleaning cycle. Close the door and press STOP. |
| Self Clean does not work. | <ul style="list-style-type: none"> • Oven control not set properly. Review the “Self Clean” instructions in Oven Controls chapter on page 33. |
| Soil not completely removed after Self Clean. | <ul style="list-style-type: none"> • Self Clean was interrupted. Review the “Self Clean” instructions in Oven Controls chapter on page 33. • Excessive spillovers on oven bottom. Remove before starting Self Clean. • Failure to clean soil from the oven frame, the door liner outside the oven door gasket and the small area at the front center of the oven bottom. These areas are not in the self-cleaning area, but get hot enough to burn on residue. Clean these areas before the self-cleaning cycle is started. Burned-on residue can be cleaned with a stiff nylon brush and water or a nylon scrubber. Do not hand clean the oven door gasket or it will be permanently damaged. |
| Oven racks do not slide easily | <ul style="list-style-type: none"> • This model comes with lubricated porcelain oven racks, which can remain in the oven during the self-clean cycle. Do not clean this vegetable oil lubrication off the racks. It is important that the sides of the oven racks always have a light coating of vegetable oil. To maintain optimal rack performance, re-apply a thin layer of vegetable oil to the sides of the rack after every self-clean cycle or when the rack becomes difficult to slide. |
| Surface burner flame is too high. | <ul style="list-style-type: none"> • Surface control knob is set too high. Adjust to lower flame setting. Burner caps are not seated properly. Check that all surface burner caps are level and seated correctly on surface burner heads. See “Cleaning the Cooktop and Surface Burners” in the Care & Cleaning section on page 37 for additional cleaning instructions. • Incorrect L.P. conversion. Refer to L.P. conversion kit instructions to correct. |

Before You Call

Surface burners do not ignite.

- Surface control knob was not completely turned to LITE. Push in and turn the surface control knob to LITE until burner ignites and then turn control knob to desired flame size.
- Burner ports are clogged. With the burner OFF, use a small-gauge wire or needle to burner head slots and ignition ports. See "Cleaning the Cooktop and Surface Burners" in the Care & Cleaning section on page 37 for additional cleaning instructions.
- Range power cord is disconnected from outlet (electric ignition models only). Be sure power cord is securely plugged into the power outlet.
- Electrical power outage. Burners may be lit manually. See "Setting Surface Burners" on page 12.
- Be sure the gas supply to the range is turned on.

Surface burner flame uneven or only part way around burner cap.

- Burner slots or ports are clogged. With the surface burner OFF, clean ports with a small-gauge wire or needle. Also, moisture is present after cleaning. Lightly fan the flame and allow burner to operate until flame is full.
- Burner caps are not seated properly. Check that all burner caps are level and seated correctly on burner heads. See "Cleaning the Cooktop and Surface Burners" in the Care & Cleaning section on page 37 for additional cleaning instructions.

Surface burner flame is orange.

- Dust particles in main gas line. Allow the burner to operate a few minutes until flame turns blue. In coastal areas, a slightly orange flame is unavoidable due to salt content in air.
 - Incorrect L.P. conversion. Refer to L.P. conversion kit instructions to correct.
-

Master Protection Agreements

Congratulations on making a smart purchase. Your new Kenmore® product is designed and manufactured for years of dependable operation. But like all products, it may require preventive maintenance or repair from time to time. That's when having a Master Protection Agreement can save you money and aggravation.

The Master Protection Agreement also helps extend the life of your new product. Here's what the Agreement* includes:

- ☑ **Parts and labor** needed to help keep products operating properly **under normal use**, not just defects. Our coverage goes **well beyond the product warranty**. No deductibles, no functional failure excluded from coverage – **real protection**.
- ☑ **Expert service** by a force of more than **10,000 authorized Sears service technicians**, which means someone you can trust will be working on your product.
- ☑ **Unlimited service calls and nationwide service**, as often as you want us, whenever you want us.
- ☑ **"No-lemon" guarantee** – replacement of your covered product if four or more product failures occur within twelve months.
- ☑ **Product replacement** if your covered product can't be fixed.
- ☑ **Annual Preventive Maintenance Check** at your request – no extra charge.
- ☑ **Fast help by phone** – we call it **Rapid Resolution** – phone support from a Sears representative on all products. Think of us as a "talking owner's manual".
- ☑ **Power surge protection** against electrical damage due to power fluctuations.
- ☑ **\$250 Food Loss Protection** annually for any food spoilage that is the result of mechanical failure of any covered refrigerator or freezer.
- ☑ **Rental reimbursement** if repair of your covered product takes longer than promised.
- ☑ **25% discount** off the regular price of any non-covered repair service and related installed parts.

Once you purchase the Agreement, a simple phone call is all that it takes for you to schedule service. You can call anytime day or night, or schedule a service appointment online.

The Master Protection Agreement is a risk free purchase. If you cancel for any reason during the product warranty period, we will provide a full refund. Or, a prorated refund anytime after the product warranty period expires. Purchase your Master Protection Agreement today!

Some limitations and exclusions apply. For prices and additional information in the U.S.A. call 1-800-827-6655.

*** Coverage in Canada varies on some items. For full details call Sears Canada at 1-800-361-6665.**

Sears Installation Service

For Sears professional installation of home appliances, garage door openers, water heaters, and other major home items, in the U.S.A. or Canada call **1-800-4-MY-HOME®**.

Acuerdos maestros de protección

Enhorabuena por haber hecho una compra inteligente. Su nuevo producto Kenmore® está diseñado y fabricado para brindarle años de funcionamiento fiable. Pero, como cualquier producto, puede necesitar mantenimiento preventivo o reparaciones periódicas. Es por eso que tener un Acuerdo maestro de protección podría ahorrarle dinero y molestias.

El Acuerdo maestro de protección también sirve para prolongar la durabilidad de su nuevo producto. El acuerdo* incluye lo siguiente:

- ☑ **Piezas y mano de obra** necesarias para contribuir a mantener el funcionamiento adecuado de los productos **utilizados en condiciones normales de uso**, no sólo en caso de defectos de los productos. Nuestra cobertura va **mucho más allá que la garantía del producto**. No se aplican deducibles ni exclusiones por fallas del funcionamiento: es decir, **verdadera protección**.
- ☑ **Servicio técnico por expertos** (más de **10000 técnicos autorizados de Sears**), lo cual significa que quien repare o realice el mantenimiento de su producto será un profesional de confianza.
- ☑ **Servicio técnico a escala nacional y número ilimitado de llamadas de solicitud de servicio técnico**: se puede poner en contacto con nosotros cuantas veces lo desee y cuando lo desee.
- ☑ **Garantía "sin sorpresas"**: se reemplaza el producto cubierto por el acuerdo si ocurren cuatro o más fallas del producto en un periodo de 12 meses.
- ☑ **Reemplazo del producto**: en caso de que no se pueda reparar el producto cubierto por el acuerdo.
- ☑ **Revisión anual preventiva de mantenimiento del producto**: puede solicitarla en cualquier momento, sin costo alguno.
- ☑ **Rápida asistencia telefónica**, la cual denominamos **Solución rápida**: es decir, asistencia telefónica a través de cualquiera de nuestros representantes de Sears, sobre cualquiera de nuestros productos. Piense en nosotros como en un "manual parlante del usuario".
- ☑ **Protección contra fallas eléctricas**, contra daños debidos a fluctuaciones de la corriente eléctrica.
- ☑ **\$250 al año para cubrir cualquier posible deterioro de alimentos** que haya tenido que desechar debido a una falla mecánica de cualquiera de nuestros refrigeradores o congeladores cubiertos por este acuerdo.
- ☑ **Devolución de gastos de alquiler de electrodomésticos** si la reparación de su producto asegurado toma más que el tiempo prometido.
- ☑ **25% de descuento** aplicable tanto a los costos del servicio de reparación, como de las piezas instaladas relacionadas que no hayan quedado cubiertos por este acuerdo.

Una vez que haya realizado el pago de este acuerdo, bastará una simple llamada telefónica para concertar una visita de servicio. Puede llamar a cualquier hora del día o de la noche, o bien concertar una visita de servicio por Internet.

La adquisición del Acuerdo maestro de protección es una inversión exenta de riesgos. Si por cualquier motivo decide cancelar dicho acuerdo durante el periodo de garantía del producto, le haremos un reintegro total del valor. O bien un importe proporcional si cancela el acuerdo en cualquier otro momento posterior al vencimiento del periodo de garantía del producto. ¡Adquiera hoy mismo su Acuerdo maestro de protección!

Algunas limitaciones y exclusiones podrían aplicarse. Para solicitar precios e información adicional, llame al 1-800-827-6655 (en los EE.UU.).

*** La cobertura en Canadá varía en el caso de algunos artículos. Para obtener detalles completos al respecto, llame al 1-800-361-6665 de Sears de Canadá.**

Servicio de instalación de Sears

Para solicitar la instalación por profesionales de Sears de electrodomésticos, abridores de puertas de garaje, calentadores de agua y otros artículos de uso prioritario en el hogar, **llame al 1-800-4-MY-HOME** en los EE.UU. o Canadá.

Kenmore®

For Sears Home Services in-home repair
of all Kenmore major appliances.

For the replacement parts, accessories and
Use & Care Guides that you need to do-it-yourself.

For professional installation of major home appliances
and items like air conditioners and water heaters.

1-844-553-6667

www.kenmore.com

In Canada 1-800-469-4663

www.sears.ca

Call anytime for the location of your nearest
Sears Parts & Repair Service Center

1-800-488-1222 (U.S.A.)

1-800-469-4663 (Canada)

To purchase a protection agreement on a serviceable product :

1-800-827-6655 (U.S.A.)

1-800-361-6665 (Canada)

Para pedir servicio de reparación
a domicilio, y ordenar piezas:

1-888-SU-HOGAR®

(1-888-784-6427)

www.kenmore.com

Au Canada pour service en français:

1-800-LE-FOYER^{MC}

(1-800-533-6937)

www.sears.ca



Free Manuals Download Website

<http://myh66.com>

<http://usermanuals.us>

<http://www.somanuals.com>

<http://www.4manuals.cc>

<http://www.manual-lib.com>

<http://www.404manual.com>

<http://www.luxmanual.com>

<http://aubethermostatmanual.com>

Golf course search by state

<http://golfingnear.com>

Email search by domain

<http://emailbydomain.com>

Auto manuals search

<http://auto.somanuals.com>

TV manuals search

<http://tv.somanuals.com>