

KENWOOD

MONITOR WITH DVD RECEIVER

DDX8905S

DDX6905S

DDX6705S

MONITOR WITH RECEIVER

DMX7705S

INSTRUCTION MANUAL

JVCKENWOOD Corporation

- Updated information (the latest Instruction Manual, system updates, new functions, etc.) is available from <http://www.kenwood.com/cs/ce/>.

Take the time to read through this instruction manual.

Familiarity with installation and operation procedures will help you obtain the best performance from your new receiver.

For your records

Record the serial number, found on the back of the unit, in the spaces designated on the warranty card, and in the space provided below. Refer to the model and serial numbers whenever you call upon your KENWOOD dealer for information or service on the product.

Model DDX8905S/ DDX6905S/ DDX6705S/ DMX7705S Serial number _____

US Residence Only

Register Online

Register your KENWOOD product at www.kenwood.com/usa/

Contents

Before Use 4

Precautions.....	4
How to read this manual	5

Basic Operations 6

Functions of the Buttons on the Front Panel ...	6
Turning on the Unit	8
Initial Settings.....	8
Adjusting the volume	10
Monitor Angle Control	10
Touch screen operations	10
HOME screen descriptions.....	11
Source selection screen descriptions.....	12
Source control screen descriptions	14
Popup menu	14
List screen	15

Disc 16

Playing a disc	16
DVD/VCD Basic Operation.....	17
Music CD/ Disc media Basic Operation	18
File search Operation	19
DVD Disc Menu Operation.....	20
DVD Setup.....	21

APPS—Android Auto™/ Apple CarPlay 22

Apple CarPlay Operation	22
Android Auto™ Operation	23
WebLink™/Waze Operation	25
Pandora® Operation	26
Spotify Operation.....	28

USB 30

Connecting a USB device	30
USB Basic Operation.....	30
Search Operation.....	32

iPod/iPhone 33

Preparation	33
iPod/iPhone Basic Operation	34
Search Operation.....	35

Radio 36

Radio Basic Operation	36
Memory Operation	37
Selecting Operation	38
Traffic Information	38

HD Radio™ Tuner 39

HD Radio Tuner Basic Operation.....	39
Receive Mode	41
Memory Operation	41
Selecting Operation	42
Bookmark.....	43
Alert Message.....	45

SiriusXM® 46

SiriusXM® Basic Operation	46
Storing Channels in Preset Memory	48
Preset select	48
Direct search	48
Category/Channel search	49
Replay	49
TuneMix™	50
SmartFavorites, TuneStart™	50
TuneScan™	50
Traffic & Weather Now™	51
Content Alerts	51
SportsFlash™	52
SiriusXM Setup	52

Bluetooth Control 58

Information for using Bluetooth® devices	58
Register the Bluetooth device	59
Bluetooth Setup	60
Playing Bluetooth Audio Device	62
Using Hands-Free Unit	64
Hands-Free Setup	68

Other External Components 69

View Camera	69
Use Dashboard Camera	71
External audio/video players—AV-IN	71
OEM Features Operation	72

Setting Up 73

Monitor Screen Setup	73
System Setup	73
User Interface Setup	74
Special Setup	75
Display Setup	75
AV Setup	77

Controlling Audio 78

Speaker/ X'over setup	78
Controlling General Audio	79
Equalizer Control	80
Volume Offset	81
Zone Control	81
Sound Effect	82
Listening Position/ DTA	83

Remote control 85

Battery Installation	85
Functions of the Remote control Buttons	85

Connection/Installation 88

Before Installation	88
Installing the unit	90

Troubleshooting 96

Problems and Solutions	96
Error Messages	96

Appendix 98

Playable Media and Files	98
Region Codes in the World	100
DVD Language Codes	101
Specifications	102
About this Unit	104

Before Use

Precautions

▲ WARNINGS

■ To prevent injury or fire, take the following precautions:

- To prevent a short circuit, never put or leave any metallic objects (such as coins or metal tools) inside the unit.
- Do not watch or fix your eyes on the unit's display when you are driving for any extended period.
- If you experience problems during installation, consult your KENWOOD dealer.

■ Precautions on using this unit

- When you purchase optional accessories, check with your KENWOOD dealer to make sure that they work with your model and in your area.
- You can select language to display menus, audio file tags, etc. See **User Interface Setup (P.74)**.
- The Radio Data System or Radio Broadcast Data System feature won't work where the service is not supported by any broadcasting station.
- The unit may not function properly if the connectors between the unit and front panel are dirty. Detach the front panel and clean the connector with a cotton swab gently, being careful not to damage the connector.

■ Protecting the monitor

- To protect the monitor from damage, do not operate the monitor using a ball point pen or similar tool with the sharp tip.

■ Cleaning the unit

- If the faceplate of this unit is stained, wipe it with a dry soft cloth such as a silicon cloth. If the faceplate is stained badly, wipe the stain off with a cloth moistened with neutral cleaner, then wipe it again with a clean soft dry cloth.

NOTE

- Applying spray cleaner directly to the unit may affect its mechanical parts. Wiping the faceplate with a hard cloth or using a volatile liquid such as thinner or alcohol may scratch the surface or erase screened print.

■ Lens fogging

When you turn on the car heater in cold weather, dew or condensation may form on the lens in the disc player of the unit. Called lens fogging, this condensation on the lens may not allow discs to play. In such a situation, remove the disc and wait for the condensation to evaporate. If the unit still does not operate normally after a while, consult your KENWOOD dealer.

■ Precautions on handling discs

- Do not touch the recording surface of the disc.
- Do not stick tape etc. on the disc, or use a disc with tape stuck on it.
- Do not use disc type accessories.
- Clean from the center of the disc and move outward.
- When removing discs from this unit, pull them out horizontally.
- If the disc center hole or outside rim has burrs, use the disc only after removing the burrs with a ballpoint pen etc.
- Discs that are not round cannot be used.

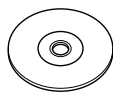

- 8-cm (3 inch) discs cannot be used.
- Discs with coloring on the recording surface or discs that are dirty cannot be used.

- This unit can only play the CDs with



- This unit may not correctly play discs which do not have the mark.
- You cannot play a disc that has not been finalized. (For the finalization process see your writing software, and your recorder instruction manual.)

Acquiring GPS signal

The first time you turn on this unit, you must wait while the system acquires satellite signals for the first time. This process could take up to several minutes. Make sure your vehicle is outdoors in an open area away from tall buildings and trees for fastest acquisition.

After the system acquires satellites for the first time, it will acquire satellites quickly each time thereafter.

Caution for Smartphone Users

Simultaneously running multiple applications on your smartphone while screen sharing places heavy demand on the microprocessor of the phone, potentially affecting communication and performance.

For best results while pairing with your Kenwood receiver, please be sure to close any unused applications by performing the following steps:

Android operating system example:

- Turn off WiFi in phone settings menu.
- Close all open applications before connecting for in-car use. Hold the <Home> key and select <Close all> to close all open applications.
- Clear RAM Memory of the Android phone before connecting for in-car use. Hold the <Home> key and select <Task Manager> then select <RAM> then select <Clear memory> to clear current memory processes.



<Home> Key

How to read this manual

- The screens and panels shown in this manual are examples used to provide clear explanations of the operations. For this reason, they may be different from the actual screens or panels used, or some display patterns may be different.
- **Indication language:** English indications are used for the purpose of explanation. You can select the indication language from the **SETUP** menu. See **User Interface Setup (P.74)**.

Basic Operations

Functions of the Buttons on the Front Panel

DDX8905S

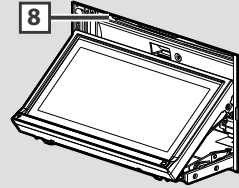
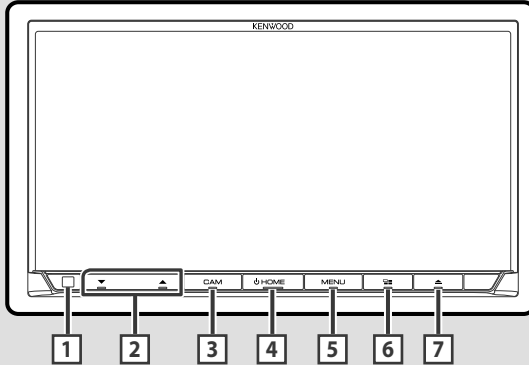

DMX7705S

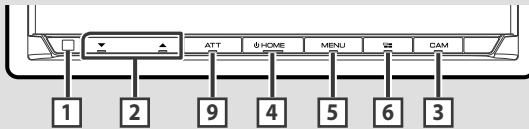

NOTE

• The panels shown in this guide are examples used to provide clear explanations of the operations. For this reason, they may be different from the actual panels.

Number	Name	Motion
1	Remote Sensor	• Receives the remote control signal.
2	▼ ▲ (Volume)	• Adjusts volume. The volume will go up until 15 when you keep pressing ▲.
3	CAM	• Switches view camera display on/off. (P.69) – The camera whose view is displayed first changes according to the "Camera Setup" setting and the shift lever position in the shift gate.
4	HOME	• Displays the HOME screen (P.11) . • Pressing for 1 second turns the power off. • When the power off, turns the power on.
5	MENU	• Displays the popup menu screen. • Pressing for 1 second switches attenuation of the volume on/off. (DDX8905S only)
6		• Displays the APP (CarPlay/ Android Auto/ WebLink) screen. • Pressing for 1 second displays the Voice Recognition screen (P.65) .

Number	Name	Motion
7	▲	<ul style="list-style-type: none"> Displays the Angle Adjust screen. <ul style="list-style-type: none"> DISC EJECT: Ejects the disc. When the panel is opened, pressing closes the panel. To forcibly eject the disc, press it for 2 seconds and touch Yes after the message is displayed.
8	Disc insert slot	<ul style="list-style-type: none"> A slot to insert a disc media. (DDX8905S only)
9	ATT	<ul style="list-style-type: none"> Switches attenuation of the volume on/off.

DDX6905S/ DDX6705S

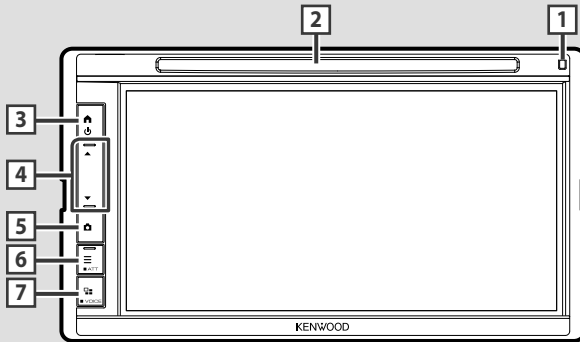

NOTE

- The panels shown in this guide are examples used to provide clear explanations of the operations. For this reason, they may be different from the actual panels.

Number	Name	Motion
1	Remote Sensor	<ul style="list-style-type: none"> Receives the remote control signal.
2	Disc insert slot	<ul style="list-style-type: none"> A slot to insert a disc media.
3	🏠	<ul style="list-style-type: none"> Displays the HOME screen (P.11). Pressing for 1 second turns the power off. When the power off, turns the power on.
4	▼, ▲ (Volume)	<ul style="list-style-type: none"> Adjusts volume. The volume will go up until 15 when you keep pressing ▲.
5	📷	<ul style="list-style-type: none"> Switches view camera display on/off. (P.69) <ul style="list-style-type: none"> The camera whose view is displayed first changes according to the "Camera Setup" setting and the shift lever position in the shift gate.
6	☰	<ul style="list-style-type: none"> Displays the popup menu screen. Pressing for 1 second switches attenuation of the volume on/off.
7	📱	<ul style="list-style-type: none"> Displays the APP (CarPlay/ Android Auto/ WebLink) screen. Pressing this switch each time toggles between current source screen and APP screen. Pressing for 1 second displays the Voice Recognition screen (P.65).

Turning on the Unit

The method of turning on is different depending on the model.

1 DDX8905S/DMX7705S

Press the **HOME** button.

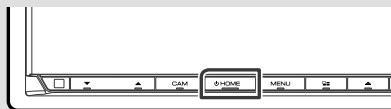

DDX6905S/ DDX6705S

Press the **HOME** button.



▶ The unit is turned on.

● To turn off the unit:

1 DDX8905S/DMX7705S

Press the **HOME** button for 1 second.

DDX6905S/ DDX6705S

Press the **HOME** button for 1 second.

NOTE

- If it is your first time turning the unit on after installation, it will be necessary to perform Initial setup (P.8).

Initial Settings

Initial setup

Perform this setup when you use this unit first time.

1 Set each item as follows.



■ Language

Select the language used for the control screen and setting items. Default is "American English (en)".

- ① Touch **Language**.
- ② Touch **Language Select**.
- ③ Select the desired language.
- ④ Touch **↩**.

For detailed operation, see **User Interface Setup (P.74)**.

■ Clock

Sets the synchronization of the clock and adjusts it.

For detailed operation, see **Calendar/clock settings (P.9)**.

■ Display

Set the button illumination color.

If it is hard to see the image on the screen even, adjust the viewing angle.

- ① Touch **Display**.
- ② Touch **Key Color**.
- ③ Select the desired color.
- ④ Touch **↩**.
- ⑤ Touch **Viewing Angle**.
- ⑥ Select an angle
- ⑦ Touch **↩**.

For detailed operation, see **Display Setup (P.75)**.

■ Camera

Set the parameters for the camera.

- 1 Touch **Camera**.
- 2 Set each item and touch .

For detailed operation, see **Camera Setup (P.69)**.

■ OEM SETUP

This function requires a commercial adaptor. Consult your KENWOOD dealer for details.

■ DEMO

Set the demonstration mode. Default is "ON".

- 1 Touch **DEMO** and set ON or OFF.

2 Touch Finish.

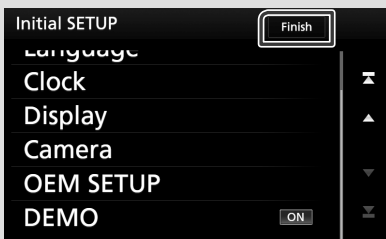

NOTE

- These settings can be set from the SETUP menu. See **Setting Up (P.73)**.

Calendar/clock settings

1 DDX8905S/ DMX7705S

Press the **MENU** button.

DDX6905S/ DDX6705S

Press the  button.

- Pop up menu appears.

2 Touch SETUP.



- SETUP Menu screen appears.

3 Touch User Interface.

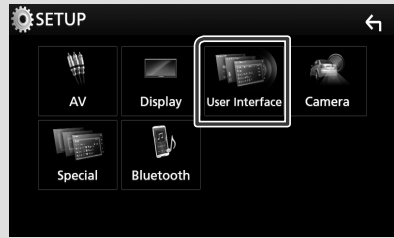

- User Interface screen appears.

4 Touch Time Zone in the User Interface screen.

5 Select the time zone.

6 Set each item as follows.

Scroll the page to show the item.

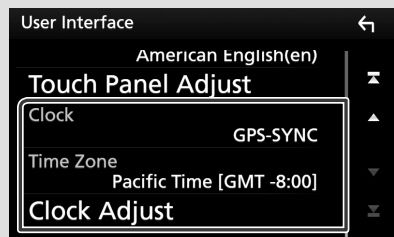

■ Clock

DDX8905S

GPS-SYNC (Default): Synchronizes the clock time with the GPS.

DDX6905S/ DDX6705S/ DMX7705S

RDS-SYNC (Default): Synchronizing the Radio Data System station time data and this unit's clock.

Manual: Sets the clock manually.

■ Time Zone

Select the time zone.

■ Clock Adjust

If you select **Manual** for Clock, adjust the date and time manually. **(P.74)**

NOTE

- Please set the date and time. If it is not set, it may not work with some functions.

Adjusting the volume

To adjust the volume (0 to 40),
Press ▲ to increase, and press ▼ to decrease.
Holding ▲ increases the volume continuously
to level 15.

DDX8905S/DMX7705S

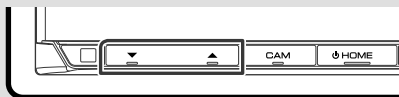

DDX6905S/DDX6705S

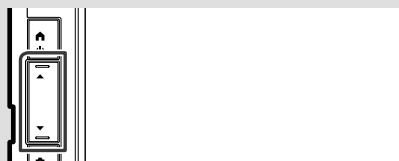

Monitor Angle Control (DDX8905S)

You can adjust the position of the monitor.

- 1 Press the ▲ button.
➤ Angle Adjust screen appears.
- 2 Select a below number that represents your desired angle setting.
Default is "0".

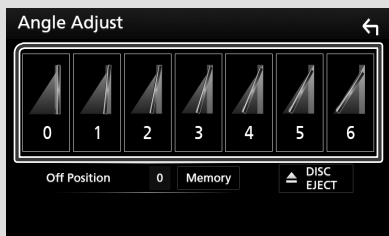

■ Off Position

You can store the current monitor angle as the angle during power off. Touch **Memory** when the desired angle is selected.

Touch screen operations

To perform operations on the screen, you need to touch, touch and hold, flick or swipe to select an item, display setting menu screen or to change the page, etc.

● Touch

Touch the screen gently to select an item on the screen.

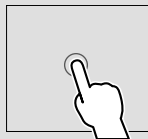

● Touch and hold

Touch the screen and keep your finger in place until the display changes or a message is displayed.

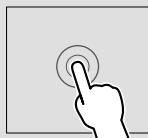

● Flick

Slide your finger quickly to the left or right on the screen to change the page.

You can scroll the list screen by flicking the screen up/down.



● Swipe

Slide your finger up or down on the screen to scroll the screen.



HOME screen descriptions

Most functions can be performed from the HOME screen.



- | | |
|----------|--|
| 1 | <ul style="list-style-type: none"> • Displays the control screen of current source. • The artwork is displayed if available from current content. |
| 2 | <ul style="list-style-type: none"> • Widget <ul style="list-style-type: none"> – You can change the widget by touching or or flicking left or right on the widget area. – Touch the widget to display the detailed screen. |
| 3 | <ul style="list-style-type: none"> • Page indication for widgets |
| 4 | <ul style="list-style-type: none"> • Current source information |
| 5 | <ul style="list-style-type: none"> • Displays the source selection screen. (P.12) |
| 6 | <ul style="list-style-type: none"> • Short-cut playback source icons (P.13) |
| 7 | <ul style="list-style-type: none"> • Displays the Hands Free screen. (P.64) • When connecting as Apple CarPlay or Android Auto, it works as a phone provided in Apple CarPlay or Android Auto. |

Display the HOME

- 1** DDX8905S/ DMX7705S
Press the **HOME** button.



- DDX6905S/ DDX6705S
Press the button.

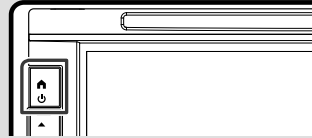

- HOME screen appears.

Source selection screen descriptions

You can display all playback sources and options on the source selection screen.









- | | |
|---|--|
| 1 | • Changes the playback source.
For playback sources, see P.12 . |
| 2 | • Changes the page. (Touch ◀ / ▶ .)
You can also change the page by flicking left or right on the screen. |
| 3 | • Returns to previous screen. |
| 4 | • Page indication |
| 5 | • Displays the SETUP Menu screen. (P.73) |

Select the playback source

1 Touch on the HOME screen.

From the screen, you can select the following sources and functions.

	• Switches to the Android Auto/ Apple CarPlay screen from the connected iPhone/Android device.* ¹ (P.22)
	• Switches to the HD Radio broadcast. (P.39) * ²
	• Switches to the Radio broadcast. (P.36) * ³
	• Switches to the SiriusXM® satellite radio broadcast. (P.46)

	• Plays a Bluetooth audio player. (P.58)
	• Plays a disc. (P.16) * ⁴
	• Plays an iPod/iPhone. (P.33)
	• Plays files on a USB device. (P.30)
	• Switches to the Pandora. (P.26)
	• Switches to the Spotify. (P.28)
	• Switches to an external component connected to the AV-IN input terminal. (P.71)
	• Displays the WebLink screen. (P.25)
	• Displays the Waze screen. (P.25)
	• Displays the Audio screen. (P.78)
	• Puts the unit in standby. (P.13)

• For sources and information displayed when an ADS adapter is connected, see **OEM Features Operation (P.72)**.

*¹ When iPhone compatible with CarPlay is connected, **Apple CarPlay** is displayed. When an Android device compatible with Android Auto is connected, **Android Auto** is displayed.

*² DDX8905S only

*³ DDX6905S/ DDX6705S/ DMX7705S only

*⁴ DDX8905S/ DDX6905S/ DDX6705S only

To select the playback source on the HOME screen

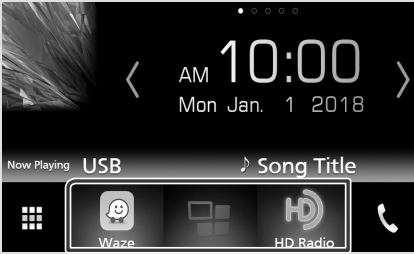

The 3 items displayed on the source selection screen as the large icons are shown on the HOME screen.

You can change items displayed on this area by customizing the source selection screen. (P.13)

To select the playback source on the source control screen

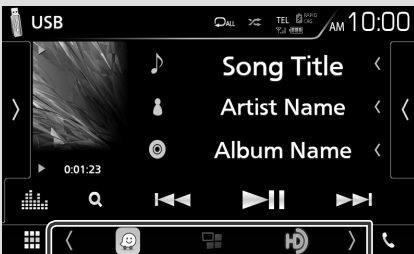

Display source selection buttons by touching or or flicking left or right on the source control screen, then select a playback source.

Put the unit in standby

- 1 Touch on the HOME screen.
- 2 Touch **STANDBY**.

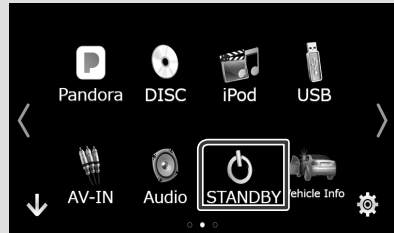

Customize Short-cut buttons on HOME screen

You can arrange the position of the source icons as you like.

- 1 Touch on the HOME screen.
- 2 Touch and hold the icon which you want to move to go into the customizing mode.
- 3 Drag it where you want to move.

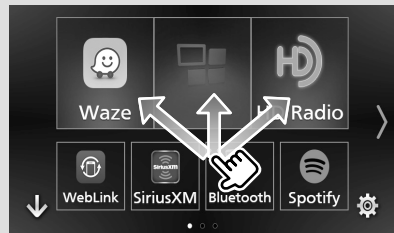

Changes the page

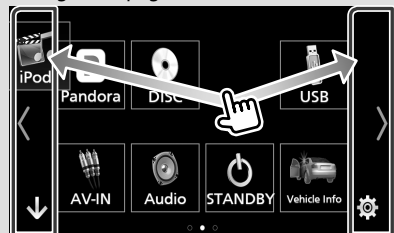

Source control screen descriptions

There are some functions which can be operated from most screens.

Indicators

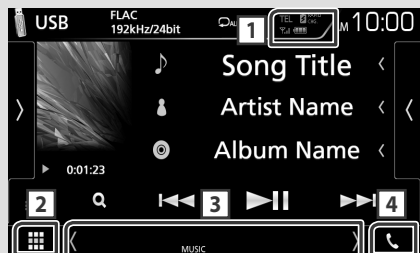

Short-cut buttons



1 TEL RAPID CHG.

- Connected Bluetooth device information.
- : Lights up when quick charging battery of the connected iPod/ iPhone/ Smartphone.

2 All sources icon

Displays all sources.

3 Secondary screen

- : The Secondary screen changes every time you touch it. You can also change the Secondary screen by flicking left or right on the screen.
- Indicators: Displays the current source condition and so on.
 - **ATT**: The attenuator is active.
 - **DUAL**: The dual zone function is on.
 - **MUTE**: The mute function is active.
 - **LOUD**: The loudness control function is on.
- Short-cut buttons: The source changes to the one you have set as a short-cut. For the short-cut setting, refer to **Customize Short-cut buttons on HOME screen (P.13)**.

4

Touch to display the Hands Free screen. **(P.64)**

When connecting as Apple CarPlay or Android Auto, it works as a phone provided in Apple CarPlay or Android Auto.

Popup menu

1 DDX8905S/ DMX7705S

Press the **MENU** button.



DDX6905S/ DDX6705S

Press the button.



➤ Popup menu appears.

2 Touch to display the popup menu.



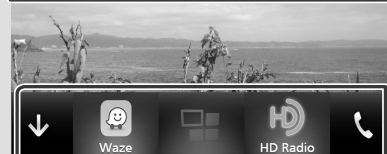







DDX8905S/ DMX7705S



DDX6905S/ DDX6705S



The contents of the menu are as follows.

	• Displays the Screen Adjustment screen. (P.73)
	• Turns the display off. (P.15)
	• Displays the view camera. (P.69)
	• Displays the SETUP Menu screen. (P.73)
	• Displays the Audio screen. (P.78)
	• Displays the control screen of current source. Icon feature differs depending on the source.
	• Close the popup menu.
	• See HOME screen descriptions (P.11) .
	• See HOME screen descriptions (P.11) .
	DDX8905S/ DMX7705S only
	• Ejects the disc. • To forcibly eject the disc, press it for 2 seconds and touch Yes after the message is displayed. DDX6905S/ DDX6705S only

Turn off the screen

1 Select Display OFF on the popup menu.



● To turn on the screen

1 Touch the display.

List screen

There are some common function keys in the list screens of most sources.



Displays list type selection window.





Displays music/movie file list.



Scrolls the displayed text.





Keys with various functions are displayed here.

-  **Play**: Plays all tracks in the folder containing the current track.
-  **A-Z**: Jump to the letter you entered (alphabet search).
-  **Top Up**: Moves to the upper hierarchy.



You can change the page to display more items by pressing  / .

-  / : Displays the top or bottom page.



Returns to previous screen.

NOTE

- Buttons which cannot be activated from the list screen are not displayed.

Disc (DDX8905S/DDX6905S/DDX6705S)

Playing a disc

DDX8905S

■ Insert a disc

- 1 Press the **▲** button.

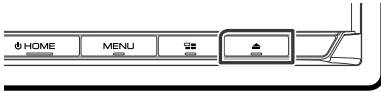

- 2 Touch **DISC EJECT**.

➤ The panel opens.

- 3 Insert the disc into the slot.

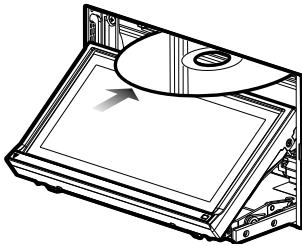

➤ The panel closes automatically.
The unit loads the disc and playback starts.

■ Eject a disc

- 1 Press the **▲** button.
- 2 Touch **DISC EJECT**.
When removing a disc, pull it horizontally.
- 3 Press the **▲** button.

DDX6905S/ DDX6705S

■ Insert a disc

- 1 Insert the disc into the slot.

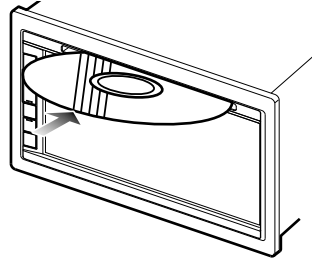

➤ The unit loads the disc and playback starts.

■ Eject a disc

- 1 Press the **≡** button.



- 2 Touch **▲**.



When removing a disc, pull it horizontally.

NOTE

- This is not displayed on the pop-up menu screen of Apple CarPlay or Android Auto source. Change Apple CarPlay or Android Auto source to other one to display the pop-up menu screen.

DVD/VCD Basic Operation

Most functions can be controlled from the source control screen and playback screen.

NOTE

- Set the remote control mode switch to DVD mode before starting operation for DVD and VCD, see **Switch the operation mode (P.85)**.
- The screen shot below is for DVD. It may be different from the one for VCD.

1 When the operation buttons are not displayed on the screen, touch the [7] area.

Control screen



Video screen



1 Information display

Displays the following information.

- **Title #, Chapter #:** DVD title and chapter number display
- **Track #/Scene #:** VCD track or scene number display. Scene # is displayed only when Playback control (PBC) is on.
- **Linear PCM, etc.:** Audio format
- **Hide:** Hides the control screen.
- : Repeats the current content. Each time you touch the key, repeat mode switches in the following sequence;
DVD: Title repeat () , Chapter repeat () , Repeat off ()
VCD (PBC On): Does not repeat
VCD (PBC Off): Track repeat () , Repeat off ()

2 Function panel

Touch on the left side of the screen to display the function panel. Touch again to close the panel. For details on the keys, see **Function panel (P.18)**.

3 Play mode indicator/ Playing time

- : Current play mode indicator
 The meanings of each icon are as follows;
 (play), (fast forward),
 (fast backward), (stop), (resume stop),
 (pause), (slow playback),
 (slow reverse playback).

4 Operation keys

- : Searches the previous/next content.
 Touch and hold to fast forward or fast backward. (It will be cancelled automatically after about 50 seconds.)
- : Plays or pauses.
- : Displays the Graphic Equalizer screen. (P.80)

5 Indicator Items

- **IN:** A disc is inserted.
 White: A Disc is inside the unit.
 Orange: Error at the disc player

VCD

- **1chLL/2chLL:** Identifies the left audio output of channel 1 or 2.
- **1chLR/2chLR:** Identifies the monaural audio output of channel 1 or 2.
- **1chRR/2chRR:** Identifies the right audio output of channel 1 or 2.
- **1chST/2chST:** Identifies the stereo audio output of channel 1 or 2.
- **LL:** Identifies the left audio output.
- **LR:** Identifies the monaural audio output.
- **RR:** Identifies the right audio output.
- **ST:** Identifies the stereo audio output.
- **PBC:** The PBC function is on.
- **VER1:** The VCD version is 1.
- **VER2:** The VCD version is 2.

6 Searching area

Touch to search the next/previous content.

7 Key display area

Touch to display the control screen.

8 MENU CTRL (DVD only)

Touch to display the DVD-VIDEO disc menu control screen. See **DVD Disc Menu Operation (P.20)**.

NOTE

- The control screen disappears when no operation is done for 5 seconds.
- If you use a remote control, you can jump directly to the desired image with entering the chapter number, scene number, play time, etc. **(P.86)**.

Function panel

1 Touch  on the left side of the screen.

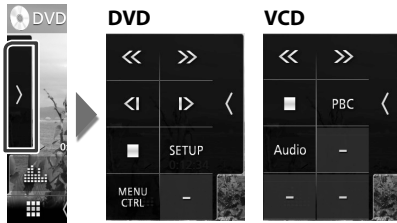

The functions of each key are as follows.



Stops playback. When touched twice, the disc is played from the beginning when you play it the next time.



Fast forward or fast backward. Each time you touch the key, the speed changes; 2 times, 8 times.



Plays in slow motion forward or backward.

SETUP (DVD only)

Touch to display the DVD SETUP screen. See **DVD Setup (P.21)**.

MENU CTRL (DVD only)

Touch to display the DVD-VIDEO disc menu control screen. See **DVD Disc Menu Operation (P.20)**.

PBC (VCD only)

Turn Playback control (PBC) on or off.

Audio (VCD only)

Change the audio output channel.

Music CD/ Disc media Basic Operation

Most functions can be controlled from the source control screen and playback screen.

NOTE

- Set the remote controller mode switch to AUD mode before starting operation for Music CD and audio files, see **Switch the operation mode (P.85)**.
- In this manual, "Music CD" will be referred to as the general CDs which include music tracks in. "Disc media" will be referred to as CD/DVD disc which includes audio or video files.
- The screen shot below is for disc media. It may be different from the one for CD.



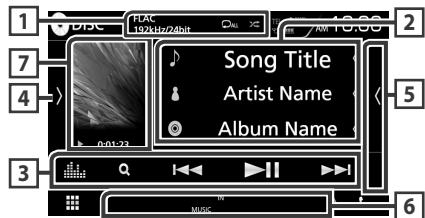



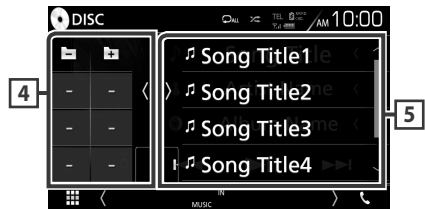

Control screen



Open the drawer



1 CODEC /  / 

- When a high-resolution source is played, its format information is displayed. (Disc media only)
-  : Repeats the current track/folder. Each time you touch the key, repeat mode switches in the following sequence; Track/ File repeat (), Folder repeat () (Disc media only), Repeat all ()
-  : Randomly plays all tracks in current folder/disc. Each time you touch the key, random mode switches in the following sequence; Track random () (Music CD only), Folder random () (Disc media only), Random off ()

2 Track information

Displays the information of the current track/ file. Only a file name and a folder name are displayed if there is no tag information. (Disc media only)

3 Operation keys

- **Q** (Disc media only) : Searches file. For details on search operation, see **File search Operation (P.19)**.
- **◀◀ ▶▶** : Searches the previous/next content.
Touch and hold to fast forward or fast backward. (It will be cancelled automatically after about 50 seconds.)
- **▶||** : Plays or pauses.
- **📊** : Displays the Graphic Equalizer screen. **(P.80)**

4 Function panel (Disc media only)

Touch on the left side of the screen to display the function panel. Touch again to close the panel.

- **📁 +** : Searches previous/next folder.

5 Content list

- Touch on the right side of the screen to display the Content list. Touch again to close the list.
- Displays the playing list. When you touch a track/file name on the list, playback will start.

6 Indicator Items

- **IN** : A disc is inserted.
White: A Disc is inside the unit.
Orange: Error at the disc player
- **VIDEO** : Identifies the video file.
- **MUSIC** : Identifies the music file.

7 Artwork (Disc media only) /Play mode indicator/ Playing time

- The jacket of the currently playing file is displayed.
- **▶, ▶▶, etc.**: Current play mode indicator
The meanings of each icon are as follows; **▶** (play), **▶▶** (fast forward), **◀◀** (fast backward), **||** (pause).

Video screen



8 Searching file area (Video file only)

Touch to search the next/previous file.

9 Key display area (Video file only)

Touch to display the control screen.

File search Operation (Disc media only)

You can search a file according to hierarchy.

NOTE

- For operations in the list screen, see **List screen (P.15)**.

- 1 Touch **Q**.
➤ Folder List screen appears.
- 2 Touch the desired folder.



- When you touch a folder its contents are displayed.
- 3 Touch desired item from the content list.
➤ Playback starts.

DVD Disc Menu Operation

You can set up some items in the DVD-VIDEO disc menu.

1 Touch illustrated area during playback.



➤ Menu Control screen appears.

2 Perform desired operation as follows.

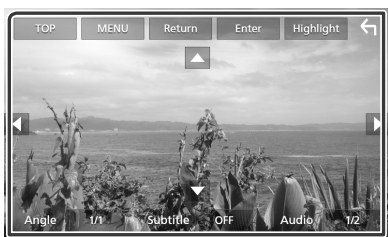

■ Displays the top menu

Touch **TOP**.*

■ Displays the menu

Touch **MENU**.*

■ Displays the previous menu

Touch **Return**.*

■ Enters selected item

Touch **Enter**.

■ Enables direct operation

Touch **Highlight** to enter the highlight control mode (**P.20**).

■ Moves the cursor

Touch ▲, ▼, ◀, ▶.

■ Switches the subtitle language

Touch **Subtitle**. Each time you touch this key, language is switched.

■ Switches the audio language

Touch **Audio**. Each time you touch this key, language is switched.

■ Switches the picture angle

Touch **Angle**. Each time you touch this key, picture angle is switched.

*These keys may not function depending on the disc.

■ Highlight control

Highlight control lets you control the DVD menu by touching the menu key directly on the screen.

1 Touch **Highlight** in the Menu Control screen.

2 Touch desired item on the screen.



NOTE

- The highlight control is cleared automatically if you do not operate for a constant time.

DVD Setup

You can set up the DVD playback functions.

1 Touch illustrated area during playback.



2 Touch on the left side of the screen. Touch **SETUP**.

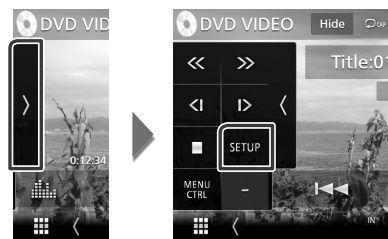

► DVD SETUP screen appears.

3 Set each item as follows.

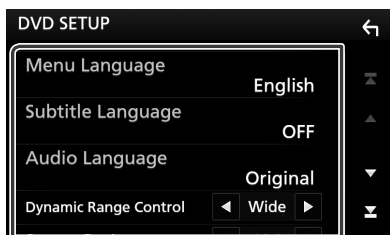

■ **Menu Language / Subtitle Language / Audio Language**

See **Language setup (P.21)**.

■ **Dynamic Range Control**

Sets the dynamic range.

Wide: The dynamic range is wide.

Normal: The dynamic range is normal.

Dialog (Default): Makes the total sound volume larger than other modes. This is effective only when you are using Dolby Digital software.

■ **Screen Ratio**

Sets the screen display mode.

16:9 (Default): Displays wide pictures.

4:3 LB: Displays wide pictures in the Letter Box format (having black stripes at the top and bottom of screen).

4:3 PS: Displays wide pictures in the Pan & Scan format (showing pictures cut at the right and left ends).

Language setup

This setting is for the language used in the menu, subtitle, and voice.

1 Touch the desired item; **Menu Language, Subtitle Language, Audio Language.**

► Language Set screen appears.

2 Select a language.



For language code, refer to **DVD Language Codes (P.101)**.

Sets the entered language and returns to the DVD Setting screen.

NOTE

- To set the DVD's original language for audio language, touch **Original**.

APPS—Android Auto™/Apple CarPlay

Apple CarPlay Operation

CarPlay is a smarter, safer way to use your iPhone in the car. CarPlay takes the things you want to do with iPhone while driving and displays them on the screen of the product. You can get directions, make calls, send and receive messages, and listen to the music from iPhone while driving. You can also use Siri voice control to make it easier to operate iPhone.

For details about CarPlay, visit <https://ssl.apple.com/ios/carplay/>.

Compatible iPhone devices

You can use CarPlay with the following iPhone models.

- iPhone 7 Plus
- iPhone 7
- iPhone SE
- iPhone 6s Plus
- iPhone 6s
- iPhone 6 Plus
- iPhone 6
- iPhone 5s
- iPhone 5c
- iPhone 5

Preparation

1 Connect iPhone using KCA-iP103 via USB (Black) terminal. (P.95)

When iPhone compatible with CarPlay is connected to the USB (Black) terminal, the Bluetooth Hands-Free phone currently connected is disconnected.

2 Unlock your iPhone.

Operation buttons and available Apps on the home screen of CarPlay

You can use the Apps of the connected iPhone. The items displayed and the language used on the screen differ among the connected devices.

To enter CarPlay mode, touch **Apple CarPlay** icon in the source selection screen. (P.12)

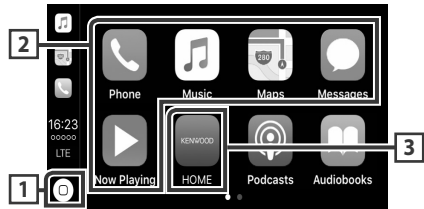

1

- Displays the home screen of CarPlay.
- Touch and hold to activate Siri.

2 Application buttons

Starts the application.

3 HOME

Exits the CarPlay screen and displays the Home screen.

To exit the CarPlay screen

- 1 DDX8905S/ DMX7705S
Press the **HOME** button.
DDX6905S/ DDX6705S
Press the **HOME** button.

Use Siri

You can activate Siri.

- 1 Press the  button for 1 second.
DDX8905S/ DMX7705S



DDX6905S/ DDX6705S

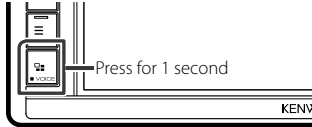

- 2 Talk to Siri.

To deactivate

- 1 Press the  button.

Switch to the Apple CarPlay screen while listening to another source

- 1 Press the  button.
DDX8905S/ DMX7705S



DDX6905S/ DDX6705S



NOTE

- If sound is output using Apple CarPlay when the Apple CarPlay screen is displayed, the source is switched to Apple CarPlay.

Android Auto™ Operation

Android Auto enables you to use functions of your Android device convenient for driving. You can easily access route guidance, make calls, listen to music, and access convenient functions on the Android device while driving. For details about Android Auto, visit <https://www.android.com/auto/> and <https://support.google.com/androidauto>.

Compatible Android devices

You can use Android Auto with Android devices of Android version 5.0 (Lollipop) or later.

NOTE

- Android Auto may not be available on all devices and is not available in all countries or regions.

Preparation

- 1 Connect an Android device via USB terminal. (P.95)
To use the hands-free function, connect the Android device via Bluetooth.
When an Android device compatible with Android Auto is connected to the USB terminal, the device is connected via Bluetooth automatically, and the Bluetooth Hands-Free phone currently connected is disconnected.
- 2 Unlock your Android device.

Operation buttons and available Apps on the Android Auto screen

You can perform the operations of the Apps of the connected Android device.

The items displayed on the screen differ among the connected Android devices.

To enter Android Auto mode, touch **Android Auto** icon in the source selection screen. (P.12)

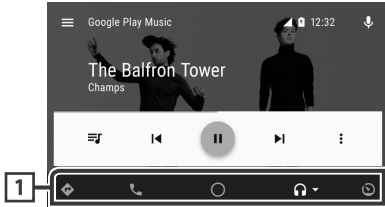

1 Application/information buttons

Starts the application or displays information.

To exit the Android Auto screen

- 1 DDX8905S/ DMX7705S
Press the **HOME** button.
DDX6905S/ DDX6705S
Press the **HOME** button.

Using voice control

- 1 Press the **VOICE** button for 1 second.
DDX8905S/ DMX7705S



DDX6905S/ DDX6705S

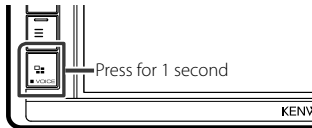

To cancel

- 1 Press the **VOICE** button.

Switch to the Android Auto screen while listening to another source

- 1 Press the **VOICE** button.
DDX8905S/ DMX7705S

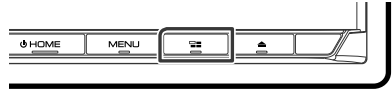

DDX6905S/ DDX6705S



NOTE

- If sound is output using Android Auto when the Android Auto screen is displayed, the source is switched to Android Auto.

WebLink™/Waze Operation

You can display and control the App on the unit while your smartphone is connected to the USB terminal.

Available Apps

You can use the following Apps on this unit. Install the Apps on your smartphone beforehand.

WebLink™

WebLink™ enables you to use the following Apps with the unit.

- Media player
- Waze
- Yelp
- YouTube
- OpenWeatherMap

Waze

Waze is the world's largest community based traffic and navigation App. Join other drivers in your area who share real-time traffic and road info, saving everyone time and gas money on their daily commute.

- To use Waze on the unit, you need to install WebLink™ and Waze on your smartphone beforehand.

1 Connecting a smartphone

- Connect an Android device via USB terminal. **(P.94)**
- Connect iPhone using KCA-iP103 via USB (Black) terminal. **(P.95)**
- When the smartphone is connected to the unit, a confirmation message to communicate each other appears on the smartphone. Touch **Allow** to establish connection, or **Ignore** to cancel the connection.
- You can check the connection status on the WebLink™ screen on your smartphone.

Operation buttons and available Apps on the App screen

To enter WebLink™ or Waze mode, touch **WebLink** or **Waze** icon in the source selection screen. **(P.12)**

WebLink source screen

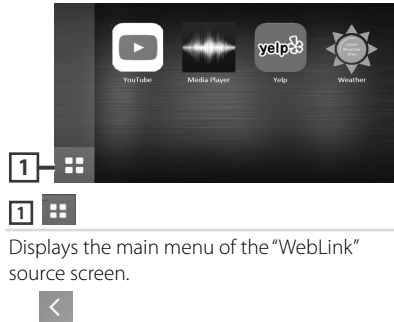

Displays the main menu of the “WebLink” source screen.

Returns to the previous screen.

2 Operate on your smartphone.

- When you are asked to communicate between your smartphone and the unit, touch **Allow** to proceed.

Switching to the App screen while listening to the another source

1 Press the button.

NOTE

- If sound is output using WebLink when the App screen is displayed, the source is switched to WebLink.

Pandora® Operation

You can listen to the Pandora® on this unit by controlling the application installed in the iPhone or Bluetooth device.

To enter Pandora source, touch **Pandora** icon in the source selection screen. (P.12)

Preparation

- Install the latest version of the Pandora® application on your iPhone, Android or BlackBerry.
- iPhone:** Search for "Pandora" in the Apple App Store to find and install the most current version.
- Android:** Visit the Google play and search for Pandora to install.
- BlackBerry:** Visit www.pandora.com from the built in browser to download the Pandora application.
- iPhones are connected on either USB or Bluetooth.
- Android or BlackBerry devices are connected on Bluetooth.
- To connect a smartphone via Bluetooth, register it as the Bluetooth device and do the App (SPP) profile setting of the connection beforehand. See **Register the Bluetooth device (P.59)** and **Connect the Bluetooth device (P.61)**.

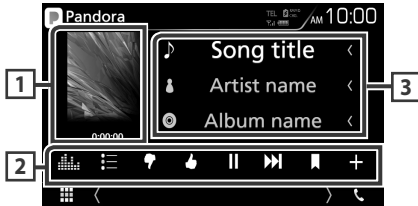

1 Artwork/ Playing time

- The picture data is displayed if available from current content.
- For confirmation of play time.

2 Operation keys

- : Searches for a station. For details on searching, see **Station list screen (P.26)**.
- (Thumbs down) : Thumbs down to the current contents and skip to the next contents.
- (Thumbs up) : Registers the current contents as favorite content.
- : Plays or pauses the content of the current station.

- : Skips the current song. (Note this function is disabled when the Pandora skip limitation is exceeded.)
- (Bookmark Song) : Bookmarks a song in the current contents.
- : Creates a new station. See **Creates a new station (P.27)**.
- : Displays the Graphic Equalizer screen. (P.80)

3 Content information

Displays the information of the current content being played.

Station list screen

You can perform the following functions from this screen.

1 Touch .

➤ Station List screen appears.

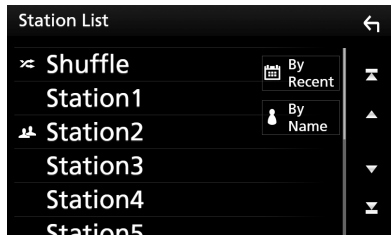

■ Selects the station

Touch the station name in the list.

■ Sort the list by registered date

Touch **By Recent**. The list is sorted to begin with the last registered station.

■ Sort the list in alphabetical order

Touch **By Name**. You can select the desired letter from the list which corresponds to the station name to help narrow the search.

NOTE

- You can operate Pandora by using the remote control. However, only playing, pausing, and skipping are available.

Creates a new station

1 Touch  .

2 Touch desired item.

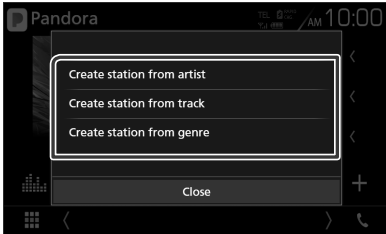

Create station from artist

Creates a new station based on an artist being played.

Create station from track

Creates a new station based on a song being played.

Create station from genre

Displays the genre list screen.

Genre list screen

1 Touch **Create station from genre**.

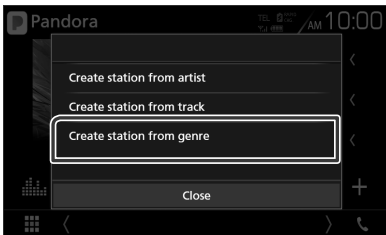

2 The selected genre is created as a new station.



About Pandora®

NOTE

- In the application on your device, log in and create an account with Pandora. (If you are not already a registered user, an account can also be created at www.pandora.com.)
- Establish an Internet connection.
- Pandora is only available in certain countries. Please visit <http://www.pandora.com/legal> for more information.
- Because Pandora® is a third-party service, the specifications are subject to change without prior notice. Accordingly, compatibility may be impaired or some or all of the services may become unavailable.
- Some functions of Pandora® cannot be operated from this unit.
- For issues using the application, please contact Pandora® at pandora-support@pandora.com.

Spotify Operation

You can listen to the Spotify on this unit by controlling the application installed in the iPhone or Android.

To enter Spotify source, touch **Spotify** icon in the source selection screen. (P.12)

Preparation

- Install the latest version of the Spotify application "Spotify" on your iPhone or Android.
- iPhone:** Search for "Spotify" in the Apple App Store to find and install the most current version.
- Android:** Search for "Spotify" in Google play to find and install the most current version.
- iPhones are connected on either USB or Bluetooth.
- Android devices are connected on Bluetooth.
- To connect a smartphone via Bluetooth, register it as the Bluetooth device and do the App (SPP) profile setting of the connection beforehand. See **Register the Bluetooth device (P.59)** and **Connect the Bluetooth device (P.61)**.



1 Artwork/ Playing time

- The picture data is displayed if available from current content.
- For confirmation of play time.

2 Operation keys

- : Displays the Menu screen
- : New radio station that relates to the artist of the currently playing song is selected and playback starts.
- , : Skips the current song.
- , : Plays or pauses the content of the current station.
- : Saves currently playing song to My Music.
- : Displays the Graphic Equalizer screen. (P.80)

3 Content information

Displays the information of the current content being played.



- : Thumbs down to the current contents and skip to the next contents.
- : Registers the current contents as favorite content.
- : Repeats the current song.
- : Randomly plays all song in current playlist.

Selecting a track

- 1 Touch .
 > Menu screen appears.
- 2 Select the list type, then select a desired item.

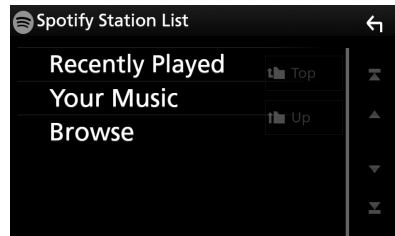

Selects the category and station

Touch the category and station name in the list.

Top

Returns to the first hierarchy of the list.

Up

Returns to the previous list.

About Spotify®

Note

- Ensure you are logged in to your smartphone application. If you do not have an Spotify account, you can create one for free from your smartphone or at www.spotify.com.
- Because Spotify is a third-party service, the specifications are subject to change without prior notice. Accordingly, compatibility may be impaired or some or all of the services may become unavailable.
- Some functions of Spotify cannot be operated from this unit.
- For issues using the application, contact Spotify at www.spotify.com.
- Establish an Internet connection.

USB

Connecting a USB device

- 1 Connect the USB device with the USB cable. (P.94)

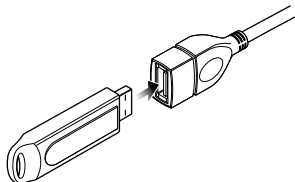

- 2 DDX8905S/ DMX7705S
Press the **HOME** button.
DDX6905S/ DDX6705S
Press the **HOME** button.

- 3 Touch .

- 4 Touch **USB**. (P.12)

Disconnect the USB device

- 1 DDX8905S/ DMX7705S
Press the **HOME** button.
DDX6905S/ DDX6705S
Press the **HOME** button.

- 2 Touch a source other than **USB**.

- 3 Detach the USB device.

Usable USB device

You can use a mass-storage-class USB device on this unit.

The word "USB device" appearing in this manual indicates a flash memory device.

● About file system

The file system should be the one of the following.

- FAT16
- FAT32
- exFAT
- NTFS

NOTE

- Install the USB device in the place where it will not affect safe driving.
- You cannot connect a USB device via a USB hub and Multi Card Reader.
- Take backups of the audio files used with this unit. The files can be erased depending on the operating conditions of the USB device. We shall have no compensation for any damage arising from any erased data.

USB Basic Operation

Most functions can be controlled from the source control screen and playback screen.

NOTE

- Set the remote controller mode switch to **AUD** mode before starting operation, see **Switch the operation mode (P.85)**.



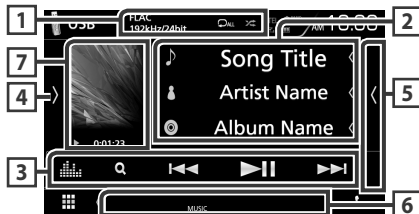



Control screen



Open the drawer







1 CODEC / /

- When a high-resolution source is played, its format information is displayed.
- : Repeats the current track/folder. Each time you touch the key, repeat mode switches in the following sequence; File repeat (), Folder repeat (), Repeat all ()
- : Randomly plays all tracks in current folder. Each time you touch the key, random mode switches in the following sequence; File random (), Random off ()

2 Track information

Displays the information of the current file. Only a file name and a folder name are displayed if there is no tag information.

3 Operation keys

- : Searches track/file. For details on search operation, see **Search Operation (P.32)**.
-  : Searches the previous/next track/file. Touch and hold to fast forward or fast backward. (It will be cancelled automatically after about 50 seconds.)
- : Plays or pauses.
- : Displays the Graphic Equalizer screen. **(P.80)**

4 Function panel

Touch on the left side of the screen to display the function panel. Touch again to close the panel.

-  : Searches previous/next folder.
- **USB DEVICE CHANGE (DDX8905S/ DDX6905S/ DMX7705S)**
Switches to another USB device when two USB devices are connected.

5 Content list





- Touch on the right side of the screen to display the Content list. Touch again to close the list.
- Displays the playing list. When you touch a track/file name on the list, playback will start.

6 Indicator Items

- **VIDEO**: Identifies the video file.
- **MUSIC**: Identifies the music file.

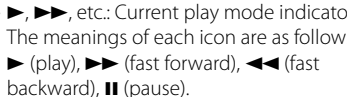
7 Artwork/ Play mode indicator/ Playing time

The jacket of the currently playing file is displayed.

- : Current play mode indicator
The meanings of each icon are as follows;
 (play),  (fast forward),  (fast backward),  (pause).

Video screen



8 Searching file area (Video file only)

Touch to search the next/previous file.

9 Key display area (Video file only)

Touch to display the control screen.

Search Operation

You can search music or video files by the following operations.

- 1 Touch **Q**.
- 2 Touch **▼**.



- 3 Select the list type.

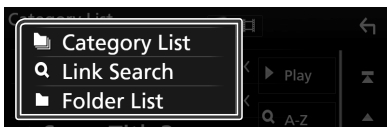

NOTE

• For operations in the list screen, see **List screen (P.15)**.

Category search

You can search a file by selecting category.

- 1 Touch **Category List**.
- 2 Select whether you search by audio files **🎵** or video files **📺**.
- 3 Touch the desired category.

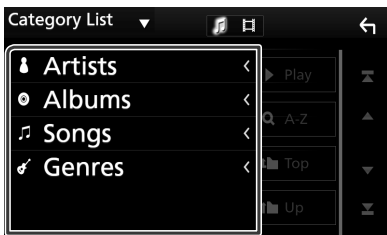

➤ The list corresponding to your selection appears.

- 4 Touch to select desired item in the list. Repeat this step until you find the desired file.

Link search

You can search a file of same artist/album/genre as the current track.

- 1 Touch **Link Search**.
- 2 Touch the desired tag type. You can select from artists, albums and genres.

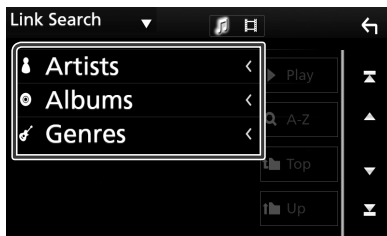

➤ The list corresponding to your selection appears.

- 3 Touch desired item from the content list.

Folder search

You can search a file according to hierarchy.

- 1 Touch **Folder List**.
- 2 Touch the desired folder.



When you touch a folder its contents are displayed.

- 3 Touch to select desired item in the list. Repeat this step until you find the desired file.

iPod/iPhone

Preparation

Connectable iPod/iPhone

The following models can be connected to this unit.

Made for

- iPhone 7 Plus
- iPhone 7
- iPhone SE
- iPhone 6s Plus
- iPhone 6s
- iPhone 6 Plus
- iPhone 6
- iPhone 5s
- iPhone 5c
- iPhone 5
- iPod touch (6th generation)
- iPod touch (5th generation)

NOTE

- Latest compatible list of iPod/iPhone. For details, see www.kenwood.com/cs/ce/ipod/.
- By connecting your iPod/iPhone to this unit with an optional accessory iPod connection cable KCA-iP103, you can supply power to your iPod/iPhone as well as charge it while playing music. However, the power of this unit must be on.
- If you start playback after connecting the iPod, the music that has been played by the iPod is played first.

Connect iPod/iPhone

Wired connection

Preparation

- Connect an iPod/iPhone with the KCA-iP103 (optional accessory) while CarPlay is not connected.
- With a CarPlay-capable iPhone, turn off CarPlay by operating the iPhone at functional setup before connecting iPhone. For details of the setup method, contact the manufacturer of the terminal.
- DDX8905S/ DDX6905S/ DMX7705S: Plug the iPod/iPhone into the gray USB terminal with the KCA-iP103 (optional accessory).
- Only one iPod/iPhone can be connected.

1 Connect the iPod/iPhone using KCA-iP103. (P.95)

- 2 DDX8905S/ DMX7705S**
Press the **HOME** button.
DDX6905S/ DDX6705S
Press the **🏠** button.

3 Touch **📱**.

4 Touch **iPod**. (P.12)

- **To disconnect the iPod/iPhone connected with the cable:**

1 Detach the iPod/iPhone.

Bluetooth connection

Pair the iPhone through Bluetooth.

Preparation

- To connect an iPhone via Bluetooth, register it as the Bluetooth device and do the profile setting of the connection beforehand. See **Register the Bluetooth device (P.59)** and **Connect the Bluetooth device (P.61)**.
- Connect an iPhone on Bluetooth while CarPlay and an iPod/iPhone are not connected on USB.

iPod/iPhone Basic Operation

NOTE

- Set the remote controller mode switch to AUD mode before starting operation, see **Switch the operation mode (P.85)**.

Control screen

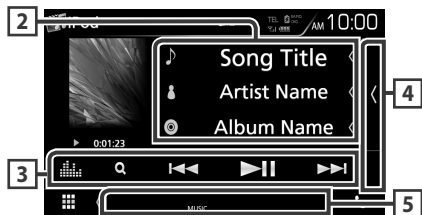

Open the drawer

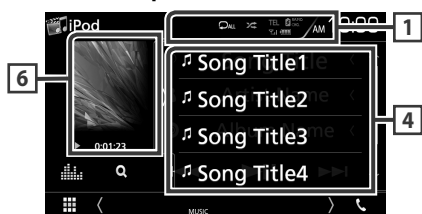

- : Repeats the current track/album. Each time you touch the key, repeat mode switches in the following sequence; Song repeat (), All songs repeat ()
- : Randomly plays all tracks in current album. Each time you touch the key, random mode switches in the following sequence; Song random (), Random off ()

2 Track information

- Displays the information of the current file.
- Touch to display the category list screen. See **Category search (P.35)**.

3 Operation keys

- : Searches track/file. For details on search operation, see **Search Operation (P.35)**.
- : Searches the previous/next track/file. Touch and hold to fast forward or fast backward. (It will be cancelled automatically after about 50 seconds.)
- : Plays or pauses.
- : Displays the Graphic Equalizer screen. (P.80)

4 Content list

- Touch on the right side of the screen to display the Content list. Touch again to close the list.
- Displays the playing list. When you touch a track/file name on the list, playback will start.

5 Indicator Items

- MUSIC**: Identifies the music file.

6 Artwork/ Play mode indicator/ Playing time

The jacket of the currently playing file is displayed.

- : Current play mode indicator. The meanings of each icon are as follows; (play), (fast forward), (fast backward), (pause).

Search Operation

You can search music files by the following operations.

1 Touch **Q**.

2 Touch **▼**.



3 Select the list type.



NOTE

- For operations in the list screen, see [List screen \(P.15\)](#).

Category search

You can search a file by selecting category.

1 Touch **Category List**.

2 Touch the desired category.

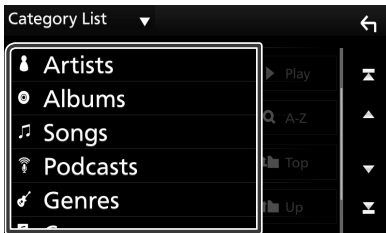

- The list corresponding to your selection appears.

3 Touch to select desired item in the list.
Repeat this step until you find the desired file.

Link search

You can search a file of same artist/album/genre/composer as the current track.

1 Touch **Link Search**.

2 Touch the desired tag type. You can select from artists, albums, genres and composers.

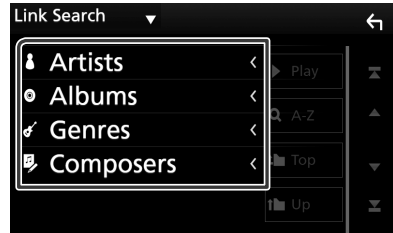

- The list corresponding to your selection appears.

3 Touch desired item from the content list.

Radio (DDX6905S/DDX6705S/DMX7705S)

Radio Basic Operation

Most functions can be controlled from the source control screen.

To enter Radio source, touch **Radio** icon in the source selection screen. (P.12)

NOTE

- Set the remote control mode switch to **AUD** mode before starting operation, see **Switch the operation mode (P.85)**.

Control screen



Preset list screen

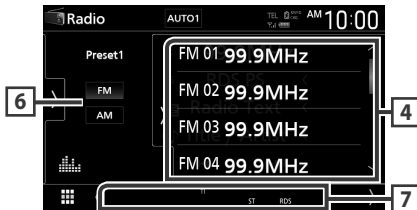

1 Information display

Displays the information of the current station: Frequency and Channel

Touching allows you to switch between Content A and Content B.

Content A: PS name, Radio Text, Title & Artist
Content B: PTY Genre, Radio Text plus

Preset#: Preset number

2 Seek mode

Switches the seek mode in the following sequence; **AUTO1**, **AUTO2**, **MANUAL**.

- AUTO1**: Tunes in a station with good reception automatically.
- AUTO2**: Tunes in stations in memory one after another.
- MANUAL**: Switches to the next frequency manually.

3 Operation keys

- : Tunes in a station. The method of frequency switching can be changed (see 2 in table).
- : Displays the Graphic Equalizer screen. (P.80)

4 Preset list

- Recalls the memorized station or channel.
- When touched for 2 seconds, stores the current receiving station or channel in memory.
- Touch on the right side of the screen to display the Preset list. Touch again to close the list.

5 Function panel

Touch on the left side of the screen to display the function panel. Touch again to close the panel. For details on the keys, see **Function panel (P.37)**.

6 Band button

Switches the band (FM, AM).

7 Indicator Items

- ST**: A stereo broadcast is being received.
- MONO**: The forced monaural function is on.
- TI**: Indicates the reception state of traffic information.
 - White: TP is being received.
 - Orange: TP is not being received.

Function panel

1 Touch  on the left side of the screen.

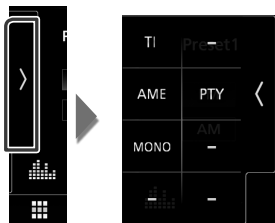

The functions of each key are as follows.

TI (FM only)

Sets the traffic information mode on. For details, see **Traffic Information (P.38)**.

AME

Presets stations automatically. For details, see **Auto memory (P.37)**.

PTY (FM only)

Searches a program by setting program type. For details, see **Search by program type (P.38)**.

MONO (FM only)

Select the Monaural reception.

Memory Operation

Auto memory

You can store stations with good reception in memory automatically.

1 Touch desired band key.

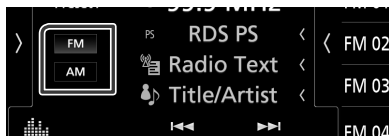

2 Touch  on the left side of the screen. Touch **AME**.

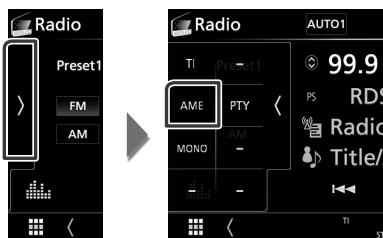

3 Touch **Yes**.

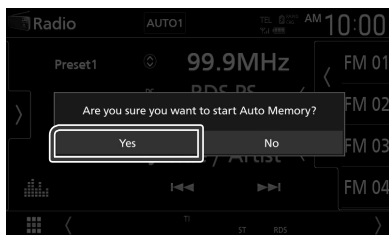

➤ Auto memory starts.

Manual memory

You can store the current receiving station or channel in memory.

1 Select a station or channel you wish to store in memory.

2 Touch **FM#** (#:1-15) or **AM#** (#:1-5) in which you want to store the station or channel for 2 seconds until a beep sounds.

Selecting Operation

Preset select

You can list and select memorized station or channel.

- 1 Touch  on the right side of the screen. Select a station or channel from the list.

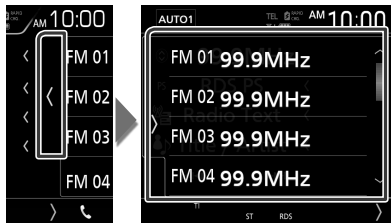

Search by program type (FM only)

You can tune to a station with a specific program type when listening to FM.

- 1 Touch  on the left side of the screen. Touch **PTY**.

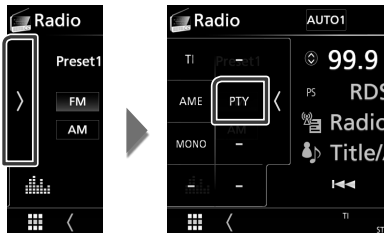

➤ TUNER PTY Mode screen appears.

- 2 Select a program type from the list.
- 3 Touch **Search**.

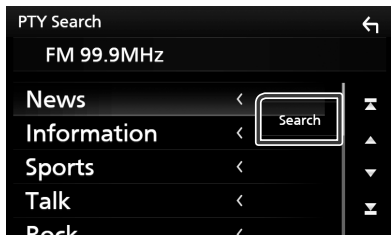

You can search a station of the selected program type.

Traffic Information (FM only)

You can listen and watch the traffic information automatically when a traffic bulletin starts. However, this feature requires a Radio Broadcast Data System that includes the TI information.

- 1 Touch  on the left side of the screen. Touch **TI**.

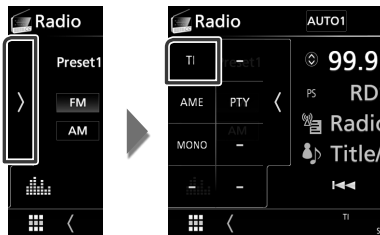

➤ Traffic information mode is set.

When the traffic bulletin starts

The Traffic Information screen appears automatically.

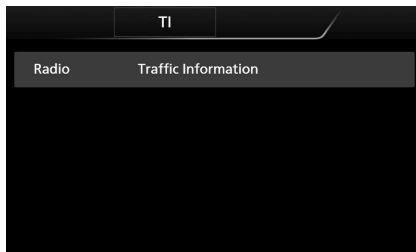

NOTE

- It is necessary to have Traffic Information function set to on in order to have the Traffic Information screen appear automatically.
- The volume setting during reception of traffic information is automatically stored. The next time the traffic information is received, this unit recalls the volume setting automatically.

HD Radio™ Tuner (DDX8905S)

HD Radio Tuner Basic Operation

Most functions can be controlled from the source control screen.

To enter HD Radio source, touch **HD Radio** icon in the source selection screen. (P.12)

NOTE

- Set the remote control mode switch to **AUD** mode before starting operation, see **Switch the operation mode (P.85)**.
- HD Radio broadcasting is for North American sales area only.
- The screen shot below is for tuner. It may be different from the one for HD Radio broadcasting.

Control screen



Preset list screen



1 Indicator display

While receiving an HD Radio station, it lights with orange when the audio is digital and lights with gray when it is analog. While receiving an analog station, it is off.

2 Information display

Displays the information of the current station: Frequency and Channel

Touching allows you to switch between Content A, Content B and Content C.

Content A: Station name, Song Title, Artist Name

Content B: Station Message, Radio Text

Content C: PTY Genre, Album Name

3 Seek mode

Switches the seek mode in the following sequence; **AUTO1**, **AUTO2**, **MANUAL**.

- **AUTO1**: Tunes in a station with good reception automatically.
- **AUTO2**: Tunes in stations in memory one after another.
- **MANUAL**: Switches to the next frequency manually.

4 Operation keys

- : Tunes in a station. The method of frequency switching can be changed (see 3 in table).
- **CH** **CH** : Selects a channel.
- : Display the Channel List screen. See **Channel search (P.42)**.
- : Display a list of registered bookmarks. See **Bookmark list (P.44)**.
- : Displays the Graphic Equalizer screen. (P.80)

5 Preset list

- Recalls the memorized station or channel.
- When touched for 2 seconds, stores the current receiving station or channel in memory.
- Touch on the right side of the screen to display the Preset list. Touch again to close the list.

6 Function panel

Touch on the left side of the screen to display the function panel. Touch again to close the panel. For details on the keys, see **Function panel (P.40)**.

7 Picture

The picture data or station Logo data is displayed if available from current content.

8 Band button

Switches the band (FM, AM).

9 Indicator Items

- **MC**: A multicast digital broadcast is being received.
- **ANALOG**: An analog broadcast is being received.
- **DIGITAL**: A digital broadcast is being received.
- **ST**: A stereo broadcast is being received.
- **EA**:
 - White: Emergency Alert is on.
 - No light: Emergency Alert is off.
 - Orange: Interrupting or in snooze/ignore state.

Function panel

1 Touch  on the left side of the screen.

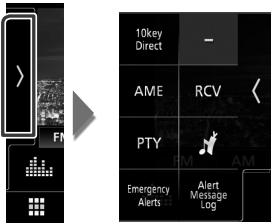

The functions of each key are as follows.

10key Direct

Display the direct station/ channel search screen. For details, see **Direct search (P.42)**.

AME

Presets stations automatically. For details, see **Auto memory (P.41)**.

RCV

Change the HD Radio reception mode. For details, see **Receive Mode (P.41)**.

PTY (FM only)

Searches a program by setting program type. For details, see **Search by program type (P.43)**.



Stores the information about the song being received. See **Bookmark (P.43)**.

Emergency Alerts

Turn on or off the alert message. See **Alert Message (P.45)**.

Alert Message Log

Displays the alert message received. See **Alert Message (P.45)**.

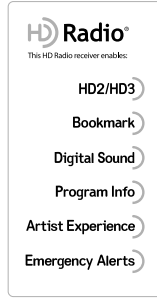

HD2/HD3

• Adjacent to traditional main stations are HD2/HD3 Channels, providing new original programming on the FM dial

Bookmark

• A music & product discovery feature that enables users to store information about content on the radio, and can deliver interactive information via QR codes

Digital Sound

• Crystal clear, CD-like digital audio quality to consumers; eliminates background noise

Program Info

• Provides song name, artist, station ID, and other relevant data to enrich the listening experience

Artist Experience

• Visual images, such as album art of over-the-air broadcasts from HD Radio stations

Emergency Alerts

• Delivers critical and life-saving messages to the public during emergency situations

Receive Mode

You can set the radio broadcasts receive mode.

- 1 Touch  on the left side of the screen. Touch **RCV**.

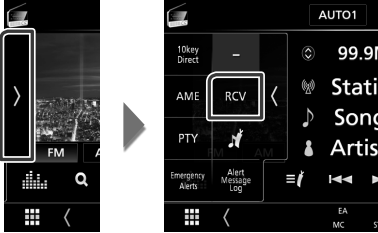

- 2 Select a receive mode.

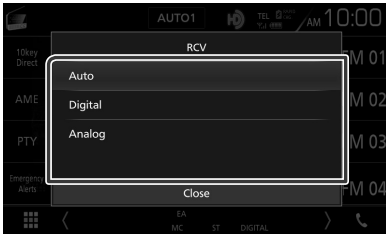

■ Auto

Switch between digital and analog audio automatically.

■ Digital

Select this to tune to digital audio only.

■ Analog

Select this to tune to analog audio only.

Memory Operation

Auto memory

You can store stations with good reception in memory automatically.

- 1 Touch desired band key.

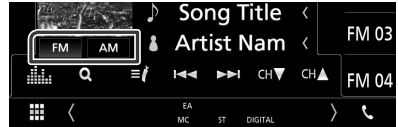

- 2 Touch  on the left side of the screen. Touch **AME**.

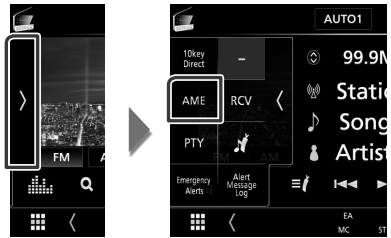

- 3 Touch **Yes**.

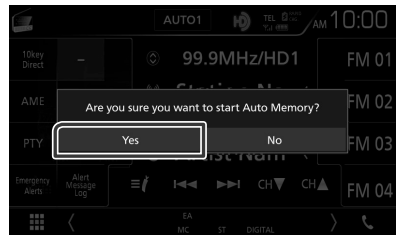

➤ Auto memory starts.

Manual memory

You can store the current receiving station or channel in memory.

- 1 Select a station or channel you wish to store in memory.
- 2 Touch **FM#** (#:1-15) or **AM#** (#:1-5) in which you want to store the station or channel for 2 seconds until a beep sounds.

Selecting Operation

Preset select

You can list and select memorized station or channel.

- 1 Touch **Q** on the right side of the screen. Select a station or channel from the list.

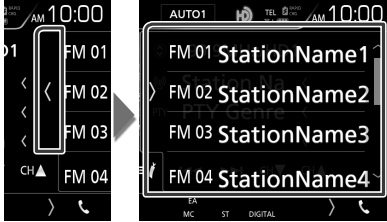

Direct search

You can tune in by entering the desired frequency or channel number.

- 1 Touch **Q** on the left side of the screen. Touch **10key Direct**.

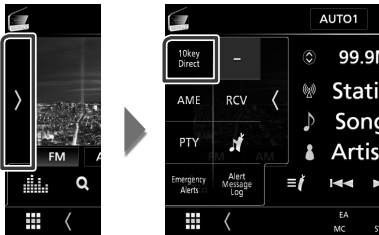

- 2 Select the search method.



- 3 Enter the frequency or channel number.

- 4 Touch **Enter**.

NOTE

- To clear the number you entered, touch **BS**.

Channel search

You can specify the desired channel.

- 1 Touch **Q**.

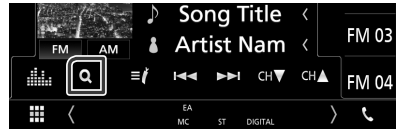

- 2 Select the desired content from the list.



NOTE

- Touch **Info Change**. Select a desired item. Song title, artist name, album name

Search by program type (FM only)

You can tune to a station with a specific program type when listening to FM.

- 1 Touch  on the left side of the screen. Touch **PTY**.

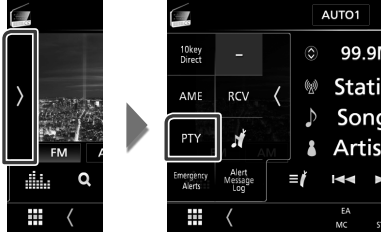

► TUNER PTY Mode screen appears.

- 2 Select a program type from the list.
- 3 Touch **Search**.

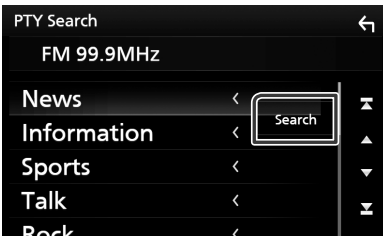



You can search a station of the selected program type.

Bookmark

Stores tag information (title, artist, album, URL, and description) about the song you are listening to now.

Detailed information and QR codes can be displayed according to the stored tag information.

Bookmark registration

- 1 Touch  on the left side of the screen. Touch .

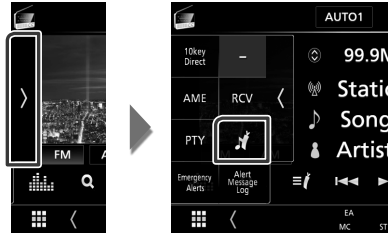

► Registers a bookmark.

NOTE

- Up to 100 bookmarks can be registered to this unit.

Bookmark list

Displaying a list of registered bookmarks and detailed information and QR code of the song.

1 Touch .

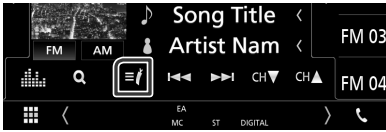

2 Select the desired bookmark from the list.

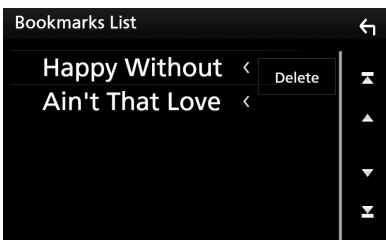

► The bookmark information appears.



Delete

Deletes the bookmarks being displayed.

Bookmark delete

Deleting a bookmark.

1 Touch **Delete**.



2 Select the bookmark to delete from the list.

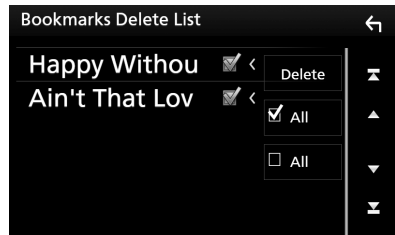

All

Select all bookmarks.

All

Erases all check marks.

3 Touch **Delete**.

► Confirmation message appears.

4 Touch **Yes**.

► Deletes all the selected bookmark(s).

Alert Message

This function is to receive alert messages. First, you need to turn on the "Emergency Alerts". (P.40)

When an Alert Message comes



Snooze

The alert message is erased. Same alert message cannot be displayed for next 10 minutes.

Ignore

The alert message is erased. Same alert message cannot be displayed for next 12 hours.

Allow Alert

Touch to tune to that channel of HD Radio source.

Display of the received Alert Message

You can read the received alert message afterward.

- 1 Touch  on the left side of the screen. Touch **Alert Message Log**.

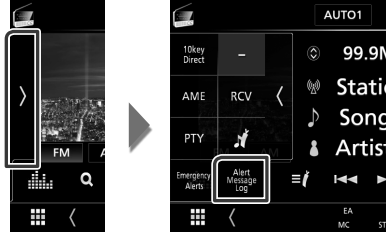

- 2 Select the desired Alert Message from the list.

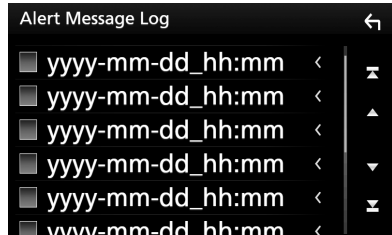

- > The Alert Message appears.



- 3 Touch **Close**.

SiriusXM®

SiriusXM® Basic Operation

Only SiriusXM® brings you more of what you love to listen to, all in one place. Get over 140 channels, including commercial-free music plus the best sports, news, talk, comedy and entertainment. Welcome to the world of satellite radio. A SiriusXM Vehicle Tuner and Subscription are required. For more information, visit www.siriusxm.com.

To enter SiriusXM source, touch **SiriusXM** icon in the source selection screen. (P.12)

Activating subscription

- Check your Radio ID.
The SiriusXM Satellite Radio ID is required for activation and can be found by tuning to Channel 0 as well as on the label found on the SiriusXM Connect tuner and its packaging.
The Radio ID does not include the letters I, O, S or F.
- Activate the SiriusXM Connect Vehicle Tuner using one of the two methods below:
 - For users in the U.S.A.
Online: Visit www.siriusxm.com/activatenow
Phone: Call SiriusXM Listener Care at 1-866-635-2349
 - For users in Canada:
Online: Visit <http://www.siriusxm.ca/help/activation-help/>
Phone: Call XM customer Care at 1-877-438-9677

NOTE

- Set the remote control mode switch to AUD mode before starting operation, see **Switch the operation mode (P.85)**.
- To use SiriusXM® Satellite Radio, the optional accessory is necessary.

Control screen



Preset list screen

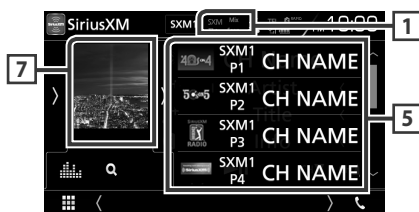

1 Indicator display

Displays the “Mix” (TuneMix™), “Scan” (TuneScan™), (Traffic&Weather), (SportsFlash™) indicator and the received signal strength of the SiriusXM tuner.

2 Information display

Displays the information of the current channel:
Channel Name

P#: Preset number

#CH: Channel display

Logo: Channel logo

Touching allows you to switch between Content A, Content B and Content C.

Content A: Artist Name, Song Title

Content B: Content Info, Category Name

Content C: Channel Description, Similar Channels

: Touch for 2 seconds to register the artist of the current song as a Content Alert.

: Touch for 2 seconds to register the current song as a Content Alert.

For details, see **Content Alerts (P.51)**.

3 Band button

Switches the band. (SXM1/ SXM2/ SXM3/ SXM4)

4 Operation keys

- **Q** : Display the Category search screen. For details on search operation, see **Category/Channel search (P.49)**.
- **▶||** : Plays or pauses. See **Replay (P.49)**.
- **CH▼ CH▲** : Selects a channel.
- **📊** : Displays the Graphic Equalizer screen. **(P.80)**

5 Preset list

- Recalls the memorized channel.
- When touched for 2 seconds, stores the current receiving channel in memory.
- Touch on the right side of the screen to display the Preset list. Touch again to close the list.

6 Function panel

Touch on the left side of the screen to display the function panel. Touch again to close the panel. For details on the keys, see **Function panel (P.47)**.

7 Artwork

Display album artwork for most SiriusXM music channels

Function panel

- 1 Touch **☰** on the left side of the screen.

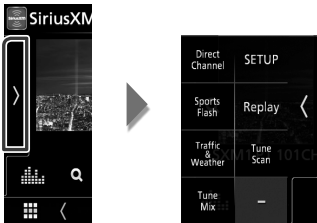

The functions of each key are as follows.

Direct Channel

Touch and enter the desired number. For details, see **Direct search (P.48)**.

SETUP

Touch to display the SiriusXM SETUP screen. For details, see **SiriusXM Setup (P.52)**.

Replay / Live

Turns the replay mode on or off. See **Replay (P.49)**.

Traffic & Weather

For SXV300 *¹

Traffic & Weather Now™ allows you to access the latest report whenever you want to hear it. Select your city at the set up menu **Select a City for Traffic & Weather (P.57)** and press the **Traffic & Weather** button to check the latest report. It will start from the beginning.

- **☰** (White) : Played already.
- **☰** (Green) : New information arrived.
- **☰** (Purple) : Playing.
- **☰** (Gray) : No information.

For SXV200 or SXV100 *²

Turns the Traffic & Weather Jump function on or off.

- **☰** (White) : Function on.
- **☰** (Purple) : Playing.
- **☰** (Gray) : Function off.

TuneScan *³

Hear a few seconds of the songs from each of the SmartFavorite music channels on the current preset band. See **TuneScan™ (P.50)**.

TuneMix *⁴

When you turn it ON, the preset channels on P1-P6 are shuffled to provide a playback which is a blend of songs from your favorite channels. See **TuneMix™ (P.50)**.

SportsFlash *⁴

Displays during SportsFlash™. To cancel the SportsFlash interruption and return to the previous channel, touch it. See **SportsFlash™ (P.52)** and **SportsFlash™ setup (P.56)**.

*¹ Compatible with SXV300 or later tuner models. It may take a few minutes after power on to get the first full report for your city. Traffic channels are not available in Canada.

*² When SXV200 or SXV100 is connected with this unit.

*³ Compatible with SXV200 or later tuner models.

*⁴ Compatible with SXV300 or later tuner models.

Storing Channels in Preset Memory

You can store the current channel in memory.

- 1 Tune to a channel you wish to store in memory.
- 2 Touch  on the right side of the screen.

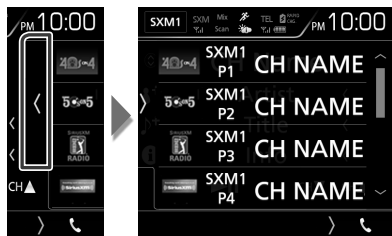

- 3 Touch and hold for 2 seconds (until you hear a beep) the preset number **SXM(1-4) P(1-6)** in which you want to store the channel.

Preset select

You can list and select memorized station or channel.

To select from the preset list

- 1 Touch  on the right side of the screen. Select a channel from the list.

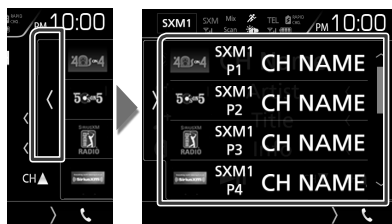

Direct search

You can tune to a channel directly.

- 1 Touch  on the left side of the screen. Touch **Direct Channel**.

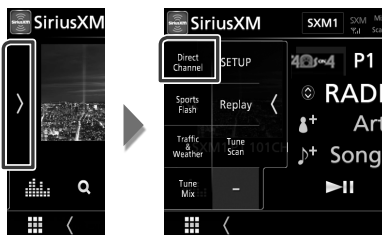

- 2 Enter the channel number and touch **Enter**.



NOTE

- To clear the number you entered, touch **BS**.

Category/Channel search

You can specify the desired category and select a channel.

1 Touch **Q**.

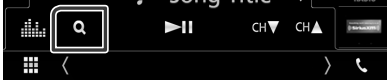

2 Select a category.



► Channel list appears.

3 Select the desired content from the list.



NOTE

- All the channels in the selected category appear.
- Touching **All-Channels** displays all the channels.
- Touch **Info Change** in the channel list. Select a desired item.
Content info, Channel name, artist name, song title, category name
- Categories which have the prefix "Featured -" are Featured Favorites.
- Featured Favorites are groups of channels that are created by the SiriusXM Programming department allowing you to discover new channels. Featured Favorite channels are dynamic and can change often, allowing you to discover new channels.
 - You can set whether to be notified when the featured seasonal theme is updated. **(P.57)**

Replay

You can replay the last 60 minutes of the current channel.

1 Touch **▶II** or **Replay** on the function panel.



Press to skip to the previous/next track.
Press and hold to rewind or fast forward.



Plays or pauses.

■ **Replay time bar/ Play mode indicator**

Display recorded capacity and playback position.

▶, ▶▶, etc.: Current play mode indicator



Display a list of recorded data on a program basis.

2 Touch **Q** to display an Instant Replay list.

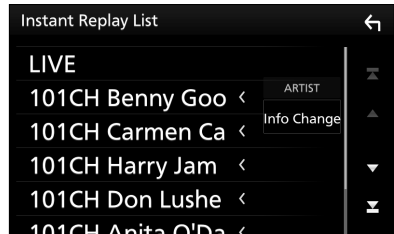

■ **Instant Replay List**

Touching this plays back the displayed program.

LIVE: To return to live

■ **Info Change**

Touch **Info Change**. Select a desired item.
Content info, channel name, artist name, song title, category name

To return to live music/content

- 1 Touch **>** on the left side of the screen.
- 2 Touch **Live**.

TuneMix™

TuneMix™ plays a unique blend of songs from your Preset music channels from the current SiriusXM Preset Band, allowing you to build a custom channel from as few as two to as many as 6 music channels. You can even skip songs you don't want to hear.

- 1 Touch **>** on the left side of the screen. Touch **TuneMix** to set ON or OFF.

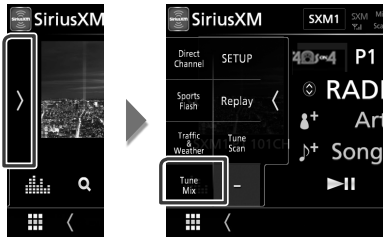

NOTE

- Compatible with SXV300 or later tuner models.

SmartFavorites, TuneStart™

Preset channels 1 through 6 of the current band are SmartFavorites channels.

The SiriusXM Vehicle Tuner automatically buffers the broadcast audio content of the SmartFavorites channels in the background.

You can rewind and replay up to 30 minutes of any of the missed news, talk, sports or music content when you tune to a SmartFavorites channel. (see **Replay (P.49)**)

When tuning from a SmartFavorites channel, songs will play from the beginning of each track (TuneStart™). You can enable/disable TuneStart. (see **TuneStart™ (P.57)**)

NOTE

- Compatible with SXV200 or later tuner models.

TuneScan™

TuneScan™ is a feature that plays samples from the starts of multiple buffered songs from each of the SmartFavorites channels that predominantly play music selections.

You have easy access to a large sampling of music content and can enjoy hearing a full song when stopping the scan on a song of interest.

- 1 Touch **>** on the left side of the screen.



- 2 Touch **TuneScan** to begin scanning your SmartFavorites channels. You will hear a few seconds of the songs from each of the SmartFavorite channels.

- 3 Touch **TuneScan** again while your favorite song is being played to start listening to that song.



- Scan finishes and continues playing the song.

NOTE

- To cancel TuneScan™, Touch on the left side of the screen. Touch **TuneScan**.
- Touch and hold **TuneScan** to cancel TuneScan, the channel before starting TuneScan will be played.
- Compatible with SXV200 or later tuner models.

Traffic & Weather Now™

Traffic & Weather Now™ allows you to access the latest report whenever you want to hear it. Select your city at the set up menu **Select a City for Traffic & Weather (P.57)**.



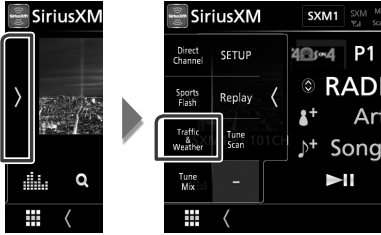

- 1 Touch  on the left side of the screen.



- 2 Touch **Traffic & Weather**.

The report starts from the beginning. To stop and return to the previous channel, touch it again.

Indicator display

-  (White) : Played already.
-  (Green) : New information arrived.
-  (Purple) : Playing.
-  (Gray) : No information.

NOTE

- Compatible with SXV300 or later tuner models.

Content Alerts

When a broadcast program related to the registered artist, song or team starts, an Alert Content List screen appears to allow you to switch the current channel to the relevant channel.

- 1 When the broadcast of the registered content starts, an Alert Content List screen appears.

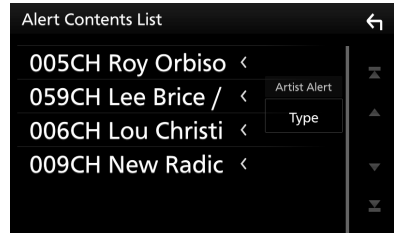

- 2 Select a content from the list.

NOTE

- Touch **Info Change**. Select a desired item. Artist Alert, Song Alert, GameAlert™
- To learn how to register artists and songs for the Content Alert function, see 2. Information display of **SiriusXM® Basic Operation (P.46)**.
- To learn how to set up the Content Alerts function and select Teams for alerts, see **Content Alerts setup (P.54)**.

SportsFlash™

SportsFlash™ will notify you when a big play happens during a game with one of your favorite sports teams. Choose to tune in and hear the play unfold like it was live. Continue listening to the game, or you can return to your previous channel.

- 1 When a big play happens during one of the games, an Alert screen appears.

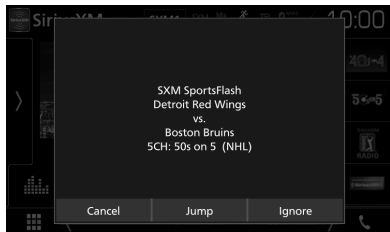

■ Jump

Touch to tune to that channel and play back the big play.

■ Ignore

Touch to cancel this specific Sports Flash Alert. Touching **Ignore** will ignore this specific alert but will allow future alerts for this game.

■ Cancel

Touch to cancel the SportsFlash alert. No alerts from this game will be displayed afterward.

NOTE

- Compatible with SXV300 or later tuner models.
- To learn how to set up the SportsFlash alert function, see **SportsFlash™ setup (P.56)**.

SiriusXM Setup

- 1 Touch **>** on the left side of the screen. Touch **SETUP**.

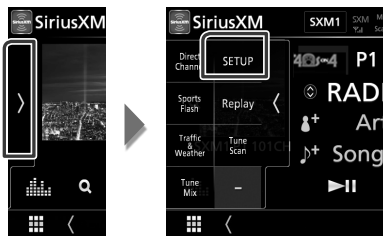

- SiriusXM SETUP screen appears.

See the following sections for each setting.

- Set up the parental code (**P.53**)
- Set up the Parental Control (**P.53**)
- Set up the skip channel select (**P.54**)
- Set up the Content Alerts (**P.54**)
- Set up the teams for SportsFlash™ (**P.56**)
- Select the city for Traffic & Weather Jump or Traffic & Weather Now™ (**P.57**)
- Select the Featured Bands Update Messages (**P.57**)
- Set up the TuneStart™ (**P.57**)
- Reset to the default settings (**P.57**)

Parental code

You can set a SiriusXM parental code for Parental Control.

- 1 Touch **Parental Code** in the SiriusXM SETUP screen.

➤ Parental Pass Check screen appears.

NOTE

- The code number is set to "0000" as default.

- 2 Enter the current code number and touch **Enter**.

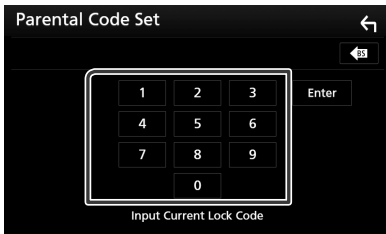

➤ Parental Pass 1st entering screen appears.

- 3 Enter the new code number and touch **Enter**.

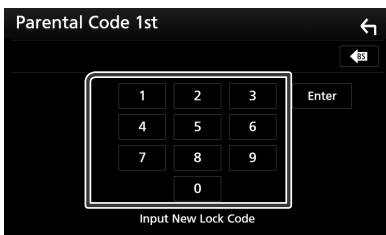

➤ Parental Pass 2nd entering screen appears.

- 4 Enter the same code number as you input in step 3 and touch **Enter**.

➤ The code number is confirmed and SiriusXM parental code is now set.

Parental Control

Parental Control is a feature that provides the user with the ability to prevent unauthorized access to mature content and user selected channels.

- 1 Touch **Parental Control** in the SiriusXM SETUP screen.

- 2 Touch **Mature, User or OFF**.

■ OFF

Deactivates the parental mature and user locks.

■ Mature

Locks channels classified as "mature" only.

■ User

Locks only the selected channels.

- 3 Enter the parental code you originally input in **Parental code (P.53)** and touch **Enter**.

When selecting User

This allows you to limit access to any SiriusXM channel (Parental Lock Channel).

- 1 Touch **Parental Lock Channel Selection** in the SiriusXM SETUP screen.

➤ Parental Pass Check screen appears.

NOTE

- You need to set up a **Parental code (P.53)** beforehand.

- 2 Enter the parental code you originally input in **Parental code (P.53)** and touch **Enter**.

➤ Parental Lock Category Select screen appears.

- 3 Touch the desired category from the list.



➤ Displays all the channels in the selected category.

NOTE

- Touch **All-Channels** to display all the channels.
- To delete the parental lock channel setting, touch **Disable All** and then touch **YES** on the confirmation screen.

4 Touch each channel on the list and set to ON or OFF.

ON: If you wish to set the lock.

OFF: If you wish to unlock the channel.

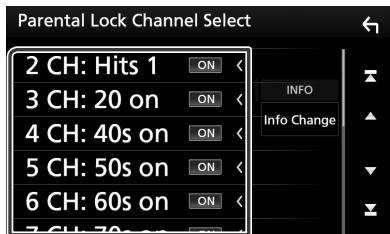

NOTE

- Touch **Info Change**. Select a desired item. Content information, Channel name, Artist name, Song title, Category name.

Skip channel select

You can set the undesired channels to skip.

1 Touch Skip Channel Select.

- Skip Category Select screen appears.

2 Touch the desired category from the list.



- Displays all the channels in the selected category.

3 Touch each channel on the list and set to ON or OFF.

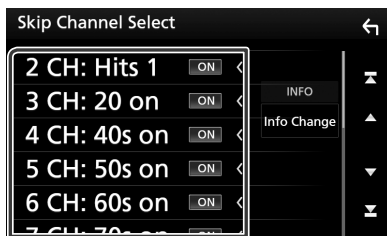

NOTE

- To delete the skip channel setting, touch **Disable All** and then touch **YES** on the confirmation screen.
- Touch **Info Change**. Select a desired item. Content information, Channel name, Artist name, Song title, Category name.
- You can also select channels with Direct Channel and Preset Memory functions.

Content Alerts setup

Activating content alert

1 Touch Content Alerts in the SiriusXM SETUP screen.

- The Content Alerts is turned on or off. Default is "ON".

Selecting the content for the content alert

1 Touch Content Alerts Contents Set in the SiriusXM SETUP screen.

2 Select the content you want to set up.

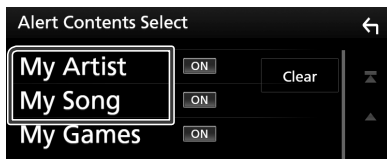

NOTE

- To set all the content Alerts off, touch **Clear** and then touch **YES** on the confirmation screen.
- Select **OFF** for the content you want to deactivate the content alert for.

- 3 Touch each content list item you want to set check or uncheck.



NOTE

• You can select for up to 60 Artists or Songs.

- **To delete the Artist and Song**

- 1 Touch **Delete**.

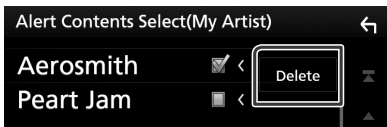

- 2 Touch the content name to check.



■ **All**

Select all content.

■ **All**

Erases all check marks.

- 3 Touch **Delete** and then touch **YES** on the confirmation screen.

To select a Team

Get alerted when your favorite sports team is playing on another SiriusXM channel with GameAlert™

- 1 Touch **My Games**.



- 2 Touch the desired league from the list.

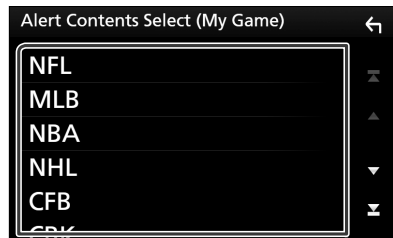

- 3 Touch each team in the list you want to set check or uncheck.

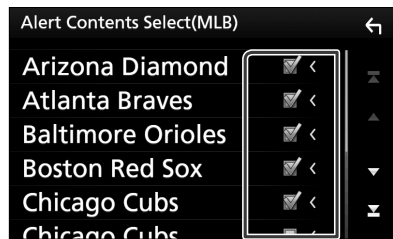

NOTE

• You can select for up to 30 Teams.

SportsFlash™ setup

Activating SportsFlash

- 1 Touch **SportsFlash** in the SiriusXM SETUP screen.
 - The SportsFlash is turned on or off. Default is "ON".

Selecting SportsFlash Beep

- 1 Touch **SportsFlash Beep** in the SiriusXM SETUP screen.
 - The SportsFlash Beep is turned on or off. Default is "ON".

Selecting the teams for SportsFlash

- 1 Touch **SportsFlash Team Set** in the SiriusXM SETUP screen.
 - Team Set screen appears.
- 2 Touch **Edit**.

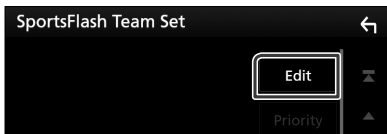

- 3 Touch the desired league from the list.

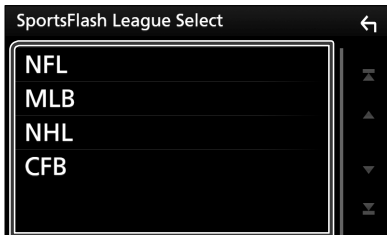

- 4 Touch each team in the list you want to set ON or OFF.

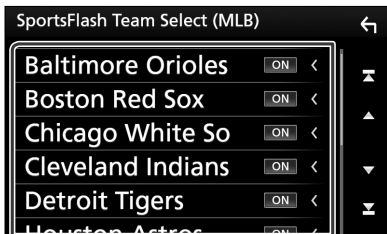

- 5 Touch  twice.

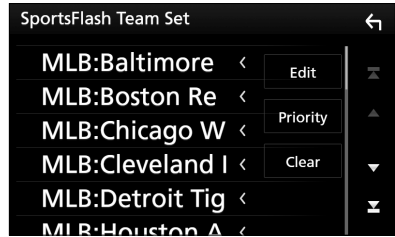

■ Edit

Sets and removes teams.

■ Priority

Sets the priority of a team to be posted.

■ Clear

Removes all teams that have been set.

Touch **Clear**. When the confirmation screen appears, touch **YES**.

NOTE

- SportsFlash™ is available on SXV300 or later tuner models.
- Up to 50 teams can be added.

Set the SportsFlash™ Team Priority

- 1 Touch **Priority**.



- 2 Set the priority of a team.

Each time you touch a Team, the priority is set and reset.



3 Touch **Done**.



NOTE

- Priority can be set on up to 5 teams.
- When priority has already been set for 5 teams, it cannot be set for any other team. Delete an unnecessary team.

Select a City for Traffic & Weather

You can select a city for which you wish to receive SiriusXM Traffic & Weather broadcasts and hear them from the beginning.

- 1 Touch **Traffic & Weather City Select** in the SiriusXM SETUP screen.
- 2 Touch ◀ and ▶ to select a city.

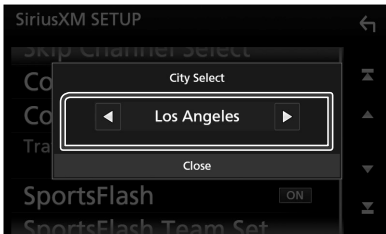

Selecting Featured Bands Update Messages

You can set whether to be notified when the featured seasonal theme is updated.

- 1 Touch **Featured Bands Update Messages** in the SiriusXM SETUP screen.
The Featured Bands Update Messages is turned on or off.
Default is "ON".

TuneStart™

- 1 Touch **Tune Start** in the SiriusXM SETUP screen.
The TuneStart is turned on or off.
Default is "ON".

Reset

- 1 Touch **SiriusXM Reset** in the SiriusXM SETUP screen.
▶ Confirmation screen appears.
- 2 Touch **YES**.
▶ All SiriusXM settings return to default.

Bluetooth Control

Using the Bluetooth function, various functions can be used: listening to the audio file, making/receiving a call.

Information for using Bluetooth® devices



Bluetooth is a short-range wireless radio communication technology for mobile devices such as mobile phones, portable PCs, and other devices.

Bluetooth devices can be connected without cables and communicate with each other.

NOTE

- While driving, do not perform complicated operations such as dialing numbers, using the phone book, etc. When you perform these operations, stop your car in a safe place.
- Some Bluetooth devices may not connect to this unit depending on the Bluetooth version of the device.
- This unit may not work for some Bluetooth devices.
- Connecting conditions may vary depending on your environment.
- For some Bluetooth devices, the device is disconnected when the unit is turned off.

About the cell-phone and Bluetooth audio player

This unit conforms to the following Bluetooth specifications:

Version

Bluetooth Ver. 3.0

Profile

Cell-phone:

HFP (V1.6) (Hands Free Profile)

SPP (Serial Port Profile)

PBAP (Phonebook Access Profile)

Audio player:

A2DP (Advanced Audio Distribution Profile)

AVRCP (V1.5) (Audio/Video Remote Control Profile)

Sound codec

SBC, AAC

NOTE

- The units supporting the Bluetooth function have been certified for conformity with the Bluetooth Standard following the procedure prescribed by Bluetooth SIG.
- However, it may be impossible for such units to communicate with your cell-phone depending on its type.

Register the Bluetooth device

It is necessary to register the Bluetooth audio player or cell-phone to this unit before using the Bluetooth function.

You can register up to 10 Bluetooth devices.

NOTE

- Up to 10 Bluetooth devices can be registered. If an attempt is made to register the 11th Bluetooth device, the Bluetooth device connected on the earliest date will be deleted to register the 11th one.
- This unit is compatible with the Apple Easy Pairing function. When an iPod touch or iPhone is connected to this unit, an authentication dialog appears. Performing operation for authentication on this unit or iOS smartphone registers the smartphone as a Bluetooth device.

Follow the step 1, 2 and 3 for registration.

Step 1: Registration the Bluetooth device

- 1 Search the unit ("DDX****") from your smartphone/cell-phone.
- 2 Input the PIN Code in your smartphone/cell-phone.
PIN Code is set to "0000" as the default.

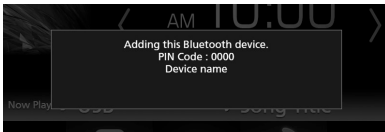

● SSP (Secure Simple Pairing of Bluetooth 2.1 or later)

- 1 Search the unit ("DDX****") from your smartphone/cell-phone.
- 2 Confirm the request both on the smartphone/cell-phone and the unit.



Step 2: Connection settings

- When the HFP profile is supported, Hands Free 1 or 2 is automatically selected for connection, proceeding to the next step.
 - When the A2DP or SPP profile is supported, the cell-phone or audio player is automatically connected, proceeding to the next step.
- If cell-phones and/or audio players have already been connected, a selection screen appears.

1 Select the hands-free number to connect.

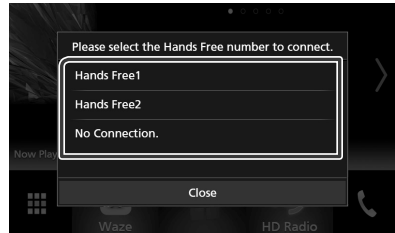

2 Select if you want to use the audio player app in your smartphone over A2DP, and the other apps in your smartphone over SPP.

This message appears if the device supports BT audio (A2DP) or smartphone link (SPP).

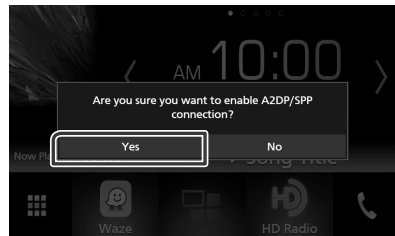

Step 3: Phonebook transfer

1 Select if you want to transfer your phonebook data.

This message appears if the device supports PBAP.

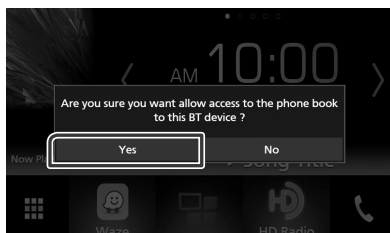

The phonebook data transmission starts. Some smartphones may request permission to access the data. The data transmission will start with your permission.



When the data transmission and connection have completed, the Bluetooth connection icon appears on the screen.

Bluetooth Setup

1 DDX8905S/ DMX7705S

Press the **MENU** button.

DDX6905S/ DDX6705S

Press the **≡** button.

➤ Popup menu appears.

2 Touch **SETUP**.



➤ SETUP Menu screen appears.

3 Touch **Bluetooth**.

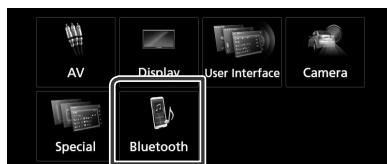

➤ Bluetooth SETUP screen appears.

See the following section for each setting.

- Connect the Bluetooth device (**P.61**)
- Change the PIN Code (**P.62**)
- Change the device name (**P.62**)

Connect the Bluetooth device

- 1 Touch **Select Device** in the Bluetooth SETUP screen.

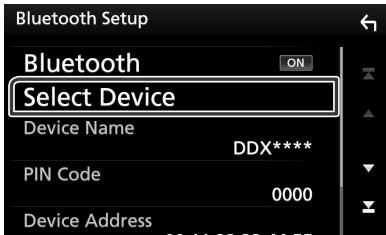

- 2 Touch the device name you want to connect.



➤ Profile select screen appears.

NOTE

- If the icon is lighted, it means that the unit will use that device.

- 3 Set each profile as follows.

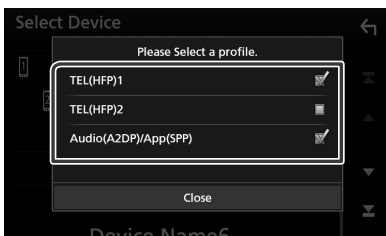

■ TEL (HFP) 1, TEL (HFP) 2

The device is connected with the unit as hands-free phone 1 or 2.

■ Audio (A2DP)/App (SPP)

Set to interwork with an application installed in a smartphone or to use as an audio player.

- 4 Touch **Close**.

To delete the registered Bluetooth device

- 1 Touch **Delete**.

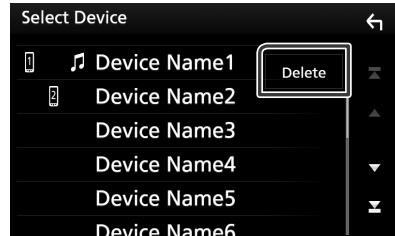

- 2 Touch the device name to check.

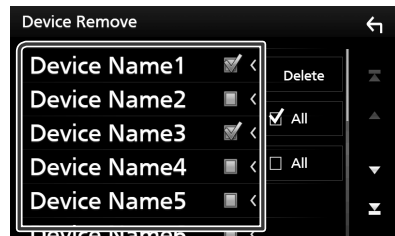

■ All

Select all Bluetooth device.

■ All

Erases all check marks.

- 3 Touch **Delete**.

➤ Confirmation message appears.

- 4 Touch **Yes**.

Change the PIN Code

- 1 Touch **PIN Code** in the Bluetooth SETUP screen.
 ▶ PIN Code Set screen appears.
- 2 Touch and hold .
- 3 Input the PIN Code.

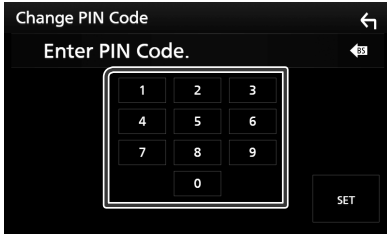

- 4 Touch **SET**.

Change the device name

- 1 Touch **Device Name** in the Bluetooth SETUP screen.
 ▶ Change Device Name screen appears.
- 2 Touch and hold .
- 3 Input the device name.



- 4 Touch **Enter**.

Playing Bluetooth Audio Device

Most function can be controlled from the source control screen.







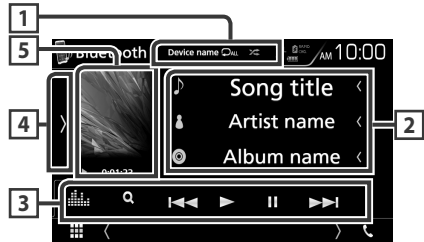

To enter Bluetooth source, touch **Bluetooth** icon in the source selection screen. (P.12)

Bluetooth basic operation

Control screen









1 Device name/ / /

- Connected device name.
-  : Repeats the current track/folder. Each time you touch the key, repeat mode switches in the following sequence; File repeat (), Folder repeat (), All songs repeat (), Repeat off ()
-  : Randomly plays all tracks in current folder. Each time you touch the key, random mode switches in the following sequence; Folder random (), All random (), Random off ()

2 Information display *

Displays the name of the track information.

3 Operation keys*

-  : Searches file. See **File search (P.63)**.
-    : Searches the previous/next content. Touch and hold to fast forward or fast backward. (It will be cancelled automatically after about 50 seconds.)
-  : Plays.
-  : Pauses.
-  : Displays the Graphic Equalizer screen. (P.80)

4 Function panel

Touch on the left side of the screen to display the function panel. Touch again to close the panel.

- **BT DEVICE CHANGE** : Selects the device to connect via Bluetooth audio (A2DP) or APP (SPP). See **Connect the Bluetooth audio (P.63)**.

5 Play mode indicator/ Playing time

▶, ||: Current play mode indicator

The meanings of each icon are as follows;

▶ (play), ▶▶ (fast forward), ◀◀ (fast backward), || (pause), ■ (stop).

*These items appear only when the audio player which supports AVRCP profile is connected.

NOTE

- The operation buttons, indications and information displayed on the screen differ depending on the connected device.
- If the operation keys do not appear, operate from the player.
- Depending on your cell-phone or audio player, audio may be heard and controlled but text information may not appear.
- If the volume is too low, raise it on your cell-phone or audio player.

Connect the Bluetooth audio

Selects the device to connect via Bluetooth audio (A2DP) or APP (SPP).

- 1 Touch  on the left side of the screen. Touch **BT DEVICE CHANGE**.

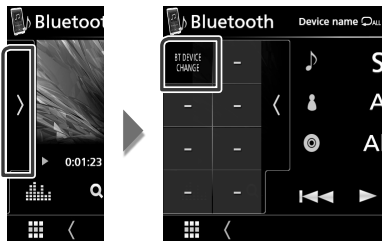

- 2 Touch the device name you want to connect.

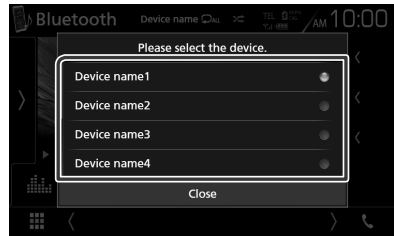

- 3 Touch **Close**.

File search

- 1 Touch .
- 2 Touch the desired file or folder.

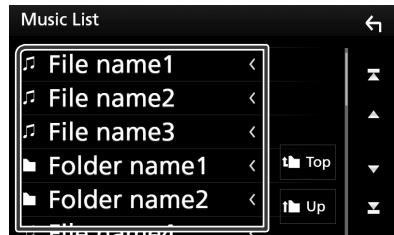

When you touch a folder its contents are displayed.

- 3 Touch desired item from the content list.
 - ▶ Playback starts.

NOTE

- For operations in the list screen, see **List screen (P.15)**.

Using Hands-Free Unit

You can use telephone function by connecting the Bluetooth telephone to this unit.

NOTE

- While Apple CarPlay or Android Auto is being connected, Bluetooth Hands-Free function and two Bluetooth devices connections cannot be used. Only Apple CarPlay or Android Auto Hands-Free function can be used.

Make a call

1 Touch .

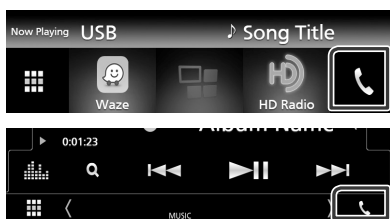





➤ Hands Free screen appears.

NOTE

- If your mobile phone supports PBAP, you can display the phone book and call lists on the touch panel screen when the mobile phone is connected.
 - Phone book: up to 1000 entries
 - Up to 50 entries including dialed calls, received calls, and missed calls

2 Select a dialing method.



- : Call using call records
- : Call using the phonebook
- : Call using the preset number
- : Call by entering a phone number
- : Voice Recognition (P.65)

● Select the cell-phone to use

When you connect two cell-phones

- 1) Touch   to select the phone you want to use.

● Bluetooth SETUP

- 1) Touch .
Bluetooth SETUP screen appears.

NOTE

- The status icons such as battery and antenna displayed may differ from those displayed on the cell-phone.
- Setting the cell-phone in the private mode can disable the hands-free function.

Call using call records

1 Touch .

2 Select the phone number from the list.



Call by entering a phone number

1 Touch .

2 Enter a phone number with number keys.





3 Touch .

Call using the preset number

- 1 Touch .
- 2 Touch the Name or phone number.



Call using the phonebook

- 1 Touch .
- 2 Touch .
- 3 Select the initial.



- Characters with no corresponding name will not appear.
- A first character with an accent character such as "ü" can be searched for with a non-accent character "u". A character with an accent character in a sentence cannot be searched.

- 4 Select the person you want to call from the list.



- 5 Select the phone number from the list.

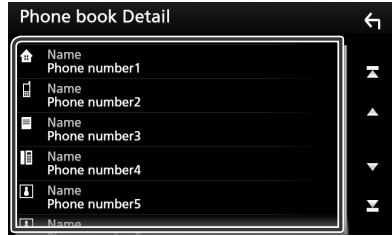

NOTE

- You can set the list to arrange in the order of last name or first name. For details, see **Hands-Free Setup (P.68)**.

 **Voice Recognition**

You can access the voice recognition function of the cell-phone connected to this unit. You can search the cell-phone phonebook by voice. (The functionality depends on the cell-phone.)

- 1 Press the  button for 1 second.
DDX8905S/ DMX7705S



DDX6905S/ DDX6705S

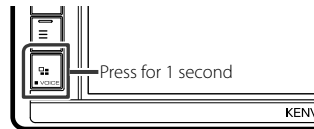



- Voice Recognition screen appears.

- 2 Start speaking.

NOTE

- You can use voice recognition function by touching  on the Hands Free screen.

Receive a call

- 1 Touch  to answer a phone call or  to reject an incoming call.



NOTE

- While monitoring the view camera, this screen does not appear even if a call comes in.

To end call

- 1 While talking, touch .

Operations during a call



Adjust the volume of your voice

- 1) Touch **Speech Quality**.
- 2) Touch ◀ or ▶ of **Microphone Level**.

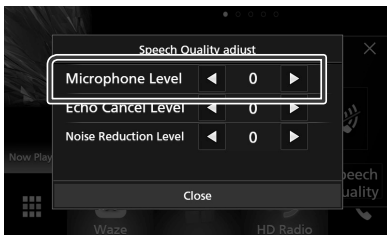

Adjust the receiver volume

Press the - or + button.
DDX8905S/ DMX7705S

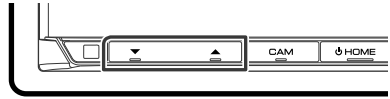

DDX6905S/ DDX6705S

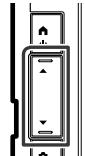



Mute your voice

Touch  to mute or not to mute your voice.

Output the dial tone



Touch **DTMF** to display the tone input screen. You can send tones by touching desired keys on the screen.

Switching the speaking voice output

Touching  /  each time switches the speaking voice output between cell-phone and speaker.

Call-waiting

When you receive a call while talking on another call, you can answer the newly received call by touching . The current call is on hold.

Each time you touch , the caller will change. When you touch , the current call will end and switch to the call in hold.

To close the Hands-Free popup screen

Touching ✕ closes the Hands-Free popup screen. To display it again, touch .

Phone number preset

You can register frequently used phone numbers to this unit.

- 1 Touch .
- 2 Touch **Edit**.



- 3 Select where to preset.

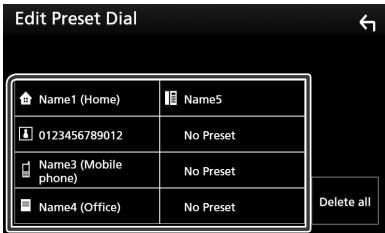

Delete all

To delete all preset numbers, touch **Delete all** and then touch **OK** on the confirmation screen.

- 4 Select how to preset.

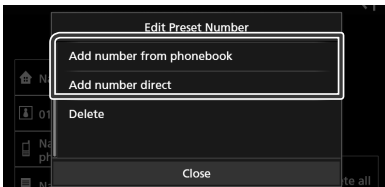

Add number from phonebook

Select the number to preset by referring to "Call using the phonebook". See **Call using the phonebook (P.65)**.

Add number direct

Enter the telephone number directly and touch **SET**. See **Call by entering a phone number (P.64)**.

Delete

To delete the preset number, touch **Delete** and then touch **OK** on the confirmation screen.

Phonebook transfer

You can transfer the phonebook in your Bluetooth smartphone via PBAP.

- 1 Touch .
- 2 Touch .



➤ The phonebook data transmission starts.

Phonebook deletion

- 1 Touch .
- 2 Touch the name to check.

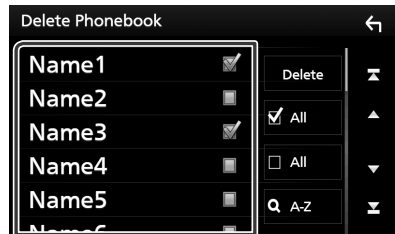

All

Checks all boxes.

All

Erases all check marks.

- 3 Touch **Delete**.
 - Confirmation message appears.
- 4 Touch **OK**.

Hands-Free Setup

You can perform various setup about handsfree function.

1 DDX8905S/ DMX7705S

Press the **MENU** button.

DDX6905S/ DDX6705S

Press the **≡** button.

▶ Popup menu appears.

2 Touch **SETUP**.



▶ SETUP Menu screen appears.

3 Touch **Bluetooth**.



▶ Bluetooth SETUP screen appears.

4 Touch **TEL SETUP**.

▶ TEL SETUP screen appears.

5 Set each item as follows.

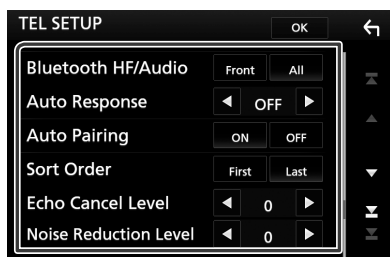

■ **Bluetooth HF/Audio**

Select the speakers to output the sound from cell-phone (such as phone call voice and ringing tone) and Bluetooth audio player.

Front: Outputs from the front speakers.

All (Default): Outputs from all speakers.

■ **Auto Response***

Sets an automatic response time to pick-up an incoming call.

OFF (Default): Automatic response is not available.

1 / 5 / 10 / 15 / 20 / 25 / 30: Set calling ring time (second).

■ **Auto Pairing**

When set to "ON", the Apple Auto Pairing function is turned on to automatically register the iPod touch or iPhone connected to this unit.

ON (Default): Uses Apple Auto Pairing function.

OFF: Not uses Apple Auto Pairing function.

■ **Sort Order**

Sets how to arrange the cell-phone phonebook.

First: Arranges in the order of first name.

Last (Default): Arranges in the order of last name.

■ **Echo Cancel Level**

Adjusts the level of echo cancellation.

Default is "0".

■ **Noise Reduction Level**

Reduces the noises generated by surrounding environment without changing the microphone volume. Use this setting when the voice of caller is not clear. Default is "0".

* Either the time interval for automatic answer set on this unit or the time interval set on the cell-phone, whichever is shorter takes effect.

6 Touch **OK**.

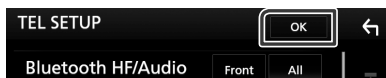

Other External Components

View Camera

NOTE

- To connect a camera, see **P.94**.
- To use a rear view camera, a REVERSE lead connection is required. (**P.93**)
- The view of the front view camera or dashboard camera varies depending on the setting of **Dashboard Camera /Front Camera**.
- If **Rear Camera Interruption** is set to on, the camera screen is displayed when you shift the gear to the reverse (R) position.

Display the camera screen

1 DDX8905S/ DMX7705S

Press the **CAM** button.

DDX6905S/ DDX6705S

Press the  button.

➤ View camera screen appears.

2 Adjust each item as follows.

To erase the caution message, touch the screen.

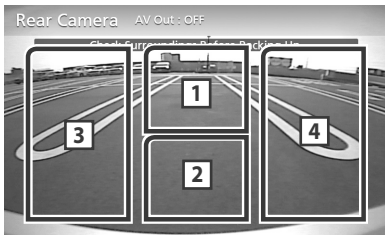

1 Switching the View Camera

Touch to change the front view camera or dashboard camera and rear view camera.

2 Camera off

Touch to exit the camera screen.

3 Switching the Guideline *1

Touching each time turns on or off the guideline.

4 Switching the Angle *1

Touch to change the camera angles.

*1 Available when **Dashboard Camera / Front Camera, Front Camera Type, Rear Camera** is set to **CMOS 3-Series Camera**.

Camera Setup

1 DDX8905S/ DMX7705S

Press the **MENU** button.

DDX6905S/ DDX6705S

Press the  button.

➤ Popup menu appears.

2 Touch **SETUP**.

➤ SETUP Menu screen appears.

3 Touch **Camera**.

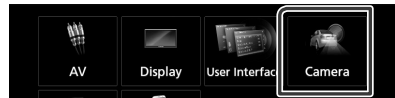

➤ Camera screen appears.

4 Set each item as follows.

■ **Rear Camera**

CMOS 3-Series Camera: Select this when the CMOS-3xx series with ID 1 ("Rear Camera") set is connected. (**Rear Camera Interruption** turns on.)

Other (Default): Select this when the other camera is connected.

■ **Rear Camera Interruption**

ON: Displays the picture from the rear view camera when you shift the gear to the reverse (R) position.

OFF (Default): Select this when no camera is connected.

■ **Rear Camera Settings**

If you select **CMOS 3-Series Camera** for **Rear Camera**, adjusts the CMOS-3xx series with ID 1 ("Rear Camera") set. For details, see the instruction manual of your camera.

■ **Parking Guidelines**

You can display parking guidelines to enable easier parking when you shift the gear to the reverse (R) position.

Default is "ON".

Guidelines SETUP

If you select **ON** for **Parking Guidelines**, adjust the parking guidelines. See **To adjust the parking guidelines (P.70)**.

Dashboard Camera /Front Camera (DDX8905S)

Dashboard Camera: Select this when the dashboard camera is connected.

CMOS 3-Series Camera: Select this when the CMOS-3xx series with ID 2 ("Front Camera") set is connected.

Other: Select this when the other camera is connected.

OFF (Default): Select this when no camera is connected.

Front Camera Type (DDX6905S/ DDX6705S/ DMX7705S)

CMOS 3-Series Camera: Select this when the CMOS-3xx series with ID 2 ("Front Camera") set is connected.

Other: Select this when the other camera is connected.

OFF (Default): Select this when no camera is connected.

Front Camera Settings

If you select **CMOS 3-Series Camera** for **Dashboard Camera /Front Camera**, **Front Camera Type**, adjusts the CMOS-3xx series with ID 2 ("Front Camera") set. For details, see the instruction manual of your camera.

Front Camera Mirror Image

If you select **Other** for **Dashboard Camera /Front Camera**, **Front Camera Type**.

ON: Displays the picture from the front view camera horizontally reversed.

OFF (Default): Displays the picture from the front view camera as it is.

To adjust the parking guidelines

NOTE

- Install the rear view camera in the appropriate position according to the instructions supplied with the rear view camera.
- When adjusting the parking guidelines, make sure to use the parking brake to prevent the car from moving.

1 Touch ON of Parking Guidelines in the Camera screen. (P.69)

2 Touch Guidelines SETUP in the Camera screen.

3 Adjust the parking guidelines by selecting the  mark.

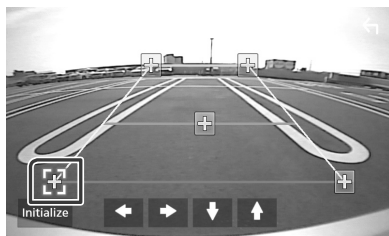

4 Adjusting the position of the selected mark.

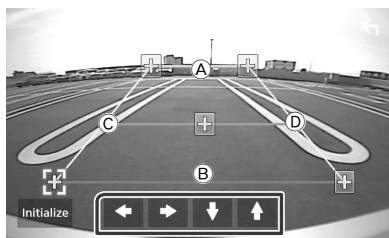

Make sure that **(A)** and **(B)** are horizontally parallel, and that **(C)** and **(D)** are the same length.

NOTE

- Touch **Initialize** and after touch **Yes** to set all the  marks to the initial default position.

Use Dashboard Camera (DDX8905S)

A Dashboard Camera, DRV-N520 (optional accessory), connected to this unit lets you play video-recorded data and so on.

For details, see the instruction manual of the Dashboard Camera DRV-N520 (optional accessory).

NOTE

- To connect a camera, see **P.95**.
- Sets the dashboard camera/front camera as **Dashboard Camera**. (**P.70**)

■ Display the dashboard camera screen

- 1 Press the **CAM** button.
 - View camera screen appears.

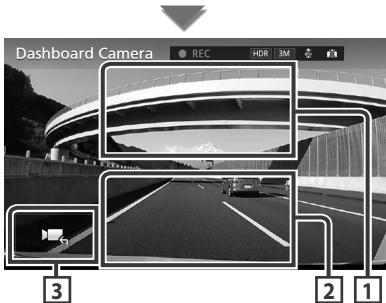

- 1 **Switching the View Camera**
Touch to change the dashboard view camera and rear view camera.
- 2 **Camera off**
Touch to exit the camera screen.
- 3 **Key display**
Touch to display the dashboard camera control buttons.

External audio/video players—AV-IN

- 1 Connect an external component to the AV-IN input terminal. (**P.94**)
- 2 Select **AV-IN** as the source. (**P.12**)
- 3 Turn on the connected component and start playing the source.

OEM Features Operation

By connecting this unit to the bus system of the vehicle using an iDataLink (commercially available), this unit can access the satellite radio source provided for the vehicle and vehicle information can be displayed on this unit.

1 DDX8905S/ DMX7705S

Press the **HOME** button.

DDX6905S/ DDX6705S

Press the  button.

➤ HOME screen appears.

2 Touch on the HOME screen.

3 Touch icon.

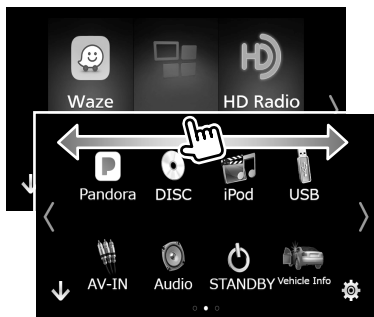

• Displays the control screen of the satellite radio source provided for the vehicle.



• Displays the control screen of the media player source provided for the vehicle.



• Displays the control screen of the Bluetooth Hands Free function provided for the vehicle.



• Displays the control screen of the Bluetooth streaming source provided for the vehicle.



• Displays information about the instruments such as a speedometer.



• Displays information about the air conditioner of the vehicle. *



• Displays information about the Parking Distance Sensor of the vehicle.



• Displays information about the tire pressures of the vehicle. *



• Displays information about the Radar Detector. *

* These ADS adapter features are displayed as the widget on the Home screen. **(P.11)** You can display these screens by touching the widget.

NOTE

• Displayable screens, button names, and screen names vary depending on the type of the connected iDataLink and the model of the vehicle. For more details, access the following URL:

www.idatalink.com/

Setting Up

Monitor Screen Setup

You can adjust image quality in video, menu screen, etc.

1 DDX8905S/ DMX7705S

Press the **MENU** button.

DDX6905S/ DDX6705S

Press the **≡** button.

➤ Popup menu appears.

2 Touch Screen Adjustment .



➤ Screen Control screen appears.

3 Adjust each item as follows.



■ Backlight / Contrast / Black / Brightness / Color / Tint

Adjusts each item.

■ Aspect

Select screen mode.

Full : Changes the aspect ratio of video and displays fully on the screen.

Normal : Displays with 4:3 ratio.

Auto :

DVD, VCD and disc media: Video of 16:9 ratio is displayed in Full and video of 4:3 ratio is displayed in Regular.

USB device: Displays video fully on vertical or horizontal with no ratio change.

NOTE

- Adjusting items are different depending on the current source.

System Setup

NOTE

- Each operation in this section can be started from the multi function menu.

1 DDX8905S/ DMX7705S

Press the **MENU** button.

DDX6905S/ DDX6705S

Press the **≡** button.

➤ Popup menu appears.

2 Touch SETUP.

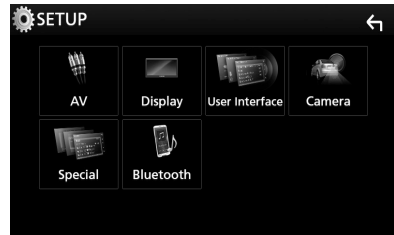

See the following section for each setting.

- Set up AV (**P.77**)
- Set up display (**P.75**)
- Set up the user interface (**P.74**)
- Set up camera (**P.69**)
- Set up special (**P.75**)
- Set up Bluetooth (**P.60**)

User Interface Setup

You can setup user interface parameters.

- 1 DDX8905S/ DMX7705S**
Press the **MENU** button.
DDX6905S/ DDX6705S
Press the **≡** button.
➤ Popup menu appears.

- 2 Touch SETUP.**
➤ SETUP screen appears.

- 3 Touch User Interface.**



➤ User Interface screen appears.

- 4 Set each item as follows.**

■ Beep

Turns the key touch tone on or off.
Default is "ON".

■ Parking Assist Display

When an ADS adapter is connected, you can display information about obstacles around the car.

ON: Always displays information.

Dyn. (Default): Displays information when the sensor detects obstacles.

OFF: Cancels.

This can be set when the iDataLink (commercially available) is connected.

■ Parking Assist Position

Select where information about obstacles is displayed on the screen (left or right).

"Left"/ "Right" (Default)

This can be set when the iDataLink (commercially available) is connected.

■ Language Select

Selects a language.

■ Touch Panel Adjust (DDX6905S/ DDX6705S/ DMX7705S)

Adjust the sensing position of touch panel. (P.74)

■ Clock

DDX8905S

GPS-SYNC (Default): Synchronizes the clock time with the GPS.

DDX6905S/ DDX6705S/ DMX7705S

RDS-SYNC (Default): Synchronizing the Radio Data System station time data and this unit's clock.

Manual: Sets the clock manually

■ Time Zone

Select the time zone.

■ Clock Adjust

If you select **Manual** for Clock, adjust the date and time manually. (P.74)

Adjust the date and time manually.

- 1 Touch Clock** in the User Interface screen.

- 2 Select Manual.**

- 3 Touch Time Zone** in the User Interface screen.

- 4 Select the time zone.**

- 5 Touch Clock Adjust** in the User Interface screen.

- 6 Adjust the date, then adjust the time.**

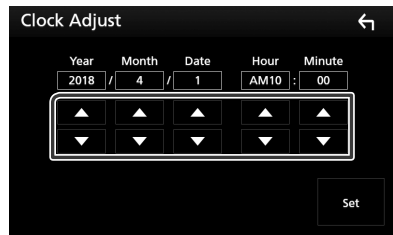

- 7 Touch Set.**

Touch panel adjustment (DDX6905S/ DDX6705S/ DMX7705S)

- 1 Touch Touch Panel Adjust** on the User Interface screen.

➤ Touch Panel Adjust screen appears.

- Follow the instruction on the screen and long touch the center of each .



NOTE

- To cancel the touch panel adjustment, touch **Cancel**.
- To reset to the initial status, touch **Reset**.

Special Setup

You can setup Special parameters.

- DDX8905S/ DMX7705S**
Press the **MENU** button.
DDX6905S/ DDX6705S
Press the  button.
➤ Popup menu appears.

- Touch **SETUP**.
➤ SETUP screen appears.

- Touch **Special**.



- Special screen appears.

- Set each item as follows.

■ **DEMO**

Set the demonstration mode. Default is "ON".

■ **SETUP Memory**

Locks or unlocks the Audio SETUP Memory/ Recall/Clear.

■ **Audio SETUP Memory**

Memorizes the current audio setting.

- Fader/ Balance, Speaker / X'over, Equalizer (User Preset, SW Level), Position/DTA, Sound Effect **(P.78)**

■ **Audio SETUP Recall**

Recalls the memorized audio setting.

■ **Audio SETUP Clear**

Clears the AUDIO SETUP Memory and the currently memorized audio setting.

■ **Software Information**

Check the software version of this unit. **(P.75)**

■ **Open Source Licenses**

Displays the open source licenses.

■ **Initialize**

Touch **Initialize** and then touch **Yes** to set all the settings to the initial default settings.

- Audio SETUP Memory is not initialized.

Software Information

Check the software version of this unit.

- Touch **Software Information** in the Special screen.

- Confirm the software version.

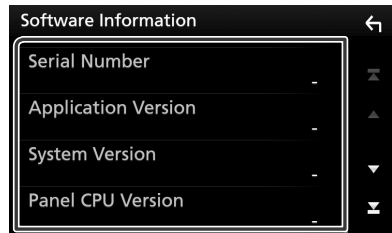

NOTE

- For how to update the software, see the relevant update procedure manual which comes with the software.

Display Setup

- DDX8905S/ DMX7705S**
Press the **MENU** button.
DDX6905S/ DDX6705S
Press the  button.
➤ Popup menu appears.

- Touch **SETUP**.
➤ SETUP screen appears.

Setting Up

3 Touch Display.



► Display screen appears.

4 Set each item as follows.

■ Dimmer

Select dimmer mode.

OFF: The display and buttons do not dim.

ON: The display and buttons dim.

SYNC (Default): Turns the dimmer function on or off when the vehicle light control switch is turned on or off.

■ OSD Clock

Select if you want to display the clock while watching DVD video, etc.

"ON" (Default)/ "OFF"

■ Key Color

You can set the button illumination color. (P.76)

■ Wallpaper Customize

Changing wallpaper image or color. (P.76)

■ Viewing Angle

If it is hard to see the image on the screen even, adjust the viewing angle. The smaller the (negative) value, the more whitish the image on the screen looks.

"0" (Default)/ "-1"/ "-2"/ "-3"

■ Customizing the key color

You can set the button illumination color.

1 Touch Key Color in the Display screen.

2 Touch the desired color.

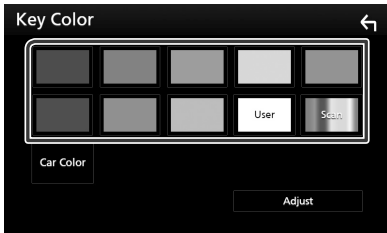

■ User

The color you have set in the process of **Adjust** is registered.

■ Scan

You can set the key color to continuously scan through the color spectrum.

■ Car Color

This can be selected when a compatible ADS adapter is connected.

3 Touch ←.

To register original color

You can register your original color.

1 Touch User in the Key Color screen.

2 Touch Adjust.

3 Use — and + to adjust each color value.

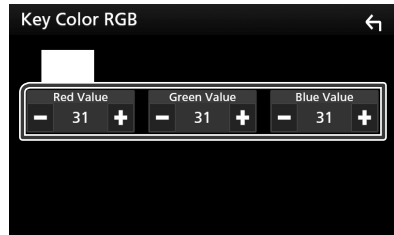

4 Touch ←.

■ Change wallpaper image or color

1 Touch Wallpaper Customize in the Display screen.

2 Select an image.

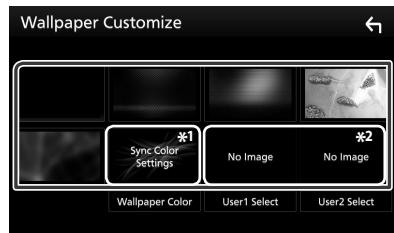

*1 Select a wallpaper color in advance.

*2 Select an original image in advance.

To select wallpaper color

1 Touch Wallpaper Color in the Wallpaper Customize screen.

2 Select a wallpaper color.

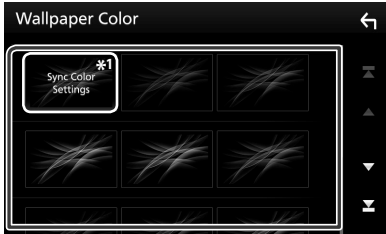

*1 The color you have selected at **Key Color** is added on the image. If you select "Scan" at **Key Color**, you cannot select this image.

3 Touch .

To register original image

You can load an image from the connected USB device and set it for the wallpaper image. Before operating this procedure, it is necessary to connect the device which has the image to load.

1 Touch **User1 Select** or **User2 Select** in the **Wallpaper Customize** screen.

2 Select the image to load.



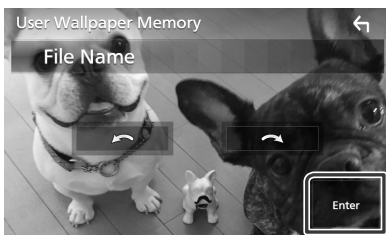

3 Touch **Enter**.



➤ The selected image is loaded and the display returns to the **Wallpaper Customize** screen.

NOTE

- Touching  rotates counter clockwise.
- Touching  rotates clockwise.
- Picture files: JPEG (.jpg, .jpeg), PNG (.png), BMP (.bmp)

AV Setup

You can set AV parameters.

1 **DDX8905S/ DMX7705S**

Press the **MENU** button.

DDX6905S/ DDX6705S

Press the  button.

➤ Pop up menu appears.

2 Touch **SETUP**.

➤ **SETUP** screen appears.

3 Touch **AV**.



➤ **AV** screen appears.

4 Set each item as follows.

■ **AV-OUT**

You can select an AV source to be output from the AV OUTPUT port.

OFF, AV-IN, DISC, USB, or iPod

- You cannot select iPod if it is connected via Bluetooth.
- If you select USB, iPod, Disc, Spotify, Pandora or Bluetooth audio as the main source, you cannot select USB or iPod as the AV output source.
- If you select Mirroring (WebLink/ Waze), Apple CarPlay or Android Auto as the main source, you cannot select DISC (Music CD/ Disc media), USB or iPod as the AV output source.

■ **Driving Position**

Select the driving position (left or right).

"Left" (Default)/ "Right"

■ **OEM SETUP**

Confirm the information about/ change the settings for using the ADS adapter.

Controlling Audio

NOTICE

- Each operation in this section can be started from the multi function menu.

You can adjust the various settings such as audio balance or subwoofer level.

- 1 DDX8905S/ DMX7705S**
Press the **MENU** button.
DDX6905S/ DDX6705S
Press the **≡** button.
▶ Popup menu appears.

2 Touch **Audio**.

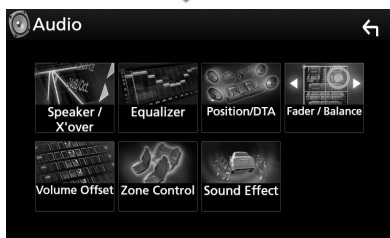

See the following section for each setting.

- Set up speaker/ X'over (**P.78**)
- Controlling equalizer (**P.80**)
- Set listening position/ DTA (**P.83**)
- Controlling general audio (Fader / Balance) (**P.79**)
- Set volume offset (**P.81**)
- Performing zone control (**P.81**)
- Set sound effect (**P.82**)

Speaker/ X'over setup

- 1 DDX8905S/ DMX7705S**
Press the **MENU** button.
DDX6905S/ DDX6705S
Press the **≡** button.
▶ Popup menu appears.
- 2 Touch **Audio**.**
▶ Audio screen appears.
- 3 Touch **Speaker/X'over**.**

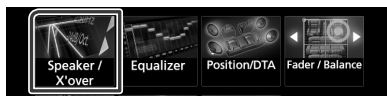

4 Select a car type.

You can setup the car type and speaker network, etc.

If your car type is selected, the Delay Time Alignment is set automatically (for timing adjustment of sound output for each channel) to have the highest surround effects.

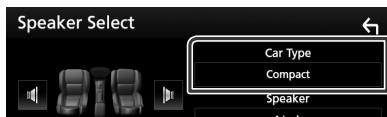

5 Touch the speaker (1) you wish to adjust and set each item (2) as follows.

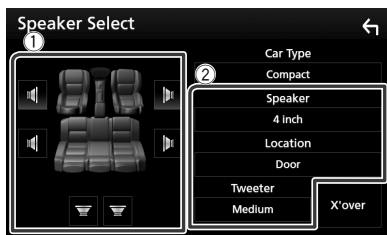

■ **Speaker**

You can select a speaker type and its size to get the best sound effects.

When the speaker type and size are set, the speaker crossover network is set automatically.

■ **Location (Only for Front, Rear)**

Select the speaker position you have fixed.

■ **Tweeter (Only for Front)**

You can set the tweeter when you are selecting front speakers.

None, Small, Medium, Large

■ **X'over**

Displays the speaker crossover setup screen.

You can adjust the crossover setup that was set automatically when you selected the speaker type.

For details, see **Crossover network setup (P.79)**

■ **TW Gain** *2

Adjusts the tweeter level. (When front is selected on Speaker Select screen)

■ **Phase Inversion** *3

Sets the phase of subwoofer output.

Check **Phase Inversion** to shift the phase 180 degrees. (When subwoofer is selected on Speaker Select screen)

*1 Only when "LPF FREQ"/"HPF FREQ" is set to a mode other than "Through" in **X'over**.

*2 Only when "Tweeter" is set to "Small", "Medium", "Large" in **Speaker Setup**.

*3 Only when "Subwoofer" is set to a mode other than "None" in **Speaker Setup**.

■ **Crossover network setup**

You can set a crossover frequency of speakers.

1 Touch **X'over**.



2 Touch the speaker to set.



3 Set each item as follows.

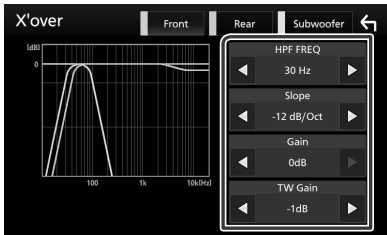

■ **HPF FREQ**

High Pass Filter adjustment. (When front or rear speaker is selected on Speaker Select screen)

■ **LPF FREQ**

Low Pass Filter adjustment. (When subwoofer is selected on Speaker Select screen)

■ **Slope** *1

Sets a crossover slope.

■ **Gain**

Adjusts the front speaker, rear speaker, or subwoofer level.

Controlling General Audio

1 **DDX8905S/ DMX7705S**

Press the **MENU** button.

DDX6905S/ DDX6705S

Press the **≡** button.

➤ Pop up menu appears.

2 Touch **Audio**.

➤ Audio screen appears.

3 Touch **Fader / Balance**.

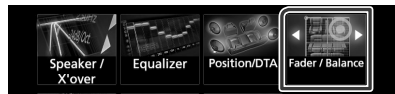

4 Set each item as follows.

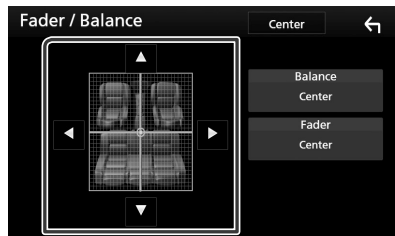

■ **Fader / Balance**

Adjust the volume balance around the touched area.

◀ and ▶ adjust the right and left volume balance.

▲ and ▼ adjust the front and rear volume balance.

Controlling Audio

■ Center

Clear the adjustment.

Equalizer Control

You can adjust equalizer by selecting the optimized setting for each category.

1 DDX8905S/ DMX7705S

Press the **MENU** button.

DDX6905S/ DDX6705S

Press the **≡** button.

➤ Pop up menu appears.

2 Touch **Audio**.

➤ Audio screen appears.

3 Touch **Equalizer**.



4 Touch the screen and set the Graphic Equalizer as desired.

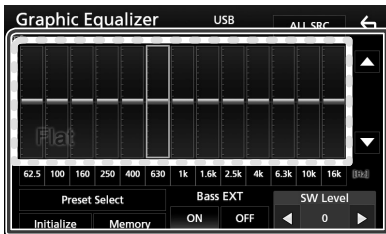

■ **Gain level (dotted frame area)**

Adjust the gain level by touching the each frequency bar.

You can select frequency bar and adjust its level by ▲, ▼.

■ **Preset Select**

Displays the screen to recall the preset equalizer curve.

■ **Memory**

Saves the adjusted equalizer curve from "User1" to "User4".

■ **Initialize**

The current EQ curve returns to flat.

■ **ALL SRC**

Apply the adjusted equalizer to all sources. Touch **ALL SRC** and then touch **OK** on the confirmation screen.

■ **Bass EXT (Bass Extend Settings)**

When turned on, the frequency lower than 62.5 Hz is set to the same gain level as 62.5 Hz.

■ **SW Level**

Adjusts the subwoofer volume. This setting is not available when subwoofer is set to "None". See **Speaker/ X'over setup (P.78)**.

■ Recall the EQ curve

1 Touch **Preset Select**.

2 Select EQ curve.

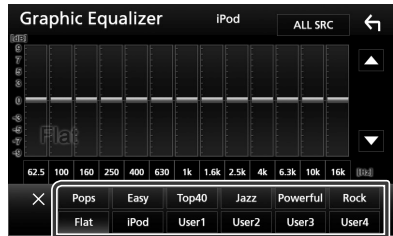

NOTE

- **iPod** is available only during iPod source.

■ Save the EQ curve

1 Adjust the EQ curve.

2 Touch **Memory**.

3 Select where to save.

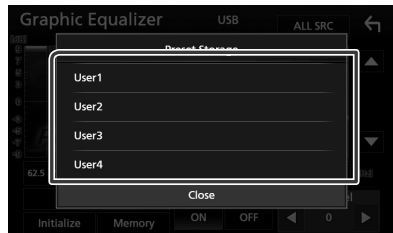

Volume Offset

Finely adjust the volume of the current source to minimize the difference in volume between different sources.

- 1 DDX8905S/ DMX7705S**
Press the **MENU** button.
DDX6905S/ DDX6705S
Press the **≡** button.
➤ Popup menu appears.
- 2 Touch Audio.**
➤ Audio screen appears.
- 3 Touch Volume Offset.**



- 4 Touch + or - to adjust the level.**



■ Initialize

Returns to the initial settings.

* If you have increased the volume first, then reduced the volume using the "Volume Offset", the sound generated if you suddenly switch to another source may be extremely loud.

Zone Control

You can select different sources for both front and rear positions in the vehicle.

- 1 DDX8905S/ DMX7705S**
Press the **MENU** button.
DDX6905S/ DDX6705S
Press the **≡** button.
➤ Popup menu appears.
- 2 Touch Audio.**
➤ Audio screen appears.
- 3 Touch Zone Control.**



➤ Zone Control screen appears.

- 4 Touch Zone Select.**

- 5 Touch Dual Zone.**

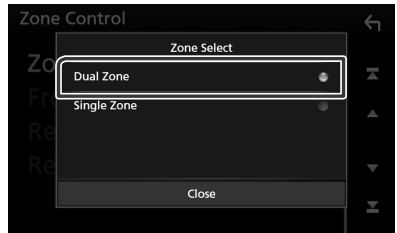

- 6 Set each source as follows.**

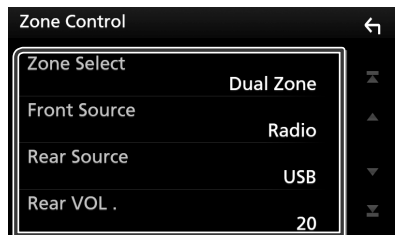

■ Zone Select

Touch **Single Zone** to turn off the dual zone function.

■ Front Source Rear Source

Select the audio source for each.

■ Rear VOL.

Adjusts the rear source volume.

NOTE

- When the rear speaker sound is switched, the audio source that is output at the AV OUTPUT terminal is also switched to the same source.
- When the dual zone function is set to on, the following functions are not available.
 - Output from the subwoofer
 - Subwoofer Level/ Bass Boost **(P.82)**
 - Equalizer Control/ Sound Effect/ Listening Position **(P.80, 82, 83)**
 - Speaker Setup **(P.78)**
 - High-resolution Sound Source File Playback
- You cannot select iPod if it is connected via Bluetooth.
- If you select USB, iPod, Disc, Spotify, Pandora or Bluetooth audio as the Front Source, you cannot select USB or iPod as the Rear Source.
- If you select Mirroring (WebLink/ Waze), Apple CarPlay or Android Auto as the Front Source, you cannot select DISC (Music CD/ Disc media), USB or iPod as the Rear Source.

Sound Effect

You can set sound effects.

- 1 DDX8905S/ DMX7705S**
 Press the **MENU** button.
DDX6905S/ DDX6705S
 Press the **≡** button.
 ▶ Popup menu appears.
- 2 Touch Audio .**
 ▶ Audio screen appears.
- 3 Touch Sound Effect .**



- 4 Set each item as follows.**

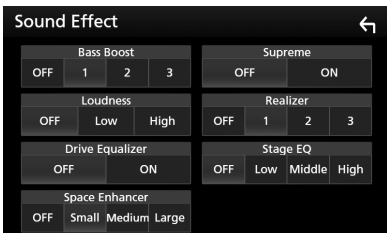

■ **Bass Boost**

Sets the amount of bass boost among “OFF”/ “1”/“2”/“3”.

■ **Loudness**

Sets the amounts of boost of low and high tones.

“OFF”, “Low”, “High”

■ **Drive Equalizer**

Reduces the driving noise by raising the bandwidth.

“OFF”, “ON”

■ **Space Enhancer**

Select the feeling of sound space enhancement.

“OFF”/ “Small”/ “Medium”/ “Large”.

This setting is not available during Radio/ HD Radio tuner source.

■ **Supreme**

Turns ON/OFF the Supreme function.

Technology to extrapolate and supplement with proprietary algorithm, the high-frequency range that is cut off when encoding.

■ **Realizer**

Virtually makes the sound more realistic using the Digital Signal Processor (DSP) system.

Select the level from “OFF”/ “1”/ “2”/ “3”.

■ **Stage EQ**

You can adjust the height of speakers virtually to suit your listening position.

“OFF”/ “Low”/ “Middle”/ “High”.

Listening Position/ DTA

Listening Position/DTA allows you to improve the sound field depending on the position of the seat you sit.

Listening Position/DTA allows you to set "Listening Position" and "Front Focus". You cannot set both at the same time.

- DDX8905S/ DMX7705S**
Press the **MENU** button.
DDX6905S/ DDX6705S
Press the **≡** button.
▶ Pop up menu appears.

- Touch Audio.**
▶ Audio screen appears.

- Touch Position/DTA.**



- Set up Listening Position (**P.83**)
- Set up Front Focus (**P.84**)

Listening Position

Adjust the sound delay time as nearer speakers to the selected seat have more delay time, so that the sound from each speaker arrive a listener at the same time.

- Touch Listening Position** in the Position/DTA screen.
- Select listening position from **Front R** (Right front), **Front L** (Left front), **Front All** (All front), and **All**.



Position DTA control

You can fine-adjust your listening position.

- Touch Adjust.**
- Touch Delay.**
- Touch ◀ or ▶ to adjust the delay time of the selected speaker.**

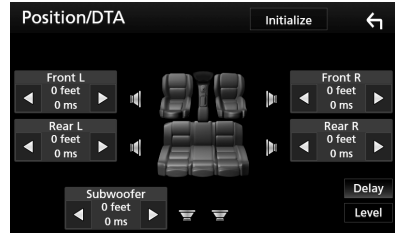

- Touch Level.**

- Touch ◀ or ▶ to adjust the sound level of the selected speaker.**

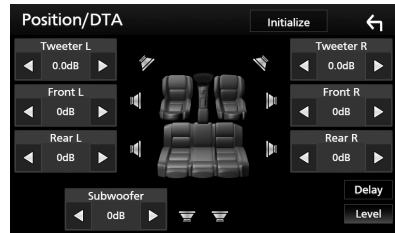

NOTE

- To return to the initial setting of Delay and Level, touch **Initialize** and **YES** in the confirmation screen.

Front Focus

This is the function to focus the imaginary sound image in front of the selected seat.

1 Touch **Front Focus** in the Position/DTA screen.

2 Select a front focus position.

For **Front All** and **All**, select Priority L or R depending on which side you want to put the imaginary sound image.



Front Focus fine adjustment

1 Touch **Adjust**.

2 Touch **Delay**.

3 Set each item as follows.

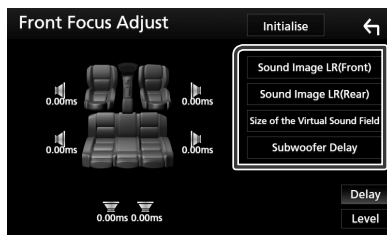

■ Sound Image LR (Front)

Adjust the sound image to focus on in front of front seats.

■ Sound Image LR (Rear)

Adjust the sound image to focus on in front of rear seats.

■ Size of the Virtual Sound Field

Adjust the size of sound image to meet your taste. If the sound image is shifted from the front, adjust it by **Sound Image LR (Front)** or **Sound Image LR (Rear)**.

■ Subwoofer Delay

Adjust the delay time of subwoofer.

4 Touch **Level**.

5 Touch ◀ or ▶ to adjust the sound level of the selected speaker.

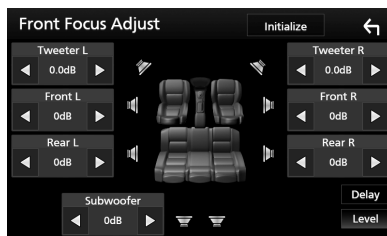

NOTE

- To return to the initial setting of Delay and Level, touch **Initialize** and **YES** in the confirmation screen.

Remote control

This unit can be operated using the remote control KNA-RCDV331 (optional accessory).

▲ CAUTION

- Put the remote control in a place where it will not move during braking or other operations. A dangerous situation could result, if the remote control falls down and gets wedged under the pedals while driving.
- Do not leave the battery near fire or under direct sunlight. A fire, explosion or excessive heat generation may result.
- Do not recharge, short, break up or heat the battery or place it in an open fire. Such actions may cause the battery to leak fluid. If spilled fluid comes in contact with your eyes or on clothing, immediately rinse with water and consult a physician.
- Place the battery out of reach of children. In the unlikely event that a child swallows the battery, immediately consult a physician.

Battery Installation

If the remote control operates only over shorter distances or does not operate at all, it is possible that the batteries are depleted.

In such instances, replace the both batteries with new ones.

- 1 Insert two "AAA"/"R03"-size batteries with the ⊕ and ⊖ poles aligned properly, following the illustration inside the case.

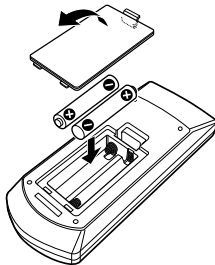

Functions of the Remote control Buttons

■ Switch the operation mode

The functions operated from the remote control differ depending on the position of the mode switch.

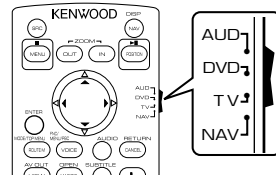

■ AUD mode

Switch to this mode when controlling a selected source or tuner source, etc.

■ DVD mode

Switch to this mode when playing a disc media including DVD, VCD, and CD.

■ NAV mode

Not used.

■ TV mode

Not used.

NOTE

- When controlling a player that is not integrated in the unit, select "AUD" mode.

Remote control

Direct search mode

Using the remote control, you can jump directly to the desired file, track chapter, etc. with entering the number corresponding to the content.

NOTE

- This operation cannot be performed for USB device and iPod.

1 Press the #BS button several times until the desired content appears.

The available contents are different depending on the source.

DVD

Title number/Chapter number

VCD 1.X and 2.X (PBC OFF)

Track number

VCD 2.X (PBC ON)

Scene number/Track number

Music CD

Track number

Radio

Frequency value

HD Radio tuner

Frequency value/Channel number

SiriusXM

Channel number

2 Enter the number of the content you want to play using the numeric keypad.

3 For DVD or VCD, music CD, press the ENTER button.



For radio, press the ◀ or ▶ button.

▶ The content you entered is played.

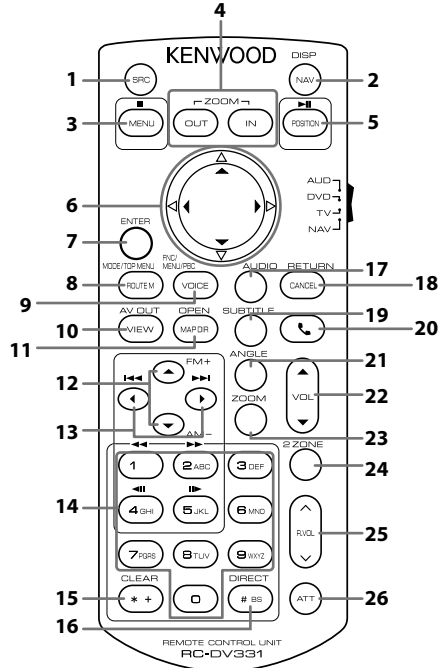
Basic operations



	Key Name	Mode switch	Function
1	SRC	AUD, DVD	Switches to the source to be played. In hands-free mode, hangs up the phone.
2	NAV	-	Switches the screen between the current source and the App screen from the connected iPhone/Android.
3	MENU	DVD	Stops playing and memorizes the last point where the disc stopped. The last point is deleted by pressing twice.
4	OUT, IN	-	Not used.
5	POSITION	AUD, DVD	Pauses the track or file, and resumes playing by pressing twice. During radio and HD Radio source in AUD mode, switches the seek mode.
6	Cursor Key	DVD	Moves the cursor in the DVD menu.
7	ENTER	AUD, DVD	Performs the selected function.

	Key Name	Mode switch	Function
8	ROUTE M	AUD	Screen mode changes each time you press this key during video playback.
		DVD	Returns to the DVD top menu.
9	VOICE	AUD	Displays the control screen of current source. (USB, iPod, DISC)
		DVD	Displays the DVD menu. Turns the playback control on or off while playing VCD.
10	VIEW	AUD, DVD	Switches the AV source to be output.
11	MAP DIR	AUD, DVD	Switches the display angle each time it is pressed. (DDX8905S only)
12	▲/▼	AUD, DVD	Selects the folder to be played. During radio and HD Radio source in AUD mode, select FM/ AM band to be received. During SiriusXM source in AUD mode, switches the bands to be received. During DVD/VCD source in DVD mode, selects the title to be played.
13	◀▶	AUD, DVD	Selects the track or file to be played. During radio, HD Radio, and SiriusXM source in AUD mode, switches to broadcast stations received by the unit. During DVD/VCD source in DVD mode, selects the chapter/scene/track to be played.
14	Numeric Keypad	AUD	Specifies the number to search in direct search. For details on the direct search mode, see Direct search mode (P.86) .
		DVD	<ul style="list-style-type: none"> • Press 1 2 to fast forward/backward. • Press 4 5 to slow forward/backward. Switches the slow playback speed each time you press this key.* *DVD only
15	* +	DVD	During DVD/VCD source, deletes a character while in direct search mode.
16	# BS	AUD, DVD	Switches to the direct search mode. For details on the direct search mode, see Direct search mode (P.86) .
17	AUDIO	DVD	Switches the voice language each time you press this key.
18	CANCEL	DVD	Displays previous screen.
19	SUBTITLE	DVD	Switches the subtitle language.
20		–	When a call comes in, answers the call.
21	ANGLE	DVD	Switches the picture angle each time you press this key.
22	Vol ▲▼	–	Adjusts the volume.
23	ZOOM	DVD	Switches the zoom ratio (2, 3, 4, Off) each time you press this key.
24	2 ZONE	AUD, DVD	Switches the Dual Zone function on and off.
25	R.VOL 	–	Adjusts volume at rear when the Dual Zone function is on.
26	ATT	–	Lowers the volume by pressing the key once. Restores the previous volume by pressing the key twice.

Connection/Installation

Before Installation

Before installation of this unit, please note the following precautions.

▲ WARNINGS

- If you connect the ignition wire (red) and the battery wire (yellow) to the car chassis (ground), you may cause a short circuit, that in turn may start a fire. Always connect those wires to the power source running through the fuse box.
- Do not cut out the fuse from the ignition wire (red) and the battery wire (yellow). The power supply must be connected to the wires via the fuse.

▲ CAUTION

- Install this unit in the console of your vehicle. Do not touch the metal part of this unit during and shortly after the use of the unit. Metal part such as the heat sink and enclosure become hot.

NOTE

- Mounting and wiring this product requires skills and experience. For best safety, leave the mounting and wiring work to professionals.
- Make sure to ground the unit to a negative 12V DC power supply.
- Do not install the unit in a spot exposed to direct sunlight or excessive heat or humidity. Also avoid places with too much dust or the possibility of water splashing.
- Do not use your own screws. Use only the screws provided. If you use the wrong screws, you could damage the unit.
- If the power is not turned ON ("There is an error in the speaker wiring. Please check the connections." is displayed), the speaker wire may have a short-circuit or touched the chassis of the vehicle and the protection function may have been activated. Therefore, the speaker wire should be checked.
- If your car's ignition does not have an ACC position, connect the ignition wires to a power source that can be turned on and off with the

ignition key. If you connect the ignition wire to a power source with a constant voltage supply, such as with battery wires, the battery may be drained.

- If the console has a lid, make sure to install the unit so that the front panel will not hit the lid when closing and opening.
- If the fuse blows, first make sure the wires aren't touching to cause a short circuit, then replace the old fuse with one with the same rating.
- Insulate unconnected wires with vinyl tape or other similar material. To prevent a short circuit, do not remove the caps on the ends of the unconnected wires or the terminals.
- Connect the speaker wires correctly to the terminals to which they correspond. The unit may be damaged or fail to work if you share the ⊖ wires or ground them to any metal part in the car.
- When only two speakers are being connected to the system, connect the connectors either to both the front output terminals or to both the rear output terminals (do not mix front and rear). For example, if you connect the ⊕ connector of the left speaker to a front output terminal, do not connect the ⊖ connector to a rear output terminal.
- After the unit is installed, check whether the brake lamps, blinkers, wipers, etc. on the car are working properly.
- Mount the unit so that the mounting angle is 30° or less.
- This unit has the cooling fan to decrease the internal temperature. Do not mount the unit in a place where the cooling fan of the unit is blocked. Blocking these openings will inhibit the cooling of the internal temperature and result in malfunction.

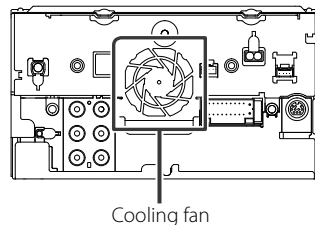



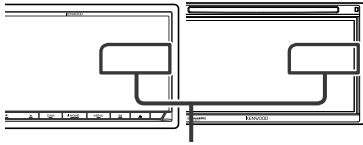



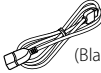

- Do not press hard on the panel surface when installing the unit to the vehicle. Otherwise scars, damage, or failure may result.
- Reception may drop if there are metal objects near the Bluetooth antenna.

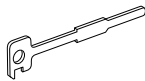

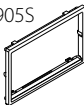
Bluetooth antenna unit

■ Supplied accessories for installation

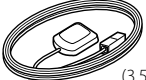
①		x1
②	 (Black 1 m)	x1
③ ^[1]	 (Gray 1 m)	x1
④	 (3 m)	x1
⑤ ^[2]		x2
⑥	 (M5 x 8 mm)	x6
⑦	 (M5 x 8 mm)	x6
⑧ ^[2]	DDX8905S  DDX6905S 	x1

⑨ ^[3]	 (3.5 m)	x1
⑩ ^[3]		x1

^[1] DDX8905S/ DDX6905S/ DMX7705S only

^[2] DDX8905S/ DDX6905S only

^[3] DDX8905S only

■ Installation procedure

- 1) To prevent a short circuit, remove the key from the ignition and disconnect the ⊖ terminal of the battery.
- 2) Make the proper input and output wire connections for each unit.
- 3) Connect the speaker wires of the wiring harness.
- 4) Connect the wiring harness wires in the following order; ground, battery, ignition.
- 5) Connect the wiring harness connector to the unit.
- 6) Install the unit in your car.
- 7) Reconnect the ⊖ terminal of the battery.
- 8) Perform the Initial Setup.
See **Initial setup (P.8)**.

Installing the unit

■ Non-Japanese cars (DDX8905S/ DDX6905S)

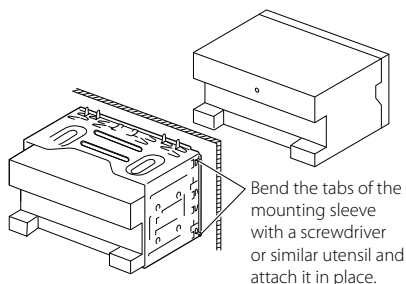

■ Japanese cars

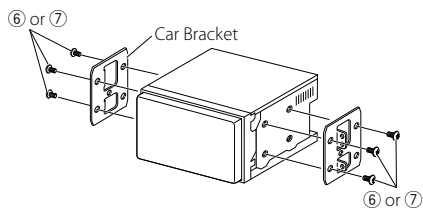

NOTE

- Make sure that the unit is installed securely in place. If the unit is unstable, it may malfunction (eg, the sound may skip).

■ Trim plate (DDX8905S/ DDX6905S)

● DDX8905S

- 1) Attach accessory ⑧ to the unit.

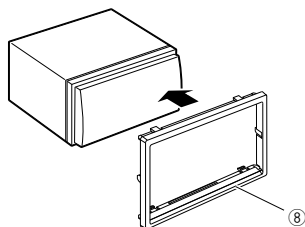

● DDX6905S

- 1) Attach accessory ⑧ to the unit.

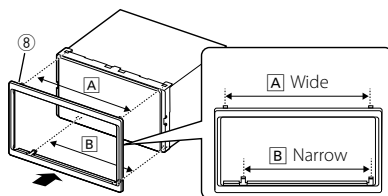

GPS antenna (DDX8905S)

GPS antenna is installed inside of the car. It should be installed as horizontally as possible to allow easy reception of the GPS satellite signals.

To mount the GPS antenna inside your vehicle:

- 1) Clean your dashboard or other surface.
- 2) Remove the separator of the metal plate (accessory ⑩).
- 3) Press the metal plate (accessory ⑩) down firmly on your dashboard or other mounting surface. You can bend the metal plate (accessory ⑩) to conform to a curved surface, if necessary.
- 4) Remove the separator of the GPS antenna (accessory ⑨), and stick the antenna to the metal plate (accessory ⑩).

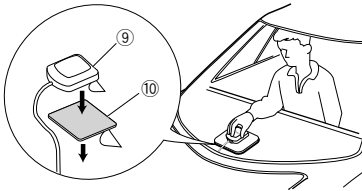

NOTE

- Depending on the type of car, reception of the GPS satellite signals might not be possible with an inside installation.
- Please install this GPS antenna in an area away from any antennas that are used with CB radios or satellite televisions.
- The GPS antenna should be installed at a position that is spaced at least 12 inch (30 cm) from cellular phone or other transmitting antennas. Signals from the GPS satellite may be interfered with by these types of communication.
- Painting the GPS antenna with (metallic) paint may cause a drop in performance.

Microphone unit

- 1) Check the installation position of the microphone (accessory ④).
- 2) Clean the installation surface.
- 3) Remove the separator of the microphone (accessory ④), and stick the microphone to the place shown below.
- 4) Wire the microphone cable up to the unit with it secured at several positions using tape or other desired method.
- 5) Adjust the direction of the microphone (accessory ④) to the driver.

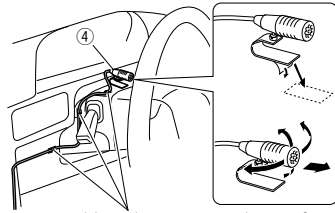

Fix a cable with a commercial item of tape.

Removing the trim plate (DDX8905S/ DDX6905S)

● DDX8905S

- 1) Engage the catch pins on the extraction key (accessory ⑤) and remove the two locks on the lower level. Lower the trim plate (accessory ⑧) and pull it forward as shown in the figure.

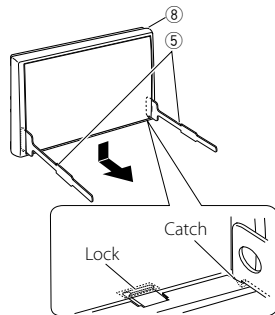

NOTE

- The trim plate can be removed from the top side in the same manner.

Connection/Installation

- 2) When the lower level is removed, remove the upper two locations.

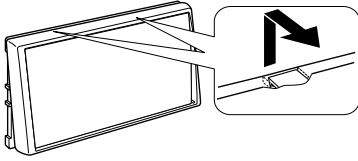

● DDX6905S

- 1) Engage the catch pins on the extraction key (accessory ⑤) diagonally and remove the two locks on the lower level. Lower the trim plate (accessory ⑧) and pull it forward as shown in the figure.

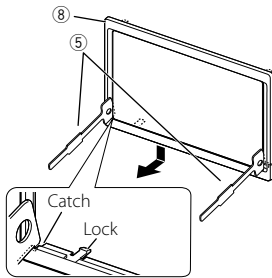

NOTE

- The trim plate can be removed from the top side in the same manner.

- 2) When the lower level is removed, remove the upper two locations.

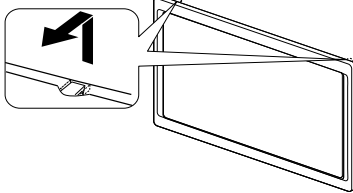

■ Removing the unit (DDX8905S/ DDX6905S)

- 1) Remove the trim plate by referring to step 1 in "Removing the trim plate".
- 2) Insert the two extraction key (accessory ⑤) deeply into the slots on each side, as shown.

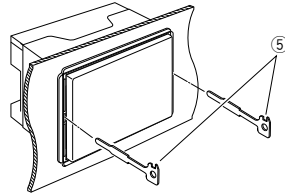

- 3) Lower the extraction key toward the bottom, and pull out the unit halfway while pressing towards the inside.

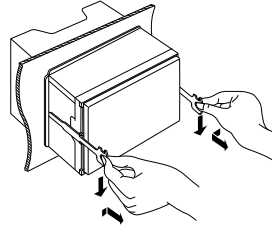

NOTE

- Be careful to avoid injury from the catch pins on the extraction key.

- 4) Pull the unit all the way out with your hands, being careful not to drop it.

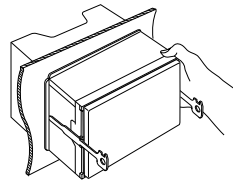

Connecting wires to terminals

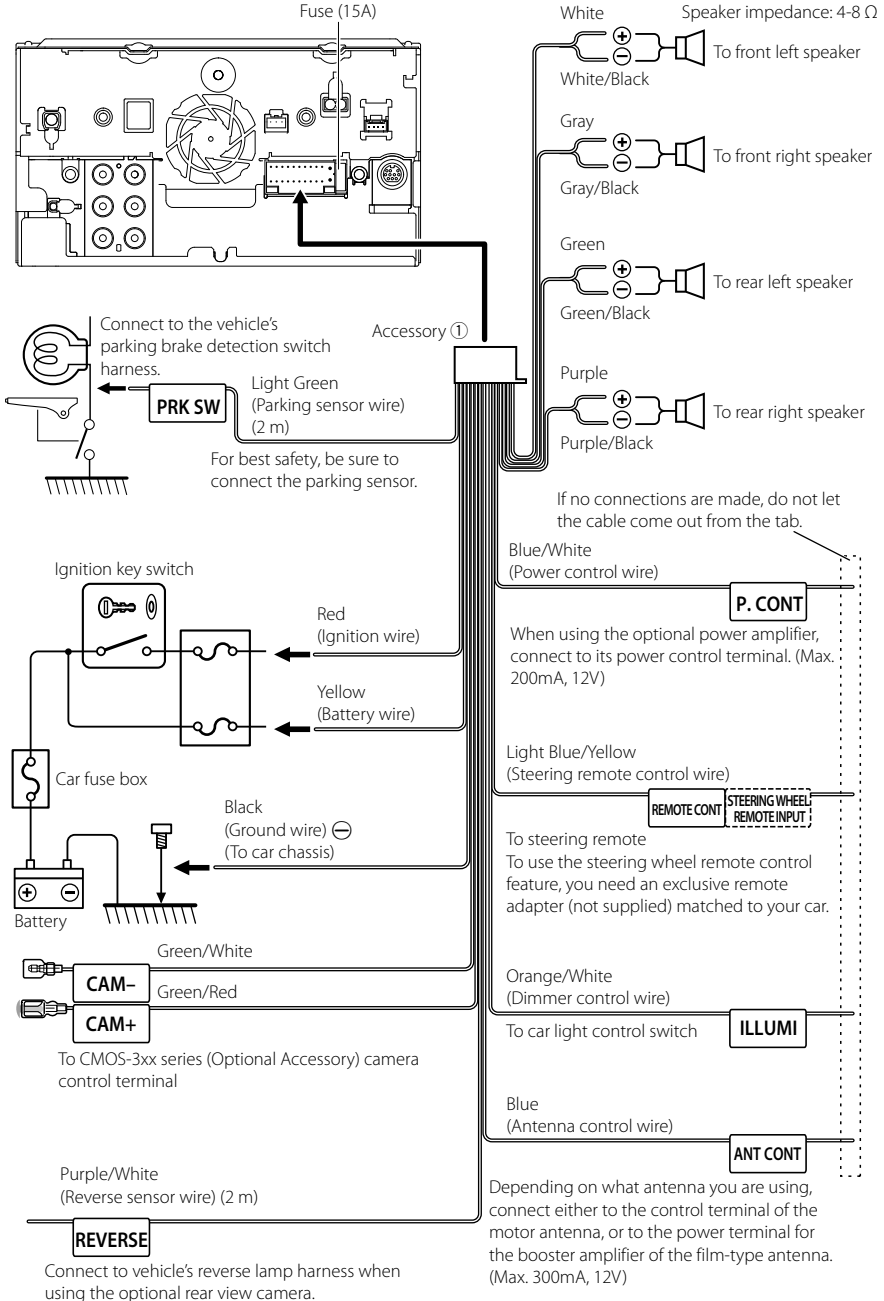

Connecting the system and external components

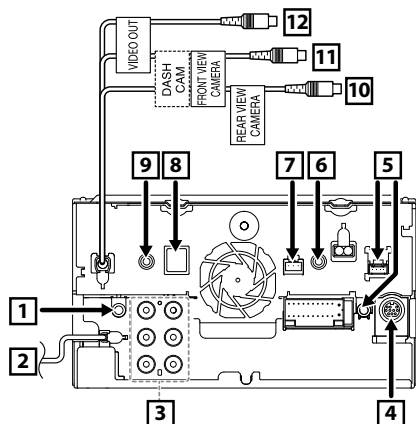

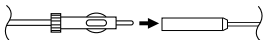
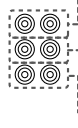
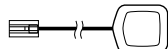
1	AV Audio output (ø3.5 mini jack)
2	FM/AM antenna input 
3	When connecting to an external amplifier, connect its ground wire to the car's chassis to avoid damaging the unit. <div style="display: flex; align-items: center;"> <div style="margin-right: 10px;"> <p>--- Rear Audio Preout (Left; White, Right; Red)</p> <p>--- Front Audio Preout (Left; White, Right; Red)</p> <p>--- Subwoofer Preout (Left; White, Right; Red)</p> </div>  </div>
4	SiriusXM Connect Vehicle Tuner connector For more information on how to install the SiriusXM Connect Vehicle tuner, consult the installation guide included with the tuner.
5	iDataLink connector
6	AV-IN (CA-C3AV; Optional Accessory) input
7	Dashboard camera interface (DDX8905S only) Connect a Dashboard Camera DRV-N520 (optional accessory). (P.95)
8	Accessory ⑨: GPS Antenna (DDX8905S only) 

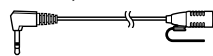
9	Accessory ④: Bluetooth Microphone 
10	Rear view camera input (Yellow)
11	Front view camera/ Dashboard camera input (Yellow) (DDX8905S only) Front view camera input (Yellow) (DDX6905S/ DDX6705S/ DMX7705S only)
12	Visual Output (Yellow)

Connecting a USB device

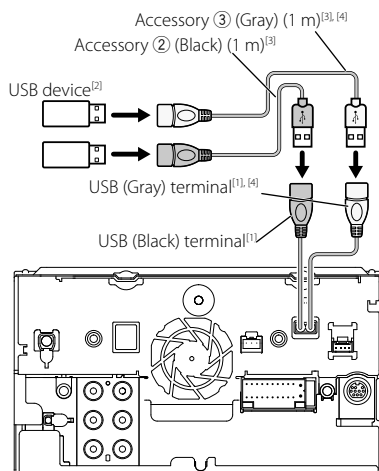

^[1] USB maximum power supply current : DC 5 V \equiv 1.5 A

^[2] Sold separately / Use CA-U1EX to extend the cable if necessary. (Max 500 mA, 5V)

^[3] See **Securing the USB extension cable (P.95)**.

^[4] DDX8905S/ DDX6905S/ DMX7705S only

Connecting an iPod/iPhone

Lightning connector

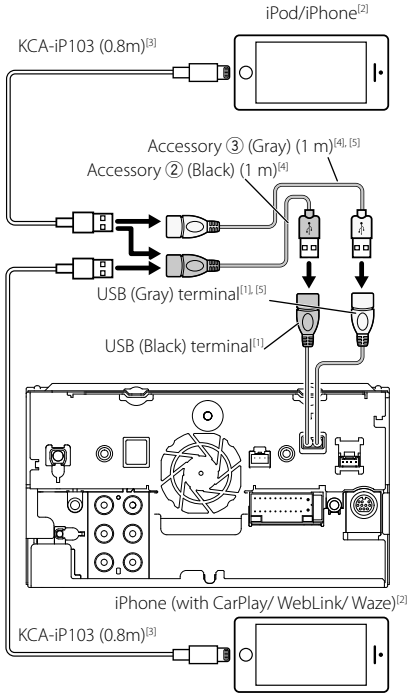

^[1] USB maximum power supply current :
DC 5 V \equiv 1.5 A

^[2] Sold separately

^[3] Optional accessory

^[4] See **Securing the USB extension cable (P.95)**.

^[5] DDX8905S/ DDX6905S/ DMX7705S only

Securing the USB extension cable

Secure the USB extension cable with insulating tape or the like so that its connectors are not disconnected.

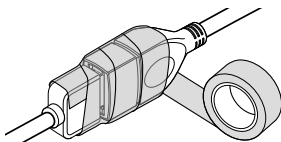

Connecting an Android smartphone

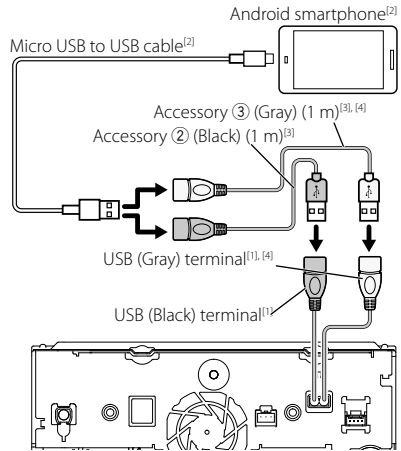

^[1] USB maximum power supply current :
DC 5 V \equiv 1.5 A

^[2] Sold separately

^[3] See **Securing the USB extension cable (P.95)**.

^[4] DDX8905S/ DDX6905S/ DMX7705S only

Connecting a Dashboard camera (DDX8905S)

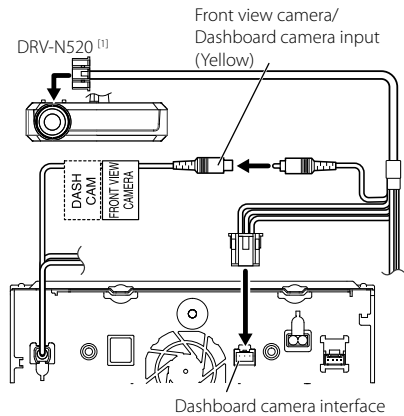

^[1] Optional accessory

Troubleshooting

Problems and Solutions

If any trouble occurs, first check the following table for possible problems.

NOTE

- Some functions of this unit may be disabled by some settings made on this unit.
- What might seem to be a malfunction in your unit may just be the result of slight misoperation or miswiring.

About settings

- **Cannot set up the subwoofer.**
- **Cannot set up subwoofer phase.**
- **No output from the subwoofer.**
- **Cannot set up the low pass filter.**
- **Cannot set up the high pass filter.**

Subwoofer is not set to on.

- Set the subwoofer to on. See *Speaker/ X'over setup (P.78)*.

The dual zone function is enabled.

- Set the dual zone function to off. See *Zone Control (P.81)*.

- **Cannot select the output destination of the subsource in the dual zone.**
- **Cannot adjust the volume of the rear speakers.**

The dual zone function is disabled.

- Set the dual zone function to on. See *Zone Control (P.81)*.

- **Cannot set up the equalizer.**
- **Cannot set up the crossover network.**

The dual zone function is enabled.

- Set the dual zone function to off. See *Zone Control (P.81)*.

About audio operations

Radio reception is poor.

The car antenna is not extended.

- Pull out the antenna all the way.

The antenna control wire is not connected.

- Connect the wire correctly. See *Connecting the system and external components (P.94)*.

Cannot select a folder.

The random play function is enabled.

- Turn off the random function.

Cannot perform repeat play during VCD playback.

The PBC function is enabled.

- Turn off the PBC function.

The specified disc does not play, but another one plays instead.

The disc is quite dirty.

- Clean the disc. See *Precautions on handling discs (P.4)*.

The disc is severely scratched.

- Try another disc instead.

The sound skips when an audio file is being played.

The disc is scratched or dirty.

- Clean the disc. See *Precautions on handling discs (P.4)*.

The recording condition is bad.

- Record the file again or use another disc.

Other

The Touch Sensor Tone doesn't sound.

The preout jack is being used.

- The Touch Sensor Tone cannot be output from the preout jack.

Android smartphone operation is slow.

This occurs when multiple applications are started on the Android smartphone.

- For details, see *Caution for Smartphone Users (P.5)*.

Error Messages

When you fail to operate the unit correctly, the cause of the failure appears as the message on the screen.

There is an error in the speaker wiring. Please check the connections.

Protective circuit has been activated because a speaker cord has shorted or it has come in contact with the car chassis.

- Wire or insulate the speaker cord as appropriate and turn the power off and on again.

Hot Error

When the internal temperature of this unit rises to 60°C or more, the protection circuit is activated and you may not be able to operate the unit.

- Use the unit again after reducing the temperature of the unit.

Mecha Error

The disc player is malfunctioning.

- Eject the disc and try inserting it again. Contact the KENWOOD dealer if this indicator continues blinking or the disc cannot be ejected.

Disc Error

An unplayable disc is inserted.

- Change the disc. See **Playable Media and Files (P.98)**.

Read Error

The disc is quite dirty.

- Clean the disc. See **Precautions on handling discs (P.4)**.

Disc is upside down.

- Load the disc with the labeled side up.

Region Code Error

The disc you wanted to play has a region code that cannot be played with this unit.

- See **Region Codes in the World (P.100)** or try another disc.

Error 07–67

The unit is not operating correctly due to some reason or other.

- Turn the power off and on again. If the "Error 07–67" message does not disappear, see your nearest KENWOOD dealer.

No Device (USB device)

The USB device is selected as a source although no USB device is connected.

- Change the source to any source other than USB/iPod. Connect a USB device, and change the source to USB again.

Disconnected (iPod, Bluetooth audio player)

The iPod/Bluetooth audio player is selected as a source although no iPod/Bluetooth audio player is connected.

- Change the source to any source other than iPod/Bluetooth. Connect an iPod/Bluetooth audio player, and change the source to iPod/Bluetooth again.

No Media file

The connected USB device contains no playable audio file. Media was played that doesn't have data recorded that the unit can play.

- See **Playable Media and Files (P.98)** and try another USB device.

USB device over current status detected.

The connected USB device is rated a current capacity higher than the allowable limit.

- Check the USB device. Some trouble may have occurred to the connected USB device.
- Change the source to any source other than USB. Remove the USB device.

 **SiriusXM**

Check Tuner

A SiriusXM tuner is not connected to this unit.

- Verify that the SiriusXM Connect Vehicle Tuner cable is securely connected to the radio.

Subscription Updated - Press Return To Continue

The SiriusXM subscription has been renewed.

- Pressing the Control knob will clear the message.

SXM Chan Unavailable

The currently selected channel is unavailable.

- Visit www.siriusxm.com for more information about the SiriusXM channel lineup.

SXM Ch Unsubscribed

The currently selected channel is not subscribed to.

- In the U.S.A., visit www.siriusxm.com or call 1-866-635-2349 if you have questions about your subscription package or would like to subscribe to this channel.
- In Canada, visit www.siriusxm.ca or call 1-877-438-9677.

SXM Check Antenna

No antenna is connected to the SiriusXM tuner.

- Check that an antenna is connected to the SiriusXM tuner. Check antenna for damages.

SXM No Signal

No SiriusXM radio signal is received.

- Verify that your vehicle is outdoors with a clear view of the sky.

Channel Locked

The selected channel has been locked by the parental controls.

- Enter the unlock code when you are asked. See **Parental Control (P.53)**.

Incorrect Pass Code entered

The selected channel is a mature or parental lock channel, and locked by the parental lock or user lock code.

- Enter the correct lock code.

Appendix

Playable Media and Files

You can play various kinds of media and files on this unit.

■ List of playable discs (DDX8905S/ DDX6905S/ DDX6705S)

Disc types / Standard		Support	Remark	
DVD	DVD Video	○		
	DVD Audio	×		
	DVD-VR	×		
	DVD-R*1	○	<ul style="list-style-type: none"> • MP3/ WMA/ AAC/ WAV/ FLAC/ Vorbis/ MPEG1/ MPEG2/ MPEG4/ H.264/ WMV/ MKV playback • Multi-border/Multisession playback (Playback depends on authoring conditions) 	
	DVD-RW	○		
	DVD+R	○		
	DVD+RW	○		
	DVD-R DL (Dual layer)	○	Only video format	
DVD+R DL (Double layer)	○			
	DVD-RAM	×		
CD	Music CD*1	○		
	CD-ROM	○	<ul style="list-style-type: none"> • MP3/ WMA/ AAC/ WAV/ FLAC/ Vorbis playback • Multisession is supported. • Packet write is not supported. 	
	CD-R	○		
	CD-RW	○		
		DTS-CD	×	
		Video CD (VCD)	○	
		Super video CD	×	
		Photo CD	×	
		CD-EXTRA	△	Only music CD session can be played.
		HDCD	△	Normal music CD sound quality
		CCCD	×	
Others	Dualdisc	×		
	Super audio CD	△	Only CD layer can be played.	

○ : Playback is possible.

△ : Playback is partly possible.

× : Playback is impossible.

*1 Incompatible with 8 cm (3 inch) discs.

■ Use of DualDisc

When playing a "DualDisc" on this unit, the surface of the disc that is not played may be scratched while the disc is inserted or ejected. Since the music CD surface does not conform to the CD standard, playback may be impossible.

(A "DualDisc" is a disc with one surface containing DVD standard signals and the other surface containing music CD signals.)

■ About disc format

The disc format should be the one of the following.

- ISO 9660 Level 1/2
- Joliet
- Romeo
- Long file name

About files

The following audio and video files are supported.

■ Playable Audio files

	Format	Bit rate	Sampling frequency	Bit count
AAC-LC (.m4a)	MPEG2/4 AAC LC HE-AAC(V1,V2)	8 – 320kbps, VBR	16 – 48 kHz	16 bit
MP3 (.mp3)	MPEG 1/2 Audio Layer 3	8 – 320kbps, VBR	16 – 48 kHz	16 bit
WMA (.wma)	Windows Media Audio Standard L3 profile (Version 7,8,9)	8 – 320kbps	16 – 48 kHz	16 bit
Linear PCM (WAVE) (.wav)	RIFF waveform Audio Format	–	16 – 48 kHz (Disc), 16 – 192 kHz (USB)	16/ 24 bit
FLAC (.flac)	flac	–	16 – 48 kHz (Disc), 16 – 192 kHz (USB)	16/ 24 bit
Vorbis (.ogg)	vorbis	VBR	16 – 48 kHz	16 bit
DSD (.dsf, .dff)	DSF, DSDIFF	–	2.8 MHz, 5.6 MHz, 11.2 MHz	1 bit

- If music of normal CD and other playback systems are recorded in the same disc, only the playback system recorded at the first setout is played.
- WMA and AAC of which is covered with DRM cannot be played.
- DSD sound is converted to PCM sound before playback.
- The EmChinks tag of DSDIFF is not supported.
- Although the audio files are complied with the standards listed above, the play may be impossible depending on the types or conditions of media or device.
- This unit supports playback of High-Resolution Audio files.
It is recommended that a car audio system should be configured with all High-Resolution Audio compatible products from player to speaker to enjoy its high quality sound.

■ Acceptable Video files

	Profile	Max. Picture size	Max. bit rate	Audio format
MPEG-1 (.mpg, .mpeg)	–	352 × 240, 352 × 288	1.5 Mbps	MPEG Audio Layer 2
MPEG-2 (.mpg, .mpeg)	MP@ML	720 × 480, 720 × 576	8 Mbps	MPEG Audio Layer 2
H.264/MPEG-4 AVC (.mp4, .m4v, .avi, .flv, .f4v)	Baseline Profile, Main Profile	1920 × 1080 (30 fps)	8 Mbps	MP3, AAC
MPEG-4 (.mp4, .avi)	Advanced Simple Profile	1920 × 1080 (30 fps)	8 Mbps	MP3, AAC
WMV (.wmv)	Main Profile	1920 × 1080 (30 fps)	8 Mbps	WMA
MKV (.mkv)	Video Format follows H.264/MPEG-4 AVC, MPEG-4, WMV			MP3, AAC, WMA, Vorbis, FLAC

- This unit can only play back files which are less than 4 GB.

■ Limitation of structure for the file and the folder

	Disc media	USB device
Maximum number of folder layers	8	8
Maximum number of files (per folder)	999	999
Maximum number of folders (per folder)	5000	9999
Maximum number of folders (per device)	5000	Unlimited

- You can enter a folder name and file name with 255 or fewer single-byte characters.
- Files in the folder whose folder name begins with a dot (.) cannot be played.

Region Codes in the World

The DVD players are given a region code according to the country or area it is marketed, as shown in the following map.

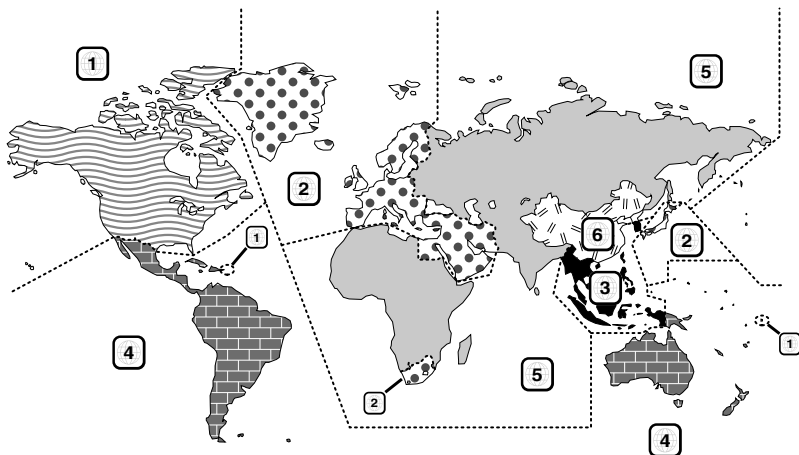

■ DVD disc marks



Indicates a region number. The discs with this mark can be played with any DVD player.



Indicates the number of audio languages recorded. Up to 8 languages can be recorded in a movie. You can select a favorite language.



Indicates the number of subtitled languages recorded. Up to 32 languages can be recorded.



If a DVD disc has scenes shot from multiple angles, you can select a favorite angle.

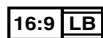

Indicates the type of screen for the image. The left mark indicates that a wide image picture (16:9) is displayed on a standard TV set screen (4:3) with a black band at both the top and bottom of the screen (letter box).

■ Operation regulatory marks

With this DVD, some functions of this unit such as the play function may be restricted depending on the location where the DVD is playing. In this case, the following marks will appear on the screen. For more information, refer to the disc manual.



■ Discs with limited period of use

Do not leave discs with a limited period of use in this unit. If you load an already expired disc, you may not be able to remove it from this unit.

DVD Language Codes

Code	Language
aa	Afar
ab	Abkhazian
af	Afrikaans
am	Amharic
ar	Arabic
as	Assamese
ay	Aymara
az	Azerbaijani
ba	Bashkir
be	Byelorussian
bg	Bulgarian
bh	Bihari
bi	Bislama
bn	Bengali, Bangla
bo	Tibetan
br	Breton
ca	Catalan
co	Corsican
cs	Czech
cy	Welsh
da	Danish
de	German
dz	Bhutani
el	Greek
en	English
eo	Esperanto
es	Spanish
et	Estonian
eu	Basque
fa	Persian
fi	Finnish
fj	Fiji
fo	Faroese
fr	French
fy	Frisian
ga	Irish
gd	Scots Gaelic
gl	Galician
gn	Guarani
gu	Gujarati
ha	Hausa
he	Hebrew
hi	Hindi
hr	Croatian
hu	Hungarian
hy	Armenian

Code	Language
ia	Interlingua
ie	Interlingue
ik	Inupiak
id	Indonesian
is	Icelandic
it	Italian
ja	Japanese
jv	Javanese
ka	Georgian
kk	Kazakh
kl	Greenlandic
km	Cambodian
kn	Kannada
ko	Korean
ks	Kashmiri
ku	Kurdish
ky	Kirghiz
la	Latin
lb	Luxembourgish
ln	Lingala
lo	Laotian
lt	Lithuanian
lv	Latvian, Lettish
mg	Malagasy
mi	Maori
mk	Macedonian
ml	Malayalam
mn	Mongolian
mo	Moldavian
mr	Marathi
ms	Malay
mt	Maltese
my	Burmese
na	Nauru
ne	Nepali
nl	Dutch
no	Norwegian
oc	Occitan
om	(Afan) Oromo
or	Oriya
pa	Punjabi
pl	Polish
ps	Pashto, Pushto
pt	Portuguese
qu	Quechua
rm	Rhaeto-Romance

Code	Language
rn	Kirundi
ro	Romanian
ru	Russian
rw	Kinyarwanda
sa	Sanskrit
sd	Sindhi
sg	Sangho
sh	Serbo-Croatian
si	Singhalese
sk	Slovak
sl	Slovenian
sm	Samoan
sn	Shona
so	Somali
sq	Albanian
sr	Serbian
ss	Siswati
st	Sesotho
su	Sundanese
sv	Swedish
sw	Swahili
ta	Tamil
te	Telugu
tg	Tajik
th	Thai
ti	Tigrinya
tk	Turkmen
tl	Tagalog
tn	Setswana
to	Tongan
tr	Turkish
ts	Tsonga
tt	Tatar
tw	Twi
uk	Ukrainian
ur	Urdu
uz	Uzbek
vi	Vietnamese
vo	Volapuk
wo	Wolof
xh	Xhosa
yo	Yoruba
zh	Chinese
zu	Zulu

Specifications

■ Monitor section

Picture Size

- DDX8905S/ DMX7705S
- : 6.95 inches (diagonal) wide
- : 156.6 mm (W) × 81.6 mm (H)
- 6-3/16 × 3-3/16 inch
- DDX6905S/ DDX6705S;
- : 6.75 inches (diagonal) wide
- : 151.8 mm (W) × 79.6 mm (H)
- 5-31/32 × 3-1/8 inch

Display System

- : TN LCD panel

Drive System

- : TFT active matrix system

Number of Pixels

- : 1,152,000 (800H x 480V x RGB)

Effective Pixels

- : 99.99 %

Pixel Arrangement

- : RGB striped arrangement

Back Lighting

- : LED

■ DVD player section

(DDX8905S/ DDX6905S/ DDX6705S)

D/A Converter

- : 24/ 32 bit

Audio Decoder

- : Linear PCM/ Dolby Audio/ MP3/ WMA/ AAC/ WAV/
- FLAC/ Vorbis

Video Decoder

- : MPEG1/ MPEG2/ MPEG4/ WMV/ H.264/ MKV

Wow & Flutter

- : Below Measurable Limit

Frequency Response

- 96 kHz : 20 – 44,000 Hz
- 48 kHz : 20 – 22,000 Hz
- 44.1 kHz : 20 – 20,000 Hz

Total Harmonic Distortion

- : 0.010 % (1 kHz)

S/N Ratio (dB)

- : 90.5 dB

Dynamic Range

- : 89 dB

Disc Format

- : DVD-Video/ VIDEO-CD/ CD-DA

Quantifying Bit Number

- : 16/ 20/ 24 bit

■ USB interface section

USB Standard

- : USB 2.0 High Speed

File System

- : FAT 16/ 32, exFAT, NTFS

Maximum Power Supply Current

- DDX8905S/ DDX6905S/ DMX7705S
- : DC 5 V $\overline{\text{DC}}$ 1.5 A × 2
- DDX6705S : DC 5 V $\overline{\text{DC}}$ 1.5 A

D/A Converter

- : 24/ 32 bit

Audio Decoder

- : MP3/ WMA/ AAC/ WAV/ FLAC/ Vorbis/ DSD

Video Decoder

- : MPEG1/ MPEG2/ MPEG4/ WMV/ H.264/ MKV

Frequency Response (DMX7705S)

- 192 kHz : 20 – 88,000 Hz
- 96 kHz : 20 – 44,000 Hz
- 48 kHz : 20 – 22,000 Hz
- 44.1 kHz : 20 – 20,000 Hz

Total Harmonic Distortion (DMX7705S)

- : 0.0001 % (1 kHz)

S/N Ratio (dB) (DMX7705S)

- : 98.5 dB

Dynamic Range (DMX7705S)

- : 89 dB

■ Bluetooth section

Technology

- : Bluetooth Ver.3.0

Frequency

- : 2.402 – 2.480 GHz

Output Power

- : +4dBm (MAX), 0dBm (AVE), Power Class2

Maximum Communication range

- : Line of sight approx. 10m (32.8 ft)

Audio Codec

- : SBC/ AAC

Profile (Multi Profile support)

- HFP (V1.6) (Hands Free Profile)
- SPP (Serial Port Profile)
- A2DP (Advanced Audio Distribution Profile)
- AVRCP (V1.5) (Audio/Video Remote Control Profile)
- PBAP (Phonebook Access Profile)

■ DSP section

Graphics equalizer

Band: 13 Band
 Frequency (BAND1 – 13)
 : 62.5/ 100/ 160/ 250/ 400/ 630/ 1k/ 1.6k/ 2.5k/ 4k/
 6.3k/ 10k/ 16k Hz

Gain

: -9/-8/-7/-6/-5/-4/-3/-2/-1/0/1/2/3/4/5/6/7/8/9 dB

2Way X'Over

High pass filter

Frequency: Through, 30/ 40/ 50/ 60/ 70/ 80/ 90/ 100/
 120/ 150/ 180/ 220/ 250 Hz

Slope: -6/-12/-18/-24 dB/Oct.

Low pass filter

Frequency: 30/ 40/ 50/ 60/ 70/ 80/ 90/ 100/ 120/
 150/ 180/ 220/ 250 Hz, Through

Slope: -6/-12/-18/-24 dB/Oct.

Position

Front / Rear /Subwoofer Delay

: 0 – 20.01 ft (0.03 or 0.04 ft Step)

Gain

: -8 – 0 dB

Subwoofer level

: -50 – +10 dB

■ Digital FM tuner section (DDX8905S)

Frequency Range (step)

: 87.9 MHz – 107.9 MHz (200 kHz)

Frequency Response (± 3.0 dB)

: 20 Hz – 20 kHz

S/N Ratio

: 80 dB (STEREO)

■ Digital AM tuner section (DDX8905S)

Frequency Range (step)

: 530 kHz – 1700 kHz (10 kHz)

Frequency Response (± 3.0 dB)

: 40 Hz – 15 kHz

S/N Ratio (dB)

: 80 dB (STEREO)

■ FM tuner section

Frequency Range (step)

: 87.9 MHz – 107.9 MHz (200 kHz)

Usable Sensitivity (S/N : 30 dB)

: 9.3 dBf (0.8 μ V/ 75 Ω)

Quieting Sensitivity (S/N : 46 dB)

: 10.2 dBf (1.13 μ V/ 75 Ω)

Frequency Response

: 30 Hz – 15 kHz

S/N Ratio (dB)

: 75 dB (MONO)

Selectivity (± 400 kHz)

: Over 80 dB

Stereo Separation

: 45 dB (1 kHz)

■ AM tuner section

Frequency Range (step)

: 530 kHz – 1700 kHz (10 kHz)

Usable Sensitivity

: 28 dB μ

■ Video section

Color System of External Video Input

: NTSC

External Video Input Level (mini jack)

: 1 V_{p-p}/ 75 Ω

External Audio Max Input Level (mini jack)

: 2 V/ 25 k Ω

Video Input Level (RCA jacks)

: 1 V_{p-p}/ 75 Ω

Video Output Level (RCA jacks)

: 1 V_{p-p}/ 75 Ω

Audio Output Level (mini jack)

: 1.2 V/ 10 k Ω

Appendix

■ Audio section

Maximum Power (Front & Rear)

: 50 W × 4

Typical Power Output (Front & Rear)

Full Bandwidth Power (at less than 1% THD)

: 22 W × 4

Output frequency band

: 20 – 88,000 Hz

Preout Level (V)

DDX8905S/ DDX6905S

: 5 V / 10 k Ω

DDX6705S/ DMX7705S

: 4 V / 10 k Ω

Preout Impedance

: \leq 300 Ω

Speaker Impedance

: 4 – 8 Ω

■ General

Operating Voltage

: 14.4 V (10.5 – 16 V allowable)

Maximum Current Consumption

: 15 A

Installation Dimensions (W × H × D)

DDX8905S

: 178 × 100 × 160 mm

7 × 3-15/16 × 6-5/16 inch

DDX6905S/ DDX6705S/ DMX7705S

: 178 × 100 × 155 mm

7 × 3/16 × 4-7/16 × 6-2/16 inch

With Sleeve

DDX8905S

: 182 × 112 × 163 mm

7-3/16 × 4-7/16 × 6-7/16 inch

DDX6905S

: 182 × 112 × 153 mm

7-3/16 × 4-7/16 × 6 inch

Operational Temperature Range

: -10 °C – +60 °C

Weight

DDX8905S

: 2.4 kg (5.3 lbs)

DDX6905S/ DDX6705S

: 2.1 kg (4.6 lbs)

DMX7705S

: 1.7 kg (3.8 lbs)

NOTE

- Although the effective pixels for the liquid crystal panel is given as 99.99% or more, 0.01% of pixels may not light or may light incorrectly.

Specifications subject to change without notice.

About this Unit

■ Copyrights

- The Bluetooth® word mark and logos are registered trademarks owned by Bluetooth SIG, Inc. and any use of such marks by JVC KENWOOD Corporation is under license. Other trademarks and trade names are those of their respective owners.
- Manufactured under license from Dolby Laboratories. Dolby, Dolby Audio and the double-D symbol are trademarks of Dolby Laboratories.
-  is a trademark of DVD Format/Logo Licensing Corporation registered in the U.S., Japan and other countries.
- This item incorporates copy protection technology that is protected by U.S. patents and other intellectual property rights of Rovi Corporation. Reverse engineering and disassembly are prohibited.
- Microsoft and Windows Media are either registered trademarks or trademarks of Microsoft Corporation in the United States and/or other countries.
- This software is based in part on the work of the independent JPEG Group.
- The "AAC" logo is a trademark of Dolby Laboratories.
- "Made for iPod" and "Made for iPhone" mean that an electronic accessory has been designed to connect specifically to iPod, or iPhone, respectively, and has been certified by the developer to meet Apple performance standards. Apple is not responsible for the operation of this device or its compliance with safety and regulatory standards. Please note that the use of this accessory with iPod, or iPhone may affect wireless performance.
- iPhone, iPod, and iPod touch are trademarks of Apple Inc., registered in the U.S. and other countries.
- Apple, Siri, Apple CarPlay and Apple CarPlay logo are trademarks of Apple Inc., registered in the U.S. and other countries. Lightning is a trademark of Apple Inc.
- Sirius, XM and all related marks and logos are trademarks of Sirius XM Radio Inc. All rights reserved.
- HD Radio Technology manufactured under license from iBiquity Digital Corporation. U.S. and Foreign Patents. HD Radio™ and the HD, HD Radio, and "Arc" logos are proprietary trademarks of iBiquity Digital Corp.
- INRIX is a registered trademark of INRIX, Inc.
- PANDORA, the PANDORA logo, and the Pandora trade dress are trademarks or registered trademarks of Pandora Media, Inc., used with permission.
- SPOTIFY and the Spotify logo are among the registered trademarks of Spotify AB.
- Android, Android Auto, Google Play and other marks are trademarks of Google LLC.
- WebLink™ is a trademark of Abalta Technologies, Inc.
- This License does not grant permission to use the

trade names, trademarks, service marks, or product names of the Licensor (Abalta Technologies, Inc.), except as required for reasonable and customary use in describing the origin of the ****WEBLINK Product****.

- Waze and Waze logo are registered trademarks of Google LLC.
- YouTube and the YouTube logo are registered trademarks of Google LLC.
- BlackBerry®, RIM®, Research In Motion® and related trademarks, names and logos are the property of Research In Motion Limited and are registered and/or used in the U.S. and countries around the world. Used under license from Research In Motion Limited.
- This product includes FontAvenue® fonts licenced by NEC Corporation. FontAvenue is a registered trademark of NEC Corporation.



- This product includes "Ubiquitous QuickBoot TM" technology developed by Ubiquitous Corp. Ubiquitous QuickBoot TM is a trademark of Ubiquitous Corp. Copyright© 2017 Ubiquitous Corp. All rights reserved.



- THIS PRODUCT IS LICENSED UNDER THE AVC PATENT PORTFOLIO LICENSE FOR THE PERSONAL USE OF A CONSUMER OR OTHER USES IN WHICH IT DOES NOT RECEIVE REMUNERATION TO (i) ENCODE VIDEO IN COMPLIANCE WITH THE AVC STANDARD ("AVC VIDEO") AND/OR (ii) DECODE AVC VIDEO THAT WAS ENCODED BY A CONSUMER ENGAGED IN A PERSONAL ACTIVITY AND/OR WAS OBTAINED FROM A VIDEO PROVIDER LICENSED TO PROVIDE AVC VIDEO. NO LICENSE IS GRANTED OR SHALL BE IMPLIED FOR ANY OTHER USE. ADDITIONAL INFORMATION MAY BE OBTAINED FROM MPEG LA, L.L.C. SEE [HTTP://WWW.MPEGLA.COM](http://www.mpegla.com)
- THIS PRODUCT IS LICENSED UNDER THE MPEG-4 VISUAL PATENT PORTFOLIO LICENSE FOR THE PERSONAL AND NON-COMMERCIAL USE OF A CONSUMER FOR (i) ENCODING VIDEO IN COMPLIANCE WITH THE MPEG-4 VISUAL STANDARD ("MPEG-4 VIDEO") AND/OR (ii) DECODING MPEG-4 VIDEO THAT WAS ENCODED BY A CONSUMER ENGAGED IN A PERSONAL AND NON-COMMERCIAL ACTIVITY AND/OR WAS OBTAINED FROM A VIDEO PROVIDER LICENSED BY MPEG LA TO PROVIDE MPEG-4 VIDEO. NO LICENSE IS GRANTED OR SHALL BE IMPLIED FOR ANY OTHER USE. ADDITIONAL INFORMATION INCLUDING THAT RELATING TO PROMOTIONAL, INTERNAL AND COMMERCIAL USES AND LICENSING MAY BE OBTAINED FROM MPEG LA, LLC. SEE [HTTP://WWW.MPEGLA.COM](http://www.mpegla.com).
- THIS PRODUCT IS LICENSED UNDER THE VC-1 PATENT PORTFOLIO LICENSE FOR THE PERSONAL AND NON-COMMERCIAL USE OF A CONSUMER TO (i) ENCODE VIDEO IN COMPLIANCE WITH THE VC-1 STANDARD ("VC-1 VIDEO") AND/OR (ii) DECODE VC-1 VIDEO

THAT WAS ENCODED BY A CONSUMER ENGAGED IN A PERSONAL AND NON-COMMERCIAL ACTIVITY AND/OR WAS OBTAINED FROM A VIDEO PROVIDER LICENSED TO PROVIDE VC-1 VIDEO. NO LICENSE IS GRANTED OR SHALL BE IMPLIED FOR ANY OTHER USE. ADDITIONAL INFORMATION MAY BE OBTAINED FROM MPEG LA, L.L.C. SEE [HTTP://WWW.MPEGLA.COM](http://www.mpegla.com)

- libFLAC
Copyright (C) 2000-2009 Josh Coalson
Copyright (C) 2011-2013 Xiph.Org Foundation
Redistribution and use in source and binary forms, with or without modification, are permitted provided that the following conditions are met:
 - Redistributions of source code must retain the above copyright notice, this list of conditions and the following disclaimer.
 - Redistributions in binary form must reproduce the above copyright notice, this list of conditions and the following disclaimer in the documentation and/or other materials provided with the distribution.
 - Neither the name of the Xiph.org Foundation nor the names of its contributors may be used to endorse or promote products derived from this software without specific prior written permission.
- THIS SOFTWARE IS PROVIDED BY THE COPYRIGHT HOLDERS AND CONTRIBUTORS "AS IS" AND ANY EXPRESS OR IMPLIED WARRANTIES, INCLUDING, BUT NOT LIMITED TO, THE IMPLIED WARRANTIES OF MERCHANTABILITY AND FITNESS FOR A PARTICULAR PURPOSE ARE DISCLAIMED. IN NO EVENT SHALL THE FOUNDATION OR CONTRIBUTORS BE LIABLE FOR ANY DIRECT, INDIRECT, INCIDENTAL, SPECIAL, EXEMPLARY, OR CONSEQUENTIAL DAMAGES (INCLUDING, BUT NOT LIMITED TO, PROCUREMENT OF SUBSTITUTE GOODS OR SERVICES; LOSS OF USE, DATA, OR PROFITS; OR BUSINESS INTERRUPTION) HOWEVER CAUSED AND ON ANY THEORY OF LIABILITY, WHETHER IN CONTRACT, STRICT LIABILITY, OR TORT (INCLUDING NEGLIGENCE OR OTHERWISE) ARISING IN ANY WAY OUT OF THE USE OF THIS SOFTWARE, EVEN IF ADVISED OF THE POSSIBILITY OF SUCH DAMAGE.
- libvorbis
Copyright (c) 2002-2008 Xiph.org Foundation
Redistribution and use in source and binary forms, with or without modification, are permitted provided that the following conditions are met:
 - Redistributions of source code must retain the above copyright notice, this list of conditions and the following disclaimer.
 - Redistributions in binary form must reproduce the above copyright notice, this list of conditions and the following disclaimer in the documentation and/or other materials provided with the distribution.
 - Neither the name of the Xiph.org Foundation nor the names of its contributors may be used to endorse or promote products derived from this

software without specific prior written permission. THIS SOFTWARE IS PROVIDED BY THE COPYRIGHT HOLDERS AND CONTRIBUTORS "AS IS" AND ANY EXPRESS OR IMPLIED WARRANTIES, INCLUDING, BUT NOT LIMITED TO, THE IMPLIED WARRANTIES OF MERCHANTABILITY AND FITNESS FOR A PARTICULAR PURPOSE ARE DISCLAIMED. IN NO EVENT SHALL THE FOUNDATION OR CONTRIBUTORS BE LIABLE FOR ANY DIRECT, INDIRECT, INCIDENTAL, SPECIAL, EXEMPLARY, OR CONSEQUENTIAL DAMAGES (INCLUDING, BUT NOT LIMITED TO, PROCUREMENT OF SUBSTITUTE GOODS OR SERVICES; LOSS OF USE, DATA, OR PROFITS; OR BUSINESS INTERRUPTION) HOWEVER CAUSED AND ON ANY THEORY OF LIABILITY, WHETHER IN CONTRACT, STRICT LIABILITY, OR TORT (INCLUDING NEGLIGENCE OR OTHERWISE) ARISING IN ANY WAY OUT OF THE USE OF THIS SOFTWARE, EVEN IF ADVISED OF THE POSSIBILITY OF SUCH DAMAGE.

- libogg
Copyright (c) 2002, Xiph.org Foundation
Redistribution and use in source and binary forms, with or without modification, are permitted provided that the following conditions are met:
 - Redistributions of source code must retain the above copyright notice, this list of conditions and the following disclaimer.
 - Redistributions in binary form must reproduce the above copyright notice, this list of conditions and the following disclaimer in the documentation and/or other materials provided with the distribution.
 - Neither the name of the Xiph.org Foundation nor the names of its contributors may be used to endorse or promote products derived from this software without specific prior written permission.

THIS SOFTWARE IS PROVIDED BY THE COPYRIGHT HOLDERS AND CONTRIBUTORS "AS IS" AND ANY EXPRESS OR IMPLIED WARRANTIES, INCLUDING, BUT NOT LIMITED TO, THE IMPLIED WARRANTIES OF MERCHANTABILITY AND FITNESS FOR A PARTICULAR PURPOSE ARE DISCLAIMED. IN NO EVENT SHALL THE FOUNDATION OR CONTRIBUTORS BE LIABLE FOR ANY DIRECT, INDIRECT, INCIDENTAL, SPECIAL, EXEMPLARY, OR CONSEQUENTIAL DAMAGES (INCLUDING, BUT NOT LIMITED TO, PROCUREMENT OF SUBSTITUTE GOODS OR SERVICES; LOSS OF USE, DATA, OR PROFITS; OR BUSINESS INTERRUPTION) HOWEVER CAUSED AND ON ANY THEORY OF LIABILITY, WHETHER IN CONTRACT, STRICT LIABILITY, OR TORT (INCLUDING NEGLIGENCE OR OTHERWISE) ARISING IN ANY WAY OUT OF THE USE OF THIS SOFTWARE, EVEN IF ADVISED OF THE POSSIBILITY OF SUCH DAMAGE.

■ FCC WARNING

This equipment may generate or use radio frequency energy. Changes or modifications to this equipment may cause harmful interference unless the modifications are expressly approved in the instruction manual. The user could lose the authority to operate this equipment if an unauthorized change or modification is made.

NOTE

- This equipment has been tested and found to comply with the limits for a Class B digital device, pursuant to Part 15 of the FCC Rules. These limits are designed to provide reasonable protection against harmful interference in a residential installation.
- This equipment may cause harmful interference to radio communications, if it is not installed and used in accordance with the instructions. However, there is no guarantee that interference will not occur in a particular installation. If this equipment does cause harmful interference to radio or television reception, which can be determined by turning the equipment off and on, the user is encouraged to try to correct the interference by one or more of the following measures:
 - Reorient or relocate the receiving antenna.
 - Increase the separation between the equipment and receiver.
 - Connect the equipment into an outlet on a circuit different from that to which the receiver is connected.
 - Consult the dealer or an experienced radio/TV technician for help.

▲ CAUTION

Use of controls or adjustments or performance of procedures other than those specified herein may result in hazardous radiation exposure.

In compliance with Federal Regulations, following are reproductions of labels on, or inside the product relating to laser product safety.

JVC KENWOOD Corporation
2967-3, ISHIKAWA-MACHI,
HACHIOJI-SHI, TOKYO, JAPAN

THIS PRODUCT COMPLIES WITH DHHS RULES
21 CFR SUBCHAPTER J IN EFFECT AT DATE OF
MANUFACTURE.

Location: Top plate

This transmitter must not be co-located or operated in conjunction with any other antenna or transmitter.

■ IC (Industry Canada) Notice

This device complies with Industry Canada licence-exempt RSS standard(s).

Operation is subject to the following two conditions:

- (1) This device may not cause interference, and
- (2) this device must accept any interference, including interference that may cause undesired operation of the device.

▲ CAUTION

This equipment complies with FCC/IC radiation exposure limits set forth for an uncontrolled environment and meets the FCC radio frequency (RF) Exposure Guidelines and RSS-102 of the IC radio frequency (RF) Exposure rules. This equipment has very low levels of RF energy that is deemed to comply without maximum permissive exposure evaluation (MPE). But it is desirable that it should be installed and operated keeping the radiator at least 20 cm or more away from person's body.

- Contains Transmitter Module
- FCC ID: ZWY8811X
- Contains Transmitter Module
- IC: 12033A-8811X

■ CALIFORNIA, USA

This product contains a CR Coin Cell Lithium Battery which contains Perchlorate Material – special handling may apply.

See www.dtsc.ca.gov/hazardouswaste/perchlorate.

■ Información acerca de la eliminación de equipos eléctricos y electrónicos al final de la vida útil (aplicable a los países que hayan adoptado sistemas independientes de recogida de residuos)



Los productos con el símbolo de un contenedor con ruedas tachado no podrán ser desechados como residuos domésticos.

Los equipos eléctricos y electrónicos al final de la vida útil, deberán ser reciclados en instalaciones que puedan dar el tratamiento adecuado a estos productos y a sus subproductos residuales correspondientes. Póngase en contacto con su administración local para obtener información sobre el punto de recogida más cercano. Un tratamiento correcto del reciclaje y la eliminación de residuos ayuda a conservar los recursos y evita al mismo tiempo efectos perjudiciales en la salud y el medio ambiente.

■ Informação sobre a eliminação de pilhas

Este produto não deve ser eliminado como lixo doméstico geral. Devolva a pilha usada ao revendedor ou entidade autorizada para que a mesma seja devolvida ao fabricante ou importador.

A reciclagem e a eliminação de lixo de maneira apropriada ajudarão a conservar os recursos naturais ao mesmo tempo que prevenirão os efeitos prejudiciais à nossa saúde e ao meio ambiente.

■ Para cumplimiento de la IFT:

“La operación de este equipo esta sujeta a las siguientes dos condiciones:

- (1) es posible que este equipo o dispositivo no cause interferencia perjudicial y
- (2) este equipo o dispositivo debe aceptar cualquier interferencia,

incluyendo la que pueda causar su operación no deseada.”

 Spotify®  waze  YouTube **android
auto**

 Bluetooth®  WebLink™







 **SiriusXM** READY  DOLBY AUDIO™

 DVD VIDEO™  Designed for Windows Media™  pandora®

Made for
 iPod  iPhone

 Works with
Apple CarPlay

 **Radio**®
This HD Radio receiver enables:

-  HD2/HD3
-  Bookmark
-  Digital Sound
-  Program Info
-  Artist Experience
-  Emergency Alerts

KENWOOD

MILITARY

Units purchased through the U.S.A. military exchange service overseas may be serviced under warranty in the continental U.S.A., subject to the following conditions.

- 1) The original warranty is in effect.
- 2) Proof of purchase is provided to the servicer.

WARRANTY FOR MILITARY MARKET

Kenwood corporation is proud of the quality and workmanship of its audio equipment. This unit has been properly designed, tested and inspected before it was shipped to you. If properly installed and operated in accordance with instructions furnished, it should give you an optimum reliable performance.

WARRANTY PERIOD

This product is warranted for a period of (1) year from the date of the original purchase.

SCOPE OF WARRANTY

Except as specified below, this warranty covers all defects in materials and workmanship of the Kenwood brand products.

During the warranty period, any authorized Kenwood Service Center in the military market listed in the back of this warranty card will provide you free-of-charge both parts and labor required to correct any defect in materials or workmanship.

The following are not covered by this warranty.

1. Voltage conversions.
2. Periodic check-ups which do not disclose any defect covered by the warranty.
3. Cabinets, grilles, other exterior finishes, bells, tape heads, and other non-durable parts and accessories.
4. Units on which the serial number has been effaced, modified or removed.
5. Installation and/or removal charges.
6. Damaged magnetic tapes.
7. House call charges for any repairs.
8. Shipping or delivery charges to or from an authorized Kenwood Service Center.
9. This warranty will not cover any failure that is due to any of the following conditions in accordance with the visual inspection of the authorized Kenwood Service Center:

* Improper maintenance or repair, including the installation of parts or accessories that do not conform to the quality and specifications of the original parts.

* Misuse, abuse, neglect, unauthorized product modification or failure to follow instructions contained in the Owner's Manual.

* Accidental or intentional damages.

* Repairs or attempted repairs by an unauthorized agency. (All repairs must be performed at an authorized Kenwood Service Center.)

* Damages or deteriorations caused during shipment (Claims must be presented to the carrier).

* Damages or deteriorations resulting from removal and/or replacement.

PURCHASER'S RESPONSIBILITIES

As the purchaser of a new Kenwood brand product, you are requested to do the following in order to obtain Kenwood warranty service.

1. Retain your sales slip or other evidence of purchase for proving your eligibility for requesting Kenwood warranty service.
2. Make your unit available to an authorized Kenwood Service Center in the military market for inspection and approved warranty service, or ship your unit in its original carton box or equivalent, fully insured and shipping charges prepaid, to the authorized Kenwood Service Center.

LIMITATION OF IMPLIED WARRANTIES

Any and all implied warranties, including warranties of merchantability and fitness for a particular purpose, shall be limited in duration to the length of this warranty.

EXCLUSION OF CERTAIN DAMAGES

KENWOOD's liability for any defective product is limited to the repair or replacement of said product, at our option, and shall not include damages of any kind, whether incidental, consequential or otherwise, except to the extent prohibited by applicable law.

KENWOOD AUTHORIZED SERVICE CENTERS IN MILITARY MARKET

JAPAN:

Yokota

Kenwood Rep.; c/o

Yokota BX, JAAX AAFES-PAC,

APO San Francisco 96328

Zama

Kenwood Rep.; c/o

Zama PX, JAAX AAFES-PAC,

APO San Francisco 96343

Misawa

Kenwood Rep.; c/o

Misawa BX, JAAX AAFES-PAC,

APO San Francisco 96519

Yokosuka

Kenwood Rep.; c/o

A-33, Yokosuka NEX No. 260-010

FPO Seattle 98760

Atsugi

Kenwood Rep.; c/o

Atsugi NEX No. 260-020 FPO Seattle

98767

Iwakuni

Kenwood Rep.; c/o

Marine Corps Exchange, Marine Corps

Air Station,

FPO Seattle 98764

Sasebo

Sasebo NEX;

Navy Exchange 260-040

F.A. Box 115 FPO Seattle 98766

Okinawa

Kenwood Rep.; c/o

OWAX, AAFES-PAC, APO San Francisco

96230

KOREA:

Kenwood Rep.; c/o

KOAX Repair Shop, AAFES-PAC

DD-Camp Market, APO San Francisco

96488

GUAM:

Kenwood Rep.; c/o

Guam NEX No. 230-010,

FPO San Francisco 96630

Kenwood Rep.; c/o

GUAX, AAFES-PAC, APO San Francisco

96334

U.S.A.:

In The Continental U.S.A.

For Nearest Authorized Service Center;

Tel: 1-800-536-9663

www.us.jvckenwood.com

EUROPE:

Please inquire at the military resale

outlets where you bought your

Kenwood products, or

JVCKENWOOD DEUTSCHLAND GMBH:

Konrad-Adenauer Allee 1-11, 61118 Bad

Vilbel, Germany

KENWOOD

Warranty Card

Identification du produit
Modelo do aparelho e numero de série
Model number & serial number

Revendeur & cachet
Nome da loja e carimbo
Dealer & stamp

Date d'achat
Data da compra
Purchase date

Nom & adresse du client
Nome e endereço do cliente
Name & address of customer

Attention:

This card and receipt (or invoice) are necessary to purchase a new panel in case of theft or damage.

Attention:

Vous aurez besoin de cette carte et du reçu (ou de la facture) pour acheter un nouveau panneau en cas de vol ou d'endommagement.

Atenção:

Em caso de dano ou perda do painel frontal, este Certificado de Garantia e a Nota Fiscal de compra serão requisitados para a aquisição de um novo painel.

© B46-0824-00/03 (K) (15/03)

Dear Customer,

Thank you for purchasing this Kenwood product. As mentioned in the pages of this booklet, our warranty is only valid in the countries listed. If your country is not listed please contact your retailer for information on warranty procedure, or write to:

JVC KENWOOD Customer Information Center

3-12, Moriyacho, Kanagawa-ku, Yokohama-shi, Kanagawa 221-0022, Japan

U.S.A.

JVCKENWOOD USA Corporation

This warranty will be honored only in the U.S.A.

KENWOOD LIMITED WARRANTY FOR CAR STEREO COMPONENTS

HOW LONG IS THE WARRANTY

Kenwood U.S.A. Corporation ("Kenwood") warrants this product for a period of one (1) year from the date of original purchase.

WHAT IS COVERED AND WHAT IS NOT COVERED

Except as specified below, this warranty covers all defects in material and workmanship in Kenwood car stereo components. The following are not covered by the warranty:

- Any product which is not distributed in the U.S.A. by Kenwood or which is not purchased in the U.S.A. from an authorized Kenwood car stereo dealer or an automobile dealer, unless the product is purchased through the U.S.A Military Exchange Service.
- Any product on which the serial number has been defaced, modified or removed.
- Damage, deterioration or malfunction resulting from:
 - Any shipment of the product (claims must be presented to the carrier).
 - Installation or removal of the product.
 - Accident, acts of nature, misuse, abuse, neglect, unauthorized product modification or failure to follow instructions supplied with the product.
 - Repair or attempted repair by anyone not authorized by Kenwood.
 - Any other cause which does not relate to a product defect.

WHO IS PROTECTED

This warranty is enforceable only by the original purchaser.

WHAT WE WILL PAY FOR

We will pay for all labor and material expenses for covered items. Payment of shipping charges is discussed in the next section of this warranty.

HOW TO OBTAIN WARRANTY SERVICE

If your KENWOOD product ever needs service:

- Take or ship it to any KENWOOD Authorized Service Center in the U.S.A. along with a complete description of the problem. (If you are uncertain as to whether a Service Center is authorized, please call 1-800-KENWOOD for the nearest Service Center. 1-800-536-9663).
- Although you must pay any shipping charges if it is necessary to ship the product for warranty service, we will pay the return shipping charges if the repairs are covered by the warranty within the United States.
- Whenever your units are taken or sent for warranty service, you must include a copy of the original dated sales receipt as proof of warranty coverage.

LIMITATION OF IMPLIED WARRANTIES

ALL IMPLIED WARRANTIES, INCLUDING WARRANTIES OF MERCHANTABILITY AND FITNESS FOR A PARTICULAR PURPOSE, ARE LIMITED IN DURATION TO THE LENGTH OF THIS WARRANTY.

EXCLUSION OF DAMAGES

KENWOOD'S LIABILITY FOR ANY DEFECTIVE PRODUCT IS LIMITED TO THE REPAIR OR REPLACEMENT OF THE PRODUCT AT OUR OPTION. KENWOOD SHALL NOT BE LIABLE FOR:

- INSTALLATION OR REMOVAL CHARGES, DAMAGE TO OTHER PROPERTY CAUSED BY ANY DEFECTS IN KENWOOD CAR STEREO COMPONENTS, DAMAGES BASED UPON INCONVENIENCE, LOSS OF USE OF THE PRODUCT, OR
 - ANY OTHER DAMAGES, WHETHER INCIDENTAL, CONSEQUENTIAL OR OTHERWISE.
- SOME STATES DO NOT ALLOW LIMITATIONS ON HOW LONG AN IMPLIED WARRANTY LASTS AND/OR DO NOT ALLOW THE EXCLUSION OR LIMITATION OF INCIDENTAL OR CONSEQUENTIAL DAMAGES, SO THE ABOVE LIMITATIONS AND EXCLUSIONS MAY NOT APPLY TO YOU.

This warranty gives you specific legal rights, and you may also have other rights which vary from state to state.

If a problem develops during or after the Limited Warranty Period, or if you have any questions regarding the operation of the product, you should contact your KENWOOD Authorized Dealer or Authorized Service Center. If the problem or your question is not handled to your satisfaction, please contact our Customer Relations Department at the address listed below:

**JVCKENWOOD USA Corporation
PO Box 22745, 2201 E. Dominguez St.
Long Beach, CA 90810-5745
Tel: (800) 536-9663
www.us.jvckenwood.com**

BRASIL

JVC KENWOOD DO BRASIL COMÉRCIO DE ELETRÔNICOS LTDA

O fabricante garante o produto identificado na Nota Fiscal de venda ao consumidor contra qualquer defeito de fabricação ou de matéria-prima durante o período de garantia. Esta garantia é válida no território brasileiro desde que o produto tenha sido adquirido no Brasil e distribuído pela JVC KENWOOD do Brasil Comércio de Eletrônicos Ltda.

PERÍODO DE GARANTIA

Este produto é garantido pelo prazo de 01 (um) ano, incluindo o período estabelecido por lei, a partir da data de aquisição, comprovada mediante a apresentação da respectiva Nota Fiscal de venda ao consumidor final. Eventuais reparos realizados no produto durante o período de garantia não implicam na dilatação do seu prazo.

EXCLUSÃO DA GARANTIA

- Produtos com o número de série ou certificado de garantia rasurados, adulterados ou ilegíveis;
- Defeitos resultantes de acidentes (quedas, batidas e etc), uso em desacordo com o manual de instruções, má utilização, ligação à fonte de tensão diferente da especificada no Manual de Instruções, modificações não autorizadas;
- Danos causados por agentes da natureza (Ex: chuvas, raios, maresia, enchentes e etc);
- Defeitos ou danos em decorrência de consertos realizados por pessoas não autorizadas;
- Defeitos ou danos resultantes do uso de peças ou dispositivos não conformes às especificações da JVC KENWOOD;
- Danos ou deteriorações aos acabamentos externos, partes cosméticas, cabos, chicotes, parafusos de fixação, luvas, alças, bolsas, estojos, adaptadores, antenas, fitas, cabeças gravadoras, CDs ou danos causados por pilhas defeituosas ou com vazamento;
- Defeitos ou danos devido ao transporte (reclamações devem ser feitas junto à empresa transportadora);
- Qualquer outra causa que não esteja relacionada a defeitos de matéria-prima e de fabricação;
- Danos causados por tentativa de roubo ou furto;
- Danos causados por uso de CDs de má qualidade;
- Danos decorrentes do desgaste natural do produto;
- Danos causados por mau uso (derramamento de líquidos e/ou alimentos, corrosão, oxidação, exposição à umidade ou situações climáticas extremas, riscos ou quedas).

CONCERTO EM GARANTIA

É indispensável a apresentação deste Certificado de Garantia devidamente preenchido, acompanhado da respectiva Nota Fiscal de compra do produto, desde que não apresente rasuras ou modificações. O consumidor somente terá direito a estes benefícios, quando o produto for entregue diretamente no balcão de um Serviço Autorizado da JVC KENWOOD.

O QUE NÃO É COBERTO PELA GARANTIA

Instalação e remoção do produto, despesas de frete, seguro e embalagem são de responsabilidade do proprietário.

Este produto é destinado exclusivamente ao uso doméstico.

IMPORTANTE:

Para qualquer informação sobre seu equipamento JVC KENWOOD, ou para obter o endereço do Serviço Autorizado mais próximo, acesse o site www.kenwood.com.br ou ligue para a Central de Atendimento JVC KENWOOD - Tel.: +55 (11) 3777-6771 com os dados abaixo preenchidos.

JVC KENWOOD DO BRASIL COMÉRCIO DE ELETRÔNICOS LTDA
Tel: (11) 3777-6771
www.kenwood.com.br

Nome do consumidor: _____

Endereço: _____ CEP: _____

Cidade: _____ Estado: _____

Telefone: _____

Data da compra: ____/____/____ Nota Fiscal: _____

CANADA

JVCKENWOOD CANADA INC.

KENWOOD WARRANTY

KENWOOD ELECTRONICS CANADA INC. (hereinafter called "KENWOOD"), gives the following written warranty to the original customer of each new Kenwood product distributed in Canada by KENWOOD and purchased from a dealer authorized by KENWOOD.

KENWOOD warrants that each new Kenwood product, under normal use, is free from any defects, subject to the terms and conditions set forth below. If a defect should occur within the warranty period, repairs will be made free of charge for parts and labour when such defects are determined by KENWOOD or its' authorized service centres to be attributable to faulty materials or workmanship at time of manufacture. Please contact KENWOOD to confirm if a dealer or service centre is authorized by KENWOOD.

WARRANTY PERIOD

This Kenwood product is warranted for parts and labour for a period of one (1) year from the date of original purchase, lease or rental, except for products which are used in a professional or commercial application, which are warranted for a period of ninety (90) days for parts and labour and are subject to the terms and conditions of the warranty.

WARRANTY EXCLUSIONS

This warranty excludes:

- Products purchased in a foreign country or purchased in Canada and taken to a foreign country.
- Products purchased from a dealer not authorized by KENWOOD.
- Products with the serial number defaced, altered or missing.
- Periodic check-ups which do not disclose any defects covered by this warranty.

GARANTIE KENWOOD

KENWOOD ELECTRONICS CANADA INC. (ci-après appelée "KENWOOD"), donne par écrit la garantie suivante à l'acheteur original de chaque nouveau produit Kenwood distribué au Canada par KENWOOD et acheté à un concessionnaire autorisé par KENWOOD.

KENWOOD garantit, sous réserve des termes et des conditions énoncés ci-dessous, que chaque nouveau produit Kenwood, dans des conditions d'emploi normales, est exempt de tous défauts. Si l'un d'eux se produit pendant la période de garantie, KENWOOD s'engage à assumer le coût des pièces défectueuses et de la main-d'œuvre nécessaires pour effectuer les réparations pourvu que de tels défauts sont attribuables à des pièces défectueuses employées lors de la fabrication du produit Kenwood ou à la main-d'œuvre tel qu'établi par KENWOOD ou par l'un de ses centres de service autorisés. Appelez KENWOOD pour vérifier si un concessionnaire ou un centre de service est autorisé par KENWOOD.

PÉRIODE DE GARANTIE

Les pièces et la main-d'œuvre nécessaires pour la réparation des produits Kenwood sont garanties pendant la période d'un (1) an à compter de la date d'achat, de bail ou de location originale, sauf dans les cas où les produits Kenwood sont employés dans un but professionnel ou commercial, où la garantie des pièces et de la main-d'œuvre demeure en vigueur pendant une période de quatre-vingt-dix (90) jours sous réserve des termes et des conditions de la garantie.

EXCLUSIONS DE GARANTIE

Cette garantie ne couvre pas:

- les produits achetés à l'étranger ou achetés au Canada et transportés à l'étranger,
- les produits achetés à un concessionnaire non autorisé par KENWOOD,
- les produits dont le numéro de série manque, a été effacé ou modifié,
- les services d'entretien périodiques qui n'indiquent aucun défaut couvert par cette garantie;

- Defects resulting from disaster, accident, abuse, misuse, lightning, power surges, neglect or lack of periodic maintenance, unauthorized modification or failure to follow instructions in the owner's manual.
- Defects or damage as a result of repairs performed by a person or party not authorized by KENWOOD.
- Defects resulting from the use of parts or devices that do not conform to KENWOOD specifications.
- Damage or deterioration occurring to any exterior finishes, cosmetic parts, tape heads, adaptors, antennas, cables, tapes, discs or faults or damage caused by defective or leaking batteries.
- Defects or damage occurring during shipping (claims should be presented to the shipping company).
- Product voltage and /or line frequency conversions.
- Product installation or removal charges.

TO OBTAIN WARRANTY SERVICE

Should your Kenwood product require warranty service, deliver it to any authorized KENWOOD service centre and present the original copy of your bill of sale and this warranty card as proof of warranty, or send your product fully insured and freight prepaid to the nearest authorized KENWOOD service centre. To avoid possible shipping damage, make sure the product is properly packed. Include a copy of your original bill of sale and this warranty card as proof of warranty along with your name, home and /or work telephone number(s), a complete return address and a detailed description of the fault(s). Products repaired within warranty will be returned freight prepaid to destinations within Canada. The customer is responsible for all freight and related costs for the return of product(s) to destinations outside Canada.

ENTIRE WARRANTY

This warranty constitutes the entire written warranty given by KENWOOD. No person, party, dealer or service centre or their agents or employees are authorized to extend or enlarge this warranty on behalf of KENWOOD by any written or verbal statement or advertisement or promotion, including any extended warranty program or plan that may be offered by the dealer or service centre, unless approved in writing by KENWOOD.

DISCLAIMER

KENWOOD disclaims any responsibility for loss of time or use of the product or any other indirect, incidental or consequential damage to other products or goods, inconvenience or commercial loss.

NOTICE TO CONSUMER

The provisions contained in this written warranty are not intended to limit, modify, take away, disclaim or exclude any warranties or rights you may have which are set forth in any applicable provincial or federal laws or legislation.

IMPORTANT

This warranty card by itself is not considered by KENWOOD as a valid proof of purchase. When applying for warranty repairs, you must present the original copy of your bill of sale and this warranty card as proof of warranty, so we recommend that they be kept in a safe place, should they be required in the future.

JVCKENWOOD CANADA INC.
6070 Kestrel Road, Mississauga, Ontario, Canada L5T 1S8
Tel.: (905) 670-7211
Fax: (905) 670-7248

L'ENTIÈRE GARANTIE

Cette garantie représente l'entière garantie donnée par écrit par KENWOOD. KENWOOD ne se tient aucunement responsable de toutes extensions ni de toutes augmentations de cette garantie faites ou entreprises par toutes personnes, parties, concessionnaires ou centres de service ou par leurs agents ou employés au nom de KENWOOD au moyen d'affirmations verbales ou écrites, d'annonces ou de promotions, y inclus tous programmes ou plans de garantie étendue que puissent offrir les concessionnaires ou les centres de service, à moins que KENWOOD n'y ait consenti par écrit d'avance.

RENONCIATION

KENWOOD renonce à toutes responsabilités de perte de temps, d'emploi du produit, de tous dommages indirects ou accessoires causés à d'autres produits ou biens, de tous inconvénients ou de toutes pertes commerciales.

AVIS AUX CONSOMMATEURS

Les stipulations contenues dans la présente garantie écrite n'ont pas pour but de limiter, de modifier, de diminuer, de rejeter ni d'exclure d'autres garanties ni droits énoncés dans n'importe quelles lois ou législations provinciales ou fédérales.

IMPORTANT

KENWOOD ne considère pas cette garantie toute seule comme étant une preuve d'achat valide. Lorsqu'on demande du service sous garantie, il faudra présenter la copie originale du contrat de vente aussi bien que cette carte de garantie en tant que preuve de garantie. On recommande de les conserver dans un lieu sûr au cas où elles s'avèreraient nécessaires à l'avenir.

JVCKENWOOD CANADA INC.
6070 Kestrel Road, Mississauga, Ontario, Canada L5T 1S8
Téléphone: (905) 670-7211
Télécopieur: (905) 670-7248

Free Manuals Download Website

<http://myh66.com>

<http://usermanuals.us>

<http://www.somanuals.com>

<http://www.4manuals.cc>

<http://www.manual-lib.com>

<http://www.404manual.com>

<http://www.luxmanual.com>

<http://aubethermostatmanual.com>

Golf course search by state

<http://golfingnear.com>

Email search by domain

<http://emailbydomain.com>

Auto manuals search

<http://auto.somanuals.com>

TV manuals search

<http://tv.somanuals.com>