

KENWOOD

GPS NAVIGATION SYSTEM

DNX5120
DNX512EX

MONITOR WITH DVD RECEIVER

DDX512
DDX5032

INSTRUCTION MANUAL

Kenwood Corporation



Take the time to read through this instruction manual.

Familiarity with installation and operation procedures will help you obtain the best performance from your new GPS Navigation System/DVD Receiver.

For your records

Record the serial number, found on the back of the unit, in the spaces designated on the warranty card, and in the space provided below. Refer to the model and serial numbers whenever you call upon your Kenwood dealer for information or service on the product. Model DNX5120/DNX512EX/DDX512/DDX5032 Serial number _____

US Residence Only

Register Online

Register your Kenwood product at
www.Kenwoodusa.com

Contents

How to read this manual	4
Before Use	6
Notes	7

Navigation Control	14
Using the Navigation System	14
Navigatin Information Interrupt on the Screen of Other Sources (DNX5120/DNX512EX only)	14
Control of Other Sources While Displaying the Navigation Screen	15

Watching DVD/VCD	16
Functions During the Playback Screen	16
Functions When Displaying the Easy Control Panel	17
Functions While Displaying the Control Screen	17
DVD Disc Menu	18
VCD Zoom Control	20

Music Disc & Audio File Listening	21
Functions While Displaying the Control Screen	21

Video File/Picture Watching	23
Function During Playback Screen	23
Functions When Displaying the Easy Control Panel	24
Functions While Displaying the Control Screen	24
Picture Control	25

Radio Listening	26
Functions While Displaying the Control Screen	26
Seek Mode	27
Auto Memory	28
Manual Memory	28
Radio Text	29
Set Station Name	29
Traffic Information	30
Search for Program Type	30

Basic Operations	10
-------------------------	-----------

iPod Control	31
Connecting an iPod	31
Functions When Displaying the Easy Control Panel	31
Functions While Displaying the Control Screen	32

USB Device Control	34
Functions When Displaying the Easy Control Panel	34
Functions While displaying the Control Screen	34
Folder Select	36

Sirius/XM Control (North American sales area only)	37
Functions While Displaying the Control Screen	37
Channel Search	38
Channel Memory	38
Direct Channel Search	39

Bluetooth Audio Control	40
Functions While Displaying the Control Screen	40

Muting Audio Volume upon Reception of Phone Call 41

Muting Audio Volume upon Reception of Phone Call 41

Character Entry 42

How to Use the Character Entry Screen 42

Screen Control 43

Screen Control 43

Hands Free Unit Control 44

Control Screen Function 44

When Received a Call 45

Calling by Entering a Phone Number 46

Quick Dialing 46

Controlling Tone-based Services 47

Calling by Phonebook 47

Making a Call Using Outgoing/Incoming Call Records 49

Calling by Voice Recognition 50

Setting Up the Hands-Free Phone 51

Voice Recognition 52

Key Word Voice Recognition 53

Phone Number Preset 54

SMS (Short Message Service) 55

Setup Menu 56

Setup Menu 56

Audio Setup 56

Crossover Network Setup 57

DVD Setup 57

Language Setup 58

Parental Level Setup 59

System Setup 60

Panel Color Coordinate 61

AV Interface Setup 62

User Interface 64

Direct Source Button Setup 65

Entering Background 66

Background Delete 66

Background Select 67

Touch Panel Adjustment 67

Clock Setup 68

Monitor Setup 68

Security Code Setup 70

Deactivating Security Code 71

iPod Setup 72

Sirius Setup 72

Sirius Parental Code Setup 73

Sirius Parental Lock Setup 74

Sirius Parental Lock Channel Select 74

Bluetooth Setup 75

Registering Bluetooth Unit 76

Registering Bluetooth Unit PIN Code 77

Registering Special Bluetooth Unit 77

Bluetooth Unit Connection 78

Deleting Bluetooth Unit 78

Software Information 79

Setup Memory 80

Audio Control 82

Audio Control Menu 82

Audio Control 82

Equalizer Control 83

Tone Setup 84

Zone Control 84

Remote Controller 86

Battery installation 86

Remote Controller mode switch 86

Common operations (AUD mode) 87

DVD/VCD/CD/Audio files (DVD mode) 88

Radio (AUD mode) 89

NAVI (NAVI mode) 90

DVD Language Codes 91

Help? Troubleshooting 92

Help? Error 94

Specifications 96

How to read this manual

This manual uses illustrations to explain its operations.

The displays and panels shown in this manual are examples used to provide clear explanations of the operations.

For this reason, they may be different from the actual displays or panels used, or some display patterns may be different.

- ▼ : Continues to the next line.
- : Ends here.

Continue to the next page

The instruction continues to the next page. Make sure to flip the page for the rest of the instruction.

Seek Mode

Sets a station selection.

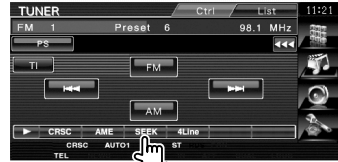

The mode is switched in following order each time you touch the button.

Display	Setting
"AUTO1"	Tunes in a station with good reception automatically.
"AUTO2"	Tunes in stations in memory one after another.
"MANU"	Switches to the next frequency manually.

Manual Memory

Stores the current receiving station in memory.

1 Select a station you wish to store in

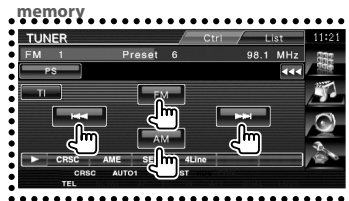

2 Store in memory

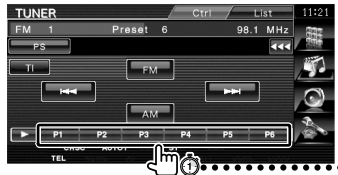

Next page ►

The above operation example with the mark differs from the actual operation.



Short Press

Press the button, denoted by .



Change in the screen

With each operation, the screen changes in the order shown here.





Selecting a screen item

Select and choose an item on the screen.
Select the item by touching the button on the screen.



Press 1 second or more

Press the button, denoted by  , for 1 second or more (2-3 seconds).
Indicates to press and hold down the button until operation starts or the screen changes. The left example indicates to press the button for 1 second.
Press it approximately for the seconds shown in the clock.

Other marks



Important precautions are described to prevent injuries etc.



Special instructions, supplementary explanations, limitations, and reference pages are described.



General precautions and reference pages are shown on the item.



The initial value of each setup is shown.

Before Use

⚠ WARNING

To prevent injury or fire, take the following precautions:

- To prevent a short circuit, never put or leave any metallic objects (such as coins or metal tools) inside the unit.
- Do not watch or fix your eyes on the unit's display when you are driving for any extended period.

How to reset your unit

- If the unit or the connected unit (disc auto changer, etc.) fails to operate properly, press the Reset button. The unit returns to factory settings when the Reset button is pressed.
- Remove the USB device before pressing the Reset button. Pressing the Reset button with the USB device installed can damage the data contained in the USB device. For how to remove the USB device, see <Playing a USB device> (page 10).

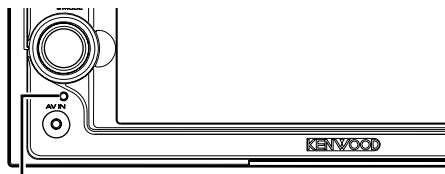

Reset button

Cleaning the Unit

If the faceplate of this unit is stained, wipe it with a dry soft cloth such as a silicon cloth.

If the faceplate is stained badly, wipe the stain off with a cloth moistened with neutral cleaner, then wipe it again with a clean soft dry cloth.



- Applying spray cleaner directly to the unit may affect its mechanical parts. Wiping the faceplate with a hard cloth or using a volatile liquid such as thinner or alcohol may scratch the surface or erase characters.

Lens Fogging

When you turn on the car heater in cold weather, dew or condensation may form on the lens in the disc player of the unit. Called lens fogging, this condensation on the lens may not allow discs to play. In such a situation, remove the disc and wait for the condensation to evaporate. If the unit still does not operate normally after a while, consult your Kenwood dealer.

Handling discs

- Do not touch the recording surface of the disc.
- Do not stick tape etc. on the disc, or use a disc with tape stuck on it.
- Do not use disc type accessories.
- Clean from the center of the disc and move outward.
- When removing discs from this unit, pull them out horizontally.
- If the disc center hole or outside rim has burrs, use the disc only after removing the burrs with a ballpoint pen etc.

Discs that cannot be used

- Discs that are not round cannot be used.

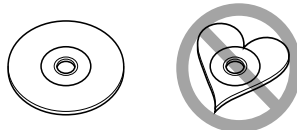

- Discs with coloring on the recording surface or discs that are dirty cannot be used.
- This unit can only play the CDs with . This unit may not correctly play discs which do not have the mark.
- You cannot play a CD-R or CD-RW that has not been finalized. (For the finalization process refer to your CD-R/CD-RW writing software, and your CD-R/CD-RW recorder instruction manual.)
- If you try to load a 3-inch-disc with its adapter into the unit, the adapter might separate from the disc and damage the unit.

Other notes

- If you experience problems during installation, consult your Kenwood dealer.
- When you purchase optional accessories, check with your Kenwood dealer to make sure that they work with your model and in your area.
- The characters conforming to ISO 8859-1 character set can be displayed.
- The RDS or RBDS feature won't work where the service is not supported by any broadcasting station.

Notes

Navigation units that can be connected to this unit (DDX512/DDX5032 only)

- KNA-G510*
- KNA-DV4100
- KNA-DV3100
- KNA-DV2100

* Update the navigation software to the latest version. For how to update the software, refer to the instruction manual of the navigation unit.

iPod that can be connected to this unit

You can control an iPod from this unit by connecting an iPod (commercial product) with Dock connector using an optional accessory iPod connection cable (KCA-iP300V).

The following iPods can be controlled from this unit.

- iPod nano
- iPod nano (Second Generation)
- iPod nano (3rd Generation)
- Fifth Generation iPod (iPod with video)
- iPod classic
- iPod touch

Update iPod software to the latest version.

The latest iPod software updater can be downloaded from the Apple Inc. web site.

By connecting your iPod to this unit with an optional accessory iPod connection cable (KCA-iP300V), you can supply power to your iPod as well as charge it while playing music. However, the power of this unit must be on.

About Satellite Radio tuner

This unit supports Satellite Radio tuners which are released by SIRIUS and XM.

Optional accessories below are necessary for connection.

SIRIUS tuner : Conversion cable CA-SR20V

XM tuner : XM interface Box KCA-XM100V

Refer to the instruction manual of Satellite radio tuner.

About HD Radio

When you connect an HD Radio, Tuner features of the unit are disabled and changed to HD Radio tuner features.

With the HD Radio tuner, you can use the similar functions of Tuner features. Refer to Tuner features for how to use the functions.

Bluetooth unit that can be connected to this unit

- KCA-BT200

List of playable discs

Disc types	Standard	Support	Remark
DVD	DVD Video	○	
	DVD Audio	×	
	DVD-R	○	
	DVD-RW	○	MP3/WMA/AAC/JPEG/MPEG Playback
	DVD+R	○	Multi-border/Multisession/ (Playback depends on authoring conditions)
	DVD+RW	○	Compatible with 8-cm (3 inch) discs
	DVD-R DL (Dual layer)	○	
	DVD+R DL (Double layer)	○	Only video format
	DVD-RAM	×	
CD	Music CD	○	CD-TEXT/8-cm (3 inch) discs supported.
	CD-ROM	○	MP3/WMA/AAC/JPEG playback
	CD-R	○	Multisession supported
	CD-RW	○	Packet write not supported.
	DTS-CD	○	
	Video CD (VCD)	○	
	Super video CD	×	
	Photo CD	×	
	CD-EXTRA	△	Only music CD session can be played.
	HDCD	△	Sound quality of normal CD music
	CCCD	×	
Others	Dualdisc	×	
	Super audio CD	△	Only CD layer can be played.

○ : Playback is possible.

△ : Playback is partly possible.

× : Playback is impossible.

Use of "DualDisc"

When playing a "DualDisc" on this unit, the surface of the disc that is not played may be scratched while the disc is inserted or ejected. Since the music CD surface does not conform to the CD standard, playback may be impossible.

(A "DualDisc" is a disc with one surface containing DVD standard signals and the other surface containing music CD signals.)

About Audio files

- **Playable Audio file**
AAC-LC (.m4a), MP3 (.mp3), WMA (.wma)



- If music of normal CD and other playback systems are recorded in the same disc, only the playback system recorded at the first setout is played.
- **Playable disc media**
CD-R/RW/ROM, DVD±R/RW
- **Playable disc file format**
ISO 9660 Level 1/2, Joliet, Romeo, Long file name.
- **Playable USB device**
USB mass storage class, iPod with KCA-iP300V
- **Playable USB device file system**
FAT16, FAT32

Although the audio files are compiled with the standards listed above, the play maybe impossible depending on the types or conditions of media or device.

- **Playing order of the Audio file**

In the example of folder/file tree shown below, the files are played in the order from ① to ⑩.

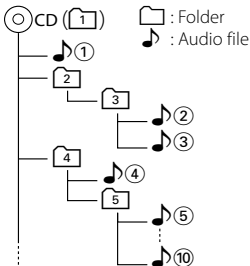

An online manual about audio files is put on the site, www.kenwood.com/audiofile/. On this online manual, detailed information and notes which are not written in this manual are provided. Make sure to read through the online manual as well.



- In this manual, the word "USB device" is used for flash memories and digital audio players which have USB terminals.
- The word "iPod" appearing in this manual indicates the iPod connected with the KCA-iP300V (optional accessory).

About Video files

- **Acceptable video files**
MPEG1, MPEG2
- **Extensions**
mpg, mpeg, m1v, m2v
- **Acceptable media**
CD-R/RW/ROM, DVD±R/RW, VCD, mass-storage-

class USB device, iPod with KCA-iP300V

Acceptable discs, disc formats, USB device file system, file and folder names and playing order are the same as those for audio files. See <About Audio files>.

About Picture files

- **Acceptable picture files**
JPEG
- **Extensions**
jpg, jpeg
- **Acceptable media**
CD-R/RW/ROM, DVD±R/RW, mass-storage-class USB device

Acceptable discs, disc formats, USB device file system, file and folder names and playing order are the same as those for audio files. See <About Audio files>.

About USB device

- If you start playback after connecting the iPod, the music that has been played by the iPod is played first.
In this case, "RESUMING" is displayed without displaying a folder name, etc. Changing the browse item will display a correct title, etc.
- When the iPod is connected to this unit, "KENWOOD" or "✓" is displayed on the iPod to indicate that you cannot operate the iPod.
- When the USB device is connected to this unit, it can be charged up provided that this unit is powered.
- Install the USB device in the place where it will not prevent you from driving your vehicle properly.
- You cannot connect a USB device via a USB hub and Multi Card Reader.
- Take backups of the audio files used with this unit. The files can be erased depending on the operating conditions of the USB device.
We shall have no compensation for any damage arising out of erasure of the stored data.
- No USB device comes with this unit. You need to purchase a commercially available USB device.
- When connecting the USB device, usage of the CA-U1EX (option) is recommended.
Normal playback is not guaranteed when a cable other than the USB compatible cable is used. Connecting a cable whose total length is longer than 5 m can result in abnormal playback.

Region codes in the world

The DVD players are given a region code according to the country or area it is marketed, as shown in the following map.

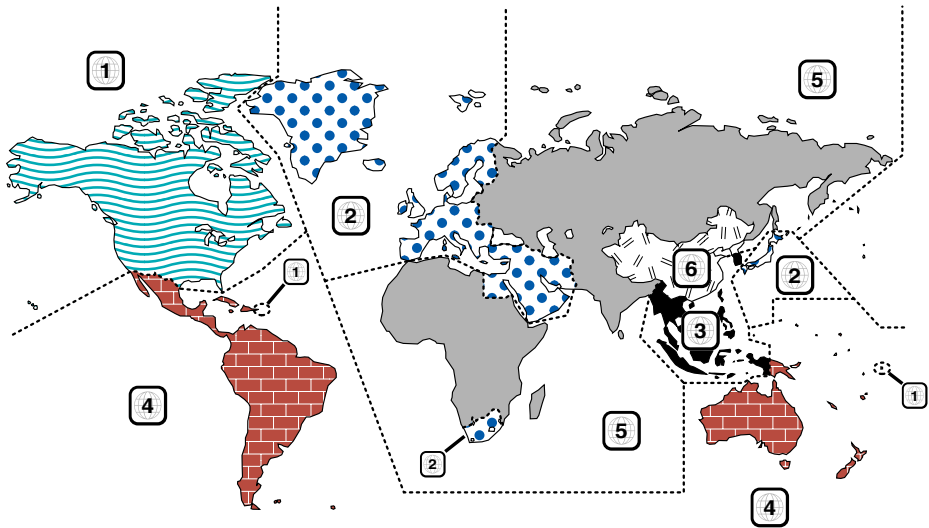

DVD disc marks

Symbol	Description
	Indicates a region number. The discs with this mark can be played with any DVD player.
	Indicates the number of audio languages recorded. Up to 8 languages can be recorded in a movie. You can select a favorite language.
	Indicates the number of subtitled languages recorded. Up to 32 languages can be recorded.
	If a DVD disc has scenes shot from multiple angles, you can select a favorite angle.
	Indicates the type of screen for the image. The left mark indicates that a wide image picture (16:9) is displayed on a standard TV set screen (4:3) with a black band at both the top and bottom of the screen (letter box).

Operation regulatory marks

With this DVD, some functions of this unit such as the play function may be restricted depending on the location where the DVD is playing. In this case, the following marks will appear on the screen. For more information, refer to the disc manual.



Discs with limited period of use

Do not leave discs with a limited period of use in this unit. If you load an already expired disc, you may not be able to remove it from this unit.

Basic Operations

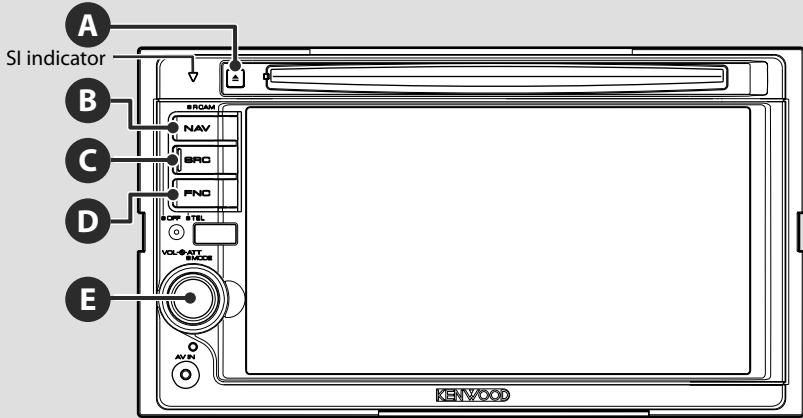

A

Turns power ON/OFF

Press the button to turn on the power.
When the button is pressed and held down for 1 second or more, the power is turned off.

B

Switches to the Navigation system

Press the button to switch the display to the navigation system screen.

E

Adjusts the volume

Turn it either way to adjust the volume.

E

Attenuates the volume

Press it to attenuate the volume.
Press it again to cancel muting.

Playing a USB device

When connecting a USB device, playback starts automatically.

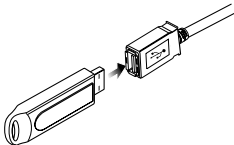

- If the USB source is selected when a USB device is not connected, "No Device" is displayed.
- When the playback is stopped and then restarted, the playback will start from the point where it was stopped at the last time. Even if the USB is removed and connected again, the playback will start from the last stopped point unless the contents in the USB device is changed.
- Make sure that the USB device is connected firmly.

Removing the USB device

Press  on the USB control screen to enter the USB suspend mode, and then remove the USB device. See <USB Device Control> (page 34).



- Removing the USB device before entering the USB suspend mode may result in damaging the data in the USB device.

C

Selecting a source

Press it to display the source select screen. Touch the source button to select the source.

Full Source Select screen



Favorite Source Select screen



- 1 Scrolls the source display.
- 2 Displays the Hands Free screen. (page 44)



- The displayed source depends on the type of device connected. In addition, you cannot press the button of currently unavailable source.

The following buttons are always displayed on the source select screen and source control screen.

- 3 Displays the Source Select screen.
The display switches between Favorite Source Select screen and Full Source Select screen by touching the button.
- 4 Displays Source Control screen.
- 5 Displays the Audio Control Menu screen. (page 82)
- 6 Displays the Setup Menu screen. (page 56)
- 7 Clock display



- If a Bluetooth Unit is not connected, [TEL] will not appear.

- 8 Displays the Full Source Select screen.



- For how to register the frequently used source buttons to Favorite Source Select screen, see <Direct Source Button Setup> (page 65).

A

Playing a disc

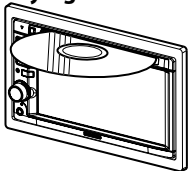

When you load a disc into disc loading slot, the disc starts playing.
If a menu appears, when playing a video disc, select the desired item.



- See <List of playable discs> (page 7) for a list of supported discs and formats.

Removing a disc

Press [▲] (Eject) button.

Basic Operations

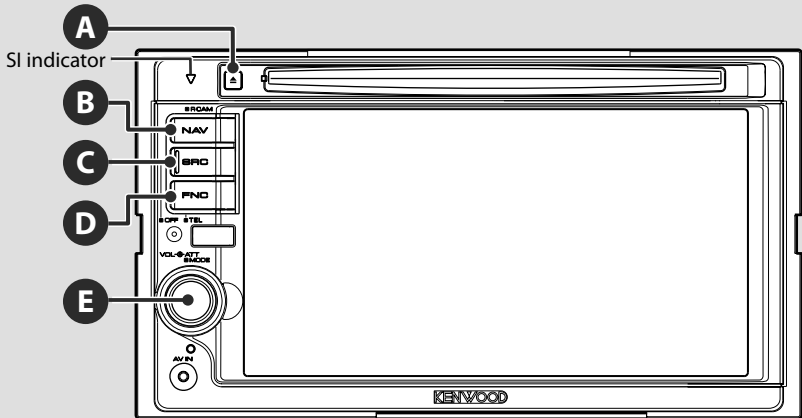

D

Switches to the Hands Free control

Press it for more than 1 second to the Hands Free control screen.

Press it again for more than 1 second to resume the normal display.

B

Switches to the rear view

Press it for more than 1 second to switch to rear view.

Press it again for more than 1 second to resume the normal display.



- Functions of the [NAV] button can be changed to Display Off function. See <System Setup> (page 60) for the function setting of the [NAV] button.

Playing an external player

Connect an external player such as a digital audio player to AV IN jack. Use of the optional cable CA-C3AV is recommended for connecting an external player.

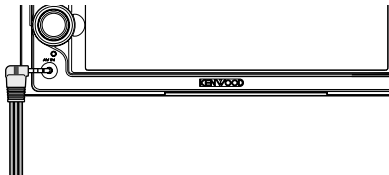

D

Switching the function screen

The function control screen switches in the following order each time you press the button.

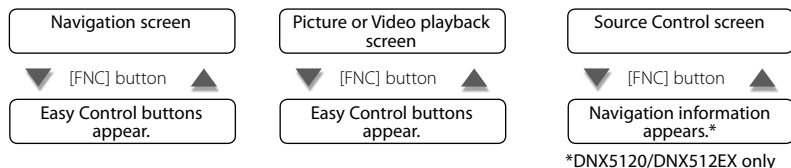

Navigation screen

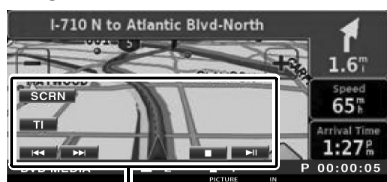

Easy Control button

Picture or Video playback screen



Easy Control button



- For the functions of Easy Control buttons, see <Control of Other Sources While Displaying the Navigation Screen> (page 15).

Source Control screen

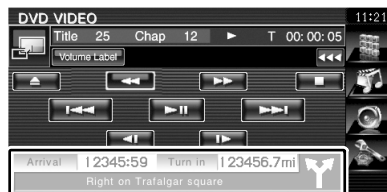

Navigation information (DNX5120/DNX512EX only)



- For the functions of Navigation information, see <Navigation Information Interrupt on the Screen of Other Sources> (page 14).

E

Scrolls the list and makes a selection

When the list screen of a source control screen is displayed, press it for more than 1 second to enter list control mode.

Turn it either way to scroll the list. Press it to make a selection.

Press it again for more than 1 second to return to the volume control mode.

Example: List screen of DVD MEDIA source



Navigation Control

Sets and controls the navigation system function.

Using the Navigation System

Displays the navigation system screen and makes the navigation function available.

1 Displaying the navigation screen



2 Setting the navigation system function

Touch the navigation system button displayed on the screen. See the included NAVIGATION SYSTEM's INSTRUCTION MANUAL for information on using the navigation system.



- You can set the navigation system function when nothing else is displayed on the screen. If anything else, such as Easy control panel is displayed, erase it first.
- For DDX512/DDX5032, an optional navigation system needs to be connected. See <Navigation unit that can be connected to this unit> (page 7) for connectable navigation units.

Navigation Information Interrupt on the Screen of Other Sources (DNX5120/DNX512EX only)

Interrupts other source screen and displays information such as guide point.

While a control screen is displaying:

Navigation information appears on the bottom of the screen.



- 1 Displays the Navigation information. When touched this area, the navigation screen appears.

Control of Other Sources While Displaying the Navigation Screen

Selected source can be controlled while displaying navigation screen.

1 Display the easy control buttons



When "DVD" is selected:

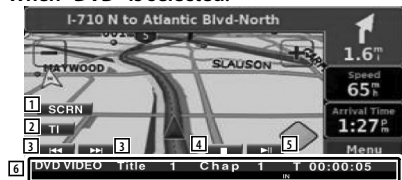

- 1 Displays the Screen Control screen.
See <Screen Control> (page 43).
- 2 Turns the traffic information function On or Off.
- 3 During DVD play :
Selects a chapter.
During VCD play :
Selects a scene (when PBC is On) or a track (when PBC is Off).
During CD play :
Selects music. When you continue to touch the button, fast forwards or fast backwards.
During Audio file, Video file, or Picture file play :
Selects a file.
- 4 When pressed twice, the disc is played from its beginning when you play it in the next time. (DVD play only)
- 5 Plays or pauses.
- 6 When touched this area, the source control screen appears.

When "USB" or "iPod" is selected:

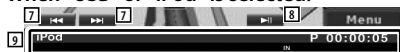

- 7 During iPod play :
Searches Music or Video.
During USB play :
Selects a file.
- 8 Plays or pauses.
- 9 When touched this area, the source control screen appears.

When "TUNER" is selected:



- 10 Tunes in a station.
- 11 Switches the band (to AM or FM 1/2/3).
- 12 When touched this area, the source control screen appears.

When "SIRIUS" or "XM" is selected:



- 13 Tunes in a station.
- 14 Switches the band
Sirius : SR1/ SR2/ SR3
XM : XM1/ XM2/ XM3
- 15 Switches the Seek mode.
SEEK 1 : Tunes channels one after the other.
SEEK 2 : Selects channels in memory one after the other.
- 16 When touched this area, the source control screen appears.

When "Bluetooth" is selected:



- 17 Selects a file.
- 18 Plays.
- 19 Pauses.
- 20 When touched this area, the source control screen appears.



- The Easy Control buttons are hidden when you touch the central part of the screen.

Watching DVD/VCD

You can play DVD/VCD using various functions.



- For the basic method of how to watch DVD/VCD, see <Basic Operations> (page 10).
- Set the remote controller mode switch to "DVD" mode before starting operation, see <Remote Controller mode switch> (page 86).

Functions During the Playback Screen

Basic functions are available even when the playback screen is displayed.

1 Display the playback screen

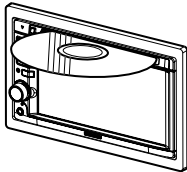

or



[DVD] button on the "Source Select" screen



DVD playback screen

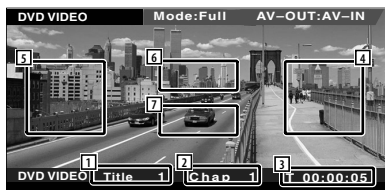

- 1 Title Number Display
- 2 Chapter Number Display
- 3 Play Time Display

- 4 Forward Chapter Search Area
Selects the next chapter.
- 5 Backward Chapter Search Area
Selects the previous chapter.
- 6 DVD Disc Menu Control Buttons Area
Displays the Disc Menu Control buttons (page 18).
- 7 Information Display Button Area

VCD playback screen

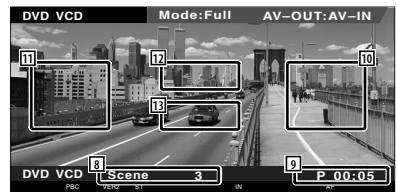

- 8 Scene/Track Number Display
- 9 Play time Display
- 10 Forward Scene/Track Search Area
Selects the next scene (when PBC is On) or track (when PBC is Off).
- 11 Backward Scene/Track Search Area
Selects the previous scene (when PBC is On) or track (when PBC is Off).
- 12 Zoom Control Button Area
Displays the Zoom Control buttons (page 20).
- 13 Information Display Button Area



- The information display is cleared automatically after approximately 5 seconds. Also, the information can be displayed automatically when it is updated.

Functions When Displaying the Easy Control Panel

Displays the basic operation buttons on the screen.

- 1 While the source is playing, press the [FNC] button



- 1 Chapter Search (during DVD play)
Searches for a chapter.
Scene/Track Search (during VCD play)
Selects a scene (when PBC is On) or a track (when PBC is Off).
- 2 Stops playing.
When pressed twice, the disc is played from its beginning when you play it in the next time.
- 3 Plays or pauses.



- When the navigation screen is displayed, press the [NAV] button to switch to the source playback screen.
- The Easy Control Panel is hidden when you touch a central part of the monitor.

Functions While Displaying the Control Screen

Switches to the source control screen to use various playback functions.

- 1 While the source is playing, press the [FNC] button



When playing a DVD



When playing a VCD



- 1 Switches to the playback screen.
- 2 Title Number Display (during DVD play)
- 3 Chapter/Scene/Track Number Display
- 4 Play Mode Display
- 5 Play Time Display
- 6 Volume Label Display
When **\$\$\$** is appeared, the text display is scrolled by pressing it.
- 7 Ejects the disc.
- 8 Fast Forwards or Fast Backwards.

Next page ►

- 9 Stops playing.
When pressed twice, the disc is played from its beginning when you play it in the next time.
- 10 Selects a chapter, a scene or a track.
When the DVD-VIDEO/VCD is paused, touch this button to start single-frame stepping.
- 11 Plays or pauses.
- 12 Slow Forwards or Backwards. (during DVD play)
- 13 Switches the button display.
- 14 Switches the Repeat Play operations in the following sequence.
DVD: Title Repeat, Chapter Repeat, Repeat Off
VCD: Track Repeat, Repeat Off (Available when the PBC is off)
- 15 Switches the play time display in the following sequence.
DVD: Chapter, Title, remaining titles
VCD: Track, disc, remaining discs (Effective only when the PBC function is off)
- 16 Function Indicator
- 17 Appears when a disc is inserted.
- 18 Sound indicator
- 19 Turns the PBC function of VCD On or Off. (only when VCD Ver 2.0 is in use)
- 20 Appears when PBC is On.
- 21 VCD version indicator

DVD Disc Menu

Selects an option from the DVD Disc Menu.

1 Display the Disc Menu Control screen

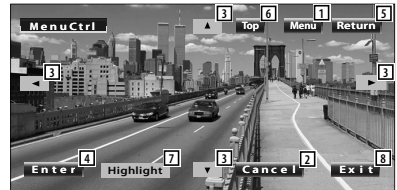
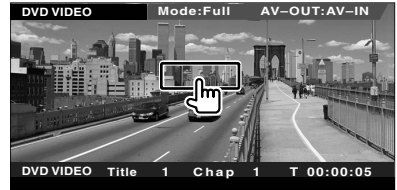

- 1 Calls the Menu.
- 2 Returns to the Disc Menu screen.
- 3 Selects a menu option.
- 4 Enters your menu selection.
- 5 Returns to the previous menu screen.
- 6 Displays the Top Menu.
- 7 Highlight Control.
- 8 Clears the Disc Menu Control.

Highlight Control

You can select a chapter and title for the DVD Menu screen. When you touch the screen, you can select the DVD menu.



- To cancel Highlight Control, press [FNC] button.

2 Select Disc Menu options

Disc Menu



- 9 Calls the Menu Control.
- 10 Switches the picture angle.
(during program playback only)

- 11 Switches the subtitle language.
(during program playback only)
- 12 Switches the voice language.
(during program playback only)
- 13 Displays the Zoom Control screen.
- 14 Clears the Disc Menu Control.

Zoom Control

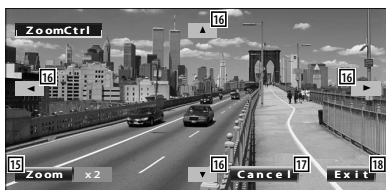

- 15 Changes the zoom ratio at 4 levels (2 times, 3 times, 4 times, or off) each time you touch.
- 16 Scrolls the screen in the direction you touch.
- 17 Returns to the Disc Menu Control screen.
- 18 Clears the Disc Menu Control.

VCD Zoom Control

Displays an enlarged VCD screen.

1 Display the Zoom Control screen

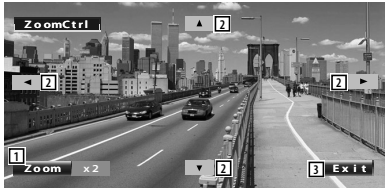
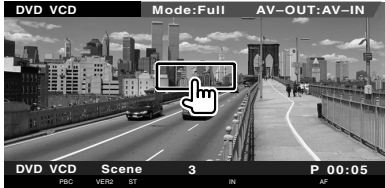

- 1 Changes the zoom ratio at 2 levels (2 times or off) each time you touch.
- 2 Scrolls the screen in the direction you touch.
- 3 Clears the Zoom Control button.

Music Disc & Audio File Listening

You can recall various control screens during CD/Audio file playback.



- For the basic method of how to play a music disc/audio file, see <Basic Operations> (page 10).
- See <List of playable discs> (page 7) for playable discs.
- See <About Audio file> (page 8) for playable files.

Functions While Displaying the Control Screen

Switches to the source control screen to use various playback functions.

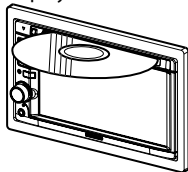

or



[DVD] button on the "Source Select" screen



During CD playback

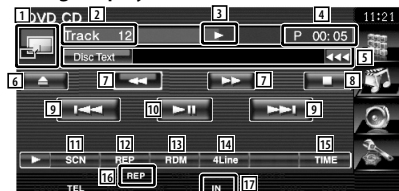

- 1 Switches to the wallpaper.
- 2 Track (Music) Number Display
- 3 Play Mode Display
- 4 Play Time Display

- 5 Music information display
Selects the Disc Text or Track Text.
When is appeared, the text display is scrolled by pressing it.
- 6 Ejects the disc.
- 7 Fast Forwards or Fast Backwards.
- 8 Stops playing the built-in disc player. When pressed twice, the disc is played from its beginning when you play it in the next time.
- 9 Selects a track.
- 10 Plays or pauses.
- 11 Starts or stops Scan Play (that plays the beginning of each music one after the other).
- 12 Repeats to play (the present track).
- 13 Starts or stops Random Play (to play music in random order).
- 14 Switches the number of lines displayed in the Information Display.
- 15 Switches the play time display between Track, Disc, and Disc Remaining Time.
- 16 Function Indicator
- 17 Appears when a disc is inserted.

Next page ►

During Audio file playback

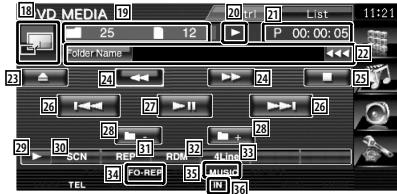

- 18 Switches to the playback screen. If there is no playback screen, wallpaper is displayed.
- 19 Folder and File Number Display
- 20 Play Mode Display
- 21 Play Time Display
- 22 Music information display
Selects Folder Name, File Name, Title, Artist Name, or Album Name.
When ******* is appeared, the text display is scrolled by pressing it.
- 23 Ejects the disc.
- 24 Fast Forwards or Fast Backwards.
(Disabled when a JPEG is being played.)
- 25 Stops playing.
When pressed twice, the disc is played back from its beginning in the next time.
- 26 Selects a file.
- 27 Plays or pauses.
- 28 Selects a folder.
- 29 Switches the button display.
- 30 Starts or stops Scan Play (that plays the beginning of each music or data one after the other).
- 31 Repeats to play (the preset files or data).
- 32 Starts or stops Random Play (to play files of the present folder in random order).
- 33 Switches the number of lines displayed in the Information Display.
- 34 Function Indicator

- 35 MUSIC, MOVIE or PICTURE indicator
- 36 Appears when a disc is inserted.
- 37 Repeats to play the music or data of the present folder.
- 38 Displays images in the folder currently being played one after another.
If there is no image in the folder currently being played, initial background is displayed.
For information on setting the image display time, see <System Setup> (page 60).
- 39 You can search for folders and Audio files through a hierarchy.
- 40 Displays music information (such as Tag and content property) of Audio file being played.

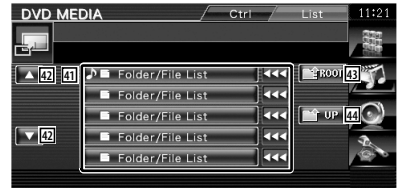

- 41 Lists folders and Audio files
Folder opens when touched, and the Audio file is played.
When ******* is appeared, the text display is scrolled by pressing it.
- 42 Scrolls the list.
- 43 Moves to the top hierarchy level.
- 44 Moves up a hierarchy level.

Video File/Picture Watching

You can recall various control screens during playback of video file (MPEG 1 and MPEG 2 file) and picture file (JPEG file).

Function During Playback Screen

Basic functions are available even when the playback screen is displayed.

1 Display the playback screen

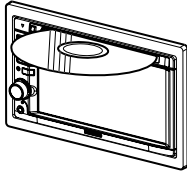

or



[DVD] button on the "Source Select" screen

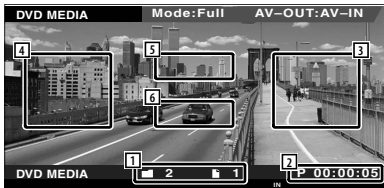

- 1 Folder/File Number Display
- 2 Play Time Display
- 3 Forward File Search Area
Selects the next file.
- 4 Backward File Search Area
Selects the previous file.

- 5 JPEG: Picture Control Button Area (page 25)
MPEG: Not effective
- 6 Information Display Button Area



- The information display is cleared automatically after approximately 5 seconds. Also, the information can be displayed automatically when it is updated.

Functions When Displaying the Easy Control Panel

Displays the basic operation buttons on the screen.

- 1 While the source is playing, press the [FNC] button

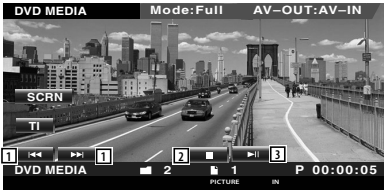

- 1 Selects a file.
- 2 Stops playing.
- 3 Plays or pauses.



- When the navigation screen is displayed, press the [NAV] button to switch to the source playback screen.
- The Easy Control Panel is hidden when you touch a central part of the monitor.

Functions While Displaying the Control Screen

Switches to the source control screen to use various playback functions.

- 1 While the source is playing, press the [FNC] button

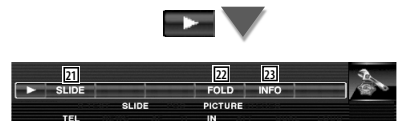
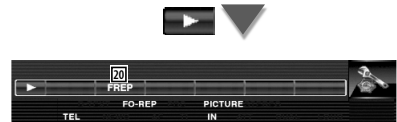
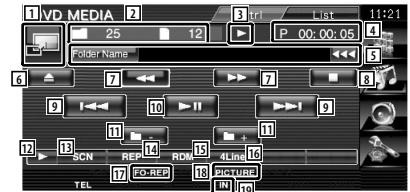

- 1 Switches to the playback screen.
- 2 Folder and File Number Display
- 3 Play Mode Display
- 4 Play Time Display

- 5 Video/Picture information display
Selects Folder Name, File Name, Title, Artist Name, or Album Name.
When **☐** is appeared, the text display is scrolled by pressing it.
- 6 Ejects a disc.
- 7 Fast Forwards or Fast Backwards.
(Disabled when a JPEG is being played.)
- 8 Stops playing.
When pressed twice, the disc is played back from its beginning in the next time.
- 9 Selects a file.
- 10 Plays or pauses.
- 11 Selects a folder.
- 12 Switches the button display.
- 13 Starts or stops Scan Play (that plays the beginning of each song or data one after the other).
- 14 Repeats to play (the preset files or data).
- 15 Starts or stops Random Play (to play files of the present folder in random order).
- 16 Switches the number of lines displayed in the Information Display.
- 17 Function Indicator
- 18 PICTURE, MOVIE or MUSIC indicator
- 19 Appears when a disc is inserted.
- 20 Repeats to play the file of the present folder.
- 21 Displays images in the folder currently being played one after another.
If there is no image in the folder currently being played, initial background is displayed.
For information on setting the image display time, see <System Setup> (page 60).
- 22 You can search for folders and files through a hierarchy.
- 23 Displays information of file being played.

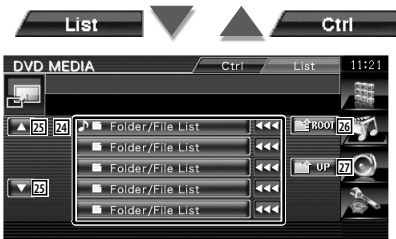

- 24 Lists folders and Video files/Picture files.
Folder opens when touched, and the Video/Picture file is played.

- 25 Scrolls the list.
- 26 Moves to the top hierarchy level.
- 27 Moves up a hierarchy level.

Picture Control

Adjusting the video display.

1 Start Picture Control



2 Adjust the video display



- 1 Reverses the picture horizontally.
- 2 Rotates counter clockwise.
- 3 Rotates clockwise.
- 4 Ends Picture Control.
- 5 Applies the effect.

Radio Listening

Various control screens appear in the Tuner Source mode.



- For the basic method of receiver button operations, see <Basic Operations> (page 10).
- Set the remote controller mode switch to "AUD" mode before starting operation, see <Remote Controller mode switch> (page 86).

Functions While Displaying the Control Screen

Switches to the source control screen to use various functions.



[TUNER] button on the "Source Select" screen

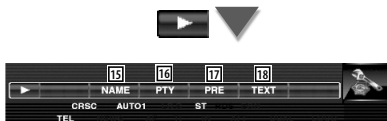
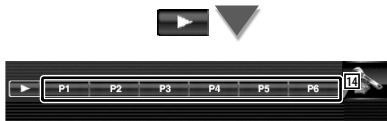
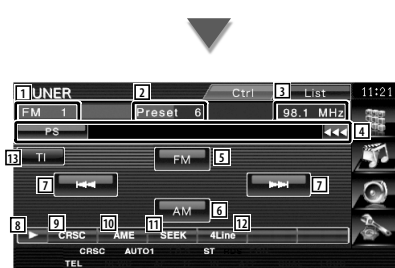

- 1 Band display
- 2 Preset number
- 3 Frequency display

- 4 Radio station information display.
Selects the Program Service Name, Title & Artist name, Station Name, Category Name 1/2, or Radio Text.
- 5 Switches to the FM1/2/3 band.
- 6 Switches to the AM band.
- 7 Tunes in a station.
Use the <Seek Mode> (page 27) to change the frequency switching.
- 8 Switches the button display.
- 9 Turns the CRSC function On or Off. (Only when receiving the FM broadcast)
- 10 Selects the Auto Memory mode.
(See page 28 for the <Auto Memory>)
- 11 Switches the Seek mode.
(See page 27 for the <Seek Mode>)
- 12 Switches the number of lines displayed in the Information Display.
- 13 Turns the Traffic Information function On or Off.
See <Traffic Information>, (page 30).
- 14 When **P1** to **P6** buttons appear, you can recall the stations on memory.
For memory of broadcasting stations, see <Auto Memory> (page 28) or <Manual Memory> (page 28).
- 15 Sets a name to the station. See <Set Station Name> (page 29).
- 16 Searches station by program type. See <Search for Program Type> (page 30).
- 17 Lists and selects memorized station.
- 18 Displays Radio Text screen. See <Radio Text> (page 29).



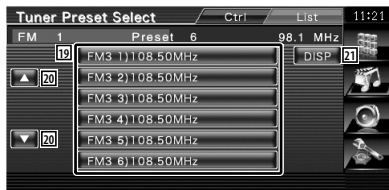

- 19 Memorized stations are displayed. Touch to tune in.
- 20 Scrolls the list.
- 21 Switches the list display name to Station name or Program Service Name.

Seek Mode

Sets a station selection.



The mode is switched in following order each time you touch the button.

Display	Setting
"AUTO1"	Tunes in a station with good reception automatically.
"AUTO2"	Tunes in stations in memory one after another.
"MANU"	Switches to the next frequency manually.

Auto Memory

Stores stations with good reception in memory automatically.

1 Select a band you wish to store in memory



2 Select the Auto Memory mode

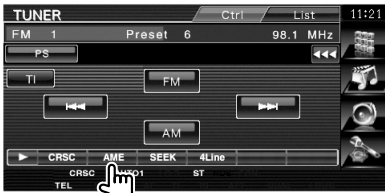

3 Start Auto Memory

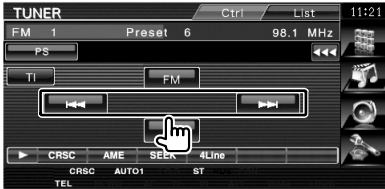

Touch  or .

Auto Memory terminates when 6 stations are stored or when all stations are tuned in.



- The operation ends automatically if you do not operate within 10 seconds.

Manual Memory

Stores the current receiving station in memory.

1 Select a station you wish to store in memory

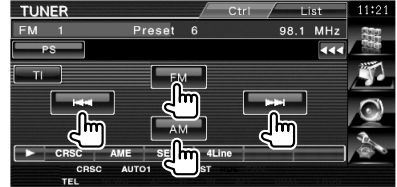

2 Store in memory



Continue to touch until the memory number appears.



: Press for # seconds.

Radio Text

You can display the radio text. (Only when receiving the FM broadcast)

1 Select a station

2 Display the radio text

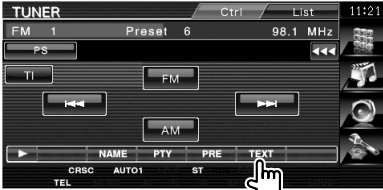

- 1 Selects the Program Service Name, Title & Artist name, Station Name, Radio Text Plus, or Radio Text for text display. When  is appeared, the text display is scrolled by pressing it.
- 2 Scrolls the text display.

Set Station Name

Assigns a name to a station.

1 Tune in to the station to name

2 Start Name set



3 Enter the name

See <Character Entry> (page 42) for information on how to enter a name.

4 End Name set



Traffic Information

When a traffic bulletin starts, any source is switched to the traffic information and it is displayed automatically.

1 Set the Traffic information mode



When the traffic bulletin starts...

The Traffic Information screen appears automatically.

Traffic Information screen

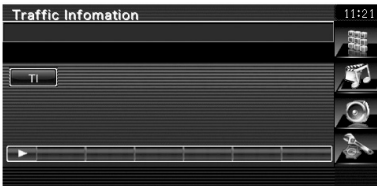

- It is necessary to have Traffic Information function set to On in order to have the Traffic Information screen appear automatically.
- During reception of traffic information the adjusted volume is automatically remembered, and the next time it switches to traffic information it's automatically the remembered volume.

Search for Program Type

A program is tuned when you set its program type. (Only when receiving the FM broadcast)

1 Enter Program Type mode

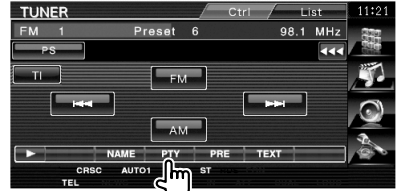

2 Select a Program Type

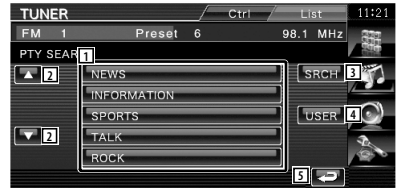

- 1 Program Type is displayed. Touch to select a Program Type.
- 2 Scrolls the Program Type list.
- 3 Searches for the program type. It is displayed when the Program type is selected.
- 4 Continue to touch more than 2 seconds, the currently receiving station is registered to have the selected program type.
- 5 Returns to the previous screen.

3 Search a station of the selected Program Type



iPod Control

You can control and listen to songs in your iPod by connecting an iPod to this unit with KCA-iP300V (optional accessory). You can also display video contents on this unit when connecting an iPod with video.

Connecting an iPod

Connect an iPod to this unit.

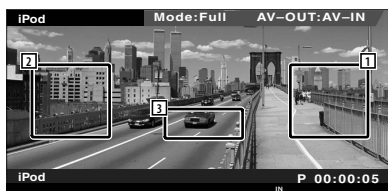
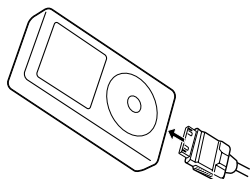

- 1 Forward music/video search area
Selects the next music/video.
- 2 Backward music/video search area
Selects the previous music/video.
- 3 Information display button area
The information is displayed for 5 seconds.



- Remove all accessories such as headphone before connecting an iPod. You may not be able to control the iPod if you connect it with accessories attached.
- When you connect an iPod to this unit, playback starts from the song you were playing on the iPod itself (Resume Function).
- If the played song is not a video content, "No iPod Video Signal" is displayed on the video screen.
- While connecting an iPod, "KENWOOD" appears on the iPod and the iPod's control is disabled.

Functions When Displaying the Easy Control Panel

Displays the basic operation buttons on the screen.

- 1 While the source is playing, press the [FNC] button



- 1 Music/Video Search.
- 2 Plays or pauses.



- When the navigation screen is displayed, press the [NAV] button to switch to the source playback screen.
- The Easy Control Panel is hidden when you touch a central part of the monitor.

Functions While Displaying the Control Screen

Switches to the source control screen to use various playback functions.

When Video or picture is playing, press the [FNC] button.



or



[iPod] button on the "Source Select" screen

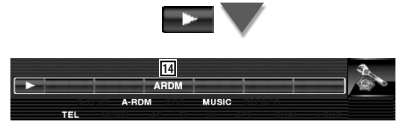
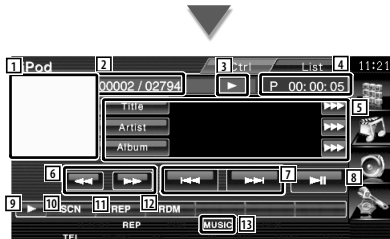

- 1 Image picture
Switches to the playback screen. If there is no playback screen, wallpaper is displayed.
- 2 Total number of music in the iPod and the music number display
- 3 Play Mode Display
- 4 Play Time Display
- 5 Music/Video Information Display
Selects the Title, Artist Name, Album Name or iPod Name.
When  is appeared, the text display is scrolled by pressing it.
- 6 Fast Forwards or Fast Backwards.
- 7 Selects Music/Video.
- 8 Plays or pauses.
- 9 Switches the button display.
- 10 Starts or stops Scan Play (that plays the beginning of each music or video one after the other).
- 11 Repeats to play (the preset files or data).
- 12 Starts or stops Random play.*
- 13 MUSIC or VIDEO indicator
- 14 Starts or stops Album Random Play (plays randomly from current album).*
- 15 Displays the list of music category.
- 16 Displays the list of video category.
- 17 Displays the previous music/video list screen.
- 18 Displays information screen of music/video being played.



* Disabled when VIDEO is being played.





- 19 Categories and music are listed.
Touch a category name to move its lower level. If music title is displayed, the music is played by touching it.
When ◀◀ is appeared, the text display is scrolled by pressing it.
When ▶ is appeared, all the music in its category is played by touching the button.
- 20 Switches list page.
- 21 Returns to previous category.
- 22 Moves to the top category.
- 23 Displays the currently playing category.

USB Device Control

You can control and listen to songs in your USB device by simply connecting it to the USB connector of this unit.



- For the connection of a USB device, see <Basic Operations> (page 10).

Functions When Displaying the Easy Control Panel

Displays the basic operation buttons on the screen.

- 1 While the source is playing, press the [FNC] button

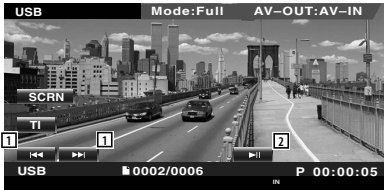

- 1 Selects a file.
- 2 Plays or pauses.



- The Easy Control Panel is hidden when you touch a central part of the monitor.

Functions While displaying the Control Screen

Switches to the source control screen to use various playback functions.

- When Video or picture is playing, press the [FNC] button.



or



[USB] button on the "Source Select" screen





- 1 Image picture
Switches to the playback screen. If there is no playback screen, wallpaper is displayed.
- 2 Track Number Display
- 3 Play Mode Display
- 4 Play Time Display
- 5 Music information display
Selects the Folder Name, File Name, Title, Artist Name, or Album Name.
When **←** is appeared, the text display is scrolled by pressing it.
- 6 Removes the USB device.
When "No Device" is shown, the USB device can be removed safely.
If you wish to play it again while the USB device is connected, press it again.
- 7 Selects a folder. (Only in Folder Select Mode)*
- 8 Selects a file.
- 9 Plays or pauses.
- 10 Switches the button display.
- 11 Starts or stops Scan Play (that plays the beginning of each music one after the other).
- 12 Repeats to play (the present music).
- 13 Starts or stops Random Play (to play music in random order)*.
- 14 Switches the number of lines displayed in the Information Display.
- 15 MUSIC, VIDEO or PICTURE indicator
- 16 Repeats to play the music or data of the present folder. (Only in Folder Select Mode)

- 17 Displays images in the folder currently being played one after another.
If there is no image in the folder currently being played, initial background is displayed.
For information on setting the image display time, see <System Setup> (page 60).
- 18 Displays the folder list. See <Folder Select> (page 36).
- 19 Displays the list of category.
- 20 Displays information screen of music being played.



* Disabled during play list mode.



The display above can also be the folder list display. See <Folder Select> (page 36).

- 21 Switches to the lower level of the category.
If the file is displayed, the music is played by touching it.
- 22 Scrolls the list.
- 23 Lists all the music in the selected category.
- 24 Moves to the upper level of the category.
- 25 Moves to the top category.
- 26 Displays the currently playing category. (Only in Category Mode)

Folder Select

Searches folders and Audio files stored in the USB device according to hierarchy.

1 Start Folder Select



2 Select music



- 1 Lists folders and Audio files
Folder opens when touched, and the Audio file is played.
- 2 Scrolls the list.
- 3 Moves to the top hierarchy level.
- 4 Moves up a hierarchy level.
- 5 Moves to the top category.
- 6 Displays the currently playing file.

Sirius/XM Control (North American sales area only)

Various control screens appear in the Satellite radio source mode. (with the optional accessory Satellite radio connected only. To connect the Sirius tuner, a conversion cable CA-SR20V (optional accessory) is necessary and to connect the XM tuner, an XM interface Box KCA-XM100V (optional accessory) is necessary.)



- This document uses the SIRIUS display as an example.

Functions While Displaying the Control Screen

Switches to control screen to use various functions.



[SIRIUS] or [XM] button on the "Source Select" screen

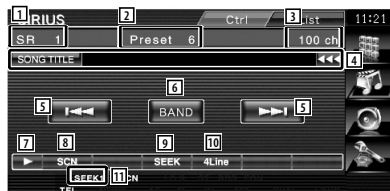

- Band display
- Preset number
- Channel display
- Displays information concerning music being played.

Sirius : Changes the display from Channel Name, Song Title Name, Artist Name, Composer Name, to Category Name.

XM : Changes the display from Channel Name, Title, Name, to Category Name.

Displays the ID number when Channel 0 is selected.

Sirius : Displays the SIRIUS ID.

XM : Displays the RADIO ID.

- Tunes in a station.
- Switches the band.
- Switches the button display.
- Starts or stops Channel Scan (that tunes channels one after the other).
- Switches the Seek mode.
SEEK 1: Tunes channels one after the other.
SEEK 2: Selects channels in memory one after the other.
- Switches the number of lines displayed in the Information Display.
- Indicates current Seek mode
- When **P1** to **P6** buttons appear, you can recall the channel to memory. For memory of channel stations, see <Channel Memory> (page 38).
- You can tune in by entering the desired channel number. See <Direct Channel Search> (page 39).
- You can tune in by specifying the desired category. See <Channel Search> (page 38).
- Displays the program information screen.



See <Channel Search> (page 38) for channel search.

Channel Search

Specifying the desired category and selecting a channel.

1 Start Channel Search



2 Select a category



- 1 Selects a category.
Displays all the channels in the selected category.
- 2 Scrolls the category.
- 3 Displays all the channels.

3 Select a channel



- 4 Selects a channel.
Tunes in the selected channel.
- 5 Scrolls the channel list.
- 6 Display the category list.
- 7 Switches the sequence of the list.
Changes the display from Channel Name, Category Name, Song Title, Artist Name, to Composer Name. (Sirius only)

Channel Memory

Stores the current receiving channel in memory.

1 Select a channel you wish to store in memory



2 Store in memory



Continue to touch until the memory number appears.



Direct Channel Search

Tuning in by entering the desired channel number.

1 Start Direct Channel Search



2 Enter the channel number



- 1 Enters the channel number.
- 2 Cancels the direct channel search.
- 3 Clears the channel number.

3 Tune in the channel



Bluetooth Audio Control

When KCA-BT200 (optional accessory) is connected, you can listen to audio files stored in Bluetooth audio player and cell-phone.



- You need to register your audio player and cell-phone to your Bluetooth Unit beforehand. Make sure to read the instruction manual of the Bluetooth Unit as well.

Functions While Displaying the Control Screen

Switches to control screen to use various functions.



[Bluetooth] button on the "Source Select" screen

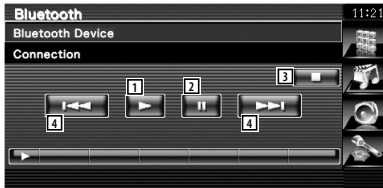

- 1 Plays.
- 2 Pauses.
- 3 Stops playing.
- 4 Selects a file.



- If the Bluetooth Audio player does not support AVRCP profile, buttons [1] to [4] are not displayed. Operate from the Audio player.

Muting Audio Volume upon Reception of Phone call

When the telephone is called, the system is paused automatically.

Muting Audio Volume upon Reception of Phone Call

When the telephone is called...

The Phone Call ("CALL") screen appears, and system is paused.

Phone Call ("CALL") screen



When the call ends...

Hang up the phone.

The system resumes playing automatically.



- To use the TEL Mute feature, you need to hook up the MUTE wire to your telephone using a commercial telephone accessory. Refer to <INSTALLATION MANUAL>.

Character Entry

When you select the Set Station Name mode or others, the following screen appears for character entry.

How To Use the Character Entry Screen

Character Entry screen



- 1 Shifts the cursor.
- 2 Enters characters.
- 3 Scrolls up or down the character button display.
- 4 Sets the key layout of the character buttons.
abc : Alphabetical key layout.
qwe : Qwerty key layout.
- 5 Enters a space.
If you erase a character, locate the cursor on it and touch this button.
- 6 Clears the character.
- 7 Exits the Character Entry mode and returns to the previous screen.



- You can enter characters only after you have applied the parking brake.

Screen Control

Setting the monitor screen.

Screen Control

1 Display Easy Control panel



2 Display the Screen Control screen



3 Adjust the picture quality

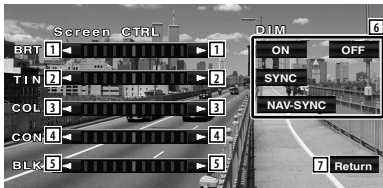

1 Brightness Control

2 Tint Control

Displayed for an NTSC system image on Video, iPod, USB or Rear View Camera.

3 Color Control

Displayed on Video, iPod, USB or Rear View Camera screen only.

4 Contrast Control

5 Black Level Adjustment

6 Dimmer Mode Setup

"ON": The display dims.

"OFF": The display doesn't dim.

"SYNC": Turning the Dimmer function On or Off when the vehicle light control switch is turned On or Off.

"NAV-SYNC" (DNX5120/DNX512EX only):

Turning the Dimmer function On

or Off according to the Navigation Day/Night display setting.

7 Returns to the previous screen.



- The Screen Control screen is displayed only when you have applied the parking brake.
- The picture quality can be set for each source.
- You can set image quality of screens such as menu from <Monitor Setup> (page 68) of the <Setup Menu>.

Hands Free Unit Control

Various functions can be used in the Hands Free control mode. (with the optional accessory Bluetooth unit connected only)



- You need to register your cell-phone to your Bluetooth Unit beforehand. Make sure to read the instruction manual of the Bluetooth Unit as well
- To use the Phonebook, it must have been downloaded from the cell-phone. For more details, see the instruction manual of your Bluetooth Unit and your cell-phone.

Control Screen Function

Displaying the control screen and using various functions.

1 Display the Hands-Free Control screen



Press the [FNC] button for more than 1 second.

or



[TEL] button on the "Source Select" screen



1 Displays the various conditions.

SMS : Displays short message status. If a cell-phone which supports SMS function is not connected, this mark does not appear.

SMS : There is unread short message.

SMS : There is no unread short message.

DL : Downloading Phonebook.

HOLO : Indicates there is a call on hold.

Yell : Displays the signal strength.*

The more the number of bar segments, the stronger the signal.

AUTO : Displays the present Auto Answering status

AUTO : When Auto Answering is on

AUTO : When Auto Answering is off

BATT : Displays the battery drain of the cell-phone.*

The more the number of bar segments, the higher the battery level.

2 Displays the called phone numbers.

If you have registered a phone number in the Phonebook, the destination person name is displayed.

3 Calls the displayed preset phone number.

4 Displays the SMS Select screen.

See <SMS (Short Message Service)> (page 55).

5 Displays the Search for Phonebook screen. See <Calling by Phonebook> (page 47).

6 Displays the Outgoing Calls screen. See <Making a Call Using Outgoing/Incoming Call Records> (page 49).

7 Displays the Incoming Calls screen. See <Making a Call Using Outgoing/Incoming Call Records> (page 49).

8 Calls the preset phone number.

For information on how to preset a phone number, see <Phone Number Preset> (page 54).

9 Displays the Hands-Free Set Up screen. See <Setting Up the Hands-Free Phone> (page 51).

10 Displays the Dialing Display screen. See <Calling by Entering a Phone Number> (page 46).

11 Starts voice recognition. See <Voice Recognition> (page 52).

12 Returns to the previous screen.



- While your car is moving, some functions are disabled for safety's sake. The buttons associated with the disabled functions become ineffective if pressed.
- When the Hands-Free Control screen appears, the name of the connected cell-phone is displayed for 5 seconds.
- * Since the number of steps of the control unit is different from that of the cell-phone, the statuses displayed on the control unit may discord from those displayed on the cell-phone. No status is displayed if information about it cannot be obtained.
- Setting the cell-phone in the private mode can disable the hands-free function.

When Received a Call

When you receive a call, you can use the hands-free phone.

1 Respond to a call



When a call arrives, the Talking screen appears automatically.

- 1 Starts conversation with a person called.
Switches the call destination if you hear a tone of call-waiting.
Resumes conversation with the person on hold after completed conversation with the other party.
- 2 Disconnects the phone.
- 3 Switches the voice output between phone and speaker.
- 4 Outputs dial tone.
See <Controlling Tone-based Services> (page 47).

Calling by Entering a Phone Number

Makes a call by entering a phone number.

1 Display the number input screen



2 Enter a phone number



- 1 Calls the entered phone number.
- 2 Creates an SMS for the entered phone number.
See <SMS (Short Message Service)> (page 55).
- 3 Clears the number.
- 4 Returns to the previous screen.

3 Make a call



You can start talking when the destination responds.

4 End the call



The Hand Free screen reappears.



- You can input max 32 digits.

Quick Dialing

You can register up to 6 phone numbers for quick dialing.



- Phone numbers must be registered in advance.
See <Phone Number Preset> (page 54).

1 Recall the phone number



2 Make a call



Controlling Tone-based Services

Uses tone base service using DTMF (Dual Tone Multi Frequency).

1 Display the DTMF input screen

Display the Talking screen. See <Calling by Entering a Phone Number> (page 46).



2 You can send tones during a call

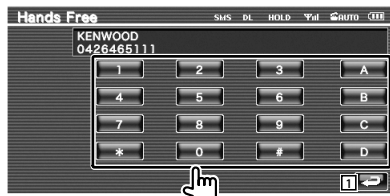

1 Returns to the previous screen.

Calling by Phonebook

You can call a person using his/her phone number that you have registered in the Phonebook.

1 Display the Phonebook screen



The Initial Input screen appears.

2 Select the Phonebook search method

You can search by the initial of the Phonebook data.

Initial alphabet screen



- 1 Displays the Phonebook beginning with the name whose first character you have touched.
- 2 Scrolls the character array display.
- 3 Returns to the Hands-Free Control screen.



Initial number screen



- 4 Displays a list of numbers in the Phonebook starting with the selected number.



Next page ►

Cyrillic alphabet search screen



- 5 Displays the Phonebook beginning with the name whose first character you have touched.

3 Select the name to call



- 6 Phonebook data list.
"REC" turns on for data with voice for voice recognition already registered.
- 7 Scrolls the Phonebook data list.
- 8 Scrolls the name.
- 9 Registers the voice for voice recognition to the selected Phonebook. If there are already 35 voice tag registered in the same cell-phone, [Record] button is deactivated.
See <Voice Recognition> (page 52).
- 10 Plays the voice registered in the selected Phonebook data.
- 11 Deletes the voice registered in the selected Phonebook data.
Touch to display the confirmation screen.
Touch [YES] to delete or [NO] to cancel.
- 12 Displays the detail of the selected Phonebook data.
- 13 Returns to the Initial Input screen.

4 Select the phone number to call



- 14 Calls the selected phone number.
- 15 Creates an SMS for the displayed phone number.
See <SMS (Short Message Service)> (page 55).
- 16 Scrolls the phone number.
- 17 Returns to the Name List screen.

5 Make a call



- To use the Phonebook, it must have been downloaded from the cell-phone. For more details, see the instruction manual of your Bluetooth Unit and your cell-phone.
- Initials including no corresponding name will not be displayed.
- During search, a non-accent character such as "u" is searched for instead of an accent character such as "ü".

Making a Call Using Outgoing/Incoming Call Records

Calls by selecting a phone number from the outgoing or incoming calls list.

1 Display the Outgoing Calls or Incoming Calls screen



 : Outgoing Calls

 : Incoming Calls

The Outgoing Calls or Incoming Calls list screen appears.

2 Select from calls list

Example : Outgoing Calls screen



1 Outgoing Calls list.

2 Scrolls the list.

3 Makes a call to the selected number.

4 Creates an SMS for the selected phone number.

See <SMS (Short Message Service)> (page 55).

5 Displays the detail of the selected phone number.

6 Returns to the Hands-Free Control screen.

3 Make a call



- The Outgoing Calls list screen or Incoming Calls list screen shows the list of the calls originated from or received at this unit. They are not the ones stored in the cell-phone memory.

Calling by Voice Recognition

Calls by recognizing the registered voice.



- In order to perform voice recognition, voice must be registered in the Phonebook data. See <Voice Recognition> (page 52). Or, to perform voice recognition by Phone number category (Home, Office, Mobile etc.) of Phonebook data, a key word voice must be registered. See <Key Word Voice Recognition> (page 53).

1 Display the Voice Recognition screen



2 Utter the voice registered in the PhoneBook

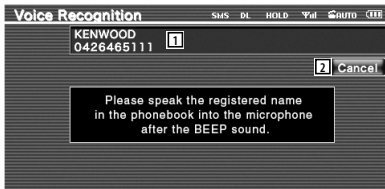

Utter within 2 seconds after the Beep.

- Displays the recognized phone number or address.
- Cancels voice recognition.

If the voice recognition is succeeded and there is only one phone number found:



Make a call.

- Displays the phonebook list.

If you hear another Beep sound:

Speak the key word within 2 seconds after the Beep, or touch the [Phonebook List] button to select the phone number.



Make a call.



- If there are more than one phone numbers registered under the same name, and the key word voice is registered for each phone number, you will hear another beep. For how to register key word, see <Key Word Voice Recognition> (page 53).

If there are more than one phone numbers registered under the same name, go to step 3.

3 Select a Phone number category



- Calls the displayed phone number.
- Creates an SMS to the displayed address. See <SMS (Short Message Service)> (page 55).
- Selects the Phone number category.
- Scrolls the phone number.
- Returns to the previous screen.

4 Make a call



- A message is displayed if the voice is not recognized. Read the message for the further operation.

Setting Up the Hands-Free Phone

The Hands-Free system can be set as follows.

1 Display the Hands Free Setup screen



2 Setup each item



- 1 Moves to the "Hands Free Setup 2" screen.
- 2 Sets an automatic response time after call termination. (☑ "8")
"Off": This function can not use.
"0-99": Sets to calling ring time (second).
- 3 Sets a ringing tone output position. (☑ "Front R")
"Front L": Outputs the tone from the front left-hand side speaker.
"Front R": Outputs the tone from the front right-hand side speaker.
"Front All": Outputs the tone from the both front speakers.
- 4 Sets the beep of the incoming call. (☑ "ON")
"ON": Beep is heard.
"OFF": Beep is canceled.
- 5 Sets the beep of the incoming SMS. (☑ "ON")
"ON": Beep is heard.
"OFF": Beep is canceled.
- 6 Returns to the Hands-Free Control screen.
- 7 Returns to the "Hands Free Setup 1" screen.
- 8 Sets whether to use cell-phone phonebook, outgoing calls list and incoming calls list. (☑ "ON")
"ON": Yes.
"OFF": No.
- 9 Sets the SMS function. (☑ "ON")
"ON": Use SMS function.
"OFF": SMS not available.
- 10 Registers the voice to select phone number category with voice recognition. See <Key Word Voice Recognition> (page 53).
- 11 Registers the phone number to Hands Free Control screen preset button. See <Phone Number Preset> (page 54).
- 12 Returns to the Hands-Free Control screen.



- Either the time interval for automatic answer set on this unit or the time interval set on the cell-phone, whichever is shorter, takes effect.
- Select the speaker which is further from the microphone in order to prevent howling or echoes.

Voice Recognition

Registers voice for voice recognition in Phonebook. Up to 35 voices can be recorded in one cell-phone.

1 Select the name to register

Go through the procedure of <Calling by Phonebook> (page 47).



- 1 Selects a name.
"REC" turns on for data with voice for voice recognition already registered.

2 Display the voice registration screen

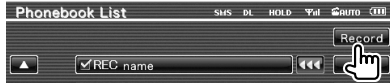

3 Utter the voice to register (1st try)



- 2 Registers the voice.
- 3 Cancels voice registration.

Utter within 2 seconds after the Beep.

4 Utter the voice to register (2nd try)



5 End voice registration

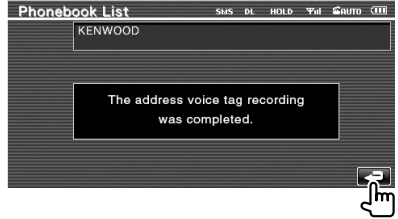

- A message is displayed if the voice is not recognized. Read the message for the further operation.
- Repeat from 1st try if the voice is different from the 1st try.

Key Word Voice Recognition

Registers the voice to select the Phone number category by Voice Recognition.

1 Display the Key Word List screen

Display the "Hands Free" screen and touch [Setup]. See <Control Screen Function> (page 44).



2 Select the Phone number category to register



- 1 Selects the Phone number category. "REC" turns on for data with voice for voice recognition already registered.
- 2 Registers voice for the selected Phone number category.
- 3 Plays voice registered for the selected Phone number category.
- 4 Deletes voice registered for the selected Phone number category. Touch to display the confirmation screen. Touch [YES] to delete or [NO] to cancel.
- 5 Returns to the Hands-Free Set Up screen.

3 Display voice registration screen



4 Utter the voice to register (1st try)



- 6 Registers the voice.
- 7 Cancels voice registration.

Utter within 2 seconds after the Beep.

5 Utter the voice to register (2nd try)



6 End voice registration

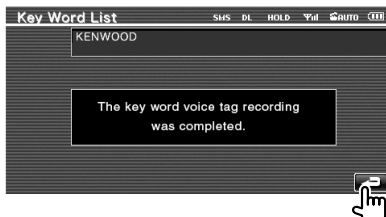

- A message is displayed if the voice is not recognized. Read the message for the further operation.
- Repeat from 1st try if the voice is different from the 1st try.

Phone Number Preset

Registers frequently used phone number to Hands Free control screen preset button.

1 Display the Hands Free Preset List screen

Display the "Hands Free" screen and touch [Setup]. See <Control Screen Function> (page 44).



2 Select the Preset number to register



1 Returns to the Hands-Free Set Up screen.

3 Select the search destination of the number to register



- 2 Registers from SMS incoming calls list.
- 3 Registers from SMS outgoing calls list.
- 4 Registers from Phonebook.
- 5 Registers from outgoing calls list.
- 6 Registers from incoming calls list.
- 7 Registers by entering phone numbers.
- 8 Registers voice for voice recognition to preset number.
- 9 Registers the currently displayed phone number.

- 10 Deletes the currently displayed phone number.
- 11 Returns to the previous screen.

4 Search phone number to register with each function

5 Register phone number



- Press [Delete] to delete the registered phone number.

SMS (Short Message Service)

Uses SMS function.

1 Display the SMS Select screen



2 Select a function



- 1 Displays received message list.
- 2 Displays sent message list.
- 3 Displays the Message screen. If there is an unfinished message, the button will be active.
- 4 Retrieves SMS messages from the cell-phone.
- 5 Returns to the Hands Free screen.

3 Select message to display



- 6 Calls the number in the selected message.
- 7 Creates a new message for the selected message.
- 8 Scrolls the list.
- 9 Displays the selected message.

SMS Message screen

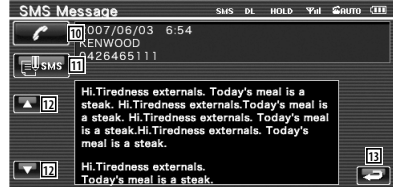

- 10 Calls the number in the selected message.
- 11 Creates a new message for the selected message.
- 12 Scrolls the message.
- 13 Returns to the previous screen.

4 Create a message



- 14 Moves the cursor.
- 15 Displays remaining number of characters allowed.
- 16 Enters character.
- 17 Changes keyboard character type.
- 18 Sends the message.
- 19 Sets the key layout of the character buttons.
abc : Alphabetical key layout.
qwe : Qwerty key layout.
- 20 Enters space.
- 21 Erases the entered character.
If pressed more than 1 second, all the input characters are erased.
- 22 Returns to the previous screen.

Setup Menu

You can set up various receiver parameters.

Setup Menu

Displays the Setup menu to set various functions.

1 Display the control screen of any source



Touch any source button on the "Source Select" screen.

2 Display the Setup Menu

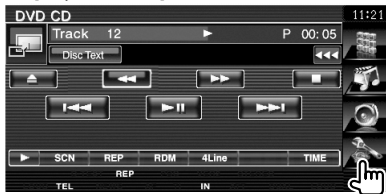

3 Select the setup item

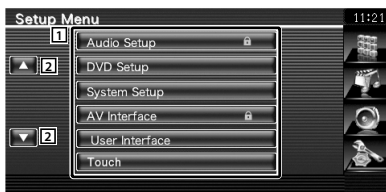

- 1 The selected setup screen appears.
- 2 Scrolls the setup menu.



- [Audio Setup] and [AV Interface] options can be locked. The key mark (🔒) is displayed in reverse video for the locked option. See <Setup Memory> (page 80).

Audio Setup

You can setup a speaker network, etc.

1 Display the Audio Setup screen

Touch **Audio Setup** in the "Setup Menu" screen (page 56).



- [Audio Setup] cannot be selected under the following conditions:
 - When no source is selected.
 - When dual zone function is set to on. See <Zone Control> (page 84).

2 Setup each item



- 1 Selects the speaker to set the crossover. See <Crossover Network Setup> (page 57).
- 2 Sets the availability of subwoofers. This can be selected only when Preout is set to "Subwoofer". See <System Setup> (page 60).
- 3 Selects the type of front speakers.
 - "Standard": Setup for general diameter speakers
 - "Narrow": Setup for small diameter speakers
 - "Middle": Setup for middle diameter speakers
 - "Wide": Setup for large diameter speakers
- 4 Switches to the crossover setup screen. See <Crossover Network Setup> (page 57).

Crossover Network Setup

You can set a crossover frequency of speakers.

1 Select the speaker to set the crossover

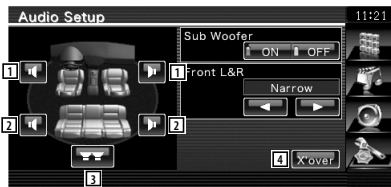

- 1 Sets the High Pass Filter of the front speaker.
- 2 Sets the High Pass Filter of the rear speaker.
- 3 Sets the Low Pass Filter of the sub woofer.
- 4 Switches to the crossover setup screen.

2 Display the Crossover setup screen



3 Set the crossover

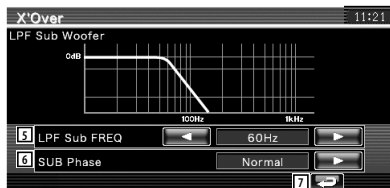

- 5 Sets the cross over frequency.
When front speaker or rear speaker is selected in step 1:
High Pass Filter adjustment
When Subwoofer is selected in step 1 :
Low Pass Filter adjustment
- 6 Sets the sub woofer phase. (Only when "Subwoofer" is set to "ON" in Audio Setup and "LPF SUB FREQ" is set to other than "Through")
- 7 Returns to the "Audio Setup" screen.

DVD Setup

You can set up the DVD play.

1 Display the DVD Setup screen

Touch **DVD Setup** in the "Setup Menu" screen (page 56).

2 Setup each item



- 1 Moves to the "DVD Setup 2" screen.
- 2 Selects a disc menu language.*1
(See <Language Setup>, page 58)
- 3 Selects a subtitle language.*1
(See <Language Setup>, page 58)
- 4 Selects an audio language.*1
(See <Language Setup>, page 58)
- 5 Sets the dynamic range.*1 (Wide)
The dynamic range is reduced by changing from "Wide" to "Normal" and from "Normal" to "Dialog". "Dialog" makes the total sound volume becomes larger as compared with "Wide" and "Normal", allowing you to listen to the movie's dialog more clearly.
This is effective only when you are using a Dolby Digital software.
The operation is available during the play stop mode.



Next page ►

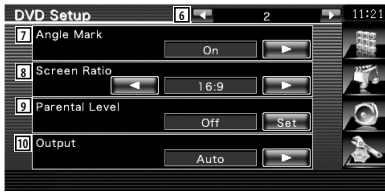

- 6 Returns to the "DVD Setup 1" screen.
- 7 Sets an angle mark display. (✔ "On")
- 8 Selects the screen display mode.*1 (✔ "16:9")
 "16:9": Displays wide pictures.
 "4:3 LB": Displays wide pictures in the Letter Box format (having black stripes at the top and bottom of screen).
 "4:3 PS": Displays wide pictures in the Pan & Scan format (showing pictures cut at the right and left ends).
- 9 Displays the Parental Lock screen.*1 (✔ "Off")
 (See <Parental Level Setup>, page 59)
- 10 Keep "Auto" to use.*1



*1 Disabled when a DVD is being played.

Language Setup

Selects a language you use for the speech and menus.

1 Select the language item to set

See <DVD Setup> (page 57) and select [Menu Language], [Sub Title Language] or [Audio Language].



2 Display the Language Setup screen



- 1 Enters a language code.
- 2 Cancels the language setup and returns to the "DVD Setup 1" screen.
- 3 Sets the original audio language.
 (It appears during Audio Language setup.)
- 4 Sets the language and returns to the "DVD Setup 1" screen.
 (It appears after you have entered a language code.)
- 5 Clears the language code.

3 Enter a language code

See <DVD Language Codes> (page 91) and select the desired language.

4 Set the language you use



Parental Level Setup

Sets a parental level.

1 Display the Parental Level code number screen

See <DVD Setup> (page 57) and touch [Parental Level].



2 Enter the code number

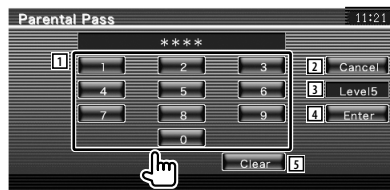

- 1 Enters a code number.
- 2 Cancels the current setup and returns to the "DVD Setup 2" screen.
- 3 Indicates the present parental lock level.
- 4 Determines the code number and displays the Parental Level setup screen.
- 5 Clears the code number.



- The number you enter first is set as your code number.
- You can clear the code number by pressing the Reset button.

3 Display the Parental Level SETUP screen



4 Select a parental level and complete the setup

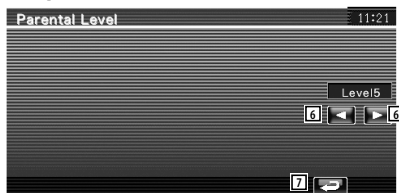

- 6 Selects a parental level.
- 7 Complete the parental level setup and returns to the "DVD Setup 2" screen.



- If a disc has higher parental lock level, you need to enter the code number.
- The parental lock level varies depending on a loaded disc.
- If a disc has no parental lock, anybody can play it back even when you have set the parental lock.

System Setup

You can set up the system parameters.

1 Display the System Setup screen

Touch **System Setup** in the "Setup Menu" screen (page 56).

2 Setup each item



- 1 Moves to the "System Setup 2" screen.
- 2 Turns the key touch tone On or Off. (🔍 "ON")
- 3 Allows scrolling of text display on the Source Control screen. (🔍 "Auto")
 "Auto": Scrolls the screen automatically.
 "Manual": Allows you to scroll the screen manually.
- 4 Selects a remote control signal. (🔍 "ON")
 When turned "OFF", the remote control of TV reception is rejected.
- 5 Sets a music CD playback. (🔍 "1")
 "1": Automatically recognizes and plays back an Audio file disc, a DVD or a music CD.
 "2": Forcibly plays back a disc as a music CD. Select "2" if you wish to play a music CD having a special format or if you cannot play a disc in the "1" position.



- You cannot play an Audio file/VCD disc in the "2" position. Also, you may not play some music CDs in the "2" position.
- Your setup is disabled when the disc is being played.

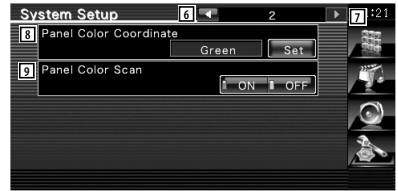

- 6 Returns to the "System Setup 1" screen.
- 7 Moves to the "System Setup 3" screen.
- 8 Sets the button illumination color.
 See <Panel Color Coordinate> (page 61).
- 9 When set to "ON", the illumination color of the screen and buttons changes one after another.



- 10 Returns to the "System Setup 2" screen.
- 11 Moves to the "System Setup 4" screen.
- 12 Sets the Preout output. (Settable only when in Standby mode)
 "Rear": Rear sound is output.
 "Subwoofer": Subwoofer sound is output.
- 13 Sets the function of the [NAV] button.
 "V. OFF": Press the [NAV] button for more than 1 second to turn the display off.
 "R-CAM": Press the [NAV] button for more than 1 second to switch to rear view.



- 14 Returns to the "System Setup 3" screen.



: Press for # seconds.

- 15 Selects a picture display time. (📄 "Middle")
The Display of a JPEG picture is changed.
("Short", "Middle", "Long")

Panel Color Coordinate

Sets the screen and button illumination color.

1 Display the Panel Color Coordinate screen

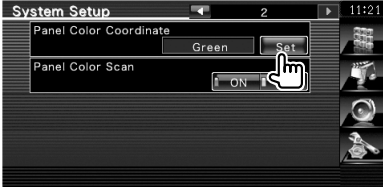

See <System Setup> (page 60).

2 Select a color



- 1 Sets to the touched color.
- 2 Sets and registers favorite color.
- 3 Returns to the "System Setup 2" screen.

To register your original color

1 Start the RGB coordinate



2 Adjust the each color value

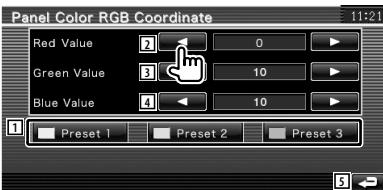

- 1 Selects a preset number to register.
- 2 Adjusts the Red value.
- 3 Adjusts the Green value.

- 4 Adjusts the Blue.
- 5 Returns to the "Panel Color Coordinate" screen.

3 Select a Preset number to register

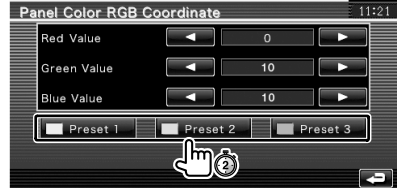

Adjusted color is registered to the selected Preset button.

4 Complete the color coordination



AV Interface Setup

You can set audio and visual (AV) interface parameters.

1 Display the AV Interface screen

Touch **AV Interface** in the "Setup Menu" screen (page 56).

2 Setup each item



- 1 Moves to the "AV Interface 2" screen.
- 2 Sets a name to be displayed when you select a system that is connected via the AV INPUT port. (📎 "VIDEO")
- 3 Sets an image display of the system that is connected via the AV INPUT port. (📎 "OFF")
 "OFF": When the image source is switched, an image entered via the AV INPUT port is displayed.
 "ON": When an image signal is entered via the AV INPUT port, this image is displayed.
- 4 Selects a navigation system connection. (📎)
 "RGB" (DDX512/DDX5032 only)
 "RGB": Allows the Kenwood's Navigation System to connect via the AV INPUT port.
 "AV-IN": Allows a third-party navigation system to connect via the AV INPUT port.
 "Off": Must be used if no navigation system is connected. (The navigation display is cancelled when the AV source is switched.)



- 5 Returns to the "AV Interface 1" screen.
- 6 Moves to the "AV Interface 3" screen.
- 7 Selects an AV source to be output at the AV OUTPUT port. (📎 "AV-IN")



- When in DVD source, "AV-OUT" cannot be set to USB. Or, when in USB source, "AV-OUT" cannot be set to DVD.
- If "AV-OUT" is set to DVD or USB, the same source video or control screen as the front monitor is displayed in the rear monitor.
- If the front source is switched from DVD (or USB) to another source, the rear source is also switched to the same source as front. In this case, displaying the navigation screen in front monitor allows the rear source to return to the DVD (or USB). Use the easy control buttons to operate the front source.

- 8 Sets output of operation screen such as control screen to AV-OUT. Operation screen is not output when set to "Black". (📎 "Through")
- 9 Sets a method to switch to the rear view camera video display. (📎 "OFF")
 "ON": Switches to the rear view camera video display when engaging the shift knob of car to "Reverse".
 "OFF": Switches to the rear view camera video display when engaging the shift knob of car to "Reverse" and then pressing the [NAV] button for more than 1 second.
- 10 You can flip the left and right of the rear view camera video display. Set to "ON" and the the rear view will be displayed left and right in mirror image on the screen. (📎 "OFF")



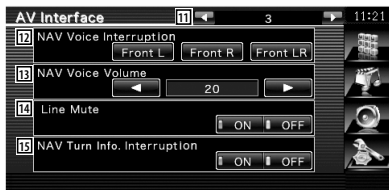

- 11 Returns to the "AV Interface 2" screen.
- 12 Selects speakers used for voice guidance of the navigation system. (📌 "Front L")
 "Front L": Uses the front left side speaker for voice guidance.
 "Front R": Uses the front right side speaker for voice guidance.
 "Front LR": Uses both front speakers for voice guidance.
- 13 Adjusts the volume for voice guidance of the navigation system. (📌 "21")
- 14 Mutes the volume during voice guidance of the navigation system. (📌 "ON")
 When turned "ON", the volume level drops for voice guidance.
- 15 Sets the guide display method of the Navigation system. (📌 "ON") (DNX5120/ DNX512EX only)
 "ON": Pops up the guide.
 "OFF": Guide is not displayed.

User Interface

You can set up user interface parameters.

1 Display the User Interface screen

Touch **User Interface** in the "Setup Menu" screen (page 56).

2 Setup each item



- 1 Moves to the "User Interface 2" screen.
- 2 Selects the background to display.
"Change": Displays images entered into this unit. See <Background Select> (page 67).
- 3 Enables entering or deleting of background images into or from this unit.
Press to enter the USB suspend mode, and then remove the USB device.
"Memory": Enables entering of background images. See <Entering Background> (page 66).
"Delete": Enables deleting of background image entered into this unit. See <Background Delete> (page 66).
- 4 Sets whether to display the target when touching the panel.



- 5 Returns to the "User Interface 1" screen.
- 6 Moves to the "User Interface 3" screen.





- 7 Sets an on-screen display of the iPod Playback screen. ("Auto")
"Auto": Information is displayed for 5 seconds when updated.
"Manual": Information is displayed when you touch on the screen.
- 8 Sets an on-screen display of the navigation screen. () "Off")
"Auto": Information is displayed for 5 seconds when updated.
"Off": Information is not displayed.
- 9 Sets an on-screen display of the video playback screen. () "Auto")
"Auto": Information is displayed for 5 seconds when updated.
"Manual": Information is displayed when you touch on the screen.

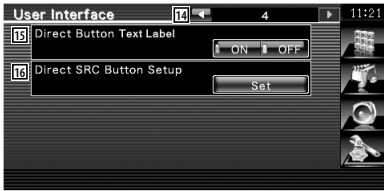

- 10 Returns to the "User Interface 2" screen.
- 11 Moves to the "User Interface 4" screen.
- 12 Sets an on-screen display of the DVD Playback screen. () "Manual")
"Auto": Information is displayed for 5 seconds when updated.
"Manual": Information is displayed when you touch on the screen.
- 13 Sets an on-screen display of the USB Playback screen. () "Manual")
"Auto": Information is displayed for 5 seconds when updated.
"Manual": Information is displayed when you touch on the screen.





- 14 Returns to the "User Interface 3" screen.
- 15 Sets whether to display the name of the , , , and  buttons on the right side of the menu screen.
- 16 Registers the source displayed in the favorite source screen.
See <Direct Source ButtonSetup> (page 65).

Direct Source Button Setup

Registers the source displayed in the favorite source screen.

1 Displays the Direct SRC button Setup screen



See <User Interface> (page 64).

2 Select a preset button

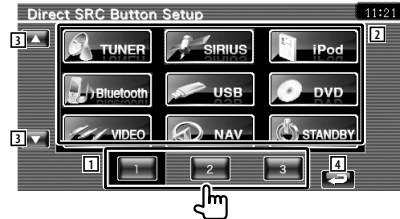

- 1 Selects the preset button to register.
- 2 Selects the source to register.
- 3 Scrolls the source button list.
- 4 Returns to the "User Interface 4" screen.

3 Select a source to register



4 Complete the registration



The selected source is registered to the preset button.

Entering Background

Loads a image for background.

1 Connect the device which has the image to load

2 Display the User Interface screen

Touch **User Interface** in the "Setup Menu" screen (page 56).

3 Display the Background Memory screen

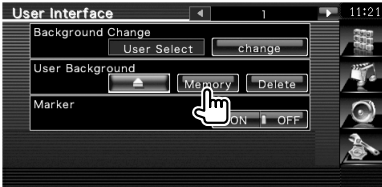

4 Select the image to load

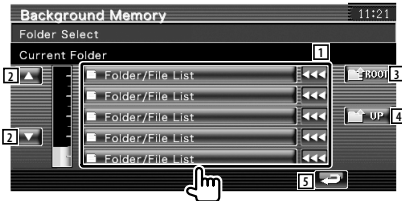

- 1 Lists the files.
- 2 Scroll the list.
- 3 Returns to Media Select screen.
- 4 Returns to the previous folder.
- 5 Returns to the "User Interface" screen.

5 Load the image

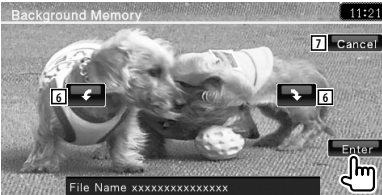

- 6 Rotates the image.
- 7 Returns to the Picture Select screen.



- See <About Picture files> (page 8) for readable image specifications.
- This operation is not possible when USB is selected as the source.

Background Delete

Deletes the background image.

1 Delete the image you have loaded

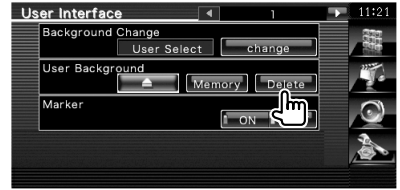

2 Confirm



- 1 Returns to the Pictrue Select screen.

Background Select

Selects a image for background.

1 Select Background Change screen

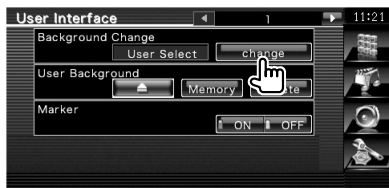

2 Select a image for background

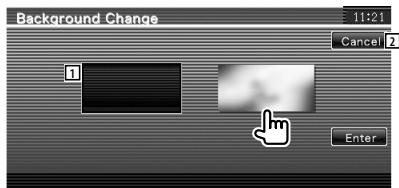

- 1 Returns to the initial background.
- 2 Returns to the original screen.

3 Set the image as the background

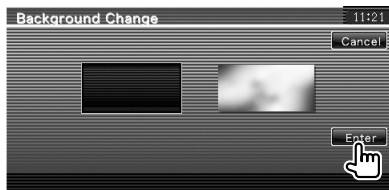

Touch Panel Adjustment

You can adjust the touch panel operations.

1 Display the Touch panel Adjustment screen

Touch **Touch** in the "Setup Menu" screen (page 56).

2 Start Touch panel setup



3 Adjust the Touch panel

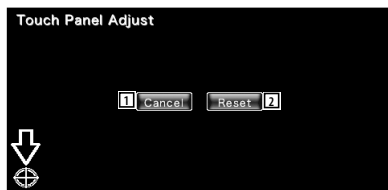

Follow the instruction on the screen and touch the center of .

- 1 Cancels the adjustment and returns to the Touch Panel Adjust screen.
- 2 Resets to the initial status.

Clock Setup

You can adjust the clock time.

1 Display the Clock Setup screen

Touch **Clock** in the "Setup Menu" screen (page 56).

2 Setup the Clock

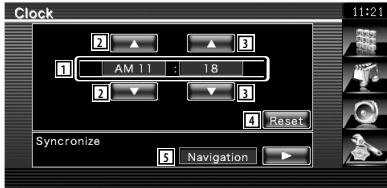

- 1 Clock time display
- 2 Adjusts hours.
- 3 Adjusts minutes.
- 4 Sets "00" minute.
Setup examples: 3:00 – 3:29 ➔ 3:00
3:30 – 3:59 ➔ 4:00
- 5 Sets the clock time in synchronization with the time data sent from the navigation system or the RDS station. (DNX5120/ DNX512EX; DDX512/DDX5032 with KNA-G510)
Sets the clock time in synchronization with the time data sent from the RDS station. (DDX512/DDX5032 with KNA-DV4100, KNA-DV3100 or KNA-DV2100)
When the synchronized mode is set, the clock cannot be adjusted manually.

3 Adjust the clock time

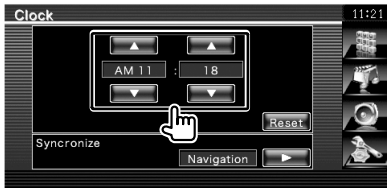

Monitor Setup

You can adjust the position, picture quality and the screen mode of the monitor.

1 Displaying the Monitor SETUP screen

Touch **Monitor Setup** in the "Setup Menu" screen (page 56).

2 Setup each item

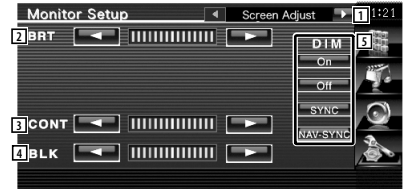

- 1 Moves to "Mode Select 1" screen.
- 2 Brightness control
- 3 Contrast Control
- 4 Black Level Adjustment
- 5 Dimmer Mode Setup
"On": The display dims.
"Off": The display doesn't dim.
"SYNC": Turning the Dimmer function On or Off when the vehicle light control switch is turned On or Off.
"NAV-SYNC" (DNX5120/DNX512EX only): Turning the Dimmer function On or Off according to the Navigation Day/Night display setting.



- In this Screen Control screen, you can perform setups for the menu screen. Setups for videos such as DVD can be performed on the <Screen Control> (page 43).



- 6 Returns to the "Screen Adjust" screen.
- 7 Moves to the "Mode Select 2" screen.

- 8 Selects a screen mode of the DVD playback screen.

You can select any of the following screen mode.

"Full", "Just", "Zoom", "Normal"

- 9 Selects a screen mode of the iPod VIDEO playback screen.

You can select any of the following screen mode.

"Full", "Just", "Zoom", "Normal"

- 10 Selects a screen mode of the USB playback screen.

You can select any of the following screen mode.

"Full", "Just", "Zoom", "Normal"

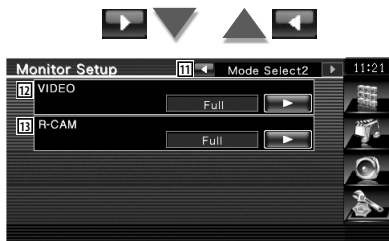

- 11 Returns to the "Mode Select 1" screen.

- 12 Selects a screen mode of the VIDEO playback screen.

You can select any of the following screen mode.

"Full", "Just", "Zoom", "Normal"

- 13 Selects a screen mode of the rear view camera (R-CAM) screen.

You can select any of the following screen mode.

"Full", "Just", "Zoom", "Normal"



- When you select the Menu or Navigation, the display is shown in the full-size display mode automatically. The screen mode of these displays cannot be changed.
- The picture quality can be set for each source.

Full picture mode ("Full")

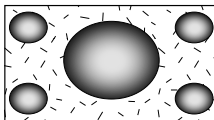

Zoom picture mode ("Zoom")

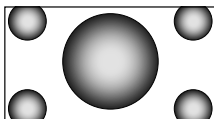

Justify picture mode ("Just")

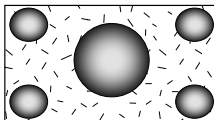

Normal picture mode ("Normal")

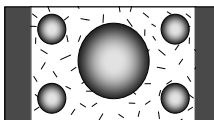

Security Code Setup

You can set a security code to protect your receiver system against theft.



- When the Security Code function is activated, the code cannot be changed and the function cannot be released. Note the Security Code can be set as the 4 digit number of your choice.

1 Display the Security Code Setup screen

Touch **Security Setup** in the "Setup Menu" screen (page 56).



- Displays the Security code input screen.
- Turns the SI function on or off.
If turned "ON", the burglar alarm lamp flashes when the vehicle ignition is off. (📌 "ON")

2 Start Security Code setup



- If you have already completed the code registration, **Clear** is displayed.

3 Enter a security Code

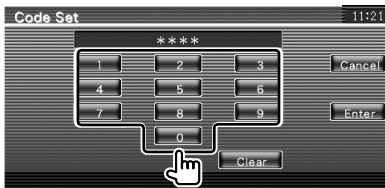

Input four-digit number.

4 Register your security code



5 Reenter the security code

Reenter the same security code as that you have entered in Step 3 for confirmation.



- If you enter a different security code, the screen returns to Step 3 (for the first code entry).

6 Register the security code again



Now, your security code is registered.

If you press the Reset button or if you disconnect your receiver from the battery after the code registration, you need to enter the registered security code.

If you have pressed the Reset button or if you have disconnected the Receiver from battery...

1 Enter the correct security code

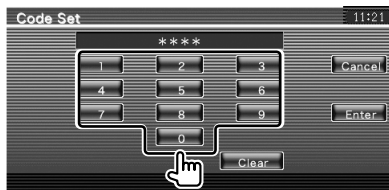

You must enter the same security code as that you have entered in Step 3.

2 Enter the security code



Now, you can use your Receiver.

Deactivating Security Code

To deactivate the Security Code function.

1 Display Security Code Setup screen

Touch **Security Setup** in the "Setup Menu" screen (page 56).

2 Start to cancel a registration of the Security Code



3 Enter a security Code

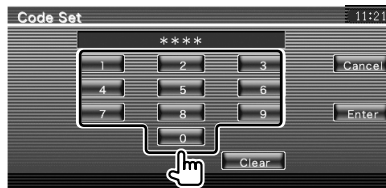

Input by four-digit number.

4 Register your security code



Now, your security code is cleared.

iPod Setup

Performs setup when using iPod.

1 Display the iPod Setup screen

Touch **iPod Setup** in the "Setup Menu" screen (page 56).

2 Setup each item



- 1 Sets the Audio book playback speed.
- 2 Sets Wide Screen on or off.



• "Wide Screen" cannot be set while the iPod is connected.

Sirius Setup

You can set up the Parental lock for Sirius.

1 Display the Sirius Setup screen

Touch **Sirius Setup** in the "Setup Menu" screen (page 56).

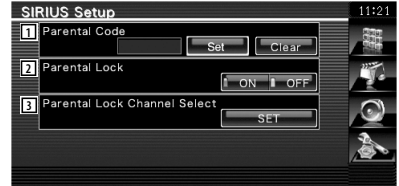

- 1 Sets the Parental lock code.
See <Sirius Parental Code Setup> (Page 73).
- 2 Switch the Parental lock function on and off.
See <Sirius Parental Lock Setup> (Page 74).
- 3 Sets the channel to set parental lock.
See <Sirius Parental Lock Channel Select> (Page 74).

Sirius Parental Code Setup

Sets a Sirius Parental code.

1 Display the Parental Code screen

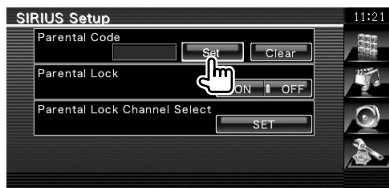

- If you have already completed the code registration, **Change** is displayed.
- If you to clear the code which has already registered, press **Clear**.

2 Enter the current code number

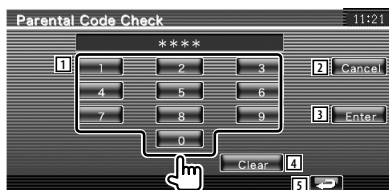

- 1 Enters a code number.
- 2 Cancels to current setup and returns to the SIRIUS Setup screen.
- 3 Determines the code number and displays the Parental Code 1st screen.
- 4 Clears the code number.
- 5 Returns to the "SIRIUS Setup" screen.



- If you are to register the parental code for the first time, this screen will not appear. Go to Step 3.

3 Enter the new code number

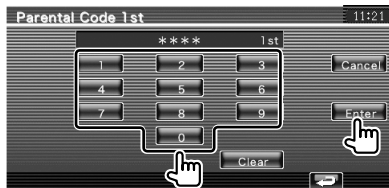

4 Confirm the code number

Enter the same code number as you input in step 3.

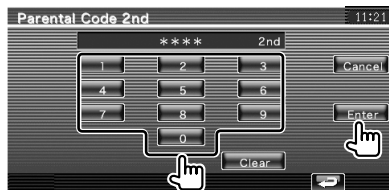

Sirius Parental code is now set, and the display returns to SIRIUS Setup screen.

Sirius Parental Lock Setup

Sets a Sirius Parental Lock function on or off.

1 Display the Parental Code screen

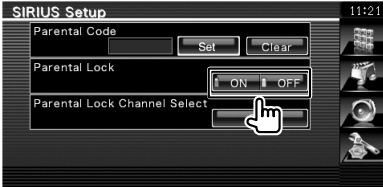

- You need to complete <Sirius Parental Code Setup> beforehand.

2 Enter the code number

Enter the same code number as you input in <Sirius Parental Code Setup>.

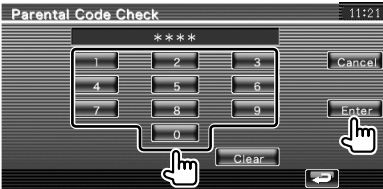

Parental Lock function is now set to on or off, and the display returns to "SIRIUS Setup" screen.



- If you have not registered the parental code, the code number you input in this step will be the number to register as Sirius Parental Code. In this case, you are requested to input the code once more.

Sirius Parental Lock Channel Select

Selects the channel to enable Sirius Parental lock function.

1 Display the Parental Code screen

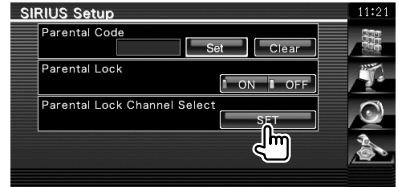

2 Enter the code number

Enter the same code number as you input in <Sirius Parental Code Setup>.

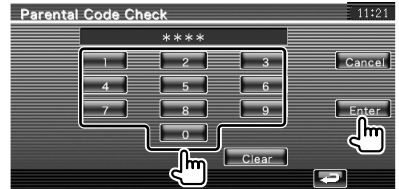

3 Select a category



- Displays all the channels in the selected category.
The category name scrolls by pressing <<<.
- Scrolls the category list.
- Displays all the channels.
- Returns to the "SIRIUS Setup" screen.

4 Set the parental lock for each channel



- 5 Lists the channel.
The channel name scrolls by pressing <<<.
- 6 Scrolls the channel list.
- 7 Sets the Parental lock function on or off for each channel.
You need to input the Parental code to switch the Parental lock function on or off.
- 8 Displays the sort sequence
- 9 Switch the sort sequence of the channel list. ("Channel", "Song title", "Artist", "Composer" and "Category")
- 10 Moves to SIRIUS Category Select Setup screen.
- 11 Returns to the "SIRIUS Setup" screen.

Bluetooth Setup

Registers and selects Bluetooth unit.

1 Display the Bluetooth Setup screen

Touch **Bluetooth Setup** in the "Setup Menu" screen (page 56).

2 Setup each item

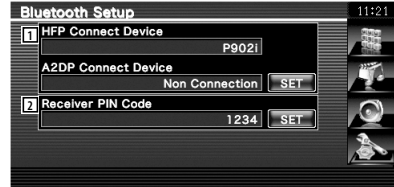

- 1 Sets cell-phone for Hands Free and Audio player for Bluetooth Audio.
- 2 Sets the PIN code of the Bluetooth unit to enter when registering (pairing) from the cell-phone or audio player side.

Registering Bluetooth Unit

Registers the Bluetooth unit to be connected.

1 Display the Connect Device List screen

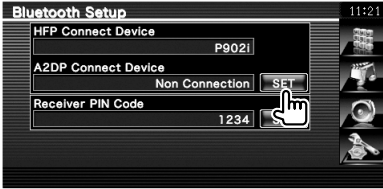

2 Search for a Bluetooth unit



- 1 Displays the registered Bluetooth unit. Displays the busy service in red. Displays the available service in gray.
- 2 Scrolls the name of the Bluetooth unit.
- 3 Searches for Bluetooth unit.
- 4 Registers Bluetooth unit that cannot be registered by normal register (paring) operation.
- 5 Returns to the previous screen.



- A new device cannot be registered if there are 5 registered Bluetooth units. Delete unnecessary registration. See <Deleting Bluetooth Unit> (page 78).

3 Select the Bluetooth unit to register



- 6 Displays the searched Bluetooth unit.
- 7 Scrolls the name of the Bluetooth unit.
- 8 Cancels searching of Bluetooth unit.
- 9 Starts search.
- 10 Scrolls.
- 11 Returns to the previous screen.

4 Enter PIN code

Enter the PIN code specified for the Bluetooth unit to register.

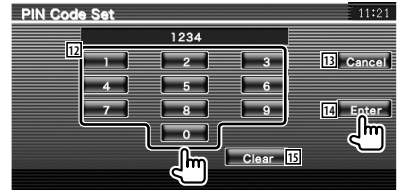

- 12 Enters a code number.
- 13 Cancels registration of PIN code.
- 14 Enters PIN code.
- 15 Clears the code number.



- You can also register from the Bluetooth unit side. For the PIN code necessary for registration, see <Registering Bluetooth Unit PIN Code> (page 77).
- If the error message appears even though the PIN code is correct, try <Registering Special Bluetooth Unit> (page 77).

Registering Bluetooth Unit PIN Code

Sets the PIN code of the Bluetooth unit to enter when registering (pairing) from the cell-phone or audio player side.

1 Display the Receiver PIN Code screen

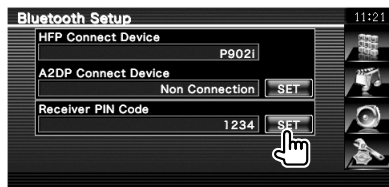

2 Enter PIN code

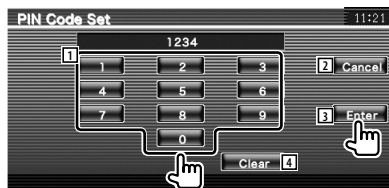

- 1 Enters a code number.
- 2 Cancels registration of PIN code.
- 3 Enters PIN code.
- 4 Clears the code number.

Registering Special Bluetooth Unit

Registers Special Bluetooth unit that results in error by normal operation by selecting from model name.

1 Display the Special Device List screen



2 Select a model name



- 1 Displays the Bluetooth unit name that can be registered.
- 2 Scrolls the name of the Bluetooth unit.
- 3 Scrolls.
- 4 Returns to the previous screen.

3 Confirm whether to register



- 5 Cancels registration.



- Only models in Bluetooth unit name list can be registered.

- 4 Go through the procedure of <Registering Bluetooth Unit> (page 76) and complete the registration (pairing).

Bluetooth Unit Connection

Selects the Bluetooth unit to connect.

1 Display the Connect Device List screen

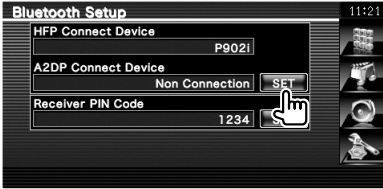

2 Select a registered Bluetooth unit

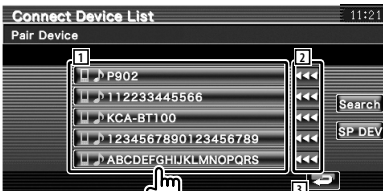

- 1 Displays the registered Bluetooth unit.
- 2 Scrolls the name of the Bluetooth unit.
- 3 Returns to the previous screen.

3 Select the service to use

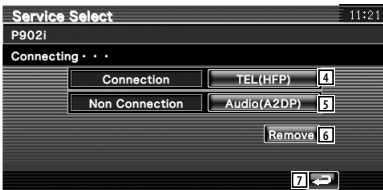

- 4 Connects/disconnects cell-phone to use for Hands Free.
- 5 Connects/disconnects Audio player to use for Bluetooth Audio.
- 6 Deletes registration (pairing).
- 7 Returns to the previous screen.

Deleting Bluetooth Unit

Deletes the registered Bluetooth unit.

1 Display the Connect Device List screen

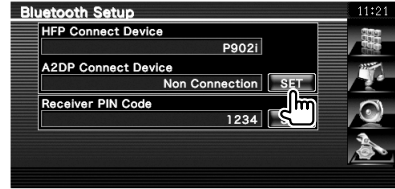

2 Select a Bluetooth unit to delete

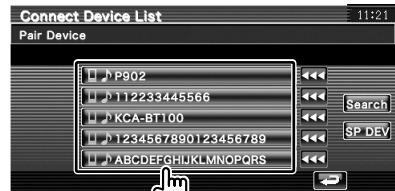

3 Delete the Bluetooth unit

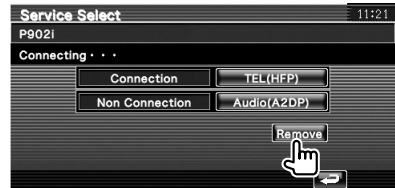

4 Confirm deleting of Bluetooth unit





Software Information

Checks the software version of this unit.

1 Display the Software Information screen

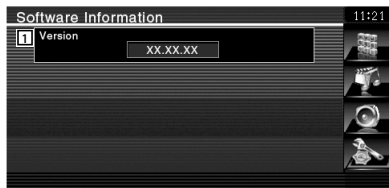
Touch  in the "Setup Menu" screen (page 56).



 Displays the software version.

Setup Memory

Audio Set Up and AV Interface settings can be memorized. The memorized settings can be recalled at any time. For example, even when the settings are cleared due to replacement of the battery, the settings can be restored.

1 Display the Setup Memory screen

Touch **Setup Memory** in the "Setup Menu" screen (page 56).



- 1 Locks the Audio Setup and AV Interface settings. When **Lock** is selected, you cannot set the Audio Setup and AV Interface settings.
- 2 Memorizes or recalls the settings. To cancel the function, touch **No**. To cancel memorization, touch **No**. The "Setup Menu" screen appears again.

2 Start Setup Memory

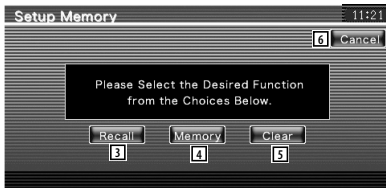

- 3 Recalls the memorized settings.
- 4 Memorizes the current Audio Set Up and AV Interface settings.
- 5 Clears the currently memorized settings.
- 6 Returns to "Setup Memory" screen.

3 Memorize or recall the settings

When memorizing the Audio Setup and AV Interface settings:



If settings have already been memorized, a confirmation message appears. Touch **Yes**. To cancel memorization, touch **No**.

When recalling the memorized settings:



Touching the screen displays a confirmation message. Touch **Yes**. To cancel recalling, touch **No**.

When clearing the currently memorized settings:



Touching the screen displays a confirmation message. Touch **Yes**. To cancel clearing, touch **No**.

4 Quit memorization/recalling of settings

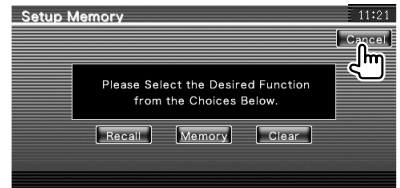

Audio Control

Audio Control Menu

Displays the Audio Control menu to set the sound effect function of this unit.

1 Display the control screen of any source



Touch any source button on the "Source Select" screen.

2 Display the Audio Control menu

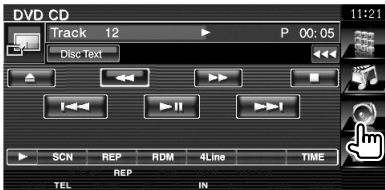

3 Select the Audio Control item

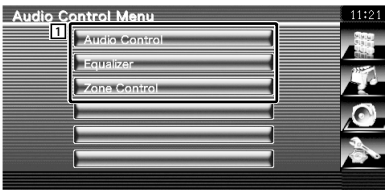

1 Switches to the selected Audio Control screen.

Audio Control

You can adjust the front/rear and right/left audio balance.

1 Display Audio Control screen

Touch **Audio Control** in the "Audio Control Menu" screen (page 82).

2 Set the each item

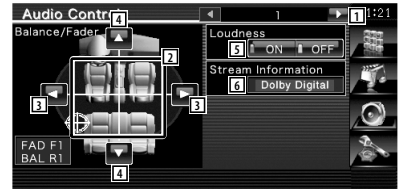

- 1 Moves to the "Audio Control 2" screen.
- 2 Adjust the front/back and left/right volume around the touched area.
- 3 Adjusts the right and left volume balance.
- 4 Adjusts the front and rear volume balance.
- 5 Turns the Loudness control function On or Off.

If turned "ON", high and low tones are automatically enhanced during low volume. Settable Only when zone function is set to Off. See <Zone Control> (page 84).

- 6 Displays the present source information. The stream (Dolby Digital, dts, Linear PCM, MPEG, MP3, WMA or AAC) is displayed.



- 7 Returns to the "Audio Control 1" screen.
- 8 Adjusts the subwoofer volume.

- 9 Adjusts the volume of the present source based on the difference level of original volume.



- If you have increased the volume first, then reduced the volume using the "Vol. Offset", the sound generated if you suddenly switch to another source may be extremely loud.

Equalizer Control

You can set up the equalizer.

1 Display Equalizer Control

Touch **Equalizer** in the "Audio Control Menu" screen (page 82).

2 Display the Equalizer screen



- 1 Selects an equalizer curve type. You can select any of the following equalizer curves.

- "Natural"
- "Rock"
- "Pops"
- "Easy"
- "Top40"
- "Jazz"
- "User"



- "User" can be selected after tone adjustment is carried out. See <Tone Setup> (page 84).

- 2 Selects items to be adjusted for tone curve setup. If turned "OFF", only Level can be setup for tone curves.
- 3 Displays the Tone curve setup screen. (page 84)

Tone Setup

You can set a Tone curve.

1 Display the Tone screen

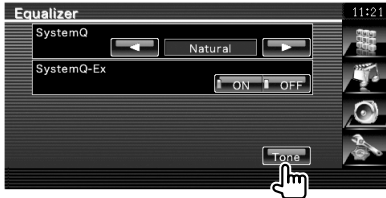

See <Equalizer Control> (page 83).

2 Set the Tone



- 1 Tone curve becomes flat.
- 2 Bass adjustment items are displayed.
- 3 Middle adjustment items are displayed.
- 4 Treble adjustment items are displayed.
- 5 Sets the Center frequency.
- 6 Sets the level.
- 7 Sets the Q factor. (Only Bass and Middle can be set)
- 8 Bass DC Extend settings (Only when Bass is selected)
If turned "ON", it extends the bass center frequency to the low register by approximately 20%.
- 9 Returns to the "Equalizer" screen.

Zone Control

You can set the front and rear audio source.

1 Display Zone Control

Touch **Zone Control** in the "Audio Control Menu" screen (page 82).



- 1 Displays the current source.

2 Set the Zone Control

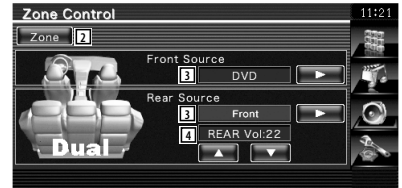

- 2 Turns the Zone Function (that sets different source sounds for front and rear speakers) On or Off.
- 3 Sets the front and rear audio source separately.
(This button appears when the Zone function is On.)



- When the rear speaker sound is switched, the audio source that is output at the AV OUTPUT terminal is also switched to the same source.

- 4 Adjusts the volume of the rear channel.
(This button appears when the Zone function is On.)



- There are following limitations when zone function is set to "On".
 - There is no output from the subwoofer.
 - <Audio Setup> (page 56) and <Equalizer Control> (page 83) are not available.
 - When "DVD" or "USB" is selected as the front source, the rear source can be selected from "Front" (same source as front), "iPod" or "VIDEO", etc. When the rear source is

set to "Front", "DVD" or "USB", the same source screen or control screen is displayed in the rear monitor. See <AV Interface Setup> (page 62).

Remote Controller

This unit can be operated using the optional Remote Controller KNA-RCDV330.



- Put the Remote Controller in a place where it will not move during braking or other operations. A dangerous situation could result, if the Remote Controller falls down and gets wedged under the pedals while driving.
- Do not place the battery near an open flame or heat source. This may cause the battery to explode.
- Do not recharge, short, break up or heat the battery or place it in an open fire. Such actions may cause the battery to leak fluid. If spilled fluid comes in contact with your eyes or on clothing, immediately rinse with water and consult a physician.
- Place the battery out of reach of children. In the unlikely event that a child swallows the battery, immediately consult a physician.

Battery installation

Use two "AAA"/"R03"-size batteries.

Insert the batteries with the + and - poles aligned properly, following the illustration inside the case.

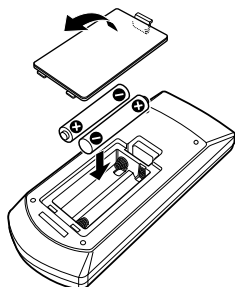

- If the Remote Controller operates only over shorter distances or does not operate at all, it is possible that the batteries are depleted. In such instances, replace the both batteries with new ones.

Remote Controller mode switch

The functions operated from the remote controller differ depending on the position of the mode switch.

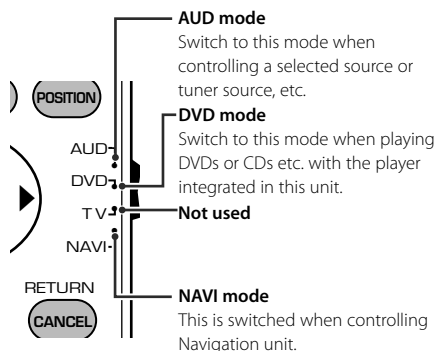

- The position of the remote control mode switch is indicated in the title of each mode, e.g., "(AUD mode)".
- When controlling a player that is not integrated in the unit, select "AUD" mode.

Common operations (AUD mode)

Source switching

Switches to the source to be played.

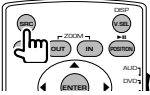

Volume control

Adjusts the volume.

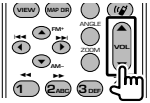

Volume attenuator

Press the key once to lower the volume. Press again to restore the previous volume.

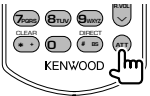

Dual Zone

Switches the Dual Zone function ON and OFF.

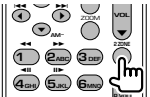

Rear volume control

Adjusts volume at rear when the Dual Zone function is ON.

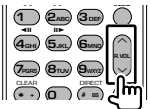

V.SEL

Switches to the navigation screen.

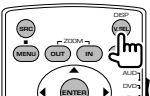

Cursor key

Moves the cursor when displaying menu.

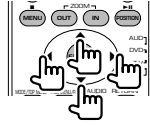

ENTER

Enters options.

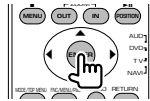

Hands-free communication

Enters the dialing method selection mode.

When a call comes in, it answers the call.



Function

Switches the function screen.



MODE

Switches the screen mode.

Screen mode changes each time you press this key.



DVD/VCD/CD/Audio files (DVD mode)

Folder search

Selects the folder to be played.

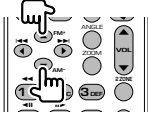

Track search and file search

Selects the track or file to be played.

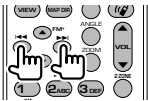

Play/Pause

Pauses the track.

Press again to resume playing.

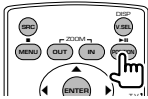

Stop

Memorizes the last point where the disc stopped. When pressed again, the last point is deleted.

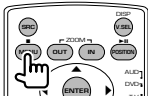

Direct search

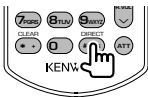

Pressing this button switches the features that can be searched directly.

DVD

- _____ Title number
- _____ Chapter number
- _____ Play time
- _____ Item number*
- _____ Cancel

* You may not be able to use this function with some discs or scenes.

CD

- _____ Track number
- _____ Play time
- _____ Cancel

Audio files

- _____ Folder number
- _____ File number
- _____ Cancel

VCD 1.X, VCD 2.X (PBC OFF)

- _____ Track number
- _____ Cancel

VCD 2.X (PBC ON)

- _____ Scene number
- _____ Number
- _____ Cancel

Once you have switched to the direct search feature, specify the search number from the numeric keypad, and then press [ENTER] key.

Numeric keypad

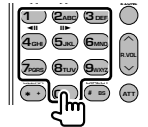

- Specify the number to search in direct search.
- Press **1** **2** to fast forward/backward. Switches the fast forward/backward speed each time you press this key.
- Press **4** **5** to slow forward/backward. Switches the slow playback speed each time you press this key.

DVD Top Menu

Returns to the DVD top menu.



DVD Menu

Displays the DVD menu.

Turns the playback control on or off while playing VCD.



SUBTITLE

Switches the subtitle language.



ZOOM

Switches the zoom ratio each time you press this key.

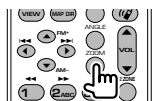

Picture Angle

Switches the picture angle each time you press this key.

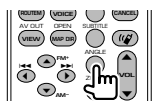

AUDIO

Switch Voice Language

Switches the voice language each time you press this key.



Radio (AUD mode)

Band switching

Switches to bands received by the unit.

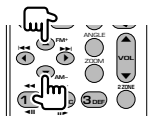

Station selection

Switches to broadcast stations received by the unit.

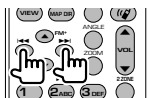

Direct tuning

After pressing this key, use the keypad to specify the broadcast station you wish to receive.

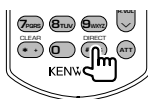

Example: 92.1MHz (FM)

0 **9** **MHZ** **2** **ABS** **1**

Example: 810kHz (AM)

0 **8** **FLW** **1** **0**

Numeric keypad

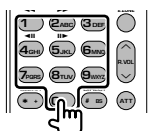

- To use preset tuning, press the number of a programmed broadcast station. (**1** – **6** **MHz**)
- Press the direct tuning key first, then specify the frequency of the station to receive.

NAVI (NAVI mode)

Joystick

Scrolls the map, or moves the cursor.

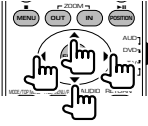

ENTER

Performs the selected function.

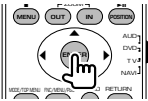

ZOOM

Zooms in or out the navigation map.

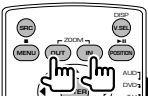

MENU

Displays Main menu.

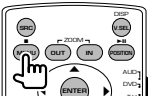

CANCEL

Displays previous screen.

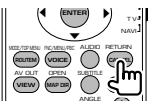

POSITION

Displays the current position.

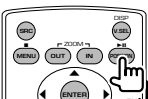

ROUTE M

Displays Route Option menu.

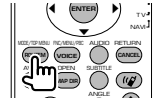

VIEW

Switches between 2D and 3D map displays.

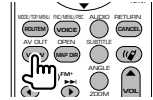

VOICE

Plays Voice guidance.

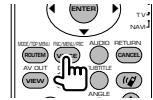

MAP DIR

Switches between the heading up navigation and north up navigation map displays.

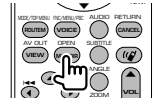

DVD Language Codes

Code	Language
aa	Afar
ab	Abkhazian
af	Afrikaans
am	Amharic
ar	Arabic
as	Assamese
ay	Aymara
az	Azerbaijani
ba	Bashkir
be	Byelorussian
bg	Bulgarian
bh	Bihari
bi	Bislama
bn	Bengali, Bangla
bo	Tibetan
br	Breton
ca	Catalan
co	Corsican
cs	Czech
cy	Welsh
da	Danish
de	German
dz	Bhutani
el	Greek
en	English
eo	Esperanto
es	Spanish
et	Estonian
eu	Basque
fa	Persian
fi	Finnish
fj	Fiji
fo	Faroese
fr	French
fy	Frisian
ga	Irish
gd	Scots Gaelic
gli	Galician
gn	Guarani
gu	Gujarati
ha	Hausa
he	Hebrew
hi	Hindi
hr	Croatian
hu	Hungarian
hy	Armenian
ia	Interlingua
ie	Interlingue
ik	Inupiak
id	Indonesian

Code	Language
is	Icelandic
it	Italian
ja	Japanese
jav	Javanese
ka	Georgian
kk	Kazakh
kl	Greenlandic
km	Cambodian
kn	Kannada
ko	Korean
ks	Kashmiri
ku	Kurdish
ky	Kirghiz
la	Latin
lb	Luxembourgish
ln	Lingala
lo	Laotian
lt	Lithuanian
lv	Latvian, Lettish
mg	Malagasy
mi	Maori
mik	Macedonian
ml	Malayalam
mn	Mongolian
mo	Moldavian
mr	Marathi
ms	Malay
mt	Maltese
my	Burmese
na	Nauru
ne	Nepali
nl	Dutch
no	Norwegian
oc	Occitan
om	(Afan) Oromo
or	Oriya
pa	Punjabi
pl	Polish
ps	Pashto, Pushto
pt	Portuguese
qu	Quechua
rm	Rhaeto-Romance
rn	Kirundi
ro	Romanian
ru	Russian
rw	Kinyarwanda
sa	Sanskrit
sd	Sindhi
sg	Sangho
sh	Serbo-Croatian

Code	Language
si	Singhalese
sk	Slovak
sl	Slovenian
sm	Samoa
sn	Shona
so	Somali
sq	Albanian
sr	Serbian
ss	Siswati
st	Sesotho
su	Sundanese
sv	Swedish
sw	Swahili
ta	Tamil
te	Telugu
tg	Tajik
th	Thai
ti	Tigrinya
tk	Turkmen
tl	Tagalog
tn	Setswana
to	Tongan
tr	Turkish
ts	Tsonga
tt	Tatar
tw	Twi
uk	Ukrainian
ur	Urdu
uz	Uzbek
vi	Vietnamese
vo	Volapuk
wo	Wolof
xh	Xhosa
yo	Yoruba
zh	Chinese
zu	Zulu

Help? Troubleshooting

Some functions of this unit may be disabled by some settings made on this unit.

- ❗ **Cannot set up the subwoofer.**
- ❗ **Cannot set up subwoofer phase.**
- ❗ **No output from the subwoofer.**
- ❗ **Cannot set up the low pass filter.**
- ❗ **Cannot set up the high pass filter.**
- ▶ Subwoofer is not set to On. ⓘ <Audio Setup> (page 56)
- ▶ Preout is set to "Rear". ⓘ <System Setup> (page 60)
- ▶ The Dual zone function is enabled. ⓘ <Zone Control> (page 84)

- ❗ **Cannot set up the subwoofer phase.**
- ▶ Subwoofer is not set to On. ⓘ <Audio Setup> (page 56)
- ▶ Low pass filter is set to Through. ⓘ <Crossover Network Setup> (page 57)

- ❗ **Cannot select the output destination of the subsource in the Dual zone.**
- ❗ **Cannot adjust the volume of the rear speakers.**
- ▶ The Dual zone function is disabled. ⓘ <Zone Control> (page 84)

- ❗ **Cannot play audio files.**
- ▶ "CD Read" of <System Setup> (page 60) is set to "2".

- ❗ **Cannot Folder select.**
- ▶ The Scan play or Random play function is enabled.

- ❗ **Cannot perform Repeat play.**
- ▶ The PBC function is enabled.

- ❗ **Cannot set up the equalizer.**
- ❗ **Cannot set up the crossover network.**
- ▶ The Dual zone function is enabled. ⓘ <Zone Control> (page 84)

- ❗ **Cannot watch the source selected as AV-OUT in the rear monitor.**
- ▶ A source control screen is displayed in front. ⓘ <AV Interface Setup> (page 62)
- ▶ "AV-OUT Graphic Output" of <AV Interface Setup> is set to "Black".

What might seem to be a malfunction in your unit may just be the result of slight misoperation or miswiring. Before calling service, first check the following table for possible problems.

General

- ❓ **The Touch Sensor Tone doesn't sound.**
- ✓ The preout jack is being used.
- ⓘ The Touch Sensor Tone can't be output from the preout jack.

Tuner source

- ❓ **Radio reception is poor.**
- ✓ The car antenna is not extended.
- ⓘ Pull the antenna out all the way.
- ✓ The antenna control wire is not connected.
- ⓘ Connect the wire correctly, referring to the section on <INSTALLATION MANUAL>.

Disc source

- ❓ **The specified disc does not play, but another one plays instead.**
- ✓ The specified disc is quite dirty.
- ⓘ Clean the disc.
- ✓ The disc is severely scratched.
- ⓘ Try another disc instead.

Audio file source

- ❓ **The sound skips when an Audio file is being played.**
- ✓ The media is scratched or dirty.
- ⓘ Clean the media, referring to the CD cleaning of the section on <Handling discs> (page 6).
- ✓ The recording condition is bad.
- ⓘ Record the media again or use another media.

Navigation

- ❓ **The touch panel control of the navigation system does not work.**
- ✓ Navigation software is not the latest version.
- ⓘ Update the navigation software. For how to update the software, refer to the instruction manual of the navigation unit.

When the unit fails to operate correctly, the cause of the failure appears on the display.

Protect :

Protective circuit has been activated because a speaker cord has shorted or it has come in contact with the car chassis.

- ➔ Wire or insulate the speaker cord as appropriate and then push the Reset button (page 6).
-

Hot Error :

When the internal temperature of this unit rises to 60°C or more, the protection circuit is activated and you may not be able to operate the unit. At such times this message will appear.

- ➔ Use the unit again after reducing the temperature inside the vehicle.
-

Hold Error :

Activation of the protective circuit when the temperature inside the disc changer is higher than 60 degrees Celsius stops the disc changer from operating. At such times this message will appear.

- ➔ Use when the temperature at the site where the disc changer has been fitted has dropped.
-

Mecha Error :

The disc player is malfunctioning.

- ➔ Eject the disc and try inserting it again. Contact the Kenwood dealer if this indicator continues blinking or the disc cannot be ejected.
-

Disc Error :

An unplayable disc is inserted.

Read Error :

Disc is quite dirty.

- ➔ Clean the disc, referring to the section on <Handling discs> (page 6).

Disc is upside down.

- ➔ Load the disc with the labeled side up.
-

Region code Error :

The disc you wanted to play has a region code that cannot be played with this unit.

Parental level Error:

The disc you wanted to play has a higher level than the parental level you set.

Error 07-67:

The unit is not operating correctly due to some reason or other.

- ➔ Push the unit's Reset button. If the "Error 07-67" message does not disappear, see your nearest Kenwood dealer.
-

No Device (USB device)/Disconnected (iPod):

The USB device/iPod is selected as a source although no USB device/iPod is connected.

- ➔ Change the source to any source other than USB/iPod. Connect an USB device/iPod, and change the source to USB/iPod again.
-

No Music:

The connected USB device contains no playable audio file.

Media was played that doesn't have data recorded that the unit can play.

USB Device Error!:

The connected USB device is rated a current capacity higher than the allowable limit.

- ➔ Check the USB device. Some trouble may have occurred to the connected USB device.
 - ➔ Change the source to any source other than USB. Remove the USB device.
-

Authorization Error:

Connection to the iPod has failed.

- ➔ Remove the iPod and then reconnect it. The unit does not support the iPod.
 - ➔ See <iPod that can be connected to this unit> (page 7).
-

Update your iPod:

The iPod's software is an older version which the unit can not support.

- ➔ Confirm that the software for the iPod is the latest version. See <iPod that can be connected to this unit> (page 7).
-

Check Sirius:

The unit cannot recognize the connected Sirius Tuner Box.

- ➔ Check the connection of the Sirius Tuner Box.

Antenna Error:

Something is wrong with the antenna.

- ➔ Check the connection of the antenna.

Acquiring Signal:

The unit cannot receive any signal.

- ➔ Move the vehicle to the area where the unit can receive signal.

Updating Firmware:

Updating the firmware of Sirius tuner.

- ➔ Operation is invalid until the update is completed.

Updating Channels **% Completed:

Updating the Sirius Channel Map.

- ➔ Operation is invalid until the update is completed.

Subscription Updated:

Updating the subscription information.

- ➔ Operation is invalid until the update is completed.

Invalid Channel:

The selected channel is invalid.

- ➔ Select a different channel.

Call 888-539-SIRIUS to Subscribe:

The selected channel is not subscribed.

- ➔ Call the displayed number for subscription.

CHECK XM TUNER:

The unit cannot recognize the connected XM Tuner.

- ➔ Check the connection of the XM Tuner.

NO SIGNAL:

The unit cannot receive any signal.

- ➔ Check the connection of the antenna.

CHECK ANTENNA:

Something is wrong with the antenna.

- ➔ Check the connection of the antenna.

CH UNAVAILABLE:

The selected channel is invalid.

- ➔ Select a different channel.

CH UNAUTHORIZED:

The selected channel is not subscribed.

OFF AIR:

The broadcast of the selected channel has finished.

Specifications

Monitor section

Picture Size

: 6.1 inches (diagonal) wide
: 136.08 mm (W) x 71.96 mm (H)

Display System

: Transparent TN LCD panel

Drive System

: TFT active matrix system

Number of Pixels

: 336,960 (480H x 234V x RGB)

Effective Pixels

: 99.99 %

Pixel Arrangement

: RGB striped arrangement

Back Lighting

: Cold Cathode Fluorescent Tube

DVD player section

D/A Converter

: 24 bit

Audio Decoder

: Linear PCM/ Dolby Digital/ dts/ MP3/ WMA/ AAC

Video Decoder

: MPEG1/ MPEG2

Wow & Flutter

: Below Measurable Limit

Frequency Response

Sampling frequency; 96 kHz : 20 – 44,000 Hz
Sampling frequency; 48 kHz : 20 – 22,000 Hz
Sampling frequency; 44.1 kHz : 20 – 20,000 Hz

Total Harmonic Distortion

: 0.010 % (1 kHz)

S/N Ratio (dB)

: 98 dB (DVD-Video 96 kHz)

Dynamic Range

: 98 dB (DVD-Video 96 kHz)

Disc Format

: DVD-Video/ VIDEO-CD/ CD-DA

Sampling Frequency

: 44.1/ 48/ 96 kHz

Quantifying Bit Number

: 16/ 20/ 24 bit

USB interface section

USB Standard

: USB 1.1/ 2.0

File System

: FAT 16/ 32

Maximum Power Supply Current

: 500 mA

D/A Converter

: 24 Bit

Audio Decoder

: MP3/ WMA/ AAC

Video Decoder

: MPEG1/ MPEG2

FM tuner section

Frequency Range (200 kHz)

: 87.9 MHz – 107.9 MHz

Usable Sensitivity (S/N : 30 dB)

: 9.3 dBf (0.8 μ V/ 75 Ω)

Quieting Sensitivity (S/N : 50 dB)

: 15.2 dBf (1.6 μ V/ 75 Ω)

Frequency Response (\pm 3.0 dB)

: 30 Hz – 15 kHz

S/N Ratio (dB)

: 70 dB (MONO)

Selectivity (\pm 400 kHz)

: \geq 80 dB

Stereo Separation

: 40 dB (1 kHz)

AM tuner section

Frequency Range (10 kHz)

: 530 kHz – 1700 kHz

Usable Sensitivity

: 28 dB μ

Video section

Color System of External Video Input

: NTSC

External Video Input Level (mini jack)

: 1 V_{p-p}/ 75 Ω

External Audio Max Input Level (mini jack)

: 2 V/ 25 kΩ

Video Output Level (RCA jacks)

: 1 V_{p-p}/ 75 Ω

Audio Output Level (RCA jacks)

: 1.2 V/ 10 kΩ

Analog RGB input (DDX512/DDX5032 only)

: 0.7 V_{p-p}/ 75 Ω

Audio section

Maximum Power (Front & Rear)

: 50 W x 4

Full Bandwidth Power (Front & Rear)

(4 Ω, 14.4 V, 1 % THD)

: 22 W x 4

Preout Level (V)

: 2 V/ 10 kΩ

Preout Impedance

: 600 Ω

Speaker Impedance

: 4 – 8 Ω

Tone action

Bass : 100 Hz ± 10 dB

Middle : 1 kHz ± 10 dB

Treble : 10 kHz ± 10 dB

Navigation section (DNX5120/DNX512EX only)

Receiver

: High-sensitivity GPS receiver

Reception Frequency

: 1575.42 MHz (C/A code)

Acquisition Times

Cold : < 38 seconds

Factory Reset : < 45 seconds

(On average for a stationary receiver with a clear view of the sky)

Accuracy

Position : < 10 meters typical

Velocity : 0.05 m/sec. RMS

Position Method

: GPS

Antenna

: External GPS antenna

General

Operating voltage

: 14.4 V (11 – 16 V allowable)

Current Consumption

: 15 A

Dimensions (W × H × D)

: 182 × 112 × 158 mm

7-3/16 x 4-7/16 x 6-1/4 inch

Operational Temperature Range

: -10 °C – +60 °C

Storage Temperature Range

: -20 °C – +85 °C

Weight (DNX5120/DNX512EX)

: 1.90 kg (4.2 lbs)

Weight (DDX512/DDX5032)

: 1.87 kg (4.1 lbs)

Specifications subject to change without notice.

Although the effective pixels for the liquid crystal panel is given as 99.99% or more, 0.01% of pixels may not light or may light incorrectly.

The "AAC" logo is trademark of Dolby Laboratories.

Apple, the Apple logo, and iPod are trademarks of Apple Inc., registered in the U.S. and other countries.

 is a trademark of DVD Format/Logo Licensing Corporation registered in the U.S., Japan and other countries.

This product incorporates copyright protection technology that is protected by U.S. patents and other intellectual property rights. Use of this copyright protection technology must be authorized by Macrovision, and is intended for home and other limited viewing uses only unless otherwise authorized by Macrovision. Reverse engineering or disassembly is prohibited.

Manufactured under license from Dolby Laboratories.
"Dolby" and the double-D symbol are trademarks of Dolby Laboratories.

"DTS" and "DTS 2.0 + Digital Out" are trademarks of Digital Theater Systems, Inc.

▲CAUTION

Use of controls or adjustments or performance of procedures other than those specified herein may result in hazardous radiation exposure.
In compliance with Federal Regulations, following are reproductions of labels on, or inside the product relating to laser product safety.

Kenwood Corporation
2967-3, ISHIKAWA-MACHI,
HACHIOJI-SHI
TOKYO, JAPAN

KENWOOD CORP. CERTIFIES THIS EQUIPMENT
CONFORMS TO DHHS REGULATIONS NO.21 CFR
1040. 10, CHAPTER 1, SUBCHAPTER J.

Location : Bottom Panel

FCC WARNING

This equipment may generate or use radio frequency energy. Changes or modifications to this equipment may cause harmful interference unless the modifications are expressly approved in the instruction manual. The user could lose the authority to operate this equipment if an unauthorized change or modification is made.

NOTE

This equipment has been tested and found to comply with the limits for a Class B digital device, pursuant to Part 15 of the FCC Rules. These limits are designed to provide reasonable protection against harmful interference in a residential installation. This equipment may cause harmful interference to radio communications, if it is not installed and used in accordance with the instructions. However, there is no guarantee that interference will not occur in a particular installation. If this equipment does cause harmful interference to radio or television reception, which can be determined by turning the equipment off and on, the user is encouraged to try to correct the interference by one or more of the following measures:

- Reorient or relocate the receiving antenna.
- Increase the separation between the equipment and receiver.
- Connect the equipment into an outlet on a circuit different from that to which the receiver is connected.
- Consult the dealer or an experienced radio/TV technician for help.

KENWOOD

Free Manuals Download Website

<http://myh66.com>

<http://usermanuals.us>

<http://www.somanuals.com>

<http://www.4manuals.cc>

<http://www.manual-lib.com>

<http://www.404manual.com>

<http://www.luxmanual.com>

<http://aubethermostatmanual.com>

Golf course search by state

<http://golfingnear.com>

Email search by domain

<http://emailbydomain.com>

Auto manuals search

<http://auto.somanuals.com>

TV manuals search

<http://tv.somanuals.com>