

# KENWOOD

## DNX891HD DNX7710BT DNX771HD DNX691HD DNX571HD DNX571EX DNX5710BT

GPS NAVIGATION SYSTEM

### Quick Start Guide

SISTEMA DE NAVEGACIÓN GPS

### Guía de inicio rápido

JVCKENWOOD Corporation

- You can update the system by connecting a USB device containing an update file. For updating the system, visit <<http://www2.jvckenwood.com/cs/ce/>>.
- Puede actualizar el sistema conectando un dispositivo USB que incluya un archivo de actualización. Para actualizar el sistema, visite <<http://www2.jvckenwood.com/cs/ce/>>.

**Take the time to read through this instruction manual.**

**Familiarity with installation and operation procedures will help you obtain the best performance from your new GPS Navigation System.**

#### **For your records**

Record the serial number, found on the back of the unit, in the spaces designated on the warranty card, and in the space provided below. Refer to the model and serial numbers whenever you call upon your Kenwood dealer for information or service on the product.

Model DNX891HD/ DNX7710BT/ DNX771HD/ DNX691HD/ DNX571HD/ DNX571EX/ DNX5710BT

Serial number \_\_\_\_\_

#### **US Residence Only**

### Register Online

Register your Kenwood product at [www.Kenwoodusa.com](http://www.Kenwoodusa.com)

## Contents

About the Quick start guide .....	2
Precautions .....	3
Safety Precautions and Important Information.....	5
First Step.....	6
Functions of the Buttons on the Front Panel .	8
Common Operations.....	10
How to Use the Navigation System .....	11
How to Play Music.....	13
How to Play Movie/Picture.....	14
How to Listen to the Radio/ HD Radio™ Tuner/ SiriusXM® .....	15
How to Make a Phone Call.....	15
Installation.....	17
About this Unit.....	25

## About the Quick start guide

This Quick Start Guide describes basic functions of this unit.

For functions not described in this Guide, refer to the Instruction Manual on the following website:

<http://manual.kenwood.com/edition/im382/>

To refer to Instruction manual, a PC loaded with Microsoft® Windows XP/Vista/7 or Mac OS X® 10.4 or later is required in addition to Adobe® Reader™ 7.1 or Adobe® Acrobat® 7.1 or later.

The Instruction manual is subject to change for modification of specifications and so forth. Be sure to download the latest edition of the Instruction manual for reference.

### NOTE

- The panels shown in this guide are examples used to provide clear explanations of the operations. For this reason, they may be different from the actual panels.
- In this manual, each model name is abbreviated as follows.
  - DNX891HD: **DNX8**
  - DNX7710BT, DNX771HD: **DNX7**
  - DNX691HD: **DNX6**
  - DNX571HD, DNX5710BT, DNX571EX: **DNX5**If above icons are showed, read the article applicable to the unit you use.
- In operation procedures, bracket shape indicates the key or button you should control.
  - < >: indicates the name of panel buttons.
  - [ ]: indicates the name of touch keys

## Precautions

### ▲WARNING

#### ■ To prevent injury or fire, take the following precautions:

- To prevent a short circuit, never put or leave any metallic objects (such as coins or metal tools) inside the unit.
- Do not watch or fix your eyes on the unit's display when you are driving for any extended period.
- If you experience problems during installation, consult your Kenwood dealer.

#### ■ Precautions on using this unit

- When you purchase optional accessories, check with your Kenwood dealer to make sure that they work with your model and in your area.
- You can select language to display menus, audio file tags, etc. See **Language setup (P.95)** in the Instruction Manual.
- The Radio Data System or Radio Broadcast Data System feature won't work where the service is not supported by any broadcasting station.
- The unit may not function properly if the connectors between the unit and front panel are dirty. Detach the front panel and clean the connector with a cotton swab gently, being careful not to damage the connector.

#### ■ Precautions on battery

- Put the remote control in a place where it will not move during braking or other operations. A dangerous situation could result, if the remote control falls down and gets wedged under the pedals while driving.
- Do not leave the battery near fire or under direct sunlight. A fire, explosion or excessive heat generation may result.
- Do not recharge, short, break up or heat the battery or place it in an open fire. Such actions may cause the battery to leak fluid. If spilled fluid comes in contact with your eyes or on clothing, immediately rinse with water and consult a physician.
- Place the battery out of reach of children. In the unlikely event that a child swallows the battery, immediately consult a physician.

#### ■ Protecting the monitor

- Put the remote control in a place where it will

not move during braking or other operations. A dangerous situation could result, if the remote control falls down and gets wedged under the pedals while driving.

#### ■ Protecting the monitor

Put the remote control in a place where it will not move during braking or other operations. A dangerous situation could result, if the remote control falls down and gets wedged under the pedals while driving.

#### ■ Lens fogging

When you turn on the car heater in cold weather, dew or condensation may form on the lens in the disc player of the unit. Called lens fogging, this condensation on the lens may not allow discs to play. In such a situation, remove the disc and wait for the condensation to evaporate. If the unit still does not operate normally after a while, consult your Kenwood dealer.

#### ■ Precautions on handling discs

- Do not touch the recording surface of the disc.
- Do not stick tape etc. on the disc, or use a disc with tape stuck on it.
- Do not use disc type accessories.
- Clean from the center of the disc and move outward.
- When removing discs from this unit, pull them out horizontally.
- If the disc center hole or outside rim has burrs, use the disc only after removing the burrs with a ballpoint pen etc.
- Discs that are not round cannot be used.

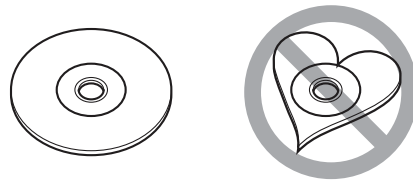

- 8-cm (3 inch) discs cannot be used.
- Discs with coloring on the recording surface or discs that are dirty cannot be used.
- This unit can only play the CDs with



This unit may not correctly play discs which do not have the mark.

- You cannot play a disc that has not been finalized. (For the finalization process see your writing software, and your recorder instruction manual.)

## ■ Acquiring GPS signal

The first time you turn on this unit, you must wait while the system acquires satellite signals for the first time. This process could take up to several minutes. Make sure your vehicle is outdoors in an open area away from tall buildings and trees for fastest acquisition.

After the system acquires satellites for the first time, it will acquire satellites quickly each time thereafter.

## ■ About the front panel **DNX8** **DNX7**

When removing the product from the box or installing it, the front panel may be positioned at the angle shown in (Fig. 1). This is due to the characteristics of mechanism the product is equipped with.

When the product is first powered on works properly, the front panel will automatically move into the position (initial setting angle) shown in (Fig. 2).

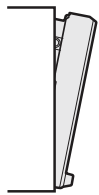

(Fig. 1)

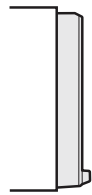

(Fig. 2)

## ■ Cleaning the Unit

If the front panel of this unit is stained, wipe it with a dry soft cloth such as a silicon cloth. If the front panel is stained badly, wipe the stain off with a cloth moistened with neutral cleaner, then wipe it again with a clean soft dry cloth.

## ⚠ CAUTION

- Applying spray cleaner directly to the unit may affect its mechanical parts. Wiping the front panel with a hard cloth or using a volatile liquid such as thinner or alcohol may scratch the surface or erase screened print.

## ■ How to reset your unit

If the unit fails to operate properly, press the Reset button. The unit returns to the factory settings.

### **DNX8** **DNX7**

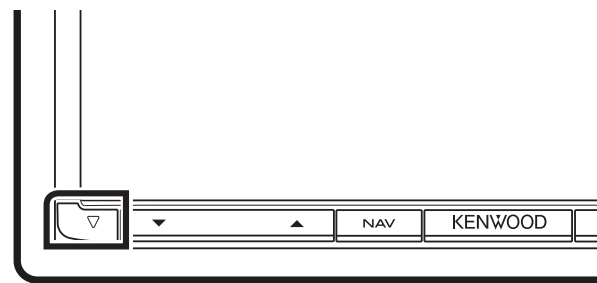

### **DNX6** **DNX5**

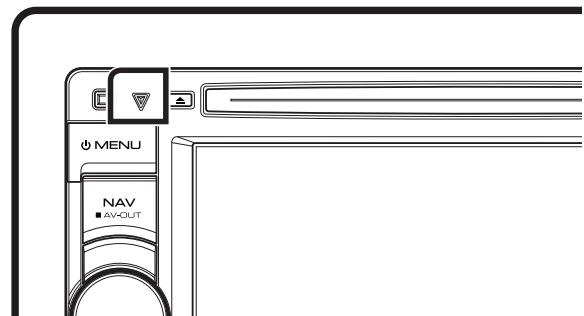

## 📌 NOTE

- Disconnect the USB device before pressing the <Reset> button. Pressing the <Reset> button with the USB device connected can damage the data stored in the USB device. For how to disconnect the USB device, see **How to Play Music (P.13)**.
- When the unit is turned on after resetting, the Initial SETUP screen appears. See **First Step (P.6)**.

## Safety Precautions and Important Information

Read this information carefully before starting to operate the Kenwood Car Navigation System and follow the instructions in this manual. Neither Kenwood nor Garmin shall be liable for problems or accidents resulting from failure to observe the instructions in this manual.

### **⚠️ WARNING**

**Failure to avoid the following potentially hazardous situations could result in an accident or collision resulting in death or serious injury.**

When navigating, carefully compare information displayed on the navigation system to all available navigation sources, including information from street signs, visual sightings, and maps. For safety, always resolve any discrepancies or questions before continuing navigation.

Always operate the vehicle in a safe manner.

Do not become distracted by the navigation system while driving, and always be fully aware of all driving conditions. Minimize the amount of time spent viewing the screen of the navigation system while driving, and use voice prompts when possible.

Do not enter destinations, change settings, or access any functions requiring prolonged use of the navigation system controls while driving. Stop your vehicle in a safe and legal manner before attempting such operations.

Keep the system volume at a low enough level to be able to hear outside noises while driving. If you can no longer hear outside noises, you may be unable to react adequately to the traffic situation. This may cause accidents.

The navigation system will not display the correct current position of the vehicle the first time it is used after purchase, or if the vehicle battery is disconnected. GPS satellite signals will soon be received, however, and the correct position will be displayed.

Be careful of the ambient temperature. Using the navigation system at extreme temperatures can lead to malfunction or damage. Also note that the unit can be damaged by strong vibration, by metal objects, or by water getting inside the unit.

### **⚠️ CAUTION**

**Failure to avoid the following potentially hazardous situations may result in injury or property damage.**

The navigation system is designed to provide you with route suggestions. It does not reflect road closures or road conditions, weather conditions, or other factors that may affect safety or timing while driving.

Use the navigation system only as a navigational aid.

Do not attempt to use the navigation system for any purpose requiring precise measurement of direction, distance, location, or topography.

The Global Positioning System (GPS) is operated by the United States government, which is solely responsible for its accuracy and maintenance. The government system is subject to changes that could affect the accuracy and performance of all GPS equipment, including the navigation system. Although the navigation system is a precision navigation device, any navigation device can be misused or misinterpreted and, therefore, become unsafe.

## IMPORTANT INFORMATION

### **■ Vehicle Battery Preservation**

This navigation system can be used when the ignition key is turned to ON or ACC. To preserve the battery, however, it should be used with the engine running whenever possible. Using the navigation system for a long time with the engine switched off can cause the battery to run down.

### **■ Map Data Information**

One of the goals of Garmin is to provide customers with the most complete and accurate cartography that is available to us at a reasonable cost. We use a combination of governmental and private data sources, which we identify in product literature and copyright messages displayed to the consumer. Virtually all data sources contain some inaccurate or incomplete data. In some countries, complete and accurate map information is either not available or is prohibitively expensive.

## First Step

Various setup screens appear automatically before using.

### Initial setup

When you first turn on the unit, the screen of the configuration setting will appear.

## 1 Turn the ignition key of your car to ACC.

The unit is turned on.  
Initial SETUP screen appears.

## 2 Touch the corresponding key and set the value.

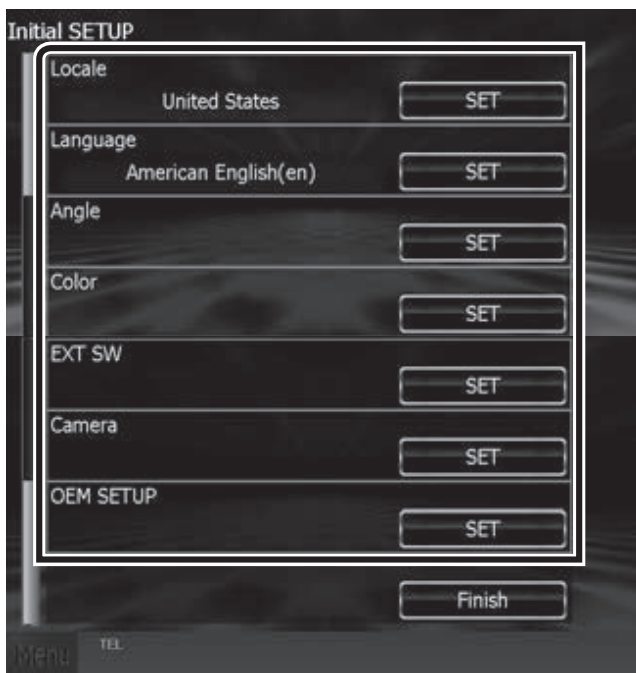

### Locale

Select the country for the navigation system.  
The language, the distance unit, and the gasoline unit are set.  
After setting, touch [Enter].

### Language

Select the language used for the control screen and setting items. Default is "American English (en)".  
(Instruction Manual P.95)  
After setting, touch [Enter].

### Angle **DNX8** **DNX7**

Adjust the position of the monitor. Default is "0".  
(Instruction Manual P.98)  
After setting, touch [↵].

### Color

Set the screen and button illumination color. You can select whether to perform color scan and adjust scanning color. (Instruction Manual P.99)  
After setting, touch [↵].

### EXT SW (DNX891HD, DNX7710BT only)

Control the external devices. (Instruction Manual P.104)  
After setting, touch [↵].

### Camera

Set the parameters for the camera. (Instruction Manual P.102)  
After setting, touch [↵].

### OEM SETUP (North America Sales area only)

This function requires a commercial adaptor.  
Consult your Kenwood dealer for details.

## 3 Touch [Finish].

### NOTE

- "Initial setup" also appears when the unit is reset.

## ■ iPod/iPhone connection setup

When you first select iPod as a source, the setting screen of the iPod/iPhone connection will appear.

### 1 Touch [Menu] on any screen.

Top Menu screen appears.

### 2 Touch [iPod] in the Top Menu screen.

iPod connection setup screen appears.

### 3 Touch [CHANGE].

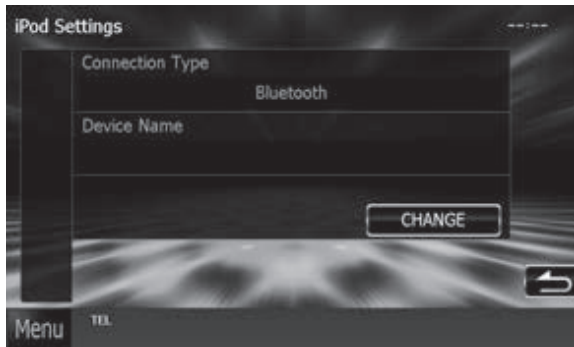

Select the way of iPod/iPhone connection. For the details, refer to "iPod/iPhone connection setup" (P.54) in the Instruction Manual.

#### NOTE

- For the details of the necessary cable and adapter to connect with iPod/iPhone, refer to "iPod/iPhone connection" (P.26).
- When you select "HDMI + BT" or "Bluetooth", Bluetooth device selection screen will appear. Select the iPod/iPhone to be connected.

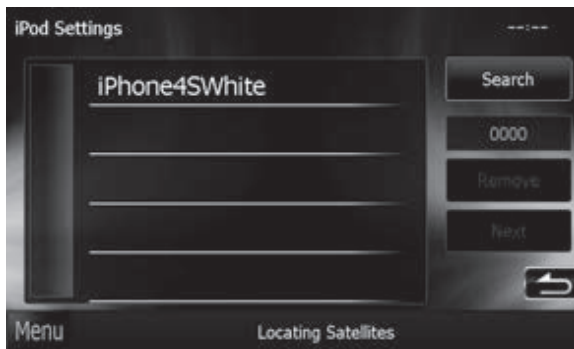

If a connectable Bluetooth device is not displayed, touch [Search] and do the pairing of the devices.

- "iPod connection setup" also appears when the unit is reset.

## ■ Application link setup

When you first select Apps as a source, the setting screen for the connection with the device installed the apps will appear.

### 1 Touch [Menu] on any screen.

Top Menu screen appears.

### 2 Touch [Apps] in the Top Menu screen.

Application link setup screen appears.

### 3 Touch [CHANGE].

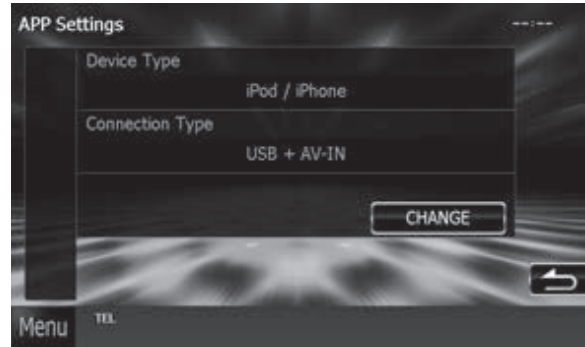

Select the way to connect with the device installed the apps. For the details, refer to "Application link setup" (P.56) in the Instruction Manual.

#### NOTE

- For the details of the necessary cable and adapter to connect with iPod/iPhone and Android, refer to "iPod/iPhone connection" (P.26) and "Android connection" (P.26).
- When you select "HDMI + BT", "HDMI/MHL + BT" or "Bluetooth", Bluetooth device selection screen will appear. Select the device to be connected.

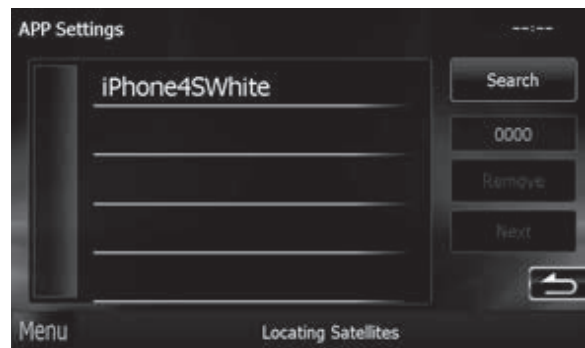

If a connectable Bluetooth device is not displayed, touch [Search] and do the pairing of the devices.

- "Application link setup" also appears when the unit is reset.



# Functions of the Buttons on the Front Panel

■ DNX891HD/ DNX7710BT/ DNX771HD

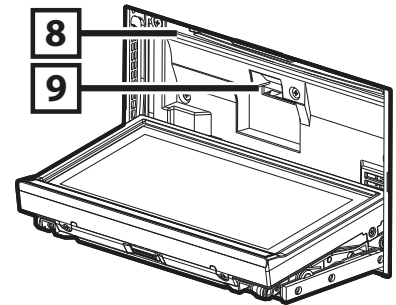
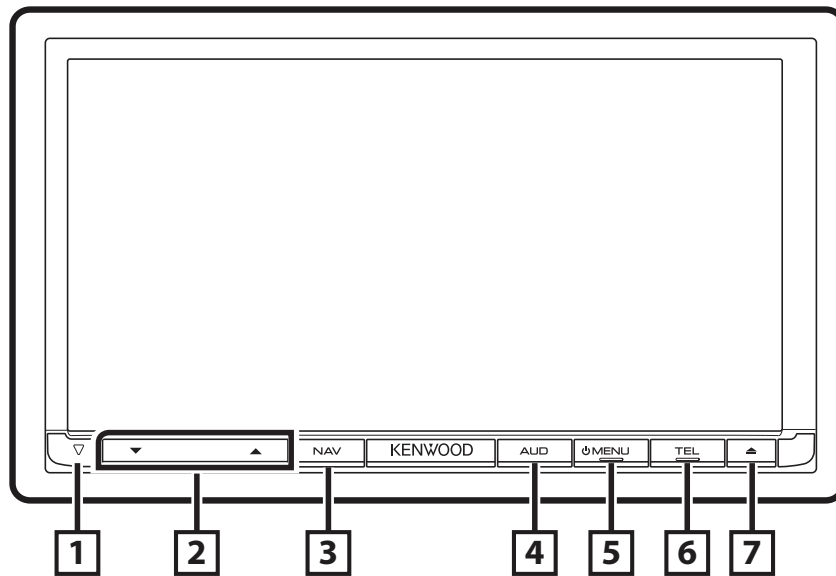

No.	Name/Motion
1	<p><b>▽ (Reset)</b></p> <ul style="list-style-type: none"> <li>• If the unit or the connected unit fails to operate properly, the unit returns to factory settings when this button is pressed (Instruction Manual P.125).</li> <li>• This indicator flashes when the vehicle ignition is off (Instruction Manual P.96).</li> </ul>
2	<p><b>▲, ▼</b></p> <ul style="list-style-type: none"> <li>• Adjusts volume.</li> </ul>
3	<p><b>NAV</b></p> <ul style="list-style-type: none"> <li>• Displays the navigation screen.</li> <li>• Pressing for 1 second switches AV out sources.</li> </ul>
4	<p><b>AUD</b></p> <ul style="list-style-type: none"> <li>• Displays Graphic Equalizer screen (Instruction Manual P.110).*</li> <li>• Pressing for 1 second switches camera view display on/off.</li> </ul>
5	<p><b>MENU</b></p> <ul style="list-style-type: none"> <li>• Displays the Top Menu screen (Instruction Manual P.14).</li> <li>• Pressing for 1 second turns the power off.</li> <li>• When the power off, turns the power on.</li> </ul>

No.	Name/Motion
6	<p><b>TEL</b></p> <ul style="list-style-type: none"> <li>• Displays the Hands Free screen (Instruction Manual P.85).</li> <li>• Pressing for 1 second displays the Voice Recognition screen. (Instruction Manual P.88)</li> </ul>
7	<p><b>▲</b></p> <ul style="list-style-type: none"> <li>• Ejects the disc.</li> <li>• When the panel is opened, pressing closes the panel and pressing for 1 second ejects the disc forcibly.</li> <li>• When the panel is closed, pressing for 1 second fully opens the panel to the location of the SD card slot.</li> </ul>
8	<p><b>Disc insert slot</b></p> <ul style="list-style-type: none"> <li>• A slot to insert a disc media.</li> </ul>
9	<p><b>SD card slot</b></p> <ul style="list-style-type: none"> <li>• An SD card slot for upgrading the map. For how to upgrade the map, refer to the instruction manual of the navigation system.</li> </ul>

\* The display may not switch to the Graphic Equalizer screen in some conditions.



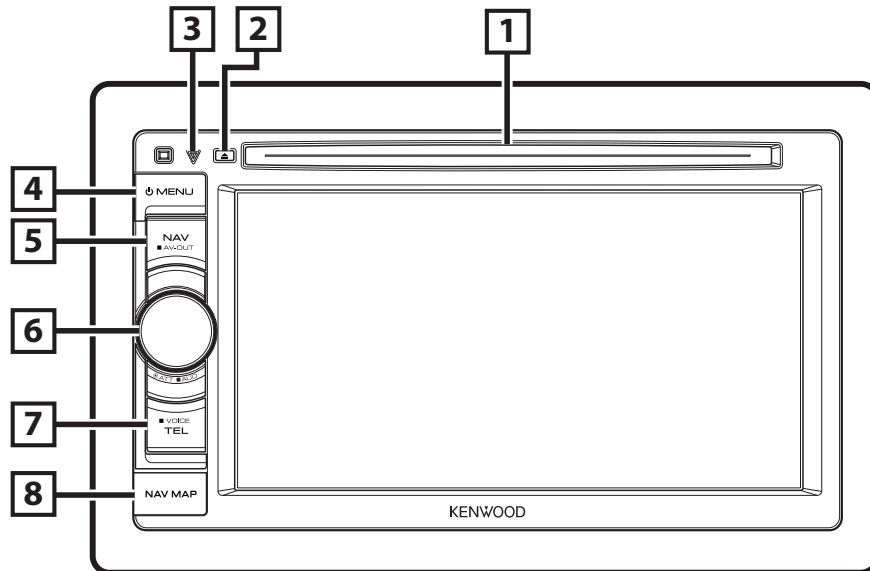

No.	Name/Motion
1	<b>Disc insert slot</b> <ul style="list-style-type: none"> <li>• A slot to insert a disc media.</li> </ul>
2	<b>▲</b> <ul style="list-style-type: none"> <li>• Ejects the disc.</li> <li>• Pressing for 1 second ejects the disc forcibly.</li> </ul>
3	<b>▽ (Reset)</b> <ul style="list-style-type: none"> <li>• If the unit or the connected unit fails to operate properly, the unit returns to factory settings when this button is pressed (Instruction Manual P.125).</li> <li>• This indicator flashes when the vehicle ignition is off (Instruction Manual P.96).</li> </ul>
4	<b>MENU</b> <ul style="list-style-type: none"> <li>• Displays the Top Menu screen (Instruction Manual P.14).</li> <li>• Pressing for 1 second turns the power off.</li> <li>• When the power off, turns the power on.</li> </ul>
5	<b>NAV</b> <ul style="list-style-type: none"> <li>• Displays the navigation screen.</li> <li>• Pressing for 1 second switches AV out sources.</li> </ul>
6	<b>Volume knob</b> <ul style="list-style-type: none"> <li>• Turning adjusts volume up or down.</li> <li>• Pressing switches attenuation of the volume on/off.</li> <li>• Pressing for 1 second displays Graphic Equalizer screen (Instruction Manual P.110).*</li> </ul>

No.	Name/Motion
7	<b>TEL</b> <ul style="list-style-type: none"> <li>• Displays the Hands Free screen (Instruction Manual P.85).</li> <li>• Pressing for 1 second displays the Voice Recognition screen. (Instruction Manual P.88)</li> </ul>
8	<b>microSD card slot</b> <ul style="list-style-type: none"> <li>• A microSD card slot for upgrading the map. For how to upgrade the map, refer to the instruction manual of the navigation system.</li> </ul>

\* The display may not switch to the Graphic Equalizer screen in some conditions.

## Common Operations

### General

There are some functions which can be operated from most screens.

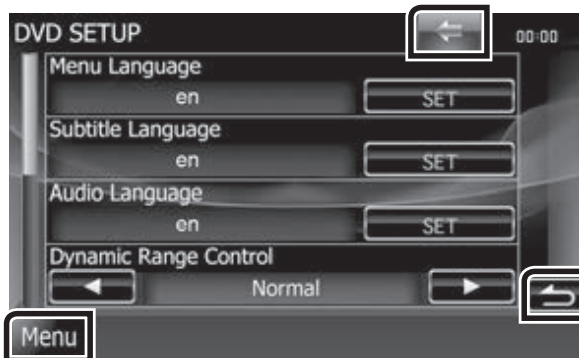

### [Menu]

Returns to the Top Menu screen.  
Touching for at least 1 second displays the Screen Control screen. (Even when an image is displayed, touching for at least 1 second displays the Screen Control screen.)

### [↶] (RETURN)

Returns to previous screen.

### [←] (common menu key)

Touch to display the common menu. The contents of the menu are as follows.

- : Displays the EXT SW Control screen. (DNX891HD, DNX7710BT only)
- : Displays the SETUP Menu screen.
- : Displays the Audio Control Menu screen.
- : Displays the control screen of current source. Icon feature differs depending on the source.
- : Closes the menu.

### List screen

There are some common function keys in the list screens of most sources.



### [←] (Scroll)

Scrolls the displayed text.

### All > etc.

Touch keys with various functions are displayed here.

Displayed keys differ depending on the current audio source, status, etc.

For examples, see **List screen (P.16)** in the Instruction Manual.

### Flick scrolling

You can scroll the list screen by flicking the screen up/down or right/left.

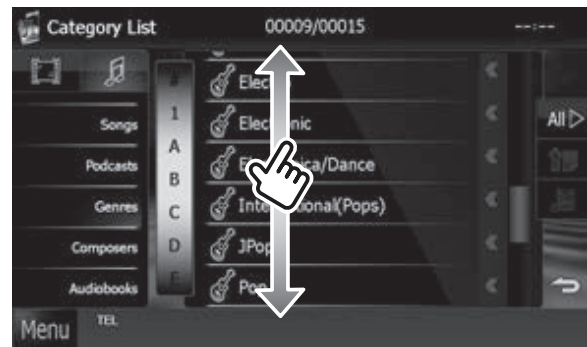

# How to Use the Navigation System

**1** Press the <NAV> button to display the navigation screen.

**2** Operate the desired function from the Main Menu screen.



No.	Name/Motion
1	GPS satellite strength.
2	Finds a destination.
3	Views the map.
4	Uses the Apps such as ecoRoute and Help.
5	Adjusts the settings.

## NOTE

- You can get additional information about using the navigation system from Help. To display Help, touch [Apps] and then touch [Help].

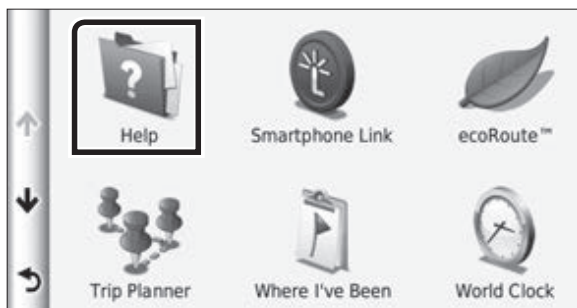

- For more information about your navigation system, download the latest version of the Owner's Manual from <http://manual.kenwood.com/edition/im382/>.

**3** Enter your destination and start the guidance.

### Finding points of interest

- 1) Touch [Where To?].

- 2) Select a category and a subcategory.
- 3) Select a destination.
- 4) Touch [Go].

## NOTE

- To enter letters contained in the name, touch the Search bar and enter the letters.

**4** Follow your route to the destination.

## NOTICE

- The speed limit icon feature is for information only and does not replace the driver's responsibility to abide by all posted speed limit signs and to use safe driving judgment at all times. Garmin and JVC KENWOOD will not be responsible for any traffic fines or citations that you may receive for failing to follow all applicable traffic laws and signs.

Your route is marked with a magenta line. As you travel, your navigation system guides you to your destination with voice prompts, arrows on the map, and directions at the top of the map. If you depart from the original route, your navigation system recalculates the route.

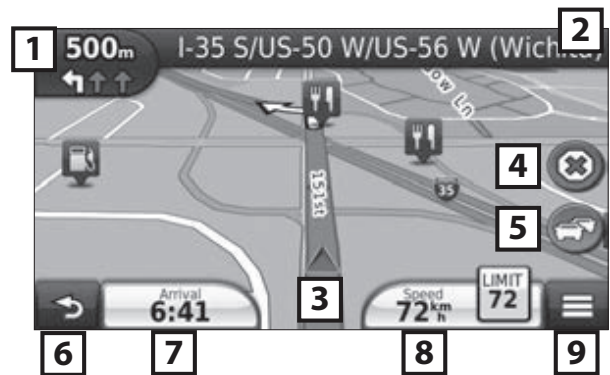

No.	Name/Motion
1	Views the Next Turn page or the junction view page, when available.
2	Views the Turn List page.
3	Views the Where Am I? page.
4	Stops the current route.
5	Displays traffic information on the route.
6	Returns to the Main menu.
7	Displays a different data field.
8	Views the Trip Computer.
9	Displays more options.



## NOTE

- Touch and drag the map to view a different area of the map.
- A speed limit icon could appear as you travel on major roadways.

### • Adding a stop

- 1) While navigating a route, touch [] and then touch [Where To?].
- 2) Search for the extra stop.
- 3) Touch [Go!].
- 4) Touch [Add to Active Route] to add this stop before your final destination.

### • Taking a detour

- 1) While navigating a route, touch [].
- 2) Touch [].

## Other Features

### • Manually avoiding traffic on your route

- 1) From the map, touch the traffic icon.
- 2) Touch [Traffic On Route].
- 3) If necessary, touch the arrows to view other traffic delays on your route.
- 4) Touch [] > [Avoid].

### • Viewing the traffic map

- 1) The traffic map shows color-coded traffic flow and delays on nearby.

### • About traffic

#### NOTICE

- Traffic service is not available in some areas or countries.
- Garmin and JVC KENWOOD are not responsible for the accuracy or timeliness of the traffic information.  
With an FM traffic receiver, the navigation system can receive and use traffic information. When a traffic message is received, you can see the event on the map and change your route to avoid the incident. The FM TMC subscription activates automatically after your navigation system acquires satellite signals while receiving traffic signals from the service provider. Go to [www.garmin.com/kenwood](http://www.garmin.com/kenwood) for more information.

### • Updating the software

To update the navigation system software, you must have a USB mass storage device and an internet connection.

- 1) Go to [www.garmin.com/Kenwood](http://www.garmin.com/Kenwood).
- 2) Find your model and select [Software Updates] > [Download].

- 3) Read and accept the terms of the Software License Agreement.

- 4) Follow the instructions on the Web site to complete the installation of the software update.

### • Updating maps

You can purchase updated map data from Garmin or ask your Kenwood dealer or Kenwood service center for details.

- 1) Go to [www.garmin.com/Kenwood](http://www.garmin.com/Kenwood).
- 2) Select [Order Map Updates] for your Kenwood unit.
- 3) Follow the Web site instructions to update your map.

## How to insert an SD Card/ microSD Card

### **DNX8** **DNX7**

- 1) Press <▲> button for 1 second.
- 2) Hold the SD card with the label facing up, and insert it into the slot until it clicks.

Labelled side

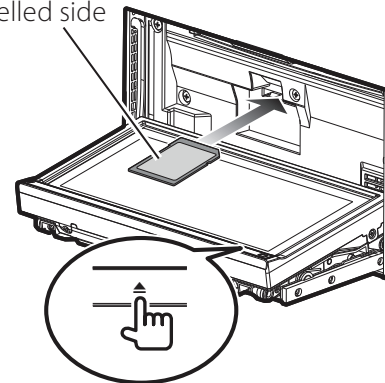

### **DNX6** **DNX5**

- 1) Open the card slot cover.
- 2) Hold the microSD card with the label facing up, and insert it into the slot until it clicks.

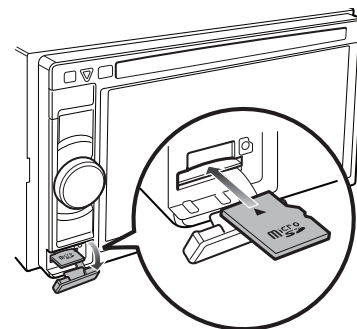

### • To eject the card

- 1) Push the card until it clicks and then remove your finger from the card.
- 2) The card pops up so that you can pull it out with your fingers.

# How to Play Music

You can play audio files from music CD, disc media, USB storage device and iPod.

### NOTE

- For details on playable file format, media format, iPod model, etc., refer to the Instruction Manual.

## 1 Connect the media you want to play as shown below.

### Disc

#### DNX8 DNX7

- 1) Press the <▲> button to open the front panel.
- 2) Insert the disc into the slot.  
The panel closes automatically and playback starts.

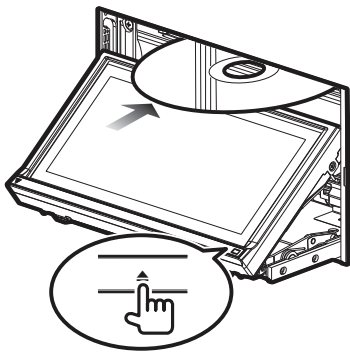

#### • To eject the disc:

- 1) Press the <▲> button.

#### DNX6 DNX5

- 1) Insert the disc into the slot.  
Playback starts.

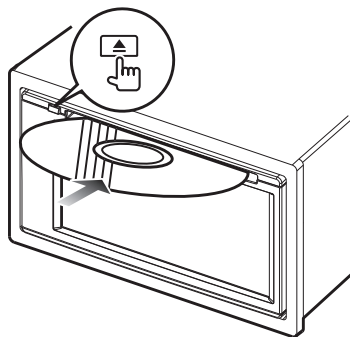

#### • To eject the disc:

- 1) Press the <▲> button.

### iPod/iPhone

- 1) Connect the iPod/iPhone.  
Playback starts.

### NOTE

- For the details of the necessary cable and adapter to connect with iPod/iPhone, refer to "iPod/iPhone connection" (P.26).

#### • To disconnect the iPod/iPhone connected with the cable:

- 1) Touch [◀] on the screen and then touch [▲].

Disconnect the iPod/ iPhone from the cable.

### USB device

- 1) Connect the USB device with the USB cable.

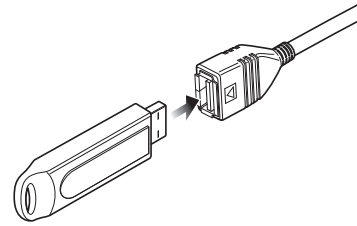

#### • To disconnect the USB device:

- 1) Touch [▲] on the screen and disconnect the device from the cable.

## 2 Control the music you are listening to on the source control screen.

The following symbols indicate the keys on the screen.

The functions of the keys are the same despite the difference of the source you are listening to.



Touch [Touch icon]



#### • Basic operations from this screen

- ▶||** Plays or pauses.
- Stops playing.
- ▲** Disconnects the device.



Searches the previous/next content.

**◀▶▶▶ or move the cursor in the center bar**

Fast forwards or Fast backwards (Disc media, CD, USB device only).



Repeats current content.



Plays all contents in random order.

**NOTE**

- For other operations, refer to the Instruction Manual.
- If desired key is not displayed in the multi-function bar, touch the [◀▶] to switch the menu.

### 3 Search the track/file you want to listen to.

#### • List search

1) Touch center of the screen.

The content list of the media being played is displayed.

If the information of the current track only is displayed, touch [⬆] to switch the list display.



#### • Refined search

1) Touch [Q].

2) Touch the desired refinement method.

The list is refined by the item you selected.

3) Touch the desired item.

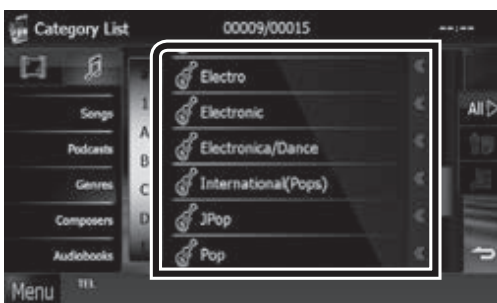

**NOTE**

- For details on searching operations, refer to **Search**

**Operation (P.39)** in the Instruction Manual.

## How to Play Movie/Picture

You can play DVD video, Video CD (VCD), movie files from disc media, iPod and picture files from USB storage device.

**NOTE**

- For details on playable file format, device format, etc., refer to the Instruction Manual.

### 1 Connect the media you want to play.

For the method of connecting, see **How to Play Music (P.13)**.

### 2 Control the movie/picture by touching the screen.

Each area on the screen has a separate function.

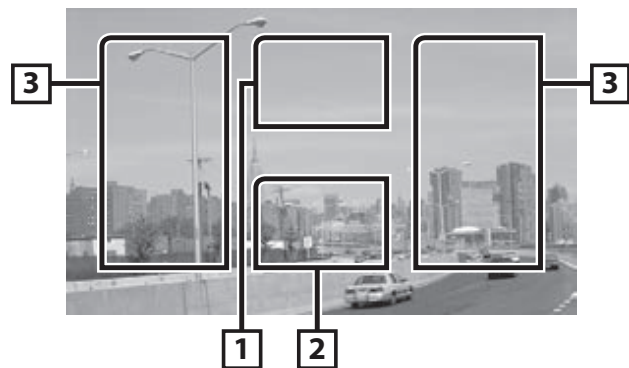

No.	Name/Motion
1	DVD: Displays the DVD menu.*1 VCD: Displays the Zoom Control screen.*2 Disc media: Displays the disc menu.*3
2	Displays the Source Control screen.
3	<ul style="list-style-type: none"> <li>• Searches the next/previous content or file.</li> <li>• Scrolling from center of display to left or right performs fast backward or fast forward. To stop fast backward/forward, touch center of the display.*4</li> </ul>

\*1 See **DVD Disc Menu Operation (P.25)** in the Instruction Manual.



\*2 See **Zoom Control For DVD And VCD (P.26)** in the Instruction Manual.

\*3 See **Movie Control (P.44)** in the Instruction Manual.

\*4 For USB, this function may be unavailable depending on the playing file format.



## NOTE

- For operations on the source control screen, see **How to Play Music (P.13)**. However, searching by category/link/album artwork is not available.
- Touching [  ] (displayed by touching [  ] in the source control screen) hides all keys.

## How to Listen to the Radio/ HD Radio™ Tuner/ SiriusXM®

### 1 Touch [Menu] on any screen.

Top Menu screen appears.

### 2 Touch [TUNER], [HD Radio], or [SiriusXM].

The unit switches to the radio/ HD Radio tuner / SiriusXM (sold separately) source.



### 3 Operate on the source control screen.

#### • Station search



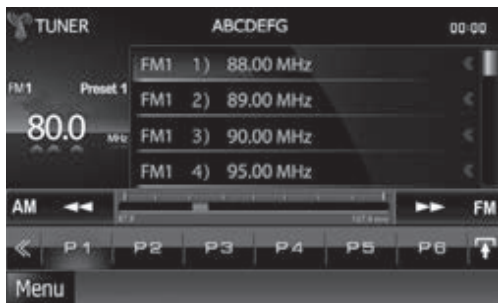

- 1) Touch [  ].

Sub function menu appears.



- 2) Touch [AM] or [FM] to select the band. (Radio/ HD Radio tuner only)
- 3) **Radio/ HD Radio tuner:**  
Touch [  ] or [  ] to tune in the desired station.  
**SiriusXM:**  
Touch [CH▼] or [CH▲] to tune in the desired station.

#### • Auto memory (Radio/ HD Radio tuner only)

- 1) Touch [  ].
- 2) Touch [AM] or [FM] to select the band.
- 3) Touch [  ].
- 4) Touch [AME].
- 5) Touch [  ] or [  ] in the sub function menu.

Auto memory starts.

#### • Recalling the preset station

- 1) Touch [P#].

You can also display the preset list by touching the frequency display in the center.

## NOTE

- For other operations, see **Radio/HD Radio Tuner Basic Operation (P.58)** and **SiriusXM® Basic Operation (P.68)** in the Instruction Manual.

## How to Make a Phone Call

You can use your Bluetooth cell-phone when paired to this unit.

## NOTE

- You cannot register the Bluetooth unit when you are using the following sources:  
iPod, Bluetooth Audio, APPS, iHeart, Pandora

### 1 Register your cell-phone to the unit.

Follow as the procedures shown below. For detailed operation, see **Registering the Bluetooth Unit (P.83)** in the Instruction Manual.

- 1) Touch [Menu] on any screen.  
Top Menu screen appears.
- 2) Touch [SETUP].  
SETUP Menu screen appears.
- 3) Touch [Bluetooth].  
Bluetooth SETUP screen appears.



- 4) Touch [Search].  
Searched Device List screen appears.
- 5) Select your cell-phone from the displayed list in the Searched Device List screen.





- 6) Enter PIN code from the cell-phone.  
Registering is completed.  
The PIN code is set to "0000" as default.

## 2 Connect your cell-phone to the unit.

- 1) Touch the device name you want to connect in the Bluetooth SETUP screen.
- 2) Touch [ON] of [TEL(HFP)] in the BT Connection Settings screen.  
The selected device is connected to the unit.

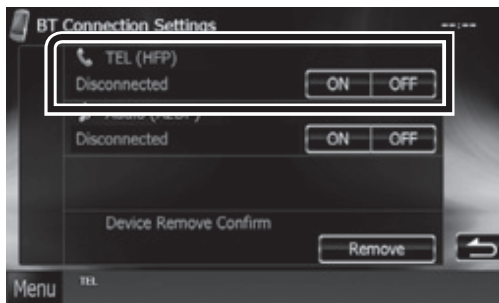

When registration of your cell-phone is completed, the phone book of the cell-phone is automatically downloaded to this unit.

## 3 Make or receive a phone call.



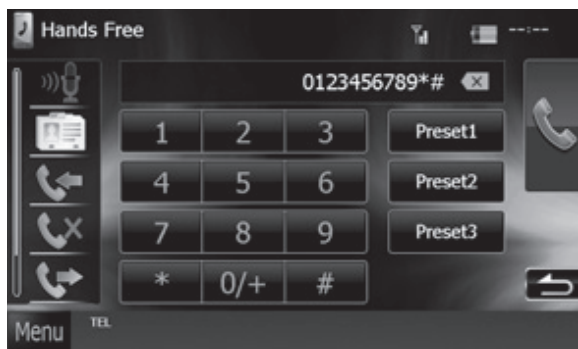

See the table below for each operation method.





### Call by entering a phone number

- 1) Enter a phone number with number keys.
- 2) Touch [  ].

### Call using call records

- 1) Touch [  ] (incoming calls), [  ] (missed calls), or [  ] (outgoing calls).
- 2) Select the phone number from the list.
- 3) Touch [  ].

### Call using the phonebook

- 1) Touch [  ].
- 2) Select the name from the list.
- 3) Select the number from the list.
- 4) Touch [  ].

### Call using the preset number

- 1) Touch [Preset #] to start calling the corresponding phone number.
- 2) Touch [  ].

### Call by voice

You can make a voice call using the voice recognition function of the cell-phone.

- 1) Touch [  ].
- 2) Pronounce the name registered in the cell-phone.

### NOTE

- For detailed operation, see **Using Hands-Free Unit (P.85)** in the Instruction Manual.

# Installation

## Before Installation

Before installation of this unit, please note the following precautions.

### ⚠ WARNINGS

- If you connect the ignition wire (red) and the battery wire (yellow) to the car chassis (ground), you may cause a short circuit, that in turn may start a fire. Always connect those wires to the power source running through the fuse box.
- Do not cut out the fuse from the ignition wire (red) and the battery wire (yellow). The power supply must be connected to the wires via the fuse.

### ⚠ CAUTION

- Install this unit in the console of your vehicle. Do not touch the metal part of this unit during and shortly after the use of the unit. Metal part such as the heat sink and enclosure become hot.

### 📝 NOTE

- Mounting and wiring this product requires skills and experience. For best safety, leave the mounting and wiring work to professionals.
- Make sure to ground the unit to a negative 12V DC power supply.
- Do not install the unit in a spot exposed to direct sunlight or excessive heat or humidity. Also avoid places with too much dust or the possibility of water splashing.
- Do not use your own screws. Use only the screws provided. If you use the wrong screws, you could damage the unit.
- If the power is not turned ON ("PROTECT" is displayed), the speaker wire may have a short-circuit or touched the chassis of the vehicle and the protection function may have been activated. Therefore, the speaker wire should be checked.
- If your car's ignition does not have an ACC position, connect the ignition wires to a power source that can be turned on and off with the ignition key. If you connect the ignition wire to a power source with a constant voltage supply, such as with battery wires, the battery may be drained.
- If the console has a lid, make sure to install the unit so that the front panel will not hit the lid when closing and opening.
- If the fuse blows, first make sure the wires aren't touching to cause a short circuit, then replace the old fuse with one with the same rating.

- Insulate unconnected wires with vinyl tape or other similar material. To prevent a short circuit, do not remove the caps on the ends of the unconnected wires or the terminals.
- Connect the speaker wires correctly to the terminals to which they correspond. The unit may be damaged or fail to work if you share the ⊖ wires or ground them to any metal part in the car.
- When only two speakers are being connected to the system, connect the connectors either to both the front output terminals or to both the rear output terminals (do not mix front and rear). For example, if you connect the ⊕ connector of the left speaker to a front output terminal, do not connect the ⊖ connector to a rear output terminal.
- After the unit is installed, check whether the brake lamps, blinkers, wipers, etc. on the car are working properly.
- Mount the unit so that the mounting angle is 30° or less.
- This unit has the cooling fan to decrease the internal temperature. Do not mount the unit in a place where the cooling fan of the unit are blocked. Blocking these openings will inhibit the cooling of the internal temperature and result in malfunction.

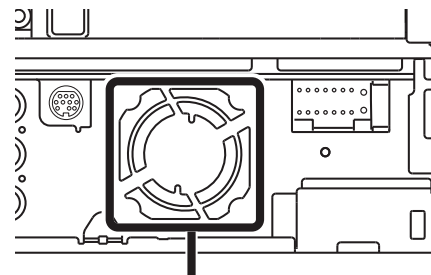

Cooling fan

- Do not press hard on the panel surface when installing the unit to the vehicle. Otherwise scars, damage, or failure may result.
- Reception may drop if there are metal objects near the Bluetooth antenna.

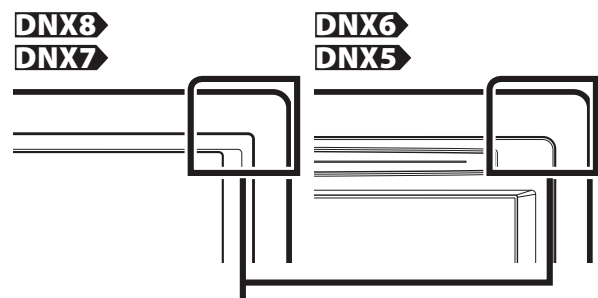

Bluetooth antenna unit

## ■ Supplied accessories

First of all, make sure that all accessories are supplied with the unit.

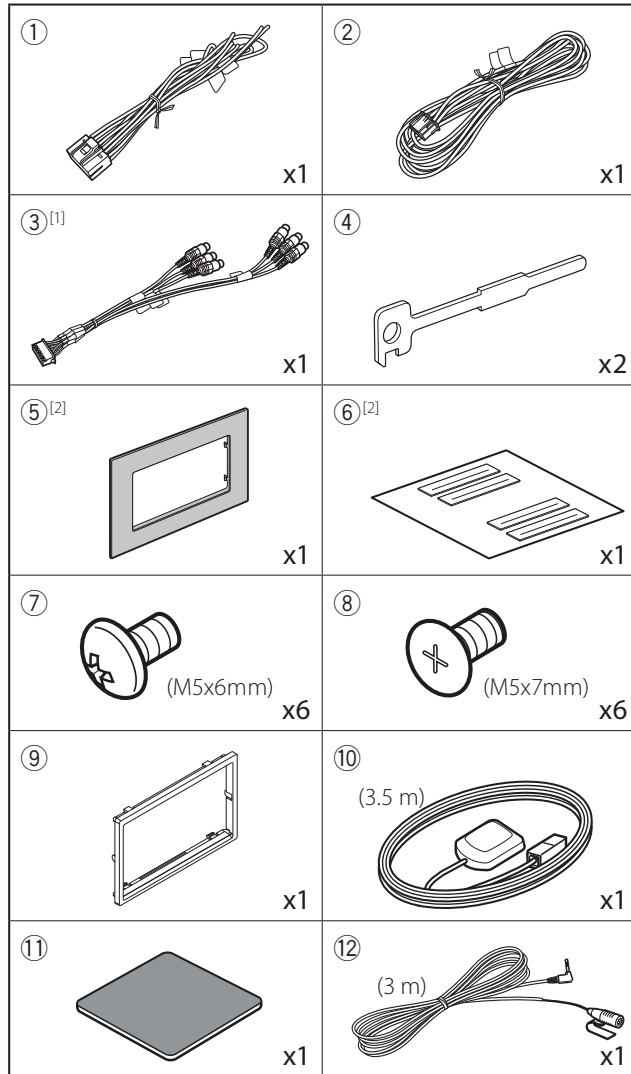

<sup>[1]</sup> DNX891HD, DNX7710BT, DNX771HD only

<sup>[2]</sup> DNX891HD only

## ■ Unit

- 1) To prevent a short circuit, remove the key from the ignition and disconnect the ⊖ terminal of the battery.
- 2) Make the proper input and output wire connections for each unit.
- 3) Connect the speaker wires of the wiring harness.
- 4) Connect the wiring harness wires in the following order; ground, battery, ignition.
- 5) Connect the wiring harness connector to the unit.
- 6) Install the unit in your car.
- 7) Reconnect the ⊖ terminal of the battery.
- 8) Press the <Reset> button. **(P.4)**
- 9) Perform the Initial Setup.

See **First Step (P.6)**.

### • Non-Japanese cars

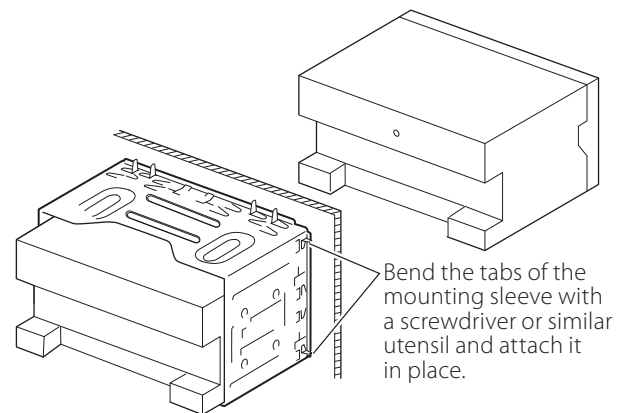

### • Japanese cars

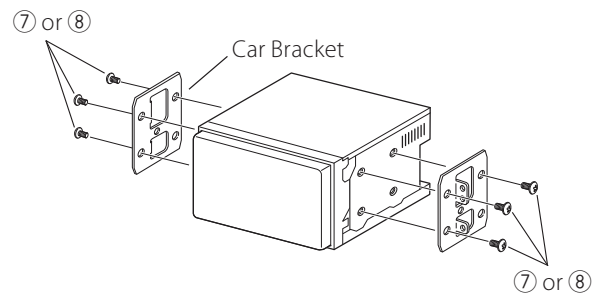

### 🔧 NOTE

- Make sure that the unit is installed securely in place. If the unit is unstable, it may malfunction (eg, the sound may skip).

## ■ Trim plate

- 1) Attach accessory ⑨ to the unit.

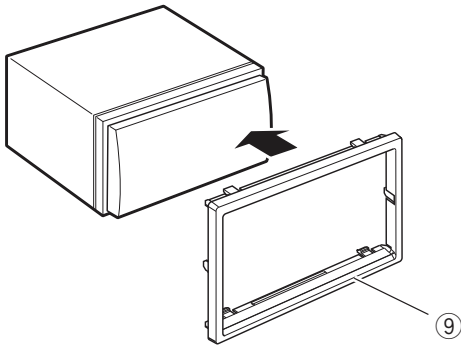

## • General Motors cars (DNX891HD)

- 1) Cut out accessory ⑤ to meet the shape of the opening of the center console.
- 2) Attach accessory ⑤ to the unit.

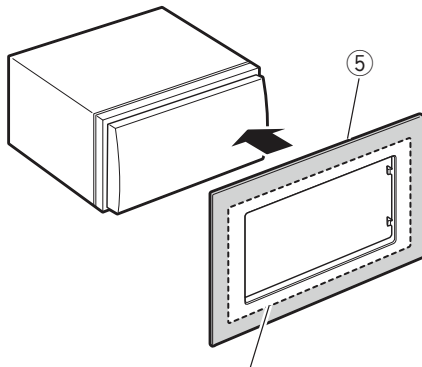

Cut out to meet the shape of the opening in the vehicle.

## • Toyota/Scion cars (DNX891HD)

- 1) Cut out accessory ⑤ as illustrated.

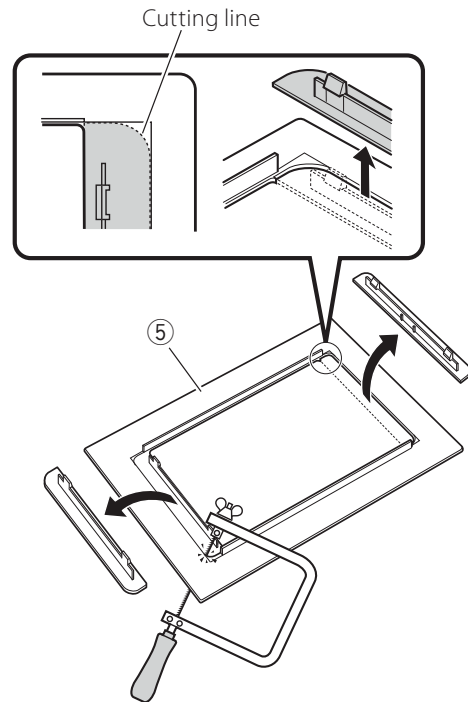

- 2) Fold double-sided adhesive (accessory ⑥) along the slit and attach it to accessory ⑤ cut-out against the center rib as illustrated. Use 2 pieces of accessory ⑥ for 1 accessory ⑤ cut-out.
- 3) Attach accessory ⑤ cut-out to the unit.

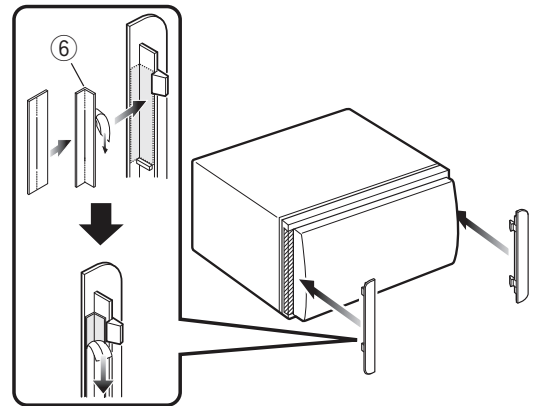

## ■ GPS antenna

GPS antenna is installed inside of the car. It should be installed as horizontally as possible to allow easy reception of the GPS satellite signals.

To mount the GPS antenna inside your vehicle:

- 1) Clean your dashboard or other surface.
- 2) Remove the separator of the metal plate (accessory ⑪).
- 3) Press the metal plate (accessory ⑪) down firmly on your dashboard or other mounting surface. You can bend the metal plate (accessory ⑪) to conform to a curved surface, if necessary.
- 4) Remove the separator of the GPS antenna (accessory ⑩), and stick the antenna to the metal plate (accessory ⑪).

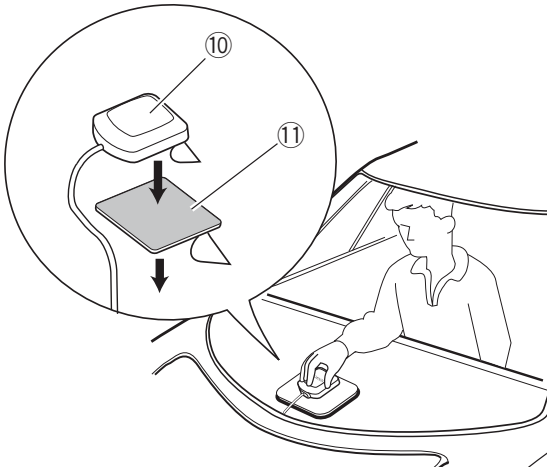

## 🔑 NOTE

- Depending on the type of car, reception of the GPS satellite signals might not be possible with an inside installation.
- Please install this GPS antenna in an area away from any antennas that are used with CB radios or satellite televisions.
- The GPS antenna should be installed at a position that is spaced at least 12 inch (30 cm) from cellular phone or other transmitting antennas. Signals from the GPS satellite may be interfered with by these types of communication.
- Painting the GPS antenna with (metallic) paint may cause a drop in performance.

## ■ Microphone unit

- 1) Check the installation position of the microphone (accessory ⑫).
- 2) Clean the installation surface.
- 3) Remove the separator of the microphone (accessory ⑫), and stick the microphone to the place shown below.
- 4) Wire the microphone cable up to the unit with it secured at several positions using tape or other desired method.
- 5) Adjust the direction of the microphone (accessory ⑫) to the driver.

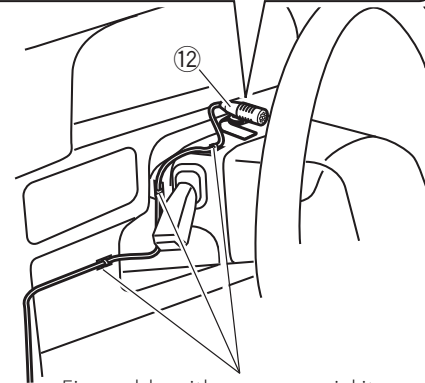
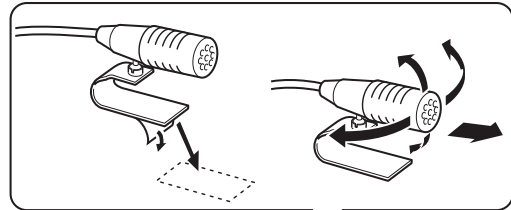

Fix a cable with a commercial item of tape.

## ■ Removing the trim plate

- 1) Engage the catch pins on the extraction key (accessory④) and remove the two locks on the lower level.

Lower the trim plate (accessory⑨) and pull it forward as shown in the figure.

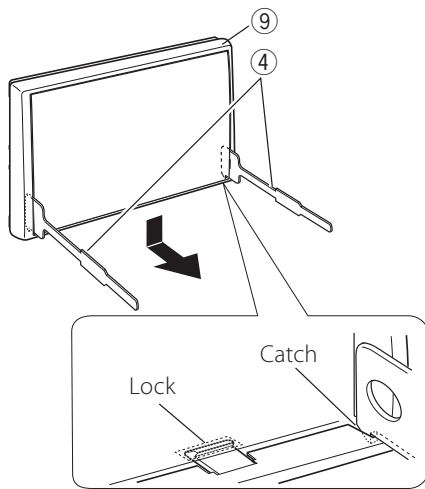

### 🔪 NOTE

- The trim plate can be removed from the top side in the same manner.

- 2) When the lower level is removed, remove the upper two locations.

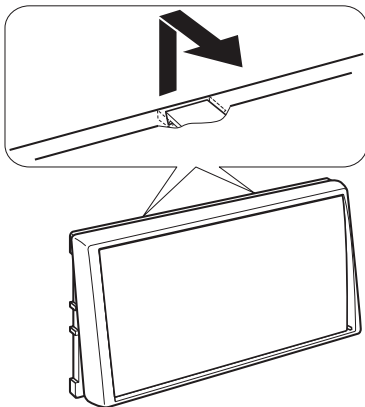

## ■ Removing the unit

- 1) Remove the trim plate by referring to step 1 in "Removing the trim plate".
- 2) Insert the two extraction key (accessory④) deeply into the slots on each side, as shown.

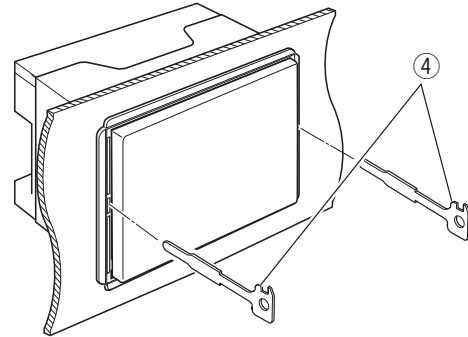

- 3) Lower the extraction key toward the bottom, and pull out the unit halfway while pressing towards the inside.

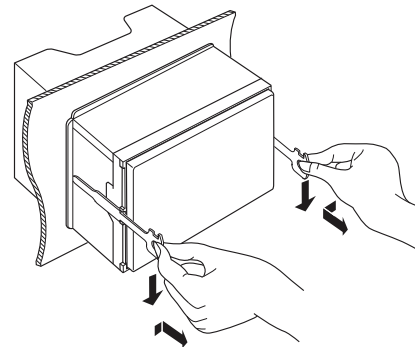

### 🔪 NOTE

- Be careful to avoid injury from the catch pins on the extraction key.

- 4) Pull the unit all the way out with your hands, being careful not to drop it.

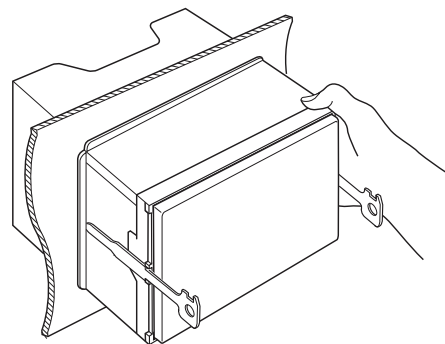

## System connection

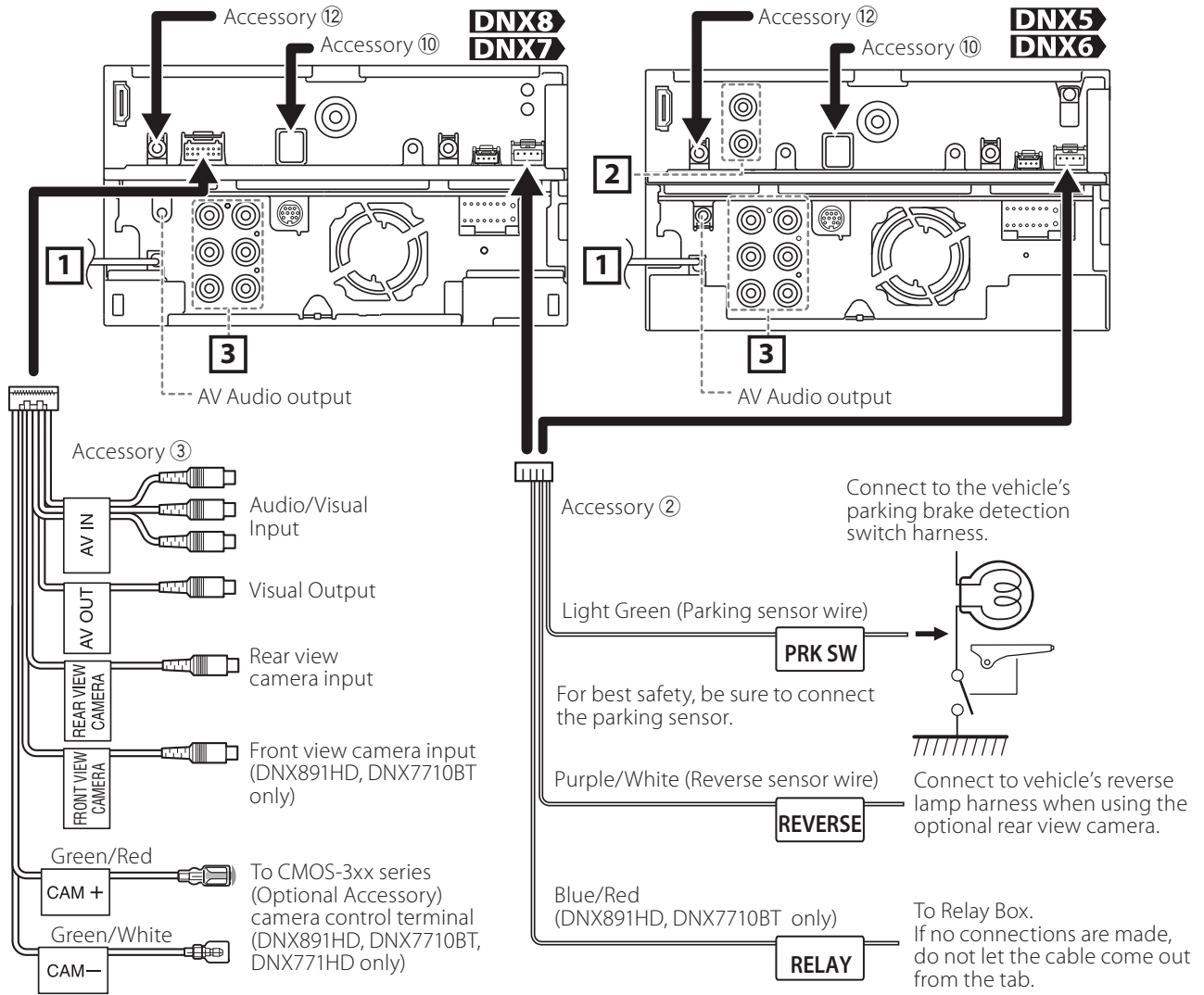

**1** FM/AM antenna input

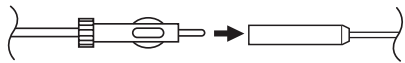

Accessory 10: GPS Antenna

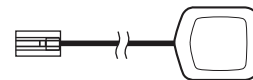

**2** Rear View Camera Input  
AV Video Output

Accessory 12:  
Bluetooth Microphone

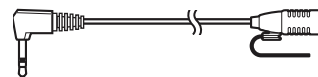

**3** Rear Audio Preout  
Front Audio Preout  
Subwoofer Preout



## ■ Connecting wires to terminals

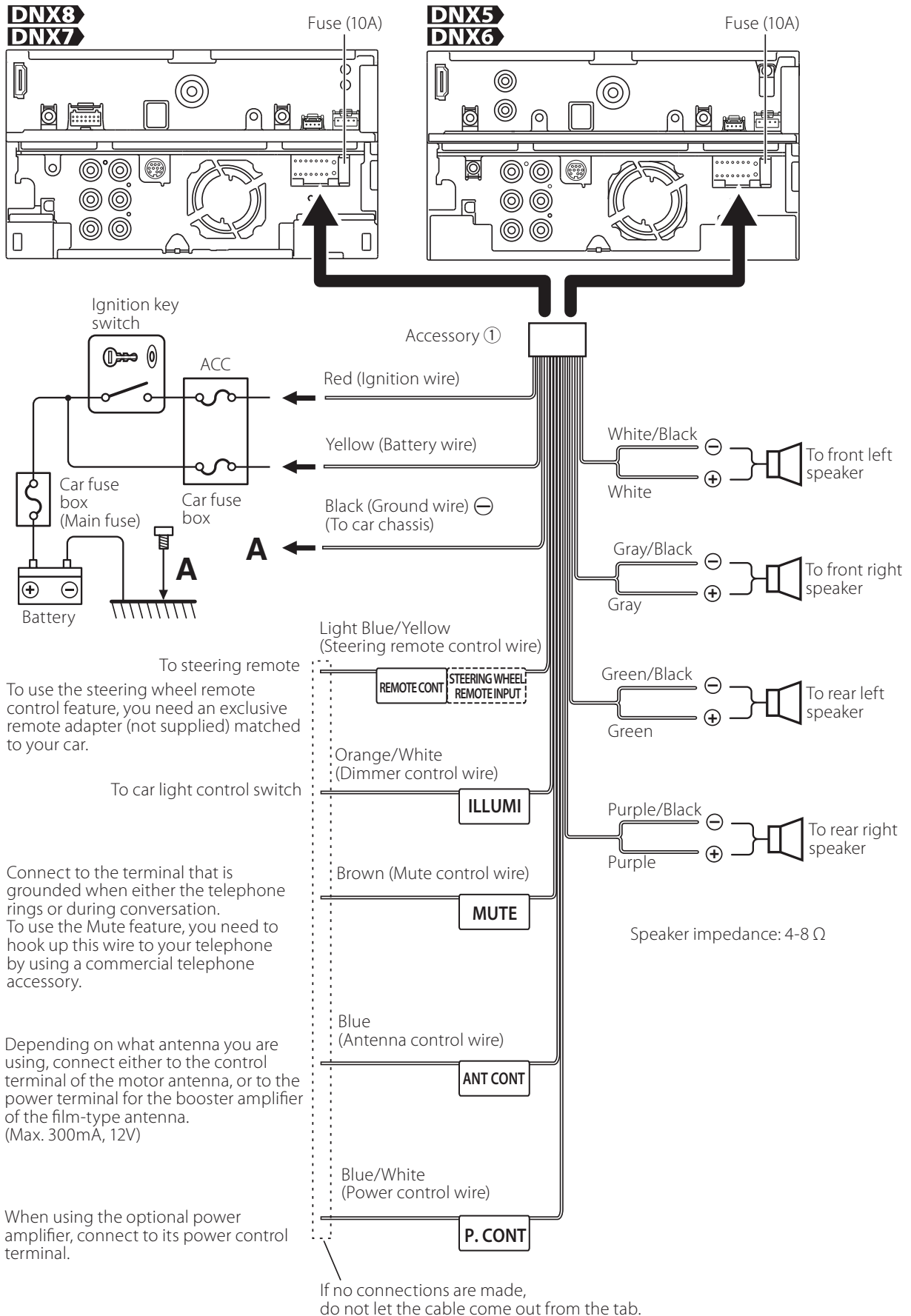

## Optional accessory connection

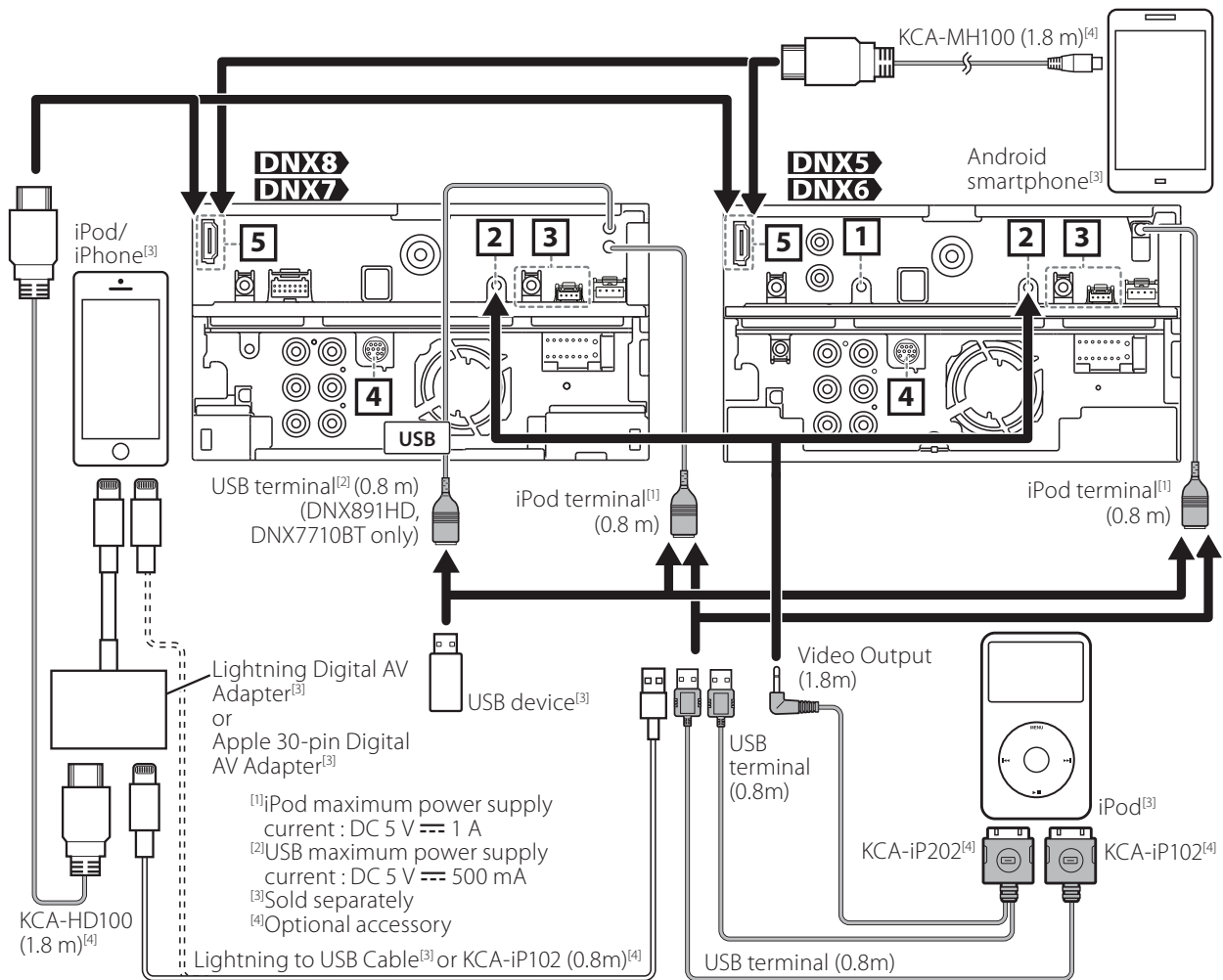

- 1** AV-IN (CA-C3AV; Optional Accessory) input
- 2** iPod/ AV-IN2 (CA-C3AV; Optional Accessory) input
- 3** iDataLink connector (DNX891HD/ DNX771HD/ DNX691HD/ DNX571HD/ DNX571EX only)
- 4** SiriusXM Connect Vehicle Tuner connector (DNX891HD/ DNX771HD/ DNX691HD/ DNX571HD/ DNX571EX only)

- 5** When you connect the cable to HDMI/MHL terminal, remove the fixture. After connecting the cable, put the fixture again.

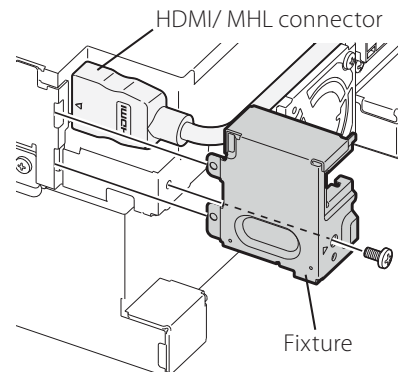

### NOTE

- When you connect iPod/iPhone with HDMI cable, the necessary cable differs depending on the type of the connector like Lightning or 30-pin. Refer to "iPod/iPhone connection" (P.26) for the necessary cable.
- The setting is necessary to meet the connected iPod/iPhone or Android device.
- It is also possible to connect with iPod/iPhone or Android device via Bluetooth. Refer to "iPod/iPhone connection" (P.26) or "Android connection" (P.26).

## About this Unit

### ■ Copyrights

- The Bluetooth word mark and logos are owned by the Bluetooth SIG, Inc. and any use of such marks by JVC KENWOOD Corporation is under license. Other trademarks and trade names are those of their respective owners.
- The “AAC” logo is a trademark of Dolby Laboratories.
- “Made for iPod” and “Made for iPhone” mean that an electronic accessory has been designed to connect specifically to iPod or iPhone, respectively, and has been certified by the developer to meet Apple performance standards.  
Apple is not responsible for the operation of this device or its compliance with safety and regulatory standards. Please note that the use of this accessory with iPod or iPhone may affect wireless performance.
- iPhone, iPod, iPod classic, iPod nano, and iPod touch are trademarks of Apple Inc., registered in the U.S. and other countries.  
Lightning is a trademark of Apple Inc.
- Sirius, XM and all related marks and logos are trademarks of Sirius XM Radio Inc. All rights reserved.
- HD Radio Technology manufactured under license from iBiquity Digital Corporation. U.S. and Foreign Patents. HD Radio™ and the HD, HD Radio, and “Arc” logos are proprietary trademarks of iBiquity Digital Corp.
-  is a trademark of DVD Format/Logo Licensing Corporation registered in the U.S., Japan and other countries.
- This item incorporates copy protection technology that is protected by U.S. patents and other intellectual property rights of Rovi Corporation. Reverse engineering and disassembly are prohibited.
- Manufactured under license from Dolby Laboratories.  
Dolby and the double-D symbol are trademarks of Dolby Laboratories.
- Android is a trademark of Google Inc.
- BlackBerry®, RIM®, Research In Motion® and related trademarks, names and logos are the property of Research In Motion Limited and are registered and/or used in the U.S. and countries around the world. Used under license from Research In Motion

Limited.

- Adobe, Acrobat and Reader are either registered trademarks or trademarks of Adobe Systems Incorporated in the United States and/or other countries.
- ABOUT DIVX VIDEO: DivX® is a digital video format created by DivX, LLC, a subsidiary of Rovi Corporation. This is an official DivX Certified® device that plays DivX video. Visit [divx.com](http://divx.com) for more information and software tools to convert your files into DivX videos.
- ABOUT DIVX VIDEO-ON-DEMAND: This DivX Certified® device must be registered in order to play purchased DivX Video-on-Demand (VOD) movies. To obtain your registration code, locate the DivX VOD section in your device setup menu. Go to [vod.divx.com](http://vod.divx.com) for more information on how to complete your registration.
- DivX®, DivX Certified® and associated logos are trademarks of Rovi Corporation or its subsidiaries and are used under license.
- THIS PRODUCT IS LICENSED UNDER THE AVC PATENT PORTFOLIO LICENSE FOR THE PERSONAL USE OF A CONSUMER OR OTHER USES IN WHICH IT DOES NOT RECEIVE REMUNERATION TO (i) ENCODE VIDEO IN COMPLIANCE WITH THE AVC STANDARD (“AVC VIDEO”) AND/OR (ii) DECODE AVC VIDEO THAT WAS ENCODED BY A CONSUMER ENGAGED IN A PERSONAL ACTIVITY AND/OR WAS OBTAINED FROM A VIDEO PROVIDER LICENSED TO PROVIDE AVC VIDEO. NO LICENSE IS GRANTED OR SHALL BE IMPLIED FOR ANY OTHER USE. ADDITIONAL INFORMATION MAY BE OBTAINED FROM MPEG LA, L.L.C. SEE [HTTP://WWW.MPEGLA.COM](http://WWW.MPEGLA.COM)
- THIS PRODUCT IS LICENSED UNDER THE MPEG-4 VISUAL PATENT PORTFOLIO LICENSE FOR THE PERSONAL AND NON-COMMERCIAL USE OF A CONSUMER FOR (i) ENCODING VIDEO IN COMPLIANCE WITH THE MPEG-4 VISUAL STANDARD (“MPEG-4 VIDEO”) AND/OR (ii) DECODING MPEG-4 VIDEO THAT WAS ENCODED BY A CONSUMER ENGAGED IN A PERSONAL AND NON-COMMERCIAL ACTIVITY AND/OR WAS OBTAINED FROM A VIDEO PROVIDER LICENSED BY MPEG LA TO PROVIDE MPEG-4 VIDEO. NO LICENSE IS GRANTED OR SHALL BE IMPLIED FOR ANY OTHER USE. ADDITIONAL INFORMATION INCLUDING THAT RELATING TO PROMOTIONAL, INTERNAL AND COMMERCIAL USES AND LICENSING MAY BE OBTAINED FROM MPEG LA, LLC. SEE [HTTP://WWW.MPEGLA.COM](http://WWW.MPEGLA.COM).

- The terms HDMI and HDMI High-Definition Multimedia Interface, and the HDMI logo are trademarks or registered trademarks of HDMI Licensing LLC in the United States and other countries.
- MHL and the MHL logo are a trademark or registered trademark of MHL, LLC.
  - Incorporates MHL 2
- libFLAC  
 Copyright (C) 2000,2001,2002,2003,2004,2005,2006,2007,2008,2009 Josh Coalson  
 Redistribution and use in source and binary forms, with or without modification, are permitted provided that the following conditions are met:
  - Redistributions of source code must retain the above copyright notice, this list of conditions and the following disclaimer.
  - Redistributions in binary form must reproduce the above copyright notice, this list of conditions and the following disclaimer in the documentation and/or other materials provided with the distribution.
  - Neither the name of the Xiph.org Foundation nor the names of its contributors may be used to endorse or promote products derived from this software without specific prior written permission.
 THIS SOFTWARE IS PROVIDED BY THE COPYRIGHT HOLDERS AND CONTRIBUTORS "AS IS" AND ANY EXPRESS OR IMPLIED WARRANTIES, INCLUDING, BUT NOT LIMITED TO, THE IMPLIED WARRANTIES OF MERCHANTABILITY AND FITNESS FOR A PARTICULAR PURPOSE ARE DISCLAIMED. IN NO EVENT SHALL THE FOUNDATION OR CONTRIBUTORS BE LIABLE FOR ANY DIRECT, INDIRECT, INCIDENTAL, SPECIAL, EXEMPLARY, OR CONSEQUENTIAL DAMAGES (INCLUDING, BUT NOT LIMITED TO, PROCUREMENT OF SUBSTITUTE GOODS OR SERVICES; LOSS OF USE, DATA, OR PROFITS; OR BUSINESS INTERRUPTION) HOWEVER CAUSED AND ON ANY THEORY OF LIABILITY, WHETHER IN CONTRACT, STRICT LIABILITY, OR TORT (INCLUDING NEGLIGENCE OR OTHERWISE) ARISING IN ANY WAY OUT OF THE USE OF THIS SOFTWARE, EVEN IF ADVISED OF THE POSSIBILITY OF SUCH DAMAGE.

## Android connection

To connect the Android device with this unit, the cable (sold separately) and the profile which your Android device supports are necessary as follows:

- **To listen to music and watch video of APPS source**
  - MHL device
  - KCA-MH100 (Optional Accessory)
  - Bluetooth profile: SPP
- **To listen to music of APPS source**
  - Bluetooth profile: A2DP
  - Bluetooth profile: SPP
- **To listen to music of Bluetooth Audio source**
  - Bluetooth profile: A2DP
  - Bluetooth profile: AVRCP

## iPod/iPhone connection

To connect the iPod/iPhone with this unit, the cable, adapter (both sold separately), and the profile which your iPod/iPhone supports are necessary as follows:

- **To listen music and watch video with Lightning connector device**
  - Lightning Digital AV Adapter
  - KCA-HD100
  - Lightning to USB Cable (accessory of the iPod/iPhone)
  - Bluetooth profile: SPP
- **To listen music with Lightning connector device**
  - Lightning to USB Cable (accessory of the iPod/iPhone)
- **To listen music and watch video with 30-pin connector device (1)**
  - Apple 30-pin Digital AV Adapter
  - KCA-HD100
  - KCA-iP102
  - Bluetooth profile: SPP
- **To listen music and watch video with 30-pin connector device (2)**
  - KCA-iP202
- **To listen music with 30-pin connector device**
  - KCA-iP102
- **To listen to music via Bluetooth**
  - Bluetooth profile: A2DP
  - Bluetooth profile: SPP

## NOTE

- When connecting with Lightning Digital AV Adapter or Apple 30-pin Digital AV Adapter some

applications can be controlled from this unit. The operable functions depend on the application. Refer to "Apps Operation" (P.51) in the Instruction Manual.

- Do not leave the cable or the adapter made by other makers inside the car. It might lead the malfunction caused by heat.

### ■ Connectable iPod/iPhone

The following models can be connected to this unit.

Made for

- iPhone 5
- iPhone 4S
- iPhone 4
- iPhone 3GS
- iPhone 3G
- iPhone
- iPod touch (5th generation)
- iPod touch (4th generation)
- iPod touch (3rd generation)
- iPod touch (2nd generation)
- iPod touch (1st generation)
- iPod classic
- iPod with video
- iPod nano (7th generation)
- iPod nano (6th generation)
- iPod nano (5th generation)
- iPod nano (4th generation)
- iPod nano (3rd generation)

### ■ Requirements Pandora®:

Requirements for listening to the Pandora® are as follows:

#### iPhone or iPod touch

- Use an Apple iPhone or iPod touch running under iOS3 or later.
- Search for "Pandora" in the Apple iTunes App Store to find and install the most current version of the Pandora® application on your device.

#### Android™

- Visit the Google play and search for Pandora to install.

#### BlackBerry®

- Visit [www.pandora.com](http://www.pandora.com) from the built in browser to download the Pandora application.
- Bluetooth must be built in and the following profiles must be supported.
  - SPP
  - A2DP

### NOTE

- In the application on your device, log in and create an account with Pandora.
- (If you are not already a registered user, an account can also be created at [www.pandora.com](http://www.pandora.com).)
- Internet connection by LTE, 3G, EDGE, or WiFi.
- Pandora® is only available in the United States, Australia, and New Zealand.
- Because Pandora® is a third-party service, the specifications are subject to change without prior notice. Accordingly, compatibility may be impaired or some or all of the services may become unavailable.
- Some functions of Pandora® cannot be operated from this unit.
- For issues using the application, please contact Pandora® at [pandora-support@pandora.com](mailto:pandora-support@pandora.com).

### ■ About iHeartRadio®:

Requirements for using iHeartAuto™ are as follows:

#### iPhone or iPod touch

- Use an Apple iPhone or iPod touch running iOS5 or later.
- Search for "iHeartAuto" in the Apple App Store to find and install the most current version of the iHeartAuto™ application on your device.

#### Android™

- Use an Android device with firmware 2.2 or later.
- Search for "iHeartAuto" on Google play to find and install the most current version of the iHeartAuto™ application on your device.

### NOTE

- iHeartRadio® is available only in the United States and U.S. Territories
- For the best application experience, a 3G/4G or Wi-Fi connection is recommended.
- Because iHeartAuto™ is a third-party service, the specifications are subject to change without prior notice. Accordingly, compatibility may be impaired or some or all of the services may become unavailable.
- Some functions of iHeartRadio® cannot be operated from this unit.
- If you experience issues while using the application, please contact iHeartRadio® Customer Care at <http://help.iheartradio.com>.
- iHeartRadio® and iHeartAuto™ are trademarks owned by Clear Channel Broadcasting, Inc. All uses are authorized under license.

DNX891HD/ DNX771HD/ DNX691HD/ DNX571HD/  
DNX571EX:

### **FCC WARNING**

This equipment may generate or use radio frequency energy. Changes or modifications to this equipment may cause harmful interference unless the modifications are expressly approved in the instruction manual. The user could lose the authority to operate this equipment if an unauthorized change or modification is made.

### **NOTE**

This equipment has been tested and found to comply with the limits for a Class B digital device, pursuant to Part 15 of the FCC Rules. These limits are designed to provide reasonable protection against harmful interference in a residential installation.

This equipment may cause harmful interference to radio communications, if it is not installed and used in accordance with the instructions. However, there is no guarantee that interference will not occur in a particular installation. If this equipment does cause harmful interference to radio or television reception, which can be determined by turning the equipment off and on, the user is encouraged to try to correct the interference by one or more of the following measures:

- Reorient or relocate the receiving antenna.
- Increase the separation between the equipment and receiver.
- Connect the equipment into an outlet on a circuit different from that to which the receiver is connected.
- Consult the dealer or an experienced radio/TV technician for help.

### **CAUTION**

Use of controls or adjustments or performance of procedures other than those specified herein may result in hazardous radiation exposure. In compliance with Federal Regulations, following are reproductions of labels on, or inside the product relating to laser product safety.

JVC KENWOOD Corporation  
2967-3, ISHIKAWA-MACHI,  
HACHIOJI-SHI, TOKYO, JAPAN

THIS PRODUCT COMPLIES WITH DHHS  
RULES 21 CFR SUBCHAPTER J IN EFFECT AT  
DATE OF MANUFACTURE.

Location: Top plate

DNX891HD/ DNX771HD/ DNX691HD/ DNX571HD/  
DNX571EX:

### **IC (Industry Canada) Notice**

This device complies with Industry Canada licence-exempt RSS standard(s).

Operation is subject to the following two conditions:  
(1) This device may not cause interference, and  
(2) this device must accept any interference, including interference that may cause undesired operation of the device.

The term "IC: " before the certification/ registration number only signifies that the Industry Canada technical specification were met.

### **CAUTION**

This equipment complies with FCC/IC radiation exposure limits set forth for an uncontrolled environment and meets the FCC radio frequency (RF) Exposure Guidelines in Supplement C to OET65 and RSS-102 of the IC radio frequency (RF) Exposure rules. This equipment has very low levels of RF energy that it deemed to comply without maximum permissive exposure evaluation (MPE). But it is desirable that it should be installed and operated keeping the radiator at least 20cm or more away from person's body (excluding extremities: hands, wrists, feet and ankles).

Under Industry Canada regulations, this radio transmitter may only operate using an antenna of a type and maximum (or lesser) gain approved for the transmitter by Industry Canada. To reduce potential radio interference to other users, the antenna type and its gain should be so chosen that the equivalent isotropically radiated power (e.i.r.p.) is not more than that necessary for successful communication.

DNX891HD/ DNX771HD/ DNX691HD/ DNX571HD/  
DNX571EX:

- Contains Transmitter Module  
FCC ID : YZP-RBFAC21XX
- Contains Transmitter Module  
IC: 7414A-RBFAC21XX

## CALIFORNIA, USA

This product contains a CR Coin Cell Lithium Battery which contains Perchlorate Material – special handling may apply. See [www.dtsc.ca.gov/hazardouswaste/perchlorate](http://www.dtsc.ca.gov/hazardouswaste/perchlorate)

### **Información acerca de la eliminación de equipos eléctricos y electrónicos al final de la vida útil (aplicable a los países que hayan adoptado sistemas independientes de recogida de residuos)**



Los productos con el símbolo de un contenedor con ruedas tachado no podrán ser desechados como residuos domésticos.

Los equipos eléctricos y electrónicos al final de la vida útil, deberán ser reciclados en instalaciones que puedan dar el tratamiento adecuado a estos productos y a sus subproductos residuales correspondientes. Póngase en contacto con su administración local para obtener información sobre el punto de recogida más cercano. Un tratamiento correcto del reciclaje y la eliminación de residuos ayuda a conservar los recursos y evita al mismo tiempo efectos perjudiciales en la salud y el medio ambiente.

#### **Para cumplimiento de la COFETEL:**

“La operación de este equipo esta sujeta a las siguientes dos condiciones:

- (1) es posible que este equipo o dispositivo no cause interferencia perjudicial y
- (2) este equipo o dispositivo debe aceptar cualquier interferencia, incluyendo la que pueda causar su operación no deseada.”

#### **Informação sobre a eliminação de pilhas**

Este produto não deve ser eliminado como lixo doméstico geral. Devolva a pilha usada ao revendedor ou entidade autorizada para que a mesma seja devolvida ao fabricante ou importador. A reciclagem e a eliminação de lixo de maneira apropriada ajudarão a conservar os recursos naturais ao mesmo tempo que prevenirão os efeitos prejudiciais à nossa saúde e ao meio ambiente.



**HDMI™**  **MHL™**  
HIGH-DEFINITION MULTIMEDIA INTERFACE      Mobile High-Definition Link

 **iHeartRADIO**

**SiriusXM**  
READY

Works With  
**PANDORA®**

 **DOLBY DIGITAL**

**DIVX™**

 **Bluetooth®**



**DVD**  
VIDEO™

Made for  
 **iPod**  **iPhone**

Designed for  
 **Windows Media™**

 **Radio®**

This HD Radio receiver enables:

PSD )

HD2/HD3 )

Bookmark )

Digital Sound )

Artist Experience )

---

**KENWOOD**

## DNX891HD DNX7710BT DNX771HD DNX691HD DNX571HD DNX571EX DNX5710BT

---

### GPS NAVIGATION SYSTEM INSTRUCTION MANUAL

JVC KENWOOD Corporation

Before reading this manual, click the button below to check the latest edition and the modified pages.

**Take the time to read through this instruction manual.**

**Familiarity with installation and operation procedures will help you obtain the best performance from your new GPS Navigation System.**

**For your records**

Record the serial number, found on the back of the unit, in the spaces designated on the warranty card, and in the space provided below. Refer to the model and serial numbers whenever you call upon your Kenwood dealer for information or service on the product.

Model DNX891HD/ DNX771HD/ DNX691HD/ DNX571HD/ DNX571EX Serial number \_\_\_\_\_

***US Residence Only***

**Register Online**

Register your Kenwood product at [www.Kenwoodusa.com](http://www.Kenwoodusa.com)



# What Do You Want To Do?

Thank you for purchasing the KENWOOD GPS NAVIGATION SYSTEM.  
In this manual, you will learn various convenient functions of the system.

**Click the icon of the media you want to play.**

With one-click, you can jump to the section of each media!

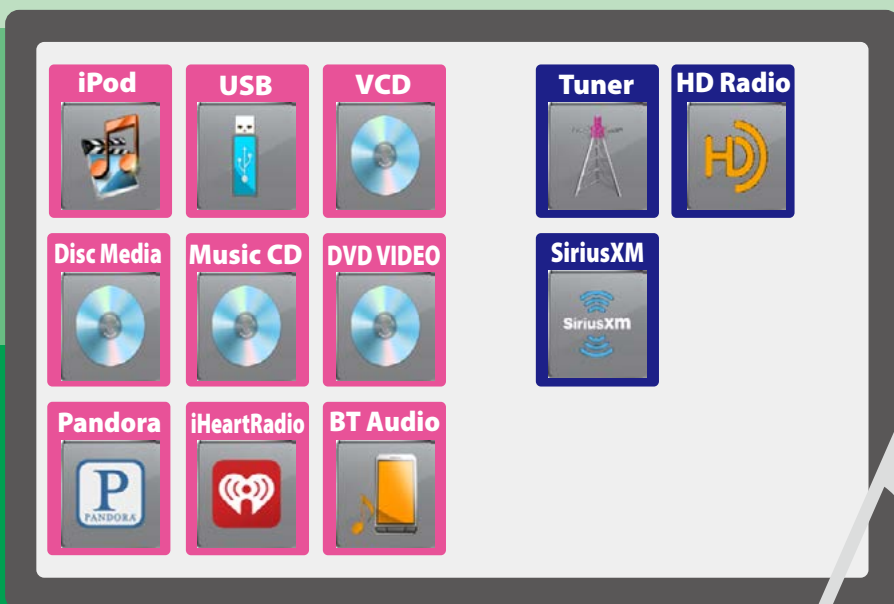

# Contents

## **Before Use 4**

▲ WARNING \_\_\_\_\_ 4

## **How to Read this Manual 5**

## **Basic Operations 6**

Functions of the Buttons  
on the Front Panel \_\_\_\_\_ 6

Turning on the Unit \_\_\_\_\_ 10

How to Play Media \_\_\_\_\_ 13

Operating with the Top Menu Screen \_\_\_\_ 14

Common Operations \_\_\_\_\_ 16

Navigation Operation \_\_\_\_\_ 18

OEM Features Operation \_\_\_\_\_ 20

## **DVD/Video CD (VCD) Operation 22**

DVD/VCD Basic Operation \_\_\_\_\_ 22

DVD Disc Menu Operation \_\_\_\_\_ 25

Zoom Control For DVD And VCD \_\_\_\_\_ 26

DVD Setup \_\_\_\_\_ 28

## **CD/Audio and Visual Files/ iPod/App Operation 32**

Music/Video/Picture Basic Operation \_\_\_\_ 32

Search Operation \_\_\_\_\_ 39

Movie Control \_\_\_\_\_ 44

Pandora® Operation \_\_\_\_\_ 45

iHeartRadio Operation \_\_\_\_\_ 48

Apps Operation \_\_\_\_\_ 51

USB/iPod/DivX Setup \_\_\_\_\_ 52

## **Radio and HD Radio™ Tunzwer Operation 58**

Radio/HD Radio Tuner Basic Operation\_\_ 58

Memory Operation \_\_\_\_\_ 61

Selecting Operation \_\_\_\_\_ 62

Traffic Information \_\_\_\_\_ 64

Receive Mode \_\_\_\_\_ 64

Bookmark \_\_\_\_\_ 65

## **SiriusXM® Operation 68**

SiriusXM® Basic Operation \_\_\_\_\_ 68

Memory Operation \_\_\_\_\_ 71

Selecting Operation \_\_\_\_\_ 71

Content alert \_\_\_\_\_ 73

SiriusXM Replay™ \_\_\_\_\_ 74

Smart Favorites, TuneStart™ \_\_\_\_\_ 75

TuneScan™ \_\_\_\_\_ 75

SiriusXM Setup \_\_\_\_\_ 76

## **Bluetooth Control 82**

Registering And  
Connecting Bluetooth Unit \_\_\_\_\_ 82

Playing Bluetooth Audio Device \_\_\_\_\_ 84

Using Hands-Free Unit \_\_\_\_\_ 85

Smartphone Link \_\_\_\_\_ 88

Hands-Free Setup \_\_\_\_\_ 90

## **Setting Up** **92**

Monitor Screen Setup _____	92
View Camera Control _____	93
System Setup _____	93
Display Setup _____	98
Navigation Setup _____	101
Camera Setup _____	102
Software Information _____	103
AV Input Setup _____	103
AV Output Interface Setup _____	104
External Device Control _____	104

## **Controlling Audio** **106**

Setting Audio _____	106
Controlling General Audio _____	110
Equalizer Control _____	110
Zone Control _____	112
Sound Effect _____	113
Listening Position _____	115

## **Remote control** **118**

Battery Installation _____	118
Functions of the Remote control Buttons _____	119

## **Troubleshooting** **122**

Problems and Solutions _____	122
Error Messages _____	123
Resetting the Unit _____	125

## **Appendix** **126**

Playable Media and Files _____	126
Status Bar Indicator Items _____	130
Region Codes in the World _____	132
DVD Language Codes _____	133
Specifications _____	134
About this Unit _____	137

## Before Use

### ⚠ WARNING

#### To prevent injury or fire, take the following precautions:

- To prevent a short circuit, never put or leave any metallic objects (such as coins or metal tools) inside the unit.
- Do not watch or fix your eyes on the unit's display when you are driving for any extended period.
- If you experience problems during installation, consult your Kenwood dealer.

#### Precautions on using this unit

- When you purchase optional accessories, check with your Kenwood dealer to make sure that they work with your model and in your area.
- You can select language to display menus, audio file tags, etc. See [Language setup \(P.95\)](#).
- The Radio Data System or Radio Broadcast Data System feature won't work where the service is not supported by any broadcasting station.

#### Protecting the monitor

To protect the monitor from damage, do not operate the monitor using a ball point pen or similar tool with the sharp tip.

#### Cleaning the unit

If the faceplate of this unit is stained, wipe it with a dry soft cloth such as a silicon cloth. If the faceplate is stained badly, wipe the stain off with a cloth moistened with neutral cleaner, then wipe it again with a clean soft dry cloth.



- Applying spray cleaner directly to the unit may affect its mechanical parts. Wiping the faceplate with a hard cloth or using a volatile liquid such as thinner or alcohol may scratch the surface or erase screened print.

#### Lens fogging

When you turn on the car heater in cold weather, dew or condensation may form on the lens in the disc player of the unit. Called lens fogging, this condensation on the lens may not allow discs to play. In such a situation, remove the disc and wait for the condensation to evaporate. If the unit still does not operate normally after a while, consult your Kenwood dealer.

#### Precautions on handling discs

- Do not touch the recording surface of the disc.
- Do not stick tape etc. on the disc, or use a disc with tape stuck on it.
- Do not use disc type accessories.
- Clean from the center of the disc and move outward.
- When removing discs from this unit, pull them out horizontally.
- If the disc center hole or outside rim has burrs, use the disc only after removing the burrs with a ballpoint pen etc.
- Discs that are not round cannot be used.

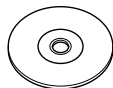

- 8-cm (3 inch) discs cannot be used.
- Discs with coloring on the recording surface or discs that are dirty cannot be used.
- This unit can only play the CDs with



This unit may not correctly play discs which do not have the mark.

- You cannot play a disc that has not been finalized. (For the finalization process see your writing software, and your recorder instruction manual.)

# How to Read this Manual

[Return to the Top page](#)  
[CD, Disc, iPod, USB device](#)

## Search Operation

You can search the music, video, or picture file by some operations.

### NOTE

- If you use a remote controller, you can jump directly to the desired track/file with entering the track/folder/file number, play time, etc. For details, see "[Direct search mode](#)" (p.81).

### List search

You can search tracks, folders, and files according to hierarchy.

For USB devices and iPods, you can list and search files in the device by using playlist.

**1 Press the <MENU> button during playback.**  
Simple Control screen appears.

**2 Touch [  ].**  
List Control screen appears.

**3 Touch desired track/file.**

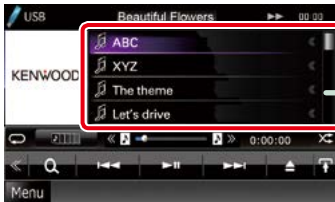

Playback starts.

### Other search

When you want to narrow the list down, there are other search ways.

**1 Press the <MENU> button during playback.**  
Simple Control screen appears.

**2 Touch [  ].**  
The search type screen appears.

### Link header

You can refer each section or top page with one-click.

### Operation title

Introduces the function.

### NOTE

Introduces some tips, notes, etc.

### Reference mark

Displayed in blue notes.

With one-click, you can jump to the article related to the current section.

### Operation procedure

Explains necessary procedures to achieve the operation.

< >: Indicates the name of panel buttons.

[ ]: Indicates the name of touch keys.

### Screen shot

Shows some screen shots displayed during operation for reference.

The area or keys to touch are surrounded with a red frame.

### NOTE

- The screens and panels shown in this manual are examples used to provide clear explanations of the operations. For this reason, they may be different from the actual screens or panels used, or some display patterns may be different.



## Basic Operations

### Functions of the Buttons on the Front Panel

#### DNX891HD/ DNX7710BT/ DNX771HD

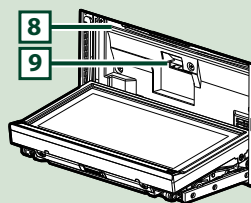
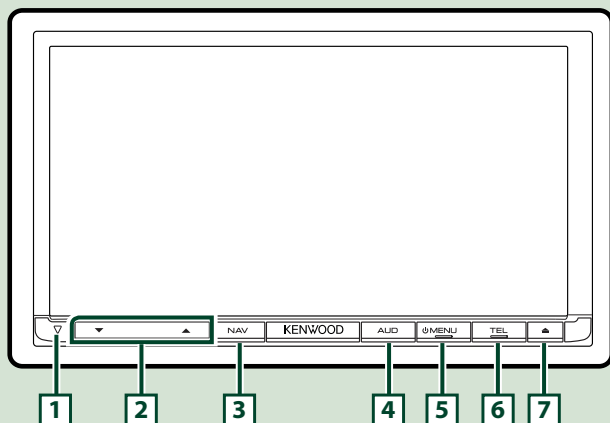

#### NOTE

- The panels shown in this guide are examples used to provide clear explanations of the operations. For this reason, they may be different from the actual panels.
- In this manual, each model name is abbreviated as follows.

DNX891HD: **DNX8**

DNX7710BT, DNX771HD: **DNX7**

If above icon is showed, read the article applicable to the unit you use.

### How to insert an SD Card

- 1) Press **[7] <▲>** button for 1 second.  
The panel fully opens.
- 2) Hold the SD card as the illustration in the right and insert it into the slot until it clicks.

#### ● To eject the card:

Push the card until it clicks and then remove your finger from the card.

The card pops up so that you can pull it out with your fingers.

Labelled side

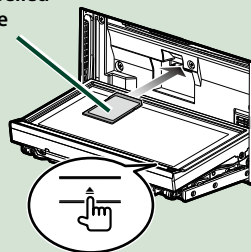

Number	Name	Motion
<b>1</b>	▽ (Reset)	<ul style="list-style-type: none"> <li>If the unit or the connected unit fails to operate properly, the unit returns to factory settings when this button is pressed <a href="#">(P.125)</a>.</li> <li>This indicator flashes when the vehicle ignition is off <a href="#">(P.96)</a>.</li> </ul>
<b>2</b>	▼, ▲ (Vol)	<ul style="list-style-type: none"> <li>Adjusts volume.</li> </ul>
<b>3</b>	NAV	<ul style="list-style-type: none"> <li>Displays the navigation screen.</li> <li>Pressing for 1 second switches AV out sources.</li> </ul>
<b>4</b>	AUD	<ul style="list-style-type: none"> <li>Displays Graphic Equalizer screen <a href="#">(P.111)</a>.*</li> <li>Pressing for 1 second switches camera view display on/off.</li> </ul>
<b>5</b>	MENU	<ul style="list-style-type: none"> <li>Displays the Top Menu screen <a href="#">(P.14)</a>.</li> <li>Pressing for 1 second turns the power off.</li> <li>When the power off, turns the power on.</li> </ul>
<b>6</b>	TEL	<ul style="list-style-type: none"> <li>Displays the Hands Free screen <a href="#">(P.85)</a>.</li> <li>Pressing for 1 second displays the Voice Recognition screen. <a href="#">(P.88)</a></li> </ul>
<b>7</b>	▲ (Eject)	<ul style="list-style-type: none"> <li>Ejects the disc.</li> <li>When the panel is opened, pressing closes the panel and pressing for 1 second ejects the disc forcibly.</li> <li>When the panel is closed, pressing for 1 second fully opens the panel to the location of the SD card slot.</li> </ul>
<b>8</b>	Disc insert slot	<ul style="list-style-type: none"> <li>A slot to insert a disc media.</li> </ul>
<b>9</b>	SD card slot	An SD card slot for upgrading the map. For how to upgrade the map, refer to the instruction manual of the navigation system.

\*The display may not switch to the Graphic Equalizer screen in some conditions.

## DNX691HD/DNX571HD/DNX5710BT/DNX571EX

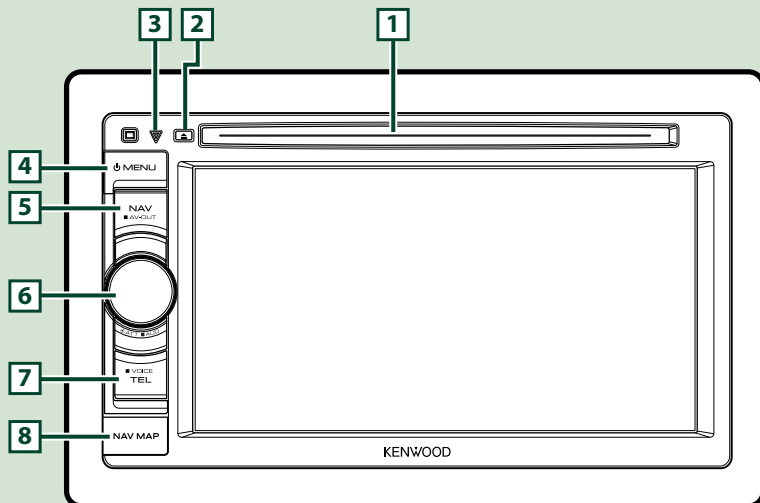

### NOTE

- The panels shown in this guide are examples used to provide clear explanations of the operations. For this reason, they may be different from the actual panels.
- In this manual, each model name is abbreviated as follows.  
DNX691HD: **DNX6**  
DNX571HD, DNX571EX, DNX5710BT: **DNX5**  
If above icons are showed, read the article applicable to the unit you use.

## How to insert a microSD Card

- 1) Open the [8] microSD card slot cover as the illustration in the right.
- 2) Hold the microSD card with the label facing up and the notched section right, and insert it into the slot until it clicks.

### ● To eject the card:

Push the card until it clicks and then remove your finger from the card.

The card pops up so that you can pull it out with your fingers.

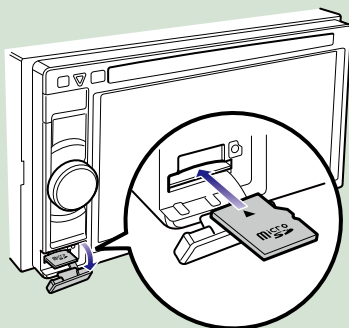

Number	Name	Motion
<b>1</b>	Disc insert slot	<ul style="list-style-type: none"> <li>• A slot to insert a disc media.</li> </ul>
<b>2</b>	▲ (Eject)	<ul style="list-style-type: none"> <li>• Ejects the disc.</li> <li>• Pressing for 1 second ejects the disc forcibly.</li> </ul>
<b>3</b>	▽ (Reset)	<ul style="list-style-type: none"> <li>• If the unit or the connected unit fails to operate properly, the unit returns to factory settings when this button is pressed <a href="#">(P.125)</a>.</li> <li>• This indicator flashes when the vehicle ignition is off <a href="#">(P.96)</a>.</li> </ul>
<b>4</b>	MENU	<ul style="list-style-type: none"> <li>• Displays the Top Menu screen <a href="#">(P.14)</a>.</li> <li>• Pressing for 1 second turns the power off.</li> <li>• When the power off, turns the power on.</li> </ul>
<b>5</b>	NAV	<ul style="list-style-type: none"> <li>• Displays the navigation screen.</li> <li>• Pressing for 1 second switches AV out sources.</li> </ul>
<b>6</b>	Volume Knob	<ul style="list-style-type: none"> <li>• Turning adjusts volume up or down.</li> <li>• Pressing switches attenuation of the volume on/off.</li> <li>• Pressing for 1 second displays Graphic Equalizer screen <a href="#">(P.111)</a>.*</li> </ul>
<b>7</b>	TEL	<ul style="list-style-type: none"> <li>• Displays the Hands Free screen <a href="#">(P.85)</a>.</li> <li>• Pressing for 1 second displays the Voice Recognition screen. <a href="#">(P.88)</a></li> </ul>
<b>8</b>	microSD card slot	<ul style="list-style-type: none"> <li>• A microSD card slot for upgrading the map. For how to upgrade the map, refer to the instruction manual of the navigation system.</li> </ul>

\* The display may not switch to the Graphic Equalizer screen in some conditions.

## Turning on the Unit

The method of turning on is different depending on the model.

- 1 Press the <MENU> button.

### DNX8 ▶ DNX7 ▶

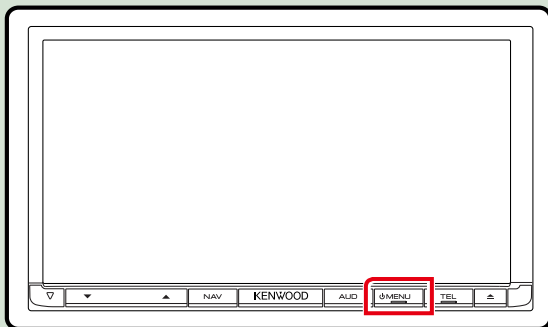

### DNX6 ▶ DNX5 ▶

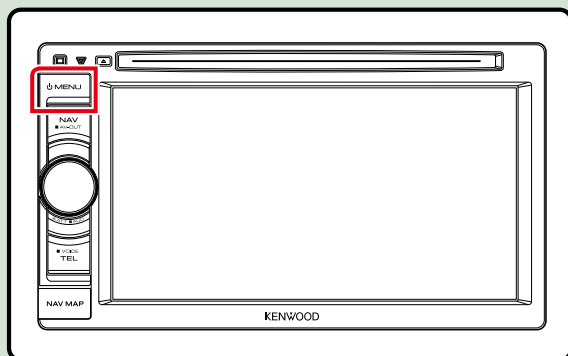

The unit is turned on.

- **To turn off the unit:**  
Press the <MENU> button for 1 second.

If it is your first time turning the unit on after installation, it will be necessary to perform [Initial setup \(P.11\)](#).

## Initial setup

Perform this setup when you use this unit first time or when you reset the unit ([P.125](#)).

### 1 Set each item as follows.

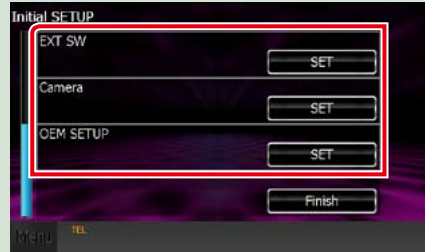

#### Locale

Select the country for the navigation system.

The language, the distance unit, and the gasoline unit are set.

After setting, touch [Enter].

- ① Touch [SET].
- ② Select the desired country.
- ③ Touch [Enter].

#### Language

Select the language used for the control screen and setting items. Default is "American English (en)".

- ① Touch [SET].
- ② Touch [◀] or [▶] to select the desired language.
- ③ Touch [Enter].

For detailed operation, see [Language setup \(P.95\)](#).

#### Angle **DNX8** **DNX7**

Adjust the position of the monitor. Default is "0".

- ① Touch [SET].
- ② Touch desired angle number and [↵].

For detailed operation, see [Monitor angle control \(P.98\)](#).

#### Color

Set the screen and button illumination color. You can select whether to allow color scan operation or select a fixed color for operation.

- ① Touch [SET].
- ② Touch [ON] or [OFF] of [Panel Color Scan].
- ③ If you want to change color, touch [SET] of [Panel Color Coordinate].
- ④ Touch your desired color and [↵].

For detailed operation, see [Panel color coordinate \(P.99\)](#).

**Continued**

### EXT SW (DNX891HD, DNX7710BT only)

Control the external devices.

① Touch [SET].

② Set device name, output pattern, and pulse set for each device. Then, touch [↵].

For detailed operation, see [EXT SW setup \(P.96\)](#).

### Camera

Set the parameters for the camera.

① Touch [SET].

② Set each item and touch [↵].

For detailed operation, see [Camera Setup \(P.102\)](#).

### OEM SETUP (North America Sales area only)

This function requires a commercial adaptor.

Consult your Kenwood dealer for details.

## 2 Touch [Finish].



### NOTE

- These settings can be set from the SETUP menu. See [Setting Up \(P.92\)](#).

## How to Play Media

### Music CD and disc media

#### DNX8 DNX7

- 1 Press the <▲> button.

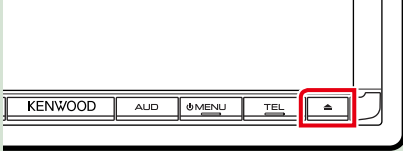

The panel opens.

- 2 Insert the disc into the slot.

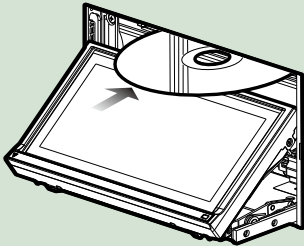

The panel closes automatically.  
The unit loads the disc and playback starts.

- **To eject the disc:**  
Press the <▲> button.

#### DNX6 DNX5

- 1 Insert the disc into the slot.

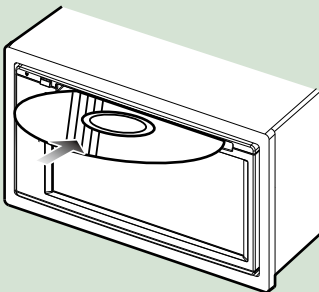

The unit loads the disc and playback starts.

- **To eject the disc:**  
Press the <▲> button.

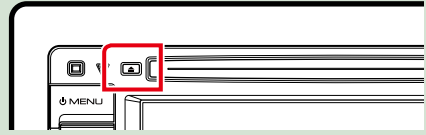

### USB device

- 1 Connect the USB device with the USB cable.

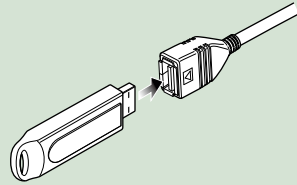

The unit reads the device and playback starts.

- **To disconnect the device:**  
Touch [▲] on the screen and disconnect the device from the cable.

### iPod

- 1 Connect the iPod.

The unit reads the iPod and playback starts.

#### NOTE

- For the details of the necessary cable and adapter to connect with iPod/iPhone, refer to [Music/Video/Picture Basic Operation \(P.32\)](#).

- **To disconnect the iPod/iPhone connected with the cable:**  
Touch [◀] on the screen and then touch [▲]. Disconnect the iPod from the cable.



## Operating with the Top Menu Screen

Most functions can be performed from the Top Menu screen.

### 1 Touch [Menu] on any screen.



#### NOTE

- If [Menu] is not displayed during video/picture playback, press the <MENU> button. [\(P.6\)](#)

Top Menu screen appears.



#### NOTE

- Top Menu screen can be changed by flicking left or right.

### ● Customizing Top Menu screen





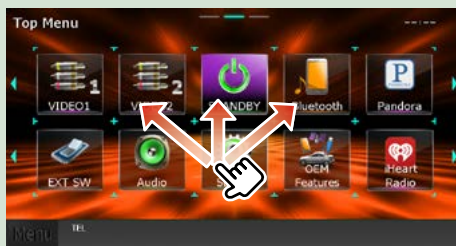

You can arrange the position of the source icons as you like.

1. Touch and hold the icon which you want to move to go into the customizing mode.
2. Drag it where you want to move.

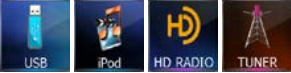
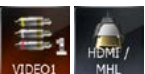
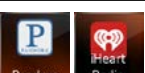
#### Customizing mode screen

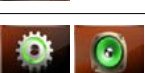

From this screen, you can perform the following functions.

Function	Icon	Operation
Switch the audio source	 USB iPod HD RADIO TUNER etc.	Touch the icon of the desired source.
Switch the video source	 VIDEO1 HDMI / MHL etc.	Touch the icon of the desired video source.
Switch the application installed in the iPhone/iPod or Android.	 Pandora iHeart Radio	Touch the icon of the desired application.
Switch the Apps source	 APPS	Touch the icon of the desired App source.
Enter setup mode	 SETUP Audio etc.	Touch the icon of the desired setup function.
Display navigation screen	 NAV or 0.5 mi → Sunset Blvd	Touch [NAV] or navigation information.
Turn off all audio function	 STANDBY	Touch [STANDBY].
Vehicle information display	 OEM Features	Touch [OEM Features].

# Common Operations

Introduces the common operations.

## General

There are some functions which can be operated from most screens.



### [Menu] (Screen control)

Returns to the Top Menu screen. Touching for at least 1 second displays the Screen Control screen. (Even when an image is displayed, touching for at least 1 second displays the Screen Control screen.)

### [RETURN]

Returns to previous screen.

### [Common menu key]

Touch to display the common menu. The contents of the menu are as follows.

: Displays the EXT SW Control screen. (DNX891HD, DNX7710BT only)

: Displays the SETUP Menu screen.

: Displays the Audio Control Menu screen.

: Displays the control screen of current source. Icon feature differs depending on the source.

: Closes the menu.

## List screen

There are some common function keys in the list screens of most sources.



### [Scroll]

Scrolls the displayed text.

### [All > etc.]

Touch keys with various functions are displayed here. Displayed keys differ depending on the current audio source, status, etc. For examples of functions of each key, refer to the table below.

Key	Function
	Lists all the music in the lower hierarchy.
	Moves to the upper hierarchy.
	Displays current category folder.
	Displays music/picture/movie file list.

## Flick scrolling

You can scroll the list screen by flicking the screen up/down or right/left.



## Navigation Operation

For details on the navigation function, please refer to the Navigation Instruction Manual.

### Display the navigation screen

- 1 Press the <NAV> button.

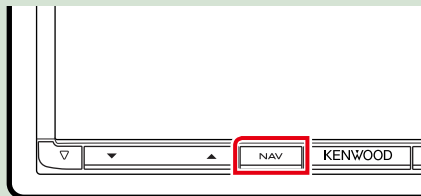

**DNX8** **DNX7**

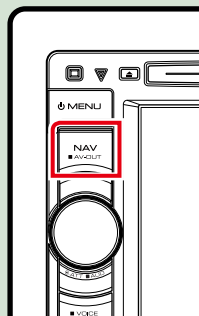

**DNX6** **DNX5**

The navigation screen appears.

### Control audio from the navigation screen

You can control audio sources while the navigation screen is displayed.

Also, you can view the navigation information while the source control screen is displayed.

- 1 Touch the information bar.



The navigation screen with audio information appears.

**2** Touch [  ] or [  ] in the navigation screen.



Touching this area displays the audio screen.

 : Displays the navigation and control keys of the current source.



 : Displays the navigation and current video/picture playback display.



**NOTE**

- The screen switches between playback screen and camera view each time the viewing area is touched.
- Touching the source icon in the bottom of the screen displays the full audio screen.

**● To return to the full navigation screen:**

Touch [  ].

**NOTE**

- For details on control keys, refer to the instructions in each section.

## OEM Features Operation

By connecting this unit to the bus system of the vehicle using an iDataLink (commercially available), this unit can access the satellite radio source provided for the vehicle and vehicle information can be displayed on this unit.

**1 Touch [Menu] on any screen.**

Top Menu screen appears.

**2 Touch [OEM Features] in the Top Menu screen.**

OEM Features screen appears.



 : Displays the control screen of the satellite radio source provided for the vehicle.



 : Displays the control screen of the media player source provided for the vehicle.

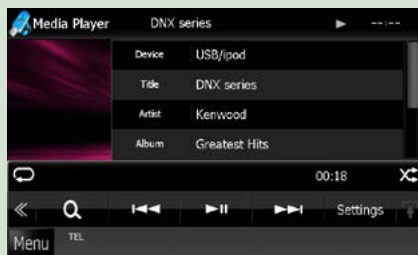

 : Displays the control screen of the Bluetooth Hands Free function provided for the vehicle.



 : Displays the control screen of the Bluetooth streaming source provided for the vehicle.

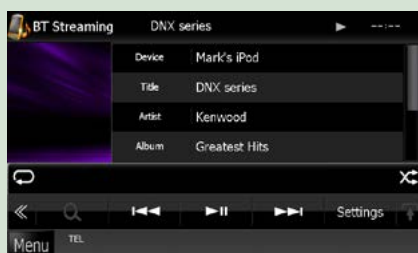

 : Displays information about the instruments such as a speedometer.



 : Displays information about the air conditioner of the vehicle.



 : Displays information about the Parking Distance Sensor of the vehicle.



 : Displays information about the tire pressures of the vehicle.

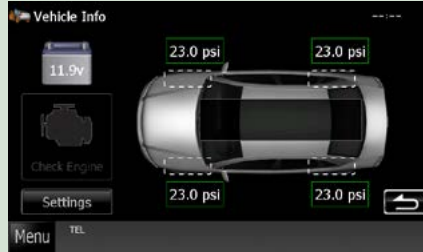

## NOTE

- Displayable screens, button names, and screen names vary depending on the type of the connected iDataLink and the model of the vehicle. For more details, access the following URL: [www.idatalink.com/](http://www.idatalink.com/)



# DVD/Video CD (VCD) Operation

## DVD/VCD Basic Operation

Most functions can be controlled from the source control screen and playback screen.

### NOTE

- Set the remote control mode switch to DVD mode before starting operation, see [Switching the operation mode \(P.119\)](#).
- The screen shot below is for DVD. It may be different from the one for VCD.

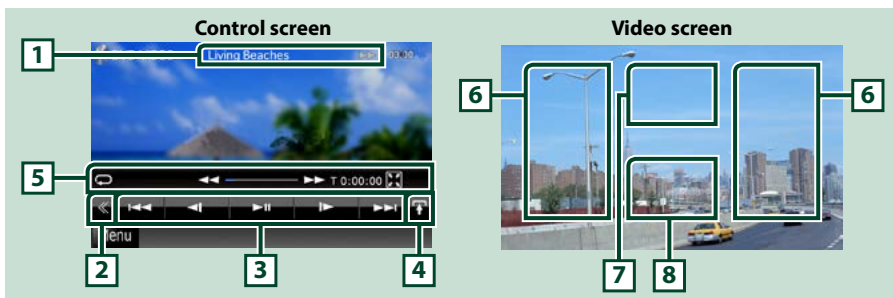

### 1 Information display

Displays the following information.

- **Title #, Chap #:** DVD title and chapter number display
- **Track #/Scene #:** VCD track or scene number display  
Scene # is displayed only when Playback control (PBC) is on.
- **▶, ▶▶, ▶▶▶, ■, etc.:** Current play mode display  
The meanings of each icon are as follows; ▶ (play), ▶▶ (fast forward), ◀◀ (fast backward), ▶▶▶ (search up), ◀◀◀ (search down), ■ (stop), **R** (resume stop), || (pause), |▶ (slow playback), ◀| (slow reverse playback).

Touch this area to display the disc label name.

### 2 Multi function key

Touch to switch the multi function menu. For details on the menu, see [Multi function menu \(P.24\)](#).

### 3 Multi function menu







Various functions can be performed by using keys in this area. For details on the keys, see [Multi function menu \(P.24\)](#).

### 4 Control switching key

Unavailable in DVD/VCD source.

## 5 Sub function menu

The following functions can be performed by using keys in this area.

- **Repeats the current content:** Touch [  ]. Each time you touch the key, repeat mode switches in the following sequence:  
DVD: "title repeat"  "chapter repeat"  "function off"  
VCD (PBC On): Does not repeat  
VCD (PBC Off): "track repeat"  "function off"
- **Hides all keys:** Touch [  ].
- **Fast forward or fast backward:** Touch [  ] or [  ]. Each time you touch the key, the speed changes; standard, 2 times, 3 times.
- **Confirms play time:** See ###:##.  
DVD: You can switch the time display between title play time, chapter play time, and title remaining time. Each time you touch, the display switches between "T ###:##" (title play time display), "C ###:##" (chapter play time display), and "R ###:##" (title remaining time display).  
As well as the time display, the bar indicating current location appears.  
VCD (PBC off): You can also confirm disc remaining time by touching time display. Each time you touch, the display switches between "P ###:##" (play time display) and "R ###:##" (disc remaining time).
- **Confirms the current location:** See the bar in center (DVD only). The bar does not appear when the time display is remaining time display.

## 6 Searching area

Touch to search the next/previous content.

Scrolling from center of display to left or right performs fast backward or fast forward. Each time you touch each area, the speed changes; standard, 2 times, 3 times. To stop fast backward/forward, touch center of the display.

## 7 Menu display area

This area functions differently depending on the current status.

- **During DVD playback:** Displays the DVD menu. During the menu display, displays the highlight control screen.
- **During VCD playback:** Displays the Zoom Control screen ([P.26](#)).

## 8 Key display area

Touch to display the last control screen.

### NOTE

- If you use a remote control, you can jump directly to the desired image with entering the chapter number, scene number, play time, etc ([P.119](#)).

## Multi function menu

### DVD



### VCD



The functions of each key are as follows.

[<<] [>>]

Searches the previous/next content.

[▶ II]

Plays or pauses.

[◀ I] or [I ▶] (DVD only)

Plays in slow motion forward or backward.

[■]

Stops playback. When touched twice, the disc is played from the beginning when you play it the next time.

[PBC] (VCD only)

Turn Playback control (PBC) on or off.

[ SETUP]

Touch to display the SETUP Menu screen. See [Setting Up \(P.92\)](#).

[ AUDIO]

Touch to display the Audio Control screen. See [Controlling Audio \(P.106\)](#).

[ EXT SW] (DNX891HD, DNX7710BT only)

Touch to control the external device power supply. For details, see [External Device Control \(P.104\)](#).

[REAR 

Touch to mute the rear speaker.

## DVD Disc Menu Operation

You can set up some items in the DVD-VIDEO disc menu.

### 1 Touch illustrated area during playback.



Menu Control screen appears.

### 2 Perform desired operation as follows.



#### Displays the top menu

Touch [Top].\*

#### Displays the menu

Touch [Menu].\*

#### Displays the previous menu

Touch [Return].\*

#### Enters selected item

Touch [Enter].

#### Enables direct operation

Touch [Highlight] to enter the highlight control mode ([P.25](#)).

#### Moves the cursor

Touch [▲], [▼], [◀], [▶].

\*These keys may not function depending on the disc.

## Highlight control

Highlight control lets you control the DVD menu by touching the menu key directly on the screen.

### 1 Touch [Highlight] in the Menu Control screen.

### 2 Touch desired item on the screen.



#### NOTE

- The highlight control is cleared automatically if you do not operate for a constant time.

## DVD play mode setting

You can select DVD play mode.

- 1 Touch [Next] in the Menu Control screen.



Menu Control 2 screen appears.

- 2 Touch the key which corresponds to desired setting item.



### Switches the subtitle language

Touch [Subtitle]. Each time you touch this key, language is switched.

### Switches the audio language

Touch [Audio]. Each time you touch this key, language is switched.

### Controls zoom ratio

Touch [Zoom]. For details, see [step 2 in Zoom Control For DVD And VCD \(P.26\)](#).

### Switches the picture angle

Touch [Angle]. Each time you touch this key, picture angle is switched.

### Exits menu control

Touch [Exit].

### Displays the Menu Control 1 screen

Touch [Previous].

## Zoom Control For DVD And VCD

You can enlarge Playback screen for DVD and VCD.

- 1 For VCD, touch illustrated area during playback.



Zoom Control screen appears.

### NOTE

- For DVD, please refer to [DVD play mode setting \(P.26\)](#) to display the Zoom Control screen.

- 2 Perform desired operation as follows.



### Switches zoom ratio

Touch [Zoom].

For DVD, changes the zoom ratio at 4 levels; Off, 2 times, 3 times, 4 times.

For VCD, changes the zoom ratio at 2 levels; Off, 2 times.

### Scrolls the screen

Touch [▲], [▼], [◀], or [▶] to scroll the screen in the direction you touch.

### Exits menu control

Touch [Exit].

### Displays the previous menu\*

Touch [Return].

**\*This function may not be performed depending on the disc.**

**NOTE**

- You cannot touch the menu keys directly on the screen when zooming.

## DVD Setup

You can set up the DVD playback functions.

### NOTE

- Each operation in this section can be started from the Top Menu screen. For details, see [Operating with the Top Menu Screen \(P.14\)](#).
- Some setup items can only be set in standby mode.

**1 Touch [ ] in the control screen.**

Multi function menu appears.

**2 Touch [SETUP].**

SETUP Menu screen appears.

**3 Touch [Source].**

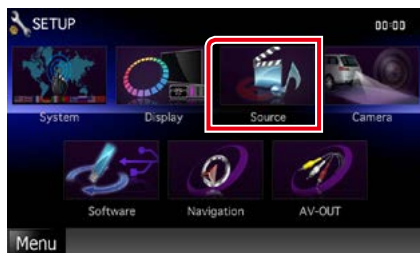

Source SETUP Menu screen appears.

**4 Touch [DVD SETUP] in the list.**

DVD SETUP screen appears.

**5 Set each item as follows.**



### Menu/Subtitle/Audio Language\*

See [Language setup \(P.29\)](#).

### Dynamic Range Control\*

Sets the dynamic range.

**Wide:** The dynamic range is wide.

**Normal:** The dynamic range is normal.

**Dialog (Default):** Makes the total sound volume larger than other modes. This is effective only when you are using Dolby Digital software.

### Angle Mark

Sets an angle mark display.

**ON (Default):** An angle mark appears.

**OFF:** An angle mark does not appear.

### Screen Ratio\*

Sets the screen display mode.

**16:9 (Default):** Displays wide pictures.

**4:3 LB:** Displays wide pictures in the Letter Box format (having black stripes at the top and bottom of screen).

**4:3 PS:** Displays wide pictures in the Pan & Scan format (showing pictures cut at the right and left ends).

### Parental Level\*

See [Parental level \(P.30\)](#).

### DISC SETUP

See [Disc setup \(P.30\)](#).

## Stream Information

Displays the present source information.

The stream (Dolby Digital, Linear PCM, MPEG, WMA or AAC) appears.

\* These items are disabled when a DVD is inserted.

## Language setup

This setting is for the language used in the menu, subtitle, and voice. You cannot setup these items during DVD playback.

**1 Touch [SET] of the desired item; [Menu Language], [Subtitle Language], [Audio Language].**

Language Set screen appears.

**2 Enter the desired language code and touch [Enter].**

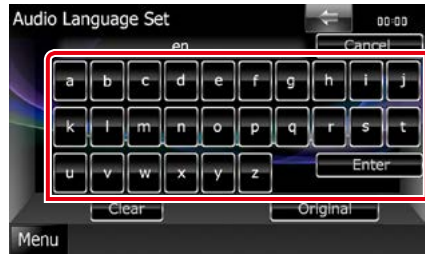

For language code, refer to [DVD Language Codes \(P.133\)](#).

Sets the entered language and returns to the DVD SETUP screen.

### NOTE

- To cancel the setup and return to the previous screen, touch [Cancel].
- To clear the entered code, touch [Clear].
- To set the DVD's original language for audio language, touch [Original].



## Parental level

Sets a parental level. You cannot setup this item during DVD playback.

### 1 Touch [SET] of [Parental Level].

Parental Pass screen appears.

### 2 Enter the parental code and touch [Enter].

Parental Level screen appears.

#### NOTE

- The parental code is set to "0000" as default.
- To cancel the setup and return to the previous screen, touch [Cancel].
- To clear the entered code, touch [Clear].
- Current parental level appears as [Level#].

### 3 Touch [◀] or [▶] to select a parental level.



#### NOTE

- If a disc has higher parental lock level, you need to enter the code number.
- The parental lock level varies depending on a loaded disc.
- If a disc has no parental lock, anybody can play it back even when you have set the parental lock.

## Disc setup

Performs setup when using disc media.

### 1 Touch [SET] of [DISC SETUP].

DISC SETUP screen appears.

### 2 Select an option as follows.



#### CD Read

Sets the motion of this unit when a music CD is played.

- 1 (Default): Automatically recognizes and plays back an audio file disc, a DVD or a music CD.
- 2: Forcibly plays back a disc as a music CD. Select [2] if you wish to play a music CD having a special format or if you cannot play a disc in [1] position.

#### On Screen DVD

Sets an on-screen display.

**Auto:** When updated, information appears for 5 seconds.

**OFF (Default):** Information does not appear.

#### NOTE

- [CD Read] is not available when a disc is in the unit.
- You cannot play an audio file/VCD disc in the [2] position. Also, you may not play some music CDs in the [2] position.



# CD/Audio and Visual Files/iPod/App Operation

## Music/Video/Picture Basic Operation

Most functions can be controlled from the source control screen and playback screen.

### NOTE

- Set the remote controller mode switch to AUD mode before starting operation, see [Switching the operation mode \(P.119\)](#).
- To connect the Android device with this unit, the cable (sold separately) and the profile which your Android device supports are necessary as follows:
  - To listen to music and watch video of APPS source
    - MHL device
    - KCA-MH100
    - Bluetooth profile: SPP
  - To listen to music of APPS source
    - Bluetooth profile: A2DP
    - Bluetooth profile: SPP
  - To listen to music of Bluetooth Audio source
    - Bluetooth profile: A2DP
    - Bluetooth profile: AVRCP
- To connect the iPod/iPhone with this unit, the cable, adapter (both sold separately), and the profile which your iPod/iPhone supports are necessary as follows:
  - To listen music and watch video with Lightning connector device
    - Lightning Digital AV Adapter
    - KCA-HD100
    - Lightning to USB Cable (accessory of the iPod/iPhone)
    - Bluetooth profile: SPP
  - To listen music with Lightning connector device
    - Lightning to USB Cable (accessory of the iPod/iPhone)
  - To listen music and watch video with 30-pin connector device (1)
    - Apple 30-pin Digital AV Adapter
    - KCA-HD100
    - KCA-iP102
    - Bluetooth profile: SPP
  - To listen music and watch video with 30-pin connector device (2)
    - KCA-iP202
  - To listen music with 30-pin connector device
    - KCA-iP102
  - To listen to music via Bluetooth
    - Bluetooth profile: A2DP
    - Bluetooth profile: SPP

When connecting with Lightning Digital AV Adapter or Apple 30-pin Digital AV Adapter some applications can be controlled from this unit. The operable functions depend on the application.

- Do not leave the cable or the adapter made by other makers inside the car. It might lead the malfunction caused by heat.
- Some settings are necessary to meet the connected iPod/iPhone or Android device. Refer to [iPod/iPhone connection setup \(P.54\)](#) and [Application link setup \(P.56\)](#).

See the following sections for each source operation.

- **Music CD** [\(P.33\)](#)
- **Disc media** [\(P.33\)](#)
- **USB device** [\(P.35\)](#)

- iPod ([P.35](#))
- Pandora ([P.45](#))
- iHeartRadio ([P.48](#))
- Apps ([P.51](#))

## Music CD and disc media

### NOTE

- In this manual, "Music CD" will be referred to as the general CDs which include music tracks in. "Disc media" will be referred to as CD/DVD disc which includes audio, picture or video files.
- The screen shot below is for CD. It may be different from the one for disc media.

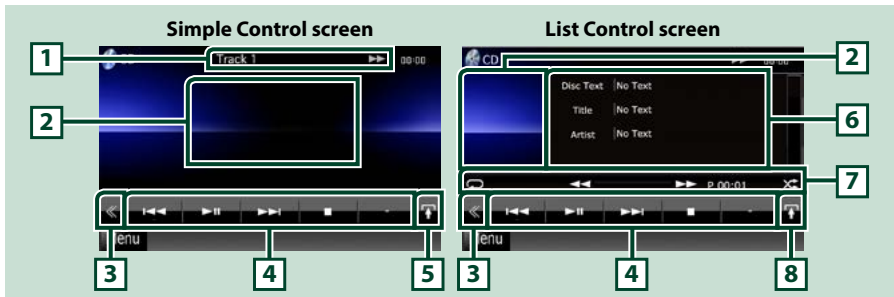

### 1 Information display

Displays the following information.

- **Track #:** Each time you touch this area, display switches between current track number, text, etc.
- **▶, ▶▶, ▶▶▶, ■, etc.:** Current play mode display  
The meanings of each icon are as follows; ▶ (play), ▶▶ (fast forward), ◀◀ (fast backward), ▶▶▶ (search up), ◀◀◀ (search down), ■ (stop), **R** (resume stop), || (pause).

### 2 Movie display area/Control switching area

Touch to switch between the Simple Control and List Control screen.

### 3 Multi function key

Touch to switch the multi function menu. For details on the menu, see [Multi function menu \(P.37\)](#).

### 4 Multi function menu

Various functions can be performed by using keys in this area. For details on the menu, see [Multi function menu \(P.37\)](#).

### 5 Sub function key

Touch to display "Sub function menu" (7 in this table).

### 6 Track information

Displays the information of the current track.

For music CD and disc media, you can switch the current track information and the current folder list by touching the list switching key (8 in this table).

However, only "No Information" is displayed for music CD.

### 7 Sub function menu

Various functions can be performed by using keys in this area. For details on the keys, see [Sub function menu \(P.38\)](#).

### 8 List switching key

Touch to switch between the track list and the CD-TEXT display (CD)/ID3 tag information (disc media only).

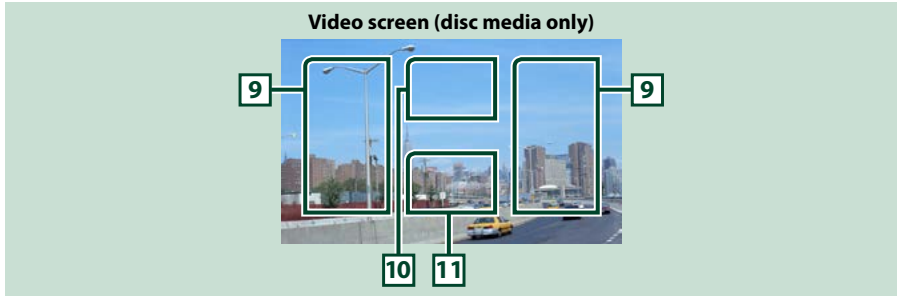

### 9 Searching file area (disc media only)

Touch to search the next/previous file.

Scrolling from center of display to left or right performs fast backward or fast forward. Each time you touch each area, the speed changes; standard, 2 times, 3 times. To stop fast backward/forward, touch center of the display.

### 10 Menu display area (disc media only)

Touch to display the disc menu. For details, see [Movie Control \(P.44\)](#).

### 11 Key display area (disc media only)

Touch to display the last control screen.

## USB device and iPod

### NOTE

- The screen shot below is for USB device. It may be different from the one for iPod.

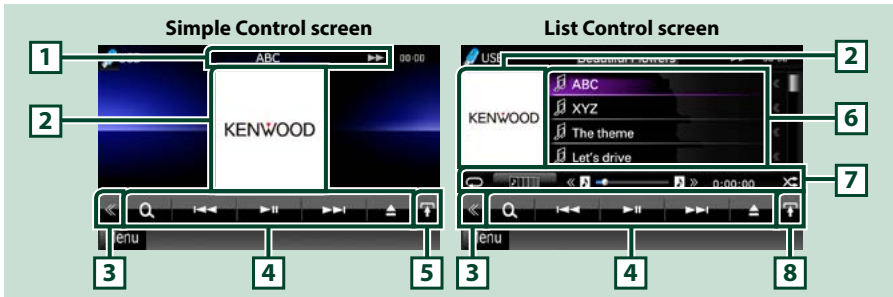

### 1 Information display

Displays the following information.

- **Current file name:** Each time you touch this area, display switches between file number/folder number and file name.
- **▶, ▶▶, etc.:** Current play mode display  
The meanings of each icon are as follows: ▶ (play, searching), || (pause), ▶▶ (forward manual search), ◀◀ (reverse manual search).

### 2 Artwork/Control switching area

The picture data is displayed if available from the current file. When the picture is not available, "No Photo" is displayed.

Touch to switch between the Simple Control and List Control screen.

### 3 Multi function key

Touch to switch the multi function menu. For details on the menu, see [Multi function menu \(P.37\)](#).

### 4 Multi function menu

Various functions can be performed by using keys in this area. For details on the keys, see [Multi function menu \(P.37\)](#).

### 5 Sub function key

Touch to display "Sub function menu" (7 in this table).

### 6 Contents list

Displays the list and contents. The contents of the list differ depending on the playback status and source.

When you select the video source on the device connected with the Lightning connector, the source is switched to Apps [\(P.51\)](#) automatically.

### 7 Sub function menu

Various functions can be performed by using keys in this area. For details on the keys, see [Sub function menu \(P.38\)](#).

### 8 List switching key

Touch to switch between the file list and the current file information.

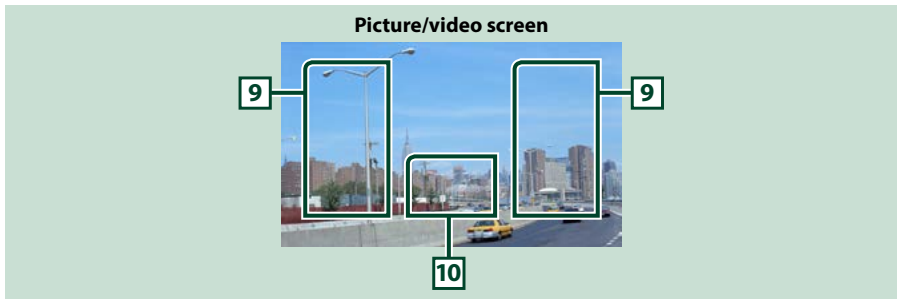

**9 Searching file area (picture/video file only)**

- Touch to search the next/previous file.
- During slide show in USB mode, touching each area searches the next/previous music file.
- Scrolling from center of display to left or right performs fast backward or fast forward. To stop fast backward/forward, touch center of the display. This function is not available when there is no music file in the current folder.

**10 Key display area (picture/video file only)**

Touch to display the last control screen.

## Multi function menu

### Music CD



### iPod



### Disc media



### USB device



The following functions can be performed by using keys in this area.

#### [ ] (Disc media, iPod, USB device only)

Searches track/file. For details on search operation, see [Search Operation \(P.39\)](#).

#### [ ] [ ]

Searches the previous/next track/file.

#### [ ] [ ] / [ ]

Plays or pauses.

#### [ ] (music CD and disc media only)

Stops playback.

#### [ ] (iPod and USB device only)

Touch to disconnect the device. For details, see [How to Play Media \(P.13\)](#).

#### [ ] [ ] (disc media and USB device only)

Searches previous/next folder.

#### [ ] (picture files in USB device only)

During picture playback, switches to picture display.

#### [ ] SETUP

Touch to display the SETUP Menu screen. See [Setting Up \(P.92\)](#).

#### [ ] AUDIO

Touch to display the Audio Control screen. See [Controlling Audio \(P.106\)](#).

#### [ ] EXT SW] (DNX891HD, DNX7710BT only)

Touch to control the external device power supply. For details, see [External Device Control \(P.104\)](#).

#### [ REAR ]

Touch to mute the rear speaker.



## Sub function menu

### Music CD



### iPod



### Disc media



### USB device



The following functions can be performed by using keys in this area.



Repeats the current track/folder. Each time you touch the key, repeat mode switches in the following sequence;

CD: "track repeat" "repeat off"

iPod: "song repeat" "all songs repeat" "repeat off"

Disc media, USB device: "file repeat" , "folder repeat" , "repeat off"



Searches track from the album artwork list. For details on search operation, see [Search from album artwork \(P.42\)](#).



Hides all keys.



Fast forward or fast backward.



Plays the previous or next album in [Favorite list \(P.43\)](#).



Confirms play time.

During music CD playback, you can also confirm disc remaining time by touching time display.

Each time you touch, the display switches between "P ###:##" (track play time display) and "R ###:##" (disc remaining time).



Randomly plays all tracks in current folder/disc or in current playlist in the connected iPod.

Each time you touch the key, random mode switches in the following sequence;

CD: "track random" "random off"

Disc media, USB device: "file random" "random off"

iPod: "track random" "album random" "random off"



Confirms the current location.

During USB device and iPod playback, you can drag the circle left or right to change the playing position.

## Search Operation

You can search music, video or picture files by the following operations.

### NOTE

- If you use a remote control, you can jump directly to the desired track/file with entering the track/folder/file number, play time, etc. For details, see [Direct search mode \(P.119\)](#).

## List search

You can search tracks, folders, and files according to hierarchy.

### 1 Touch illustrated area.



List Control screen appears.

### 2 Touch desired track/file.

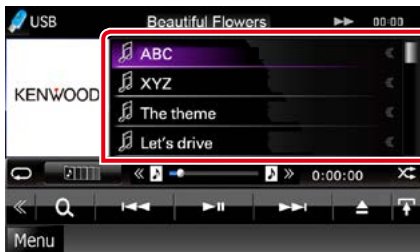

Playback starts.

### NOTE

- For disc media, you can switch the file list and folder list by touching [  ].
- For disc media, you cannot display the list during random play and stop.

## Other search

When you want to narrow the list down, there are other search ways.

This function is not available when music CD is the current source.

### 1 Touch [ ] in the control screen.

The search type screen appears.

### 2 Touch desired search way.

USB device

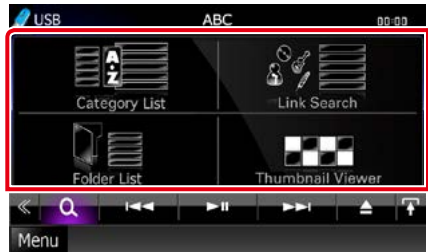

iPod

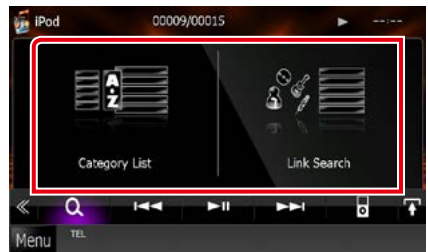

The list sorted in the way you selected appears.

See the following sections for each operation.

- [Category List]: You can search a file by selecting category ([P.40](#)).
- [Link Search]: You can search a file of same artist/album/genre/composer as the current track ([P.40](#)).
- [Folder List]: You can search a file according to hierarchy ([P.41](#)).
- [Thumbnail Viewer]: You can search a picture file ([P.41](#)).

### NOTE

- For disc media, you can display the folder list directly by touching [  ].

### Category search (USB device and iPod only)

**1** Touch the desired category from the left part of the screen.



**2** The list is sorted by selected category.

**3** Touch desired item.

Playback starts.

#### NOTE

- To narrow the search you can select a letter from the alphabet list in the center of the display.
- For operations in the list screen, see [Common Operations \(P.16\)](#).

### Link search (USB device and iPod only)

**1** Touch the desired item from the left part of the screen. You can select from artist, album, genre and composer.

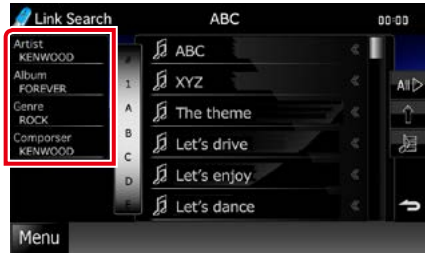

The list corresponding to your selection appears.

#### NOTE

- The list is sorted by the way you selected.
- **artist**: Displays the album list of the artist.
- **album**: Displays all tunes of the current album.
- **genre**: Displays the artists list in which artists belong to the same genre.
- **composer**: Displays the album list of the composer of the current file.

**2** Touch to select desired item in the list. Repeat this step until you find the desired file.

#### NOTE

- To narrow the search you can select a letter from the alphabet list in the center of the display.
- For operations in the list screen, see [Common Operations \(P.16\)](#).

## Folder search (USB device and disc media only)

### 1 Touch the desired folder.



Folders in the selected source are displayed in the center.

When you touch a folder its contents are displayed.

The hierarchy till the current folder is displayed on the left.

### 2 Touch desired item from the content list.

Playback starts.

#### NOTE

- For operations in the list screen, see [Common Operations \(P.16\)](#).

## Picture search (USB device only)

### 1 Touch the desired picture.

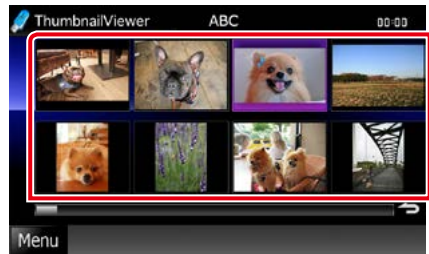

The selected picture appears in full screen. See number 9-10 in [USB device and iPod \(P.35\)](#) for operation of picture screen.

## Search from album artwork (USB device and iPod only)

You can search music files by selecting the album artwork.

### 1 Touch [ ].

Sub function menu appears.

### 2 Touch [ ].



Favorite screen appears.

### 3 Touch desired artwork in the lower line.



#### NOTE

- The key in the upper side of the screen functions differently depending on the status.

##### When [Load Albums] appears:

You have not yet loaded any artworks. Touch the key to start loading.

##### When [Load More Albums] appears:

Some artworks are not loaded. Touch the key to load all artworks. If you touch the key, the track being played may stop and another track may start playback.

##### When the key does not available:

All artworks are already loaded.

### 4 Touch [ ] on the selected artwork.

The first song in the album is played.

In addition, you can create your original playlist from this screen. For details, see [Favorite list \(P.43\)](#).

#### NOTE

- After all tracks in the album are played, the same album is played again from the first track.
- The albums with no photo are not displayed.

### **Favorite list**

You can create an original playlist of your favorite 10 albums by selecting album artworks.

#### **1 Touch and drag the desired album artwork in the lower line to the upper line.**



Selected album is registered to the favorite list.

#### **NOTE**

- The added album is placed on the extreme right.
- You cannot register the same album already registered to the favorite list.
- Up to 10 albums can be registered to the list.

#### **2 Touch the desired artwork in the favorite list.**

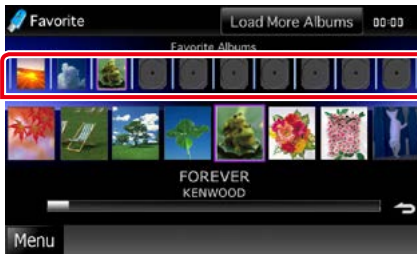

Selected album is played and the control screen appears.

#### **NOTE**

- The favorite list is played to the right starting with the selected album.
- To delete the album from the favorite list, touch and drag it to the lower line.
- You can change the playing order of the favorite list by dragging the artwork in the list.
- The favorite list mode is canceled in the following situations.
  - Playing another album from other list (folder list, category list, etc.)
  - Playing another album by touching the artwork in the lower line in the artwork list screen.
- The favorite list mode resumes after disconnecting/connecting the device or turning on/off. File being played, playing time code, favorite list contents, favorite list order, etc. resumes if file configuration of the device is not changed.

## Movie Control

You can adjust the movie playback from a disc media.

- 1 In the playback screen, touch illustrated area.**



Movie Control screen appears.

- 2 Perform desired operation as follows.**



### Changes subtitle language

Touch [Subtitle].

### Changes audio language

Touch [Audio].

### Exits the menu

Touch [Exit].

## Pandora® Operation

You can listen to the Pandora® on this unit by controlling the application installed in the iPhone or Bluetooth device.

To enter Pandora mode, touch [Pandora] icon in the Top Menu screen.

### NOTE

- Install the latest version of the Pandora® application on your iPhone, Android or BlackBerry.  
**iPhone:** Search for "Pandora" in the Apple App Store to find and install the most current version.  
**Android:** Visit the Google play and search for Pandora to install.  
**BlackBerry:** Visit [www.pandora.com](http://www.pandora.com) from the built in browser to download the Pandora application.
- When you first select Pandora as a source, the setting screen for the connection with the device installed the apps will appear. For the details, refer to [Application link setup \(P.56\)](#).

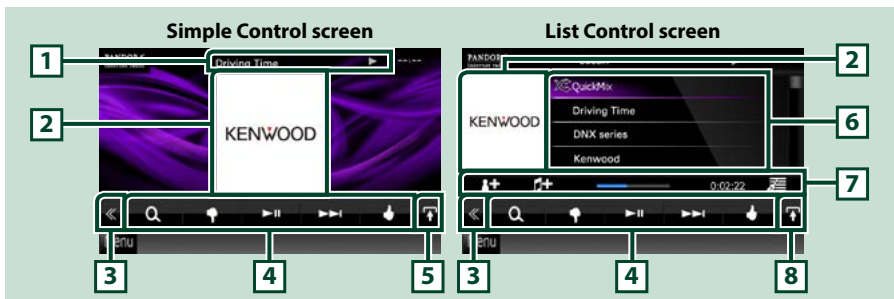

### 1 Information display

Displays text information of current contents that is being played.

### 2 Artwork/Control switching area

The picture data is displayed if available from current content.  
Touch to switch between the Simple Control and List Control screen.

### 3 Multi function key

Touch to switch the multi function menu. For details on the menu, see [Multi function menu \(P.46\)](#).

### 4 Multi function menu

Various functions can be performed by using the keys in this area. For details on the keys, see [Multi function menu \(P.46\)](#).

### 5 Sub function key

Touch to display "Sub function menu" (7 in this table).

### 6 Content information

Displays the information of the current content being played.

### 7 Sub function menu

Various functions can be performed by using keys in this area. For details on the keys, see [Sub function menu \(P.46\)](#).

### 8 List switching key

Touch to switch between the content list and the current content information.



## Multi function menu



The following functions can be performed by using keys in this area.



Searches for a station. For details on searching, see [Station list screen \(P.47\)](#).



**(Thumbs down)**

Thumbs down to the current song and skip to the next song.



Plays or pauses the content of the current station.



Skips the current song.

(Note this function is disabled when the Pandora skip limitation is exceeded.)



**(Thumbs up)**

Registers the current contents as favorite content.



**(Bookmark Artist)**

Bookmark an artist in the current contents.



**(Bookmark Song)**

Bookmark a song in the current contents.

### NOTE

- [SETUP], [AUDIO], [EXT SW], and [REAR] functions same as iPod.

## Sub function menu



The following functions can be performed by using keys in this area.

### Status bar in center

Displays the elapsed time since when you select the station and status bar which shows current location.



Creates a new station based on an artist being played.



Creates a new station based on a song being played.



Displays the genre list screen. For details on searching, see [Genre list screen \(P.47\)](#).

## Station list screen

You can perform the following functions from this screen.



### Selects the station

Touch the station name in the list.

### Sort the list in alphabetical order

You can select the desired letter from the list which corresponds to the station name to help narrow the search.

### Sort the list by registered date

Touch [ByDate]. The list is sorted to begin with the last registered station.

#### NOTE

- You can operate Pandora by using the remote control. However, only playing, pausing, and skipping are available.
- You cannot select iPod as rear source when you select Pandora as main source in dual zone function.

## Genre list screen

You can perform the following functions from this screen.



The selected genre is created as a new station.

## iHeartRadio Operation

You can listen to the iHeartRadio on this unit by controlling the application installed in the iPhone or Android.

To enter iHeartRadio mode, touch [iHeartRadio] icon in the Top Menu screen.

### NOTE

- Install the latest version of the iHeartRadio application "iHeartAuto" on your iPhone or Android.  
**iPhone:** Search for "iHeartAuto" in the Apple App Store to find and install the most current version.  
**Android:** Search for "iHeartAuto" in Google play to find and install the most current version.
- When you first select iHeartRadio as a source, the setting screen for the connection with the device installed the apps will appear. For the details, refer to [Application link setup \(P.56\)](#).

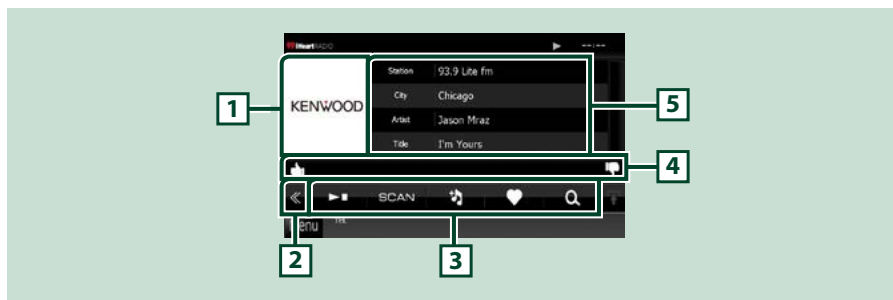

### 1 Artwork switching area

The picture data is displayed if available from current content. When the picture is not available, "No Photo" is displayed.

### 2 Multi function key

Touch to switch the multi function menu. For details on the menu, see [Multi function menu \(P.49\)](#).

### 3 Multi function menu

Various functions can be performed by using the keys in this area. For details on the keys, see [Multi function menu \(P.49\)](#).

### 4 Sub function menu

The following functions can be performed by using keys in this area.

- Thumbs up to the current song: Touch [👍].
- Thumbs down to the current song: . Touch [👎].

### 5 Content information

Displays the information of the current content being played.

## Multi function menu



The following functions can be performed by using keys in this area.



Stops or pauses. (Live station only)



Plays or pauses. (Custom station only)



Skips the current song. (Custom station only)



Scans for another station of the same genre. (Live station only)



Creates a custom station based on the current song.



Searches for a station. For details on searching, see [Station search \(P.49\)](#).



Saves currently playing station to My Stations. (Live station only)



Use the Discovery Tuner to set the variety level of a station. For details, see [Discovery tuner \(P.50\)](#). (Custom station only)

## Station search

You can list and select station.

### 1 Touch [ ] in the control screen.

The Station Search screen appears.



### Selects the category and station

Touch the category and station name in the list.



Returns to the first hierarchy of the category list.



Returns to the previous category list.



Deletes a saved station from My Stations. For details, see [My stations edit \(P.50\)](#).

## My stations edit

1 Touch [  ] in the Station Search screen.

Station Edit screen appears.

2 Select the station to delete from My stations.



### Selects the station

Touch to check the station name you want to delete.

You can uncheck if you touch it again.



Returns to the first hierarchy of the category list.



Returns to the previous category list.

3 Touch [  ].

Station Delete screen appears.

4 Touch [Yes].



My station selected is deleted.

## Discovery tuner

You can set the variety level in a custom station.

1 Touch [  ] in the control screen.

The Discovery tuner select screen appears.



### Selects the variety

Touch the variety you want to set.

## Apps Operation

You can listen to music or watch video from the Apps operating on iPod touch/iPhone or Android. To enter Apps mode, touch [APPS] icon in the Top Menu screen.

### NOTE

- When you turn on the power and select apps as the source, the caution for the operation, watching video and listening music appears. With your acceptance, you can control apps, listen to music and watch video from apps when you are driving.



- When you first select APPS as a source, the setting screen for the connection with the device installed the apps will appear. For the details, refer to [Application link setup \(P.56\)](#).

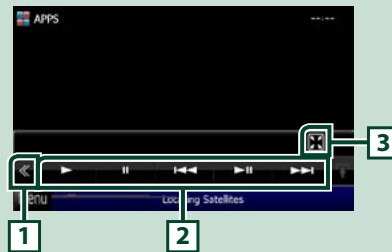

### 1 Multi function key (iPod touch/iPhone only)

Touch to switch the multi function menu.

### 2 Multi function menu (iPod touch/iPhone only)

The following functions can be performed by using keys in this area.

- Plays or pauses: Touch [▶], [⏸], or [▶⏸] (iPod only).
- Searches the previous/next track/file: Touch [◀◀] or [▶▶].
- Fast forward or fast backward (iPod only): Touch [◀◀] or [▶▶].

### 3 Sub function menu (iPod touch/iPhone only)

The following functions can be performed by using keys in this area.

- Hides all keys (During video file playback only): Touch [⏏]

### NOTE

- The operable functions depend on the application.

## USB/iPod/DivX Setup

You can perform setup when using USB/ iPod/ DivX (DNX891HD/ DNX7710BT/ DNX5710BT).

### NOTE

- Each operation in this section can be started from the Top Menu screen. For details, see [Operating with the Top Menu Screen \(P.14\)](#).
- Some setup items can only be set in standby mode.

**1 Touch [ ] in the control screen.**  
Multi function menu appears.

**2 Touch [SETUP].**  
SETUP Menu screen appears.

**3 Touch [Source].**

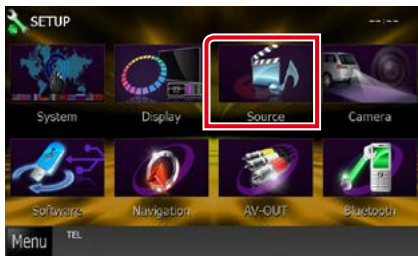

Source SETUP Menu screen appears.

**4 Touch [USB SETUP], [iPod SETUP], [APPS SETUP], or [DivX SETUP] in the list.**  
Each setup screen appears.  
See the following section for each setting.

- [USB setup \(P.52\)](#)
- [iPod setup \(P.53\)](#)
- [AppsApplication link setup \(P.56\)](#)
- [DivX\(R\) VOD \(P.57\)](#)

## USB setup

**1 Set each item as follows.**



### Picture Display Time

Selects length of time to display JPEG picture file in the screen. Select from [Short], [Middle], and [Long] (default).

### On Screen USB

Sets how to display the information of the USB device.

**Auto (Default):** Information appears for 5 seconds when updated.

**OFF:** Does not display any information.

## iPod setup

### 1 Set each item as follows.



#### AudioBook Speed

Sets the audio book playback speed. Select from [Slow], [Normal] (default), and [Fast].

#### Wide Screen\*

Sets Wide Screen. Set [ON] (default) or [OFF].

#### On Screen iPod

Sets how to display the information of the iPod.

**Auto (Default):** Information appears for 5 seconds when updated.

**OFF:** Does not display any information.

#### iPod connection setup

Sets the way to connect the iPod/iPhone with this unit. For details on searching, see [iPod/iPhone connection setup \(P.54\)](#).

\* This setting is not available when an iPod is connected.



## iPod/iPhone connection setup

- 1 Touch [iPod Connection Setup] in the iPod Settings screen.**  
iPod connection setup screen appears.

- 2 Touch [CHANGE].**



- 3 Select the way to connect the iPod/iPhone with this unit.**



### USB + AV-IN

Select when connecting with KCA-iP202.

### USB 1Wire

Select when connecting with KCA-iP102/  
Lightning to USB Cable.

### HDMI + BT

Select when connecting with KCA-HD100 and  
Lightning Digital AV Adapter or Apple 30-pin  
Digital AV Adapter.

### Bluetooth

Select when connecting via Bluetooth only.

- 4 Touch [Next].**

Confirmation screen appears.

- 5 Touch [Done].**

## NOTE

- For the details of the necessary cable and adapter to connect with iPod/iPhone, refer to [Music/Video/Picture Basic Operation \(P.32\)](#).
- When you select "HDMI + BT" or "Bluetooth" in step 3, Bluetooth device selection screen will appear. Select the iPod/iPhone to be connected.



If a connectable Bluetooth device is not displayed, touch [Search] and do the pairing of the devices.



## Application link setup

Sets the device an application is installed in and the app is selected as the source.

### 1 Touch [CHANGE].



### 2 Select the device installed the apps.



#### iPod / iPhone

Select when using iPod/iPhone.

#### Android / Other

Select when using Android or BlackBerry device.

### 3 Touch [Next].

Connection setup screen appears.

### 4 Select the way to connect the device with this unit.

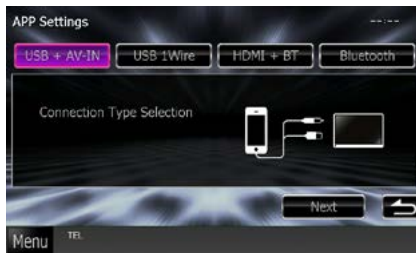

#### When selecting [iPod / iPhone]

##### USB + AV-IN

Select when connecting with KCA-IP202.

##### USB 1Wire

Select when connecting with KCA-IP102/ Lightning to USB Cable.

##### HDMI + BT

Select when connecting with KCA-HD100 and Lightning Digital AV Adapter or Apple 30-pin Digital AV Adapter.

##### Bluetooth

Select when connecting via Bluetooth only.

#### When selecting [Android / Other]

##### HDMI/MHL + BT

Select when connecting with KCA-MH100.

##### Bluetooth

Select when connecting via Bluetooth only.

### 5 Touch [Next].

Confirmation screen appears.

### 6 Touch [Done].

#### NOTE

- This setup can be set when in STANDBY source.
- For the details of the necessary cable and adapter to connect with iPod/iPhone and Android, refer to [Music/Video/Picture Basic Operation \(P.32\)](#).
- When you select "HDMI + BT", "HDMI/MHL + BT" or "Bluetooth" in step 4, Bluetooth device selection screen will appear. Select the device to be connected.



If a connectable Bluetooth device is not displayed, touch [Search] and do the pairing of the devices.

- When you select "iPod/ iPhone" in Apps Setup, select "iPod" as the source, and select App on the iPod, the source of this unit is also changed to App automatically.

## DivX(R) VOD (DNX891HD/ DNX7710BT/ DNX5710BT)

This feature is available only for Central and South America sales area.

### 1 Set each item as follows.



#### DivX(R) Registration Code

Checks the registration code. This code is needed when making a disc which has DRM (Digital Rights Management).

#### DivX(R) Deactivation

Deregisters the unit which is already registered. After you touch the key, a confirmation message appears. Follow the message and complete the operation.

#### NOTE

- [DivX(R) VOD] is disabled when a disc is being played.
- When downloading a DivX VOD file controlled by DRM, register the code appeared on the screen. Otherwise the file may not be able to play with this unit. Remaining number of viewing is displayed when playing a DivX VOD file with the viewing restriction. When the used number of viewing reached maximum number, a warning message appears and the file cannot be played.

# Radio and HD Radio™ Tuner Operation

## Radio/HD Radio Tuner Basic Operation

Most functions can be controlled from the source control screen.

### NOTE

- Set the remote control mode switch to AUD mode before starting operation, see [Switching the operation mode \(P.119\)](#).
- HD Radio broadcasting can be received only by the DNX891HD, DNX771HD, DNX691HD, DNX571HD, and DNX571EX.
- HD Radio broadcasting is for North American sales area only.
- The screen shot below is for tuner. It may be different from the one for HD Radio broadcasting.

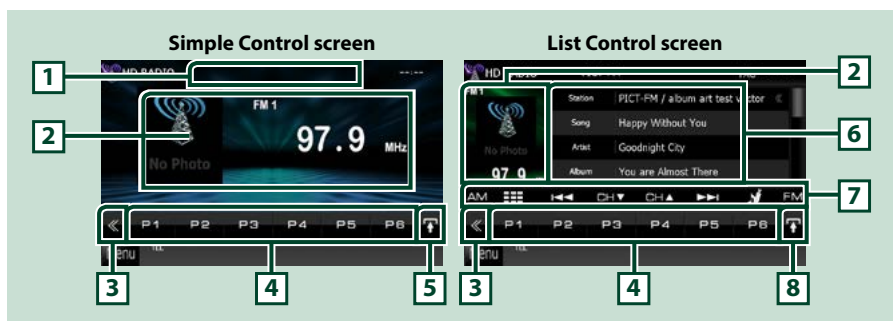

### 1 PS/Station name display

Displays the PS name or station name.

### 2 Information display/Control switching area

Displays the following information.

- **Picture:** The picture data or station Logo data is displayed if available from current content.
- **[FM1] etc.:** Band display
- **MHz/kHz:** Frequency display
- **Preset #:** Preset number
- **HD# (HD Radio tuner only):** Channel display

Touch to switch between the Simple Control and List Control screen.

### 3 Multi function key

Touch to switch the multi function menu. For details on the menu, see [Multi function menu \(P.59\)](#).

### 4 Preset key/Multi function menu

Recalls the memorized station or channel. When touched for 2 seconds, stores the current receiving station or channel in memory.

When switched, various functions can be performed by using keys in this area.

For details on the menu, see [Multi function menu \(P.59\)](#).

### 5 Sub function key

Touch to display "Sub function menu" (7 in this table).

## 6 Preset list

Displays the list of preset stations or channels and the information.

## 7 Sub function menu

The following functions can be performed by using keys in this area.

- **Switches the band:** Touch [AM] or [FM].
- **Tunes in a station:** Touch [◀◀] [▶▶]. The method of frequency switching can be changed. See [Multi function menu \(P.59\)](#).
- **Selects a channel (HD Radio tuner only):** Touch [CH▼] or [CH▲].
- **Stores the information about the song being received:** Touch [📌]. See [Bookmark \(P.65\)](#).
- **Tunes in by entering direct number (HD Radio tuner only):**  
Touch [🔢] and enter the desired number. For details, see [Direct search \(P.63\)](#).  
The bar in center (tuner only) shows the current frequency location.

## 8 List switching key

Touch to switch between the preset list and the information list.

In tuner mode, radio text plus will be displayed.

In HD Radio tuner mode, tuned program information will be displayed.

## Multi function menu

### Tuner



### HD Radio tuner



The functions of each key are as follows.

### [P1] - [P6]

Selects the preset station. Touch for 2 seconds to store the current station into the preset memory.

### [🔍]

Selects the method of searching from preset stations selecting or channel searching. For details on search operation, see [Selecting Operation \(P.62\)](#).

### [TI] (FM Tuner and HD Radio tuner only)

Sets the traffic information mode on. For details, see [Traffic Information \(P.64\)](#).

### [SEEK]

Switches the seek mode in the following sequence; [AUTO1], [AUTO2], [MANUAL].

- **AUTO1:** Tunes in a station with good reception automatically.
- **AUTO2:** Tunes in stations in memory one after another.
- **MANUAL:** Switches to the next frequency manually.

### [AME]

Selects the auto memory mode. For details, see [Auto memory \(P.61\)](#).

### [PTY] (FM Tuner and HD Radio tuner only)

Searches a program by setting program type. For details, see [Search by program type \(P.62\)](#).

### [RCV] (HD Radio tuner only)

Switches the receive mode in the following sequence; [AUTO], [DIGITAL], [ANALOG]. For details, see [Receive Mode \(P.64\)](#).

**Continued**

[  **SETUP** ]

Touch to display the SETUP Menu screen. See [Setting Up \(P.92\)](#).

[  **AUDIO** ]

Touch to display the Audio Control screen. See [Controlling Audio \(P.106\)](#).

[  **EXT SW** ] (DNX891HD, DNX7710BT only)

Touch to control the external device power supply. For details, see [External Device Control \(P.104\)](#).

[ **REAR**  ]

Touch to mute the rear speaker.

## **Radio**<sup>®</sup>

This HD Radio receiver enables:

**PSD** 

**HD2/HD3** 

**Bookmark** 

**Digital Sound** 

**Artist Experience** 

### **PSD**

- Program Service Data provides song name, artist, station ID, and other relevant data streams

### **HD2/HD3**

- Adjacent to traditional main stations are HD2/HD3 Channels, providing new original formats on the FM dial

### **Bookmark**

- Bookmark is a music & product discovery feature that enables users to store information about content on the radio and delivers interactive information via QR codes

### **Digital Sound**

- HD Radio broadcasts deliver crystal clear, CD-like digital audio quality to consumers

### **Artist Experience**

- Visual images, such as album art of over-the-air broadcasts from HD Radio stations

## Memory Operation

### Auto memory

You can store stations with good reception in memory automatically.

#### NOTE

- Auto memory terminates when 6 stations are stored or when all stations are tuned in.
- The operation ends automatically if you do not operate within 10 seconds.

#### 1 Touch [ ].

Sub function menu appears.

#### 2 Touch desired band key.



#### 3 Touch [ ] in the control screen.

The multi function menu appears.

#### 4 Touch [AME] in the multi function menu.

#### 5 Touch [ ] or [ ] in the sub function menu.

Auto memory starts.

### Manual memory

You can store the current receiving station or channel in memory.

#### 1 Select a station or channel you wish to store in memory.

#### 2 Touch [P#] (#:1-6) in which you want to store the station or channel for 2 seconds until a beep sounds.



## Selecting Operation

### Preset select

You can list and select memorized station or channel.

#### Selecting from the multi function menu

- 1 Touch the desired number from P1 to P6.

The unit will tune to the selected station or channel.

#### Selecting from the preset list

- 1 Touch illustrated area.

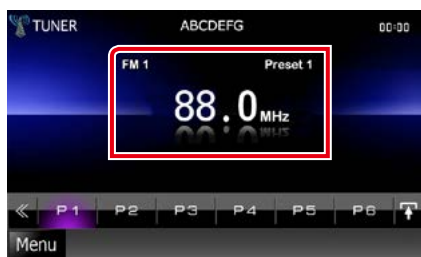

List Control screen appears.

- 2 Select a station or channel from the list.

#### NOTE

- For HD Radio tuner, touching [Q] and then [Preset List] displays the preset channel list. You can also select your desired channel from the list.

### Search by program type (FM tuner and HD Radio tuner only)

You can tune to a station with a specific program type when listening to FM.

- 1 Touch [◀◀] in the control screen.  
The multi function menu appears.
- 2 Touch [PTY] in the multi function menu.  
TUNER PTY Mode screen appears.
- 3 Select a program type from the list.
- 4 Touch [Search].



You can search a station of the selected program type.

## Direct search (HD Radio tuner only)

You can tune in by entering the desired frequency or channel number.

### 1 Touch illustrated area.



List Control screen appears.

### 2 Touch [ ].

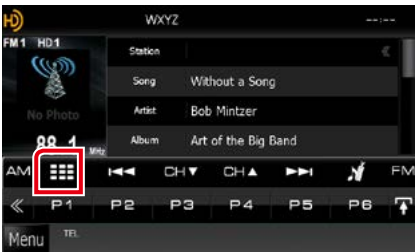

10Key Direct screen appears.

### 3 Enter the channel number and touch [Enter].

#### NOTE

- To cancel the direct search, touch [Cancel].
- To clear the number you entered, touch [Clear].
- You can search by frequency. Each time you touch [Mode] in the left part of the screen, it changes the mode between frequency entering mode and channel entering mode.

## Category/Channel search (HD Radio tuner only)

You can specify the desired category and select a channel.

### 1 Touch [ ] in the control screen.

The multi function menu appears.

### 2 Touch [ ] in the multi function menu.

List select screen appears.

### 3 Touch [Preset list] or [Category/Channel list].



The previously used category or channel list appears.

### 4 Select the desired content from the list.

#### NOTE

- Each time you touch [Info Change] in the channel list, switches the sequence of the list.  
Song title, artist name, album name

## Traffic Information (HD Radio tuner only)

You can listen and watch the traffic information automatically when a traffic bulletin starts.

However, this feature requires a Radio Broadcast Data System that includes the TI information.

**1 Touch [ <<< ] in the control screen.**

The multi function menu appears.

**2 Touch [TI] in the multi function menu.**

Traffic information mode is set.

### When the traffic bulletin starts

The Traffic Information screen appears automatically.



#### NOTE

- It is necessary to have Traffic Information function set to on in order to have the Traffic Information screen appear automatically.
- The volume setting during reception of traffic information is automatically stored. The next time the traffic information is received, this unit recalls the volume setting automatically.

## Receive Mode (HD Radio tuner only)

You can set the radio broadcasts receive mode.

**1 Touch [ <<< ] in the control screen.**

The multi function menu appears.

**2 Touch [RCV] in the multi function menu.**

HD Radio tuner Mode screen appears.

**3 Select the receive mode from [Auto], [Digital], and [Analog] using [ < ] and [ > ].**



#### NOTE



- If you select [Auto], tunes to analog broadcast automatically when there is no digital broadcast.

## Bookmark (HD Radio tuner only)

Stores tag information (title, artist, album, URL, and description) about the song you are listening to now.

Detailed information and QR codes can be displayed according to the stored tag information.

### Registering a bookmark



- 1 Touch [  ].  
Sub function menu appears.
- 2 Touch [  ].  
Registers a bookmark.

#### NOTE

- Up to 100 bookmarks can be registered to this unit.

### Bookmark list

Displaying a list of registered bookmarks and detailed information and QR code of the song.

- 1 Touch [  ] in the control screen.  
The multi function menu appears.
- 2 Touch [  ] in the multi function menu.  
List select screen appears.
- 3 Touch [Bookmark].



The Bookmark List appears.

- 4 Select the desired bookmark from the list.





The bookmark information appears.



Deletes the bookmarks being displayed.

## Bookmark delete

Deleting a bookmark.

- 1 Touch [  ] in the control screen.**  
The multi function menu appears.
- 2 Touch [  ] in the multi function menu.**  
List select screen appears.
- 3 Touch [Bookmark].**



The Bookmark List appears.

- 4 Touch [Delete List].**

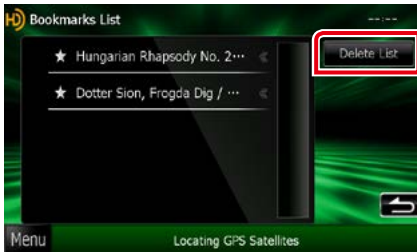

The Bookmark Delete List appears.

- 5 Select the bookmark to delete from the list.**

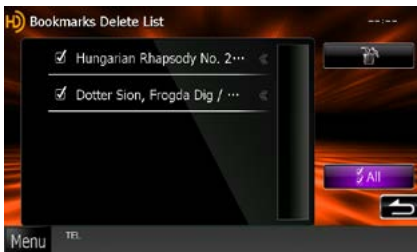

### [All]

Select all bookmarks.

- 6 Touch [  ].**  
Deletes all the selected bookmark(s)



# SiriusXM® Operation

## SiriusXM® Basic Operation

Most functions can be controlled from the source control screen.

### Before use

- SiriusXM® Satellite Radio operation requires the connection of the optional SiriusXM Connect Vehicle Tuner and service. To activate the SiriusXM Connect Vehicle Tuner, you will need the Radio ID.
- **Make a note of your Radio ID:** For each SiriusXM Connect Vehicle Tuner, peculiar Radio ID is assigned. To confirm your Radio ID, tune to channel 0. The letters I, O, S and F are not used in any Radio ID. The Radio ID is also located on the label of the SiriusXM Connect Vehicle Tuner.
- **How to activate your SiriusXM Service:** Go to [www.siriusxm.com/activatenow](http://www.siriusxm.com/activatenow) or call 1-866-635-2349 to activate your SiriusXM Vehicle Connect Tuner. To activate SiriusXM Canada service go to [www.xmradio.ca](http://www.xmradio.ca) and click on "ACTIVATE RADIO" in the top right corner, or call 1-877-438-9677

### NOTE

- Set the remote control mode switch to AUD mode before starting operation, see [Switching the operation mode \(P.119\)](#).
- To use SiriusXM® Satellite Radio, the optional accessory is necessary.
- SiriusXM® Satellite Radio are for North American sales area only.

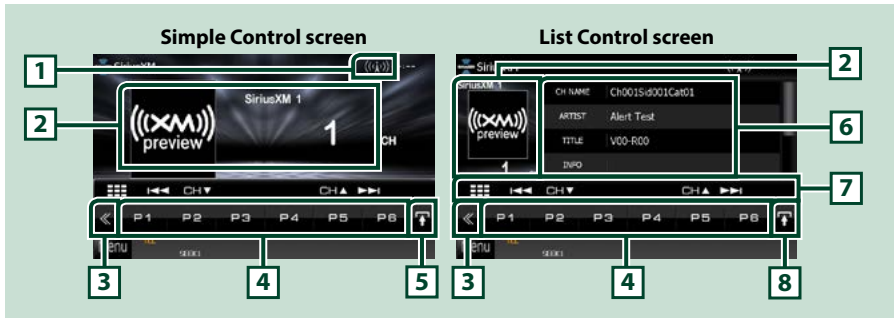

### 1 Signal Strength indication

Displays the received signal strength of the SiriusXM tuner.

### 2 Information display/Control switching area

Displays the following information.

- [SXM1], etc.: Band display
- Preset #: Preset number
- #CH: Channel display
- Logo: Channel logo display

Touch to switch between the Simple Control and List Control screen.

### 3 Multi function key

Touch to switch the multi function menu. For details on the menu, see [Multi function menu \(P.69\)](#).

#### 4 Preset key/Multi function menu

Recalls the memorized channel. When touched for 2 seconds, store the current receiving channel in memory.

When switched, various functions can be performed by using keys in this area.

For details on the menu, see [Multi function menu \(P.69\)](#).

#### 5 Sub function key

Touch to display "Sub function menu" (7 in this table).

#### 6 Music information

Displays the information of the current channel: Channel Name, Artist Name, Song Title, Content Info, Category Name, Channel Description, Similar Channels

#### 7 Sub function menu

The following functions can be performed by using keys in this area.

- **Tunes in a station:** Touch [CH▼] [CH▲].
- **Searches the previous/next track:** Touch [◀◀] [▶▶], fast forward/fast backward when keep on touching. see [SiriusXM Replay™ \(P.74\)](#).
- **Tunes in by entering direct number:** Touch [ ] and enter the desired number. For details, see [Direct search \(P.72\)](#).

#### 8 List switching key

Touch to switch between the preset list and the information list.

### Multi function menu



The functions of each key are as follows.

#### [P1] - [P6]

Selects the preset channel. Touch for 2 seconds to store the current station into the preset memory.



Selects the method of searching from preset channel selecting or category/channel searching. For details on search operation, see [Selecting Operation \(P.71\)](#).

#### [SEEK]

Switches the seek mode in the following sequence; [SEEK1], [SEEK2].

- **SEEK1:** Tunes channels one after the other.
- **SEEK2:** Selects channels in preset (memory) one after the other.

#### [BAND]

Switches the band.

#### [▶ II]

Plays or pauses. see [SiriusXM Replay™ \(P.74\)](#).



Touch for 2 seconds to register content as Alert content.

- [🔔]: Registers the artist of the song you are listening to now as an alert content.
- [🎵]: Registers the song you are listening to now as an alert content.

For details, see [Content alert \(P.73\)](#).

**Continued**





Turns the Traffic & Weather Jump function on or off.  
For details, see [City select for Traffic & Weather Jump \(P.79\)](#).



Listen to live.

**[TuneScan]**

Plays samples from the starts of multiple buffered songs from each of the Smart Favorite channels that predominantly play music selections. See [TuneScan™ \(P.75\)](#).



**SETUP]**

Touch to display the SETUP Menu screen. See [Setting Up \(P.92\)](#).



**AUDIO]**

Touch to display the Audio Control screen. See [Controlling Audio \(P.106\)](#).



**EXT SW] (DNX891HD only)**

Touch to control the external device power supply. For details, see [External Device Control \(P.104\)](#).



**REAR**

Touch to mute the rear speaker.

## Memory Operation

### Manual memory

You can store the current receiving station or channel in memory.

- 1 Select a station or channel you wish to store in memory.
- 2 Touch [P#] (#:1-6) in which you want to store the station or channel for 2 seconds until a beep sounds.

## Selecting Operation

### Preset select

You can list and select memorized station or channel.

#### Selecting from the multi function menu

- 1 Touch the desired number from P1 to P6.

The unit will tune to the selected station or channel.

#### Selecting from the preset list

- 1 Touch illustrated area.



List Control screen appears.

- 2 Select a station or channel from the list.

#### NOTE

- For SiriusXM tuner, touching [Q] and then [Preset List] displays the preset channel list. You can also select your desired channel from the list.

## Direct search

You can tune in by entering the desired frequency or channel number.

### 1 Touch illustrated area.



List Control screen appears.

### 2 Touch [List Control].

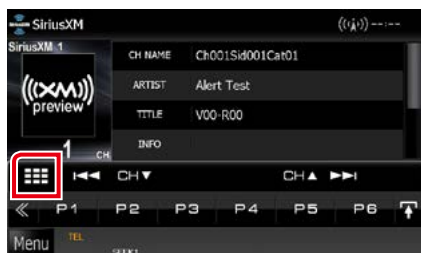

10Key Direct screen appears.

### 3 Enter the channel number and touch [Enter].

#### NOTE

- To cancel the direct search, touch [Cancel].
- To clear the number you entered, touch [Clear].

## Category/Channel search

You can specify the desired category and select a channel.

### 1 Touch [Category/Channel list].

The multi function menu appears.

### 2 Touch [Search].

List select screen appears.

### 3 Touch [Category/ Channel list].

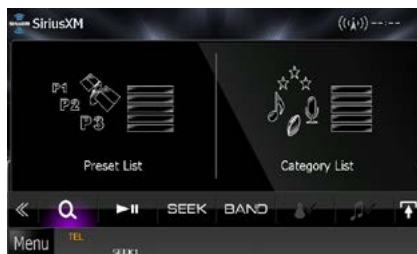

The previously used category or channel list appears.

### 4 Select the desired content from the list.

#### NOTE

- All the channels in the selected category appear.
- Touching [All Channels] displays all the channels.
- Each time you touch [Info Change] in the channel list, switches the sequence of the list.
  - Channel name, artist name, song title, category name, content info

## Content alert

When a broadcast program related to the registered artist, song or team starts, a message appears to allow you to switch the current channel to the relevant channel.

### 1 When the broadcast of the registered content starts, an Alert screen appears.

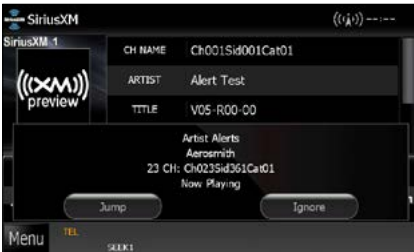

#### Jump

Touch to display the Alert Content List screen.

#### Ignore

Touch to cancel the Content alert.

### 2 Select a content from the list.



#### NOTE

- Each time you touched [Type], switches the sequence of the Content alert list as follows; Artist Alert, Song Alert, GameAlert™
- For how to register artists and songs and turn on/off the Team alert function, see [Multi function menu \(P.69\)](#).
- For how to set up the Content alert function, see [SiriusXM Setup \(P.76\)](#).

## SiriusXM Replay™

You can replay last 60 minutes of current channel.

### 1 Touch [SiriusXM] in the Top Menu.

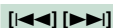

Searches the previous/next track. Fast forward/fast backward when keep on touching.



Plays or pauses.



Tunes in a station.

### Replay time bar

Display recorded capacity and playback position.



Listen to live.



Displays a list of recorded data on a program basis.

### [BAND]

Switches the band.

### 2 Touch [Q] to display a program list.



### Program list

Touching this plays back the displayed program.

### [Info Change]

Touching this allows you to switch among the Artist name, Song title, Category name, and Content info cyclically.

## Smart Favorites, TuneStart™

Station memory number 1 through 6 of current band are Smart Favorite channels. SiriusXM Vehicle Tuner automatically buffered the broadcast audio content of the Smart Favorites channels in the background.

You can rewind and replay up to 30 minutes of any of the missed news, talk, sports or music content when you tune to a Smart Favorite channel. (see [SiriusXM Replay™ \(P.74\)](#))

When tuning Smart Favorites channels, songs will play from the beginning of each track (Tune Start). You can enable/disable Tune Start. (see [TuneStart™ \(P.80\)](#))

## TuneScan™

TuneScan™ is a feature that plays samples from the starts of multiple buffered songs from each of the Smart Favorite channels that predominantly play music selections. You have easy access to a large sampling of music content and can enjoy hearing a full song when stopping the scan on a song of interest.

- 1 Touch [◀] in the control screen.**  
The multi function menu appears.
- 2 Touch [TuneScan] in the multi function menu.**  
The introductions of the songs will be played in recorded order.
- 3 Touch [TuneScan] while your favorite song is being played.**



Scan finishes and continues playing the song.

### NOTE

- To cancel Tune Scan, Touch [TuneScan] for 2 seconds.  
After cancel, the channel before starting Tune Scan will be played.

## SiriusXM Setup

### NOTE

- Each operation in this section can be started from the Top Menu screen. For details, see [Operating with the Top Menu Screen \(P.14\)](#).

- 1 Touch [  ] in the control screen.**  
Multi function menu appears.
- 2 Touch [SETUP] in the multi function menu.**  
SETUP Menu screen appears.
- 3 Touch [Source].**

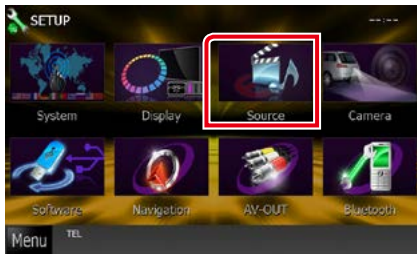

Source SETUP Menu screen appears.

- 4 Touch [SiriusXM SETUP] in the list.**  
SiriusXM SETUP screen appears.  
See the following section for each setting.
  - **Set up the parental code** [\(P.76\)](#)
  - **Set up the parental control** [\(P.77\)](#)
  - **Set up the skip channel select** [\(P.78\)](#)
  - **Set up the Content alerts** [\(P.78\)](#)
  - **Set up the content for Content alerts** [\(P.79\)](#)
  - **Select the city for Content alerts** [\(P.79\)](#)
  - **Set up the TuneStart™** [\(P.80\)](#)
  - **Reset to the default settings** [\(P.80\)](#)

## Parental code

You can set a SiriusXM parental code.

- 1 Touch [Change] of [Parental Code] in the SiriusXM SETUP screen.**

Parental Pass Check screen appears.

### NOTE

- The code number is set to "0000" as default.

- 2 Enter the current code number.**  
Parental Pass 1st entering screen appears.
- 3 Enter the new code number and touch [Enter].**  
Parental Pass 2nd entering screen appears.
- 4 Enter the same code number as you input in step 3 and touch [Enter].**

The code number is confirmed and SiriusXM parental code is now set.

## Parental control

Parental control is a feature that provides the user with the ability to prevent unauthorized access to mature content and user selected channels.

**1 Touch [ON] or [OFF] of [Parental Lock Mature] in the SiriusXM SETUP screen.**

**2 Enter the same code number as you originally input in [Parental code \(P.76\)](#) and touch [Enter].**

Turns the Mature on or off.

Default is "OFF".

If you want to separately set the parental lock for each channel, select OFF and proceed to step 3 onward.

**3 Touch [SET] of [Parental Lock Channel Select] in the SiriusXM SETUP screen.**

Parental Pass Check screen appears.

### NOTE

- You need to complete [Parental code \(P.76\)](#) beforehand.
- To delete the parental lock channel setting, touch and hold [Unlock All] for 2 seconds, enter the Parental code number, then touch [Enter].

**4 Enter the same code number as you originally input in [Parental code \(P.76\)](#) and touch [Enter].**

Parental Lock Category Select screen appears.

**5 Touch the desired category from the list.**



Displays all the channels in the selected category.

### NOTE

- Touch [All Channels] to display all the channels.

**6 Touch each channel list and set on or off.**

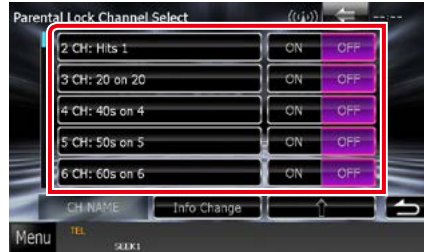

### NOTE

- Each time you touched [Info Change], switches the sequence of the channel list as follows; Channel name, Artist name, Song title, Category name, Content information.
- Touch [↑] to return to Parental Lock Category Select screen.
- Touch [←] to return to SiriusXM SETUP screen.



## Skip channel select

You can set the undesired channels to skip.

- 1 Touch [SET] of [Skip Channel Select].**  
Skip Category Select screen appears.
- 2 Touch the desired category from the list.**  
Displays all the channels in the selected category.
- 3 Touch each channel list and set ON or OFF.**

### NOTE

- Operations in each list screen are same as [Parental control \(P.77\)](#).
- To delete the skip channel setting, touch and hold [Unskip All] for 2 seconds, enter the Parental code number, then touch [Enter].

## Content alerts setup

You can turn on or off the Content alerts function.

- 1 Touch [ON] or [OFF] of [Content alerts] in the SiriusXM SETUP screen.**  
Turns the Content alerts on or off.  
Default is "ON".

## Content alerts Content Set

You can set a content for Content alerts.

### 1 Touch [SET] of [Content alerts Content Set] in the SiriusXM SETUP screen.

Artist list screen appears.

#### NOTE

- Touching [Disable All] of [Content alerts Content Set] turns all content of Content alerts "OFF".



### 2 Touch [Type] to select the screen of the content you want to set up.

Touching this allows you to switch among the Artist list, Song list, and Team list cyclically.

### 3 Touch each content list and set ON or OFF.

#### NOTE

- Touch "Delete" to delete the currently selected content from the Artist list and Song list.
- Available teams were pre-registered in the Team list. Team(s) cannot be registered or deleted manually.

## City select for Traffic & Weather Jump

You can select a city for which traffic information or weather forecast is to be received with the Content alerts function.

### 1 Touch [◀] and [▶] of [Traffic Weather Jump City Select] to select a city.

## TuneStart™

- 1 Touch [ON] or [OFF] of [Tune Start] in the SiriusXM SETUP screen.**

Turns the Tune start on or off.

Default is "ON".

## Reset

- 1 Touch [Reset] of [SiriusXM Reset] for 2 seconds in the SiriusXM SETUP screen.**

All SiriusXM setting returns to default.



## Bluetooth Control

Using the Bluetooth function, various functions can be used: listening to the audio file, making/receiving a call.

### About the cell-phone and Bluetooth audio player

This unit conforms to the following Bluetooth specifications:

#### Version

Bluetooth Ver. 3.0+EDR Certified

#### Profile

Cell-phone:

HFP (V1.6) (Hands Free Profile)

SPP (Serial Port Profile)

SDP (Service Discovery Profile)

PBAP (Phonebook Access Profile)

GAP (Generic Access Profile)

Audio player:

A2DP (Advanced Audio Distribution Profile)

AVRCP (V1.4) (Audio/Video Remote Control Profile)

#### Sound codec

SBC, AAC, MP3, aptX (DNX891HD, DNX7710BT only)

#### NOTE

- For the cell-phones verified for compatibility, access the following URL:  
<http://www.kenwood.com/cs/ce/bt/>.
- The units supporting the Bluetooth function have been certified for conformity with the Bluetooth Standard following the procedure prescribed by Bluetooth SIG.  
However, it may be impossible for such units to communicate with your cell-phone depending on its type.



## Registering And Connecting Bluetooth Unit

It is necessary to register the Bluetooth audio player or cell-phone to this unit before using the Bluetooth function.

You can register up to 5 Bluetooth units.

**1 Touch [Menu] on any screen.**

**2 Touch [SETUP].**

SETUP Menu screen appears.

**3 Touch [Bluetooth].**

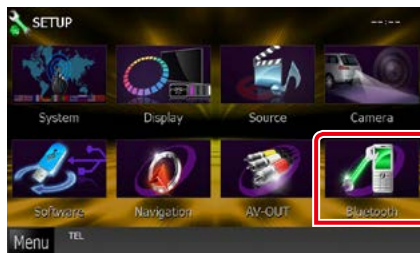

Bluetooth SETUP screen appears.

See the following section for each setting.

- **Registering the Bluetooth Unit** ([P.83](#))
- **Connecting the Bluetooth unit** ([P.83](#))

## Registering the Bluetooth Unit

### 1 Touch [Search].

Searched Device List screen appears.

#### NOTE

- You cannot register the Bluetooth unit when you are using the following sources:  
iPod, Bluetooth Audio, APPS, iHeart, Pandora  
If you want to register the Bluetooth unit while using one of the above mentioned sources, send the connection request from the Bluetooth unit and register it.
- A new device cannot be registered if there are 5 registered Bluetooth units. Delete unnecessary registration. See [Connecting the Bluetooth unit \(P.83\)](#).
- The Searched Device List screen cannot be displayed, when the receiving source is Pandora, iHeartRadio, or Bluetooth Audio.
- This unit is compatible with the Apple Easy Pairing function. When an iPod touch or iPhone is connected to this unit, an authentication dialog appears. Performing operation for authentication on this unit or iOS smartphone registers the smartphone as a Bluetooth device.

### 2 Select the Bluetooth unit to register from the list.



#### NOTE

- If the unit cannot be searched in step 1, you can search the unit again by touching [Search] in above screen.
- A Bluetooth device cannot be searched while the source is Pandora, iHeartRadio, or Bluetooth audio.
- Touch [Cancel] to cancel searching for the Bluetooth unit.

### 3 Enter PIN code form the cell-phone.

Profile select screen appears.

## Connecting the Bluetooth unit

### 1 Touch the device name you want to connect.

Profile select screen appears.

#### NOTE

- If the icon is lighted, it means that the unit will use that device.

### 2 Set each profile as follows.



#### TEL (HFP)

Means that the device is a cell-phone.

#### Audio (A2DP)

Means that the device is an audio player or cell-phone with audio player.

#### NOTE

- If a device has been paired, the Bluetooth unit cannot be connected from the paired device.
- Touching [Remove] of [Device Remove Confirm] removes registration information. After you touch the key, a confirmation message appears. Follow the message and complete the operation.

## Playing Bluetooth Audio Device

### Bluetooth basic operation

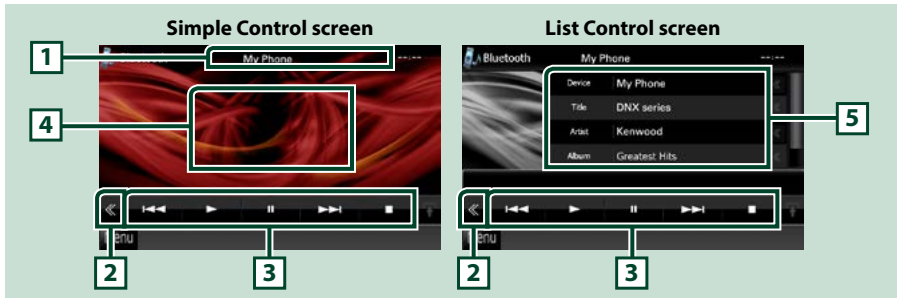

#### 1 Information display

Displays the name of the track information. If the information is not available, device name is displayed.

#### 2 Multi function key

Touch to switch the multi function menu.

#### 3 Multi function menu

The functions of each key are as follows.

- [◀▶]: Searches the previous/next content.\*
- [▶]: Plays.\*
- [⏸]: Pauses.\*
- [■]: Stops playback.\*
- [🔊 AUDIO]: Touch to display the Audio Control screen. See [Registering the Bluetooth Unit \(P.83\)](#).
- [⚙️ SETUP]: Touch to display the SETUP Menu screen. See [Setting Up \(P.92\)](#).
- [🔌 EXT SW]: Control the external device power supply. (DNX891HD, DNX7710BT only)  
For details, see [External Device Control \(P.104\)](#).
- [REAR 🔊]: Touch to mute the rear speaker.

#### 4 Control switching area

Touch to switch between the Simple Control and List Control screen.

#### 5 File information

Displays the information of the current file.

\* These items appear only when the audio player which supports AVRCP profile is connected.

#### NOTE

- If the operation keys do not appear, operate from the player.
- Depending on your cell-phone or audio player, audio may be heard and controlled but text information may not appear.
- If the volume is too low, raise it on your cell-phone or audio player.

## Using Hands-Free Unit

You can use telephone function by connecting the Bluetooth telephone to this unit.

### Making a call

- 1 Press the <TEL> button.  
**DNX8** **DNX7**



**DNX6** **DNX5**

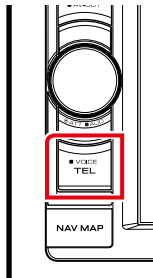

Hands Free screen appears.

#### NOTE

- When registration of your cell-phone is completed, the phone book of the cell-phone is automatically downloaded to this unit.
- Up to 600 phone numbers can be registered for each registered cell-phone.
- Up to 30 digits can be registered for each phone number along with up to 127 characters representing a name. (127 is the number of alphabetical characters. Fewer characters can be input depending on the type of characters.)
- Depending on the type of your cell-phone, the following restrictions are placed;
  - The phonebook data cannot be downloaded normally.
  - Characters in the phonebook are garbled.
- To cancel downloading the phonebook data, operate the cell-phone.

## 2 Select a dialing method.



See the following table for each method.

#### Call by entering a phone number

- ① Touch [ ].
- ② Enter a phone number with number keys.
- ③ Touch [ ].

#### Call using call records

- ① Touch [ ], [ ], or [ ].
- ② Select the phone number from the list.
- ③ Touch [ ].

#### Call using the phonebook

- ① Touch [ ].
- ② Select the name from the list.\*1\*2
- ③ Select the number from the list.
- ④ Touch [ ].

#### Call using the preset number

- ① Touch [Preset #] to start calling the corresponding phone number.
- ② Touch [ ].

**Continued**



\*1 You can sort the list to begin with touched character.



- Characters with no corresponding name will not appear.
- During search, a non-accent character such as “u” is searched for instead of an accent character such as “ü”.

\*2 You can set the list to arrange in the order of last name or first name. For details, see [Hands-Free Setup \(P.90\)](#).

#### NOTE

- If you edited the phonebook in your cell-phone, touch “Download” on top of the phonebook list in this unit to download it from your cell-phone. The phonebook in this unit will be updated with the latest downloaded data.
- While your car is moving, some functions are disabled for safety reasons. The keys associated with the disabled functions become ineffective if touched.
- The status icons such as battery and antenna displayed may differ from those displayed on the cell-phone.
- Setting the cell-phone in the private mode can disable the hands-free function.

## Receiving a call

1 Touch [ ] to answer a phone call or [ ] to reject an incoming call.



#### NOTE

- While monitoring the camera view, this screen does not appear even if a call comes in. To display this screen, press the <TEL> button or return the shift knob of car to the driver position.

## Operations during a call

### Adjust the receiver volume

#### DNX8 ▶ DNX7

Press the <▼> or <▲> button.

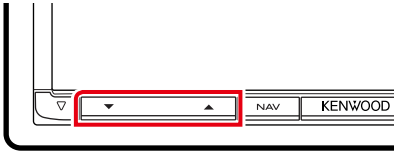

#### DNX6 ▶ DNX5

Turn the volume knob.

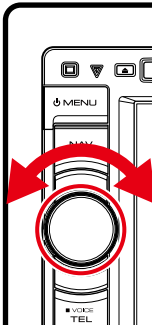

### Output the dial tone

Touch [DTMF] to display the tone input screen.  
You can send tones by touching desired keys on the screen.

### Switching the speaking voice output

Touching [Speaker icon] / [Phone icon] each time switches the speaking voice output between cell-phone and speaker.

### Call-waiting

When you receive a call while talking on another call, you can answer the newly received call by touching [Call waiting icon]. The current call is on hold.

Each time you touch [Call waiting icon], the caller will change.

When you touch [End call icon], the current call will end and switch to the call in hold.

## Phone number preset

You can register frequently used phone numbers to this unit.

### 1 Enter the number you want to register in Hands Free screen.

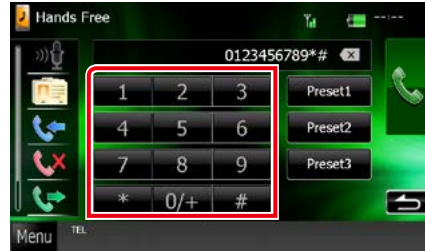

### 2 Touch [Preset 1], [Preset 2], or [Preset 3] for 2 seconds in the Hands Free screen.

## Voice Recognition

You can access the voice recognition function of the cell-phone connected to this unit. You can search the cell-phone phonebook by voice. (The functionality depends on the cell-phone.)

**1 Press the <TEL> button for 1 second.**

**DNX8** **DNX7**

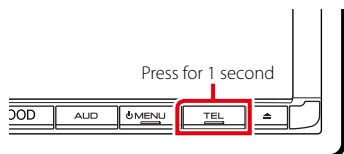

**DNX6** **DNX5**

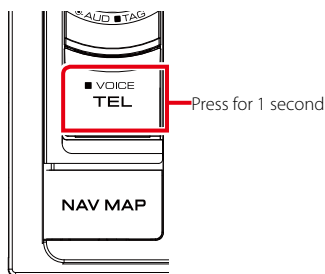

Voice Recognition screen appears.

**2 Start speaking.**

### NOTE

- You can use voice recognition function by touching [  ] on the Hands Free screen.

## Smartphone Link

You can receive Garmin's traffic information and weather forecast by connecting your Android smartphone in which the Smartphone Link application is installed to this unit.

**1 Press the <NAV> button.**

**DNX8** **DNX7**

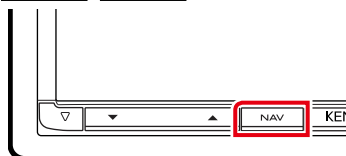

**DNX6** **DNX5**



Navigation screen appears.

Touch [Apps] on the Main Menu screen and then an icon of your desired content. For details, see Navigation system manual.

### NOTE

- Install the latest version of the Smartphone Link application on your Android. Search for "Smartphone Link" in the Google play to find and install the most current version.
- For how to register the Bluetooth device (Android), see [Registering the Bluetooth Unit \(P.83\)](#).



## Hands-Free Setup

You can perform various setup about handsfree function.

- 1 Touch [Menu] on any screen.
- 2 Touch [SETUP].  
SETUP Menu screen appears.
- 3 Touch [Bluetooth].

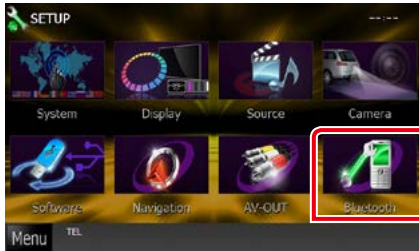

Bluetooth SETUP screen appears.

- 4 Touch [TEL SET-UP] in the Bluetooth SET-UP screen.



Hands-free SETUP screen appears.

## 5 Set each item as follows.



### Bluetooth HF/Audio

Select the speakers to output the sound from cell-phone (such as phone call voice and ringing tone) and Bluetooth audio player.

**Front Only:** Outputs from the front speakers.

**All (Default):** Outputs from all speakers.

### Auto Response\*

Sets an automatic response time to pick-up an incoming call.

**OFF (Default):** Automatic response is not available.

**0-99:** Set calling ring time (second).

### Auto Pairing

When set to "ON", the Apple Auto Pairing function is turned on to automatically register the iPod touch or iPhone connected to this unit.

**ON (Default):** Uses Apple Auto Pairing function.

**OFF:** Not uses Apple Auto Pairing function.

### Phone Information Use

Sets whether to use phonebook, outgoing, incoming and missed calls list.

**ON (Default):** Yes.

**OFF:** No.

### **Sort Order**

Sets how to arrange the cell-phone phonebook.

**First:** Arranges in the order of first name.

**Last (Default):** Arranges in the order of last name.

### **Echo Cancel Level**

Adjusts the level of echo cancellation.

Default is "0".

### **Microphone Level**

Adjusts the sensitivity of the telephone microphone. Default is "15".

### **Noise Reduction Level**

Reduces the noises generated by surrounding environment without changing the microphone volume. Use this setting when the voice of caller is not clear. Default is "-10".

### **[Restore]**

Resets the settings to the default settings.

**\* Either the time interval for automatic answer set on this unit or the time interval set on the cell-phone, whichever is shorter takes effect.**

# Setting Up

## Monitor Screen Setup

You can adjust image quality in iPod video, picture file, menu screen, etc.

**1 Touch the lower left area of any screen for at least 1 second.**



Screen Control screen appears.

**2 Adjust each item as follows.**

iPod/ AV-IN/ Camera

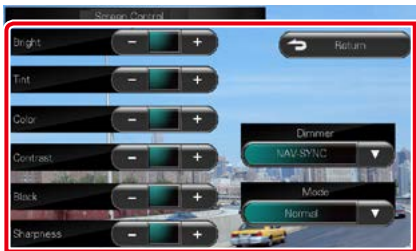

DVD/ USB



### Bright / Tint\* / Color\* / Contrast / Black / Sharpness\*

Adjusts each item.

### Dimmer

Select dimmer mode.

**ON:** The display and buttons dim.

**OFF:** The display and buttons do not dim.

**SYNC (Default):** Turns the dimmer function on or off when the vehicle light control switch is turned on or off.

**NAV-SYNC:** Turns the dimmer function on or off according to the Navigation Day/Night display setting.

### Mode\* (except USB)

Select screen mode.

**Full:** Full picture mode

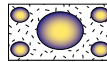

**Just:** Justify picture mode

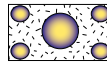

**Zoom:** Zoom picture mode

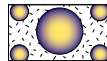

**Normal:** Normal picture mode

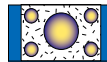

### \* Playback screen only

#### NOTE

- Adjusting items are different depending on the current source.
- You can perform this function only when you have applied the parking brake.
- The image quality can be set for each source.

## View Camera Control

### DNX8 DNX7

You can set up display when a CMOS-3xx Series view camera is used.

#### 1 Press the <AUD> button for 1second.



Camera view screen appears.

#### 2 Adjust each item as follows.

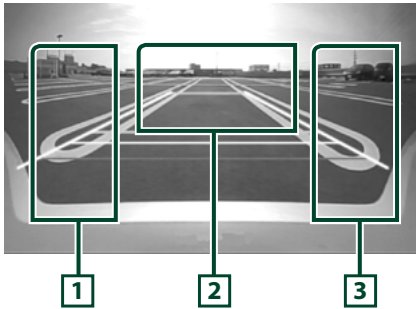

##### 1 Guideline

Touching each time turns on or off the guideline display alternately.

##### 2 Switching the View Camera

Touching each time changes between the front view camera and rear view camera.

##### 3 Angle

Touching each time changes camera angles in the following order:

Super wide view/ Wide view/ Overhead view/  
Wide view + Top view/ Corner view

#### NOTE

- The video camera controls described above may not be operable depending the connected cameras.
- [AUD Key Longer than 1 Second] must be set to "CAM". See [User interface \(P.94\)](#)

## System Setup

#### NOTE

- Each operation in this section can be started from the multi function menu.

#### 1 Touch [Menu] on any screen.

TOP Menu screen appears.

#### 2 Touch [SETUP].

#### 3 Touch [System].

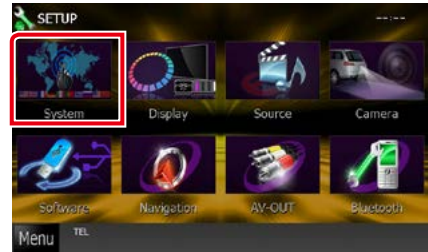

System Menu screen appears.

See the following section for each setting.

- **Set up the user interface** ([P.94](#))
- **Adjust touch panel** ([P.95](#))
- **Set up security** ([P.96](#))
- **Set up external switch (DNX891HD, DNX7710BT only)** ([P.96](#))
- **Set up memory** ([P.97](#))



## User interface

You can setup user interface parameters.

### 1 Touch [User Interface] in the list.

User Interface screen appears.

### 2 Set each item as follows.

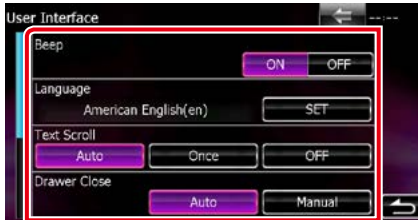

#### Beep

Turns the key touch tone on or off.  
Default is "ON".

#### Language

Select the language used for the control screen and setting items. See [Language setup \(P.95\)](#).

#### Text Scroll

Allows scrolling of text display on the source control screen. Select from "Auto"/"Once"/"OFF".

**Auto (Default):** Scrolls the text automatically.

**Once:** Allows you to scroll the text only once automatically when updated.

**OFF:** Does not scroll the text automatically.

#### Drawer Close

Sets whether to close the common menu [\(P.16\)](#) automatically. Default is "Auto".

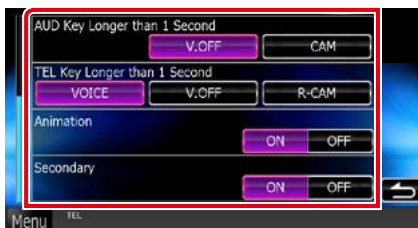

#### AUD Key Longer than 1 Second **DNX6** **DNX7**

You can set the operation performed when the AUDIO key is pressed for 1 second. Select from "V.OFF"/"CAM".

**V.OFF:** Turn the display off.

**CAM (Default):** Switches to the front or rear view camera video display.\*

#### TEL Key Longer than 1 Second **DNX6** **DNX5**

You can set the operation performed when the TEL key is pressed for 1 second. Select from "Voice"/"V.OFF"/"R-CAM".

**Voice (Default):** Displays the Voice Recognition screen. [\(P.88\)](#).

**V.OFF:** Turn the display off.

**R-CAM:** Switches to the rear view camera video display.

#### Animation

Sets whether to display animation. Default is "ON".

#### Secondary

Sets whether to display the navigation information in the audio screen or vice versa. Default is "ON".

**\*When you set [Front Camera] to OFF, the display will change to the rear view camera and when you set it to "CMOS-3xx"/"Other", the display will change to the front view camera. See [Camera Setup \(P.102\)](#)**

## Language setup

### 1 Touch [SET] of [Language] in the User Interface screen.

Language Setting screen appears.

### 2 Set each item as follows.

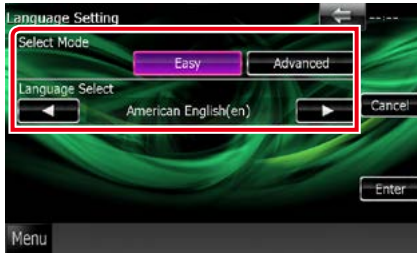

#### Select Mode

Selects the mode to select a language.

**Easy (Default):** Selects a language easily.

**Advanced:** Allows you to select languages for respective items.\*

#### Language Select

Selects a language.

\* If you select [Advanced] for Select Mode, the following screen appears.



#### GUI Language Select:

Selects the display language used for the control screen and so forth.

#### Navigation Language Select:

Selects the language used for navigation.

#### Text Language Select:

Selects the language used for tag text (song information).

### 3 Touch [Enter].

#### NOTE

- To cancel the language setup, touch [Cancel].

## Touch panel adjustment

### 1 Touch [Touch] in the System Menu screen.

Touch Panel Adjustment screen appears.

### 2 Follow the instruction on the screen and touch the center of each .

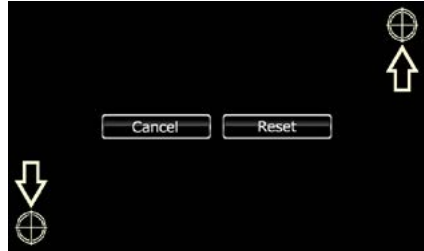

#### NOTE

- To cancel the touch panel adjustment, touch [Cancel].
- To reset to the initial status, touch [Reset].

## Security setup

A red indicator will blink on the unit after the ACC is set to OFF, warning potential thieves. If turned to "ON" (default), the security indicator on the front panel flashes when the vehicle ignition is off.

### 1 Touch [Security] in the System Menu screen.

Security screen appears.

### 2 Touch [ON] or [OFF] of [SI].

## EXT SW setup (DNX891HD, DNX7710BT)

Set up the external switch power mode.

### 1 Touch [EXT SW] in the System Menu screen.

EXT SW screen appears.

### 2 Set each item as follows.



#### SW Name

Sets the name of the external device.

#### Output Pattern

Sets the power signal output mode among "Pulse"/"Level". Default is "Pulse".

You can set to turn output on/off each time the button on the EXT SW screen is touched. See [External Device Control \(P.104\)](#).

#### Pulse Set

Sets the pulse signal output time.

Outputs 500ms when "1" is set.

Increases by 200ms with each step. Up to 100 steps can be set.

#### NOTE

- You can enter characters only after you have applied the parking brake.
- "Pulse": Generates a single power signal pulse.



- "Level": Continues output of high power signal.

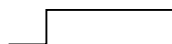

## Setup memory

Audio Control, AV-IN SETUP, Camera, and Audio SETUP settings can be memorized. The memorized settings can be recalled at any time. For example, even when the settings are cleared due to replacement of the battery, the settings can be restored.

### 1 Touch [SETUP Memory] in the System Menu screen.

SETUP Memory screen appears.

### 2 Follow the instruction on the screen.

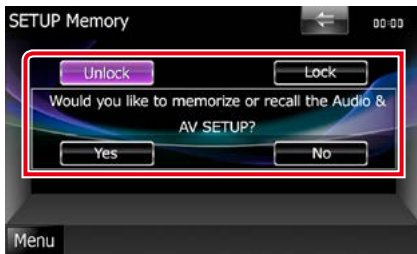

#### [Lock]/[Unlock]\*

Locks or unlocks the AV-IN SETUP, and Audio SETUP settings.

#### Yes

Memorizes or recalls the settings.

#### No

Cancels the function or memorization.  
The SETUP Menu screen appears again.

**\* When [Lock] is selected, you cannot change the AV-IN SETUP, and Audio SETUP settings. Also, the locked key mark is displayed under each setting icon in the setup menu.**

### 3 Follow the instruction on the screen.

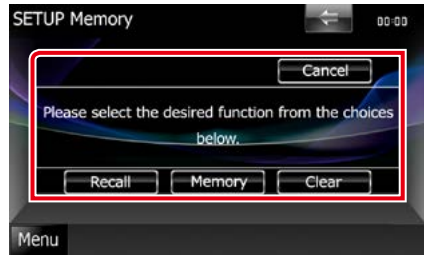

#### Recall

Recalls the memorized settings.

#### Memory

Memorizes the current settings.

#### Clear

Clears the currently memorized settings.

#### Cancel

Quits memorization/recalling of settings.

## Display Setup

- 1 Touch [Menu] on any screen.
- 2 Touch [SETUP].  
SETUP Menu screen appears.
- 3 Touch [Display].

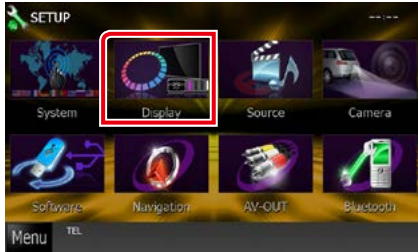

Display Menu screen appears.  
See the following section for each setting.

- **Control monitor angle** **DNX8** **DNX7** ([P.98](#))
- **Adjust panel color** ([P.99](#))
- **Changing background image** ([P.100](#))

## Monitor angle control **DNX8** **DNX7**

You can adjust the position of the monitor.

- 1 Touch [Angle] in the Display Menu screen.  
Angle setup screen appears.
- 2 Select a below number that represents your desired angle setting.



Default is "0".

### NOTE

- You can store the current monitor angle as the angle during power off. Touch [Memory] when the desired angle is selected.

## Panel color coordinate

You can set the screen and button illumination color.

The selectable items differ depending on the unit.

### 1 Touch [Color] in the Display Menu screen.

Color screen appears.

### 2 Touch [SET] of [Panel Color Coordinate].



Panel Color Coordinate screen appears.

#### NOTE

- You can touch [SET] or [Initialize] when [Panel Color Scan] is set to off.
- Touch [Initialize] to reset the settings to the default settings.

### 3 Touch the desired color.



## Registering original color

You can register your original color.

### 1 Touch [Adjust] in the Panel Color Coordinate screen.

Panel Color RGB Coordinate screen appears.

### 2 Use [◀] and [▶] to adjust each color value.

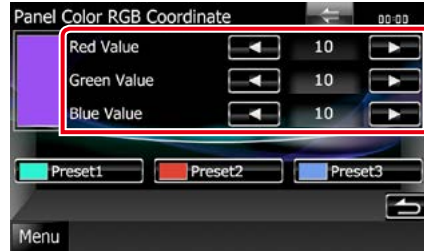

### 3 Touch the desired preset key for 2 seconds.

## Panel color scan

You can set the panel color to continuously scan through the color spectrum.

### 1 Touch [ON] of [Panel Color Scan] in the Color screen.

Panel Color Scan is set to on.

## Changing background image

You can load an image from the connected USB device and set it for the background image.

Before operating this procedure, it is necessary to connect the device which has the image to load.

### 1 Touch [Background] in the Display Menu screen.

Background screen appears.

### 2 Touch [STANDBY].



### 3 Touch [Memory] of [User Background].

User Background File Select screen appears.

### 4 Select the image to load.

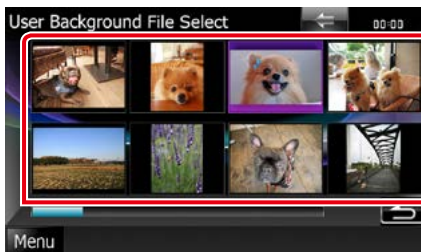

### 5 Touch [Enter].

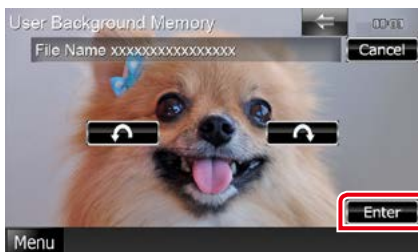

The selected image is loaded and the

display returns to the Background screen.

#### NOTE

- Touching [↶] rotates counter clockwise.
- Touching [↷] rotates clockwise.

### 6 Touch [Change] of [Background Change] in the Background screen.

### 7 Select an image for background and touch [Enter].

#### NOTE

- See [Playable Media and Files \(P.126\)](#) for readable image specifications.
- Touching [Delete] in the Background screen deletes the background image. After you touch [Delete], a confirmation message appears. Follow the message and complete the operation.

## Navigation Setup

You can set navigation parameters.

**1 Touch [Menu] on any screen.**

**2 Touch [SETUP].**

SETUP Menu screen appears.

**3 Touch [Navigation].**



Navigation SETUP screen appears.

**4 Set each item as follows.**



### NAV Interrupt Speaker

Selects speakers used for voice guidance of the navigation system.

**Front L:** Uses the front left side speaker for voice guidance.

**Front R:** Uses the front right side speaker for voice guidance.

**Front All (Default):** Uses both front speakers for voice guidance.

### NAV Voice Volume

Adjusts the volume for voice guidance of the navigation system. Default is "20".

### NAV Mute

Mutes the volume of rear speakers during voice guidance of the navigation system. Default is "ON".



## Camera Setup

You can set camera parameters.

- 1 Touch [Menu] on any screen.
- 2 Touch [SETUP].  
SETUP Menu screen appears.
- 3 Touch [Camera].

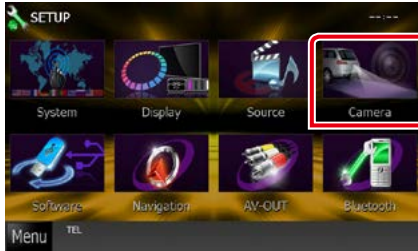

Camera SETUP screen appears.

- 4 Set each item as follows.



### Rear Camera\*1 **DNX8** **DNX7**

Selects the type of rear camera to use.

CMOS-3xx: When the CMOS-300 series with ID 1 set is connected.

Other (Default): When the other camera is connected.

### R-CAM Interruption

Sets a method for switching the display.  
Setting values are ON and OFF.

ON: Switches to the rear view camera video display when shifting to revers.

OFF (Default): Does not switches to the rear view camera video display when shifting to revers.

### R-CAM Settings\*2 **DNX8** **DNX7**

Adjusts the CMOS-300 series with ID 1 set.  
For details, see the instruction manual of your camera.

### Front Camera\*1 **DNX8** **DNX7**

Selects the type of front camera to use.

CMOS-3xx: When the CMOS-300 series with ID 2 set is connected.

Other: When the other camera is connected.

OFF (Default): When the front camera is not used.

### F-CAM Settings\*3 **DNX8** **DNX7**

Adjusts the CMOS-300 series with ID 2 set.  
For details, see the instruction manual of your camera.

\*1 These settings become settable only when the parking brake is on.

\*2 This setting becomes settable only when the parking brake is on and the CMOS-300 series is selected.

\*3 This setting becomes settable only when the parking brake is on and "Front Camera" is set to CMOS-300 series.

## Software Information

Check the software version of this unit.

- 1 Touch [Menu] on any screen.
- 2 Touch [SETUP].  
SETUP Menu screen appears.
- 3 Touch [Software].



Software Information screen appears.

- 4 Confirm the software version. Touch [Update] as necessary.

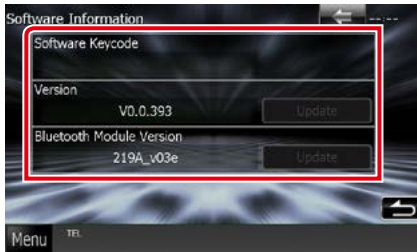

### NOTE

- For how to update the software, see the relevant update procedure manual which comes with the software.

## AV Input Setup

You can set AV input parameters.

- 1 Touch [Menu] on any screen.
- 2 Touch [SETUP].  
SETUP Menu screen appears.
- 3 Touch [Source].



- 4 Touch [AV-IN SETUP] in the list.  
AV-IN SETUP screen appears.

- 5 Set each item as follows.



### AV-IN1 Name/AV-IN2 Name

Sets a name to be displayed when you select a system that is connected via the AV INPUT port. Default is "VIDEO".

## AV Output Interface Setup

You can select an AV source to be output at the AV OUTPUT port. Default is "VIDEO1".

- 1 Touch [Menu] on any screen.
- 2 Touch [SETUP].  
SETUP Menu screen appears.
- 3 Touch [AV-OUT].

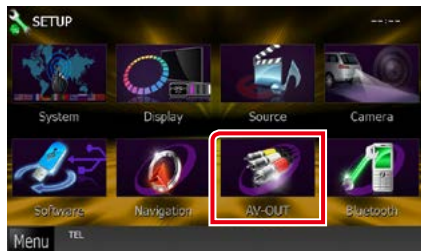

AV-OUT Interface screen appears.

- 4 Touch [◀] or [▶] to set [AV-OUT] to VIDEO1, DISC, iPod, USB, or OFF.

### NOTE

- Only when iPod is connected to this unit with KCA-iP202, "USB" can be selected as AV output source. For the connection setting, refer to [iPod/iPhone connection setup \(P.54\)](#).

## External Device Control (DNX891HD, DNX7710BT only)

Control the external device power supply.

- 1 Touch [EXT SW] in the Source Control screen.



EXT SW Control screen appears.

### NOTE

- If [EXT SW] is not displayed, touch [◀].

- 2 Touch the desired switch key.

You can turn on or off the external device power supply.

### NOTE

- You must connect a commercially available relay unit in order to use this function. Connect the external device to be controlled to that relay unit.
- See [EXT SW setup \(P.96\)](#) for information on setting the power on or off specification.



# Controlling Audio

## NOTE

- Each operation in this section can be started from the multi function menu.

You can adjust the various settings such as audio balance or subwoofer level.

**1 Touch [Menu] on any screen.**

**2 Touch [Audio].**

Audio screen appears.

See the following section for each setting.

- **Setting audio** ([P.106](#))
- **Controlling audio** ([P.110](#))
- **Controlling equalizer** ([P.112](#))
- **Performing zone control** ([P.112](#))
- **Set sound effect** ([P.113](#))
- **Set listening position** ([P.115](#))

## Setting Audio

**1 Touch [Audio SETUP].**



Audio SETUP screen appears.



See the following section for each setting.

- **Set up speakers** ([P.107](#))
- **Set up your car type** ([P.108](#))
- **Select DSP** ([P.109](#))

## Speaker setup

You can select a speaker type and its size to get the best sound effects.

When the speaker type and size are set, the speaker crossover network is set automatically.

### 1 Touch [Speaker Select] in the Audio SETUP screen.

Speaker Select screen appears.



### 2 Touch the speaker you wish to adjust and set each item as follows.



#### **Tweeter (DNX891HD, DNX7710BT, DNX691HD only)**

You can set the tweeter when you are selecting front speakers.

None, Small, Middle, Large

#### **X'over**

Displays the speaker crossover setup screen.

You can adjust the crossover setup that was set automatically when you selected the speaker type.

For details, see [Crossover network setup \(P.108\)](#)

### 3 Select a speaker size using [◀] and [▶]. The speaker size is different depending on the speaker type and the unit.

#### **Front**

OEM, 3-1/2 inch, 4 inch, 4-3/4 inch, 5 inch, 6-1/2 inch, 6-3/4 inch, 7 inch, 4x6, 5x7, 6x8, 6x9, 7x10

#### **Rear**

None, OEM, 3-1/2 inch, 4 inch, 4-3/4 inch, 5 inch, 6-1/2 inch, 6-3/4 inch, 7 inch, 4x6, 5x7, 6x8, 6x9, 7x10

#### **Subwoofer**

None, 6 1/2 inch, 8 inch, 10 inch, 12 inch, 15 inch over

#### **NOTE**

- Select "None" if you have no speakers.

### Crossover network setup

You can set a crossover frequency of speakers.

- 1 Touch the speaker to set the crossover in the Speaker Select screen.
- 2 Touch [X'over].  
X'over screen appears.
- 3 Set each item as follows.

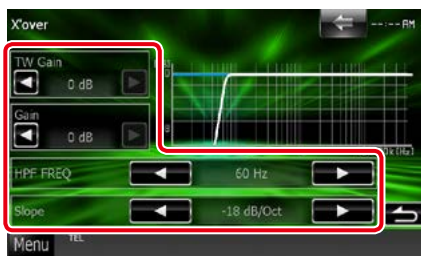

#### **TW (Tweeter) Gain \*1 (DNX891HD, DNX7710BT, DNX691HD only)**

Adjusts the tweeter level. (When front is selected on Speaker Select screen)

#### **Gain (DNX891HD, DNX7710BT, DNX691HD only)**

Adjusts the front speaker, rear speaker, or subwoofer level.

#### **Phase\*2**

Sets the phase of subwoofer output.  
The phase is reversed 180 degrees when set to "Reverse". (When subwoofer is selected on Speaker Select screen)

#### **HPF FREQ**

High Pass Filter adjustment. (When front or rear speaker is selected on Speaker Select screen)

#### **LPF FREQ**

Low Pass Filter adjustment. (When subwoofer is selected on Speaker Select screen)

#### **Slope\*3**

Sets a crossover slope.

- \*1 Only when "Tweeter" is set to "Small", "Middle", "Large" in <Speaker Setup>.
- \*2 Only when "Subwoofer" is set to a mode other than "None" in <Speaker Setup>.
- \*3 Only when "LPF FREQ"/"HPF FREQ" is set to a mode other than "Through" in <X'over>.

### Car type setup

You can setup the car type and speaker network, etc.

- 1 Touch [Car Type] in the Audio SETUP screen.  
Car Type screen appears.
- 2 Select your car type from the list.



#### **NOTE**

- If your car type is selected, the Delay Time Alignment is set automatically (for timing adjustment of sound output for each channel) to have the highest surround effects.

## Speaker location setup

**1** In the **Car Type** screen, touch **[Location]**.  
Speaker Location screen appears.

**2** Select the speaker locations using **[▶]**.



### Front Speaker

Select the location from "Door"/"On Dash"/  
"Under Dash".

### Rear Speaker

Select the location from "Door"/"Rear Deck",  
"2nd Row"/"3rd Row" (Minivan, Minivan  
(Long)).

## DSP select

You can select whether using DSP (Digital  
Signal Processor) System.

**1** Touch **[Bypass]** or **[Through]** of **[DSP  
Select]** in the **Audio SETUP** screen.



### Bypass

There is no effect by DSP.

### Through

There is an effect by DSP.

### NOTE

- When the mode is set to [Bypass], DSP System cannot be adjusted.



## Controlling General Audio

### 1 Touch [Audio Control].



### 2 Set each item as follows.



#### Fader #/Balance #

Adjust the volume balance around the touched area.

[◀] and [▶] adjust the right and left volume balance.

[▲] and [▼] adjust the front and rear volume balance.

#### Volume Offset\*

Finely adjust the volume of the current source to minimize the difference in volume between different sources.

#### Subwoofer Level

Adjusts the subwoofer volume. This setting is not available when subwoofer is set to "None". See [Speaker setup \(P.107\)](#).

#### Bass Boost

Sets the amount of bass boost among "OFF"/"Level1"/"Level2"/"Level3".

\* If you have increased the volume first, then reduced the volume using the "Volume Offset", the sound generated if you suddenly switch to another source may be extremely loud.

## Equalizer Control

You can adjust equalizer by selecting the optimized setting for each category.

### 1 Touch [Equalizer].



Equalizer screen appears.

## Operation

### Controlling EQ curves

- 1 Select EQ curve from [Natural], [Rock], [Pops], [Easy], [Top40], [Jazz], [Powerful], [iPod], and [User].



#### NOTE

- [iPod] is available only during iPod source.

### Controlling equalizer manually

This setting cannot be performed when you select [iPod] in the Equalizer screen.

- 1 Touch [EQ] in the Equalizer screen.
- 2 Touch the screen and set the Graphic Equalizer as desired.

### DNX891HD, DNX7710BT, DNX691HD



### DNX771HD, [DNX5]



### Gain level (light green boxed area)

Adjust the gain level by touching the each frequency bar.

Touching [◀], [▶], [▲] and [▼] can also adjust the level. Use [◀] and [▶] to select a frequency, and [▲] and [▼] to set the level.

### EQ INIT

Returns to the previous level which the gain level is adjusted.

### Flat

Tone curve becomes flat.

### Bass EXT (Bass Extend Settings)

When turned on, the frequency lower than 62.5 Hz is set to the same gain level as 62.5 Hz.

### Loudness

Sets the amounts of boost of low and high tones.

DNX891HD, DNX7710BT, DNX691HD:

“OFF”, “Low”, “High”

DNX771HD, [DNX5]: “OFF”, “ON”

### SW Level

Adjusts the subwoofer volume. This setting is not available when subwoofer is set to “None”. See [Speaker setup \(P.107\)](#).

## Zone Control

You can select different sources for both front and rear positions in the vehicle.

### 1 Touch [Zone Control].



Zone Control screen appears.

### 2 Touch [Dual Zone].



### 3 Set each source as follows.



#### [▶] (Front Source, Rear Source)

Select the audio source for each.

#### [▼], [▲] (Rear VOL.)

Adjusts the rear channel volume.

#### [Single Zone]

Touch to turn off the dual zone function.

#### NOTE

- When the rear speaker sound is switched, the audio source that is output at the AV OUTPUT terminal is also switched to the same source.
- When the dual zone function is set to on, the following functions are not available.
  - Output from the subwoofer
  - Subwoofer Level/ Bass Boost ([P.110](#))
  - Equalizer Control/ Space Enhancer (DNX891HD, DNX7710BT, DNX691HD)/ Listening Position ([P.110, 113, 115](#))
  - DSP Bypass Control/ Speaker Setup/ Car Type Setup ([P.109, 107, 108](#))
- Different sources from iPod/iPhone (apps) cannot be set as front source and rear source separately. Only one source (app) can be set as front and rear sources.

## Sound Effect

You can set sound effects.

### 1 Touch [Sound Effect].



Sound Effect screen appears.



See the following section for each setting.

- **Set space enhancer (DNX891HD, DNX7710BT, DNX691HD) [\(P.113\)](#)**
- **Set drive equalizer [\(P.114\)](#)**
- **Set up elevation (DNX891HD, DNX7710BT, DNX691HD) [\(P.114\)](#)**
- **Set up realizer or supreme (DNX891HD, DNX7710BT, DNX691HD) [\(P.115\)](#)**

## Space Enhancer (DNX891HD, DNX7710BT, DNX691HD)

### 1 Touch [Space Enhancer] in the Sound Effect screen.



Space Enhancer screen appears.

### 2 Touch [Small], [Large], or [OFF].

Each setting value indicates the soundscape level.

#### NOTE

- This setting is not available during HD Radio tuner source.

## Drive Equalizer setting

The sound quality is automatically adjusted.

- 1 Touch **[ON]** or **[OFF]** of **[Drive Equalizer+]**.



DNX891HD, DNX7710BT, DNX691HD:  
The sound quality is automatically optimized to meet the current car speed by GPS.

DNX771HD **DNX5**:

The sound quality is automatically optimized to meet the current volume level.

## Elevation (DNX891HD, DNX7710BT, DNX691HD)

You can raise the sound position heard from the speakers virtually.

- 1 Touch **[Elevation]** in the Sound Effect screen.



Elevation screen appears.

- 2 Select Elevation level from **[High]**, **[Low]**, and **[OFF]**.

## Realizer and Supreme (DNX891HD, DNX7710BT, DNX691HD)

You can restore the sound lost due to audio compression to a realistic sound.

### 1 Touch the screen in the Sound Effect screen.



#### Realizer

Realizer is sound enhancement and boosting low frequencies (bass boost).

Select the level from "OFF"/"Level1"/"Level2"/"Level3".

#### Supreme

Turns ON/OFF the Supreme function.

Technology to extrapolate and supplement with proprietary algorithm, the high-frequency range that is cut off when encoding.

This function works on DVD MEDIA, USB and iPod sources.

## Listening Position

You can adjust the sound effects according to your listening position.

### 1 Touch [Position].



Position screen appears.

### 2 Select listening position from [Front R] (Right front), [Front L] (Left front), [Front All] (All front), and [All] using [◀] and [▶].



## Position DTA control

You can fine-adjust your listening position.

**1** In Position screen, touch [Adjust].

**2** Select the speaker you wish to adjust by touching speaker icon.



**3** Set DTA as follows.



[◀], [▶]

Adjust the settings of the DTA position.

**Gain**

Touch to adjust the gain of each speaker.

### NOTE

- Make fine adjustment of the delay time of the speaker output specified here to have a more suitable environment for your vehicle.
- If you specify the distance from the center of the currently set listening position to every speaker, the delay time will be automatically computed and set.
  - ① Determine the center of the currently set listening position as the reference point.
  - ② Measure the distances from the reference point to the speakers.
  - ③ Calculate the differences between the distance of the furthest speaker and other speakers.
  - ④ Input the differences calculated in step ③ for individual speakers.
  - ⑤ Adjust gain for individual speakers. A sound image will be shifted to the speaker with increased gain.

Example: When [Front All] is selected as the listening position

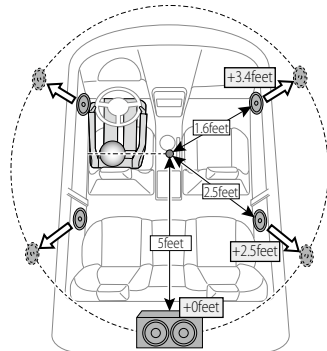





## Remote control

This unit can be operated using the remote control.

For DNX891HD, DNX7710BT, DNX691HD, and DNX5710BT, the remote control is supplied with the unit.

For DNX771HD, DNX571HD and DNX571EX the remote control is the optional accessory (KCA-RCDV331).

### ⚠ CAUTION

- Put the remote control in a place where it will not move during braking or other operations. A dangerous situation could result, if the remote control falls down and gets wedged under the pedals while driving.
- Do not leave the battery near fire or under direct sunlight. A fire, explosion or excessive heat generation may result.
- Do not recharge, short, break up or heat the battery or place it in an open fire. Such actions may cause the battery to leak fluid. If spilled fluid comes in contact with your eyes or on clothing, immediately rinse with water and consult a physician.
- Place the battery out of reach of children. In the unlikely event that a child swallows the battery, immediately consult a physician.

## Battery Installation

If the remote control operates only over shorter distances or does not operate at all, it is possible that the batteries are depleted.

In such instances, replace the both batteries with new ones.

- 1** Insert two "AAA"/"R03"-size batteries with the ⊕ and ⊖ poles aligned properly, following the illustration inside the case.

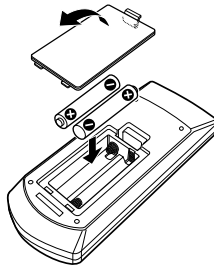

## Functions of the Remote control Buttons

### Switching the operation mode

The functions operated from the remote control differ depending on the position of the mode switch.

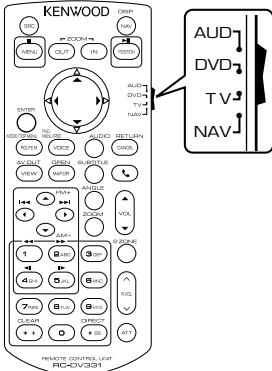

#### AUD mode

Switch to this mode when controlling a selected source or tuner source, etc.

#### DVD mode

Switch to this mode when playing a disc media including DVD, VCD, and CD.

#### NAV mode

Switch to this mode when controlling navigation function.

#### NOTE

- When controlling a player that is not integrated in the unit, select "AUD" mode.

### Direct search mode

Using the remote control, you can jump directly to the desired file, track chapter, etc. with entering the number corresponding to the content.

#### NOTE

- This operation cannot be performed for USB device and iPod.

### 1 Press the <#BS> button several times until the desired content appears.

The available contents are different depending on the source.

#### DVD

Title number/Chapter number/Play time/Item number\*

\* You may not be able to use this function with some discs or scenes.

#### VCD 1.X and 2.X (PBC OFF)

Track number

#### VCD 2.X (PBC ON)

Scene number/number

#### Music CD

Track number/Play time

#### Audio files

Folder number/File number

#### Radio

Frequency value

#### HD Radio tuner

Frequency value/Channel number

#### SiriusXM

Channel number

### 2 Enter the number of the content you want to play using the numeric keypad.

### 3 For DVD or VCD, press the <ENTER> button.



For music CD or audio files, press the <POSITION> button.

For radio, press the <<> or <>> button.

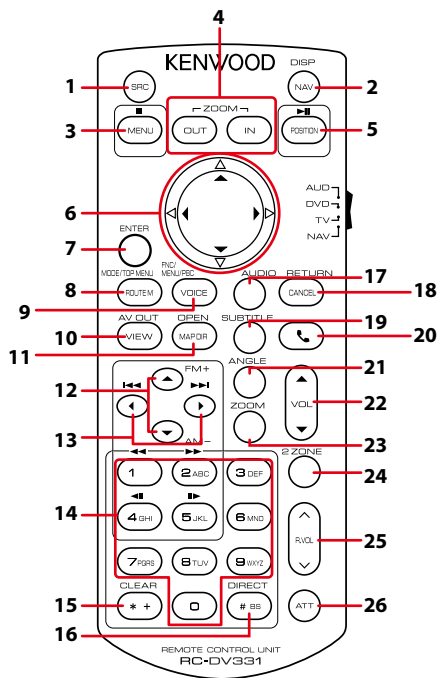
The content you entered is played.



	Key Name	Location of the mode switch	Function
1	SRC	—	Switches to the source to be played. In hands-free mode, hangs up the phone.
2	NAV	—	Switches between the navigation and the source screens.
3	MENU	DVD	Stops playing and memorizes the last point where the disc stopped. The last point is deleted by pressing twice.
		NAV	Displays Main menu.
4	POSITION	AUD, DVD	Pauses the track or file, and resumes playing by pressing twice. During radio, HD Radio, and SiriusXM source in AUD mode, switches the seek mode.
		NAV	Displays the current position.
6	Cursor Key	DVD	Moves the cursor in the DVD menu.
		NAV	Moves the cursor or scrolls the map.
7	ENTER	AUD, DVD	Performs the selected function.
		NAV	<ul style="list-style-type: none"> <li>Registers the selected position.</li> <li>Performs the selected function.</li> </ul>
8	ROUTE M	AUD	Screen mode changes each time you press this key during video playback.
		DVD	Returns to the DVD top menu.
		NAV	Displays Route Option menu.

	Key Name	Location of the mode switch	Function
9	VOICE	AUD	Switches navigation display on/off.
		DVD	Displays the DVD menu. Turns the playback control on or off while playing VCD.
		NAV	Speaks the voice guidance.
10	VIEW	AUD, DVD	Switches the AV source to be output.
		NAV	Switches between 2D and 3D map displays.
11	MAP DIR	AUD, DVD	<b>DNX8</b> <b>DNX7</b> Switches the display angle each time it is pressed.
		NAV	Switches between the heading up navigation and north up navigation map displays.
12	▲/▼	AUD, DVD	Selects the folder to be played. During radio, HD Radio, and SIRIUS/XM source in AUD mode, switches the bands to be received.
13	◀▶	AUD, DVD	Selects the track or file to be played. During radio, HD Radio, and SIRIUS/XM source in AUD mode, switches to broadcast stations received by the unit.
14	Numeric Keypad	AUD	Specifies the number to search in direct search. For details on the direct search mode, see <a href="#">Direct search mode (P.119)</a> .
		DVD	<ul style="list-style-type: none"> <li>• Press [1] [2] to fast forward/backward. Switches the fast forward/backward speed each time you press this key.</li> <li>• Press [4] [5] to slow forward/backward. Switches the slow playback speed each time you press this key.*</li> </ul> *DVD only
15	* +	DVD	Clears the number.
16	# BS	AUD, DVD	Switches to the direct search mode. For details on the direct search mode, see <a href="#">Direct search mode (P.119)</a> .
17	AUDIO	DVD	Switches the voice language each time you press this key.
18	CANCEL	DVD	Displays previous screen.
		NAV	Cancels the operations.
19	SUBTITLE	DVD	Switches the subtitle language.
20		–	When a call comes in, answers the call.
21	ANGLE	DVD	Switches the picture angle each time you press this key.
22	Vol ▲▼	–	Adjusts the volume.
23	ZOOM	DVD	Switches the zoom ratio (2, 3, 4, Off) each time you press this key.
24	2 ZONE	AUD, DVD	Switches the Dual Zone function on and off.
25	R.VOL 	–	Adjusts volume at rear when the Dual Zone function is on.
26	ATT	–	Lowers the volume by pressing the key once. Restores the previous volume by pressing the key twice.

# Troubleshooting

## Problems and Solutions

If any trouble occurs, first check the following table for possible problems.

- Some functions of this unit may be disabled by some settings made on this unit.
- What might seem to be a malfunction in your unit may just be the result of slight misoperation or miswiring.

### About settings

Problem	Reason	Solution
<ul style="list-style-type: none"> <li>• Cannot set up the subwoofer.</li> <li>• Cannot set up subwoofer phase.</li> <li>• No output from the subwoofer.</li> <li>• Cannot set up the low pass filter.</li> <li>• Cannot set up the high pass filter.</li> </ul>	Subwoofer is not set to on.	Set the subwoofer to on. See <a href="#">Speaker setup (P.107)</a> .
	The dual zone function is enabled.	Set the dual zone function to off. See <a href="#">Zone Control (P.112)</a> .
<ul style="list-style-type: none"> <li>• Cannot select the output destination of the subsource in the dual zone.</li> <li>• Cannot adjust the volume of the rear speakers.</li> </ul>	The dual zone function is disabled.	Set the dual zone function to on. See <a href="#">Zone Control (P.112)</a> .
<ul style="list-style-type: none"> <li>• Cannot set up the equalizer.</li> <li>• Cannot set up the crossover network.</li> </ul>	The dual zone function is enabled.	Set the dual zone function to off. See <a href="#">Zone Control (P.112)</a> .
	"DSP Select" is set to "Bypass".	Set "DSP Select" to "Through". See <a href="#">DSP select (P.109)</a> .

### About audio operations

Problem	Reason	Solution
Radio reception is poor.	The car antenna is not extended.	Pull out the antenna all the way.
	The antenna control wire is not connected.	Connect the wire correctly. See "Connection" in the Quick Start Guide.
Cannot play audio files stored in a disc.	"CD Read" is set to "2".	Set "CD Read" to "1". See <a href="#">Disc setup (P.30)</a> .
Cannot select a folder.	The random play function is enabled.	Turn off the random function.
Cannot perform repeat play during VCD playback.	The PBC function is enabled.	Turn off the PBC function.
The specified disc does not play, but another one plays instead.	The disc is quite dirty.	Clean the disc. See <a href="#">Precautions on handling discs (P.4)</a> .
	The disc is severely scratched.	Try another disc instead.

Problem	Reason	Solution
The sound skips when an audio file is being played.	The disc is scratched or dirty.	Clean the disc. See <a href="#">Precautions on handling discs (P.4)</a> .
	The recording condition is bad.	Record the file again or use another disc.

## Other

Problem	Reason	Solution
The Touch Sensor Tone doesn't sound.	The preout jack is being used.	The Touch Sensor Tone cannot be output from the preout jack.

## Error Messages

**When you fail to operate the unit correctly, the cause of the failure appears as the message on the screen.**

Error Message	Cause	Solution
Protect	Protective circuit has been activated because a speaker cord has shorted or it has come in contact with the car chassis.	Wire or insulate the speaker cord as appropriate and then push the <Reset> button ( <a href="#">P.125</a> ).
Hot Error	When the internal temperature of this unit rises to 60°C or more, the protection circuit is activated and you may not be able to operate the unit.	Use the unit again after reducing the temperature of the unit.
Mecha Error	The disc player is malfunctioning.	Eject the disc and try inserting it again. Contact the Kenwood dealer if this indicator continues blinking or the disc cannot be ejected.
Disc Error	An unplayable disc is inserted.	Change the disc. See <a href="#">Playable Media and Files (P.126)</a> .
Read Error	The disc is quite dirty.	Clean the disc. See <a href="#">Precautions on handling discs (P.4)</a> .
	Disc is upside down.	Load the disc with the labeled side up.
Region Code Error	The disc you wanted to play has a region code that cannot be played with this unit.	See <a href="#">Region Codes in the World (P.132)</a> or try another disc.
Parental Level Error	The disc you wanted to play has a higher level than the parental level you set.	Set the parental level. See <a href="#">Parental level (P.30)</a> .
Error 07–67	The unit is not operating correctly due to some reason or other.	Push the unit's Reset button. If the "Error 07–67" message does not disappear, see your nearest Kenwood dealer.
No Device (USB device, Bluetooth audio player)	The USB device is selected as a source although no USB device is connected.	Change the source to any source other than USB/iPod. Connect a USB device, and change the source to USB again.

<b>Error Message</b>	<b>Cause</b>	<b>Solution</b>
Disconnected (iPod)	The iPod/Bluetooth audio player is selected as a source although no iPod/Bluetooth audio player is connected.	Change the source to any source other than iPod/Bluetooth. Connect an iPod/Bluetooth audio player, and change the source to iPod/Bluetooth again.
No Media file	The connected USB device contains no playable audio file. Media was played that doesn't have data recorded that the unit can play.	See <a href="#">Playable Media and Files (P.126)</a> and try another USB device.
USB Device Error!!	The connected USB device is rated a current capacity higher than the allowable limit.	Check the USB device. Some trouble may have occurred to the connected USB device. Change the source to any source other than USB. Remove the USB device.
Authorization Error	Connection to the iPod has failed.	<ul style="list-style-type: none"> <li>Remove the iPod and then reconnect it.</li> <li>The unit does not support the iPod. See <a href="#">Connectable iPod/iPhone (P.128)</a>.</li> </ul>
Update your iPod	The iPod's software is an older version which the unit can not support.	The unit may not support the connected iPod model. Confirm that the software for the iPod is the latest version. See <a href="#">Connectable iPod/iPhone (P.128)</a> .
Navigation Error. Please turn on power again later.	The communication error has occurred due to severely cold temperature.	Turn on power again after warming your car interior.
Check Application	The Aha application is stopped.	Start the Aha application of the your device.
Please update your Aha application	The Aha application is an older version which the unit can not support.	Confirm that the Aha application is the latest version.

## SiriusXM

Check Tuner	A SiriusXM tuner is not connected to this unit.	Check that the connected SiriusXM Connect Vehicle Tuner is connected.
Subscription Updated - Press Return To Continue	The SiriusXM subscription has been renewed.	Pressing the Control knob will clear the error message.
Channel Not Available	The currently selected channel is unavailable.	—
Ch Unsubscribed	The currently selected channel is not subscribed to.	—
Check Antenna	No antenna is connected to the SiriusXM tuner.	Check that an antenna is connected to the SiriusXM tuner.
No Signal	No SiriusXM radio signal is received.	—

## Resetting the Unit

If the unit or the connected unit fails to operate properly, reset the unit.

### 1 Press the <Reset> button.

The unit returns to factory settings.

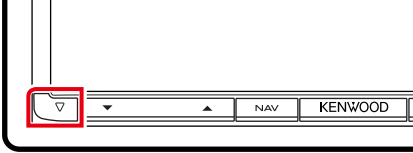

**DNX8** **DNX7**

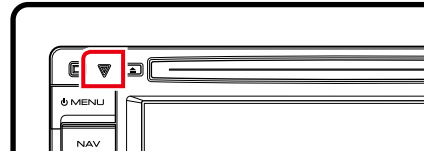

**DNX6** **DNX5**

#### NOTE

- Disconnect the USB device before pressing the <Reset> button. Pressing the <Reset> button with the USB device connected can damage the data stored in the USB device. For how to disconnect the USB device, see [How to Play Media \(P.13\)](#).
- When the unit is turned on after resetting, the Initial SETUP screen appears. See [Initial setup \(P.11\)](#).



# Appendix

## Playable Media and Files

You can play various kinds of media and files on this unit.

### List of playable discs

Disc types	Standard	Support	Remark
DVD	DVD Video	○	
	DVD Audio	×	
	DVD-VR	×	
	DVD-R*1	○	• MP3/WMA/AAC/MPEG1/MPEG2/DivX*2 playback • Multi-border/Multisession playback (Playback depends on authoring conditions)
	DVD-RW	○	
	DVD+R	○	
	DVD+RW	○	
	DVD-R DL (Dual layer)	○	Only video format
	DVD+R DL (Double layer)	○	
DVD-RAM	×		
CD	Music CD*1	○	CD-TEXT
	CD-ROM	○	• MP3/WMA/AAC/MPEG1/MPEG2 playback • Multisession is supported.
	CD-R	○	• Packet write is not supported.
	CD-RW	○	
	DTS-CD	×	
	Video CD (VCD)	○	
	Super video CD	×	
	Photo CD	×	
	CD-EXTRA	△	Only music CD session can be played.
	HDCD	○	
CCCD	×		
Others	Dualdisc	×	
	Super audio CD	△	Only CD layer can be played.

\*1 Incompatible with 8 cm (3 inch) discs.

\*2 Function of DNX891HD, DNX7710BT, DNX5710BT

○ : Playback is possible.

△ : Playback is partly possible.

×

 : Playback is impossible.

#### NOTE

- When buying DRM enabled contents, check the Registration Code in the [DivX\(R\) VOD \(P.57\)](#). Each time a file with the displayed code is played and protected against copying, the code changes.
- DivX can be played only from a DVD disc media.

## ■ Use of DualDisc

When playing a "DualDisc" on this unit, the surface of the disc that is not played may be scratched while the disc is inserted or ejected. Since the music CD surface does not conform to the CD standard, playback may be impossible.

(A "DualDisc" is a disc with one surface containing DVD standard signals and the other surface containing music CD signals.)

## ■ About disc format

The disc format should be the one of the following.

- ISO 9660 Level 1/2
- Joliet
- Romeo
- Long file name

## About files

**The following audio, video, and picture files are supported.**

### ■ Audio files

- AAC-LC (.m4a)
- MP3 (.mp3)
- WMA (.wma)
- Linear PCM (WAVE) (.wav)  
Mass-storage-class USB device only
- FLAC (.flac)  
Mass-storage-class USB device only

#### NOTE

- If music of normal CD and other playback systems are recorded in the same disc, only the playback system recorded at the first setout is played.
- WMA and AAC of which is covered with DRM cannot be played.
- Although the audio files are complied with the standards listed above, the play may be impossible depending on the types or conditions of media or device.
- An online manual about audio files is put on the site, [www.kenwood.com/cs/ce/audiofile/](http://www.kenwood.com/cs/ce/audiofile/). On this online manual, detailed information and notes which are not written in this manual are provided. Make sure to read through the online manual as well.

### ■ Video files

- MPEG1 (.mpg, .mpeg, .m1v\*)  
\*Mass-storage-class USB device only
- MPEG2 (.mpg, .mpeg, .m2v\*)  
\*Mass-storage-class USB device only
- DivX (.divx, .div, .avi)  
Function of DNX891HD, DNX7710BT, DNX5710BT  
DVD only
- H.264/MPEG-4 AVC (.mp4, .m4v)  
Mass-storage-class USB device only
- WMV 9 (.wmv, .m2ts)  
Mass-storage-class USB device only

### ■ Picture files

Only picture files in USB device can be displayed.

Files stored in disc media is not supported.

- JPEG (.jpg, .jpeg)
- PNG (.png)
- BMP (.bmp)

#### NOTE

- BMP and PNG can be set only as wallpaper.

### ■ Playing order of files

In the example of folder/file tree shown below, the files are played in the order from ① to ⑩.

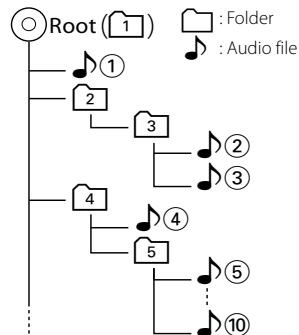

## Connectable iPod/iPhone

The following models can be connected to this unit.

Made for

- iPhone 5
- iPhone 4S
- iPhone 4
- iPhone 3GS
- iPhone 3G
- iPhone
- iPod touch (5th generation)
- iPod touch (4th generation)
- iPod touch (3rd generation)
- iPod touch (2nd generation)
- iPod touch (1st generation)
- iPod classic
- iPod with video
- iPod nano (7th generation)
- iPod nano (6th generation)
- iPod nano (5th generation)
- iPod nano (4th generation)
- iPod nano (3rd generation)

### NOTE

- For the details of the necessary cable and adapter to connect with iPod/iPhone, refer to [Music/Video/Picture Basic Operation \(P.32\)](#).
- For the conformity information on iPod/iPhone software, access [www.kenwood.com/cs/ce/ipod/](http://www.kenwood.com/cs/ce/ipod/).
- By connecting your iPod/iPhone to this unit with an optional accessory iPod connection cable KCA-iP202 or KCA-iP102, you can supply power to your iPod/iPhone as well as charge it while playing music. However, the power of this unit must be on.
- If you start playback after connecting the iPod, the music that has been played by the iPod is played first.  
In this case, "Reading" is displayed without displaying a folder name, etc. Changing the browse item will display a correct title, etc.
- When the iPod is connected to this unit, "KENWOOD" or "✓" is displayed on the iPod to indicate that you cannot operate the iPod.

## Usable USB device

You can use a mass-storage-class USB device on this unit.

The word "USB device" appearing in this manual indicates a flash memory device and digital audio players can be recognized as mass-storage.

### About file system

The file system should be the one of the following.

- FAT16
- FAT32

### NOTE

- When the USB device is connected to this unit, it can be charged through the USB cable.
- Install the USB device in the place where it will not affect safe driving.
- You cannot connect a USB device via a USB hub and Multi Card Reader.
- Take backups of the audio files used with this unit. The files can be erased depending on the operating conditions of the USB device. We shall have no compensation for any damage arising from any erased data.
- No USB device comes with this unit. You need to purchase a commercially available USB device.
- When connecting the USB device, usage of the CA-U1EX (option) is recommended. (However, maximum supply current of CA-U1EX is 500mA.) Normal playback is not guaranteed when a cable other than the USB compatible cable is used.



## Status Bar Indicator Items

Shown below is a list of indicators displayed on the status bar in the screen.

Current status of this unit is displayed on the bar.



**Status bar**

### ■ General

#### **ATT**

The attenuator is active.

#### **DUAL**

The dual zone function is on.

#### **TEL**

Indicates the connection state of the Bluetooth hands-free unit.

- White: Connected
- Orange: Not connected

#### **MUTE**

The mute function is active.

#### **LOUD DNX6 DNX5**

The loudness control function is on.

### ■ DVD/CD

#### **FO-REP**

Folder repeat function is on.

#### **IN**

A disc is inserted.

- White: A Disc is inside the unit.
- Orange: Error at the disc player

#### **VIDEO**

Identifies the video file.

#### **MUSIC**

Identifies the music file.

#### **RDM**

The random function is on.

#### **REP**

The repeat function is on.

### **C-REP**

The chapter repeat function is on.

### **T-REP**

The title repeat function is on.

### ■ VCD

#### **1chLL/2chLL**

Identifies the left audio output of channel 1 or 2.

#### **1chLR/2chLR**

Identifies the monaural audio output of channel 1 or 2.

#### **1chRR/2chRR**

Identifies the right audio output of channel 1 or 2.

#### **1chST/2chST**

Identifies the stereo audio output of channel 1 or 2.

#### **LL**

Identifies the left audio output.

#### **LR**

Identifies the monaural audio output.

#### **RR**

Identifies the right audio output.

#### **STEREO**

Identifies the stereo audio output.

#### **PBC**

The PBC function is on.

#### **SVCD**

Identifies the Super Video CD.

#### **VER1**

The VCD version is 1.

#### **VER2**

The VCD version is 2.

#### **REP**

The repeat function is on.

### ■ USB

#### **FO-REP**

The folder repeat function is on.

#### **VIDEO**

Identifies the video file.

#### **MUSIC**

Identifies the music file.

#### **PICTURE**

Identifies the picture file.

#### **RDM**

The random function is on.

#### **REP**

The repeat function is on.

#### **PLST**

The play list mode is selected now.

### ■ iPod

#### **MUSIC**

Identifies the music file.

#### **VIDEO**

Identifies the video file.

#### **RDM**

The random function is on.

#### **A-RDM**

The album random function is on.

#### **REP**

The repeat function is on.

### ■ Tuner

#### **AUTO1**

Seek mode is set to AUTO1.

#### **AUTO2**

Seek mode is set to AUTO2.

#### **MANUAL**

Seek mode is set to MANUAL.

#### **ST**

A stereo broadcast is being received.

#### **TI**

Indicates the reception state of traffic information.

- White: TP is being received.
- Orange: TP is not being received.

### ■ HD Radio reception

#### **AUTO1**

Seek mode is set to AUTO1.

#### **AUTO2**

Seek mode is set to AUTO2.

#### **MANUAL**

Seek mode is set to MANUAL.

#### **HD**

HD Radio station is being received.

#### **M/S**

A multicast digital broadcast is being received.

#### **ANALOG**

An analog broadcast is being received.

#### **DIGITAL**

A digital broadcast is being received.

#### **ST**

A stereo broadcast is being received.

### ■ SiriusXM

#### **SEEK1**

Seek mode is set to SEEK1.

#### **SEEK2**

Seek mode is set to SEEK2.



## DVD Language Codes

Code	Language
aa	Afar
ab	Abkhazian
af	Afrikaans
am	Amharic
ar	Arabic
as	Assamese
ay	Aymara
az	Azerbaijani
ba	Bashkir
be	Byelorussian
bg	Bulgarian
bh	Bihari
bi	Bislama
bn	Bengali, Bangla
bo	Tibetan
br	Breton
ca	Catalan
co	Corsican
cs	Czech
cy	Welsh
da	Danish
de	German
dz	Bhutani
el	Greek
en	English
eo	Esperanto
es	Spanish
et	Estonian
eu	Basque
fa	Persian
fi	Finnish
fj	Fiji
fo	Faroese
fr	French
fy	Frisian
ga	Irish
gd	Scots Gaelic
gl	Galician
gn	Guarani
gu	Gujarati
ha	Hausa
he	Hebrew
hi	Hindi
hr	Croatian
hu	Hungarian
hy	Armenian

Code	Language
ia	Interlingua
ie	Interlingue
ik	Inupiak
id	Indonesian
is	Icelandic
it	Italian
ja	Japanese
jav	Javanese
ka	Georgian
kk	Kazakh
kl	Greenlandic
km	Cambodian
kn	Kannada
ko	Korean
ks	Kashmiri
ku	Kurdish
ky	Kirghiz
la	Latin
lb	Luxembourgish
ln	Lingala
lo	Laotian
lt	Lithuanian
lv	Latvian, Lettish
mg	Malagasy
mi	Maori
mk	Macedonian
ml	Malayalam
mn	Mongolian
mo	Moldavian
mr	Marathi
ms	Malay
mt	Maltese
my	Burmese
na	Nauru
ne	Nepali
nl	Dutch
no	Norwegian
oc	Occitan
om	(Afan) Oromo
or	Oriya
pa	Punjabi
pl	Polish
ps	Pashto, Pushto
pt	Portuguese
qu	Quechua
rm	Rhaeto-Romance

Code	Language
rn	Kirundi
ro	Romanian
ru	Russian
rw	Kinyarwanda
sa	Sanskrit
sd	Sindhi
sg	Sangho
sh	Serbo-Croatian
si	Singhalese
sk	Slovak
sl	Slovenian
sm	Samoaan
sn	Shona
so	Somali
sq	Albanian
sr	Serbian
ss	Siswati
st	Sesotho
su	Sundanese
sv	Swedish
sw	Swahili
ta	Tamil
te	Telugu
tg	Tajik
th	Thai
ti	Tigrinya
tk	Turkmen
tl	Tagalog
tn	Setswana
to	Tongan
tr	Turkish
ts	Tsonga
tt	Tatar
tw	Twí
uk	Ukrainian
ur	Urdu
uz	Uzbek
vi	Vietnamese
vo	Volapuk
wo	Wolof
xh	Xhosa
yo	Yoruba
zh	Chinese
zu	Zulu



## Specifications

### ■ Monitor section

#### Picture Size

- DNX891HD, DNX7710BT, DNX771HD
- : 6.95 inches (diagonal) wide
- : 156.6 mm (W) x 81.6 mm (H)
- 6-3/16 x 3-3/16 inch
- DNX691HD, DNX571HD, DNX571EX, DNX5710BT
- : 6.1 inches (diagonal) wide
- : 136.2 mm (W) x 72.0 mm (H)
- 5-6/16 x 2-13/16 inch

#### Display System

- : Transparent TN LCD panel

#### Drive System

- : TFT active matrix system

#### Number of Pixels

- : 1,152,000 (800H x 480V x RGB)

#### Effective Pixels

- : 99.99 %

#### Pixel Arrangement

- : RGB striped arrangement

#### Back Lighting

- : LED

### ■ DVD player section

#### D/A Converter

- : 24 bit

#### Audio Decoder

- : Linear PCM/ Dolby Digital/ MP3/ WMA/ AAC

#### Video Decoder

- : MPEG1/ MPEG2/ DivX (DNX891HD/ DNX7710BT/ DNX5710BT only)

#### Wow & Flutter

- : Below Measurable Limit

#### Frequency Response

- 96 kHz : 20 – 20,000 Hz
- 48 kHz : 20 – 20,000 Hz
- 44.1 kHz : 20 – 20,000 Hz

#### Total Harmonic Distortion

- DNX891HD, DNX7710BT
- : 0.008 % (1 kHz)
- DNX771HD, DNX691HD, DNX571HD, DNX571EX, DNX5710BT
- : 0.010 % (1 kHz)

#### S/N Ratio (dB)

- DNX891HD, DNX7710BT
- : 100 dB (DVD-Video 96 kHz)
- DNX771HD, DNX691HD, DNX571HD, DNX571EX, DNX5710BT
- : 98 dB (DVD-Video 96 kHz)

#### Dynamic Range

- DNX891HD, DNX7710BT
- : 100 dB (DVD-Video 96 kHz)
- DNX771HD, DNX691HD, DNX571HD, DNX571EX, DNX5710BT
- : 98 dB (DVD-Video 96 kHz)

#### Disc Format

- : DVD-Video/ VIDEO-CD/ CD-DA

#### Sampling Frequency

- : 44.1/ 48/ 96 kHz

#### Quantifying Bit Number

- : 16/ 20/ 24 bit

### ■ USB interface section



#### USB Standard

- DNX891HD, DNX7710BT
- : USB 2.0 Full/ High Speed
- DNX771HD, DNX691HD, DNX571HD, DNX571EX, DNX5710BT
- : USB 2.0 High Speed

#### File System

- : FAT 16/ 32

#### Maximum Power Supply Current

- DNX891HD, DNX7710BT
- iPod/iPhone: DC 5 V  1 A
- USB: DC 5 V  500 mA
- DNX771HD, DNX691HD, DNX571HD, DNX571EX, DNX5710BT
- : DC 5 V  1 A

#### D/A Converter

- : 24 Bit

#### Audio Decoder

- : MP3/ WMA/ AAC/ WAV/ FLAC

#### Video Decoder

- : MPEG1/ MPEG2/ MPEG4/ WMV/ H.264

### ■ Bluetooth section

#### Technology

- : Bluetooth Ver.3.0+EDR

#### Frequency

- : 2.402 – 2.480 GHz

#### Output Power

- : +4dBm (MAX), 0dBm (AVE), Power Class2

#### Maximum Communication range

- : Line of sight approx. 10m (32.8 ft)

#### Audio Codec

- SBC/ AAC/ MP3/ aptX (DNX891HD, DNX7710BT only)

## Profile

- HFP (V1.6) (Hands Free Profile)
- SPP (Serial Port Profile)
- SDP (Service Discovery Profile)
- A2DP (Advanced Audio Distribution Profile)
- AVRCP (V1.4) (Audio/Video Remote Control Profile)
- PBAP (Phonebook Access Profile)
- GAP (Generic Access Profile)
- Multi Profile support

## ■ HDMI/ MHL section

### HDMI

: HDMI Type-A

### MHL Supported Version

: MHL 2

### MHL Maximum Power Supply Current

: DC 5 V  900 mA

## ■ DSP section

### Graphics equalizer

DNX891HD, DNX7710BT, DNX691HD

Band: 13 Band

Frequency (BAND1 – 13)

: 62.5/ 100/ 160/ 250/ 400/ 630/ 1k/ 1.6k/ 2.5k/ 4k/  
6.3k/ 10k/ 16k Hz

DNX771HD, DNX571HD, DNX571EX, DNX5710BT

Band: 7 Band

Frequency (BAND1 – 7)

: 62.5/ 160/ 400/ 1k/ 2.5k/ 6.3k/ 16k Hz

### Gain

: -9/-8/-7/-6/-5/-4/-3/-2/-1/0/1/2/3/4/5/6/7/8/9 dB

### 2Way X'Over

DNX891HD, DNX7710BT, DNX691HD

#### High pass filter

Frequency: Through, 30/ 40/ 50/ 60/ 70/ 80/ 90/ 100/  
120/ 150 / 180/ 220/ 250 Hz

Slope: -6/-12/-18/-24 dB/Oct.

#### Low pass filter

Frequency: 30/ 40/ 50/ 60/ 70/ 80/ 90/ 100/ 120/  
150/ 180/ 220/ 250 Hz, Through

Slope: -6/-12/-18/-24 dB/Oct.

DNX771HD, DNX571HD, DNX571EX, DNX5710BT

#### High pass filter

Frequency: Through, 50/ 60/ 80/ 100/ 120/ 150/ 180/  
220 Hz

Slope: -6/-12/-18/-24 dB/Oct.

#### Low pass filter

Frequency: 50/ 60/ 80/ 100/ 120/ 150/ 180/ 220 Hz,  
Through

Slope: -6/-12/-18/-24 dB/Oct.

### Position

#### Front / Rear /Subwoofer Delay

: 0 – 20.0ft (0.07ft Step)

#### Gain

: -8 – 0 dB

### Subwoofer level

: -50 – +10 dB

## ■ Digital FM tuner section (DNX891HD, DNX771HD, DNX691HD, DNX571HD, DNX571EX)

### Frequency Range (step)

: 87.9 MHz – 107.9 MHz (200 kHz)

### Frequency Response (± 3.0 dB)

: 20 Hz – 20 kHz

### S/N Ratio

: 75 dB (STEREO)

## ■ Digital AM tuner section (DNX891HD, DNX771HD, DNX691HD, DNX571HD, DNX571EX)

### Frequency Range (step)

: 530 kHz – 1700 kHz (10 kHz)

### Frequency Response (± 3.0 dB)

: 40 Hz – 15 kHz

### S/N Ratio (dB)

: 75 dB (STEREO)

## ■ FM tuner section

### Frequency Range (step)

DNX891HD, DNX771HD, DNX691HD, DNX571HD,  
DNX571EX

: 87.9 MHz – 107.9 MHz (200 kHz)

DNX7710BT, DNX5710BT

: 87.5 MHz – 108.0 MHz (50 kHz)

### Usable Sensitivity

DNX891HD, DNX771HD, DNX691HD, DNX571HD,  
DNX571EX (S/N : 30 dB)

: 7.2 dBf (0.8 μV/ 75 Ω)

DNX7710BT, DNX5710BT (S/N : 26 dB)

: 0.63 μV/ 75 Ω

### Quieting Sensitivity (S/N : 50 dB)

DNX891HD, DNX771HD, DNX691HD, DNX571HD,  
DNX571EX (S/N : 50 dB)

: 10.2 dBf (1.13 μV/ 75 Ω)

DNX7710BT, DNX5710BT (S/N : 46 dB)

: 15.2 dBf (1.6 μV/ 75 Ω)

### Frequency Response (± 3.0 dB)

: 30 Hz – 15 kHz

### S/N Ratio (dB)

: 75 dB (MONO)

### Selectivity (± 400 kHz)

: Over 80 dB

### Stereo Separation

: 45 dB (1 kHz)

## ■ AM tuner section

### Frequency Range (step)

: 530 kHz – 1700 kHz (10 kHz)

### Usable Sensitivity

: 28 dB $\mu$

## ■ Video section

### Color System of External Video Input

: NTSC/PAL

### External Video Input Level (RCA jack)

: 1 Vp-p/ 75  $\Omega$

### External Audio Max Input Level (RCA/mini jack)

: 2 V/ 25 k $\Omega$

### Video Input Level (RCA jacks)

: 1 Vp-p/ 75  $\Omega$

### Video Output Level (RCA jacks)

: 1 Vp-p/ 75  $\Omega$

### Audio Output Level (RCA jacks)

: 1.2 V/ 10 k $\Omega$

## ■ Audio section

### Maximum Power (Front & Rear)

: 50 W x 4

### Full Bandwidth Power (Front & Rear) (4 $\Omega$ , 14.4 V, 1 % THD)

: 22 W x 4

### Preout Level (V)

DNX891HD, DNX7710BT, DNX691HD

: 5 V/ 10 k $\Omega$

DNX771HD, DNX571HD, DNX571EX, DNX5710BT

: 2 V/ 10 k $\Omega$

### Preout Impedance

DNX891HD, DNX7710BT, DNX691HD

:  $\leq$  80  $\Omega$

DNX771HD, DNX571HD, DNX571EX, DNX5710BT

:  $\leq$  600  $\Omega$

### Speaker Impedance

: 4 – 8  $\Omega$

## ■ External SW (DNX891HD, DNX7710BT)

### Maximum Power Supply Current

: 500 mA

## ■ Navigation section

### Receiver

: High-sensitivity GPS receiver

### Reception Frequency

: 1575.42 MHz (C/A code)

### Acquisition Times

Cold : 26 seconds (typ)

(All satellites at -130 dBm Without aiding)

### Update Rate

: 1/Second, continuous

### Accuracy

Position: <2.5 meters, CEP, at -130 dBm

Velocity: 0.1 meter/sec

### Position Method

: GPS

### Antenna

: External GPS antenna

## ■ General

### Operating Voltage

: 14.4 V (10.5 – 16 V allowable)

### Maximum Current Consumption

: 10 A

### Installation Dimensions (W x H x D)

DNX891HD, DNX7710BT, DNX771HD

: 181.7 x 112.2 x 163.0 mm

7-2/16 x 4-6/16 x 6-7/16 inch

DNX691HD, DNX571HD, DNX571EX, DNX5710BT

: 181.7 x 112.2 x 160.3 mm

7-2/16 x 4-6/16 x 6-5/16 inch

### Operational Temperature Range

: -10  $^{\circ}$ C – +60  $^{\circ}$ C

### Weight

DNX891HD, DNX7710BT, DNX771HD

: 2.5 kg (5.4 lbs)

DNX691HD, DNX571HD, DNX571EX, DNX5710BT

: 2.0 kg (4.4 lbs)

### NOTE

- Although the effective pixels for the liquid crystal panel is given as 99.99% or more, 0.01% of pixels may not light or may light incorrectly.

**Specifications subject to change without notice.**

## About this Unit

### ■ Copyrights

- The Bluetooth word mark and logos are owned by the Bluetooth SIG, Inc. and any use of such marks by JVC KENWOOD Corporation is under license. Other trademarks and trade names are those of their respective owners.
- The “AAC” logo is a trademark of Dolby Laboratories.
- “Made for iPod” and “Made for iPhone” mean that an electronic accessory has been designed to connect specifically to iPod or iPhone, respectively, and has been certified by the developer to meet Apple performance standards. Apple is not responsible for the operation of this device or its compliance with safety and regulatory standards. Please note that the use of this accessory with iPod, iPhone, or iPad may affect wireless performance.
- iPhone, iPod, iPod classic, iPod nano, and iPod touch are trademarks of Apple Inc., registered in the U.S. and other countries.
- Sirius, XM and all related marks and logos are trademarks of Sirius XM Radio Inc. All rights reserved.
- HD Radio Technology manufactured under license from iBiquity Digital Corporation. U.S. and Foreign Patents. HD Radio™ and the HD, HD Radio, and “Arc” logos are proprietary trademarks of iBiquity Digital Corp.
-  is a trademark of DVD Format/Logo Licensing Corporation registered in the U.S., Japan and other countries.
- This item incorporates copy protection technology that is protected by U.S. patents and other intellectual property rights of Rovi Corporation. Reverse engineering and disassembly are prohibited.
- Manufactured under license from Dolby Laboratories. Dolby and the double-D symbol are trademarks of Dolby Laboratories.
- Android is a trademark of Google Inc.
- BlackBerry®, RIM®, Research In Motion® and related trademarks, names and logos are the property of Research In Motion Limited and are registered and/or used in the U.S. and countries around the world. Used under license from Research In Motion Limited.
- Adobe, Acrobat and Reader are either registered trademarks or trademarks of Adobe Systems Incorporated in the United States and/or other countries.
- QR Code ® is registered trademarks of DENSO WAVE INCORPORATED in JAPAN and other countries.
- The aptX® software is copyright CSR plc or its group companies. All rights reserved. The aptX® mark and the aptX logo are trade marks of CSR plc or one of its group companies and may be registered in one or more jurisdictions.
- ABOUT DIVX VIDEO: DivX® is a digital video format created by DivX, LLC, a subsidiary of Rovi Corporation. This is an official DivX Certified® device that plays DivX video. Visit [divx.com](http://divx.com) for more information and software tools to convert your files into DivX videos.
- ABOUT DIVX VIDEO-ON-DEMAND: This DivX Certified® device must be registered in order to play purchased DivX Video-on-Demand (VOD) movies. To obtain your registration code, locate the DivX VOD section in your device setup menu. Go to [vod.divx.com](http://vod.divx.com) for more information on how to complete your registration.
- DivX®, DivX Certified® and associated logos are trademarks of Rovi Corporation or its subsidiaries and are used under license.
- The terms HDMI and HDMI High-Definition Multimedia Interface, and the HDMI logo are trademarks or registered trademarks of HDMI Licensing LLC in the United States and other countries.
- MHL and the MHL logo are a trademark or registered trademark of MHL, LLC.  
- Incorporates MHL 2
- THIS PRODUCT IS LICENSED UNDER THE AVC PATENT PORTFOLIO LICENSE FOR THE PERSONAL USE OF A CONSUMER OR OTHER USES IN WHICH IT DOES NOT RECEIVE REMUNERATION TO (i) ENCODE VIDEO IN COMPLIANCE WITH THE AVC STANDARD (“AVC VIDEO”) AND/OR (ii) DECODE AVC VIDEO THAT WAS ENCODED BY A CONSUMER ENGAGED IN A PERSONAL ACTIVITY AND/OR WAS OBTAINED FROM A VIDEO PROVIDER LICENSED TO PROVIDE AVC VIDEO. NO LICENSE IS GRANTED OR SHALL BE IMPLIED FOR ANY OTHER USE. ADDITIONAL INFORMATION MAY BE OBTAINED FROM MPEG LA, L.L.C. SEE [HTTP://WWW.MPEGLA.COM](http://www.mpegla.com)
- THIS PRODUCT IS LICENSED UNDER THE MPEG-4 VISUAL PATENT PORTFOLIO LICENSE FOR THE PERSONAL AND NON-COMMERCIAL USE OF A CONSUMER FOR (i) ENCODING VIDEO IN COMPLIANCE WITH THE MPEG-4 VISUAL STANDARD (“MPEG-4 VIDEO”) AND/OR (ii) DECODING MPEG-4 VIDEO THAT WAS ENCODED BY A CONSUMER ENGAGED IN A PERSONAL AND NON-COMMERCIAL ACTIVITY AND/OR WAS OBTAINED FROM A VIDEO PROVIDER LICENSED BY MPEG LA TO PROVIDE MPEG-4 VIDEO. NO LICENSE IS GRANTED OR SHALL BE IMPLIED FOR ANY OTHER USE. ADDITIONAL INFORMATION INCLUDING THAT RELATING TO PROMOTIONAL, INTERNAL AND COMMERCIAL USES AND LICENSING MAY BE OBTAINED FROM MPEG LA, LLC. SEE [HTTP://WWW.MPEGLA.COM](http://www.mpegla.com).

• libFLAC

Copyright (C) 2000,2001,2002,2003,2004,2005,2006,2007,2008,2009 Josh Coalson

Redistribution and use in source and binary forms, with or without modification, are permitted provided that the following conditions are met:

- Redistributions of source code must retain the above copyright notice, this list of conditions and the following disclaimer.

- Redistributions in binary form must reproduce the above copyright notice, this list of conditions and the following disclaimer in the documentation and/or other materials provided with the distribution.

- Neither the name of the Xiph.org Foundation nor the names of its contributors may be used to endorse or promote products derived from this software without specific prior written permission.

THIS SOFTWARE IS PROVIDED BY THE COPYRIGHT HOLDERS AND CONTRIBUTORS "AS IS" AND ANY EXPRESS OR IMPLIED WARRANTIES, INCLUDING, BUT NOT LIMITED TO, THE IMPLIED WARRANTIES OF MERCHANTABILITY AND FITNESS FOR A PARTICULAR PURPOSE ARE DISCLAIMED. IN NO EVENT SHALL THE FOUNDATION OR CONTRIBUTORS BE LIABLE FOR ANY DIRECT, INDIRECT, INCIDENTAL, SPECIAL, EXEMPLARY, OR CONSEQUENTIAL DAMAGES (INCLUDING, BUT NOT LIMITED TO, PROCUREMENT OF SUBSTITUTE GOODS OR SERVICES; LOSS OF USE, DATA, OR PROFITS; OR BUSINESS INTERRUPTION) HOWEVER CAUSED AND ON ANY THEORY OF LIABILITY, WHETHER IN CONTRACT, STRICT LIABILITY, OR TORT (INCLUDING NEGLIGENCE OR OTHERWISE) ARISING IN ANY WAY OUT OF THE USE OF THIS SOFTWARE, EVEN IF ADVISED OF THE POSSIBILITY OF SUCH DAMAGE.

• **About Pandora®:**

Requirements for listening to the Pandora® are as follows:

**iPhone or iPod touch**

- Use an Apple iPhone or iPod touch running under iOS3 or later.
- Search for "Pandora" in the Apple App Store to find and install the most current version of the Pandora® application on your device.

**Android™**

- Visit the Google play and search for Pandora to install.

**BlackBerry®**

- Visit [www.pandora.com](http://www.pandora.com) from the built in browser to download the Pandora application.
- Bluetooth must be built in and the following profiles must be supported.
  - SPP (Serial Port Profile)
  - A2DP (Advanced Audio Distribution Profile)

**NOTE**

- In the application on your device, log in and create an account with Pandora.
- (If you are not already a registered user, an account can also be created at [www.pandora.com](http://www.pandora.com).)
- Internet connection by LTE, 3G, EDGE, or WiFi.
- Pandora® is only available in the United States, Australia, and New Zealand.
- Because Pandora® is a third-party service, the specifications are subject to change without prior notice. Accordingly, compatibility may be impaired or some or all of the services may become unavailable.
- Some functions of Pandora® cannot be operated from this unit.
- For issues using the application, please contact Pandora® at [pandora-support@pandora.com](mailto:pandora-support@pandora.com).

• **About iHeartRadio®:**

Requirements for using iHeartAuto™ are as follows:

**iPhone or iPod touch**

- Use an Apple iPhone or iPod touch running iOS or later.
- Search for “iHeartAuto” in the Apple App Store to find and install the most current version of the iHeartAuto™ application on your device.

**Android™**

- Use an Android device with firmware 2.2 or later.
- Search for “iHeartAuto” on Google play to find and install the most current version of the iHeartAuto™ application on your device.

**Note**

- iHeartRadio® is available only in the United States and U.S. Territories
- For the best application experience, a 3G/4G or Wi-Fi connection is recommended.
- Because iHeartAuto™ is a third-party service, the specifications are subject to change without prior notice. Accordingly, compatibility may be impaired or some or all of the services may become unavailable.
- Some functions of iHeartRadio® cannot be operated from this unit.
- If you experience issues while using the application, please contact iHeartRadio® Customer Care at <http://help.iheartradio.com>.
- iHeartRadio® and iHeartAuto™ are trademarks owned by Clear Channel Broadcasting, Inc. All uses are authorized under license.

**DNX891HD/ DNX771HD/ DNX691HD/ DNX571HD/  
DNX571EX:**

**■ FCC WARNING**

This equipment may generate or use radio frequency energy. Changes or modifications to this equipment may cause harmful interference unless the modifications are expressly approved in the instruction manual. The user could lose the authority to operate this equipment if an unauthorized change or modification is made.

**NOTE**

This equipment has been tested and found to comply with the limits for a Class B digital device, pursuant to Part 15 of the FCC Rules. These limits are designed to provide reasonable protection against harmful interference in a residential installation.

This equipment may cause harmful interference to radio communications, if it is not installed and used in accordance with the instructions. However, there is no guarantee that interference will not occur in a particular installation. If this equipment does cause harmful interference to radio or television reception, which can be determined by turning the equipment off and on, the user is encouraged to try to correct the interference by one or more of the following measures:

- Reorient or relocate the receiving antenna.
- Increase the separation between the equipment and receiver.
- Connect the equipment into an outlet on a circuit different from that to which the receiver is connected.
- Consult the dealer or an experienced radio/TV technician for help.

**▲ CAUTION**

Use of controls or adjustments or performance of procedures other than those specified herein may result in hazardous radiation exposure.

In compliance with Federal Regulations, following are reproductions of labels on, or inside the product relating to laser product safety.

JVC KENWOOD Corporation  
2967-3, ISHIKAWA-MACHI,  
HACHIOJI-SHI, TOKYO, JAPAN

THIS PRODUCT COMPLIES WITH DHHS  
RULES 21 CFR SUBCHAPTER J IN EFFECT AT  
DATE OF MANUFACTURE.

Location: Top plate

**DNX891HD/ DNX771HD/ DNX691HD/ DNX571HD/  
DNX571EX:**

**■ IC (Industry Canada) Notice**

This device complies with Industry Canada licence-exempt RSS standard(s).

Operation is subject to the following two conditions:

- (1) This device may not cause interference, and
- (2) this device must accept any interference, including interference that may cause undesired operation of the device.

The term "IC:" before the certification/ registration number only signifies that the Industry Canada technical specification were met.

**▲ CAUTION**

This equipment complies with FCC/IC radiation exposure limits set forth for an uncontrolled environment and meets the FCC radio frequency (RF) Exposure Guidelines in Supplement C to OET65 and RSS-102 of the IC radio frequency (RF) Exposure rules. This equipment has very low levels of RF energy that it deemed to comply without maximum permissive exposure evaluation (MPE). But it is desirable that it should be installed and operated keeping the radiator at least 20cm or more away from person's body (excluding extremities: hands, wrists, feet and ankles).

Under Industry Canada regulations, this radio transmitter may only operate using an antenna of a type and maximum (or lesser) gain approved for the transmitter by Industry Canada. To reduce potential radio interference to other users, the antenna type and its gain should be so chosen that the equivalent isotropically radiated power (e.i.r.p.) is not more than that necessary for successful communication.

**DNX891HD/ DNX771HD/ DNX691HD/ DNX571HD/  
DNX571EX:**

- Contains Transmitter Module  
FCC ID: YZP-RBFAC21XX
- Contains Transmitter Module  
IC: 7414A-RBFAC21XX

## ■ CALIFORNIA, USA

This product contains a CR Coin Cell Lithium Battery which contains Perchlorate Material – special handling may apply.

See [www.dtsc.ca.gov/hazardouswaste/perchlorate](http://www.dtsc.ca.gov/hazardouswaste/perchlorate).

## ■ Información acerca de la eliminación de equipos eléctricos y electrónicos al final de la vida útil (aplicable a los países que hayan adoptado sistemas independientes de recogida de residuos)



Los productos con el símbolo de un contenedor con ruedas tachado no podrán ser desechados como residuos domésticos.

Los equipos eléctricos y electrónicos al final de la vida útil, deberán ser reciclados en instalaciones que puedan dar el tratamiento adecuado a estos productos y a sus subproductos residuales correspondientes. Póngase en contacto con su administración local para obtener información sobre el punto de recogida más cercano. Un tratamiento correcto del reciclaje y la eliminación de residuos ayuda a conservar los recursos y evita al mismo tiempo efectos perjudiciales en la salud y el medio ambiente.

## ■ Para cumplimiento de la COFETEL:

“La operación de este equipo esta sujeta a las siguientes dos condiciones:

(1) es posible que este equipo o dispositivo no cause interferencia perjudicial y

(2) este equipo o dispositivo debe aceptar cualquier interferencia,

incluyendo la que pueda causar su operación no deseada.”

## ■ Informação sobre a eliminação de pilhas

Este produto não deve ser eliminado como lixo doméstico geral. Devolva a pilha usada ao revendedor ou entidade autorizada para que a mesma seja devolvida ao fabricante ou importador.

A reciclagem e a eliminação de lixo de maneira apropriada ajudarão a conservar os recursos naturais ao mesmo tempo que prevenirão os efeitos prejudiciais à nossa saúde e ao meio ambiente.



**HDMI™**  
HIGH-DEFINITION MULTIMEDIA INTERFACE

**MHL™**  
Mobile High-Definition Link

**iHeartRADIO**

**SiriusXM**  
READY

Works With  
**PANDORA®**

**DOLBY**  
DIGITAL

**DIVX™**

**Bluetooth®**



**DVD**  
VIDEO™

Made for  
**iPod iPhone**

Designed for  
**Windows**  
Media™

**HD Radio®**

This HD Radio receiver enables:

PSD

HD2/HD3

Bookmark

Digital Sound

Artist Experience

---

**KENWOOD**

# KENWOOD

GPS NAVIGATION SYSTEM

**DNX891HD**

**DNX771HD**

**DNX691HD**

**DNX571HD**

**DNX571EX**

---

**GPS NAVIGATION  
INSTRUCTION MANUAL**

JVCKENWOOD Corporation

# Contents

## End-User License Agreements 4

## Getting Started 12

Using the Navigation System	12
Help When You Need It	12
Searching Help Topics	12
Status Bar Icons	12
Satellite Signals	13
Viewing GPS Satellite Signals	13
Using the On-Screen Buttons	13
Using the On-Screen Keyboard	13
Adding a Shortcut	13
Removing a Shortcut	13

## Finding Locations 14

Finding a Location by Category	14
Searching Within a Category	14
Finding a Location Using the Search Bar	14
Changing the Search Area	14
Finding Fuel Stations and Prices	15
Finding an Address	15
Finding a City	15
Finding an Intersection	15
Finding a Location Using Coordinates	16
Finding a Location by Browsing the Map	16
Find a Location Using Quick Search	16
Saving a Home Location	16
Going Home	17
Editing Your Home Location Information	17
Finding Recently Found Places	17
Clearing the List of Recently Found Places	17
Finding Parking	17
Setting a Simulated Location	17
Saving a Location	17
Saving Your Current Location	17
Starting a Route to a Saved Location	18
Editing a Saved Location	18
Assigning Categories to a Saved Location	18
Deleting a Saved Location	18

## Navigation 19

Starting a Route	19
Previewing Multiple Routes	19
Following a Route	19
Using the Navigation Map	19
Adding a Point to a Route	20
Taking a Detour	20
Stopping the Route	20
Using Suggested Routes	20
Using Exit Services	20
Finding Exit Services	20
Navigating to an Exit	21
Using Find Ahead	21
Avoiding Road Features	21
Adding a Custom Avoidance Area	21
Avoiding a Road	21
Disabling a Custom Avoidance	21
Deleting Custom Avoidances	22
Enabling Advanced Detours	22
Taking a Detour Around Specified Areas	22

## The Map Pages 23

Customizing the Map Layers	23
Viewing the Trip Log	23
Changing the Map Data Field	23
Changing the Map Perspective	23
Customizing Map Buttons	23
Removing Buttons from the Map	23
Viewing a List of Turns	24
Viewing the Entire Route on the Map	24
Viewing the Next Turn	24
Viewing Junctions	24
Viewing Traffic Alerts	24
Viewing Trip Information	24
Resetting Trip Information	25
Viewing Current Location Information	25
Finding Nearby Services	25
Directions to Your Current Location	25

**Using the Apps 26**

About Smartphone Link	26
Downloading Smartphone Link	26
Connecting to Smartphone Link	26
Sending a Location from Your Phone	26
Disabling Calls While Connected	26
About Garmin Live Services	27
Subscribing to Garmin Live Services	27
About ecoRoute	27
Creating a Vehicle Profile	27
Resetting Your Vehicle Profile	27
Calibrating Fuel Economy	27
Taking the ecoChallenge	28
About ecoChallenge Scores	28
Hiding Your ecoChallenge Score	28
Resetting Your Score	28
Viewing Your Fuel Economy	28
About the Mileage Report	28
Viewing a Mileage Report	28
Exporting a Mileage Report	29
Setting Routes that Use Less Fuel	29
Viewing myGarmin Messages	29
Viewing the Weather Forecast	29
Viewing Weather Near a Different City	29
Viewing the Weather Radar	29
Viewing Weather Alerts	30
Checking Road Conditions	30
Planning a Trip	30
Editing a Trip Itinerary	30
Navigating to a Saved Trip	30
Editing a Saved Trip	30
Using the World Clock	31
Viewing the World Map	31
Finding Parking	31

**Traffic Information 32**

Traffic Subscription Activation	32
Understanding Traffic	32
Traffic Data Using Smartphone Link	32
About the Traffic Icon	32
Traffic on Your Route	33
Viewing Traffic on Your Route	33
Manually Avoiding Traffic on Your Route	33
Taking an Alternate Route	33
Viewing Traffic on the Map	33
Searching for Traffic Delays	33
Viewing a Traffic Incident on the Map	33
Understanding Traffic Data	33
About Traffic Cameras	34
Saving a Traffic Camera	34
Viewing a Traffic Camera	34
Adding a Traffic Subscription	34

**Customizing the Settings 35**

Customizing the Navigation System	35
Changing the Map Settings	35
Enabling Maps	35
Changing the Navigation Settings	35
Adjusting the Display Settings	35
Route Preferences	35
Updating the Time Settings	36
Setting the Languages	36
Adding Security	36
Device and Privacy Settings	36
Restoring Settings	36

**Appendix 37**

Updating the Software	37
Updating the Map Data	37
Safety Cameras	37
Custom POIs (Points of Interest)	37
Finding Custom POIs	37

**Icons Used in This Manual**

Important precautions are described to prevent injuries and potentially dangerous situations.



Special instructions, supplementary explanations, limitations, and reference pages are described.

# End-User License Agreements

## Software License Agreement

---

BY USING THE DNX891HD / DNX771HD / DNX691HD / DNX571HD / DNX571EX, YOU AGREE TO BE BOUND BY THE TERMS AND CONDITIONS OF THE FOLLOWING SOFTWARE LICENSE AGREEMENT. PLEASE READ THIS AGREEMENT CAREFULLY.

Garmin Ltd. and its subsidiaries ("Garmin") grant you a limited license to use the software embedded in this device (the "Software") in binary executable form in the normal operation of the product. Title, ownership rights, and intellectual property rights in and to the Software remain in Garmin and/or its third-party providers.

You acknowledge that the Software is the property of Garmin and/or its third-party providers and is protected under the United States of America copyright laws and international copyright treaties. You further acknowledge that the structure, organization, and code of the Software, for which source code is not provided, are valuable trade secrets of Garmin and/or its third-party providers and that the Software in source code form remains a valuable trade secret of Garmin and/or its third-party providers. You agree not to decompile, disassemble, modify, reverse assemble, reverse engineer, or reduce to human readable form the Software or any part thereof or create any derivative works based on the Software. You agree not to export or re-export the Software to any country in violation of the export control laws of the United States of America or the export control laws of any other applicable country.

## End User License Agreement

---

The Garmin device you have purchased ("Device"), or the download that you are making (the "Download"), may contain an application, content, or both. If a Device, the software embedded in it (the "Software"), or if a Download, the application, including its embedded software (collectively, the "Application") is owned by Garmin Ltd. or its subsidiaries (collectively, "Garmin"). The map data that may be embedded in your Device, the Application or downloaded separately (the "Map Data") is owned by HERE North America LLC and/or its affiliates ("HERE") and is licensed to Garmin. Garmin also owns, or licenses from third party providers, information, traffic data, text, images, graphics, photographs, audio, video, images and other applications and data that may be embedded in the Device or Application, or downloaded separately ("Other Content"). The Map Data and Other Content are collectively the "Content". The Software, Application and Content (collectively, the "Garmin Products") are protected

under copyright laws and international copyright treaties. The Garmin Products are licensed, not sold. The structure, organization and code of the Software and Application are valuable trade secrets of Garmin and/or its third-party providers. The Garmin Products are each provided under this License Agreement and are subject to the following terms and conditions which are agreed to by End User ("you" or "your"), on the one hand, and Garmin and its licensors and affiliated companies of Garmin and its licensors, on the other hand. If you are obtaining the Application from a third party application vendor (the "Application Vendor"), you acknowledge that Garmin, and not the Application Vendor, is responsible for the Application. Garmin's licensors, including the licensors, service providers, channel partners, suppliers and affiliated companies of Garmin and its licensors, are each a direct and intended third party beneficiary of this Agreement and may enforce their rights directly against you in the event of your breach of this Agreement.

**IMPORTANT:** CAREFULLY READ THIS ENTIRE LICENSE AGREEMENT BEFORE PURCHASING OR USING YOUR DEVICE OR DOWNLOADED APPLICATION OR CONTENT. PURCHASING, INSTALLING, COPYING, OR OTHERWISE USING YOUR DEVICE OR DOWNLOADED APPLICATION OR CONTENT INDICATES YOUR ACKNOWLEDGMENT THAT YOU HAVE READ THIS LICENSE AGREEMENT AND AGREE TO ITS TERMS AND CONDITIONS. IF YOU DO NOT AGREE TO THESE TERMS AND CONDITIONS FOR YOUR PRODUCT, RETURN THE COMPLETE DEVICE WITHIN 7 DAYS OF THE DATE YOU ACQUIRED IT (IF PURCHASED NEW) FOR A FULL REFUND TO THE DEALER FROM WHICH YOU PURCHASED THIS DEVICE. IF YOU DO NOT AGREE TO THESE TERMS AND CONDITIONS FOR YOUR DOWNLOAD, DO NOT PURCHASE, INSTALL OR USE THE DOWNLOAD.

## License Terms and Conditions

Garmin ("we" or "us") provides you with the storage media containing the Software and the Content embedded therein, including any "online" or electronic documentation and printed materials in the case of a Device, or in the case of a Download, the Application and the embedded or accompanying Content, including any "online" or electronic documentation and printed materials. Garmin grants you a limited, non-exclusive license to use the applicable Garmin Product in accordance with the terms of this Agreement. You agree to use the applicable Garmin Product

for solely personal use, or if applicable, for use in your business' internal operations, and not for service bureau, time-sharing, resale or other similar purposes. Accordingly, but subject to the restrictions set forth in the following paragraphs, you may copy the applicable Garmin Product only as necessary for your use to (i) view it, and (ii) save it, provided that you do not remove any copyright notices that appear and do not modify the Garmin Product in any way. Your use of the Application must not violate any usage rules of the Application Vendor or any other third party service provider you use to enable the Application. You agree not to otherwise reproduce, archive, copy, modify, decompile, disassemble, reverse engineer or create derivative works of any portion of the Garmin Products, and may not transfer or distribute it in any form, for any purpose, except to the extent permitted by mandatory laws. Garmin also reserves the right to discontinue offering any Content supplied by any third party supplier if such supplier ceases to supply such content or Garmin's contract with such supplier terminates for any reason.

**Support.** If you purchased your Application from a third party application vendor and you need operational or technical support and assistance regarding the installation, un-installation, use or operation of the Application, or if you have questions, complaints or claims regarding the Application, contact Garmin at: [mobileapplications.support@garmin.com](mailto:mobileapplications.support@garmin.com).

**Acknowledgement of Application Vendor Responsibility.** If you purchased your Application from a third party application vendor, the Application Vendor shall have no maintenance or support obligation for the Application, nor any responsibility for addressing any claims from you or any third party regarding the possession or use of the Application, including without limitation product liability claims, claims of failure to meet legal or regulatory requirements or consumer protection laws claims. Further, the Application Vendor shall have no responsibility regarding third party claims of intellectual property rights violations as a result of your possession or use of the Application.

**Restrictions.** Except where you have been specifically licensed to do so by Garmin, and without limiting the preceding paragraphs, you may not use the Garmin Products with any products, systems, or applications installed or

otherwise connected to or in communication with vehicles, and which are capable of dispatch, fleet management or similar applications where the Content is used by a central control center in dispatching a fleet of vehicles. In addition, you are prohibited from renting or leasing the Garmin Products to any other person or third party. Only those rental car companies that are specifically authorized by Garmin in writing to rent Garmin products containing the Content to their rental customers are permitted to rent out such products.

You agree to be fully responsible for your own conduct and content while using the Software and for any consequences thereof. You agree to use the Software only for purposes that are legal, proper and in accordance with this Agreement and any applicable policies or guidelines. By way of example, and not as a limitation, you agree that when using the Software, You will not:

- upload, post, email or transmit or otherwise make available content that infringes any patent, trademark, copyright, trade secret or other proprietary right of any party, unless you are the owner of the rights or have the permission of the owner to post such Content;
- use the Software or other content for any illegal or unauthorized purpose; or
- transmit any viruses, worms, defects, Trojan horses, or any items of a destructive nature.

In the event that you are located outside of the United States, you agree to comply with any laws, rules or regulations in your locale or in the location of your web server regarding online conduct and acceptable content, including laws regulating the export of data to the United States or your country of residence.

**Data Transfer.** Certain services in connection with the Application may result in a transfer of data from your device. In that case, additional charges for data transfer may arise, depending on your device data plan. Please contact your data provider for details about any additional charges.

**Garmin Live Services.** Garmin may provide to you services known as "Garmin Live" services. Garmin Live services may be a "one-time" Live services purchase or a purchase for a specific term. If a "one-time" purchase is made, purchasers of that service will receive Garmin Live services for the (i) useful life of the purchaser's Garmin device,

(ii) the useful life of the purchaser's smartphone (if applicable), or (iii) as long as Garmin receives Content from its third party content supplier, whichever of the three periods is shortest. A Garmin device's "useful life" means the period during which the device (a) has the required technical capabilities to utilize the then-current Live services (including a Live services-compatible operating system) and (b) is capable of operating as intended without major repairs. A Garmin device will be deemed to be out of service and its useful life to be ended if no updates have been downloaded for such device for a period of 24 months or more. Garmin Live services content is not available for all areas. Garmin may terminate a Live services subscription immediately for violations of the Live services terms of use. Live services subscriptions may not be transferred to another person or another Garmin product, even if the application remains on the smartphone. Garmin Live Services are in part - depending on the service - geographically restricted to the reception and transmission range of the radio transmitters, operated by the respective network operators. They can be affected by atmospheric conditions, topographical conditions, the vehicles location or position as well as obstacles (for example bridges and buildings). Some services are generally not available in every country. The extent and characteristics of the available services differ from country to country. You are personally responsible for the compliance with the laws and regulations of the respective countries.

**No Warranty.** The Garmin Products are provided to you "as is," and you agree to use them at your own risk. Garmin and its licensors including the licensors, service providers, channel partners and suppliers, and affiliated companies of Garmin and its licensors, make no guarantees, representations or warranties of any kind, express or implied, arising by law or otherwise, including but not limited to, content, quality, accuracy, completeness, effectiveness, reliability, merchantability, fitness for a particular purpose, usefulness, use or results to be obtained from the Garmin Products, or that the Content or server will be uninterrupted or error-free. The Garmin Products are intended to be used only as supplementary travel aids and must not be used for any purpose requiring precise measurement of direction, distance, location or topography. GARMIN MAKES NO WARRANTY AS TO THE ACCURACY OR COMPLETENESS OF THE MAP DATA OR OTHER CONTENT.

**Disclaimer of Warranty.** GARMIN AND ITS

LICENSORS, including the licensors, service providers, channel partners, suppliers and affiliated companies of Garmin and its licensors, DISCLAIM ANY WARRANTIES, EXPRESS OR IMPLIED, OF QUALITY, PERFORMANCE, MERCHANTABILITY, FITNESS FOR A PARTICULAR PURPOSE OR NONINFRINGEMENT. NO ORAL OR WRITTEN ADVICE OR INFORMATION PROVIDED BY GARMIN OR ITS SUPPLIERS AND LICENSORS SHALL CREATE A WARRANTY, AND YOU ARE NOT ENTITLED TO RELY ON ANY SUCH ADVICE OR INFORMATION. THIS DISCLAIMER OF WARRANTIES IS AN ESSENTIAL CONDITION OF THIS AGREEMENT. Some States, Territories and Countries do not allow certain warranty exclusions, so to that extent the above exclusion may not apply to you.

**Disclaimer of Liability.** GARMIN AND ITS LICENSORS, including the licensors, service providers, channel partners, suppliers and affiliated companies of Garmin and its licensors, SHALL NOT BE LIABLE TO YOU: IN RESPECT OF ANY CLAIM, DEMAND OR ACTION, IRRESPECTIVE OF THE NATURE OF THE CAUSE OF THE CLAIM, DEMAND OR ACTION ALLEGING ANY LOSS, INJURY OR DAMAGES, DIRECT OR INDIRECT, WHICH MAY RESULT FROM THE USE OR POSSESSION OF THE GARMIN PRODUCTS; OR FOR ANY LOSS OF PROFIT, REVENUE, CONTRACTS OR SAVINGS, OR ANY OTHER DIRECT, INDIRECT, INCIDENTAL, SPECIAL OR CONSEQUENTIAL DAMAGES ARISING OUT OF YOUR USE OF OR INABILITY TO USE THE GARMIN PRODUCTS, ANY DEFECT IN THE CONTENT OR INFORMATION, OR THE BREACH OF THESE TERMS OR CONDITIONS, WHETHER IN AN ACTION IN CONTRACT OR TORT OR BASED ON A WARRANTY AND WHETHER RESULTING FROM THE USE, MISUSE, OR INABILITY TO USE THE GARMIN PRODUCTS OR FROM DEFECTS OR ERRORS IN THE APPLICATION, EVEN IF GARMIN OR ITS LICENSORS HAVE BEEN ADVISED OF THE POSSIBILITY OF SUCH DAMAGES. GARMIN'S AND ITS LICENSORS' TOTAL AGGREGATE LIABILITY WITH RESPECT TO ITS OBLIGATIONS UNDER THIS LICENSE AGREEMENT OR OTHERWISE WITH RESPECT TO THE APPLICATION OR THE CONTENT SHALL NOT EXCEED \$1.00. Some States, Territories and Countries do not allow certain liability exclusions or damages limitations, so to that extent the above may not apply to you. If you purchased your Application from a third party application vendor, THE SOLE AND MAXIMUM RESPONSIBILITY OF THE APPLICATION VENDOR IN THE EVENT OF A WARRANTY FAILURE IS A REFUND OF THE APPLICATION PURCHASE PRICE.

ANY CONTENT OR MATERIAL DOWNLOADED

OR UPLOADED OR OTHERWISE OBTAINED THROUGH THE SOFTWARE IS DONE AT YOUR OWN DISCRETION AND RISK. YOU WILL BE SOLELY RESPONSIBLE FOR ANY DAMAGE TO YOUR ELECTRONIC COMMUNICATION DEVICE OR ANY LOSS OF DATA THAT MAY RESULT FROM THE DOWNLOAD OR UPLOAD OF ANY SUCH CONTENT OR MATERIAL OR THE USE OF THE SOFTWARE.

**Predictive Routing.** Your device may have a “predictive routing” feature called myTrends that identifies your driving routines. If it does have this feature, when your device predicts a route, it will display your estimated time to destination and relevant traffic information regarding the predicted route. Information related to your driving routines would be accessible to any other person who uses your device. If you do not want your device to predict your routes or display information related to predicted routes, you may turn off myTrends by accessing your device’s Settings menu.

**Collection of Information.** We may collect information relating to how often you use the Garmin Product or the frequency with which certain applications and features of the Garmin Product are used. This information would be collected anonymously, in a way that does not personally identify you. We may use this information to detect broad user trends and to otherwise enhance our products or applications. The use of location-based services on the Garmin Product, which may include weather, movie times, traffic information, fuel prices, or information regarding local events, will cause the physical location of your device to be collected in order to provide you with such location-based services. This location data is collected anonymously in a form that does not personally identify you. If you provide your consent then Garmin will collect and upload information such as your location, speed, and direction (known as “traffic probe data” or “floating car data”) in order to enhance the quality of the traffic data and other content provided by Garmin or other Content providers. If you provide your consent, then Garmin may also share this data with or sell this data to third parties. This data is shared and sold anonymously in a form that does not personally identify you. The collection and use of this location information are described in more detail in the privacy statement for the Garmin Product.

**Disclaimer of Endorsement; Change of Content Providers.** Reference to any products,

services, processes, hypertext links to third parties or other Content by trade name, trademark, manufacturer, supplier or otherwise does not necessarily constitute or imply its endorsement, sponsorship or recommendation by Garmin or its licensors. Product and service information are the sole responsibility of each individual vendor. The HERE name and logo, the HERE and HERE ON BOARD trademarks and logos, and other trademarks and trade names owned by HERE North America LLC may not be used in any commercial manner without the prior written consent of HERE. Content providers may be changed by Garmin during the term of this Agreement, and your experience with the Content provided by a new provider may not duplicate your experience with the previous Content supplier.

**Export Control.** You agree not to export from anywhere any part of the Content or any direct product thereof except in compliance with and with all licenses and approvals required under, applicable export laws, rules and regulations.

**Legal Compliance.** You represent and warrant that (i) you are not located in a country that is subject to a U.S. Government embargo, or has been designated by the U.S. Government as a “terrorist supporting” country, and (ii) you are not listed on any U.S. Government list of prohibited or restricted parties.

**Indemnity.** You agree to indemnify, defend and hold Garmin and its licensors, including the respective licensors, service providers, channel partners, suppliers, assignees, subsidiaries, affiliated companies, and the respective officers, directors, employees, shareholders, agents and representatives of Garmin and its licensors, free and harmless from and against any liability, loss, injury (including injuries resulting in death), demand, action, cost, expense, or claim of any kind or character, including but not limited to attorney’s fees, arising out of or in connection with any use or possession by you of the Garmin Products.

**Map Data.** Use of the Map Data is subject to certain restrictions and/or requirements imposed by third party suppliers and/or governmental or regulatory authorities as further set forth at [http://corporate.navteq.com/supplier\\_terms.html](http://corporate.navteq.com/supplier_terms.html).

**Term.** This Agreement is effective until such time as (i) if applicable, your subscription term is either terminated (by you or by Garmin) or expires, or



(ii) Garmin terminates this Agreement for any reason, including, but not limited to, if Garmin finds that you have violated any of the terms of this Agreement. In addition, this Agreement shall terminate immediately upon the termination of an agreement between Garmin and any third party from whom Garmin (a) obtains services or distribution necessary to support the Garmin Products, or (b) licenses Content. You agree, upon termination, to destroy all copies of the Content. The Disclaimers of Warranty and Liability set out above shall continue in force even after any termination.

**Entire Agreement.** These terms and conditions constitute the entire agreement between Garmin and its licensors, including the licensors, service providers, channel partners, suppliers and affiliated companies of Garmin and its licensors, and you pertaining to the subject matter hereof, and supersedes in their entirety any and all written or oral agreements previously existing between us with respect to such subject matter.

### Governing Law.

(a) For European Union HERE Data

The above terms and conditions shall be governed by the laws of the Netherlands, without giving effect to (i) its conflict of laws provisions, or (ii) the United Nations Convention for Contracts for the International Sale of Goods, which is explicitly excluded. You agree to submit to the jurisdiction of the Netherlands for any and all disputes, claims and actions arising from or in connection with the HERE Data provided to you hereunder.

(b) For North American HERE Data and other non-European Union HERE Data

The above terms and conditions shall be governed by the laws of Illinois, without giving effect to (i) its conflict of laws provisions, or (ii) the United Nations Convention for Contracts for the International Sale of Goods, which is explicitly excluded. You agree to submit to the jurisdiction of Illinois for any and all disputes, claims and actions arising from or in connection with the HERE Data provided to you hereunder.

(c) For disputes, claims and actions not related to the HERE Data

The above terms and conditions shall be governed by the laws of Kansas, without giving effect to (i) its conflict of laws provisions, or (ii) the United Nations Convention for Contracts for the International Sale of Goods, which is explicitly excluded. You agree to submit to the jurisdiction of Kansas for any and all disputes, claims and actions arising from or in connection with the Application or Content. Any translation of this Agreement from English is provided as a convenience only. If this Agreement is translated into a language other than English and there is a conflict of terms between the English version and the other language version, the English version will control.

**Government End Users.** If End User is an agency, department, or other entity of the United States Government, or funded in whole or in part by the U.S. Government, then use, duplication, reproduction, release, modification, disclosure or transfer of the Application and accompanying documentation is subject to restrictions as set forth in DFARS 252.227-7014(a)(1) (JUN 1995) (DOD commercial computer software definition), DFARS 27.7202-1 (DOD policy on commercial computer software), FAR 52.227-19 (JUN 1987) (commercial computer software clause for civilian agencies), DFARS 252.227-7015 (NOV 1995) (DOD technical data – commercial items clause); FAR 52.227-14 Alternates I, II, and III (JUN 1987) (civilian agency technical data and noncommercial computer software clause); and/or FAR 12.211 and FAR 12.212 (commercial item acquisitions), as applicable. In case of conflict between any of the FAR and DFARS provisions listed herein and this License Agreement, the construction that provides greater limitations on the Government's rights shall control. The contractor/manufacture is Garmin International, Inc., 1200 East 151st Street, Olathe, Kansas 66062, USA and HERE North America LLC, 425 West Randolph Street, Chicago, Illinois 60606 USA.

Garmin® is a trademark of Garmin Ltd. or its subsidiaries, registered in the USA and other countries. These trademarks may not be used without the express permission of Garmin.

HERE is a trademark in the U.S. and other countries. All other company names and trademarks mentioned or referenced in this documentation are the properties of their respective owners. All rights reserved.

Additional Terms and Privacy Policy for Location

---

Platform Services. If your Application is provided access to Location Platform Services, by accessing such Location Platform Services you agree to application of the Nokia Terms of Service at <http://here.com/services/terms> and the Nokia Privacy Policy at <http://www.nokia.com/global/privacy/privacy-policy/privacy-policy/>.

---

## Traffic End User License Agreement

---

Your Garmin product may be equipped to receive traffic data. If it is so equipped, the following terms and conditions apply to your use of your Garmin product.

HERE North America LLC and/or its affiliates including Traffic.com (formerly NavTeq Traffic) ("HERE") or another third party traffic provider ("TPTP") holds the rights to the traffic information ("Traffic Data"). If you receive RDS/TMC, DAB or HD Radio/TM Traffic Data, HERE or the TPTP holds the rights to the RDS/TMC, DAB or HD Radio networks through which it is delivered to your Garmin product. By subscribing to, receiving or otherwise accessing the Traffic Data, you acknowledge that you have read this Agreement, that you understand it, that you agree to be bound by the terms and conditions of this Agreement, and that you are at least 18 years of age. If you do not agree to the terms and conditions of this Agreement, decline the subscription or, if the subscription is bundled as part of your Garmin product, return the product within 7 days for a full refund to the dealer from which you purchased the product.

You agree to use the Traffic Data together with your Garmin product solely for personal, non-commercial purposes, and not for service bureau, time-sharing or other similar purposes. You may not modify, copy, scan, decompile, disassemble or reverse engineer any portion of the Traffic Data, or use any other method to reproduce, duplicate, republish, transmit, or distribute in any way any portion of the Traffic Data. You agree to indemnify, defend, and hold harmless either HERE or TPTP (and their respective affiliates) and Garmin Ltd. (and its subsidiaries) against any and all claims, damages, costs, or other expenses that arise directly or indirectly out of (a) your unauthorized use of the Traffic Data (b) the RDS/TMC, DAB or HD Radio networks, (c) your violation of this Agreement, and/or (d) any unauthorized or unlawful activities by you in connection herewith.

The Traffic Data is informational only. You assume all risk of use. HERE or TPTP (and their respective affiliates), Garmin Ltd. (and its subsidiaries), and their suppliers make no representations about content, traffic and road conditions, route usability, or speed.

The Traffic Data is provided to you "as is," and you

agree to use it at your own risk. HERE or TPTP (and their respective affiliates) and Garmin Ltd. (and its subsidiaries) make no warranty of fitness or compatibility of the Traffic Data with the Garmin product and no warranty that the Traffic Data will operate properly as integrated and interfaced with the Garmin product. In addition, HERE or TPTP (and their respective affiliates) and Garmin Ltd. (and its subsidiaries) make no warranty with regard to the reliability, accuracy, exhaustiveness, and completeness of the Traffic Data, which may contain inaccuracies and/or errors from time to time. To the maximum extent permitted by applicable law, any and all warranties of any kind whatsoever with regard to the Traffic Data are hereby expressly waived and excluded, including, but not limited to, those of merchantability, fitness for a particular purpose, accuracy or completeness of the Traffic Data, and/or a lack of viruses.

HERE or TPTP (and their respective affiliates), Garmin Ltd. (and its subsidiaries), and their suppliers disclaim all liability for any loss, injury, or damage resulting from use of or inability to use the Garmin product and the Traffic Data as a result of weather difficulties, the destruction of transmitters and/or broadcasting infrastructures, a natural disaster, and/or a lack of reliability, completeness, or accuracy of the Traffic Data. In no event shall HERE or TPTP (and their respective affiliates), Garmin Ltd. (and its subsidiaries), and their suppliers be liable to you or any other party for any compensatory, direct, indirect, incidental, special, or consequential damages (including, without limitation, indirect, direct, special, punitive, or exemplary damages for loss of business, loss of profits, business interruption, or loss of business information) arising out of the use of or inability to use the Garmin product or the Traffic Data, even if HERE or TPTP or Garmin have been advised of the possibility of such damages.

**Lifetime or Onetime Traffic.** If you purchase or your Garmin product is pre-loaded with "lifetime" or "one-time" traffic, you will receive Traffic Data for the useful life of your Garmin traffic receiver (as long as you own a compatible Garmin product) or as long as Garmin receives Traffic Data from its third party content supplier, whichever is shorter. A traffic receiver's "useful life" means the period during which the receiver (a) has the required technical capabilities to utilize current traffic data service and (b) is capable of operating as intended without major repairs. Traffic Data is not available for all areas. Garmin may terminate your traffic subscription immediately if you violate any of the

terms of this Agreement. Your traffic subscription may not be transferred to another person or another Garmin product. Traffic services are in part geographically restricted to the reception and transmission range of the radio transmitters in the case of broadcast RDSTMC, HD or DAB traffic, operated by the respective network operators or cellular carriers in the case of connected traffic over IP. They can be affected by atmospheric conditions, topographical conditions, the vehicles' location or position as well as obstacles (for example bridges and buildings).

**Governing Law for HERE Traffic Data.** The above terms and conditions concerning HERE Traffic Data shall be governed by the laws of the State of Illinois, without giving effect to (i) its conflict of laws provisions, or (ii) the United Nations Convention for Contracts for the International Sale of Goods, which is explicitly excluded. You agree to submit to the jurisdiction of the State of Illinois for any and all disputes, claims and actions arising from or in connection with the HERE Traffic Data provided to you hereunder.

**HERE Traffic Data Government End Users.** If the HERE Traffic Data is being acquired by or on behalf of the United States government or any other entity seeking or applying rights similar to those customarily claimed by the United States government, this HERE Traffic Data is a "commercial item" as that term is defined at 48 C.F.R. ("FAR") 2.101, is licensed in accordance with this Agreement, and the HERE Traffic Data delivered or otherwise furnished shall be marked and embedded as appropriate with the following "Notice of Use," and shall be treated in accordance with such Notice:

#### **Notice of Use**

Contractor (Manufacturer/ Supplier) Name: HERE

Contractor (Manufacturer/supplier) Address: 425 West Randolph Street, Chicago, Illinois 60606

This Data is a commercial item as defined in FAR 2.101 and is subject to the HERE Traffic™ End User License Agreement under which this Data was provided.

© 1987-2014 HERE – All rights reserved.

If the Contracting Officer, federal government

agency, or any federal official refuses to use the legend provided herein, the Contracting Officer, federal government agency, or any federal official must notify HERE prior to seeking additional or alternative rights in the HERE Traffic Data.

HERE is a trademark in the U.S. and other countries. © 1987-2014 HERE. All rights reserved.

HD Radio Technology manufactured under license from iBiquity Digital Corporation. U.S. and Foreign Patents. HD Radio™ and the HD, HD Radio, and "Arc" logos are proprietary trademarks of iBiquity Digital Corp.

Garmin® is a trademark of Garmin Ltd. or its subsidiaries, registered in the USA and other countries. This trademark may not be used without the express permission of Garmin. All other company names and trademarks mentioned or referenced in this documentation are the properties of their respective owners. All rights reserved.

# Getting Started

The first time you use your Kenwood Navigation System, you need to set up your system. The Help menu provides additional information.

## ⚠ WARNING

See "Safety Precautions and Important Information" in the *Quick Start Guide* for product warnings and other important information.



- The screenshots shown in this manual may not exactly match the screens on your navigation system. The images used in this manual are intended for reference only.

## Using the Navigation System

For complete audio system information, see the other Kenwood system manuals.



- Select ① to access the navigation system.
- When navigating, ② displays Kenwood audio. When using audio, this displays navigation information.

## Help When You Need It

Select **Apps > Help** to view information about using the device.

## Searching Help Topics

Select **Apps > Help > Q**.

## Status Bar Icons

The status bar is located at the top of the main menu. The status bar icons display information about features on the device. You can select some icons to change settings or view additional information.

	GPS signal status
	Current time
	Smartphone Link status (appears when connected to Smartphone Link). See <a href="#">(page 26)</a> .

## Satellite Signals







After your vehicle is turned on, the navigation system begins acquiring satellite signals. The system may need a clear view of the sky to acquire satellite signals. When at least one of the  bars is green, your system has acquired satellite signals.

## Viewing GPS Satellite Signals

For more information about GPS, go to [www.garmin.com/aboutGPS](http://www.garmin.com/aboutGPS).

Select .

## Using the On-Screen Buttons





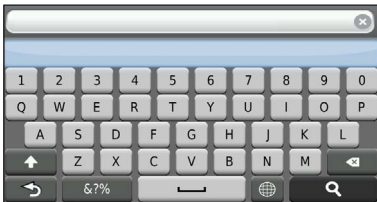

- Select  to return to the main menu.
- Hold  to quickly return to the main menu.
- Select  or  to see more choices.
- Hold  or  to scroll faster.
- Select  to see a menu of options for the current screen.

## Using the On-Screen Keyboard

See Language Settings to change the keyboard layout ([page 36](#)).

**When an on-screen keyboard appears, select a letter or a number to enter it.**



- Select  to add a space.
- Select  to delete a character.
- Select  to erase the entire entry.
- Select  to select the keyboard language mode.
- Select  to enter special characters, such as punctuation marks.
- Select  to change character capitalization.

## Adding a Shortcut

You can add shortcuts to the Where To? menu. A shortcut can point to a location, a category, or a search tool. The Where To? menu can contain up to 36 shortcut icons.

- 1 Select **Where To? > Add Shortcut**.
- 2 Select an item.

## Removing a Shortcut

- 1 Select **Where To >  > Remove Shortcut(s)**.
- 2 Select the shortcut to remove.
- 3 Select the shortcut again to confirm.

# Finding Locations

The navigation system offers many methods for finding locations. The detailed maps loaded in your navigation system contain locations, such as restaurants, hotels, and auto services. You can use categories to browse for nearby businesses and attractions.

## Finding a Location by Category

- 1 Select Where To?.
- 2 Select a category, or select Categories.
- 3 If necessary, select a subcategory.
- 4 Select a location.

## Searching Within a Category

To narrow your search results, you can search within some categories.

- 1 Select Where To?.
- 2 Select a category, or select Categories.
- 3 If necessary, select a subcategory.
- 4 If necessary, enter all or part of the name in the search bar (page 14).

## Finding a Location Using the Search Bar

You can use the search bar to search for locations by entering a category, brand name, address, or city name.

- 1 Select Where To?.
- 2 Select the search bar ①.

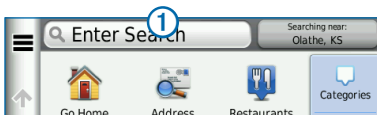

- 3 Enter a search term.

Suggested search terms appear below the search bar as you type.

- 4 Select an option:

- To search for a type of business, enter a category name, such as “movie theaters.”
- To search for a business by name, enter all or part of the name.
- To search for an address near you, enter the street number and street name.
- To search for an address in another city, enter the street number, street name, city, and state.
- To search for a city, enter the city and state.
- To search for coordinates, enter latitude and longitude coordinates.

- 5 Select an option:

- To search using a suggested search term, select the term.
- To search using the text you entered, select .

- 6 If necessary, select a location.

## Changing the Search Area

By default, your device finds locations closest to your current location. You can find a location near another city or location.

- 1 Select Where To? > Searching Near.

- 2 Select an option.

- 3 If necessary, select a location.

## Finding Fuel Stations and Prices

Before you can use this feature, you must subscribe to the Fuel Price service, and your device must be connected via a supported phone running Smartphone Link. This feature is not available in all areas.

You can find nearby fuel stations and compare fuel prices.

- 1 **Select Apps > Fuel Prices.**
- 2 **If necessary, select  > Fuel Type, select a fuel type, and select Save.**
- 3 **Select a fuel station.**

## Finding an Address



• The order of the steps may change depending on the map data loaded on your device.

- 1 **Select Where To? > Address.**
- 2 **Enter the address number, and select Done.**
- 3 **Enter the street name, and select Next.**
- 4 **If necessary, select Searching In to change the city, state, or province.**
- 5 **If necessary, select the city, the state, or the province.**
- 6 **If necessary, select the address.**

## Finding a City

Before you can find a city, you must add a shortcut to the cities search tool ([page 13](#)).

- 1 **Select Where To? > Cities.**
- 2 **Select Enter Search.**
- 3 **Enter a city name, and select .**
- 4 **Select a city.**

## Finding an Intersection

Before you can find an intersection, you must add a shortcut to the intersection search tool ([page 13](#)).

- 1 **Select Where To? > Intersections.**
- 2 **Select a state or province.**  
  
If necessary, select **State or Country** to change the country, state, or province.
- 3 **Enter the first street name, and select Next.**
- 4 **If necessary, select the street.**
- 5 **Enter the second street name, and select Next.**
- 6 **If necessary, select the street.**
- 7 **If necessary, select the intersection.**



### Finding a Location Using Coordinates

Before you can find a location using coordinates, you must add a shortcut to the coordinates search tool (page 13).

You can find a location using latitude and longitude coordinates. This can be helpful when geocaching.

- 1 Select Where To? > Coordinates.
- 2 If necessary, select  > Format, select the correct coordinate format for the type of map you are using, and select Save.
- 3 Select the latitude coordinate.
- 4 Enter the new coordinate, and select Done.
- 5 Select the longitude coordinate.
- 6 Enter the new coordinate, and select Done.
- 7 Select View on Map.

### Finding a Location by Browsing the Map

Before you can find places included in the map data, such as restaurants, hospitals, and fuel stations, you must enable the map layer for places along the road (page 23).

- 1 Select View Map.
- 2 Drag and zoom the map to display the area to search.
- 3 If necessary, select , and select a category icon to view only a specific category of places.

Location markers  (or a blue dot) appear on the map.

- 4 Select an option:
  - Select a location marker.
  - Select a point, such as a street, intersection, or address location.
- 5 If necessary, select the location description to view additional information.

### Find a Location Using Quick Search

After you have performed a search for a point of interest, certain categories may display a Quick Search list that displays the last four destinations you selected.

- 1 Select Where To?.
- 2 Select a category, or select Categories.
- 3 If applicable, select a destination from the Quick Search list .



- 4 If necessary, select the appropriate destination.

### Saving a Home Location

You can set your home location for the location you return to most often.

- 1 Select Where To? >  > Set Home Location.
- 2 Select Enter My Address, Use My Current Location, or Choose from Recently Found.

The location is saved as "Home" in the Saved menu.

## Going Home

Select Where To? > Go Home.

## Editing Your Home Location Information

1 Select Where To? > Saved > Home.

2 Select  >  > Edit.

3 Enter your changes.

4 Select Done.

## Finding Recently Found Places

Your device stores the last 50 locations you have found.

1 Select Where To? > Recent.

2 Select a location.

## Clearing the List of Recently Found Places

Select Where To? > Recent >  > Clear > Yes.

## Finding Parking

1 Select Where To? > Categories > Parking.

2 Select a parking location.

## Setting a Simulated Location

If you are not receiving satellite signals, you can use the GPS to set a simulated location.

1 Select Settings > Navigation.

2 Select GPS Simulator.

3 From the main menu, select View Map.

4 Select an area on the map.

The address of the location appears at the bottom of the screen.

5 Select the location description.

6 Select Set Location.

## Saving a Location

1 Search for a location ([page 14](#)).

2 From the search results, select a location.

3 Select .

4 Select  > Save.

5 If necessary, enter a name, and select OK.

## Saving Your Current Location

1 From the map, select the vehicle icon.

2 Select Save.



3 Enter a name, and select Done.

4 Select OK.

### Starting a Route to a Saved Location

- 1 Select **Where To? > Saved**.
- 2 If necessary, select a category, or select **All Saved Places**.
- 3 Select a location.
- 4 Select **Go!**.

### Editing a Saved Location



- 1 Select **Where To? > Saved**.
- 2 If necessary, select a category.
- 3 Select a location.
- 4 Select .
- 5 Select  **> Edit**.
- 6 Select an option:
  - Select **Name**.
  - Select **Phone Number**.
  - To assign categories to the Favorite, select **Categories**.
  - To change the symbol used to mark the Favorite on a map, select **Change Map Symbol**.
- 7 Edit the information.
- 8 Select **Done**.

### Assigning Categories to a Saved Location

You can add custom categories to organize your saved locations.



- Categories appear in the saved locations menu after you have saved more than 12 locations.

- 1 Select **Where To? > Saved**.
- 2 Select a location.
- 3 Select .
- 4 Select  **> Edit > Categories**.
- 5 Enter one or more category names, separated by commas.
- 6 If necessary, select a suggested category.
- 7 Select **Done**.

### Deleting a Saved Location



- Deleted locations cannot be recovered.

- 1 Select **Where To? > Saved**.
- 2 Select  **> Delete Saved Places**.
- 3 Select the box next to the saved locations to delete, and select **Delete**.

# Navigation

You can create, customize, and edit your routes.

## Starting a Route

- 1 Search for a location (page 14).
- 2 Select a location.
- 3 Select Go!.
- 4 If necessary, select a route.

## Previewing Multiple Routes

- 1 Search for a location (page 14).
- 2 From the search results, select a location.
- 3 Select Routes.
- 4 Use the on-screen buttons to select a route.
- 5 Select Go!.

## Following a Route

The route is marked with a magenta line. A checkered flag marks your destination.

As you travel, the device guides you to the destination with voice prompts, arrows on the map, and directions at the top of the map. If you depart from the original route, the device recalculates the route and provides new directions.



## Using the Navigation Map

- 1 From the main menu, select View Map.
- 2 If the zoom controls are hidden, select the map to display the zoom controls.
- 3 Select the map to switch to browsing mode.

Map buttons appear.

- 4 Select an option:
  - To zoom in or out, select or .
  - To rotate the map view, select .
  - To switch between North Up and 3-D views, select .
  - To add or remove map layers, select .
  - To view specific location categories, select and select a category icon.
  - To center the map on your current location, select .
  - To view shortcuts for map and navigation features, select .

### Adding a Point to a Route

- 1 While navigating a route, select  to return to the main menu.
- 2 Select Where To?.
- 3 Search for the location (page 14).
- 4 Select Go!.
- 5 Select Add to Active Route.

### Taking a Detour

While navigating a route, you can use detours to avoid obstacles ahead of you, such as construction zones.



- If the route you are currently navigating is the only reasonable option, your device might not calculate a detour.

From the map, select  > Detour.

### Stopping the Route

From the map, select .

### Using Suggested Routes

Before you can use this feature, you must save at least one location and enable the travel history feature (page 17).

Using the myTrends™ feature, your device predicts your destination based on your travel history, the day of the week, and the time of day. After you have driven to a saved location several times, the location may appear in the navigation bar on the map, along with the estimated time of travel, and traffic information.

Select the navigation bar to view a suggested route to the location.





### Using Exit Services



- You must be on a major highway or road to use Exit Services.

While navigating a route, you can find gas, food, lodging, and restrooms near upcoming exits.



Services are listed under tabs by category.

	Gas
	Food
	Lodging
	Restrooms

### Finding Exit Services



- 1 From the map, select  > Exit Services.
- 2 Use the arrows to select an upcoming exit.
- 3 Select an exit service tab.
- 4 Select a point of interest.

## Navigating to an Exit

- 1 From the map, select  > Exit Services > .
- 2 Select Go!.

## Using Find Ahead

When upcoming exits do not have needed services, you can search farther ahead on your route.

- 1 While navigating a route, from the map select  > Exit Services.
- 2 Select an exit service tab that does not have an upcoming service match.
- 3 Select Find Ahead.
- 4 Select  >  to see more exits.
- 5 Select a service.
- 6 Select Go!.

## Avoiding Road Features

- 1 Select Settings > Navigation > Avoidances.
- 2 Select the road features to avoid on your routes, and select Save.

## Adding a Custom Avoidance Area

Custom avoidances allow you to avoid specific areas and sections of road. You can enable and disable custom avoidances as needed.

- 1 Select Settings > Navigation > Custom Avoidances.
- 2 If necessary, select Add Avoidance.
- 3 Select Add Avoid Area.
- 4 Select the upper-left corner of the area to avoid, and select Next.
- 5 Select the lower-right corner of the area to avoid, and select Next.  
  
The selected area is shaded on the map.
- 6 Select Done.

## Avoiding a Road



- 1 Select Settings > Navigation > Custom Avoidances.
- 2 Select Add Avoid Road.
- 3 Select the starting point of the section of road to avoid, and select Next.
- 4 Select the ending point of the road section, and select Next.
- 5 Select Done.

## Disabling a Custom Avoidance

You can disable a custom avoidance without deleting it.

- 1 Select Settings > Navigation > Custom Avoidances.
- 2 Select an avoidance.
- 3 Select  > Disable.

### Deleting Custom Avoidances

- 1 Select Settings > Navigation > Custom Avoidances.**
- 2 Select an option:**
  - To delete all custom avoidances, select .
  - To delete one custom avoidance, select the avoidance, and select  > Delete.

### Enabling Advanced Detours

Select Settings > Navigation > Advanced Detours.

### Taking a Detour Around Specified Areas

You can take a detour for a specified distance along your route or detour around specific roads. This is useful if you encounter construction zones, closed roads, or poor road conditions.

- 1 Select a destination, and select Go! (page 14).**
- 2 From the map, select  > Detour.**
- 3 Select Next .5mi on Route, Next 2mi on Route, Next 5mi on Route, or Detour by Road(s) on Route.**
- 4 If necessary, select a road to detour around.**

# The Map Pages

You can customize which data appear on the map and view upcoming turns and current location information.

## Customizing the Map Layers

You can customize which data appear on the map, such as icons for points of interest and road conditions.

- 1 From the map, select .
- 2 Select Map Layers.
- 3 Select which layers you want to include on the map, and select Save.

## Viewing the Trip Log

Your device keeps a trip log, which is a record of the path you have traveled.

- 1 Select Settings > Map & Vehicle > Map Layers.
- 2 Select the Trip Log check box.

## Changing the Map Data Field

- 1 From the map, select the data field in the lower left-hand corner.
- 2 Select a type of data to display.
- 3 Select Save.

## Changing the Map Perspective

- 1 Select Settings > Map & Vehicle > Driving Map View.
- 2 Select an option:
  - Select Track Up to display the map in two dimensions (2-D), with your direction of travel at the top.
  - Select North Up to display the map in 2-D with North at the top.
  - Select 3-D to display the map in three dimensions.

## Customizing Map Buttons

You can include up to three icons on the right side of the main map.

- 1 Select Settings > Map & Vehicle > Map Buttons.
- 2 Select an icon, and select OK.
- 3 Select .
- 4 Select a different icon.

## Removing Buttons from the Map

You can remove all buttons from the right side of the map.

- 1 Select Settings > Map & Vehicle > Map Buttons.
- 2 Select an icon, and touch OK.
- 3 Select Save.



### Viewing a List of Turns

When you are navigating a route, you can view all of the turns and maneuvers for your entire route and the distance between turns.

**1 Select the text bar on the top of the map.**

**2 Select a turn.**



The details for the turn appear. If available, an image of the junction appears for junction on major roadways.

### Viewing the Entire Route on the Map

**1 While navigating a route, select the navigation bar at the top of the map.**

**2 Select  > Map.**

### Viewing the Next Turn

While navigating a route, a preview of the next turn, lane change, or other maneuver appears in the upper-left corner of the map.

The preview includes the distance to the turn or maneuver and the lane in which you should be traveling, if available.

From the map, select  to view the next turn on the map.

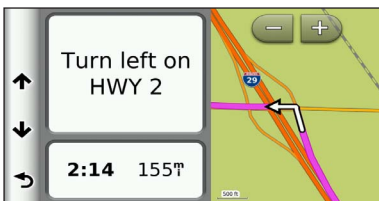

### Viewing Junctions

While navigating a route, you can view the junctions on major roadways. When you approach a junction in a route, the image of that junction appears briefly, if available.



- The Lane Assist page with Junction View is not available on the DNX691HD, DNX571HD, and DNX571EX.

From the map, select  to view the junction, if available.



### Viewing Traffic Alerts

While you navigate a route, a traffic alert may appear.

Select the alert to view more information.

### Viewing Trip Information

The trip information page displays your present speed and provides statistics about your trip.

From the map, select  > Trip Computer.



## Resetting Trip Information

**1** From the map, select  > Trip Computer.

**2** Select  > Reset All.

**3** Select an option:

- When not navigating a route, select **Select All** to reset every data field, except the speedometer, on the page.
- Select **Reset Trip Data** to reset the information on the trip computer.
- Select **Reset Max. Speed** to reset the maximum speed.
- Select **Reset Trip B** to reset the odometer.

## Viewing Current Location Information

You can use the Where Am I? page to view information about your current location. This feature is helpful if you need to tell emergency personnel your location.

From the map, select  > Where Am I?.

## Finding Nearby Services

You can use the Where Am I? page to find nearby services, such as hospitals or police stations.

**1** From the map, select  > Where Am I?.

**2** Select a category.

## Directions to Your Current Location

If you need to tell another person how to get to your current location, your device can give you a list of directions.

Select **Apps** > **Where Am I?** >  > **Directions to Me.**

# Using the Apps

The Apps on your navigation system provide access to weather, trip planning, fuel reports, and more.

## About Smartphone Link

Smartphone Link is a phone application that allows your navigation system to download live data using your phone data connection. Your system transfers data from Smartphone Link using Bluetooth wireless technology.

Connecting to Smartphone Link provides access to Garmin Live Services. Garmin Live Services provides free and subscription-based plans to view live data on your device, such as traffic data, weather, and fuel prices.

Saved locations and recently found locations are synchronized with your phone each time your navigation system connects to Smartphone Link.

## Downloading Smartphone Link

Smartphone Link is available for some smartphones. See the application store for your phone for compatibility and availability information.

Download Smartphone Link from the application store on your supported phone. See your phone owner's manual for information on downloading and installing applications.

## Connecting to Smartphone Link

Before you can connect to Smartphone Link, you must download and install the Smartphone Link application on your phone.

- 1 Start Smartphone Link on your phone.**
- 2 See your other Kenwood system manuals and your phone owner's manual for connection information.**

 appears in the status bar on your device when Smartphone Link is connected.

## Sending a Location from Your Phone

Smartphone Link is registered as a navigation application on your phone.

- 1 From your phone, select the button to start navigating to a location (see the owner's manual for your phone).**
- 2 Select Smartphone Link from the application menu.**

The next time you connect your device to your phone, the location is transferred to the recently found items on your device.

## Disabling Calls While Connected

While the device is connected to the phone and receiving Garmin Live Services, you can disable hands-free calling.

- 1 Select Apps > Smartphone Link.**
- 2 Select your phone.**
- 3 Clear the Hands-Free Calling check box.**

## About Garmin Live Services

Before you can use Garmin Live Services, your device must be connected to a supported phone running Smartphone Link ([page 26](#)).

Some Garmin Live Services, like Weather, are available as separate apps on your device. Other Garmin Live Services, like Live Traffic, enhance the existing navigation features on your device. Connecting to Smartphone Link provides access to Garmin Live Services. Garmin Live Services provide free and subscription-based plans to view live data on your device, such as traffic data, weather and fuel prices.

Features that require access to Garmin Live Services display the Smartphone Link symbol  and appear only when the device is connected to Smartphone Link.

## Subscribing to Garmin Live Services

You must subscribe to Garmin Live Services using the Smartphone Link app on your phone.

- 1 Start the Smartphone Link app on your phone ([page 26](#)).**
- 2 Select Garmin Live Services.**  
  
A list of services and subscription prices appears.
- 3 Select a service.**
- 4 Select the price.**
- 5 Select Subscribe.**
- 6 Follow the on-screen instructions.**

## About ecoRoute

The ecoRoute™ feature calculates your vehicle fuel economy, carbon footprint, and the fuel price of navigating to a destination, and offers tools for improving fuel efficiency.

The data provided by the ecoRoute feature is only an estimate. The data is not actually read from your vehicle. To receive more-accurate fuel reports for your specific vehicle and driving habits, calibrate the fuel economy.

## Creating a Vehicle Profile

The vehicle profile provides a basis for ecoRoute to calculate your vehicle fuel economy.

- 1 Select Apps > ecoRoute™.**
- 2 Enter the required information, and select Next.**
- 3 Select Done.**

## Resetting Your Vehicle Profile

- 1 Select Apps > ecoRoute™ > Vehicle Profile.**
- 2 Select Reset.**

## Calibrating Fuel Economy

Use this feature when you refuel to maintain an accurate fuel economy.

- 1 Select Apps > ecoRoute™ > At the Pump.**
- 2 Enter the current fuel price.**
- 3 Enter how much fuel your vehicle has used since the last fill up.**
- 4 Enter the distance you have traveled since the last fill up.**
- 5 Select Next.**

### Taking the ecoChallenge

The ecoChallenge helps you maximize your fuel economy by scoring your driving habits. The higher your ecoChallenge scores, the more fuel you save. The ecoChallenge collects data and calculates a score whenever you are moving.

The ecoChallenge  icon displays your current score on the map.

**Select Apps > ecoRoute™ > ecoChallenge.**



To view detailed ecoChallenge scores, select the icon.

The leaf color on the driving challenge icon changes depending on your performance in the challenge.

### About ecoChallenge Scores

- **Overall**—a combination of the speed, acceleration, and braking score.
- **Speed**—gain points for driving at your vehicle optimal speed for conserving fuel (45–60 mph for most vehicles).
- **Acceleration**—gain points for smooth acceleration; lose points for rapid acceleration.
- **Braking**—gain points for smooth braking; lose points for hard braking.

### Hiding Your ecoChallenge Score

**1 Select Settings > Map & Vehicle > Map Buttons.**

**2 Select** .

**3 Select OK.**

### Resetting Your Score

You can restart your current ecoChallenge.

**1 Select Apps > ecoRoute > ecoChallenge.**

**2 Select**  **> Reset.**

**3 Select Yes.**

### Viewing Your Fuel Economy

**1 Select Apps > ecoRoute™ > Fuel Economy.**

The graph along the bottom shows your average fuel economy for a period of driving time.

**2 Select a section of the graph to zoom in.**

**3 Select Reset to clear the fuel economy data.**

### About the Mileage Report

A mileage report tracks the distance, the time, the average fuel economy, and the fuel cost of navigating to a destination.

A mileage report is created for every route that you drive. If you stop a route on the device, a mileage report is created for the distance you traveled.

Mileage reports are created automatically when you stop or complete routes.

### Viewing a Mileage Report

You can view the 20 most-recent mileage reports.

**1 Select Apps > ecoRoute™ > Mileage Report.**

**2 Select a report.**

To reset all report data, select **Reset**.

## Exporting a Mileage Report

- 1 **Connect a USB mass storage device to your Kenwood unit.**
- 2 **Select Apps > ecoRoute™ > Mileage Report.**
- 3 **Select Export to export and save the reports to the USB mass storage device.**

## Setting Routes that Use Less Fuel

- 1 **Select Settings > Navigation > Calculation Mode.**
- 2 **Select Less Fuel.**

## Viewing myGarmin Messages

Before you can use this feature, your device must be connected to a supported phone running Smartphone Link ([page 26](#)). This feature is not available in all areas.

You can view messages from myGarmin, such as notifications for software and map updates.

- 1 **Select Apps > myGarmin.**

If you have unread messages, the number of unread messages appears on the myGarmin icon.

- 2 **Select a message subject.**

The full message appears.

## Viewing the Weather Forecast

Before you can use this feature, your device must be connected to a supported phone running Smartphone Link ([page 26](#)). This feature is not available in all areas.

- 1 **Select Apps > Weather.**

The forecast for your current location appears.

- 2 **Select a day.**

The detailed forecast for that day appears.

## Viewing Weather Near a Different City

- 1 **Select Apps > Weather > Current Location.**

- 2 **Select an option:**

- To view weather for a favorite city, select a city in the list.
- To add a favorite city, select **Add City**, and enter a city name.

## Viewing the Weather Radar

You can view an animated, color-coded radar map of current weather conditions, as well as a weather icon on the map. The weather icon changes to show weather in the vicinity, such as rain, snow, and thunderstorms.

- 1 **Select Apps > Weather.**

- 2 **If necessary, select a city.**

- 3 **Select  > Weather Radar.**

### Viewing Weather Alerts

While you are traveling with your device, weather alerts may appear on the map. You can also view a map of weather alerts near your current location or near a selected city.

- 1 Select **Apps > Weather**.
- 2 If necessary, select a city.
- 3 Select  > **Weather Alerts**.

### Checking Road Conditions

- 1 Select **Apps > Weather**.
- 2 If necessary, select a city.
- 3 Select  > **Road Conditions**.

### Planning a Trip

You can use the trip planner to create and save a trip with multiple destinations.

- 1 Select **Apps > Trip Planner**.
- 2 Select **New Trip**.
- 3 Select **Select Start Location**.
- 4 Search for a location ([page 14](#)).
- 5 Select **Select**.
- 6 To add additional locations, select .
- 7 Select **Next**.
- 8 Enter a name, and select **Done**.

### Editing a Trip Itinerary

- 1 Select **Apps > Trip Planner**.
- 2 Select a saved trip.
- 3 Select an option:
  - To change the arrival or departure time, select a location in the trip.
  - To record how long you will stay at a location, select a location in the trip, and select **Duration**.
  - To view the trip on the map, select **Map**.

### Navigating to a Saved Trip

- 1 Select **Apps > Trip Planner**.
- 2 Select a saved trip.
- 3 Select **Go!**.
- 4 If prompted, select a route.

### Editing a Saved Trip

- 1 Select **Apps > Trip Planner**.
- 2 Select a saved trip.
- 3 Select .
- 4 Select an option:
  - Select **Rename Trip**.
  - Select **Edit Destinations** to add and delete locations, or to change the order of locations.
  - Select **Delete Trip**.
  - Select **Optimize Order** to arrange the stops on your trip in the most-efficient order.

## Using the World Clock

- 1 Select Apps > World Clock.
- 2 If necessary, select a city, enter a city name, and select Done.

## Viewing the World Map

Select Apps > World Clock > .

Nighttime hours appear in the shaded area of the map.

## Finding Parking

Before you can use this feature, you must subscribe to the Dynamic Parking service, and your device must be connected to a supported phone running Smartphone Link ([page 26](#)). This feature is not available in all areas.

You can find detailed parking information, including parking availability in nearby garages, and pricing information.

- 1 Select Apps > Parking.
- 2 Select a parking location.



# Traffic Information

Using the built-in receiver, the navigation system can receive and use traffic information. When a traffic message is received, you can see the event on the map and change your route to avoid the traffic incident. Traffic information is not available on all models or in all areas.

## NOTICE

Garmin and JVC KENWOOD is not responsible for the accuracy or timeliness of the traffic information.

Traffic information may not be available in all areas or countries.

## Traffic Subscription Activation

You can purchase traffic subscriptions for regions or countries. Go to [www.garmin.com/kenwood](http://www.garmin.com/kenwood) for more information.

## Understanding Traffic

Your navigation system can receive traffic information using the built-in traffic receiver or a traffic subscription from Garmin Live Services (page 27). The traffic receiver must be in data range of a station transmitting traffic data to receive traffic information. The traffic subscription activates automatically after your navigation system acquires satellite signals while receiving traffic signals from the service provider. You can add other subscriptions at any time. For information about traffic receivers and coverage areas, go to [www.garmin.com/kenwood](http://www.garmin.com/kenwood).

## Traffic Data Using Smartphone Link

You can purchase a traffic subscription to receive traffic data using Smartphone Link. When your navigation system is connected to Smartphone Link and within a traffic coverage area, your system will begin displaying traffic information. Traffic data is not available in all areas.

- 1 From your phone, purchase a traffic subscription from Garmin Live Services (page 27).
- 2 Connect your device to Smartphone Link (page 26).

## About the Traffic Icon

When you are receiving traffic information, a traffic icon appears on the Map. The traffic icon changes color to indicate the severity of traffic conditions.

Color	Description	Meaning
Green	Low severity	Traffic is flowing normally.
Yellow	Medium severity	Traffic is slightly congested.
Red	High severity	Traffic is heavily congested or stopped.
Gray	No data	Traffic data has not updated.

## Traffic on Your Route

When calculating your route, the navigation system examines the current traffic and automatically optimizes the route for the shortest time. If a severe traffic delay occurs on your route while you are navigating, your navigation system automatically recalculates the route.

The traffic icon  changes color to indicate the severity of traffic conditions on your route or on the road you are currently traveling.

Your navigation system may route you through a traffic delay if a better alternative route does not exist. The delay time is added into your estimated time of arrival automatically.

## Viewing Traffic on Your Route

1 While navigating a route, select .

2 Select Traffic on Route.

A list of traffic events appears, organized by their location on the route.

3 Select an event.

## Manually Avoiding Traffic on Your Route

1 From the map, select .

2 Select Traffic On Route.

3 If necessary, use the arrows to view other traffic delays on your route.

4 Select  > Avoid.

## Taking an Alternate Route

1 While navigating an automobile route, select .

2 Select Alternate Route.

3 Select a route.

## Viewing Traffic on the Map

The traffic map shows color-coded traffic flow and delays on nearby roads.

1 From the map, select .

2 Select Traffic Conditions.

## Searching for Traffic Delays

1 From the map, select .

2 Select Traffic Conditions > .

3 Select an item in the list.

4 If there is more than one delay, use the arrows to view additional delays.

## Viewing a Traffic Incident on the Map

1 From the map, select .

2 Select Traffic Conditions.

3 Select a traffic icon.

## Understanding Traffic Data

The traffic legend explains the icons and colors used on the traffic map.

1 From the map, select .

2 Select Traffic Legend.

### About Traffic Cameras

Before you can use this feature, you must subscribe to the photoLive service, and your device must be connected to a supported phone running Smartphone Link (page 26). This feature is not available in all areas.

Traffic cameras provide live images of traffic conditions on major roadways and intersections. You can save cameras that you want to view regularly.

### Saving a Traffic Camera

- 1 Select **Apps > photoLive**.
- 2 Select **Add Camera**.
- 3 Select **a road**.
- 4 Select **an intersection**.
- 5 Select **Save**.

### Viewing a Traffic Camera

Before you can view a traffic camera, you must save a traffic camera.

- 1 Select **Apps > photoLive**.
- 2 Select **a camera**.

### Adding a Traffic Subscription

You can purchase traffic subscriptions for other regions or countries.

- 1 **From the main menu, select Traffic.**
- 2 Select **Subscriptions >** .
- 3 **Write down the FM Traffic Receiver unit ID.**
- 4 Go to [www.garmin.com/fmtraffic](http://www.garmin.com/fmtraffic) to purchase a subscription and get a 25-character code.

The traffic subscription code cannot be reused. You must obtain a new code each time you renew your service. If you own multiple FM traffic receivers, you must obtain a new code for each receiver.

- 5 Select **Next on the device**.
- 6 Enter the code.
- 7 Select **Done**.

# Customizing the Settings

You can customize the settings of your GPS navigation system.

## Customizing the Navigation System

- 1 **Select Settings.**
- 2 **Select a setting category.**
- 3 **Select the setting to change it.**

## Changing the Map Settings

### Select Settings > Map & Vehicle.

- **Vehicle**—select **Change** to change the icon used to display your position on the map. Select the icon you want to use, and select **Save**.
- **Driving Map View**—select a map perspective.
- **Map Detail**—adjust the amount of detail shown on the map. More detail may cause the map to redraw slower.
- **Map theme**—changes the color of the map data.
- **Map Buttons**—Sets which icons are included on the map. Up to three icons can be included on the map.
- **Map Layers**—Sets the data that appears on the map.
- **Dashboards**—Sets the map dashboard layout.
- **myMaps**—Sets which installed maps the device uses.

## Enabling Maps

- 1 **Select Settings > Map & Vehicle > myMaps.**
- 2 **Select a map.**

## Changing the Navigation Settings

### Select Settings > Navigation.

- **Calculation Mode**—sets route preference.
- **Avoidances**—sets road features to avoid on a route.
- **Custom Avoidances**—allows you to avoid specific roads or areas.
- **Advanced Detours**—sets the length of a detour.
- **Safe Mode**—disables all functions that require significant operator attention and could become a distraction while driving.
- **GPS Simulator**—stops the device from receiving a GPS signal, and saves battery power.

## Adjusting the Display Settings

### Select Settings > Display.

- **Color Mode**—select **Day** for a light background, **Night** for a dark background, or **Auto** to automatically switch between the two.

## Route Preferences

### Select Settings > Navigation > Calculation Mode.

The route calculation is based on road speeds and vehicle acceleration data for a given route.

- **Faster Time**—calculates routes that are faster to drive but can be longer in distance.
- **Shorter Distance**—calculates routes that are shorter in distance but can take more time to drive.
- **Less Fuel**—calculates routes that could use less fuel than other routes.

### Updating the Time Settings

#### Select Settings > Units & Time.

- **Current Time**—select **Automatic** to update the time automatically. When Automatic is not selected, you can adjust the time in 15-minute increments.
- **Time Format**—select a 12-hour, 24-hour, or UTC time format.
- **Units**—sets the unit of measure used for distances.

### Setting the Languages

#### Select Settings > Language & Keyboard.

- **Voice Language**—select a voice for the voice prompts.
- **Keyboard Language**—sets the language for your keyboard.
- **Keyboard Layout**—sets the keyboard layout.

### Adding Security

#### Select Settings > Navigation > Safe Mode.

- **Safe Mode**—turn safe mode on or off. When your vehicle is moving, safe mode disables all functions that require significant operator attention and could become a distraction while driving.

### Device and Privacy Settings

#### Select Settings > Device.

- **About** — displays the software version number, the unit ID number, and information on several other software features.



- You need this information when you update the system software or purchase additional map data ([page 37](#)).
- **Travel History** — allows the device to record information for the myTrends ([page 20](#)), and Trip Log features.
- **Clear Travel History**—clears all travel history for the myTrends ([page 20](#)), and Trip Log features.

### Restoring Settings

You can restore a category of settings or all settings to the factory default values.

- 1 **Select Settings.**
- 2 **If necessary, select a settings category.**
- 3 **Select  > Restore.**

# Appendix

This appendix provides additional information about your navigation system, such as how to update the software and map data.

## Updating the Software

Before you can update the navigation system software, you must have a USB mass storage device and an Internet connection.

- 1 Go to [www.garmin.com/kenwood](http://www.garmin.com/kenwood).
- 2 Select **Update**.
- 3 Follow the on-screen instructions.

## Updating the Map Data

You can purchase updated map data from Garmin or ask your Kenwood dealer or Kenwood service center for details.

- 1 Go to [www.garmin.com/kenwood](http://www.garmin.com/kenwood).
- 2 Select **Update**.
- 3 Follow the on-screen instructions.

## Safety Cameras

### WARNING

Garmin and JVC KENWOOD are not responsible for the accuracy of, or the consequences of using, a safety camera database.

Safety camera information is available in some locations. Go to <http://my.garmin.com> for availability. For these locations, the navigation system includes the locations of hundreds of safety cameras. Your navigation system alerts you when you are approaching a safety camera and can warn you if you are driving too fast. The data is updated at least weekly, so you always have access to the most up-to-date information.

You can purchase a new region or extend an existing subscription at any time. Each region that you purchase has an expiration date.

## Custom POIs (Points of Interest)

You can manually load custom points of interest (POI) databases, available from various companies on the Internet. Some custom POI databases contain alert information for points such as safety cameras and school zones. The navigation system can notify you when you approach one of these points. You are responsible for ensuring that your use of safety camera information is lawful in your area.

### WARNING

Garmin and JVC KENWOOD are not responsible for the consequences of using custom POI databases, or for the accuracy of custom POI databases.

After downloading your POI database, use the Garmin POI Loader to install the POIs onto a USB mass storage device. Use the USB mass storage device to load the POIs. The POI Loader is available at [www.garmin.com/products/poiloader](http://www.garmin.com/products/poiloader). Refer to the POI Loader Help file for more information; click **Help** to open the Help file.



- Each time you load custom POIs to the navigation system, any other custom POIs already saved in the system will be overwritten.

## Finding Custom POIs

- 1 Select **Where To? > Categories > Custom POIs**.
- 2 Select a category.

For the latest free software updates (excluding map data) throughout the life of your Garmin products, visit the Garmin Web site at [www.garmin.com/Kenwood](http://www.garmin.com/Kenwood).



© 2014 Garmin Ltd. or its subsidiaries

Garmin International, Inc.  
1200 East 151st Street, Olathe, Kansas 66062, USA

Garmin (Europe) Ltd.  
Liberty House, Hounsdown Business Park, Southampton, Hampshire, SO40 9LR, UK

Garmin Corporation  
No. 68, Zhangshu 2<sup>nd</sup> Road, Xizhi Dist., New Taipei City, 221, Taiwan (R.O.C.)

[www.garmin.com](http://www.garmin.com)

Part Number 190-01686-01 Rev. B

Garmin® and the Garmin logo are trademarks of Garmin Ltd. or its subsidiaries, registered in the USA and other countries. ecoRoute™, myTrends™, and trafficTrends™ are trademarks of Garmin Ltd. or its subsidiaries. These trademarks may not be used without the express permission of Garmin. HERE is a trademark in the U.S. and other countries. The Bluetooth® word mark and logos are owned by the Bluetooth SIG, Inc. and any use of such marks by Garmin is under license. All other company names and trademarks mentioned or referenced in this documentation are the properties of their respective owners. All rights reserved.

## Caution for Smartphone Users

Simultaneously running multiple applications on your smartphone while screen sharing places heavy demand on the microprocessor of the phone, potentially affecting communication and performance.

For best results while pairing with your Kenwood receiver, please be sure to close any unused applications by performing the following steps:

*Android operating system example:*

- Turn off WiFi in phone settings menu.
- Close all open applications before connecting for in-car use. Hold the <Home> key and select <Close all> to close all open applications.
- Clear RAM Memory of the Android phone before connecting for in-car use. Hold the <Home> key and select <Task Manager> then select <RAM> then select <Clear memory> to clear current memory processes.

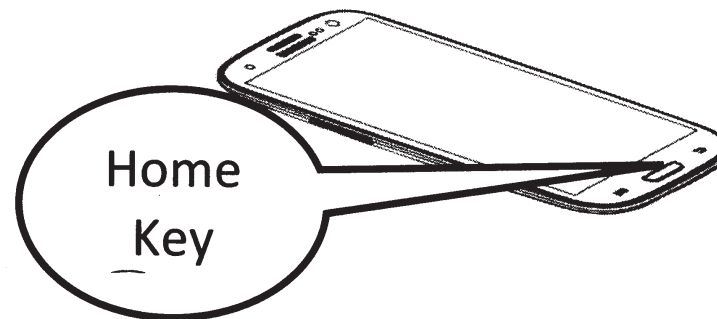



## MILITARY

Units purchased through the U.S.A. military exchange service overseas may be serviced under warranty in the continental U.S.A., subject to the following conditions.

- 1) The original warranty is in effect.
- 2) Proof of purchase is provided to the servicier.

### WARRANTY FOR MILITARY MARKET

Kenwood corporation is proud of the quality and workmanship of its audio equipment. This unit has been properly designed, tested and inspected before it was shipped to you. If properly installed and operated in accordance with instructions furnished, it should give you an optimum reliable performance.

### WARRANTY PERIOD

This product is warranted for a period of (1) year from the date of the original purchase.

### SCOPE OF WARRANTY

Except as specified below, this warranty covers all defects in materials and workmanship of the Kenwood brand products.

During the warranty period, any authorized Kenwood Service Center in the military market listed in the back of this warranty card will provide you free-of-charge both parts and labor required to correct any defect in materials or workmanship.

The following are not covered by this warranty.

1. Voltage conversions.
2. Periodic check-ups which do not disclose any defect covered by the warranty.
3. Cabinets, grilles, other exterior finishes, belts, tape heads, and other non-durable parts and accessories.
4. Units on which the serial number has been effaced, modified or removed.
5. Installation and/or removal charges.
6. Damaged magnetic tapes.
7. House call charges for any repairs.
8. Shipping or delivery charges to or from an authorized Kenwood Service Center.
9. This warranty will not cover any failure that is due to any of the following conditions in accordance with the visual inspection of the authorized Kenwood Service Center:
  - \* Improper maintenance or repair, including the installation of parts or accessories that do not conform to the quality and specifications of the original parts.
  - \* Misuse, abuse, neglect, unauthorized product modification or failure to follow instructions contained in the Owner's Manual.
  - \* Accidental or intentional damages.
  - \* Repairs or attempted repairs by an unauthorized agency. (All repairs must be performed at an authorized Kenwood Service Center.)
  - \* Damages or deteriorations caused during shipment (Claims must be presented to the carrier).
  - \* Damages or deteriorations resulting from removal and/or replacement.

### PURCHASER'S RESPONSIBILITIES

As the purchaser of a new Kenwood brand product, you are requested to do the following in order to obtain Kenwood warranty service.

1. Retain your sales slip or other evidence of purchase for proving your eligibility for requesting Kenwood warranty service.
2. Make your unit available to an authorized Kenwood Service Center in the military market for inspection and approved warranty service, or ship your unit in its original carton box or equivalent, fully insured and shipping charges prepaid, to the authorized Kenwood Service Center.

### LIMITATION OF IMPLIED WARRANTIES

Any and all implied warranties, including warranties of merchantability and fitness for a particular purpose, shall be limited in duration to the length of this warranty.

### EXCLUSION OF CERTAIN DAMAGES

KENWOOD's liability for any defective product is limited to the repair or replacement of said product, at our option, and shall not include damages of any kind, whether incidental, consequential or otherwise, except to the extent prohibited by applicable law.

### KENWOOD AUTHORIZED SERVICE CENTERS IN MILITARY MARKET

#### JAPAN:

##### Yokota

Kenwood Rep.,; c/o  
Yokota BX, JAAX AAFES-PAC,  
APO San Francisco 96328

##### Zama

Kenwood Rep.,; c/o  
Zama PX, JAAX AAFES-PAC,  
APO San Francisco 96343

##### Misawa

Kenwood Rep.,; c/o  
Misawa BX, JAAX AAFES-PAC,  
APO San Francisco 96519

##### Yokosuka

Kenwood Rep.,; c/o  
A-33, Yokosuka NEX No. 260-010  
FPO Seattle 98760

##### Atsugi

Kenwood Rep.,; c/o  
Atsugi NEX No. 260-020 FPO Seattle  
98767

##### Iwakuni

Kenwood Rep.,; c/o  
Marine Corps Exchange, Marine Corps  
Air Station,  
FPO Seattle 98764

##### Sasebo

Sasebo NEX;  
Navy Exchange 260-040  
F.A. Box 115 FPO Seattle 98766

##### Okinawa

Kenwood Rep.,; c/o  
OWAX, AAFES-PAC, APO San Francisco  
96230

#### KOREA:

Kenwood Rep.,; c/o  
KOAX Repair Shop, AAFES-PAC  
DD-Camp Market, APO San Francisco  
96488

#### GUAM:

Kenwood Rep.,; c/o  
Guam NEX No. 230-010,  
FPO San Francisco 96630  
Kenwood Rep.,; c/o  
GUAX, AAFES-PAC, APO San Francisco  
96334

#### U.S.A.:

##### Hawaii

Kenwood Factory Service  
99-994 Iwaena St., Aiea, Hawaii 96701

##### Alaska

Vista Radio TV,  
861 East Loop Road, Anchorage, Alaska  
99501  
Anchorage Commercial Electronics, Inc.,  
1450 East 9th Ave., Anchorage, Alaska  
99501

##### In The Continental U.S.A.

For Nearest Authorized Service Center;  
Tel: 1-800-536-9663

##### Kenwood Service U.S.A.

Kenwood Factory Service;  
P.O. Box 22745, 2201 East Dominguez  
Street,  
Long Beach, California 90801-5745  
Tel: (310) 639-5300

##### EUROPE:

Please inquire at the military resale  
outlets where you bought your Kenwood  
products, or  
KENWOOD ELECTRONICS  
DEUTSCHLAND GMBH:  
Rembrücker-Str. 15, 63150 Heusenstamm,  
Germany  
Tel.: 49-06104-69010

# Warranty Card

Identification du produit  
Modelo do aparelho e numero de série  
Model number & serial number

Revendeur & cachet  
Nome da loja e carimbo  
Dealer & stamp

Date d'achat  
Data da compra  
Purchase date

Nom & adresse du client  
Nome e endereço do cliente  
Name & address of customer

### Attention:

This card and receipt (or invoice) are necessary to purchase a new panel in case of theft or damage.

### Attention:

Vous aurez besoin de cette carte et du reçu (ou de la facture) pour acheter un nouveau panneau en cas de vol ou d'endommagement.

### Atenção:

Em caso de dano ou perda do painel frontal, este Certificado de Garantia e a Nota Fiscal de compra serão requisitados para a aquisição de um novo painel.

© B46-0824-00/01 (K) (12/07)

# KENWOOD

Dear Customer,

Thank you for purchasing this kenwood product. As mentioned in the pages of this booklet, our warranty is only valid in the countries listed. If your country is not listed please contact your retailer for information on warranty procedure, or write to:

### JVC KENWOOD Customer Information Center

3-12, Moriyocho, Kanagawa-ku, Yokohama-shi, Kanagawa 221-0022, Japan

<b>U.S.A.</b>	<b>KENWOOD USA CORPORATION</b>
<p>This warranty will be honored only in the U.S.A.</p>	
<b>KENWOOD LIMITED WARRANTY FOR CAR STEREO COMPONENTS</b>	<b>WHO IS PROTECTED</b>
	This warranty is enforceable only by the original purchaser.
<b>HOW LONG IS THE WARRANTY</b>	<b>WHAT WE WILL PAY FOR</b>
Kenwood U.S.A. Corporation ("Kenwood") warrants this product for a period of one (1) year from the date of original purchase.	We will pay for all labor and material expenses for covered items. Payment of shipping charges is discussed in the next section of this warranty.
<b>WHAT IS COVERED AND WHAT IS NOT COVERED</b>	<b>HOW TO OBTAIN WARRANTY SERVICE</b>
<p>Except as specified below, this warranty covers all defects in material and workmanship in Kenwood car stereo components. The following are not covered by the warranty:</p> <ol style="list-style-type: none"> <li>Any product which is not distributed in the U.S.A. by Kenwood or which is not purchased in the U.S.A. from an authorized Kenwood car stereo dealer or an automobile dealer, unless the product is purchased through the U.S.A. Military Exchange Service.</li> <li>Any product on which the serial number has been defaced, modified or removed.</li> <li>Damage, deterioration or malfunction resulting from:             <ol style="list-style-type: none"> <li>Any shipment of the product (claims must be presented to the carrier).</li> <li>Installation or removal of the product.</li> <li>Accident, acts of nature, misuse, abuse, neglect, unauthorized product modification or failure to follow instructions supplied with the product.</li> <li>Repair or attempted repair by anyone not authorized by Kenwood.</li> <li>Any other cause which does not relate to a product defect.</li> </ol> </li> </ol>	<p>If your KENWOOD product ever needs service:</p> <ol style="list-style-type: none"> <li>Take or ship it to any KENWOOD Authorized Service Center in the U.S.A. along with a complete description of the problem. (If you are uncertain as to whether a Service Center is authorized, please call 1-800-KENWOOD for the nearest Service Center. 1-800-536-9663).</li> <li>Although you must pay any shipping charges if it is necessary to ship the product for warranty service, we will pay the return shipping charges if the repairs are covered by the warranty within the United States.</li> <li>Whenever your units are taken or sent for warranty service, you must include a copy of the original dated sales receipt as proof of warranty coverage.</li> </ol>
<b>LIMITATION OF IMPLIED WARRANTIES</b>	
ALL IMPLIED WARRANTIES, INCLUDING WARRANTIES OF MERCHANTABILITY AND FITNESS FOR A PARTICULAR PURPOSE, ARE LIMITED IN DURATION TO THE LENGTH OF THIS WARRANTY.	
	<b>EXCLUSION OF DAMAGES</b>
	<p>KENWOOD'S LIABILITY FOR ANY DEFECTIVE PRODUCT IS LIMITED TO THE REPAIR OR REPLACEMENT OF THE PRODUCT AT OUR OPTION. KENWOOD SHALL NOT BE LIABLE FOR:</p> <ol style="list-style-type: none"> <li>INSTALLATION OR REMOVAL CHARGES, DAMAGE TO OTHER PROPERTY CAUSED BY ANY DEFECTS IN KENWOOD CAR STEREO COMPONENTS, DAMAGES BASED UPON INCONVENIENCE, LOSS OF USE OF THE PRODUCT; OR</li> <li>ANY OTHER DAMAGES, WHETHER INCIDENTAL, CONSEQUENTIAL OR OTHERWISE.</li> </ol> <p>SOME STATES DO NOT ALLOW LIMITATIONS ON HOW LONG AN IMPLIED WARRANTY LASTS AND/OR DO NOT ALLOW THE EXCLUSION OR LIMITATION OF INCIDENTAL OR CONSEQUENTIAL DAMAGES, SO THE ABOVE LIMITATIONS AND EXCLUSIONS MAY NOT APPLY TO YOU.</p>
	<p>This warranty gives you specific legal rights, and you may also have other rights which vary from state to state.</p>
	<p>If a problem develops during or after the Limited Warranty Period, or if you have any questions regarding the operation of the product, you should contact your KENWOOD Authorized Dealer or Authorized Service Center. If the problem or your question is not handled to your satisfaction, please contact our Customer Relations Department at the address listed below:</p>
	<b>KENWOOD USA CORPORATION</b>
	<b>P.O. Box 22745, 2201 East Dominguez Street, Long Beach, CA 90801-5745</b>
	<b>Tel: (310) 639-5300</b>

<b>BRASIL</b>	<b>JVC KENWOOD DO BRASIL COMÉRCIO DE ELETRÔNICOS LTDA</b>
<p>O fabricante garante o produto identificado na Nota Fiscal de venda ao consumidor contra qualquer defeito de fabricação ou de matéria-prima durante o período de garantia. Esta garantia é válida no território brasileiro desde que o produto tenha sido adquirido no Brasil e distribuído pela JVC KENWOOD do Brasil Comércio de Eletrônicos Ltda.</p>	
<b>PERÍODO DE GARANTIA</b>	<b>CONCERTO EM GARANTIA</b>
Este produto é garantido pelo prazo de 01 (um) ano, incluindo o período estabelecido por lei, a partir da data de aquisição, comprovada mediante a apresentação da respectiva Nota Fiscal de venda ao consumidor final. Eventuais reparos realizados no produto durante o período de garantia não implicam na dilatação do seu prazo.	É indispensável a apresentação deste Certificado de Garantia devidamente preenchido, acompanhado da respectiva Nota Fiscal de compra do produto, desde que não apresente rasuras ou modificações. O consumidor somente terá direito a estes benefícios, quando o produto for entregue diretamente no balcão de um Serviço Autorizado da JVC KENWOOD.
<b>EXCLUSÃO DA GARANTIA</b>	<b>O QUE NÃO É COBERTO PELA GARANTIA</b>
<ol style="list-style-type: none"> <li>Produtos com o número de série ou certificado de garantia rasurados, adulterados ou ilegíveis;</li> <li>Defeitos resultantes de acidentes (quedas, batidas e etc), uso em desacordo com o manual de instruções, má utilização, ligação à fonte de tensão diferente da especificada no Manual de Instruções, modificações não autorizadas;</li> <li>Danos causados por agentes da natureza (Ex: chuvas, raios, maresia, enchentes e etc);</li> <li>Defeitos ou danos em decorrência de concertos realizados por pessoas não autorizadas;</li> <li>Defeitos ou danos resultantes do uso de peças ou dispositivos não conformes às especificações da JVC KENWOOD;</li> <li>Danos ou deteriorações aos acabamentos externos, partes cosméticas, cabos, chiques, parafusos de fixação, luvas, alças, bolsas, estojos, adaptadores, antenas, fitas, cabecas gravadoras, CDs ou danos causados por pilhas defeituosas ou com vazamento;</li> <li>Defeitos ou danos devido ao transporte (reclamações devem ser feitas junto à empresa transportadora);</li> <li>Qualquer outra causa que não esteja relacionada a defeitos de matéria-prima e de fabricação;</li> <li>Danos causados por tentativa de roubo ou furto;</li> <li>Danos causados por uso de CDs de má qualidade;</li> <li>Danos decorrentes do desgaste natural do produto; -</li> <li>Danos causados por mau uso. (derramamento de líquidos e/ou alimentos, corrosão, oxidação, exposição à umidade ou situações climáticas extremas, riscos ou quedas).</li> </ol>	<p>Instalação e remoção do produto, despesas de frete, seguro e embalagem são de responsabilidade do proprietário.</p>
	<b>ESTE PRODUTO É DESTINADO EXCLUSIVAMENTE AO USO DOMÉSTICO.</b>
<b>IMPORTANTE:</b>	
Para qualquer informação sobre seu equipamento JVC KENWOOD, ou para obter o endereço do Serviço Autorizado mais próximo, acesse o site <a href="http://www.kenwood.com.br">www.kenwood.com.br</a> ou, ligue para a Central de Atendimento JVC KENWOOD - Tel.: +55 (11) 3777-6771 com os dados abaixo preenchidos.	
<b>JVC KENWOOD DO BRASIL COMÉRCIO DE ELETRÔNICOS LTDA</b>	<b>JVC KENWOOD DO BRASIL COMÉRCIO DE ELETRÔNICOS LTDA</b>
<b>Tel: (11) 3777-6771</b>	<b>Tel: (11) 3777-6771</b>
<b><a href="http://www.kenwood.com.br">www.kenwood.com.br</a></b>	<b><a href="http://www.kenwood.com.br">www.kenwood.com.br</a></b>
Nome do consumidor: _____	_____
Endereço: _____ CEP: _____	_____
Cidade: _____ Estado: _____	_____
Telefone: _____	_____
Data da compra: ____ / ____ / ____	Nota Fiscal: _____

<b>CANADA</b>	<b>KENWOOD ELECTRONICS CANADA INC.</b>
<b>KENWOOD WARRANTY</b>	<b>ENTIRE WARRANTY</b>
<p>KENWOOD ELECTRONICS CANADA INC. (hereinafter called "KENWOOD"), gives the following written warranty to the original customer of each new Kenwood product distributed in Canada by KENWOOD and purchased from a dealer authorized by KENWOOD.</p>	<p>This warranty constitutes the entire written warranty given by KENWOOD. No person, party, dealer or service centre or their agents or employees are authorized to extend or enlarge this warranty on behalf of KENWOOD by any written or verbal statement or advertisement or promotion, including any extended warranty program or plan that may be offered by the dealer or service centre, unless approved in writing by KENWOOD.</p>
<p>KENWOOD warrants that each new Kenwood product, under normal use, is free from any defects, subject to the terms and conditions set forth below. If a defect should occur within the warranty period, repairs will be made free of charge for parts and labour when such defects are determined by KENWOOD or its' authorized service centres to be attributable to faulty materials or workmanship at time of manufacture. Please contact KENWOOD to confirm if a dealer or service centre is authorized by KENWOOD.</p>	<p>(e) Defects resulting from disaster, accident, abuse, misuse, lightning, power surges, neglect or lack of periodic maintenance, unauthorized modification or failure to follow instructions in the owner's manual.</p> <p>(f) Defects or damage as a result of repairs performed by a person or party not authorized by KENWOOD.</p> <p>(g) Defects resulting from the use of parts or devices that do not conform to KENWOOD specifications.</p> <p>(h) Damage or deterioration occurring to any exterior finishes, cosmetic parts, tape heads, adaptors, antennas, cables, tapes, discs or faults or damage caused by defective or leaking batteries.</p> <p>(i) Defects or damage occurring during shipping (claims should be presented to the shipping company).</p> <p>(j) Product voltage and /or line frequency conversions.</p> <p>(k) Product installation or removal charges.</p>
<b>WARRANTY PERIOD</b>	<b>DISCLAIMER</b>
<p>This Kenwood product is warranted for parts and labour for a period of one (1) year from the date of original purchase, lease or rental, except for products which are used in a professional or commercial application, which are warranted for a period of ninety (90) days for parts and labour and are subject to the terms and conditions of the warranty.</p>	<p>KENWOOD disclaims any responsibility for loss of time or use of the product or any other indirect, incidental or consequential damage to other products or goods, inconvenience or commercial loss.</p>
<b>WARRANTY EXCLUSIONS</b>	<b>NOTICE TO CONSUMER</b>
<p>This warranty excludes:</p> <ol style="list-style-type: none"> <li>Products purchased in a foreign country or purchased in Canada and taken to a foreign country.</li> <li>Products purchased from a dealer not authorized by KENWOOD.</li> <li>Products with the serial number defaced, altered or missing.</li> <li>Periodic check-ups which do not disclose any defects covered by this warranty.</li> </ol>	<p>The provisions contained in this written warranty are not intended to limit, modify, take away, disclaim or exclude any warranties or rights you may have which are set forth in any applicable provincial or federal laws or legislation.</p>
<b>GARANTIE KENWOOD</b>	<b>IMPORTANT</b>
<p>KENWOOD ELECTRONICS CANADA INC. (ci-après appelée "KENWOOD"), donne par écrit la garantie suivante à l'acheteur original de chaque nouveau produit Kenwood distribué au Canada par KENWOOD et acheté à un concessionnaire autorisé par KENWOOD.</p>	<p>This warranty card by itself is not considered by KENWOOD as a valid proof of purchase. When applying for warranty repairs, you must present the original copy of your bill of sale and this warranty card as proof of warranty, so we recommend that they be kept in a safe place, should they be required in the future.</p>
<p>KENWOOD garantit, sous réserve des termes et des conditions énoncés ci-dessous, que chaque nouveau produit Kenwood, dans des conditions d'emploi normales, est exempt de tous défauts. Si l'un d'eux se produit pendant la période de garantie, KENWOOD s'engage à assumer le coût des pièces défectueuses et de la main-d'œuvre nécessaires pour effectuer les réparations pourvu que de tels défauts sont attribuables à des pièces défectueuses employées lors de la fabrication du produit Kenwood ou à la main-d'œuvre tel qu'établi par KENWOOD ou par l'un de ses centres de service autorisés. Appelez KENWOOD pour vérifier si un concessionnaire ou un centre de service est autorisé par KENWOOD.</p>	<p>(e) les défauts causés par les désastres, les accidents, les abus, les emplois incorrects, les éclairs, les surtensions de courant, les manques de soins ou d'entretiens périodiques, les modifications non autorisées ou les manques de respect du mode d'emploi;</p> <p>(f) les défauts ou les dommages causés lors de réparations effectuées par une personne ou par une partie non autorisée par KENWOOD;</p> <p>(g) les défauts causés par l'emploi de pièces ou de dispositifs qui ne se conforment pas aux exigences de KENWOOD;</p> <p>(h) les finitions extérieures, les pièces cosmétiques, les têtes de bandes, les adaptateurs, les antennes, les câbles, les bandes, les disques endommagés ou déperis, ni les défauts ou dommages causés par des piles défectueuses ou qui fuient;</p> <p>(i) les défauts ou dommages qui se produisent pendant l'expédition des produits Kenwood (On devrait déposer de telles réclamations auprès des compagnies de transport);</p> <p>(j) les conversions de tension et/ou de fréquence du produit;</p> <p>(k) les frais d'installation ou d'enlèvement du produit.</p>
<b>PÉRIODE DE GARANTIE</b>	<b>RENONCIATION</b>
<p>Les pièces et la main-d'œuvre nécessaires pour la réparation des produits Kenwood sont garanties pendant la période d'un (1) an à compter de la date d'achat, de bail ou de location originale, sauf dans les cas où les produits Kenwood sont employés dans un but professionnel ou commercial, où la garantie des pièces et de la main-d'œuvre demeure en vigueur pendant une période de quatre-vingt-dix (90) jours sous réserve des termes et des conditions de la garantie.</p>	<p>KENWOOD renonce à tous ses responsabilités de perte de temps, d'emploi du produit, de tous dommages indirects ou accessoires causés à d'autres produits ou biens, de tous inconvénients ou de toutes pertes commerciales.</p>
<b>EXCLUSIONS DE GARANTIE</b>	<b>AVIS AUX CONSOMMATEURS</b>
<p>Cette garantie ne couvre pas:</p> <ol style="list-style-type: none"> <li>les produits achetés à l'étranger ou achetés au Canada et transportés à l'étranger,</li> <li>les produits achetés à un concessionnaire non autorisé par KENWOOD;</li> <li>les produits dont le numéro de série manque, a été effacé ou modifié;</li> <li>les services d'entretien périodiques qui n'indiquent aucun défaut couvert par cette garantie;</li> </ol>	<p>Les stipulations contenues dans la présente garantie écrite n'ont pas pour but de limiter, de modifier, de diminuer, de rejeter ni d'exclure d'autres garanties ni droits énoncés dans n'importe quelles lois ou législations provinciales ou fédérales.</p>
<b>COMMENT OBTENIR DU SERVICE SOUS GARANTIE</b>	<b>IMPORTANT</b>
<p>Au cas où un service sous garantie de votre produit Kenwood s'avère nécessaire, veuillez livrer le produit à n'importe quel centre de service KENWOOD et présenter la copie originale du contrat de vente et cette carte de garantie en tant que preuve de garantie ou veuillez faire parvenir votre produit assuré et port payé au centre de service KENWOOD autorisé le plus proche. Pour éviter toutes possibilités de dommages pendant le transport, veuillez bien emballer le produit. Veuillez inclure une copie du contrat de vente original et cette carte de garantie en tant que preuve de garantie aussi bien que votre nom, numéros de téléphone au poste de travail et/ou au domicile, votre adresse et une description détaillée des défauts. Les produits sous garantie réparés seront retournés port payé aux destinations à l'intérieur du Canada. Le consommateur sera responsable de tous frais de transport et d'autres frais qui s'y rapportent pour faire expédier les produits à destinations à l'extérieur du Canada.</p>	<p>KENWOOD ne considère pas cette garantie toute seule comme étant une preuve d'achat valide. Lors d'un demande du service sous garantie, il faudra présenter la copie originale du contrat de vente aussi bien que cette carte de garantie en tant que preuve de garantie. On recommande de les conserver dans un lieu sûr au cas où elles s'avèreraient nécessaires à l'avenir.</p>
	<b>KENWOOD ELECTRONICS CANADA INC.</b>
	<b>6070 Kestrel Road, Mississauga, Ontario, Canada L5T 1S8</b>
	<b>Téléphone: (905) 670-7211</b>
	<b>Télécopieur: (905) 670-7248</b>

## Free Manuals Download Website

<http://myh66.com>

<http://usermanuals.us>

<http://www.somanuals.com>

<http://www.4manuals.cc>

<http://www.manual-lib.com>

<http://www.404manual.com>

<http://www.luxmanual.com>

<http://aubethermostatmanual.com>

Golf course search by state

<http://golfingnear.com>

Email search by domain

<http://emailbydomain.com>

Auto manuals search

<http://auto.somanuals.com>

TV manuals search

<http://tv.somanuals.com>