

KENWOOD

CD-RECEIVER

KDC-X591 KDC-MP535U

INSTRUCTION MANUAL

Kenwood Corporation



Take the time to read through this instruction manual.

Familiarity with installation and operation procedures will help you obtain the best performance from your new CD-receiver.

For your records

Record the serial number, found on the back of the unit, in the spaces designated on the warranty card, and in the space provided below. Refer to the model and serial numbers whenever you call upon your Kenwood dealer for information or service on the product.

Model KDC-X591/MP535U Serial number _____

US Residence Only

Register Online

Register your Kenwood product at
www.kenwoodusa.com

Contents

Safety precautions **3**

Notes **4**

General features **7**

- Power
- Selecting the Source
- Volume
- Attenuator
- Audio Control
- Adjusting the detail of Audio Control
- Audio Setup
- Speaker Setting
- Switching Display
- Subwoofer Output
- Theft Deterrent Faceplate
- TEL Mute

Tuner features **12**

- Tuning
- Tuning Mode
- Direct Access Tuning
- Station Preset Memory
- Auto Memory Entry
- Preset Tuning

CD/USB device/Audio file/External disc control features **14**

- Playing CD & Audio file
- Playing USB (iPod) device
- Drive Search
- Playing External Disc
- Fast Forwarding and Reversing
- Music Search
- Disc Search/Folder/Album Search
- Direct Music Search
- Direct Disc Search
- Track/File/Disc/Folder Repeat
- Scan Play
- Random Play
- Magazine Random Play
- All Random Play
- File select
- File Select 1 mode
- File Select 2 mode
- Text/Title Scroll

HD Radio control features **20**

- About HD Radio
- Tuning

Menu system **21**

- Menu System
- Activating Security Code
- Deactivating Security Code
- Touch Sensor Tone
- Manual Clock Adjustment
- DSI (Disabled System Indicator)
- Display Illumination Control
- Dimmer
- Built-in Amp Setting
- Dual Zone System Setting
- Supreme Setting
- AMP Control
- CRSC (Clean Reception System Circuit)
- Receive mode Setting
- Electronic Serial Number (ESN) display
- Auxiliary Input Display Setting
- Text Scroll
- Built-in Auxiliary input Setting
- CD Read Setting
- Audio Preset Memory
- Audio Preset Recall
- Firmware version display
- Demonstration mode Setting

Basic Operations of remote control **28**

Accessories/ Installation Procedure **30**

Connecting Wires to Terminals **31**

Installation **32**

Troubleshooting Guide **34**

Specifications **37**

Safety precautions

⚠ WARNING

To prevent injury or fire, take the following precautions:

- To prevent a short circuit, never put or leave any metallic objects (such as coins or metal tools) inside the unit.
- Do not watch or fix your eyes on the unit's display when you are driving for any extended period.
- Mounting and wiring this product requires skills and experience. For safety's sake, leave the mounting and wiring work to professionals.

⚠ CAUTION

To prevent damage to the machine, take the following precautions:

- Make sure to ground the unit to a negative 12V DC power supply.
- Do not install the unit in a spot exposed to direct sunlight or excessive heat or humidity. Also avoid places with too much dust or the possibility of water splashing.
- Do not place the faceplate (and the faceplate case) in areas exposed to direct sunlight, excessive heat or humidity. Also avoid places with too much dust or the possibility of water splashing.
- To prevent deterioration, do not touch the terminals of the unit or faceplate with your fingers.
- Do not subject the faceplate to excessive shock, as it is a piece of precision equipment.
- When replacing a fuse, only use a new fuse with the prescribed rating. Using a fuse with the wrong rating may cause your unit to malfunction.
- Do not apply excessive force to the open faceplate or place objects on it. Doing so will cause damage or breakdown.
- Use only the screws provided or specified for installation. If you use wrong screws, you could damage the unit.

Attach the panel while you are on the vehicle

The panel lock arm appears when the panel is removed. Therefore, the panel must be attached while the electrical system of the car is operating.

Do Not Load 3-in. CDs in the CD slot

If you try to load a 3 in. CD with its adapter into the unit, the adapter might separate from the CD and damage the unit.

About CD players/disc changers connected to this unit

Kenwood disc changers/ CD players released in 1998 or later can be connected to this unit.

Refer to the catalog or consult your Kenwood dealer for connectable models of disc changers/ CD players. Note that any Kenwood disc changers/ CD players released in 1997 or earlier and disc changers made by other makers cannot be connected to this unit.

Connecting unsupported disc changers/CD players to this unit may result in damage.

Set the "O-N" Switch to the "N" position for the applicable Kenwood disc changers/ CD players.

The functions you can use and the information that can be displayed may differ depending on the models being connected.



- You can damage both your unit and the CD changer if you connect them incorrectly.

Lens Fogging

When you turn on the car heater in cold weather, dew or condensation may form on the lens in the CD player of the unit. Called lens fogging, this condensation on the lens may not allow CDs to play. In such a situation, remove the disc and wait for the condensation to evaporate. If the unit still does not operate normally after a while, consult your Kenwood dealer.

iPod is a trademark of Apple Computer, Inc., registered in the U.S. and other countries.

The "AAC" logo is trademark of Dolby Laboratories.

Notes

- If you experience problems during installation, consult your Kenwood dealer.
- When you purchase optional accessories, check with your Kenwood dealer to make sure that they work with your model and in your area.
- We recommend the use of <Activating Security Code> (page 22) to prevent theft.
- The characters which can be displayed by this unit are A-Z 0-9 @ " ' ` % & * + - = , . / \ < > [] () ; ^ - { } | ~ .
- The illustrations of the display and the panel appearing in this manual are examples used to explain more clearly how the controls are used. Therefore, what appears on the display in the illustrations may differ from what appears on the display on the actual equipment, and some of the illustrations on the display may be inapplicable.

How to reset your unit

- If the unit fails to operate properly, press the Reset button. The unit returns to factory settings when the Reset button is pressed.
- Remove the USB device before pressing the Reset button. Pressing the Reset button with the USB device installed can damage the data contained in the USB device. For how to remove the USB device, refer to <Playing USB (iPod) device> (page 15).
- Press the reset button if the disc auto changer fails to operate correctly. Normal operation should be restored.

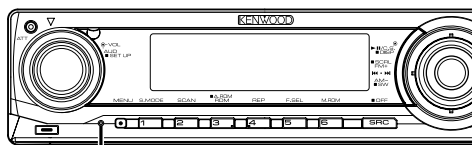

Reset button

Cleaning the Unit

If the faceplate of this unit is stained, wipe it with a dry soft cloth such as a silicon cloth. If the faceplate is stained badly, wipe the stain off with a cloth moistened with neutral cleaner, then wipe it again with a clean soft dry cloth.



- Applying spray cleaner directly to the unit may affect its mechanical parts. Wiping the faceplate with a hard cloth or using a volatile liquid such as thinner or alcohol may scratch the surface or erase characters.

Cleaning the Faceplate Terminals

If the terminals on the unit or faceplate get dirty, wipe them with a clean soft dry cloth.

Before using this unit for the first time

This unit is initially set on the Demonstration mode. When using this unit for the first time, cancel the <Demonstration mode Setting> (page 27).

About KENWOOD "Music Editor" of PC application attached to KDC-X591/MP535U

- "Music Editor" is recorded in the CD-ROM attached to this unit.
- Refer to the attached installation manual for the installation method of "Music Editor".
- Refer to the user's manual recorded in the installation CD-ROM and Help of "Music Editor" for the operation method of "Music Editor".
- The unit can play CD/ USB device created by "Music Editor".
- Information about "Music Editor" upgrade is put on the site, www.kenwood.com.

About Audio file

• Playable Audio file

AAC-LC (.m4a), MP3 (.mp3), WMA (.wma), WAV (.wav)

• Playable disc media

CD-R/RW/ROM

• Playable disc file format

ISO 9660 Level 1/2, Joliet, Romeo, Long file name.

• Playable USB device

USB mass storage class, iPod with KCA-iP200

• Playable USB device file system

FAT16, FAT32

Although the audio files are complied with the standards listed above, the play maybe impossible depending on the types or conditions of media or device.

• Playing order of the Audio file

In the example of folder/file tree shown below, the files are played in the order from ① to ⑩.

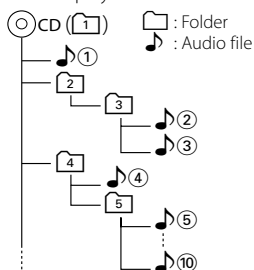

An online manual about audio files is put on the site, www.kenwood.com/audiofile/. On this online manual, detailed information and notes which are not written in this manual are provided. Make sure to read through the online manual as well.



- In this manual, the word "USB device" is used for flash memories and digital audio players which have USB terminals.
- The word "iPod" appearing in this manual indicates the iPod connected with the KCA-iP200 (optional accessory). The iPod connected with the KCA-iP200 can be controlled from this unit. iPods that can be connected with the KCA-iP200 are the iPod nano and the iPod with video. When an iPod is connected using a commercially available USB cable, it is handled as a mass-storage-class device.
- For the supported formats and types of USB device, refer to www.kenwood.com/usb/.

About USB device

- Install the USB device in the place where it will not prevent you from driving your vehicle properly.
- You cannot connect a USB device via a USB hub.
- Take backups of the audio files used with this unit. The files can be erased depending on the operating conditions of the USB device. We shall have no compensation for any damage arising out of erasure of the stored data.
- No USB device comes with this unit. You need to purchase a commercially available USB device.
- For how to play the audio files recorded in a USB device, see <CD/USB device/Audio file/External disc control features> (page 14).
- When connecting the USB device, usage of the CA-U1EX (option) is recommended. Normal playback is not guaranteed when a cable other than the USB compatible cable is used. Connecting a cable whose total length is longer than 5 m can result in abnormal playback.

About Satellite Radio tuner

This unit supports Satellite Radio tuners which are released by SIRIUS and XM.

Refer to the instruction manual of Satellite radio tuner.

Notes

Handling CDs

- Do not touch the recording surface of the CD.
- Do not stick tape etc. on the CD, or use a CD with tape stuck on it.
- Do not use disc type accessories.
- Clean from the center of the disc and move outward.
- When removing CDs from this unit, pull them out horizontally.
- If the CD center hole or outside rim has burrs, use the CD only after removing the burrs with a ballpoint pen etc.

CDs that cannot be used

- CDs that are not round cannot be used.

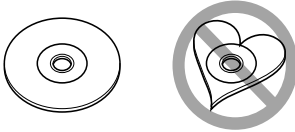

- CDs with coloring on the recording surface or CDs that are dirty cannot be used.
- This unit can only play the CDs with .
This unit may not correctly play discs which do not have the mark.
- You cannot play a CD-R or CD-RW that has not been finalized. (For the finalization process refer to your CD-R/CD-RW writing software, and your CD-R/CD-RW recorder instruction manual.)

▲CAUTION

Use of controls or adjustments or performance of procedures other than those specified herein may result in hazardous radiation exposure. In compliance with Federal Regulations, following are reproductions of labels on, or inside the product relating to laser product safety.

Kenwood Corporation
2967-3, ISHIKAWA-MACHI,
HACHIOJI-SHI
TOKYO, JAPAN

KENWOOD CORP. CERTIFIES THIS EQUIPMENT
CONFORMS TO DHHS REGULATIONS NO.21 CFR
1040. 10, CHAPTER 1, SUBCHAPTER J.

Location : Bottom Panel

FCC WARNING

This equipment may generate or use radio frequency energy. Changes or modifications to this equipment may cause harmful interference unless the modifications are expressly approved in the instruction manual. The user could lose the authority to operate this equipment if an unauthorized change or modification is made.

NOTE

This equipment has been tested and found to comply with the limits for a Class B digital device, pursuant to Part 15 of the FCC Rules. These limits are designed to provide reasonable protection against harmful interference in a residential installation. This equipment may cause harmful interference to radio communications, if it is not installed and used in accordance with the instructions. However, there is no guarantee that interference will not occur in a particular installation. If this equipment does cause harmful interference to radio or television reception, which can be determined by turning the equipment off and on, the user is encouraged to try to correct the interference by one or more of the following measures:

- Reorient or relocate the receiving antenna.
- Increase the separation between the equipment and receiver.
- Connect the equipment into an outlet on a circuit different from that to which the receiver is connected.
- Consult the dealer or an experienced radio/TV technician for help.

General features

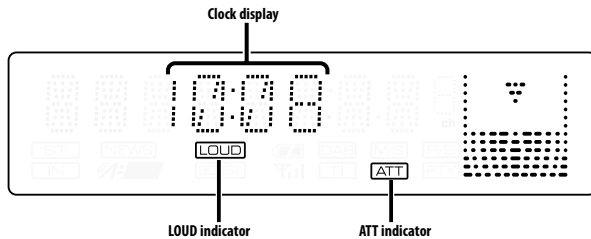
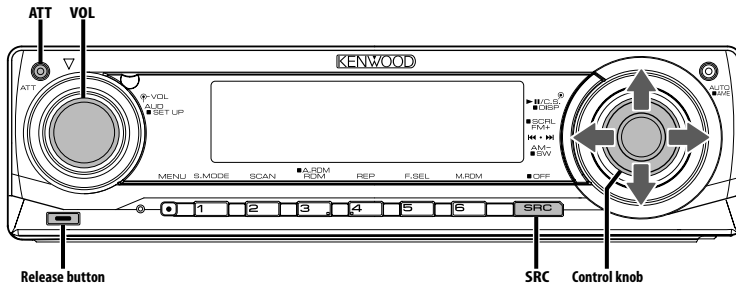

Power

Turning ON the Power

Press the [SRC] button.

Turning OFF the Power

Press the [SRC] button for at least 1 second.

Selecting the Source

Press the [SRC] button.

Source required	Display
Satellite radio (Optional accessory)	"SAT"
Tuner or HD Radio (Optional accessory)	"TUNER" or "HD RADIO"
USB device (iPod)	"USB" ("iPod")
CD	"CD"
External disc (Optional accessory)	"CD CH"
Auxiliary input	"AUX"
Auxiliary input (Optional accessory)	"AUX EXT"
Standby (Illumination only mode)	"STANDBY"



- When connection of the iPod is recognized, the source display changes from "USB" to "iPod".
- USB (iPod) source is recognized as CD source on the connected unit.

Volume

Increasing Volume

Turn the [VOL] knob clockwise.

Decreasing Volume

Turn the [VOL] knob counterclockwise.

Attenuator

Turning the volume down quickly.

Press the [ATT] button.

Each time you press the button, the Attenuator turns ON and OFF.

When the Attenuator is ON, the "ATT" indicator blinks.

General features

Audio Control

1 Select the source to adjust

Press the [SRC] button.

2 Enter Audio Control mode

Press the [VOL] knob.

3 Select the Basic Audio item to adjust

Press the [VOL] knob.

Each time you press the knob, the item to be adjusted alternates between the items shown in the table below.

4 Adjust the Basic Audio item

Turn the [VOL] knob.

Adjustment Item	Display	Range
Rear Volume	"R-VOL"	0 — 35
Subwoofer level	"SW L"	-15 — +15
System Q	"USER"/"ROCK"/"POPS"/ "EASY"/"TOP40"/"JAZZ"/ "NATURAL"	User/Rock/Pops/ Easy/Top 40/Jazz/ Natural
Bass level*	"BAS L"	-8 — +8
Middle level*	"MID L"	-8 — +8
Treble level*	"TRE L"	-8 — +8
Balance	"BAL"	Left 15 — Right 15
Fader	"FAD"	Rear 15 — Front 15

Exit Audio Control mode (Volume control mode)

* You can adjust these items in detail. Refer to <Adjusting the detail of Audio Control> (Page8). (Function of KDC-X591)

* Source tone memory: Puts the set up value in the memory per source. (Detail Audio item is included)

About System Q

- You can recall the best preset sound setting for different types of music.
- Change each setting value with the <Speaker Setting> (page 9). First, select the speaker type with the Speaker setting.
- "USER": The ranges selected lastly for Bass level, Middle level, and Treble level are recalled automatically.

5 Exit Audio Control mode

Press any button.

Press a button other than the [VOL] knob and [ATT] button.

Function of KDC-X591

Adjusting the detail of Audio Control

Among the Basic Audio items, you can adjust the Bass level, Middle level, and Treble level in detail.

1 Select the Basic Audio item

Select the desired item to be set in detail from followings;

- Bass level
- Middle level
- Treble level

For how to select Basic Audio items, see <Audio Control> (page 8).

2 Enter Detail adjustment mode of Audio Control

Press the [VOL] knob for at least 1 second.

3 Select the Detail Audio item to adjust

Press the [VOL] knob.

Each time you press the knob, the item to be adjusted alternates between the items shown in the table below.

4 Adjust the Detail Audio item

Turn the [VOL] knob.

Bass level

Adjustment Item	Display	Range
Bass Center Frequency	"BAS F"	40/50/60/70/80/100/ 120/150 Hz
Bass Q Factor	"BAS Q"	1.00/1.25/1.50/2.00
Bass Extend	"B EX"	OFF/ON

Middle level

Adjustment Item	Display	Range
Middle Center Frequency	"MID F"	0.5/1.0/1.5/2.0 kHz
Middle Q Factor	"MID Q"	1.0/2.0

Treble level

Adjustment Item	Display	Range
Treble Center Frequency	"TRE"	10.0/12.5/15.0/17.5 kHz

5 Exit the Detail Audio Control mode

Press the [VOL] knob for at least 1 second.



- When you set the Bass Extend to ON, low frequency response is extended by 20%.
- You can exit the Audio Control mode at anytime by pressing any button except for [VOL] knob and [ATT] button.

Audio Setup

Setting the Sound system, such as Cross over Network.

1 Select the source to adjust

Press the [SRC] button.

2 Enter Audio Setup mode

Press the [VOL] knob for at least 1 second.

3 Select the Audio Setup item to adjust

Press the [VOL] knob.

Each time you press the knob, the item to be adjusted alternates between the items shown in the table below.

4 Setup the Audio item

Turn the [VOL] knob.

Adjustment Item	Display	Range
Front High Pass Filter	"HPF"	Through/40*/60*/80/100/120/ 150/180/220* Hz
Rear High Pass Filter	"HPR"	Through/40*/60*/80/100/120/ 150/180/220* Hz
Low Pass Filter	"LPF"	50*/60/80/100*/120/ Through Hz
Subwoofer Phase	"PHAS"	Reverse (180°)/ Normal (0°)
Volume offset	"V-OFF"	-8 — ±0 (AUX; -8 — +8)
Loudness	"LOUD"	OFF/ON
Dual Zone System	"2ZON"	OFF/ON



- * Function of KDC-X591.
- Volume offset: Sets each source's volume as a difference from the basic volume.
- Loudness: Compensates for low and high tones during low volume. (Only the low tone is compensated for when the tuner is selected as a source.)
- Dual Zone System
 - Main source and sub source (Auxiliary input) output Front channel and Rear channel separately.
 - - Set up the channel of sub source by <Dual Zone System Setting> (page 24).
 - - Select Main source by [SRC] button.
 - - Adjust the volume of Front channel by [VOL] knob.
 - - Adjust the volume of Rear channel by <Audio Control> (page 8).
 - - The Audio Control has no effect on sub source.
- You can use the Dual Zone System with the internal auxiliary input.

5 Exit Audio Setup mode

Press the [VOL] knob for at least 1 second.

Speaker Setting

Fine-tuning so that the System Q value is optimal when setting the speaker type.

1 Enter Standby

Press the [SRC] button.

Select the "STANDBY" display.

2 Enter Speaker Setting mode

Press the [VOL] knob.

3 Select the Speaker type

Turn the [VOL] knob.

Each time you turn the knob, the setting alternates between the settings shown in the table below.

Speaker type	Display
OFF	"SP OFF"
For 5 & 4 in. speaker	"SP 5/4"
For 6 & 6x9 in. speaker	"SP 6*9/6"
For the OEM speaker	"SP OEM"

4 Exit Speaker Setting mode

Press the [VOL] knob.

General features

Switching Display

Changing the information displayed.

1 Enter Switching Display mode

Press the Control knob for at least 1 second.

"DISP SEL" is displayed.

2 Select the Display item

Push the Control knob towards right or left.

In Tuner source

Information	Display
Frequency	"FREQ"
Clock	"CLOCK"

In CD & External disc source

Information	Display
Disc title	"D-TITLE"
Track title	"T-TITLE"
Track number & Play time	"P-TIME"
Clock	"CLOCK"

In Audio file source

Information	Display
Music title & Artist name	"TITLE"
Album name & Artist name	"ALBUM"
Folder name*	"FOLDER"
File name	"FILE"
Play time & Music number	"P-TIME"
Clock	"CLOCK"

In HD Radio source

Information	Display
Station name	"ST NAME"
Music title/ Artist name/ Album name/ Genre	"TITLE"
Frequency	"FREQ"
Clock	"CLOCK"

In Satellite radio source

Information	Display
Channel name	"CH NAME"
Music title	"SONG"
Artist name	"ARTIST"
Composer name	"COMPOSER"
Category name	"CATEGORY"
Label name	"LABEL"
Comment	"COMMENT"
Band & Channel number	"CH NUM"

Clock	"CLOCK"
-------	---------

In Standby/ Auxiliary input source

Information	Display
Source name	"SRC NAME"
Clock	"CLOCK"

3 Exit Switching Display mode

Press the Control knob.



- When LX-AMP is connected, the item setup by the Display mode of LX-AMP is displayed. (KDC-X591 only)
- When the music number exceeds 1000, only the last 3 digits of its number are displayed.
- When you select the clock display, the display setting of each source will be changed to the clock display.
- Music title, Artist name, and Album name cannot be displayed in WAV file.
- If the selected display item does not have any information, alternative information is displayed.
- * When playing music from iPod or music edited by "Music Editor", the folder name display may show something different such as playlist or artist name depending on the music selection procedure.

Subwoofer Output

Turning the Subwoofer output ON or OFF.

Push the Control knob toward down for at least 2 seconds.

Each time you push the knob, Subwoofer output switches ON and OFF.

When it is ON, "SW ON" is displayed.

Theft Deterrent Faceplate

The faceplate of the unit can be detached and taken with you, helping to deter theft.

Removing the Faceplate

1 Press the Release button.

Drop open the faceplate.

2 Drawing the faceplate to left side pull it to forward and remove it.

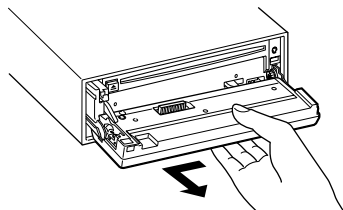

- The faceplate is a precision piece of equipment and can be damaged by shocks or jolts.
- Keep the faceplate in its faceplate case while detached.
- Do not expose the faceplate (and the faceplate case) to direct sunlight or excessive heat or humidity. Also avoid places with too much dust or the possibility of water splashing.

Reattaching the Faceplate

1 Align the shaft on the unit with the depression on the faceplate.

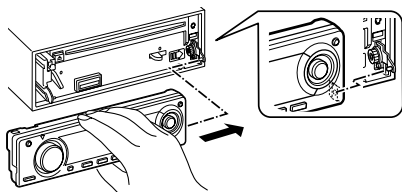

2 Push the faceplate in until it clicks.

The faceplate is locked in place, allowing you to use the unit.

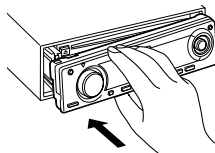

TEL Mute

The audio system automatically mutes when a call comes in.

When a call comes in

"CALL" is displayed.

The audio system pauses.

Listening to the audio during a call

Press the [SRC] button.

The "CALL" display disappears and the audio system comes back ON.

When the call ends

Hang up the phone.

The "CALL" display disappears and the audio system comes back ON.



- To use the TEL Mute feature, you need to hook up the MUTE wire to your telephone using a commercial telephone accessory. Refer to <Connecting Wires to Terminals> (page 31).

Tuner features

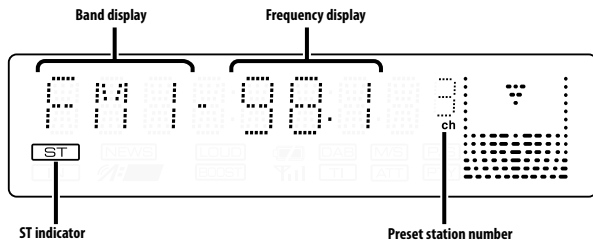
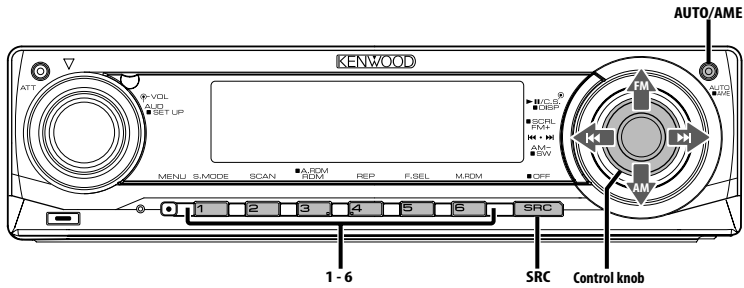

Tuning

Selecting the station.

1 Select tuner source

Press the [SRC] button.

Select the "TUNER" display.

2 Select the band

Push the Control knob towards [FM] or [AM].

Each time you push the knob toward [FM], it switches between the FM1, FM2, and FM3 bands.

3 Tune up or down band

Push the Control knob towards [◀◀] or [▶▶].



- During reception of stereo stations the "ST" indicator is ON.

Tuning Mode

Choose the tuning mode.

Press the [AUTO] button.

Each time you press the button, the Tuning mode alternates between the modes shown in the table below.

Tuning mode	Display	Operation
Auto seek	"AUTO 1"	Automatic search for a station.
Preset station seek	"AUTO 2"	Search in order of the stations in the Preset memory.
Manual	"MANUAL"	Normal manual tuning control.

Function of remote control

Direct Access Tuning

Entering the frequency and tuning.

1 Select the band

Press the [FM] or [AM] button.

2 Enter Direct Access Tuning mode

Press the [DIRECT] button on the remote control.

"- - - -" is displayed.

3 Enter the frequency

Press the number buttons on the remote control.

Example:

Desired frequency	Press button
92.1 MHz (FM)	[0], [9], [2], [1]
810 kHz (AM)	[0], [8], [1], [0]

Canceling Direct Access Tuning

Press the [DIRECT] button on the remote control.

Station Preset Memory

Putting a station in the memory.

1 Select the band

Push the Control knob towards [FM] or [AM].

2 Select the frequency to put in the memory

Push the Control knob towards [◀◀] or [▶▶].

3 Put the frequency in the memory

Press the desired [1] — [6] button for at least 2 seconds.

The preset number display blinks 1 time.

On each band, 1 station can be put in the memory on each [1] — [6] button.

Auto Memory Entry

Putting stations with good reception in the memory automatically.

1 Select the band for Auto Memory Entry

Push the Control knob towards [FM] or [AM].

2 Open Auto Memory Entry

Press the [AME] button for at least 2 seconds.

"A-MEMORY" is displayed.

When 6 stations that can be received are put in the memory Auto Memory Entry closes.

Preset Tuning

Recalling the stations in the memory.

1 Select the band

Push the Control knob towards [FM] or [AM].

2 Recall the station

Press the desired [1] — [6] button.

CD/USB device/Audio file/External disc control features

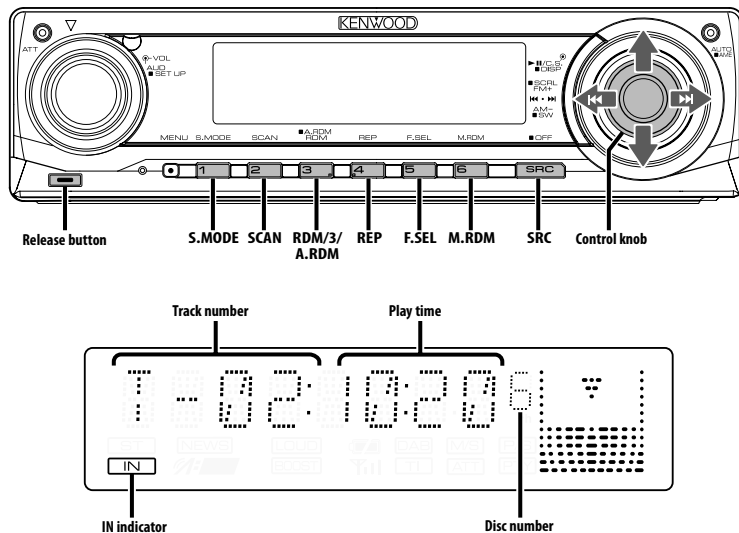

Playing CD & Audio file

When there is no disc inserted

- 1 Drop open the faceplate**
Press the Release button.
- 2 Insert a disc.**
- 3 Push the faceplate on the left side, and return it to its former position.**



- When the faceplate has been dropped open, it might interfere with the shift lever or other vehicle function. If this happens, pay attention to safety and move the shift lever or take an appropriate action to remove the obstacle, then operate the unit.
- Do not use the unit with the faceplate in the open condition. If it's used in the open position dust can enter the inside part and cause damage.



- For the audio files and discs you can play with this unit, refer to <About Audio file> (page 5).
- You can play the file made by KENWOOD Music Editor by the same operation.
- When a disc is inserted, the "IN" indicator is ON.

When a disc is inserted

- Press the [SRC] button.
Select the "CD" display.

Pause and play

- Press the Control knob.
Each time you press the knob, the audio pauses or plays.

Eject the disc

- 1 Drop open the faceplate**
Press the Release button.
- 2 Eject the disc**
Press the [▲] button.

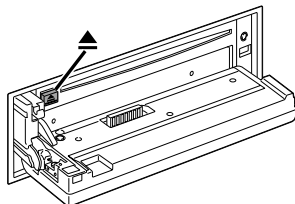

- 3 Press the faceplate on the left side, and return it to its former position.**



- You can eject the disc for 10 minutes after switching off the engine.

Playing USB (iPod) device

When the USB device is not connected

Connect the USB device

Playback of the file contained in the USB device starts.

When the USB device is connected

Select USB source

Press the [SRC] button.

Select the "USB" (or "iPod") display.



- For the audio files that can be played with this unit and the devices that can be connected to this unit, refer to <About Audio file> (page 5).
- The word "iPod" appearing in this manual indicates the iPod connected with the KCA-iP200 (optional accessory). Refer to <About Audio file> (page 5).
- If you start playback after connecting the iPod, the music that has been played by the iPod is played first. In this case, "RESUMING" is displayed without displaying a folder name, etc. Changing the browse item will display a correct title, etc.
- When the iPod is connected to this unit, "KENWOOD" or "✓" is displayed on the iPod to indicate that you cannot operate the iPod.
- When the USB device is connected to this unit, it can be charged up provided that this unit is powered.
- When the Multi Card Reader is used, refer to <Drive Search> (page 15).
- After you stopped playing a file contained in the USB device, you can restart playing the file from the point where you stopped its playback. Even after removing the USB device, you can restart playing the file from the point where you stopped its playback as long as the files contained in the USB device are all the same.
- Be sure to insert the USB device connector as far as it will go.
- You can play the file made by KENWOOD Music Editor by the same operation.

Pause and play

Press the Control knob.

Each time you press the knob, the audio pauses or plays.

Removing the USB device

- 1 Drop open the faceplate**
Press the Release button.
- 2 Set the remove mode as the USB source**
Press the [▲] button for at least 2 seconds.
The ▲ indicator blinks.
- 3 Remove the USB device.**

Drive Search

Selecting the device inserted in the Multi Card Reader.

- 1 Put the playback to pause**
Press the [S.MODE] button.
- 2 Select a device**
Push the Control knob towards up or down.
- 3 Restart playback**
Press the [S.MODE] button.



- This unit is compliant with Multi Card Readers with a maximum of 4 slots.
- If a device is inserted during connection of the Multi Card Reader, it is not recognized. Select the Remove mode with reference to <Playing USB (iPod) device> (page 15), remove the Card Reader, and then insert the memory.

CD/USB device/Audio file/External disc control features

Playing External Disc

Playing discs set in the optional accessory disc player connected to this unit.

Press the [SRC] button.

Select the display for the disc player you want.

Display examples:

Display	Disc player
"CD CH"	CD changer
"MD CH"	MD changer

Pause and play

Press the Control knob.

Each time you press the knob, the audio pauses or plays.



- Disc 10 is displayed as "0".
- The functions that can be used and the information that can be displayed will differ depending on the external disc players being connected.

Fast Forwarding and Reversing

Fast Forwarding

Hold down toward [▶▶] with the Control knob.

Release to resume the playback.

Reversing

Hold down toward [◀◀] with the Control knob.

Release to resume the playback.



- The accurate play time is not displayed during fast forwarding or reversing of the Audio file.

Music Search

Switching between music contained in the disc or folder being played now.

Push the Control knob towards [◀◀] or [▶▶].

Function of disc changer/ Audio file

Disc Search/Folder/Album Search

Switching between folders/albums contained in the disc in the disc changer, media, or device being played now.

Push the Control knob towards up or down.

Function of remote control

Direct Music Search

Doing Music Search by entering the music number.

1 Enter the music number

Press the number buttons on the remote control.



- You can select Direct music Search up to 999.

2 Do music Search

Press the [◀◀] or [▶▶] button.

Canceling Direct Music Search

Press the [▶II] button.



- This function is not available on iPod and the music edited by "Music Editor".

Function of disc changers with remote control

Direct Disc Search

Doing Disc Search by entering the disc number.

1 Enter the disc number

Press the number buttons on the remote control.

2 Do Disc Search

Press the [+] or [-] button.

Canceling Direct Disc Search

Press the [▶II] button.



- Input "0" to select disc 10.

Track/File/Disc/Folder Repeat

Replaying the music, disc in the Disc changer or Audio file folder you are listening to.

Press the [REP] button.

Each time you press the button, the Repeat Play alternates between the modes shown in the tables below.

In CD & External disc source

Repeat play	Display
Track Repeat	"TRAC REP"
Disc Repeat (In Disc Changer)	"DISC REP"
OFF	"REP OFF"

In Audio file source

Repeat play	Display
File Repeat	"FILE REP"
Folder Repeat*	"FOLD REP"
OFF	"REP OFF"



- * This function is not available on iPod and the music edited by "Music Editor".

Scan Play

Playing the first part of each music on the disc or Audio file folder you are listening to and searching for the music you want to hear.

1 Start Scan Play

Press the [SCAN] button.

"TRAC SCN"/"FILE SCN"/"SCAN ON" is displayed.

2 Release it when the music you want to listen to is played

Press the [SCAN] button.



- This function is not available on iPod and the music edited by "Music Editor".

Random Play

Play all the music on the disc or Audio file folder in random order.

Press the [RDM] button.

Each time you press the button, Random Play turns ON or OFF.

When the Random mode is ON, "DISC RDM"/"FOLD RDM"/"RDM ON" is displayed.



- When you push the Control knob toward [▶▶], the next selected music starts.

Function of disc changer

Magazine Random Play

Play the music on all the discs in the disc changer in random order.

Press the [M.RDM] button.

Each time you press the button, the Magazine Random Play turns ON or OFF.

When the Magazine Random mode is ON, "MGZN RDM" is displayed.



- When you push the Control knob toward [▶▶], the next selected music starts.

CD/USB device/Audio file/External disc control features

Function of Audio file

All Random Play

Playing randomly from all of the Audio files recorded in the media.

Press the [A.RDM] button for at least 1 second.

When the random mode is ON, "ALL RDM" is displayed.

Cancelling the All Random Play

Press the [A.RDM] button.



- When you push the Control knob toward [▶▶], the next selected music starts.
- This function is not available on iPod and the music edited by "Music Editor".

Function of iPod, "Music Editor" file

File select

Selecting the music you want to listen to from the device or media being played now.

1 Enter File Select mode

Press the [F.SEL] button.

Select the "F-SEL" display.

2 Search for a music

Select the category item using the Control knob.

Operation type	Operation
Movement between items	Push the Control knob towards right or left.
Selection of item	Press the Control knob.
Return to previous item	Push the Control knob for at least 1 second.
Return to first item	Press the [3] button.

Names of all the music are displayed in "SONGS" in the audio file.

Selecting a music will play it from the beginning.

Cancelling File Select

Press the [F.SEL] button.

Function of non-iPod and non-"Music Editor" file

File Select 1 mode

Select the target folder by tracing the hierarchical levels of folders. This is convenient when managing audio files by folder.

1 Enter Folder Select 1 mode

Press the [F.SEL] button.

Select the "F-SEL1" display.

Folder name display

Displays the current folder name.

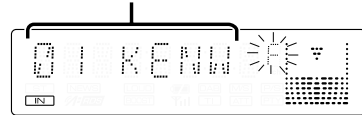

2 Select the folder

Operation type	Operation
Movement between folders	Push the Control knob towards right or left.
Selection of folder	Push the Control knob towards up.
Return to previous folder	Push the Control knob towards down.
Return to root folder	Press the [3] button.

Select the folder containing the music you want to listen to.

3 Determine the folder

Press the Control knob.

The music in the determined folder are displayed.

4 Select the music you want to listen to

Operation type	Operation
Movement between music	Push the Control knob towards right or left.
Return to folder selection step	Press the Control knob for at least 1 second.
Return to root folder	Press the [3] button.

5 Play the selected music

Press the Control knob.

Scrolling the file/folder name display

Push the Control knob toward up for at least 2 seconds.

Cancelling File Select 1

Press the [F.SEL] button twice.

Function of non-iPod and non-"Music Editor" file

File Select 2 mode

Select the target folder within the folders containing audio files. The folder which contains playable audio files is only displayed.

1 Enter Folder Select 2 mode

Press the [F.SEL] button twice.

Select the "F-SEL2" display.

Folder name display

Displays the current folder name.

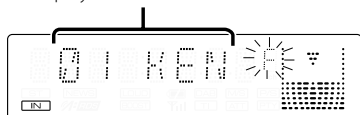

2 Select the folder

Push the Control knob towards right or left.

Each time you push the knob, the folders containing audio files are displayed one after another.

Check the name of upper level folder

Push the Control knob towards up.

Each time you push the knob towards up, the folder just above the current folder is displayed. Each time you push the knob towards down, the folder just below the current folder is displayed. "M" is displayed while the upper level folder is displayed.

3 Determine the folder

Press the Control knob.

The music in the determined folder are displayed.

4 Select the music you want to listen to

Operation type	Operation
Movement between music	Push the Control knob towards right or left.
Return to folder selection step	Press the Control knob for at least 1 second.

5 Play the selected music

Press the Control knob.

Scrolling the file/folder name display

Push the Control knob toward up for at least 2 seconds.

Cancelling Folder Select 2

Press the [F.SEL] button.

Text/Title Scroll

Scrolling the displayed CD text, Audio file text, or MD title.

Push the Control knob toward up for at least 2 seconds.



- When the <Display Illumination Control> (page 23) is set to OFF, the display may black out while scrolling.

HD Radio control features

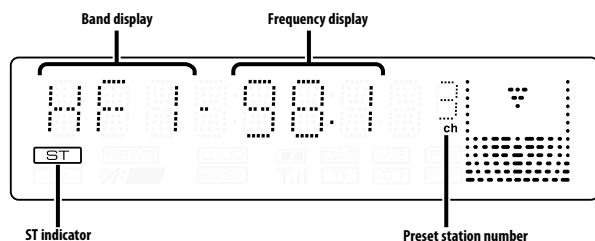
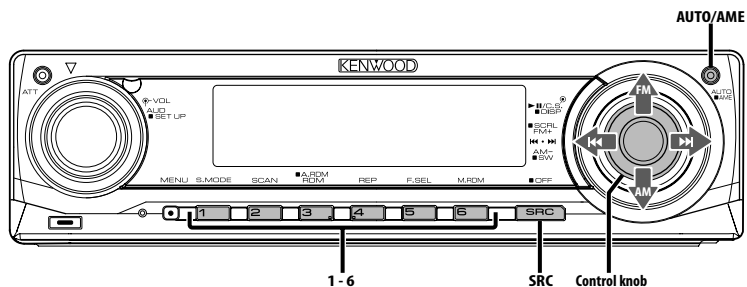

About HD Radio

- When you connect an HD Radio, Tuner features of the unit are disabled and changed to HD Radio tuner features. A portion of the setting methods including the Tuning Mode will change.
- With the HD Radio tuner, you can use the similar functions to <Station Preset Memory>, <Auto Memory Entry>, <Tuning Mode> and <Preset Tuning> of Tuner features. Refer to Tuner features for how to use the functions.

Tuning

Selecting the station.

1 Select HD Radio source

Press the [SRC] button.

Select the "HD RADIO" display.

2 Select the HD FM band

Push the Control knob toward [FM].

Each time you push the knob to [FM], the band alternates between the HF1, HF2, and HF3 bands.

Select the HD AM band

Push the Control knob toward [AM].

3 Tune up or down band

Push the Control knob towards [◀◀] or [▶▶].

Menu system

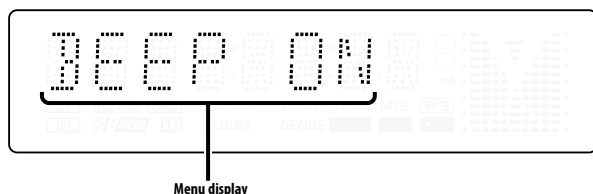
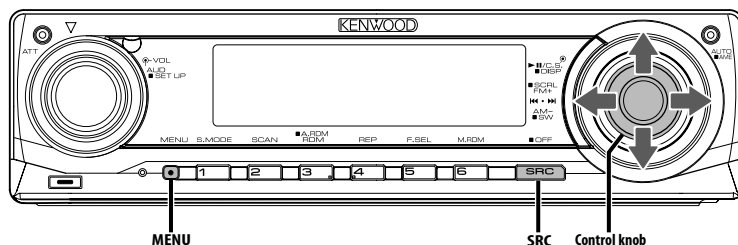

Menu System

Setting beep sound during operation, etc. functions.

The Menu system basic operation method is explained here. The reference for the Menu items and their setting content is after this operation explanation.

1 Enter Menu mode

Press the [MENU] button.

"MENU" is displayed.

2 Select the menu item

Push the Control knob towards up or down.

Example: When you want to set the beep sound select the "BEEP" display.

3 Set the menu item

Push the Control knob towards right or left.

Example: When you select "BEEP", each time you push the knob it alternates between "BEEP ON" or "BEEP OFF". Select 1 of them as the setting.

You can continue by returning to step 2 and setting other items.

4 Exit Menu mode

Press the [MENU] button.



- When other items those applicable to the basic operation method above are displayed, their setting content chart is entered. (Normally the setting listed at the top of the chart is the original setting.) Also, the explanation for items that are not applicable (<Manual Clock Adjustment> etc.) are entered step by step.

Menu system

In Standby mode

Activating Security Code

Activating the Security Code disables the usage of audio unit by someone else. Once the Security Code is activated, the entry of authorized Security Code is required to turn on the audio unit when it is removed from the vehicle. Indication of this Security Code activation prevents your precious audio unit from stealing.



- You can set the Security Code with a 4 digit number of your choice.
- The Security Code cannot be displayed or referenced. Make a note of the Security Code and treasure it up.

1 Enter Standby

Press the [SRC] button.

Select the "STANDBY" display.

2 Enter Menu mode

Press the [MENU] button.

When "MENU" is displayed, "CODE SET" is also displayed.

3 Enter Security Code mode

Press the Control knob for at least 1 second.

When "ENTER" is displayed, "CODE" is also displayed.

4 Select the digits to enter

Push the Control knob towards right or left.

5 Select the Security Code numbers

Push the Control knob towards up or down.

6 Repeat step 4 and 5, and complete the Security Code.

7 Confirm the Security Code

Press the Control knob for at least 3 seconds.

When "RE-ENTER" is displayed, "CODE" is also displayed.

8 Do the step 4 through 7 operation, and reenter the Security Code.

"APPROVED" is displayed.

The Security Code function activates.



- If you enter the wrong code in step 4 through 6, repeat from step 4.

9 Exit Security Code mode

Press the [MENU] button.

Resetting the Security Code function when the audio unit is first used after removed from the battery power source or the Reset button is pressed

1 Turn the power ON.

2 Do the step 4 through 7 operation, and enter the Security Code.

"APPROVED" is displayed.

Now, you can use the unit.



- When the Security Code function is activated, "CODE SET" changes to "CODE CLR".
- To deactivate the Security Code function, see the next section <Deactivating Security Code>.

In Standby mode

Deactivating Security Code

To deactivate the Security Code function.

1 Select Security Code mode

Push the Control knob towards up or down.

Select the "CODE CLR" display.

2 Enter Security Code mode

Press the Control knob for at least 1 second.

When "ENTER" is displayed, "CODE" is also displayed.

3 Select the digits to enter

Push the Control knob towards right or left.

4 Select the Security Code numbers

Push the Control knob towards up or down.

5 Repeat step 3 and 4, and complete the Security Code.

6 Press the Control knob for at least 3 seconds.

"CLEAR" is displayed.

The Security Code function deactivates.

7 Exit Security Code mode

Press the [MENU] button.



- If a wrong security code is entered, "ERROR" is displayed. Enter a correct security code.

In Standby mode

Touch Sensor Tone

Setting the operation check sound (beep sound) ON/OFF.

Display	Setting
"BEEP ON"	Beep is heard.
"BEEP OFF"	Beep canceled.

In Standby mode

Manual Clock Adjustment

1 Select Clock Adjustment mode

Push the Control knob towards up or down.

Select the "CLK ADJ" display.

2 Enter Clock Adjust mode

Press the Control knob for at least 1 second.

The clock display blinks.

3 Adjust the hours

Push the Control knob towards up or down.

Adjust the minutes

Push the Control knob towards right or left.

4 Exit Clock adjustment mode

Press the [MENU] button.

In Standby mode

DSI (Disabled System Indicator)

A red indicator will blink on the unit after the faceplate is removed, warning potential thieves.

Display	Setting
"DSI ON"	LED flashes.
"DSI OFF"	LED OFF.

Display Illumination Control

This function turns off the display when you perform no operation for 5 seconds. This function is effective when you are driving at night.

Display	Setting
"DISP ON"	Keeps the display on.
"DISP OFF"	Turns off the display when you perform no operation for 5 seconds.



- Set the Display Illumination Control when the <Demonstration mode Setting> (page 27) is set to OFF.
- When the display is off, pressing any key will turn on the display.
- When the display is off, you cannot perform any operation except for the following:
 - Volume
 - Attenuator
 - Selecting the source
 - Turning off the power
- During function control, such as the Menu System, the display stays on.

In Standby mode

Dimmer

Dimming this unit's display automatically when the vehicle light switch is turned ON.

Display	Setting
"DIM AUTO"	The display dims.
"DIM OFF"	The display doesn't dim.

Menu system

In Standby mode

Built-in Amp Setting

Controlling the built-in amplifier.
Turning OFF this control enhances the preout quality.

Display	Setting
"AMP ON"	The built-in amplifier activates.
"AMP OFF"	The built-in amplifier deactivates.

Other than Standby mode/
When the Dual Zone System is ON

Dual Zone System Setting

Setting the Front channel and Rear channel sound in the Dual Zone System.

Display	Setting
"ZONE2 R"	Sub source (Auxiliary input source) is to be rear channel.
"ZONE2 F"	Sub source (Auxiliary input source) is to be front channel.

In Audio file source

Supreme Setting

When AAC, MP3 or WMA files encoded at a low bit rate (less than 96kbps (fs=44.1k, 48kHz)) are played, this function restores their high frequency region to approach the sound quality of equivalents of these files encoded at a high bit rate. Processing is optimized for the compression format used (AAC, MP3, or WMA), and adjustment is made for the bit rate used.

Display	Setting
"SPRM ON"	Plays sound using the Supreme function.
"SPRM OFF"	Plays the original sound stored in the audio file.



- The sound effect may be imperceptible depending on the relationship between the audio file format and setting.
- This function is not available on iPod.

Function of KDC-X591

When LX AMP unit connecting

AMP Control

You can control the LX AMP connected to the unit.

1 Select AMP Control mode

Push the Control knob towards up or down.

Select the "AMS CTRL" display.

2 Enter AMP Control mode

Press the Control knob for at least 1 second.

3 Select the AMP Control item for adjustment

Push the Control knob towards up or down.



- For the details on the AMP Control item, see the Instruction manual attached to the LX AMP.

4 Adjust the AMP Control item

Push the Control knob towards right or left.

5 Exit AMP Control mode

Press the [MENU] button.



- You cannot use the LX AMP operation during standby mode.

In FM reception

CRSC (Clean Reception System Circuit)

Temporarily have reception alternate from stereo to mono to reduce multi-path noise when listening to the FM station.

Display	Setting
"CRSC ON"	The CRSC is ON.
"CRSC OFF"	The CRSC is OFF.



- Strong electrical fields (such as from power lines) may cause unstable sound quality when CRSC is turned ON. In such a situation, turn it OFF.

In HD Radio mode

Receive mode Setting

Sets the receive mode.

1 Select the Receive mode

Push the Control knob towards up or down.

Select the "HDR MODE" display.

2 Enter Receive mode

Press the Control knob for at least 1 second.

3 Set the Receive mode

Push the Control knob towards up or down.

Each time you push the knob, the Receive mode alternates between the modes shown in the table below.

Receive mode	Display	Operation
Auto mode	"AUTO"	Analog broadcasts and digital broadcasts will be switched automatically. When both are being transmitted, the digital broadcast will have priority.
Digital	"DIGITAL"	Digital broadcasts only.
Analog	"ANALOG"	Analog broadcasts only.

4 Exit Receive mode

Press the [MENU] button.



- Even if the Receive mode is set to "AUTO", when the Ball game mode program (non-delayed broadcast program) is received, the Receive mode will automatically switch to Analog broadcast only.

In Satellite radio source

Electronic Serial Number (ESN) display

Displaying the Electronic Serial Number.

Display

"ESN = *****"



- Electronic Serial Number (ESN)
It is important to retain the unit serial number and the electronic Satellite radio Identification number for service activation and potential service changes.

Auxiliary Input Display Setting

Selecting the display when changing to Auxiliary input source.

1 Select Auxiliary input source

Press the [SRC] button.

Select the "AUX"/"AUX EXT" display.

2 Enter Menu mode

Press the [MENU] button.

"MENU" is displayed.

3 Select Auxiliary input display setting mode

Push the Control knob towards up or down.

Select the "NAME SET" display.

4 Enter Auxiliary input display setting mode

Press the Control knob for at least 1 second.

The presently selected Auxiliary input display is displayed.

5 Select the Auxiliary input display

Push the Control knob towards right or left.

Each time you push the knob, the display alternates as listed below.

- "AUX"/"AUX EXT"
- "DVD"
- "PORTABLE"
- "GAME"
- "VIDEO"
- "TV"

6 Exit Auxiliary input display setting mode

Press the [MENU] button.



- When operation stops for 10 seconds, the name at that time is registered, and the Auxiliary input display setting mode closes.
- You can only set the Auxiliary input display when the built-in auxiliary input or the auxiliary input of optional KCA-S220A is used.

Menu system

Text Scroll

Setting the displayed text scroll.

Display	Setting
"SCL AUTO"	Repeats scroll.
"SCL MANU"	Scrolls when the display changes.



- The text scrolled is listed below.
 - CD text
 - Folder name/ File name/ Music title/ Artist name/ Album name
 - MD title
 - Text for the Satellite radio source, HD Radio source, including Channel name, etc.

In Standby mode

Built-in Auxiliary input Setting

Set the Built-in Auxiliary Input function.

Display	Setting
"AUX OFF"	When selecting the source there's no Auxiliary Input.
"AUX ON"	When selecting the source there's Auxiliary Input.

In Standby mode

CD Read Setting

When there is a problem with playing a CD with special format, this setting plays the CD by force.

Display	Setting
"CD READ1"	Play CD and Audio file.
"CD READ2"	Play CD by force.



- Some music CDs may not play even in the "CD READ2" mode.

Other than Standby mode

Audio Preset Memory

Registering the value setup by Sound Control. The memory cannot be erased by the Reset button.

1 Setup Sound Control

Refer to the following operations to setup the Sound Control.

- <Audio Control> (page 8)
- <Audio Setup> (page 9)

2 Enter Menu mode

Press the [MENU] button.

"MENU" is displayed.

3 Select Audio Preset mode

Push the Control knob towards up or down.

Select the "A-PRESET" display.

4 Enter Audio Preset mode

Press the Control knob for at least 1 second.

5 Select the Audio Preset Memory

Push the Control knob towards up or down.

Select the "MEMORY" display.

6 Put the Audio Preset in the memory

Press the Control knob for at least 2 seconds.

The "MEMORY" display blinks 1 time.

7 Exit Audio Preset mode

Press the [MENU] button.



- Register 1 pair of Audio Preset Memory. You cannot register by the source.
- When you press the Reset, all the sources will be the setting value which is registered.
- The following items cannot be registered.
Volume, Balance, Fader, Loudness, Volume offset, Dual Zone System, Rear Volume

Other than Standby mode

Audio Preset Recall

Recalling the sound setup registered by <Audio Preset Memory> (page 26).

- 1 Select the source**
Press the [SRC] button.
- 2 Enter Menu mode**
Press the [MENU] button.
"MENU" is displayed.
- 3 Select Audio Preset mode**
Push the Control knob towards up or down.
Select the "A-PRESET" display.
- 4 Enter Audio Preset mode**
Press the Control knob for at least 1 second.
- 5 Select the Audio Preset Recall**
Push the Control knob towards up or down.
Select the "RECALL" display.
- 6 Recall the Audio Preset**
Press the Control knob for at least 2 seconds.
The "RECALL" display blinks 1 time.
- 7 Exit Audio Preset mode**
Press the [MENU] button.

 - The User memory of "System Q" in <Audio Control> (page 8) is changed to the value which was recalled.
 - The source tone memory item of <Audio Control> (page 8) is changed to the value which was recalled by the selected source.

In Standby mode

Firmware version display

Displaying the firmware version with the unit.

- 1 Select the firmware version display mode**
Push the Control knob towards up or down.
Select the "F/W VER" display.
- 2 Display the firmware version**
Push the Control knob towards right or left.

In Standby mode

Demonstration mode Setting

Sets the demonstration mode.

- 1 Select the Demonstration mode**
Push the Control knob towards up or down.
Select the "DEMO" display.
- 2 Set the Demonstration mode**
Press the Control knob for at least 2 seconds.
Each time you press the knob at least 2 seconds, the Demonstration mode alternates between the settings shown in the table below.

Display	Setting
"DEMO ON"	The Demonstration mode function is ON.
"DEMO OFF"	Exit Demonstration mode (Normal mode).

Basic Operations of remote control

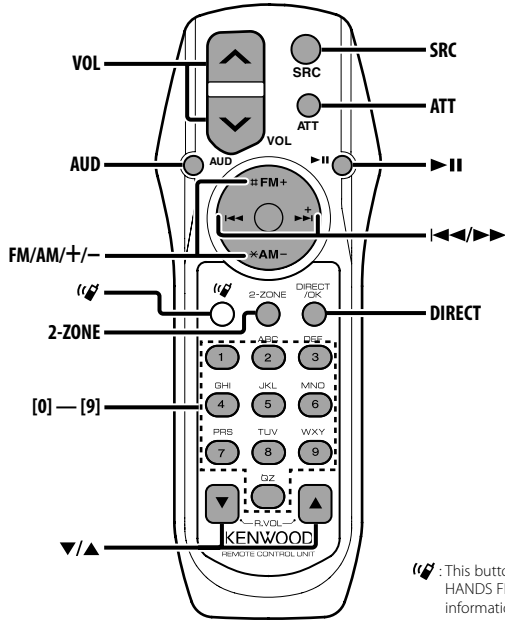

: This button is used when Kenwood Bluetooth HANDS FREE BOX is connected. For more information, refer to the instruction manual of Bluetooth HANDS FREE BOX.

Loading and Replacing the battery

Use two "AA"/ "R6"-size batteries.
Slide the cover while pressing downwards to remove it as illustrated.
Insert the batteries with the + and - poles aligned properly, following the illustration inside the case.

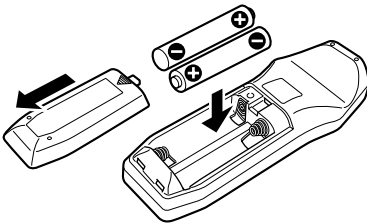

▲WARNING

- Store unused batteries out of the reach of children.
Contact a doctor immediately if the battery is accidentally swallowed.



- Do not set the remote control in hot places such as on the dashboard.

Basic operations

[VOL] buttons

Adjusts the volume.

[SRC] button

Each time you press the button, the source alternates.

For the source alternating order refer to <Selecting the Source> (page 7).

[ATT] button

Turns the volume down quickly.

When the button is pressed again, the volume returns to the previous level.

Audio Control

[AUD] button

Selects the Audio item to be adjusted.

[VOL] buttons

Adjusts the Audio item.



- Refer to <Audio Control> (page 8) for the operation method, such as the procedures for Audio control and others operations.
- The remote control can only select and adjust the Basic Audio item. Selecting and adjusting of the Detail Audio item cannot be done.

Dual Zone System

[2-ZONE] button

Each time you press the button, "2ZON" of <Audio Setup> (page 9) is turned ON or OFF.

[▲]/ [▼] buttons

Adjusts the volume of the rear channel.

The rear channel activates while the Dual Zone System is ON.

In Tuner source

[FM]/ [AM] buttons

Selects the band.

Each time you press the [FM] button, the band alternates between the FM1, FM2, and FM3 bands.

[◀◀]/ [▶▶] buttons

Tune up or down band.

[0] — [9] buttons

Press buttons [1] — [6] to recall preset stations.

[DIRECT] button

Enters and cancels the <Direct Access Tuning> (page 13) mode.

In Disc/USB source

[◀◀]/ [▶▶] buttons

Going forwards and backwards between music.

[+]/ [-] buttons

Going forwards and backwards between disc/folders.

[▶||] button

Each time you press the button, the music is played or paused.

[0] — [9] buttons

When in <Direct Music Search> (page 16) and <Direct Disc Search> (page 16), enters the music/disc number.

In Satellite radio source

[FM] button

Selects the preset band.

[◀◀]/ [▶▶] buttons

Searches up or down channels.

[0] — [9] buttons

Press buttons [1] — [6] to recall preset channels.

[DIRECT] button

Enters and cancels the <Direct Access Tuning> mode.

In HD Radio source

[FM] button

Selects the HD FM band.

Each time you press the [FM] button, the band alternates between the HF1, HF2, and HF3 bands.

[AM] button

Selects the HD AM band.

[◀◀]/ [▶▶] buttons







Tunes up or down bands.

[0] — [9] buttons

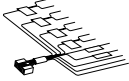
Press buttons [1] — [6] to recall preset stations.

Accessories/ Installation Procedure

Accessories

①	1
②	2
③	4
④	4
⑤	2
⑥	1
⑦	1

Installation Procedure

1. To prevent a short circuit, remove the key from the ignition and disconnect the ⊖ battery.
2. Make the proper input and output wire connections for each unit.
3. Connect the speaker wires of the wiring harness.
4. Connect the wiring harness wires in the following order: ground, battery, ignition.
5. Connect the wiring harness connector to the unit.
6. Install the unit in your car.
7. Reconnect the ⊖ battery.
8. Press the reset button.

▲WARNING

If you connect the ignition wire (red) and the battery wire (yellow) to the car chassis (ground), you may cause a short circuit, that in turn may start a fire. Always connect those wires to the power source running through the fuse box.



- If the power is not turned ON ("PROTECT" is displayed), the speaker wire may have a short-circuit or touched the chassis of the vehicle and the protection function may have been activated. Therefore, the speaker wire should be checked.
- If your car's ignition does not have an ACC position, connect the ignition wires to a power source that can be turned on and off with the ignition key. If you connect the ignition wire to a power source with a constant voltage supply, as with battery wires, the battery may die.
- If the console has a lid, make sure to install the unit so that the faceplate will not hit the lid when closing and opening.
- If the fuse blows, first make sure the wires aren't touching to cause a short circuit, then replace the old fuse with one with the same rating.
- Insulate unconnected wires with vinyl tape or other similar material. To prevent a short circuit, do not remove the caps on the ends of the unconnected wires or the terminals.
- Connect the speaker wires correctly to the terminals to which they correspond. The unit may be damaged or fail to work if you share the ⊖ wires or ground them to any metal part in the car.
- When only two speakers are being connected to the system, connect the connectors either to both the front output terminals or to both the rear output terminals (do not mix front and rear). For example, if you connect the ⊕ connector of the left speaker to a front output terminal, do not connect the ⊖ connector to a rear output terminal.
- After the unit is installed, check whether the brake lamps, blinkers, wipers, etc. on the car are working properly.
- Mount the unit so that the mounting angle is 30° or less.

If You Want to Connect iPod

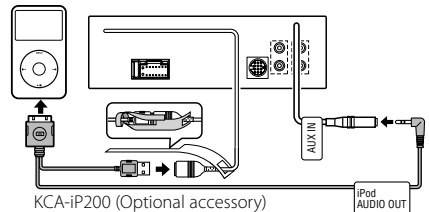

- No other optional accessory can be connected because the USB connector and the AUX input are used for iPod connection.
- Dual Zone System in <Audio Setup> (page 9) will become unavailable.

Connecting Wires to Terminals

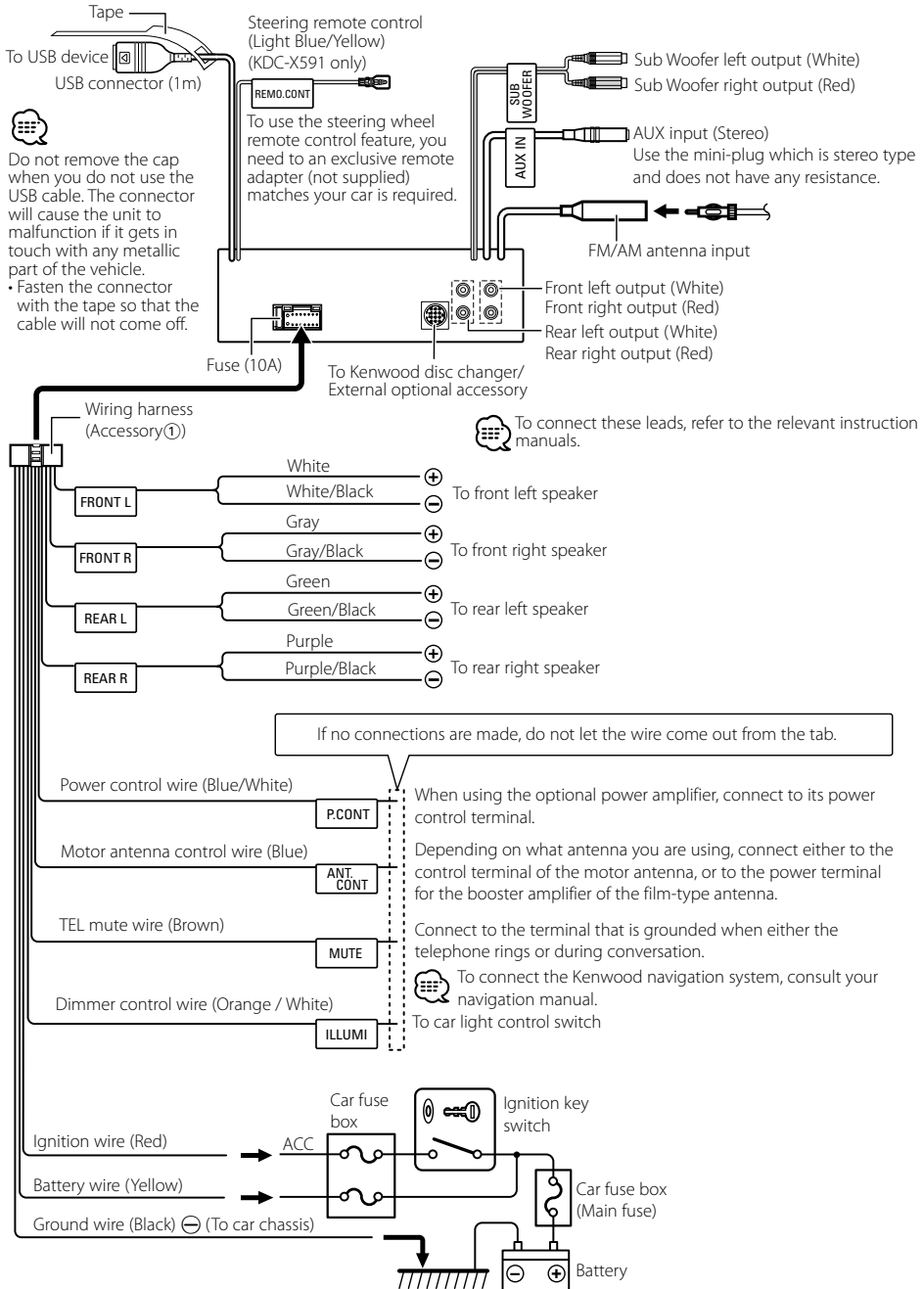

Installation

non-Japanese cars

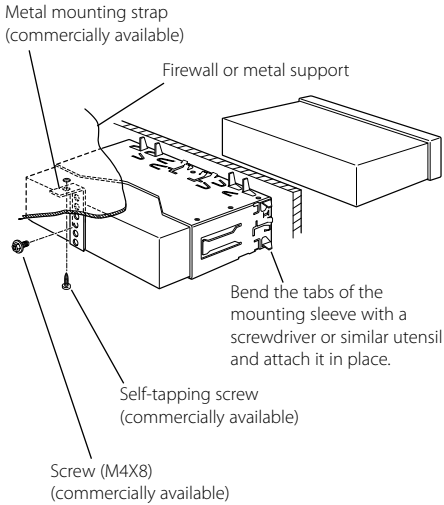

- Make sure that the unit is installed securely in place. If the unit is unstable, it may malfunction (for example, the sound may skip).

Japanese cars

- 1 Refer to the section <Removing the hard rubber frame> and then remove the hard rubber frame.
- 2 Align the holes in the unit (two locations on each side) with the vehicle mounting bracket and secure the unit with the accessory screws.

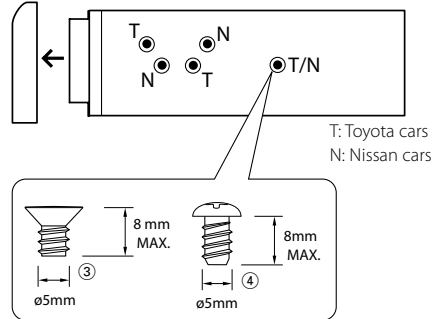

Accessory③...for Nissan car
Accessory④...for Toyota car



- During installation, do not use any screws except for those provided. The use of different screws might result in damage to the main unit.
- Damage may occur if a screwdriver or similar tool is used with excessive force during the installations.

Removing the hard rubber frame

- 1 Engage the catch pins on the removal tool and remove the two locks on the upper level. Upper the frame and pull it forward as shown in the figure.

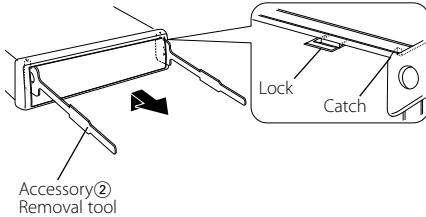

- 2 When the upper level is removed, remove the lower two locations.



- The frame can be removed from the bottom side in the same manner.

Removing the Unit

- 1 Refer to the section <Removing the hard rubber frame> and then remove the hard rubber frame.
- 2 Remove the screw (M4 × 8) on the back panel.
- 3 Insert the two removal tools deeply into the slots on each side, as shown.
- 4 Lower the removal tool toward the bottom, and pull out the unit halfway while pressing towards the inside.

Screw (M4X8)
(commercially available)

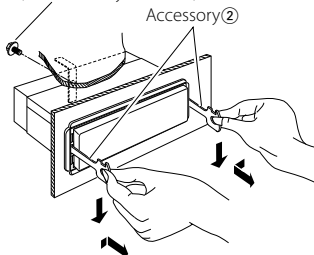

- Be careful to avoid injury from the catch pins on the removal tool.
- 5 Pull the unit all the way out with your hands, being careful not to drop it.

Screwing the Faceplate on the Unit

If you want to fasten the faceplate to the main unit so that it does not fall off.

- 1 Refer to the section <Removing the hard rubber frame> and then remove the hard rubber frame.
- 2 Drop open the faceplate by pressing the Release button.
- 3 Tighten the screw (ø2 × 5 mm) (Accessory 6) and bracket (Accessory 6) in the hole shown on the diagram.

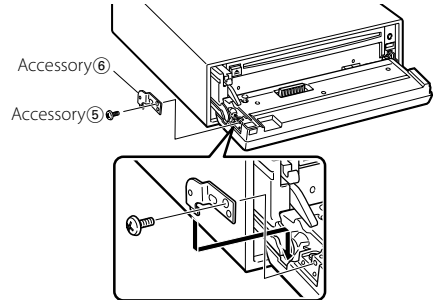

- 4 Tighten the screw (ø2 × 5 mm) (Accessory 6) and bracket (Accessory 7) in the hole shown on the diagram.

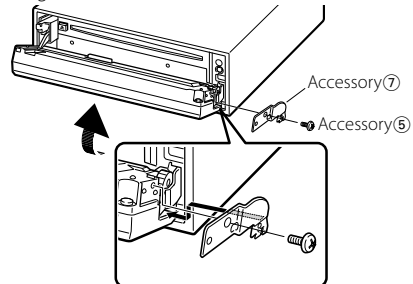

- Never insert the screws in any other screw hole than the one specified. If you screw them in another hole, it will contact and may cause damage to the mechanical parts inside the unit.

Troubleshooting Guide

Some functions of this unit may be disabled by some settings made on this unit.

! Cannot switch to Aux source.

- ▶ AUX is not turned on. ☞ <Built-in Auxiliary input Setting> (page 26)
- AUX cannot be used when the KCA-iP200 is connected.

! • Cannot set up the subwoofer. • Cannot set up subwoofer phase. • No output from the subwoofer. • Cannot set up the low pass filter.

- ▶ <Subwoofer Output> (page 10) is not set to On.
- The Dual zone function is enabled. ☞ <Audio Setup> (page 9)

! • Cannot set up the high pass filter. • Cannot set up the Fader.

- ▶ The Dual zone function is enabled. ☞ <Audio Setup> (page 9)

! Cannot set up the subwoofer phase.

- ▶ Low pass filter is set to Through. ☞ <Audio Setup> (page 9)

! • Cannot select the output destination of the subsource in the Dual zone. • Cannot adjust the volume of the rear speakers.

- ▶ The Dual zone function is disabled. ☞ <Audio Setup> (page 9)

! No Audio control effect on AUX.

- ▶ The Dual zone function is enabled. ☞ <Audio Setup> (page 9)

! • Cannot register a security code. • Cannot set up Display Illumination Control.

- ▶ <Demonstration mode Setting> (page 27) is not turned off.

! Cannot play audio files.

- ▶ <CD Read Setting> (page 26) is set to "2".

! Cannot File select.

- ▶ The Scan play or Random play function is enabled.

What might seem to be a malfunction in your unit may just be the result of slight misoperation or miswiring. Before calling service, first check the following table for possible problems.

General

? The Touch Sensor Tone doesn't sound.

- ✓ The preout jack is being used.
- ☞ The Touch Sensor Tone can't be output from the preout jack.

Tuner source

? Radio reception is poor.

- ✓ The car antenna is not extended.
- ☞ Pull the antenna out all the way.
- ✓ The antenna control wire is not connected.
- ☞ Connect the wire correctly, referring to the section on <Connecting Wires to Terminals> (page 31).

Disc source

? The specified disc does not play, but another one plays instead.

- ✓ The specified CD is quite dirty.
- ☞ Clean the CD.
- ✓ The disc is loaded in a different slot from that specified.
- ☞ Eject the disc magazine and check the number for the specified disc.
- ✓ The disc is severely scratched.
- ☞ Try another disc instead.

Audio file source

? The sound skips when an Audio file is being played.

- ✓ The media is scratched or dirty.
- ☞ Clean the media, referring to the CD cleaning of the section on <Handling CDs> (page 6).
- ✓ The audio file is broken or not supported.
- ☞ Damaged and unsupported files are skipped.
- ✓ The recording condition is bad.
- ☞ Record the media again or use another media.

HD Radio source

? No sound can be heard, or the volume is low.

- ✓ The preset broadcast station is not transmitting in the mode that was set with <Receive mode Setting> (page 25).

☞ Please set <Receive mode Setting> to "AUTO".

- ✓ In digital AM broadcasting, receive mode switches between stereo and monaural too often.
 - ☞ Receiving condition is bad or unstable. Stereo is chosen when receiving condition is good, and it switches to monaural when the condition becomes bad.

- ✓ HD Radio tuner is connected to KCA-S220A or other units.

☞ Connect the HD Radio tuner directly to this unit.

USB device source

? The USB device is not detected.

- ✓ The USB connector is disconnected.
 - ☞ Connect the connector of the USB device properly.

? The USB device does not play its audio files.

- ✓ The USB connector is disconnected.
 - ☞ Connect the connector of the USB device properly.
-

Troubleshooting Guide

The messages shown below display your systems condition.

EJECT:	<ul style="list-style-type: none"> No disc magazine has been loaded in the changer. The disc magazine is not completely loaded. No CD in the unit. 	IN (Blink):	<p>The CD player section is not operating properly.</p> <ul style="list-style-type: none"> ↻ Reinsert the CD. If the CD cannot be ejected or the display continues to flash even when the CD has been properly reinserted, please switch off the power and consult your nearest service center.
NO DISC:	No disc has been loaded in the disc magazine.	PROTECT:	<p>The speaker wire has a short-circuit or touches the chassis of the vehicle, and then the protection function is activated.</p> <ul style="list-style-type: none"> ↻ Wire or insulate the speaker cable properly and press the reset button. If the "PROTECT" code does not disappear, consult your nearest service center.
TOC ERR:	<ul style="list-style-type: none"> No disc has been loaded in the disc magazine. The CD is quite dirty. The CD is upside-down. The CD is scratched a lot. 	NA FILE:	<p>An Audio file is played with a format that this unit can't support.</p> <ul style="list-style-type: none"> ↻ ----
READ ERR:	<ul style="list-style-type: none"> The number of files or folders which are stored in the connected USB device is above the limitation. The file system of the connected USB device is broken. ↻ Copy the files and folders for the USB device again referring to http://www.kenwood.com/usb/. If the error message is still displayed, initialize the USB device or use other USB devices. 	COPY PRO:	<p>A copy-protected file is played.</p> <ul style="list-style-type: none"> ↻ ----
E-05:	The disc is unreadable.	DEMO:	<p>The Demonstration mode has been selected.</p> <ul style="list-style-type: none"> ↻ The <Demonstration mode Setting> (page 27) is ON. Turn it OFF.
BLANK:	Nothing has been recorded on the MD.	NO DVICE:	<p>The USB device is selected as a source although no USB device is connected.</p> <ul style="list-style-type: none"> ↻ Change the source to any source other than USB. Connect an USB device, and change the source to USB again.
NO TRACK:	No tracks are recorded on the MD, although it has a title.	NA DVICE:	<p>An unsupported USB device is connected.</p> <ul style="list-style-type: none"> ↻ For the supported USB devices, refer to <http://www.kenwood.com/usb/>.
NO PANEL:	The faceplate of the slave unit being connected to this unit has been removed.	NO MUSIC/E-15:	<p>The connected USB device contains no playable audio file.</p> <ul style="list-style-type: none"> Media was played that doesn't have data recorded that the unit can play.
E-77:	<p>The unit is malfunctioning for some reason.</p> <ul style="list-style-type: none"> ↻ Press the reset button on the unit. If the "E-77" code does not disappear, consult your nearest service center. 	USB ERR:	<p>The connected USB device is rated a current capacity higher than the allowable limit.</p> <ul style="list-style-type: none"> ↻ Check the USB device with reference to <http://www.kenwood.com/usb/>. Some trouble may have occurred to the connected USB device. ↻ Change the source to any source other than USB. Remove the USB device.
E-99:	<p>Something is wrong with the disc magazine. Or the unit is malfunctioning for some reason.</p> <ul style="list-style-type: none"> ↻ Check the disc magazine. And then press the reset button on the unit. If the "E-99" code does not disappear, consult your nearest service center. 	iPod ERR:	<p>Connection to the iPod has failed.</p> <ul style="list-style-type: none"> ↻ Remove the USB device and then reconnect it. ↻ Confirm that the software for the iPod is the latest version.
LOAD:	Discs are being exchanged in the Disc changer.	REMOVE:	<p>The Remove mode has been selected for the USB device. You can remove the USB device safely.</p>
READING:	The unit is reading the data on the disc.		
HOLD:	<p>The protective circuit in the unit activates when the temperature inside the automatic disc changer exceeds 60°C (140°F), stopping all operation.</p> <ul style="list-style-type: none"> ↻ Cool down the unit by opening the windows or turning on the air conditioner. As the temperature falls below 60°C (140°F), the disc will start playing again. 		

Specifications

Specifications subject to change without notice.

FM tuner section

- Frequency range (200 kHz space)
 - : 87.9 MHz – 107.9 MHz
- Usable sensitivity (S/N = 30dB)
 - : 9.3dBf (0.8 μ V /75 Ω)
- Quieting Sensitivity (S/N = 50dB)
 - : 15.2dBf (1.6 μ V /75 Ω)
- Frequency response (\pm 3.0 dB)
 - : 30 Hz – 15 kHz
- Signal to Noise ratio (MONO)
 - : 70 dB
- Selectivity (\pm 400 kHz)
 - : \geq 80 dB
- Stereo separation (1 kHz)
 - : 40 dB

AM tuner section

- Frequency range (10 kHz space)
 - : 530 kHz – 1700 kHz
- Usable sensitivity (S/N = 20dB)
 - : 28 dB μ (25 μ V)

CD player section

- Laser diode
 - : GaAlAs
- Digital filter (D/A)
 - : 8 Times Over Sampling
- D/A Converter
 - : 1 Bit
- Spindle speed
 - : 1000 – 400 rpm (CLV 2times)
- Wow & Flutter
 - : Below Measurable Limit
- Frequency response (\pm 1 dB)
 - : 10 Hz – 20 kHz
- Total harmonic distortion (1 kHz)
 - : 0.008 % (KDC-X591)
 - : 0.01 % (KDC-MP535U)
- Signal to Noise ratio (1 kHz)
 - : 110 dB (KDC-X591)
 - : 105 dB (KDC-MP535U)
- Dynamic range
 - : 93 dB
- MP3 decode
 - : Compliant with MPEG-1/2 Audio Layer-3
- WMA decode
 - : Compliant with Windows Media Audio
- AAC decode
 - : AAC-LC ".m4a" files
- WAV signal
 - : Linear-PCM

Audio section

- Maximum output power
 - : 50 W x 4
- Full Bandwidth Power (at less than 1% THD)
 - : 22 W x 4
- Speaker impedance
 - : 4 - 8 Ω
- Tone action
 - Bass : 100 Hz \pm 8 dB
 - Middle : 1 kHz \pm 8 dB
 - Treble : 10 kHz \pm 8 dB
- Preout level / Load (during disc play)
 - : 4000 mV/10 k Ω (KDC-X591)
 - : 2500 mV/10 k Ω (KDC-MP535U)
- Preout impedance
 - : \leq 600 Ω

USB Interface

- USB Standard
 - : USB1.0/ 1.1/ 2.0
- File System
 - : FAT16/ 32
- Maximum Supply current
 - : 500 mA
- MP3 decode
 - : Compliant with MPEG-1/2 Audio Layer-3
- WMA decode
 - : Compliant with Windows Media Audio
- AAC decode
 - : AAC-LC ".m4a" files
- WAV signal
 - : Linear-PCM

Auxiliary input

- Frequency response (\pm 1 dB)
 - : 20 Hz – 20 kHz
- Input Maximum Voltage
 - : 1200 mV
- Input Impedance
 - : 100 k Ω

General

- Operating voltage (11 – 16V allowable)
 - : 14.4 V
- Current consumption
 - : 10 A
- Installation Size (W x H x D)
 - : 182 x 53 x 155 mm
 - : 7-3/16 x 2-1/16 x 6-1/8 inch
- Weight
 - : 3.1 lbs (1.40 kg)

KENWOOD

Free Manuals Download Website

<http://myh66.com>

<http://usermanuals.us>

<http://www.somanuals.com>

<http://www.4manuals.cc>

<http://www.manual-lib.com>

<http://www.404manual.com>

<http://www.luxmanual.com>

<http://aubethermostatmanual.com>

Golf course search by state

<http://golfingnear.com>

Email search by domain

<http://emailbydomain.com>

Auto manuals search

<http://auto.somanuals.com>

TV manuals search

<http://tv.somanuals.com>