

KENWOOD

AUDIO/VIDEO RECEIVER

KR-V7070

INSTRUCTION MANUAL

KENWOOD CORPORATION

For your records

Record the serial number, found on the back of the unit, in the spaces designated on the warranty card, and in the space provided below. Refer to the model and serial numbers whenever you call upon your dealer for information or service on this product.

Model _____ Serial Number _____

Unpacking

Unpack the unit carefully and make sure that all accessories are put aside so they will not be lost. Examine the unit for any possibility of shipping damage. If your unit is damaged or fails to operate, notify your dealer immediately. If your unit was shipped to you directly, notify the shipping company without delay. Only the consignee (the person or company receiving the unit) can file a claim against the carrier for shipping damage.

We recommend that you retain the original carton and packing materials for use should you transport or ship the unit in the future.

Accessories

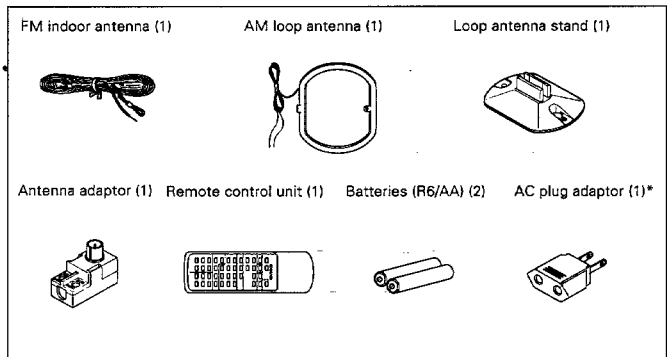

* Use to adapt the plug on the power cord to the shape of the wall outlet. (Accessory only for regions where use is necessary.)

Before applying power

⚠ Caution : Read this page carefully to ensure safe operation.

KR-V7070 (En)

Units are designed for operation as follows.

U.S.A. and Canada AC 120 V only
Australia AC 240 V only
Other countries AC 110-120 / 220-240 V switchable

AC voltage selection

This unit operates on 110 - 120 volts or 220 - 240 volts AC. The AC voltage selector switch on the rear panel is set to the voltage that prevails in the area to which the unit is shipped. Before connecting the power cord to your AC outlet, make sure that the setting position of this switch matches your line voltage. If not, it must be set to your voltage in accordance with the following direction.

Note:

Our warranty does not cover damage caused by excessive line voltage due to improper setting of the AC voltage selector switch.



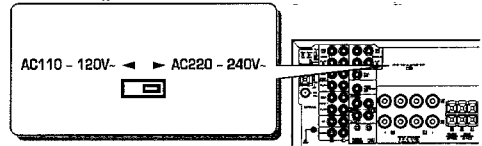

AC voltage Selector switch



Move switch lever to match your line voltage with a small screwdriver or other pointed tool.

Safety precautions

WARNING : TO PREVENT FIRE OR ELECTRIC SHOCK, DO NOT EXPOSE THIS APPLIANCE TO RAIN OR MOISTURE.

	CAUTION RISK OF ELECTRIC SHOCK DO NOT OPEN		CAUTION: TO REDUCE THE RISK OF ELECTRIC SHOCK, DO NOT REMOVE COVER (OR BACK). NO USER-SERVICEABLE PARTS INSIDE, REFER SERVICING TO QUALIFIED SERVICE PERSONNEL.
	THE LIGHTNING FLASH WITH ARROWHEAD SYMBOL, WITHIN AN EQUILATERAL TRIANGLE, IS INTENDED TO ALERT THE USER TO THE PRESENCE OF UNINSULATED "DANGEROUS VOLTAGE" WITHIN THE PRODUCT'S ENCLOSURE THAT MAY BE OF SUFFICIENT MAGNITUDE TO CONSTITUTE A RISK OF ELECTRIC SHOCK TO PERSONS.		
	THE EXCLAMATION POINT WITHIN AN EQUILATERAL TRIANGLE IS INTENDED TO ALERT THE USER TO THE PRESENCE OF IMPORTANT OPERATING AND MAINTENANCE (SERVICING) INSTRUCTIONS IN THE LITERATURE ACCOMPANYING THE APPLIANCE.		

For the U.S.A.

FCC WARNING

This equipment may generate or use radio frequency energy. Changes or modifications to this equipment may cause harmful interference unless the modifications are expressly approved in the instruction manual. The user could lose the authority to operate this equipment if an unauthorized change or modification is made.

NOTE:

This equipment has been tested and found to comply with the limits for a Class B digital device, pursuant to Part 15 of the FCC Rules. These limits are designed to provide reasonable protection against harmful interference in a residential installation. This equipment may cause harmful interference to radio communications, if it is not installed and used in accordance with the instructions. However, there is no guarantee that interference will not occur in a particular installation. If this equipment does cause harmful interference to radio or television reception, which can be determined by turning the equipment off and on, the user is encouraged to try to correct the interference by one or more of the following measures:

- Reorient or relocate the receiving antenna.
- Increase the separation between the equipment and receiver.
- Connect the equipment into an outlet on a circuit different from that to which the receiver is connected.
- Consult the dealer or an experienced radio / TV technician for help.

For the U.S.A.

Note to CATV system installer:

This reminder is provided to call the CATV system installer's attention to Article 820-40 of the NEC that provides guidelines for proper grounding and, in particular, specifies that the cable ground shall be connected to the grounding system of the building, as close to the point of cable entry as practical.

Special features

DOLBY PRO LOGIC & DOLBY 3 STEREO

The surround system reproduces video software program carrying the  mark with similar acoustic effects to movie theaters.

The **DOLBY PRO LOGIC** mode controls the audio signals of the Front Left/Right, Center and Rear surround channels using the built-in directivity enhancer circuit to reproduce the feeling of sound motions realistically.

The **DOLBY 3 STEREO** mode can reproduce the motions of sound even when only the front and center speakers are used, by providing proper acoustic position using the directivity enhancer circuit.

DSP LOGIC

This mode adds presence sound components obtained from the DSP (Digital Signal Processor) to the signals output from the **DOLBY PRO LOGIC** (Left, Center, Right and Surround channels), allowing movie software programs to be played with a similar feeling of presence to movie theaters in a listening room in home.

DSP presence

This mode adds presence sound components obtained from the DSP (Digital Signal Processor) to the original source signals, allowing music source entertainment with the feeling of presence in an arena, stadium or jazz club in a listening room at home.

Contents

Caution : Read the pages marked Δ carefully to ensure safe operation.

Before applying power	Δ Before applying power	2
	Δ Safety precautions	2
Special features	3
System connection	4
	FM DE-EMPHASIS/CHANNEL SPACE switch	7
Controls and indicators	8
Operation of remote control unit	10
Playing music	11
Sound adjustment functions	12
Recording	14
	Recording	14
	Copying tape (Tape dubbing)	14
Broadcast reception	15
	Receiving broadcast station	15
	Receiving radio station by specifying its frequency	16
	Storing radio stations in memory (Station preset)	17
Operation of video components	18
	Playback of videotape	18
	Recording of video source	18
Presence play	20
	Dolby 3 Stereo adjustment and playback	21
	Dolby Pro Logic Surround arrangement	22
	Dolby Pro Logic Surround playback	23
	Enjoying music with feeling of presence (DSP LOGIC and DSP modes)	24
	26
In case of difficulty	26
Δ Specifications	27

System connection

KR-V7D70 (En)

Make connection as shown below.
When connecting the related system components, refer also to the instruction manuals of the related components.
Do not plug in the power lead until all connections are completed.

Malfunction of microcomputer
If operation is not possible or erroneous display appears even though all connections have been made properly, reset the microcomputer referring to "In case of difficulty".

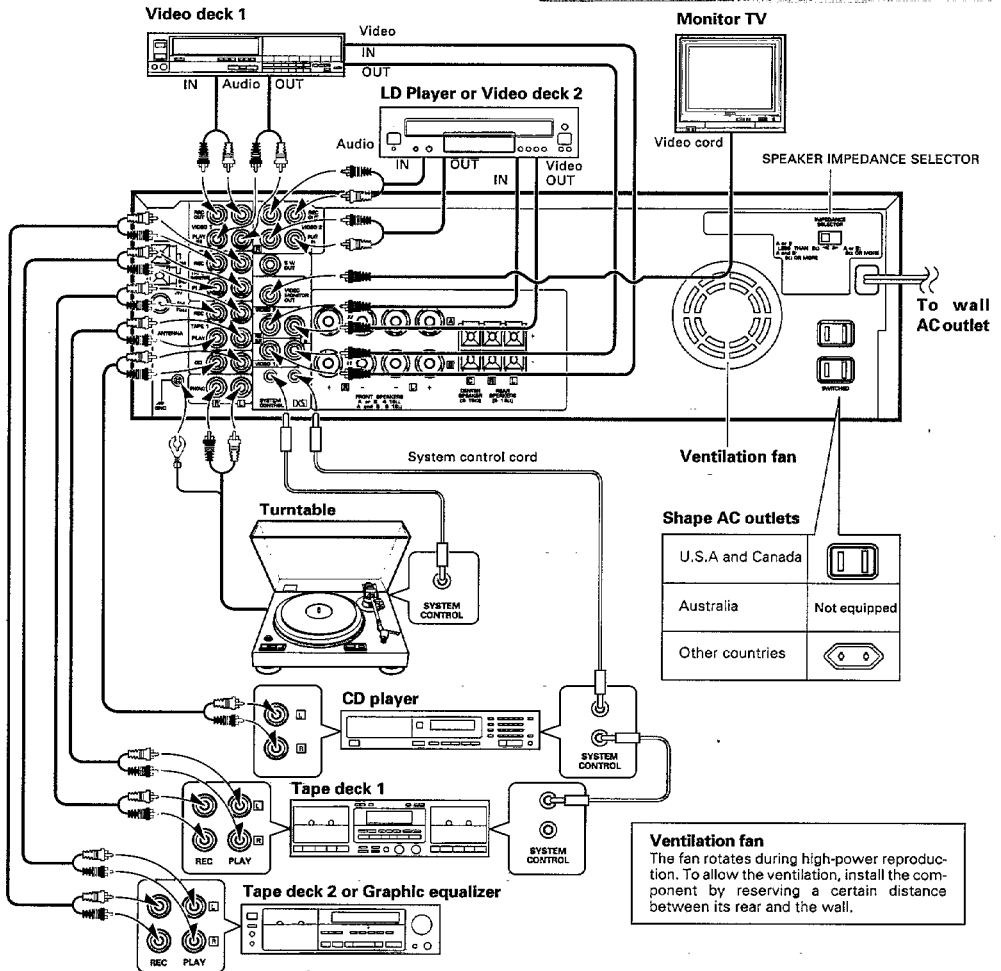

Automatic operation

If you connect other KENWOOD components (i.e. a cassette deck or CD player) to this unit's SYSTEM CONTROL, this unit's input selector will automatically switch to that component when you start playback from it. This also works when you use the remote control.
(Automatic operation is not possible with TAPE DECK 2 or VIDEO machines.)

Notes



1. Connect all cords firmly. If connections are loose, there could be loss of sound or noise produced.
2. When plugging and unplugging connection cords, be sure to first remove the power cord from the AC outlet. Plugging / unplugging connection cords without removal of the power cord can cause malfunctions or damage to the unit.
3. Do not connect up a power source which is larger than that indicated on the socket at the rear of the unit.
4. Insert the system control plugs completely into the jacks.
5. If the system control cords or audio cords are not connected properly, the remote control or automatic operation between system components will not work properly.

Connection of speakers

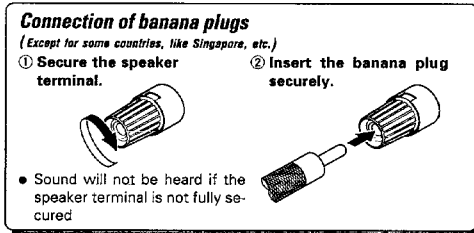
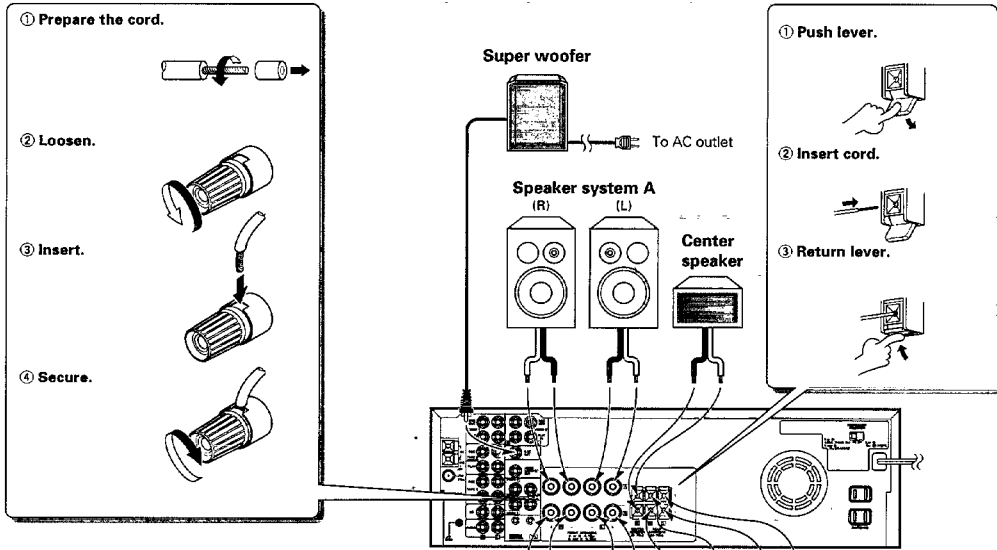

- Never short-circuit the + and - speaker cords.
- If the left and right speakers are connected inversely or if the speaker cords are connected with reversed polarity, the sound becomes unnatural with ambiguous acoustic image positioning. Be sure to connect the speakers and speaker cords correctly.

Setting the speaker IMPEDANCE SELECTOR

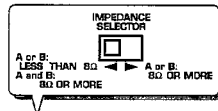

When using the speaker A or speaker B separately

Speaker impedance	Selector position
4 Ω, 6 Ω	
8 Ω, 16 Ω	

When using the speaker A and B simultaneously

Speaker impedance	Selector position
8 Ω, 16 Ω	

CAUTION: TO PREVENT FIRE OR DAMAGE REQUIRING SERVICE, SET THE IMPEDANCE SELECTOR SWITCH AS DESCRIBED BELOW.

According to the impedance of the speakers used, set the speaker IMPEDANCE SELECTOR on the rear panel as shown in the table.

- When the IMPEDANCE SELECTOR switch is set to "A or B: LESS THAN 8Ω, A and B: 8Ω OR MORE", it is possible to use the A and B speakers at the same time. Therefore, when using the speakers A and B simultaneously, be sure to set the IMPEDANCE SELECTOR switch to the "A or B: LESS THAN 8Ω, A and B: 8Ω OR MORE" position.
- During speaker system connection and operation of the speaker IMPEDANCE SELECTOR, set the power key to OFF.

Connection method to each antenna terminal

- ① Push lever. ② Insert cord. ③ Return lever.

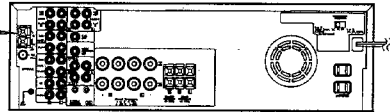

Connection of AM antenna

AM loop antenna connection

The supplied antenna is for indoor use. Place it as far as possible from the main system, TV set, speaker cords and power cord, and set it to a direction which provides the best reception.

AM outdoor antenna connection

If the reception is poor when the AM loop antenna is used, distribute a vinyl-coated wire of more than 6 meters outdoors, without disconnecting the loop antenna.

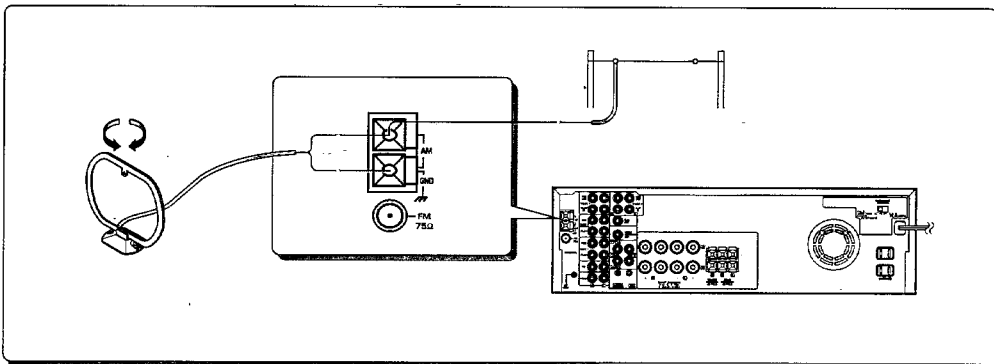

Connection of FM antenna

FM indoor antenna connection

The accessory antenna is for temporary indoor use only. For stable signal reception we recommend using an outdoor antenna. Remove the indoor antenna if you connect one outdoors.

FM outdoor antenna connection

Lead the 75Ω coaxial cable connected to the FM outdoor antenna into the room and connect it to the FM 75Ω terminal.

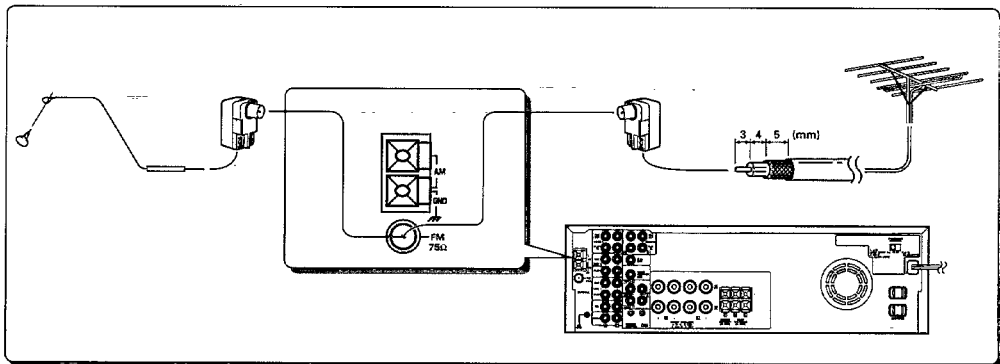

Connection of antenna adaptor

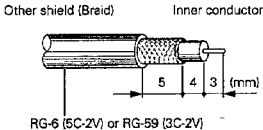
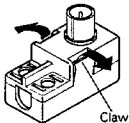
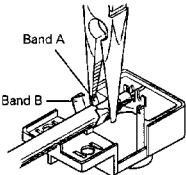
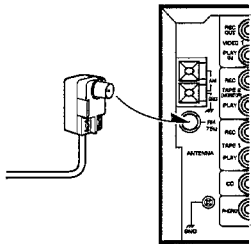
<p>① Prepare the cable.</p> <p>When coaxial cable is used</p>  <p>Remove the vinyl coating and twist conductors.</p>	<p>② Open the antenna adaptor.</p>  <p>Open the claws with the fingers to release the lock and pull out the cover.</p>
<p>③ Attach the cable and close the cover.</p> <p>When coaxial cable is used</p>  <p>Insert the cable into the slit on the clip. Fasten bands A and B using a pair of pliers.</p>	<p>④ Connect the adaptor to the antenna terminal.</p>  <p>Insert the antenna cord tip into the slit on the hardware and wrap the cord around it.</p>

FM DE-EMPHASIS / CHANNEL SPACE switch (Except for U.S.A., Canada, Australia and Europe)

The FM DE-EMPHASIS / CHANNEL SPACE switch on the rear panel is set to the correct setting that prevails in the area to which the unit is shipped. However, if the FM DE-EMPHASIS / CHANNEL SPACE setting is not matched to the area where the unit is to be used; for instance, when you moved from area 1 to area 2 or vice versa, desired reception of AM / FM broadcasts is not expected. In this case, change the FM DE-EMPHASIS / CHANNEL SPACE setting in accordance with the area corresponding to the table. The FM DE-EMPHASIS is switched over at the same time.

CHANNEL SPACE 75µs 10kHz 100kHz AM FM 9kHz 50kHz DE 50µs EMPHASIS
--

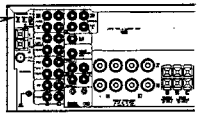

- When changing the setting of the FM DE-EMPHASIS / CHANNEL SPACE switch, first disconnect the power cord, then reset the channel space switch, connect the power cord again, and turn the power on.

	Area	CHANNEL SPACE freq.	FM DE-EMPHASIS
1.	U.S.A., Canada, Hawaii, South American countries	FM: 100kHz AM: 10kHz	75 µs
2.	Other countries	FM: 50kHz AM: 9kHz	50 µs

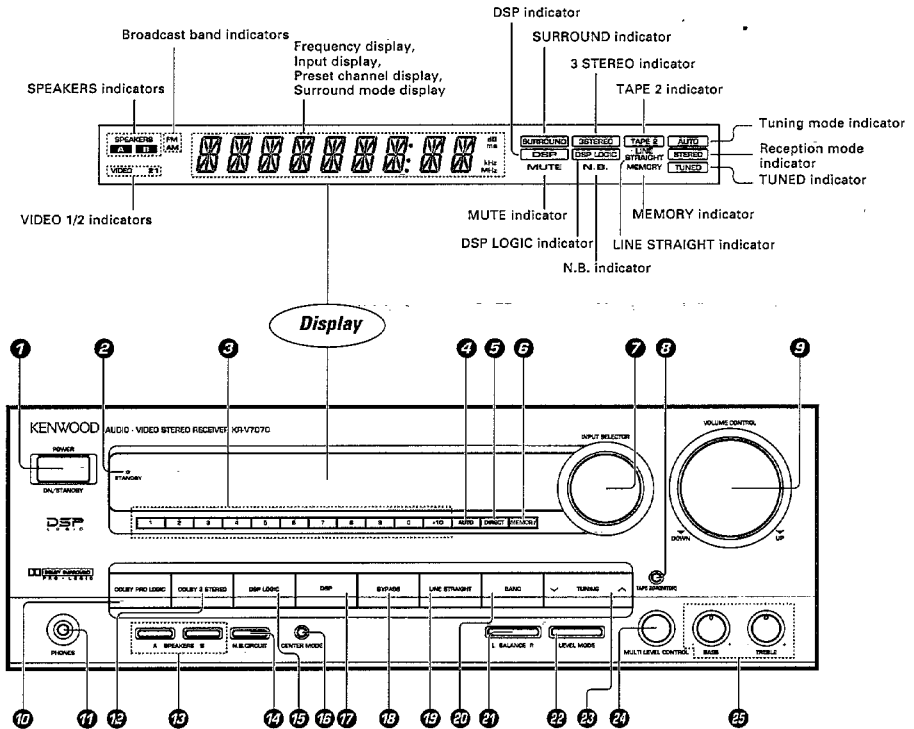

- ① **POWER key**
- ② **STANDBY indicator**
- ③ **Numeric keys**
- ④ **AUTO key**
- ⑤ **DIRECT key**
Press for direct station tuning based on numerical input.
- ⑥ **MEMORY key**
Press to preset a station in the memory.
- ⑦ **INPUT SELECTOR knob**
Turn to select the input sources.
- ⑧ **TAPE 2 (MONITOR) key**
- ⑨ **VOLUME CONTROL knob**
- ⑩ **DOLBY PRO LOGIC key**
- ⑪ **PHONES jack**
Used for headphone listening.
- ⑫ **DOLBY 3 STEREO key**
- ⑬ **SPEAKERS A/B keys**
Press to select the A and/or B speaker systems.
- ⑭ **N. B. CIRCUIT key**
Use for correct reproduction of natural bass sound.
- ⑮ **DSP LOGIC key**
- ⑯ **CENTER MODE key**
Press to select the center mode of the DOLBY PRO LOGIC surround play.
- ⑰ **DSP key**
- ⑱ **BYPASS key**
Press to cancel the surround modes.
- ⑲ **LINE STRAIGHT key**
- ⑳ **BAND key**
Press to switch the broadcast band.
- ㉑ **BALANCE keys**
Turn to adjust the volume balance between left and right.
- ㉒ **LEVEL MODE key**
Selects the item whose presets are to be changed (in SURROUND MODE).
- ㉓ **TUNING keys**
- ㉔ **MULTI LEVEL CONTROL knob**
Adjusts up or down the presets of the item selected with the LEVEL MODE key (in SURROUND MODE).
- ㉕ **Tone control knobs**

STANDBY mode of POWER switch

When the power cord of this system is plugged into an AC outlet, the STANDBY indicator lights up regardless of the ON/OFF setting of the POWER switch. This indicates that a small amount of current is being supplied to the unit to back up the memory contents. This mode is referred to as the Standby mode. While the STANDBY indicator is lit, the power of the system can be switched ON/OFF from the remote control unit.

Remote control unit

This unit's remote control can operate KENWOOD cassette decks or CD players when they are connected by the SYSTEM CONTROL. For details regarding the component's functions, please refer to the operation manual for that unit.

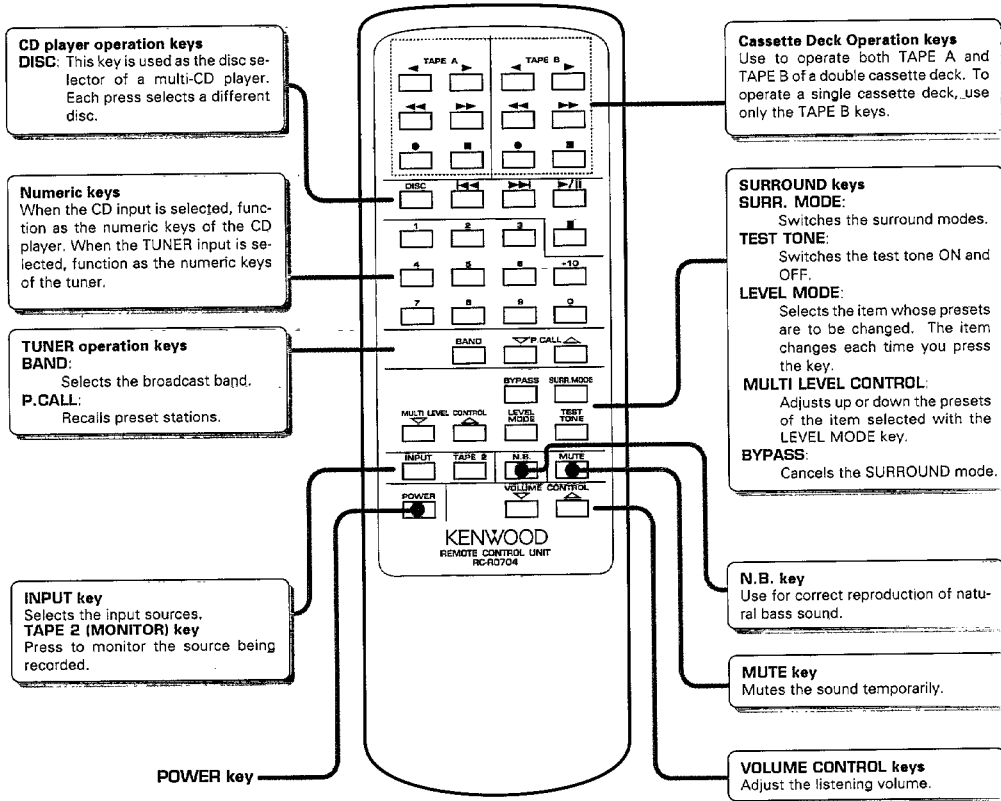

Model: RC-R0704
Infrared ray system

Operation of remote control unit

KR-V7070 (En)

Loading batteries

1 Remove the cover.

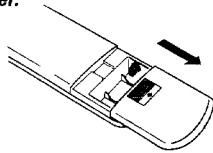

2 Insert batteries.

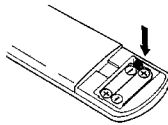

3 Close the cover.

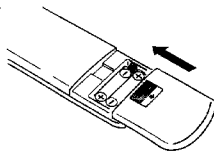

- Insert two AA-size (R6 / SUM-3) batteries as indicated by the polarity marking.

Operation procedure

Plug the power cord of the system into an AC wall outlet, and press the POWER key on the remote control unit to turn the power on. When the power is turned on, press the key of the source component to be operated.

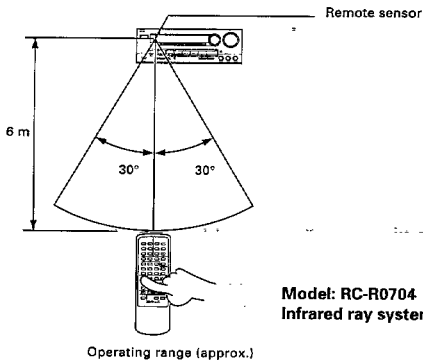

- Components connected via the system control cords, such as the CD player, can also be remote-controlled. In this case, please read the instruction manual supplied with your components.
- When two operation keys on the remote control unit are pressed successively, press each key securely reserving an interval of more than 1 second for each press.

Notes



1. The supplied batteries are intended for use in operation checks. Therefore, their lives may be shorter than ordinary batteries.
2. When the remote-controllable distance gets shorter than before, replace both batteries with new ones.
3. Malfunction may occur if direct sunlight or the light of a high-frequency lighting fluorescent lamp enters the remote control light sensor. In such a case, change the system installation position to prevent the malfunction.

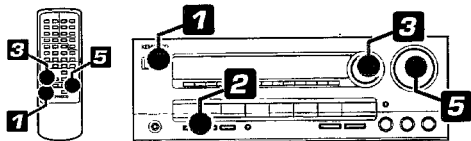

1 Turn the power ON.

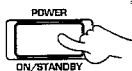

2 Select the SPEAKERS switch setting.

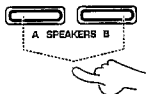

The indicators of the speaker systems to be used should light up.

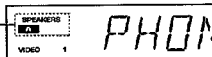

A, B OFF

Sound is not output from the speakers. Use this setting for listening through headphones, etc.

A ON

Sound is output from the speakers connected to the SPEAKERS A terminals on the rear panel.

B ON

Sound is output from the speakers connected to the SPEAKERS B terminals on the rear panel.

A, B ON

Sound is output from the speakers connected to the SPEAKERS A and B terminals on the rear panel.

- When a surround mode is activated while both SPEAKERS A and B are ON, the SPEAKERS B system is automatically switched off. If the SPEAKERS B key is pressed at this time, the SPEAKERS B system is switched ON and the SPEAKERS A system is switched OFF automatically.
- Output to the super woofer is not turned off even if you turn off both SPEAKERS A and B.

3 Select the input source.

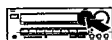

INPUT SELECTOR



The input sources are switched in the following order:

- ① TUNER (frequency display)
- ② TAPE 1
- ③ VIDEO 1
- ④ VIDEO 2
- ⑤ CD
- ⑥ PHONO

The selected source is displayed

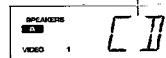

- The selected input source is held in memory for about 3 days even after the power cord is unplugged from the mains outlet.

4 Play the selected source.

5 Adjust the volume.

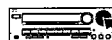

VOLUME CONTROL

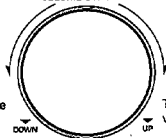

To decrease volume
DOWN

To increase volume
UP

VOLUME display

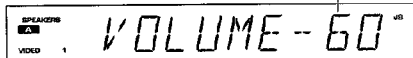

- The sound of input source cannot be listened to while TAPE 2 is ON.

Sound adjustment functions

Adjusting the tone

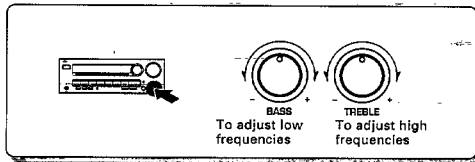

Adjusting the left/right sound balance

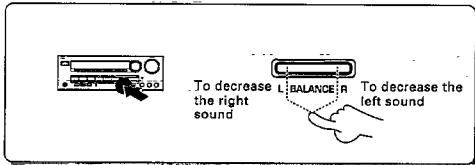

Natural Bass Correction (N.B. CIRCUIT)

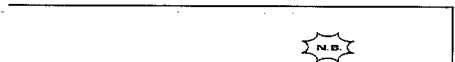
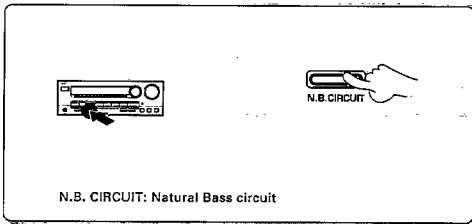

To cancel
Press the N.B. CIRCUIT key again.

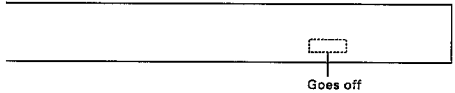

To cancel
Press the MUTE key again.

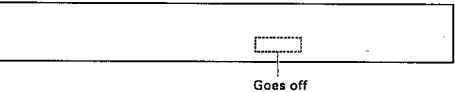

To mute sound temporarily

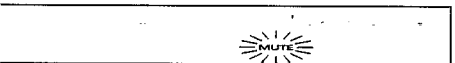
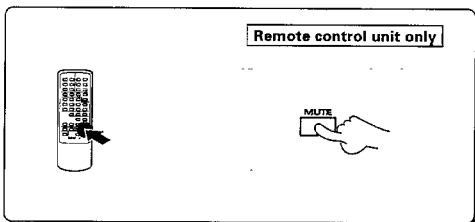

To cancel
Press the MUTE key again.

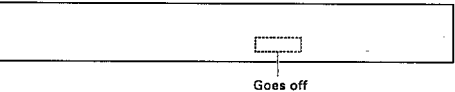

To listen through headphones

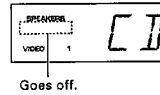
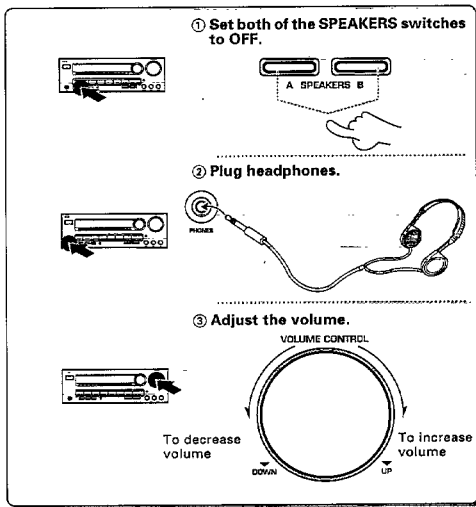

Line-straight playback

This feature allows to enjoy music sources such as CD with an even higher sound quality.

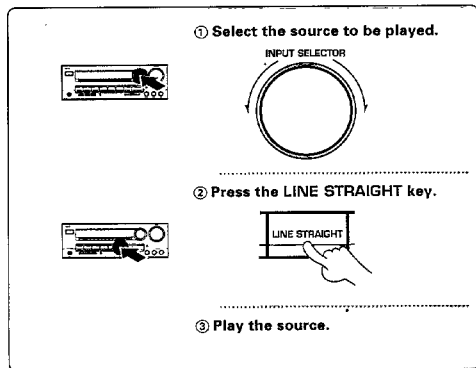

LINE STRAIGHT

- The tone control functions are defeated during line-straight play.
- The line-straight play is cancelled when a key associated with surround play is pressed.

To cancel

Press the **LINE STRAIGHT** key again.



Goes off.

To record a music source

① Select the source to be recorded.

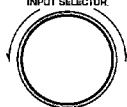
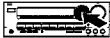

Select input source other than TAPE 1.

② Put the cassette deck in record-pause mode.

③ Play the source and start recording.

Copying tape (Tape dubbing TAPE 1 → TAPE 2)

Play the cassette deck connected to the TAPE 1 jacks and start recording of the cassette deck connected to the TAPE 2 jacks.

Copying tape (Tape dubbing TAPE 2 → TAPE 1)

① Press the TAPE 2(MONITOR) key.

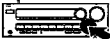

② Select a source other than TAPE 1.

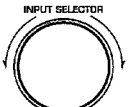
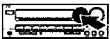

③ Play cassette deck 2 and start recording on cassette deck 1.



- For copying a tape using a double cassette deck, read the instruction manual of the double cassette deck.

Regarding TAPE 2(MONITOR)

A cassette deck or graphic equalizer can be connected to this unit's TAPE 2(MONITOR) terminals. If you connect a graphic equalizer, turn the TAPE 2(MONITOR) key ON. If you connect a 3-head cassette deck, you can monitor the source sound, or the sound being recorded, while recording. Pressing the TAPE 2(MONITOR) key lets you compare the recorded sound and the source sound. Refer to the operating manual for the component you connected for further details.

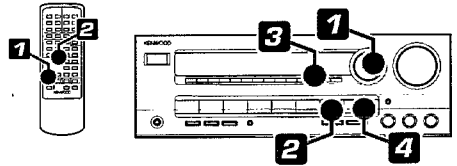

Receiving broadcast station

1 Select the TUNER input.

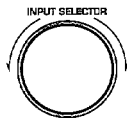

2 Select the broadcast band.

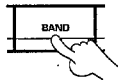

3 Select the tuning method.



4 Select a station.

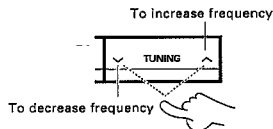

The input sources are switched in the following order:

- ① TUNER (frequency display)
- ② TAPE 1
- ③ VIDEO 1
- ④ VIDEO 2
- ⑤ CD
- ⑥ PHONE

Frequency display

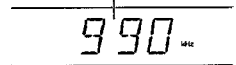

- The last frequency tuned before is displayed.

Each press switches the band as follows:

- ① FM
- ② AM



Each press switches the tuning method as follows:

- ① AUTO lit (auto tuning)
- ② AUTO not lit (manual tuning)



- Usually, set the switch to **AUTO** (auto tuning).

Select **manual tuning** when noise interferes due to weak radio wave. (The stereo broadcasting is received in monaural during manual tuning.)

Frequency display

"TUNED" lights up when a station is turned.

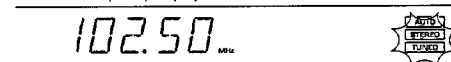

Auto tuning: The next station found is tuned automatically.
Manual tuning: Press repeatedly or hold until a station is tuned.

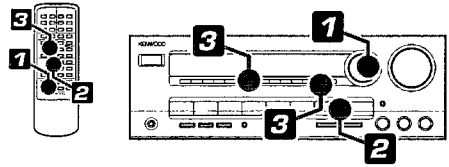

Receiving radio station by specifying its frequency

1 Select the TUNER input.

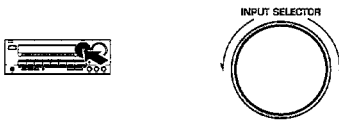

The input sources are switched in the following order:

- ① TUNER (frequency display)
- ② TAPE 1
- ③ VIDEO 1
- ④ VIDEO 2
- ⑤ CD
- ⑥ PHONO

Frequency display

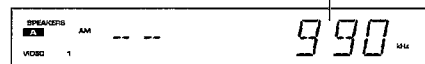

2 Select the broadcast band.



Each press switches the band as follows:

- ① FM
- ② AM

AM or FM indicator



3 Specify the frequency.

- ① Press the DIRECT key.

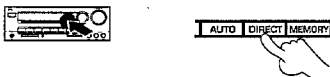

- ② Enter the frequency of the desired station.

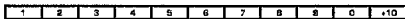

Press the numeric keys according to the frequency to be tuned as shown below.

Desired station	Order of pressing numeric keys
FM 90 MHz	9, 0, 0 (100 kHz space)
	9, 0, 0, 0 (50 kHz space)
FM 102.5 MHz	1, 0, 2, 5 (100 kHz space)
	1, 0, 2, 5, 0 (50 kHz space)
AM (MW) 810 MHz	8, 1 (10 kHz space)
	8, 1, 0 (9 kHz space)
AM (MW) 1260 kHz	1, 2, 6 (10 kHz space)
	1, 2, 6, 0 (9 kHz space)

Frequency display

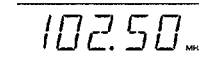

"TUNED" lights up when a station is tuned.



- If you commit a mistake, repeat step 3 again.

Preparation

- Tune the station to be stored in memory.

→ P.16

Storing radio stations in memory (Station preset)

1 Press the MEMORY key during receiving a station.



AUTO DIRECT MEMORY



Lights up (for 5 sec.)

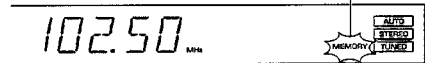

Proceed to step 2 within 5 sec. (If more than 5 sec. have elapsed, press the MEMORY key again.)

2 Select one of the preset numbers from 1 to 40.

1 2 3 4 5 6 7 8 9



Press the numeric keys in the following order.

To store in "15" [+10], [5]
To store in "20" [+10], [+10], [0]

- Repeat steps 1 and 2 for each of the stations to be stored in memory.
- If a station is stored in a preset number which already stores a station memory under it, the previous memory is replaced by the new memory content.
- Once the memory content has been preset, it is held for about 3 days even after the power cord is unplugged from the mains outlet.

Receiving a preset station

Press the preset number of the desired station.

- ① Select the TUNER input with the INPUT SELECTOR.

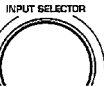

②

1 2 3 4 5 6 7 8 9

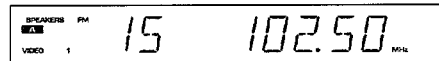

Press the numeric keys in the following order.

To recall "15" [+10], [5]
To recall "20" [+10], [+10], [0]

Receiving all preset stations in order

Press the P.CALL key.



- Every time the key is pressed, the next station in the order of the preset number is received.

When you press Δ key, ... 1 → 2 → 3 38 → 39 → 40

When you press ∇ key, ... 1 → 2 → 3 38 → 39 → 40

If the key is held pressed Preset stations will be received successively for about half a second each.

Operation of video components

For the connections and operations, also read carefully the instruction manuals of the video components. [P.4](#)

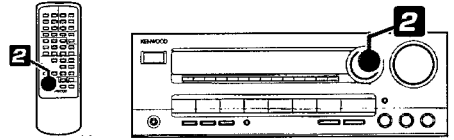

Playback of videotape

1 Turn the power of the monitor TV ON.

2 Select the VIDEO 1 input.

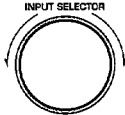

The input sources are switched in the following order:

- ① TUNER (frequency display)
- ② TAPE 1
- ③ VIDEO 1
- ④ VIDEO 2
- ⑤ CD
- ⑥ PHONO

"VIDEO 1" should be displayed.

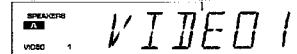

- Select the input to which a video deck is connected.

3 Play the video deck.

Recording of video source

1 Connect the video source component to be played.

2 Select the VIDEO 2 input.

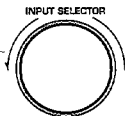
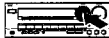

- Connect the component to be played to the VIDEO 2 jacks.
- The connectable components include a video deck (playback only), video camera (playback only), LD player or DBS tuner.

The input sources are switched in the following order:

- ① TUNER (frequency display)
- ② TAPE 1
- ③ VIDEO 1
- ④ VIDEO 2
- ⑤ CD
- ⑥ PHONO

"VIDEO 2" should be displayed.

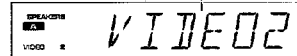

3 Play the source component.

4 Start recording on the recording video deck.

- Start recording with the video deck which is connected to the VIDEO 1 jacks.

The surround modes allow to enjoy the feeling of presence in music. Select the mode according to the source or components played. For the connections of the rear and/or center speakers, refer to "Connection of speakers". → P. 8

DOLBY 3 STEREO mode

→ P. 21

If the left and right speakers are installed apart from each other, the center acoustic image (words, etc.) may vary depending on the listener's position. The DOLBY 3 STEREO mode provides an improved positioning of the center acoustic image regardless of the listening position. To use this mode, connect the center speaker.

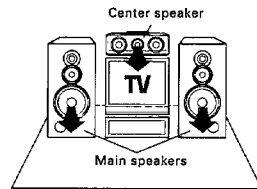

DOLBY PRO LOGIC surround mode

→ P. 22

Video and LD software programs carrying the  mark contain recording of the same Dolby Surround data as those used in movie theaters.

The DOLBY PRO LOGIC surround mode uses the Dolby Surround data and brings into home a similar sound field with full of presence to movie theater.

To use this mode, connect the rear (and center) speakers.

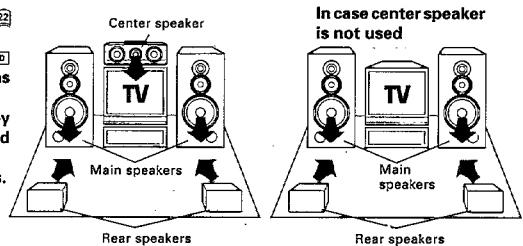

DSP presence mode

→ P. 24

This mode provides a live atmosphere to music sources. By adding the reverberation component of one of the three sound fields of this mode, it allows to enjoy three kinds of sound fields with full of feeling of presence. The sound field can be selected according your liking.

To use this mode, connect the rear speakers.

Soundscapes

- ① ARENA
- ② JAZZ CLUB
- ③ STADIUM

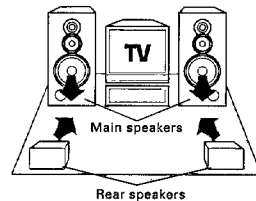

DSP LOGIC

→ P. 24

This mode provides the atmosphere of a movie theater by adding the reverberation component of movie theater to the DOLBY PRO LOGIC. To use this mode, connect both the rear and center speakers.

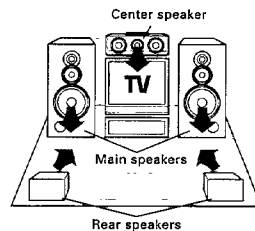

What is DSP?



The DSP stands for Digital Signal Processor. In the DSP presence and DSP LOGIC modes, the reverberation components (elements of sound echoed in various spaces) which determine the feeling of presence are created by digital processing by the DSP without spoiling the sound quality of the original music source.

This mode improves the positioning of the acoustic image of words, etc., by applying directivity enhancer processing and using an additional center speaker when a video software program recorded with ordinary 2-channel stereo is played.

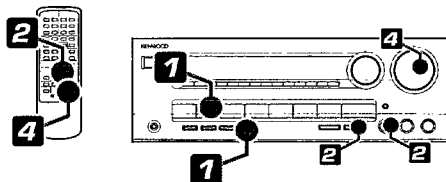

DOLBY 3 STEREO adjustment and playback

1 Activate the DOLBY 3 STEREO mode.

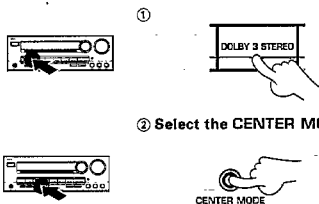

2 Adjust the volume balance.

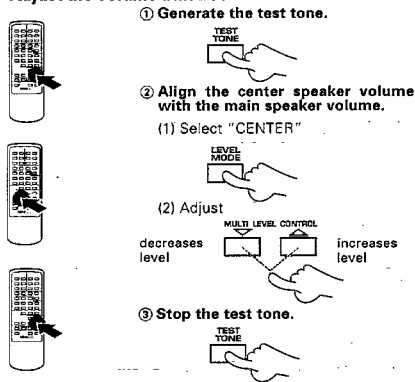

3 Play a video software program.

4 Adjust the volume.

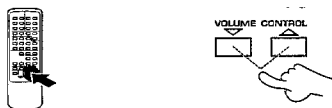

3 STEREO



Each press of the **CENTER MODE** key switches the center modes as follows:

- ① **NORMAL** :When the center speaker is a compact-sized speaker.
 - ② **WIDE BAND** :When the center speaker is a medium- or large-sized speaker.
- If you cannot tell whether your center speaker is compact or medium-sized, try two modes and select according to your liking.
 - The selected center mode is automatically stored in memory and held unless it is changed later.

- The test tone which is heard like noise moves between speakers at an interval of 1.5 sec.

Left (L)
Center (C)
Right (R)

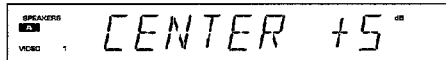
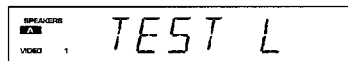

- Be sure to adjust from your listening position.
- The center level is adjusted in 1dB steps each time you press the **MULTI LEVEL CONTROL** keys.
- The center level can be adjusted in the range from -10 dB to +10 dB.
- The center level is stored in memory as the common settings with the **DOLBY PRO LOGIC** and **DSP LOGIC** mode.

To cancel DOLBY 3 STEREO play

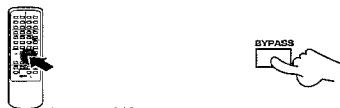

When video (LD) software carrying  mark is played, this mode provides the Dolby Surround effect, similar to movie theaters.

Manufactured under license from Dolby Laboratories Licensing Corporation. Additionally Licensed under one or more of the following patents: U.S. numbers 3,959,590; Canadian numbers 1,004,603 and 1,037,877. "Dolby", "Pro Logic" and the double-D symbol  are trademarks of Dolby Laboratories Licensing Corporation.

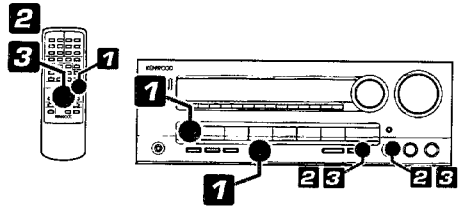

DOLBY PRO LOGIC surround arrangement

1 Activate the DOLBY PRO LOGIC mode.

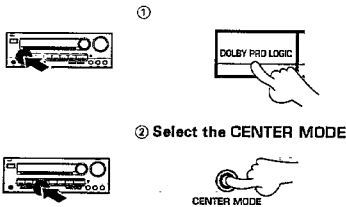

2 Adjust the delay time.

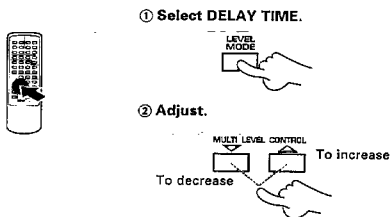

3 Adjust the volume balance.

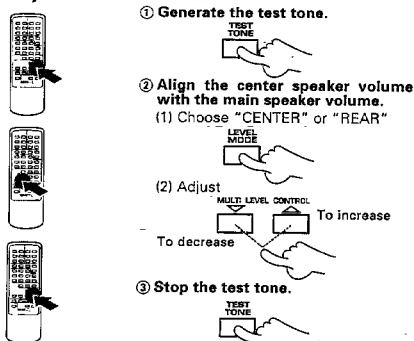

Lights up.

PRO LOGIC 

Each press of the **CENTER MODE** key switches the center modes as follows:

- ① **NORMAL** : When the center speaker is a compact-sized speaker.
 - ② **WIDE BAND** : When the center speaker is a medium- or large-sized speaker.
 - ③ **PHANTOM** : When the center speaker is not used.
- If you cannot tell whether your center speaker is compact or medium-sized, try two modes and select according to your liking.
 - The selected center mode is automatically stored in memory and held unless it is changed later.

Each press switches the band as follows:

- ① **DELAY** (DELAY TIME)
- ② **CENTER** (CENTER LEVEL)
- ③ **REAR** (REAR LEVEL)

- The delay time can be adjusted in the range from 15 ms to 30 ms, in 5 ms steps.
- Once the delay time has been preset, it is held until it is re-set later.



How to decide the DELAY TIME

- P. 23

- The test tone which is heard like noise moves between speakers at an interval of 1.5 sec.

In **NORMAL** and **WIDE BAND** modes:

- Left (L)
- Center (C)
- Right (R)
- Surround (Rear) (S)

In **PHANTOM** mode:

- Left (L)
- Right (R)
- Surround (Rear) (S)

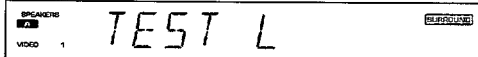

- Be sure to adjust from your listening position.
- The volume is adjusted in 1dB steps each time you press the **MULTI LEVEL CONTROL** keys.
- The volume levels can be adjusted in the range from -10 dB to +10 dB.
- The rear level is stored in memory as the common setting with the DSP and DSP LOGIC modes and the center level is stored as the common setting with the DOLBY 3 STEREO and DSP LOGIC mode.

Before playing a video (or LD) software program carrying the **[DOLBY SURROUND]** mark, be sure to complete the "DOLBY PRO LOGIC surround arrangement".

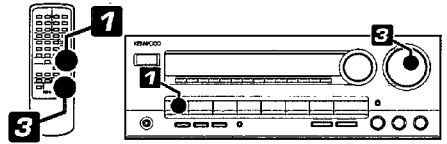

DOLBY PRO LOGIC surround playback

1 Activate the DOLBY PRO LOGIC mode.



2 Play a video software program.

3 Adjust the volume.



Each press of the key switches the modes as follows:

- ① PRO LOGIC
- ② 3 STEREO
- ③ DSP LOGIC
- ④ DSP (ARENA/JAZZ CLUB/STADIUM) Lights.



To cancel DOLBY PRO LOGIC SURROUND play

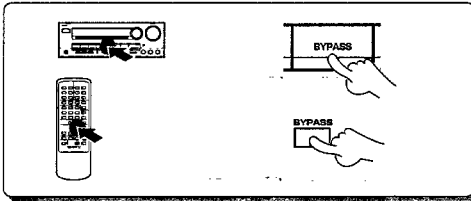

How to calculate the proper delay time

Assuming that the distance from the front speaker is A meters and the distance from the rear speakers is B meters

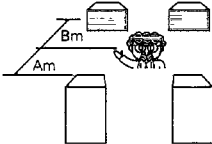

① Use the delay time calculation chart on the right.

Example: When A = 3 m, B = 3 m, the delay time is 20 ms.

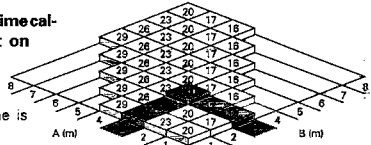

② Use the following formula for calculation.
 Delay time = 20 + 3 x (A - B) (Unit: ms)

Set the delay time to the number closest to the one you found using either method one or two.

The DSP modes allow to enjoy various sound fields. By varying the settings, it is also possible to create the user's desired sound field. The settings should be adjusted from your listening position.

Preparation

- Play a video source.

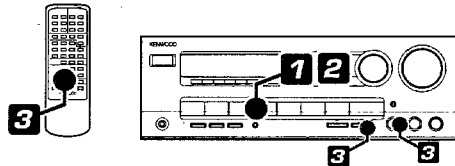

Enjoying music with a feeling of presence

1 Select a presence mode.

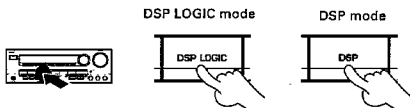

When you've chosen DSP

ARENA

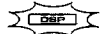

- Select in consideration of the speaker layout and the source played.

2 Select a sound field. (DSP presence mode only)

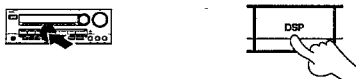

In DSP mode, the soundscape will change each time you press the key.

- ① ARENA (arena)
- ② JAZZ CLUB (jazz club)
- ③ STADIUM (stadium)

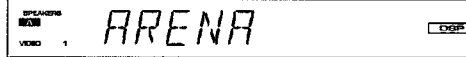

Steps 1 and 2 are enough for obtaining sufficient sound field effect. Proceed to steps 3, 4 and 5 below if you like.

3 Adjust the delay time.

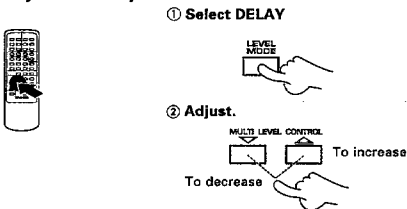

Each press switches the band as follows:

- ① DELAY (delay time)
- ② EFFECT (effect level)
- ③ REAR (rear level)

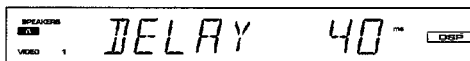

- The delay time is adjusted in 5ms steps each time you press the **MULTI LEVEL CONTROL** key.
- The delay time can be adjusted in the range from 10 ms to 60 ms.
- The values set in this step are reset to the initial values when another sound field or one of the Dolby surround modes is selected.

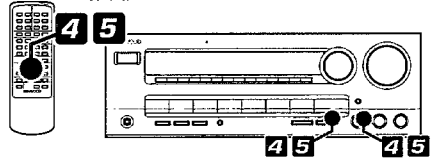

4 Adjust the effect level.

① Select EFFECT.



② Adjust.

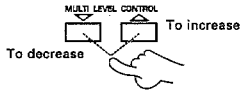

- The effect level is adjusted in 2dB steps each time you press the **MULTI LEVEL CONTROL** keys.
- The effect level's adjustment latitude is -6dB~+6dB.
- The values set in this step are reset to the initial values when another sound field or one of the Dolby surround modes is selected.

5 Adjust the volume balance.

① Choose "CENTER" or "REAR"
(To adjust the center speaker volume, the unit must be in DSP LOGIC mode.)



② Adjust.

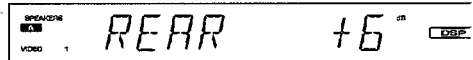
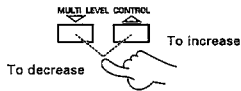

- The volume is adjusted in 1dB steps each time you press the **MULTI LEVEL CONTROL** keys.
- The rear volume level can be adjusted in range from -10 dB to +10 dB.
- The rear level is stored in memory as the common setting with the **DOLBY PRO LOGIC** mode and the center level is stored as the common settings with the **DOLBY PRO LOGIC** and **DOLBY 3 STEREO** modes.

To cancel the presence play



Goes off.



- Be sure to set the **SURROUND** to **OFF** when the presence play is not required.

In case of difficulty

KR-V707Q (E/N)

Operation to reset

The microcomputer may fall into malfunction (impossibility to operate, erroneous display, etc.) when the power cord is unplugged while power is ON or due to an external factor. In this case, execute the following procedure to reset the microcomputer and return it to normal condition.

Unplug the power cord from the power socket and, while holding the POWER key depressed, plug the power cord into the socket again.

- Please note that resetting the microcomputer clears the contents stored in it returns it to the condition when it left the factory.

Remote control unit

Symptom	Cause	Remedy
Remote control operation is not possible.	<ul style="list-style-type: none"> ● Batteries are exhausted. ● The remote control unit is too far away from the main system, controlling angle is too large, or there is an obstacle in between. ● The audio cords and system control cords are not connected properly. ● The source component to be operated does not contain the tape(s) or CD. ● An attempt is made to play a tape which is being recorded in the cassette deck. 	<ul style="list-style-type: none"> ● Replace with new batteries. → P.10 ● Operate the remote control unit within the controllable range. ● Connect properly referring to "System connection". → P.4 ● Place the tape(s) or CD in the source component to be played. ● Wait until the recording is completed.

Amplifier

Symptom	Cause	Remedy
Sound is not output.	<ul style="list-style-type: none"> ● The speaker cords are disconnected. ● The VOLUME is set to the minimum position. ● MUTE is ON. (The MUTE indicator is blinking) ● The SPEAKERS switches are set to OFF. ● The TAPE 2 key is set to ON. 	<ul style="list-style-type: none"> ● Connect them properly referring to "System connection". → P.4 ● Adjust the volume to a proper level. ● Press the MUTE key to OFF. → P.12 ● Set the SPEAKERS switch(es) to ON. ● Set the TAPE 2 key to OFF.
The STANDBY indicator blinks and sound is not output.	<ul style="list-style-type: none"> ● Speaker cords are short-circuited. 	<ul style="list-style-type: none"> ● Turn the power off, eliminate the short-circuiting, then turn on the power again. → P.5
Sound is not output from one of the speakers.	<ul style="list-style-type: none"> ● The speaker cord is disconnected. ● The BALANCE control is set to an extreme position. 	<ul style="list-style-type: none"> ● Connect it properly referring to "System connection". → P.4 ● Adjust the Left/Right balance. → P.12
Sound is not output from the Surround rear speaker and/or center speaker, or their sound is very small.	<ul style="list-style-type: none"> ● The rear-speaker cords and/or center speaker cord are disconnected. ● The Surround play mode has not been engaged. ● The REAR VOL. and/or CENTER VOL. controls are set to the minimum level. 	<ul style="list-style-type: none"> ● Connect them properly referring to "System connection". → P.4 ● Set the presence mode. → P.20 ● Adjust the REAR VOL. and CENTER VOL. controls.
A hum noise is generated when the PHONO input selector key is pressed.	<ul style="list-style-type: none"> ● The audio cord from the turntable is not inserted securely into the PHONO jacks. ● The turntable is not grounded. 	<ul style="list-style-type: none"> ● Insert the audio cord plugs securely into the PHONO jacks. → P.4 ● Connect the grounding wire to the GND terminal on the rear panel.

Tuner

Symptom	Cause	Remedy
Radio stations cannot be received.	<ul style="list-style-type: none"> ● No antenna is connected. ● The broadcast band is not set properly. ● The frequency of the desired station is not tuned. 	<ul style="list-style-type: none"> ● Connect an antenna. → P.6 ● Set the broadcast band properly. ● Tune the frequency of the desired station. → P.18
Interference.	<ul style="list-style-type: none"> ● Noise due to ignition noise of an automobile. ● Noise due to an influence from an electric appliance. ● Noise due to a nearby TV set. 	<ul style="list-style-type: none"> ● Install the outdoor antenna apart from the road. ● Turn off the power of the appliance. ● Install the system more apart from the TV set.
A station which was preset cannot be received by pressing the corresponding numeric key.	<ul style="list-style-type: none"> ● The preset station belongs to a frequency that cannot be received. ● The preset memory was cleared because the power cord had been unplugged for a long period of time. 	<ul style="list-style-type: none"> ● Preset a station with a receivable frequency. ● Preset the station again. → P.17

Notes

Do not use contact cleaners because it could cause a malfunction. Be specially careful against contact cleaners containing oil, for they may deform the plastic components.



Specifications U.S.A. and Canada

⚠ Caution : Read this page carefully
to ensure safe operation.

KR-V7070 (En)

Audio section

Rated power output at the STEREO operation

100 watts per channel minimum RMS, both channels driven at 8 Ω , from 20 Hz to 20,000 Hz with no more than 0.06 % total harmonic distortions. (FTC)

Power output at the Surround operation

Front

100 watts per channel minimum RMS, both channels driven at 8 Ω , 1 kHz with no more than 0.7 % total harmonic distortions. (FTC)

Center

100 watts per channel minimum RMS, both channels driven at 8 Ω , 1 kHz with no more than 0.7 % total harmonic distortions. (FTC)

Rear

28 watts per channel minimum RMS, both channels driven at 8 Ω , 1 kHz with no more than 0.7 % total harmonic distortions. (FTC)

Total harmonic distortion (1 kHz, 8 Ω) 0.01 % at 50 W
Signal to noise ratio (IHF A)

PHONO (MM) 75 dB
CD 98 dB

Input sensitivity / impedance

PHONO (MM) 2.5 mV / 47 k Ω
CD, TAPE, VIDEO 200 mV / 47 k Ω

Output level / impedance

S.W. OUT 2.0 V / 600 Ω

Tone controls

BASS ± 10 dB (at 100 Hz)
TREBLE ± 10 dB (at 10 kHz)
N.B. circuit + 9 dB (70 Hz)

Video section

VIDEO inputs / outputs (Composite) 1 Vp-p / 75 Ω

FM Tuner section

Tuning frequency range 87.5 MHz ~ 108 MHz
Usable sensitivity (IHF) 13.2 dBf (1.2 μ V at 75 Ω)
50 dB quieting sensitivity

STEREO 41.2 dBf (32 μ V at 75 Ω)

Total harmonic distortion at 1 kHz

MONO 0.6 %

STEREO 0.7 %

Signal to noise ratio at 65 dBf (IHF)

MONO 75 dB

STEREO 68 dB

Selectivity (IHF ± 400 kHz) 50 dB

Stereo separation (IHF at 1 kHz) 40 dB

Frequency response 30 Hz ~ 15 kHz, + 0.5 dB, - 3.0 dB

AM Tuner section

Tuning frequency range 530 kHz ~ 1,700 kHz

Usable sensitivity 12 μ V / (500 μ V / m)

Total harmonic distortion 0.7 %

Signal to noise ratio 48 dB

Selectivity 30 dB

General

Power consumption 3.5 A

AC outlet

SWITCHED 2: (total 150 W, 1.25 A max.)

Dimensions W: 440 mm (17-5/16")

H: 144 mm (5-11/16")

D: 347 mm (13-11/16")

Weight (net) 9.8 kg (21.6 lb)

Note

KENWOOD follows a policy of continuous advancements in development. For this reason specifications may be changed without notice.



Specifications Other countries

Caution: Read this page carefully to ensure safe operation.

KR-V7070 (En)

Audio section

Rated power output at the STEREO operation (EIAJ) 1 kHz, 10 % THD at 8 Ω	132 W + 132 W
(DIN/IEC) from 63 Hz to 12,500 Hz, 0.7 % T.H.D., at 8 Ω	100 W + 100 W
Power output at the Surround operation	
Front (1 kHz, 0.7 % T.H.D. at 8 Ω)	100 W + 100 W
Center (1 kHz, 0.7 % T.H.D. at 8 Ω)	100 W
Rear (1 kHz, 0.7 % T.H.D. at 8 Ω)	28 W + 28 W
Total harmonic distortion (1 kHz, 8 Ω) 0.01 % at 50 W	
Signal to noise ratio (IHF'66)	
PHONO (MM)	75 dB
CD	98 dB
Input sensitivity / impedance	
PHONO (MM)	2.5 mV / 47 k Ω
CD, TAPE, VIDEO	200 mV / 47 k Ω
Output level / impedance	
S.W. OUT	2.0 V / 600 Ω
Tone controls	
BASS	\pm 10 dB (at 100 Hz)
TREBLE	\pm 10 dB (at 10 kHz)
N.B. circuit	+ 9 dB (70 Hz)

Video section

VIDEO inputs / outputs (Composite) 1 Vp-p / 75 Ω

FM Tuner section

Tuning frequency range	87.5 MHz ~ 108 MHz
Usable sensitivity (IHF)	13.2 dBf (1.2 μ V at 75 Ω)
50 dB quieting sensitivity	
STEREO	41.2 dBf (32 μ V at 75 Ω)
Total harmonic distortion at 1 kHz	
MONO	0.6 %
STEREO	0.7 %
Signal to noise ratio at 65 dBf (IHF)	
MONO	75 dB
STEREO	68 dB
Selectivity (IHF \pm 400 kHz)	50 dB
Stereo separation (IHF at 1 kHz)	40 dB
Frequency response	30 Hz ~ 15 kHz, + 0.5 dB, - 3.0 dB

AM Tuner section

Tuning frequency range	
9 kHz	531 kHz ~ 1,602 kHz
10 kHz	530 kHz ~ 1,610 kHz
Usable sensitivity	12 μ V / (500 μ V / m)
Total harmonic distortion	0.7 %
Signal to noise ratio	48 dB
Selectivity	30 dB

General

Power consumption	300 W
AC outlet	
SWITCHED	2: (total 90 W max.)
	(Except for Australia)
Dimensions	W: 440 mm
	H: 144 mm
	D: 347 mm
Weight (net)	9.8 kg

Note

KENWOOD follows a policy of continuous advancements in development. For this reason specifications may be changed without notice.



Free Manuals Download Website

<http://myh66.com>

<http://usermanuals.us>

<http://www.somanuals.com>

<http://www.4manuals.cc>

<http://www.manual-lib.com>

<http://www.404manual.com>

<http://www.luxmanual.com>

<http://aubethermostatmanual.com>

Golf course search by state

<http://golfingnear.com>

Email search by domain

<http://emailbydomain.com>

Auto manuals search

<http://auto.somanuals.com>

TV manuals search

<http://tv.somanuals.com>