

KENWOOD

KVT-815DVD

KVT-745DVD

KVT-715DVD

MONITOR WITH DVD RECEIVER

INSTALLATION MANUAL

MONITEUR AVEC RÉCEPTEUR DVD

MANUEL D'INSTALLATION

MONITOR CON RECEPTOR DVD

MANUAL DE INSTALACIÓN











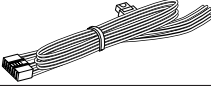

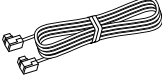
MONITOR COM RECEPTOR DVD

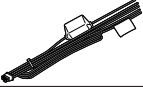
MANUAL DE INSTALAÇÃO

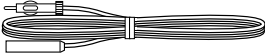
KENWOOD CORPORATION

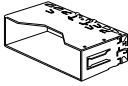
Before Installation

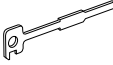
Accessories

①	1	⑧	4
②	1	⑨	2
③	1	⑩	2
④	1	⑪	4
⑤	1	⑫	4
⑥	2			
⑦	4			

Installation Procedure

1. To prevent a short circuit, remove the key from the ignition and disconnect the ⊖ battery.
2. Make the proper input and output wire connections for each unit.
3. Connect the speaker wires of the wiring harness.
4. Connect the wiring harness wires in the following order: ground, battery, ignition.
5. Connect the wiring harness connector to the unit.
6. Install the unit in your car.
7. Reconnect the ⊖ battery.
8. Press the reset button.

▲WARNING

If you connect the ignition wire (red) and the battery wire (yellow) to the car chassis (ground), you may cause a short circuit, that in turn may start a fire. Always connect those wires to the power source running through the fuse box.

▲CAUTION

- If your car's ignition does not have an ACC position, connect the ignition wires to a power source that can be turned on and off with the ignition key. If you connect the ignition wire to a power source with a constant voltage supply, as with battery wires, the battery may die.
- If the console has a lid, make sure to install the unit so that the faceplate will not hit the lid when closing and opening.
- If the fuse blows, first make sure the wires aren't touching to cause a short circuit, then replace the old fuse with one with the same rating.
- Insulate unconnected wires with vinyl tape or other similar material. To prevent a short circuit, do not remove the caps on the ends of the unconnected wires or the terminals.
- Connect the speaker wires correctly to the terminals to which they correspond. The unit may be damaged or fail to work if you share the ⊖ wires or ground them to any metal part in the car.
- When only two speakers are being connected to the system, connect the connectors either to both the front output terminals or to both the rear output terminals (do not mix front and rear). For example, if you connect the ⊕ connector of the left speaker to a front output terminal, do not connect the ⊖ connector to a rear output terminal.
- After the unit is installed, check whether the brake lamps, blinkers, wipers, etc. on the car are working properly.
- Mount the unit so that the mounting angle is 30° or less.

Connection

English

▲WARNING

If you connect the ignition wire (red) and the battery wire (yellow) to the car chassis (ground), you may cause a short circuit, that in turn may start a fire. Always connect those wires to the power source running through the fuse box.

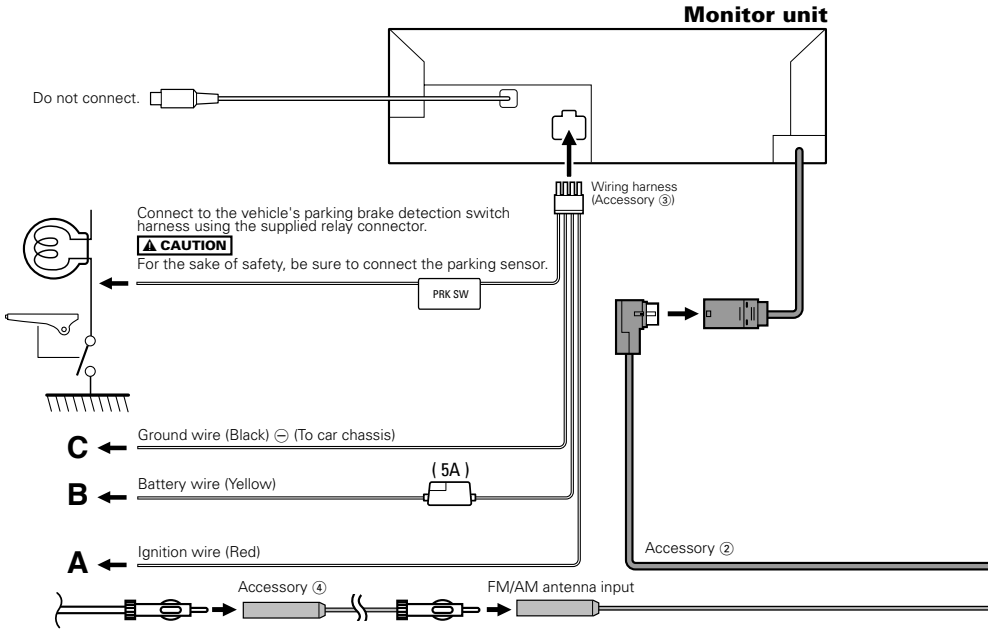

Monitor unit

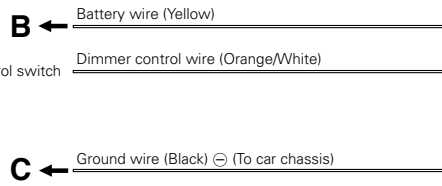

- B** ← Battery wire (Yellow)
- To car light control switch **Dimmer control wire (Orange/White)**
- C** ← Ground wire (Black) ⊖ (To car chassis)

- Depending on what antenna you are using, connect either to the control terminal of the motor antenna, or to the power terminal for the booster amplifier of the film-type antenna. **Motor antenna control wire (Blue)**
- When using the optional power amplifier, connect to its power control terminal. **Power control wire (Blue/White)**
- To "EXT.AMP.CONT." terminal of the amplifier having the external amp control function. **External amplifier control wire (Pink/Black)**

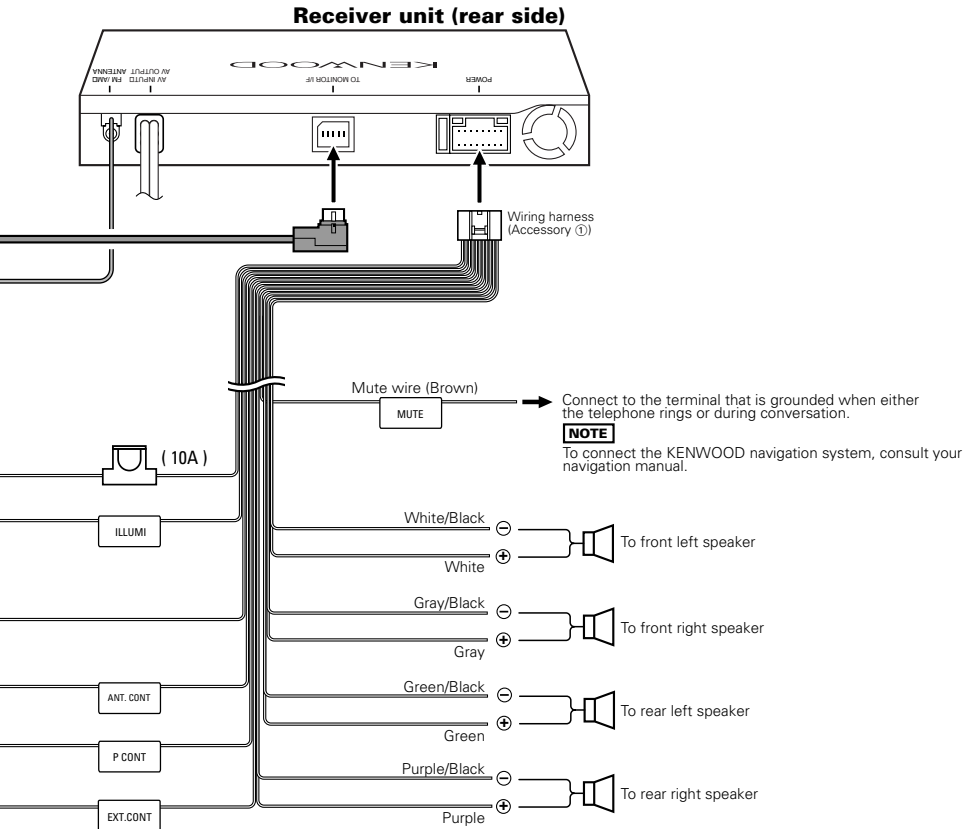
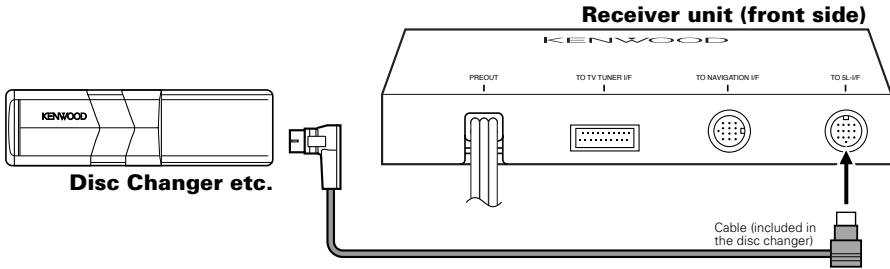

Connection

English

System Connection

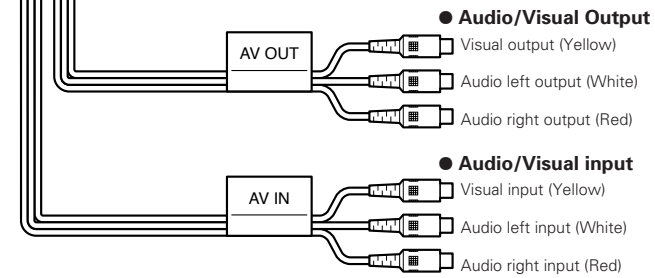
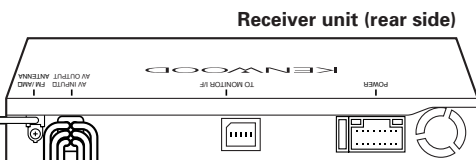
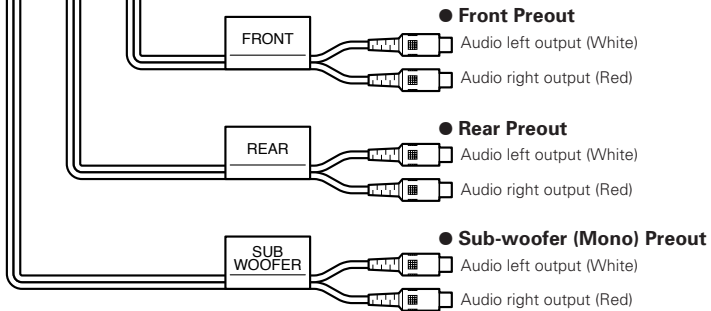
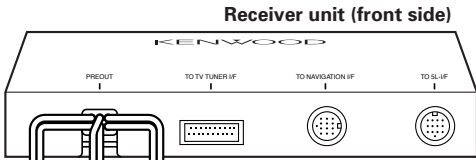

Installation

Installation for Monitor/Player Unit

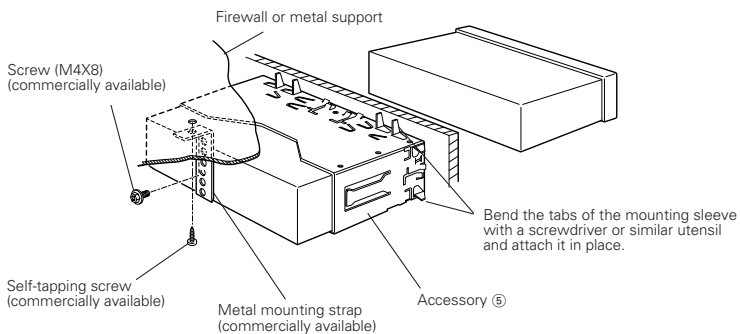

 Make sure that the unit is installed securely in place. If the unit is unstable, it may malfunction (eg, the sound may skip).

Installation for Receiver unit

1. Attach the installation brackets ⑨ to the sides of the hideaway unit using the sems bolts ⑦.

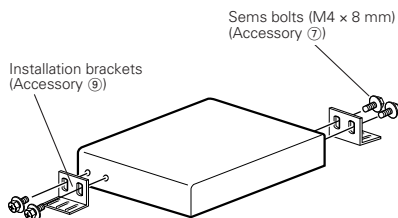

2. Use the tapping screw ⑧ to secure the hideaway unit to the audio board.

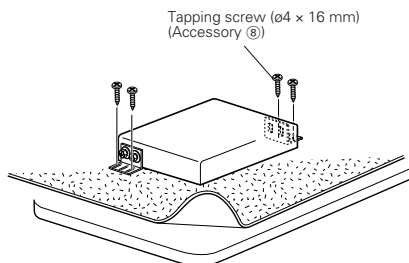

Installation

Installing in Japanese-Made Cars

- Installing on Toyota, Nissan or Mitsubishi Car Using Brackets at Holes shown by "●"

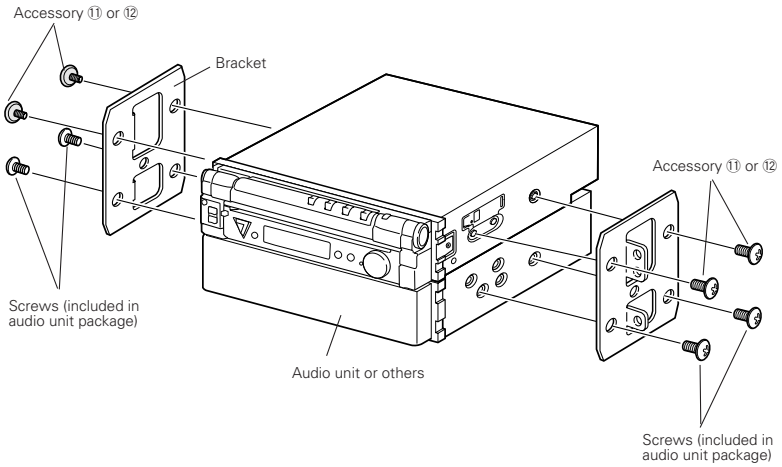
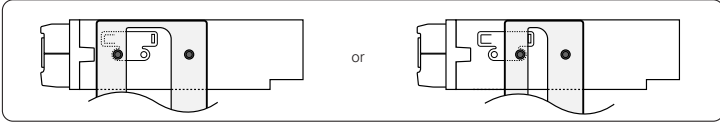

■ Installation on Toyota Car using Brackets at Holes shown by "●"

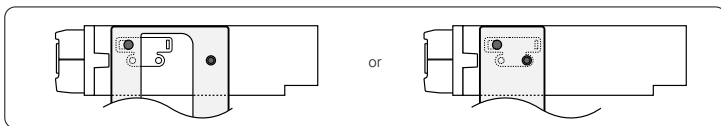

When using the bracket shown above, you cannot use screws at two holes of the right and left unit sides. If so, tighten the bracket using accessories ⑩ as shown below.

1. Use accessories ⑩ at both sides as shown.

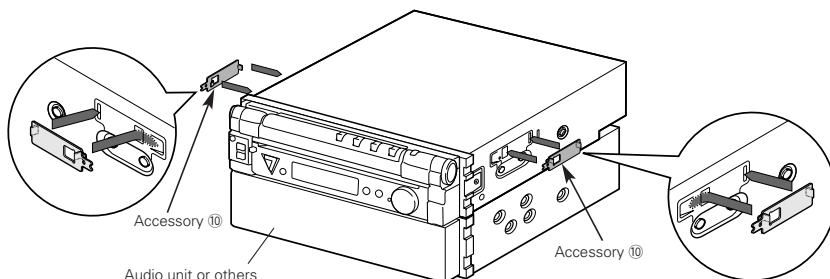

2. Mount the bracket at each side.

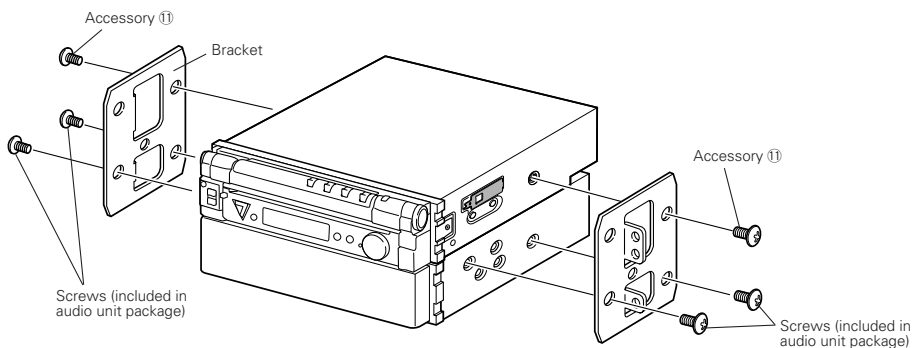

3. Bend each end of accessory ⑩ to fix the bracket.

Use a flat-blade screwdriver or pliers, and bend each accessory tab into the hole of installation bracket to fix the bracket.

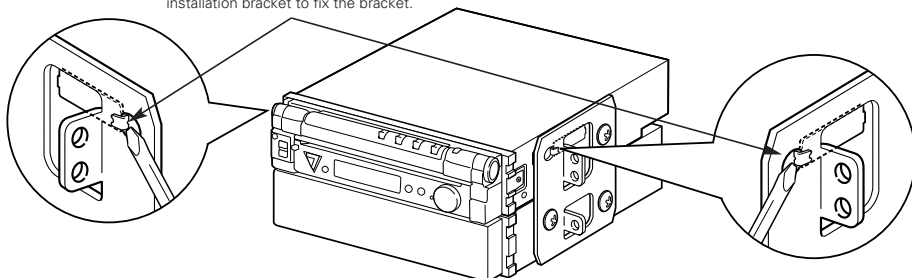

Installation

Removing Monitor/Player Unit

■ Removing the Hard Rubber Frame (escutcheon)

1. Engage the catch pins on the removal tool ⑥ and remove the two locks on the lower level. Lower the frame and pull it forward as shown in the figure.

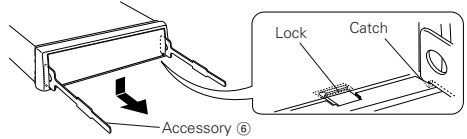

2. When the lower level is removed, remove the upper two locations.



The frame can be removed from the top side in the same manner.

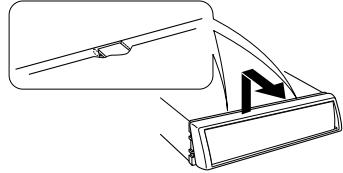

Removing the Unit

1. Refer to the section <Removing the Hard Rubber Frame> and then remove the hard rubber frame.
2. Remove the Hex-head screw with integral washer (M4 x 6) on the back panel.
3. Insert the two removal tools ⑥ deeply into the slots on each side, as shown.

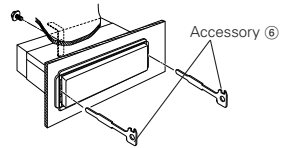

4. Lower the removal tool toward the bottom, and pull out the unit halfway while pressing towards the inside.



Be careful to avoid injury from the catch pins on the removal tool.

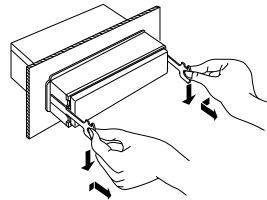

5. Pull the unit all the way out with your hands, being careful not to drop it.

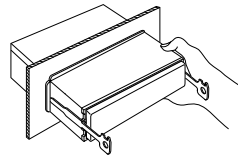

Avant l'installation

Accessoires

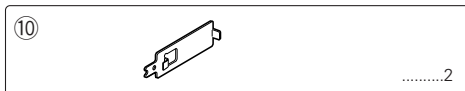
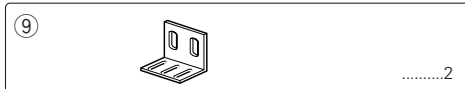
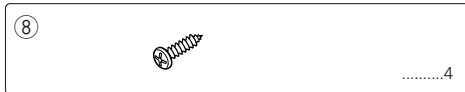
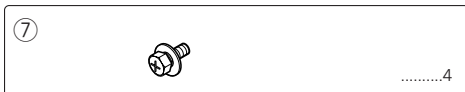
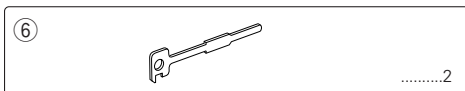
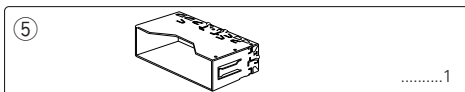
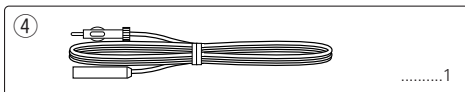
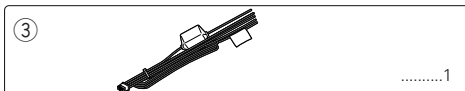
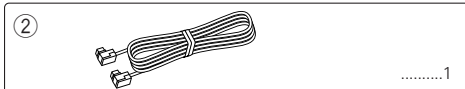
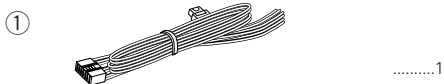

Procédure d'installation

1. Afin d'empêcher un court circuit, retirez la clé du contact et déconnectez la batterie ⊖.
2. Effectuez correctement les connexions d'entrée et sortie de chaque appareil.
3. Connectez les câbles de haut-parleur du faisceau de câbles.
4. Connectez les fils du câblage de distribution électrique dans l'ordre suivant : masse, batterie, contact.
5. Connectez le connecteur du câblage de distribution électrique à l'appareil.
6. Installez l'appareil dans votre voiture.
7. Reconnectez la batterie ⊖.
8. Appuyez sur la touche de réinitialisation.

▲AVERTISSEMENT

Si vous connectez le câble d'allumage (rouge) et le câble de batterie (jaune) au châssis de la voiture (masse), vous risquez de causer un court-circuit qui peut provoquer un incendie. Connectez toujours ces câbles à la source d'alimentation de la boîte à fusible.

▲ATTENTION

- Si le contact de votre voiture ne dispose pas d'une position ACC, connectez les fils de contact à une source d'alimentation pouvant être activée et désactivée avec la clé de contact. Si vous connectez le fil de contact à une source d'alimentation avec une alimentation de tension constante, comme avec des fils de batterie, la batterie peut mourir.
- Si la console a un couvercle, assurez-vous d'installer l'unité de manière à ce que la dalle ne touche pas le couvercle lors de l'ouverture et de la fermeture.
- Si le fusible saute, assurez-vous d'abord que les fils ne se touchent pas et n'entraînent pas de court-circuit, puis remplacez le fusible grillé par un fusible neuf de même capacité.
- Isolez les câbles non-connectés avec un ruban adhésif en vinyle ou autre matériel similaire. Afin d'empêcher tout court-circuit, ne retirez pas les capuchons présents aux extrémités des fils ou des bornes non connectés.
- Connectez les fils d'enceinte correctement aux bornes correspondantes. L'appareil peut être endommagé ou ne pas fonctionner si vous partagez les fils ⊖ ou si vous les mettez à la masse sur une partie métallique de la voiture.
- Lorsque deux enceintes seulement sont connectées au système, connectez les connecteurs soit aux deux bornes de sortie avant, soit aux deux bornes de sortie arrière (ne mélangez l'avant et l'arrière). Par exemple, si vous connectez le connecteur ⊕ de l'enceinte gauche à une borne de sortie avant, ne connectez pas le connecteur ⊖ à une borne de sortie arrière.
- Après avoir installé l'appareil, vérifiez si les feux de freinage, les indicateurs, les clignotants, etc de la voiture fonctionnent correctement.
- Monter l'unité de façon à ce que l'angle de montage soit de 30° ou moins.

Connexion

⚠ AVERTISSEMENT

Si vous connectez le câble d'allumage (rouge) et le câble de batterie (jaune) au châssis de la voiture (masse), vous risquez de causer un court-circuit qui peut provoquer un incendie. Connectez toujours ces câbles à la source d'alimentation de la boîte à fusible.

French

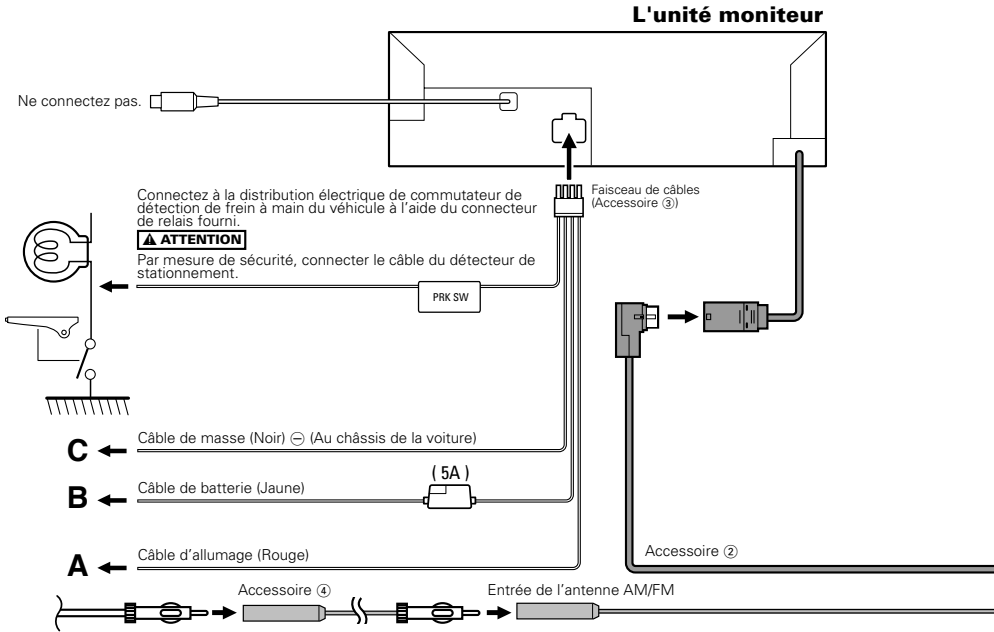

- B** ← Câble de batterie (Jaune)
- ← Câble de commande du gradateur (Orange/Blanc)
- C** ← Câble de masse (Noir) ⊖ (Au châssis de la voiture)

Au commutateur d'éclairage de la voiture

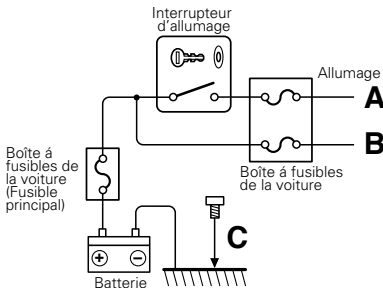

Selon l'antenne que vous utilisez, connectez à la prise de commande du moteur d'antenne ou à la prise d'alimentation du préamplificateur de l'antenne de type film.

Câble de commande de l'antenne moteur (Bleu)

Lors de l'utilisation de l'amplificateur de puissance optionnel, connectez à sa prise de commande d'alimentation.

Câble de commande de l'alimentation (Bleu/Blanc)

Vers le terminal "EXT.AMP.CONT." de l'amplificateur ayant la fonction de contrôle de l'amp. extérieure.

Câble de commande de l'amplificateur externe (Rose/Noir)

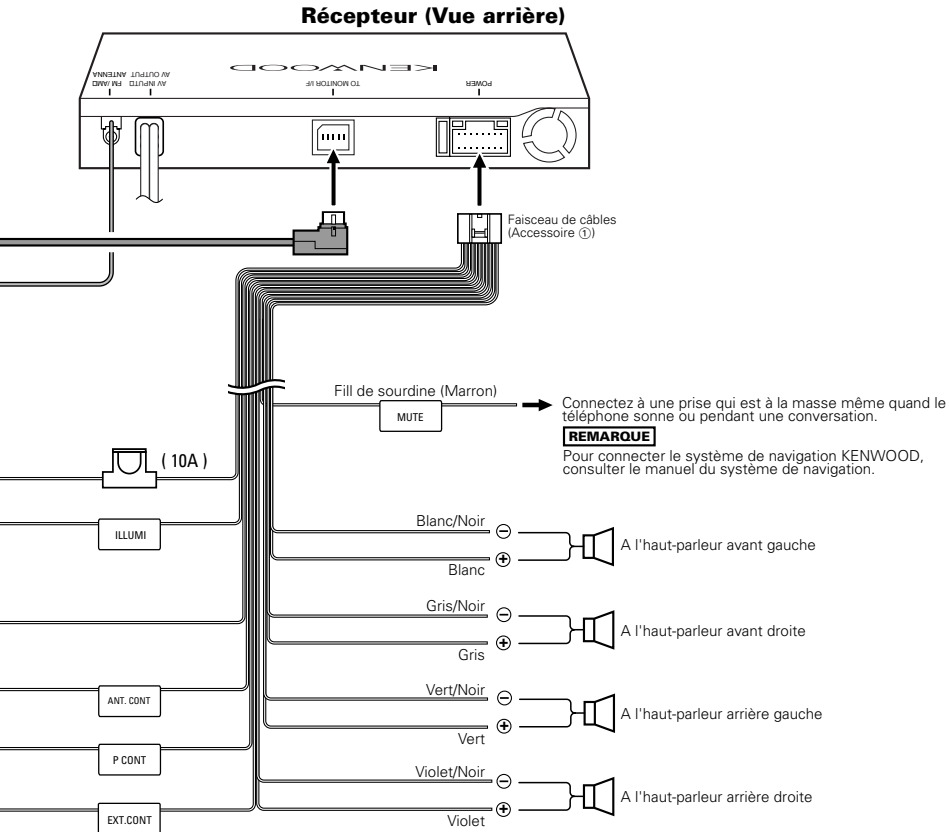
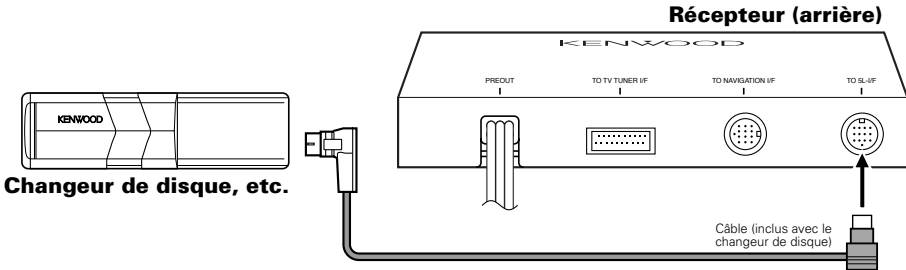

Connexion du système

French

Récepteur (arrière)

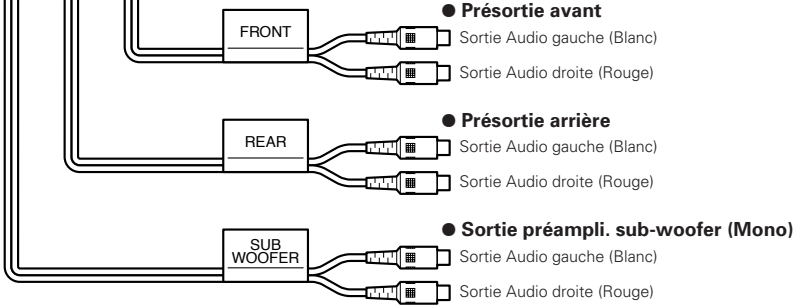
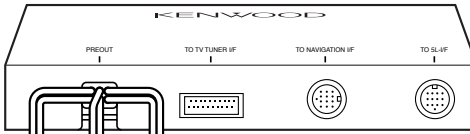

Récepteur (Vue arrière)

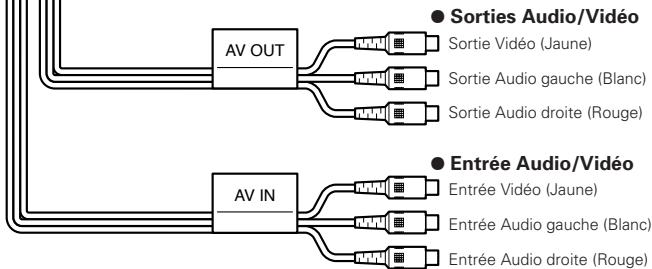

Installation pour unité moniteur/lecteur

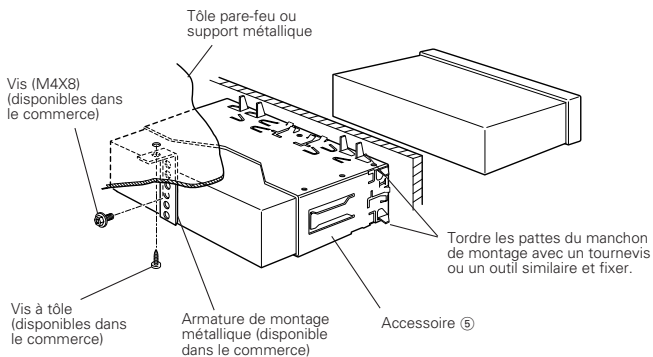

Assurez-vous que l'appareil est solidement installé à sa place. Si l'appareil est instable, il pourrait ne pas bien fonctionner (par ex., le son pourrait sauter).

Installation du récepteur

1. Fixer les attaches d'installation ⑨ sur les côtés de l'unité de dissimulation à l'aide de vis à tête sems ⑦.

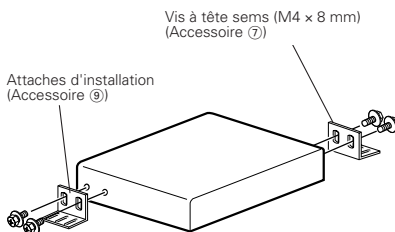

2. Utiliser la vis taraudeuse ⑧ pour fixer l'unité de dissimulation sur le panneau audio.

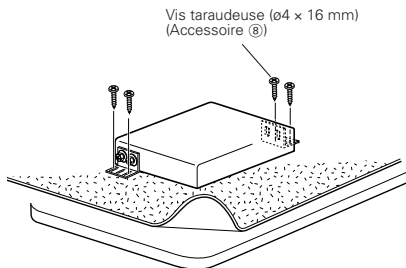

Installation

Installation dans des véhicules de fabrication japonaise

- Installation dans des véhicules Toyota, Nissan ou Mitsubishi avec supports qui utilisent les trous indiqués par "●"

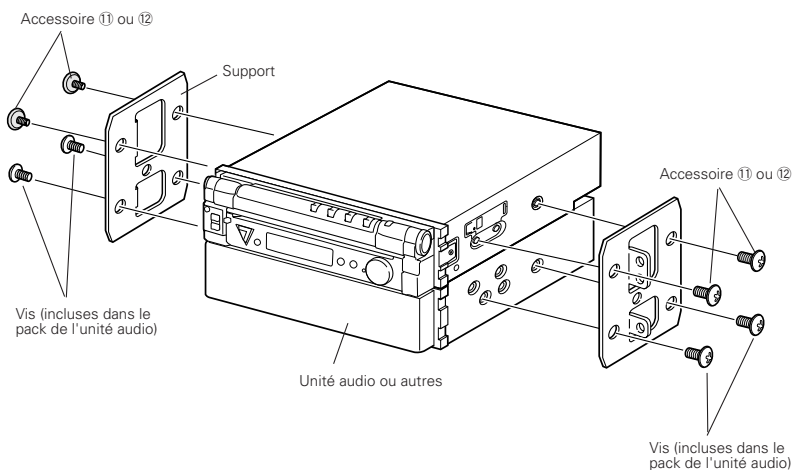
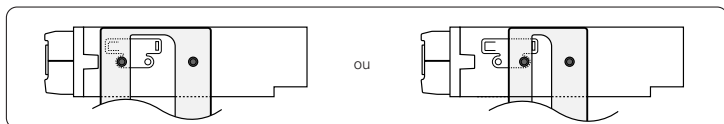

■ Installation dans des véhicules Toyota avec supports qui utilisent les trous indiqués par "●"

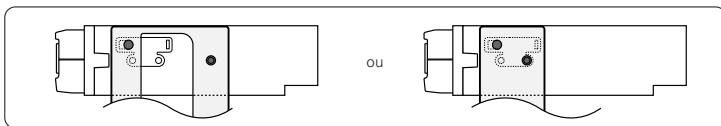

Lorsque les supports indiqués ci-dessus sont utilisés, vous ne pouvez utiliser les vis des deux trous sur les côtés droit et gauche. Si c'est le cas, serrez le support en utilisant les accessoires ⑩ comme indiqué ci-dessous.

1. Utilisez les accessoires ⑩ des deux côtés comme indiqué.

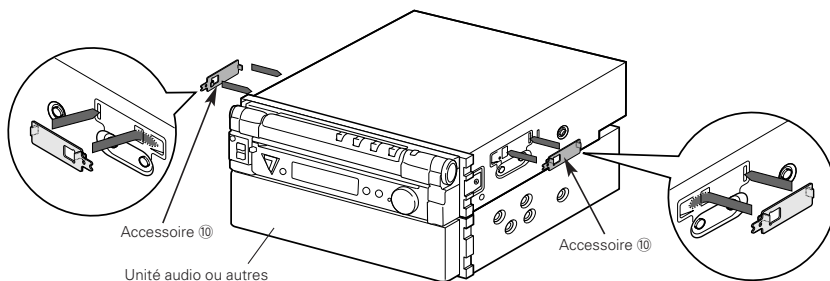

2. Installez un support de chaque côté.

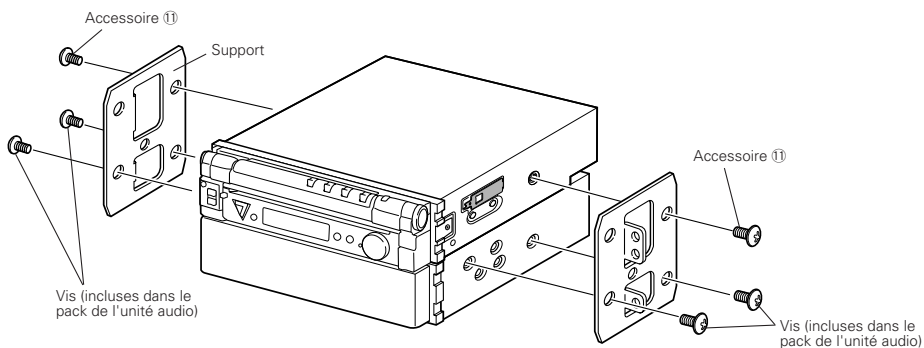

3. Pliez chaque extrémité de l'accessoire ⑩ pour fixer le support.

Utilisez un tournevis plat ou une pince et pliez la languette de chaque accessoire dans les trous du support de montage pour fixer ce dernier.

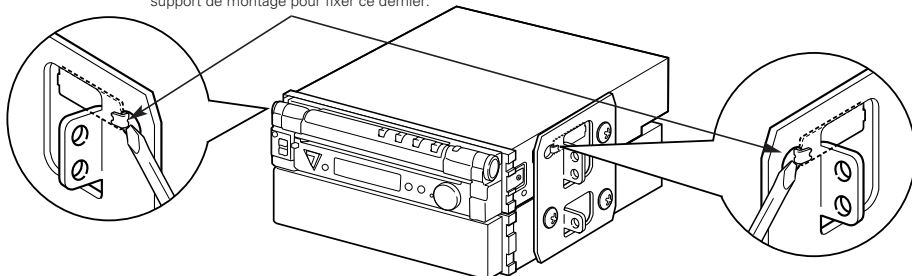

Retrait de l'unité moniteur/lecteur

■ Retrait du cadre en caoutchouc dur (écusson)

1. Engagez les loquets sur l'outil de démontage ⑥ et enlevez les deux crochets inférieurs. Baissez le cadre et tirez-le vers l'avant comme montré sur l'illustration.

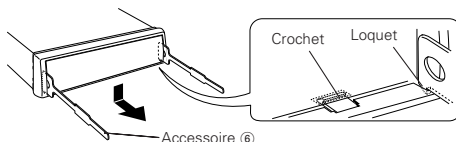

2. Quand la partie inférieure est retirée, retirez les deux crochets supérieurs.

 Le cadre peut être retiré à partir de la partie supérieur de la même façon.

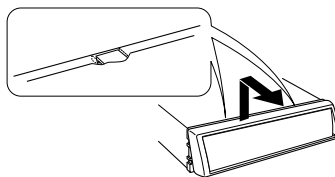

Retrait de l'appareil

1. Référez vous à la section <Retrait du cadre en caoutchouc dur> puis retirez le cadre en caoutchouc dur.
2. Retirez la vis (M4 x 6) sur le panneau arrière.
3. Insérez les deux outils de démontage ⑥ profondément dans les fentes de chaque côté, comme montré.

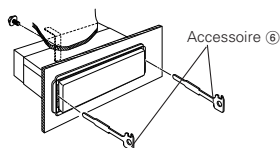

4. Baissez les outils de démontage vers le bas et tirez l'appareil à moitié en faisant pression vers l'intérieur.

 Faites attention de ne pas vous blesser avec le loquet de l'outil de démontage.

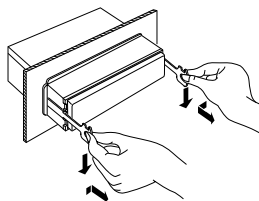



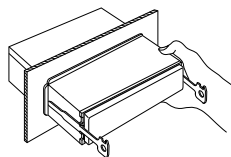





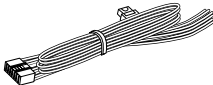

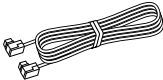

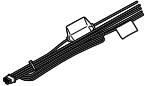
5. Sortez l'appareil entièrement avec les mains, en faisant attention de ne pas le faire tomber.

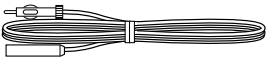

Antes de la instalación

Accesorios

①	1	⑧	4
②	1	⑨	2
③	1	⑩	2
④	1	⑪	4
⑤	1	⑫	4
⑥	2			
⑦	4			

Spanish

Procedimiento de instalación

1. Para prevenir cortocircuitos, retire la llave del encendido y desconecte la batería ⊖.
2. Inserte correctamente el conector de cada cable en el lugar de la unidad que le corresponda.
3. Conecte los cables de los altavoces al conector ISO.
4. Conecte la alimentación en el siguiente orden: tierra, batería, encendido.
5. Conecte el mazo de alimentación a la unidad.
6. Instale la unidad en el automóvil.
7. Conecte nuevamente la batería ⊖.
8. Haga una reposición del sistema (reset).

▲ADVERTENCIA

Si usted conecta el cable de encendido (rojo) y el cable de la batería (amarillo) al chasis del vehículo (tierra), puede ocasionar un cortocircuito, que puede provocar un incendio. Conecte siempre esos cables a la fuente de alimentación que pasa por la caja de fusibles.

▲PRECAUCIÓN

- Si el encendido de su vehículo no tiene una posición ACC, conecte los cables de encendido a una fuente de alimentación que se pueda encender y apagar con la llave de encendido. Si conecta el cable de encendido a una fuente de alimentación con un suministro de voltaje constante, como con los cables de la batería, la batería puede agotarse.
- Si el panel de mandos tiene una tapa, asegúrese de instalar la unidad de tal forma que la placa frontal no golpee la tapa cuando se abra o se cierre.
- Si se funden los fusibles, asegúrese primero de que los cables no están en contacto pues pueden ocasionar un cortocircuito, luego reemplace el fusible dañado por uno nuevo que tenga la misma potencia de servicio.
- Aislar los cables no utilizados. Para prevenir cortocircuito, no quite las tapas de los cables o terminales sin conectar.
- Conecte correctamente los cables de altavoz a los terminales que corresponden. La unidad se puede dañar o no funcionar si combina los cables ⊖ o a tierra con cualquier parte metálica en el vehículo.
- Cuando solamente se conectan dos altavoces al sistema, los conectores se deben conectar ya sea a los terminales de salida delanteros o a los terminales de salida traseros (nunca mezcle los delanteros y los traseros). Por ejemplo, si realiza la conexión del conector ⊕ del altavoz izquierdo a un terminal de salida delantero, no conecte el conector ⊖ a un terminal de salida trasero.
- Después de haber instalado la unidad asegúrese de que las luces y los indicadores del automóvil funcionan correctamente.
- Instale la unidad en un ángulo de 30° o menos.

Conexión

⚠ ADVERTENCIA

Si usted conecta el cable de encendido (rojo) y el cable de la batería (amarillo) al chasis del vehículo (tierra), puede ocasionar un cortocircuito, que puede provocar un incendio. Conecte siempre esos cables a la fuente de alimentación que pasa por la caja de fusibles.

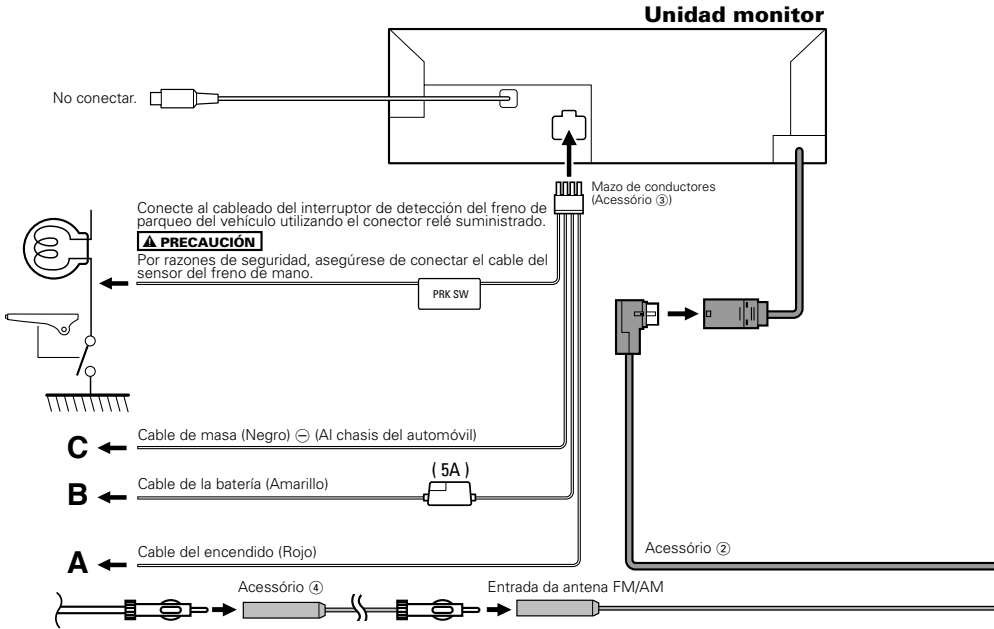

Spanish

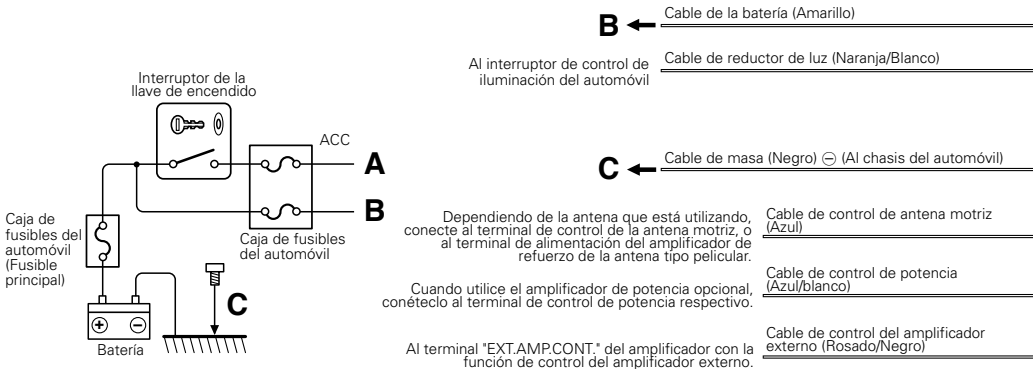

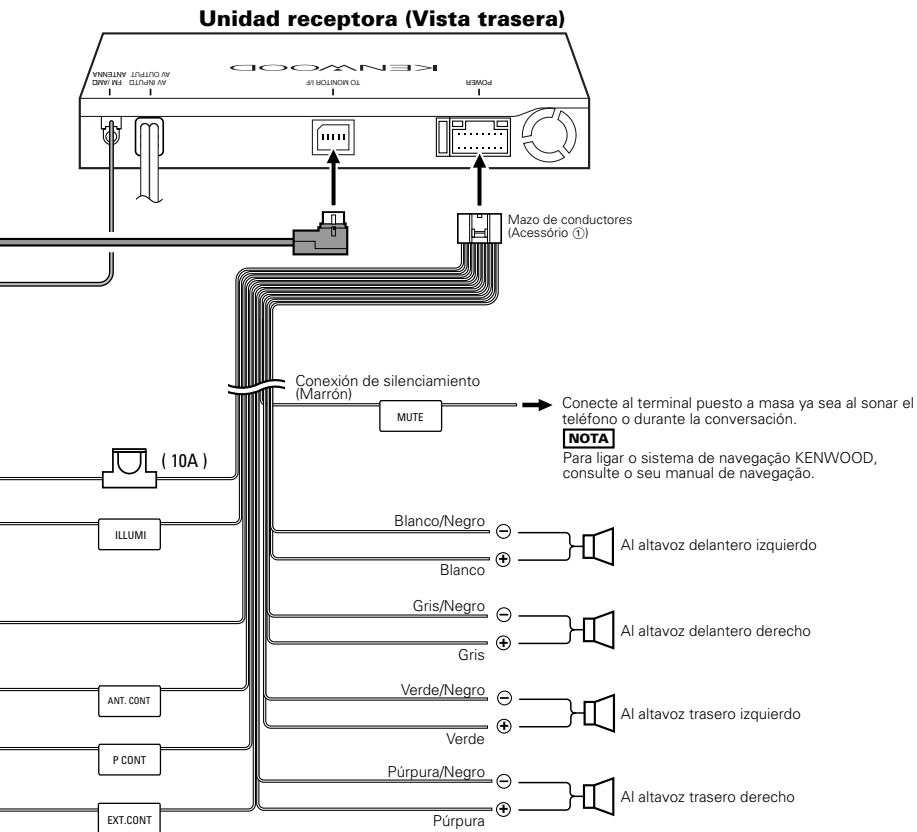
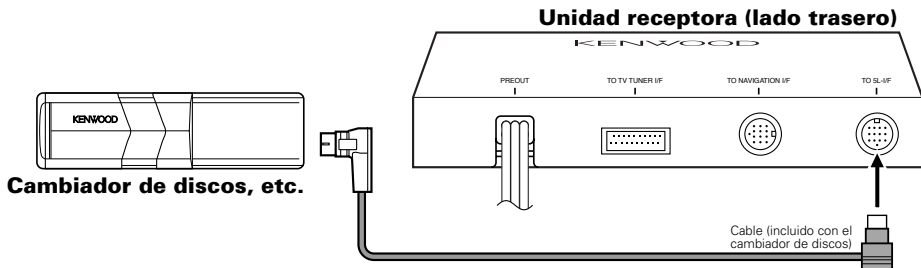

Conexión del sistema

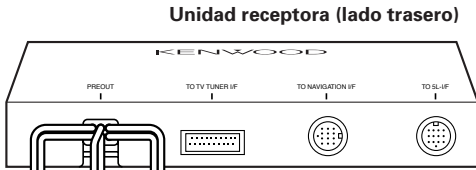

● **Salida de preamplificador delantera**

Salida de audio izquierda (Blanco)

Salida de audio derecha (Rojo)

● **Salida de preamplificador trasera**

Salida de audio izquierda (Blanco)

Salida de audio derecha (Rojo)

● **Previo de salida del subwoofer (mono)**

Salida de audio izquierda (Blanco)

Salida de audio derecha (Rojo)

Unidad receptora (Vista trasera)

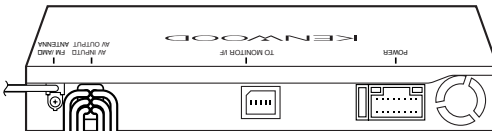

● **Salida de audio/visual**

Salida visual input (Amarillo)

Salida de audio izquierda (Blanco)

Salida de audio derecha (Rojo)

● **Entrada de audio/visual**

Entrada visual input (Amarillo)

Entrada de audio izquierda (Blanco)

Entrada de audio derecha (Rojo)

Instalación para el monitor/unidad de reproductor

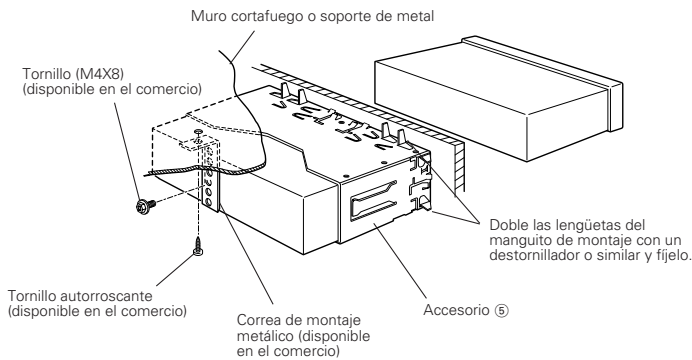

 Asegúrese de que la unidad está instalada en forma segura. Si la unidad está en una posición inestable, es posible que no funcione correctamente (por ejemplo, el sonido puede interrumpirse).

Instalación para la unidad receptora

1. Instale los soportes de instalación ⑨ a los lados de la unidad escondida utilizando los pernos ⑦.

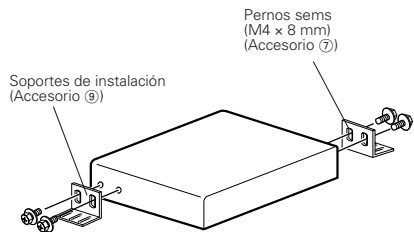

2. Utilice el tornillo de rosca cortante ⑧ para asegurar la unidad escondida al panel de audio.

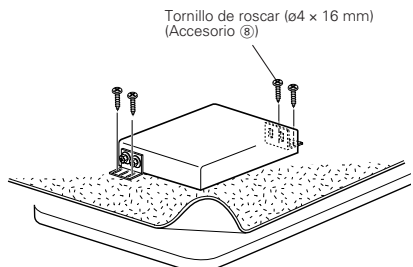

Instalación

Instalación en automóviles fabricados en Japón

- Instalación en automóviles Toyota, Nissan o Mitsubishi con abrazadera en orificios indicados por "●"

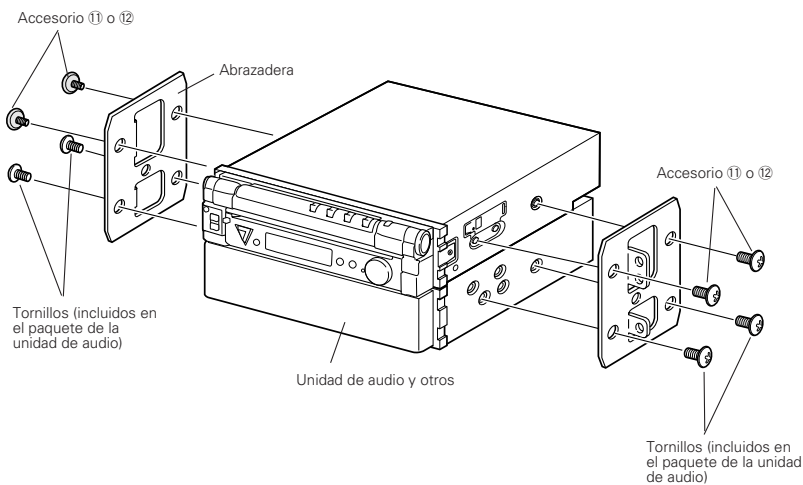
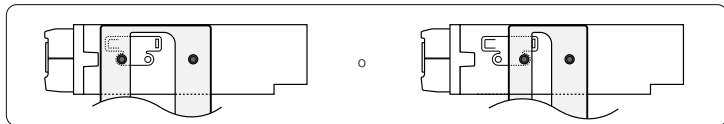

■ Instalación en automóviles Toyota con abrazadera en orificios indicados por "●"

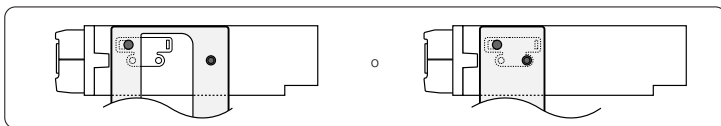

Cuando se utilice la abrazadera indicada anteriormente, no es posible utilizar tornillos en los dos orificios de los lados derecho e izquierdo de la unidad. En tal caso, apriete la abrazadera con los accesorios 10 como se indica a continuación.

1. Utilice los accesorios 10 a ambos lados como se indica.

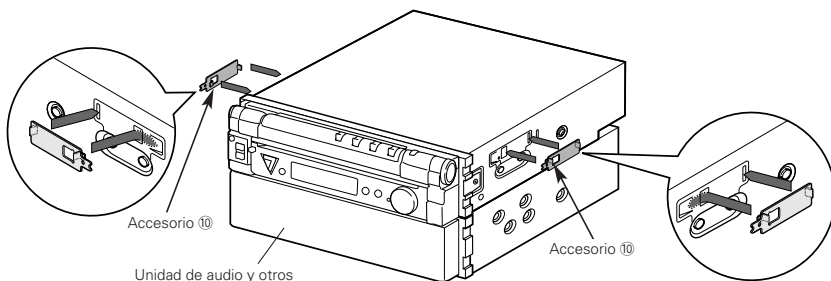

2. Monte la abrazadera a cada lado.

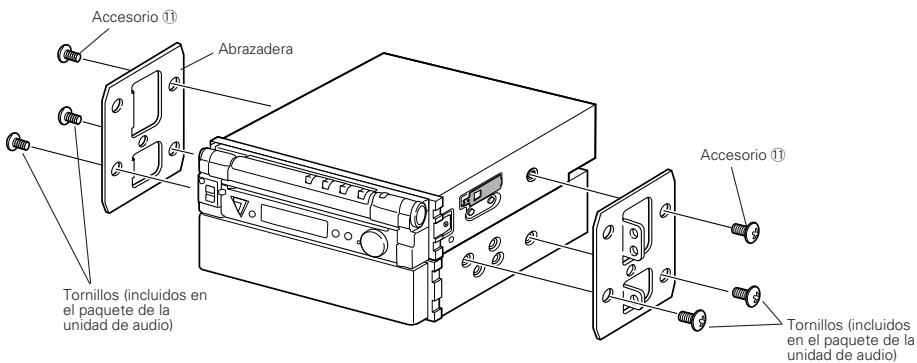

3. Doble cada uno de los extremos del accesorio 10 para fijar la abrazadera.

Utilice un destornillador plano o unos alicates y doble cada una de las pestañas del accesorio en el orificio de la abrazadera de instalación para fijar la abrazadera.

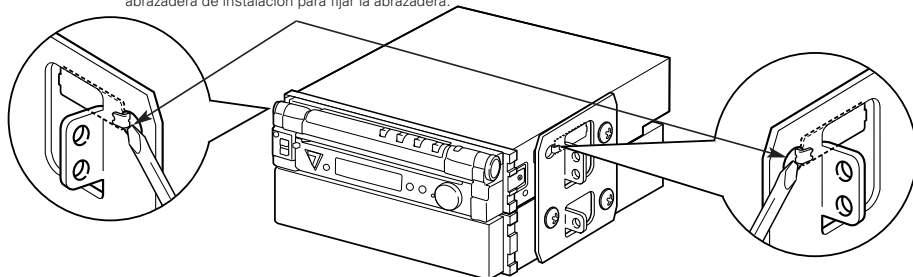

Desinstalación de monitor/reproductor

■ Extracción del Marco (escudete)

1. Enganche la uña de la herramienta de extracción ⑥ y libere los cierres provistos en dos lugares de la parte inferior. Tal como se muestra en la figura, baje el marco y extráigalo hacia adelante.

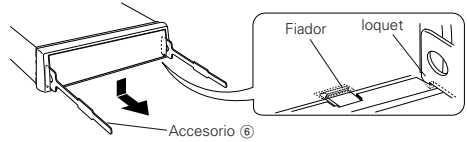

2. Después de extraer la parte inferior, libere de la misma manera los dos lugares del lado superior.



El marco podrá desmontarse también de la misma manera desde el lado superior.

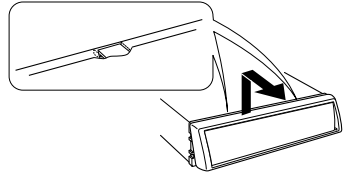

Desmontaje de la unidad

1. Refiérase a la sección <Extracción del Marco> y retírelo.
2. Quite el tornillo (M4 x 6) del panel posterior.
3. Inserte profundamente las dos herramientas de extracción ⑥ en las ranuras de cada lado, tal como se muestra en la figura.

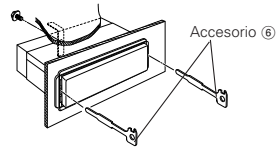

4. Mueva la herramienta de extracción hacia abajo, y extraiga la unidad hasta la mitad mientras presiona hacia adentro.



Preste atención para no lastimarse con las uñas de la herramienta de extracción.

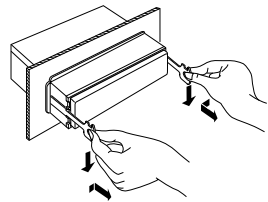



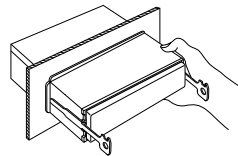





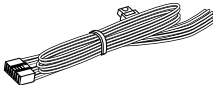

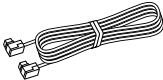

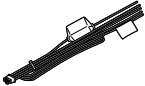
5. Termine de sacar la unidad con las manos, prestando atención para no dejarla caer.

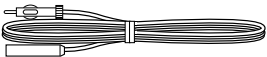

Antes da instalação

Acessórios

①	1	⑧	4
②	1	⑨	2
③	1	⑩	2
④	1	⑪	4
⑤	1	⑫	4
⑥	2			
⑦	4			

Procedimentos para Instalação

1. Para evitar um curto circuito, remova a chave da ignição e desligue o polo \ominus da bateria.
2. Faça as ligações apropriadas dos cabos de entrada e saída de cada aparelho.
3. Ligue os cabos de cablagem dos alto-falantes.
4. Ligue a cablagem pela ordem seguinte: massa, bateria, ignição.
5. Ligue o conector da cablagem à unidade.
6. Instale o aparelho no seu carro.
7. Torne a ligar o polo \ominus da bateria.
8. Pressione o botão de reajuste.

▲ADVERTÊNCIA

Se ligar o cabo de ignição (vermelho) e o cabo de bateria (amarelo) ao chassis do carro (massa), poderá causar um curto circuito, que por sua vez pode originar um fogo. Ligue sempre estes cabos à alimentação que passar pela caixa de fusíveis.

▲CUIDADO

- Se a ignição do seu carro não tiver uma posição ACC, ligue os fios de ignição a uma fonte de alimentação que possa ser ligada e desligada com a chave de ignição. Se ligar o fio de ignição a uma fonte de alimentação com um débito de tensão constante, como os cabos da bateria, a bateria poderá ficar descarregada.
- Se a consola tiver uma cobertura, assegure-se de que instala a unidade de forma a que o painel não toque na cobertura ao fechar e abrir.
- Se o fusível fundir, assegure-se primeiro que os fios não estão em contacto causando um curto circuito, e depois substitua o fusível velho por outro com a mesma capacidade.
- Isole os cabos não ligados com fita isolante ou outro material similar. Para evitar um curto circuito, não remova as tampas nas pontas dos fios desligados ou dos terminais.
- Ligue os fios dos altifalantes correctamente aos terminais correspondentes. A unidade poderá ser danificada ou deixar de funcionar se partilhar os fios \ominus ou os ligar à massa a qualquer peça metálica do carro.
- Quando estiverem apenas dois altifalantes ligados ao sistema, ligue os conectores quer a ambos os terminais de saída frontais ou ambos os terminais de saída traseiros (não misture os frontais com os traseiros). Por exemplo, se ligar o conector \oplus do altifalante esquerdo a um terminal de saída da frente, não ligue o conector \ominus a um terminal de saída de trás.
- Depois que o aparelho tiver sido instalado, verifique se as lâmpadas de stop, os pisca-piscas, os limpa pára-brisa, etc. do carro estão funcionando correctamente.
- Monte a unidade de forma a que o ângulo de montagem seja de 30° ou menos.

Conexões

⚠️ ADVERTÊNCIA

Se ligar o cabo de ignição (vermelho) e o cabo de bateria (amarelo) ao chassis do carro (massa), poderá causar um curto circuito, que por sua vez pode originar um fogo. Ligue sempre estes cabos à alimentação que passar pela caixa de fusíveis.

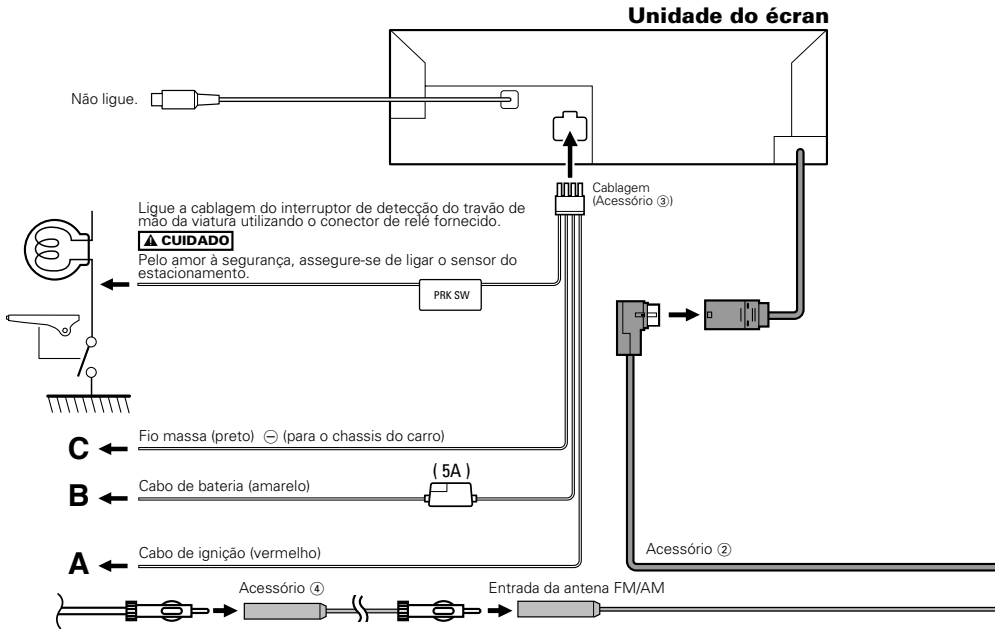

- C** ← Fio massa (preto) ⊖ (para o chassis do carro)
- B** ← Cabo de bateria (amarelo) (5A)
- A** ← Cabo de ignição (vermelho)

- B** ← Cabo de bateria (amarelo)
- ← Cabo de controle de escurecimento (laranja/branco)
- C** ← Fio massa (preto) ⊖ (para o chassis do carro)

Para o comutador de controle de luz do carro

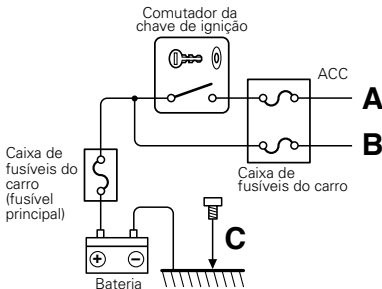

Dependendo do tipo de antena que estiver usando, ligue ou ao terminal de controle do motor da antena, ou ao terminal de energia para reforçar o amplificador da antena do tipo filme.

Ao usar o amplificador de potência opcional, ligue ao seu terminal de controle de energia.

Para o terminal "EXT-AMP.CONT." do amplificador que tenha a função de controle do amplificador externo.

Cabo de controle de motor antena (azul)

Cabo de controle de potência (azul/branco)

Cabo de controle do amplificador externo (cor rosa/preto)

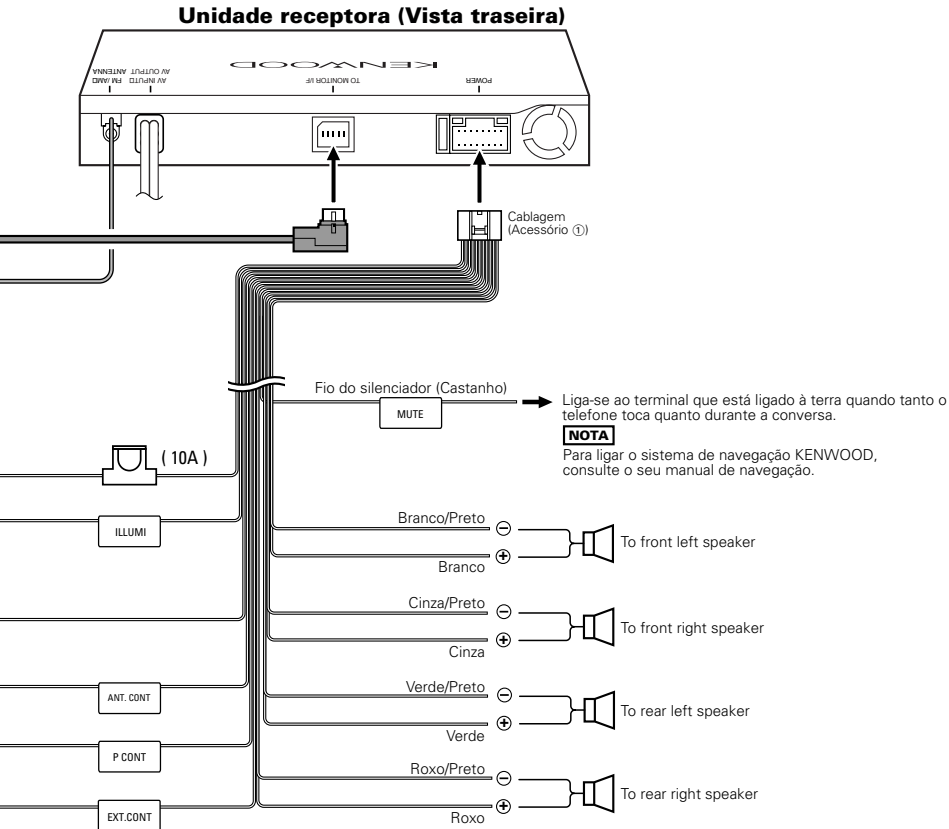
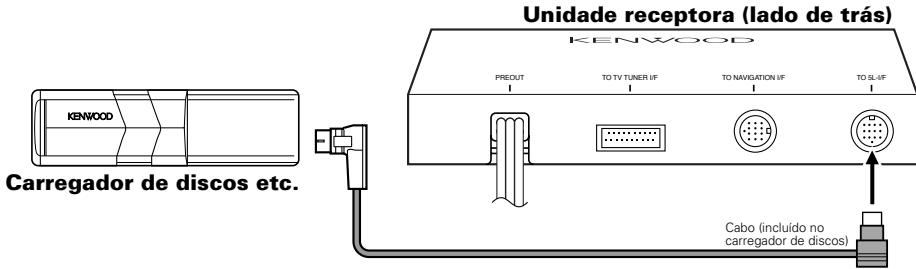

Ligação do sistema

Unidade receptora (lado de trás)

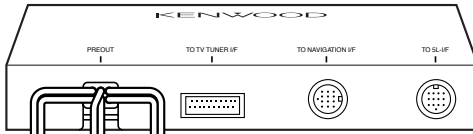

● Preout Dianteiro

Entrada audio esquerda (Branco)

Entrada audio direita (Vermelho)

● Preout Traseiro

Entrada audio esquerda (Branco)

Entrada audio direita (Vermelho)

● Sub-woofer (Mono) Preout

Entrada audio esquerda (Branco)

Entrada audio direita (Vermelho)

Unidade receptora (Vista traseira)

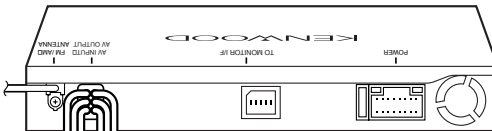

● Entrada Audio/Visual

Entrada visual (Amarelo)

Entrada audio esquerda (Branco)

Entrada audio direita (Vermelho)

● Entrada Audio/Visual

Entrada visual (Amarelo)

Entrada audio esquerda (Branco)

Entrada audio direita (Vermelho)

Instalação para Écran/Unidade de leitor

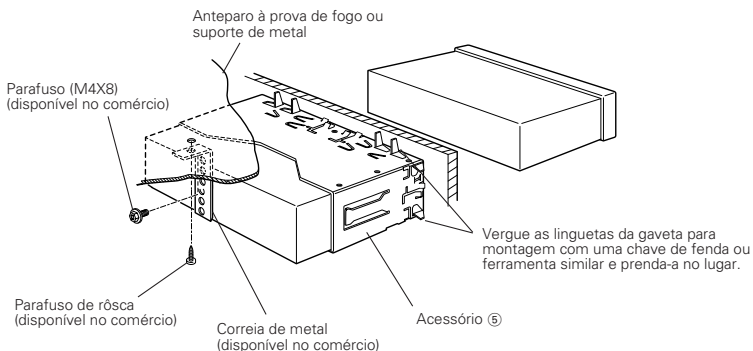

 Assegure-se de que a unidade fica instalada firmemente no seu lugar. Se a unidade estiver instável, poderá funcionar mal (p.ex., o som poderá saltar).

Instalação para Unidade Receptora

1. Una os suportes de instalação ⑨ aos lados da unidade de esconderijo usando os parafusos sems ⑦.

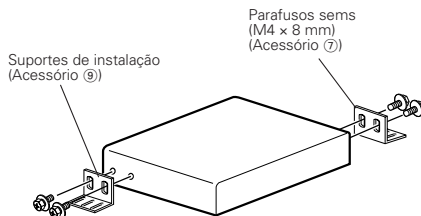

2. Use o parafuso auto-roscante ⑧ para firmar a unidade de ocultar à placa de áudio.

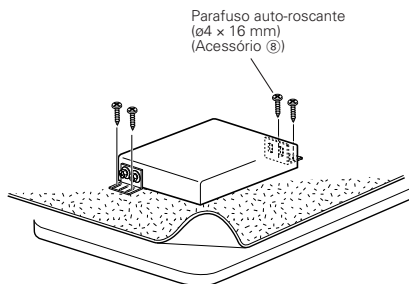

Instalação

Instalação em automóveis fabricados no Japão

- Instalação em automóveis Toyota, Nissan ou Mitsubishi utilizando grampos nos orifícios indicados por "●"

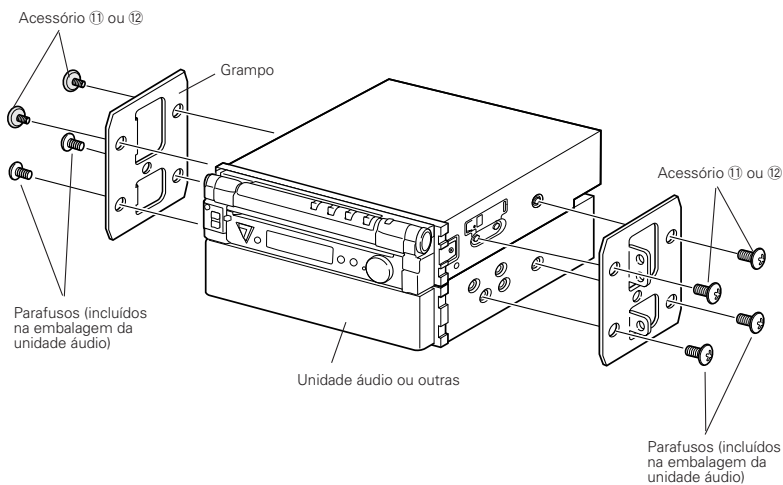
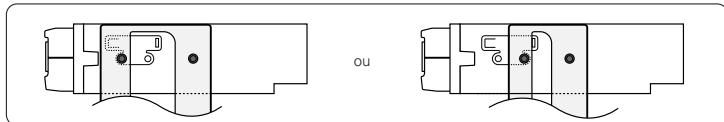

■ Instalação em automóveis Toyota utilizando grampos nos orifícios indicados por "●"

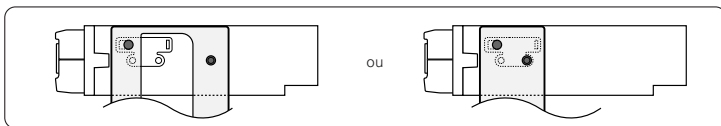

Quando usar o grampo apresentado acima, não pode usar parafusos nos dois orifícios dos lados direito e esquerdo da unidade. Nesse caso, aperte o grampo utilizando acessórios 10 como indicado a seguir.

1. Use acessórios 10 dos dois lados como indicado.

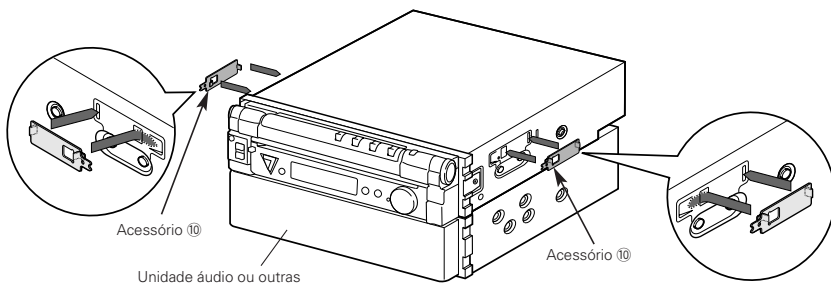

2. Monte o grampo de cada lado.

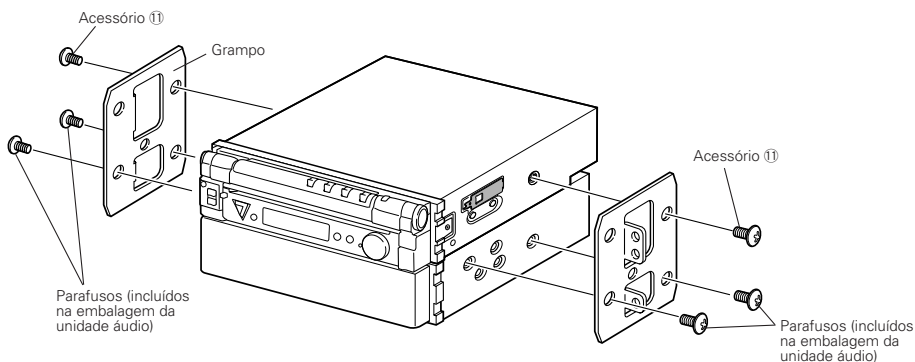

3. Dobre cada extremidade do acessório 10 para apresentar o grampo.

Use uma chave de fendas de lâmina plana ou alicate, e dobre cada patilha do acessório para o orifício do grampo de instalação para apresentar o grampo.

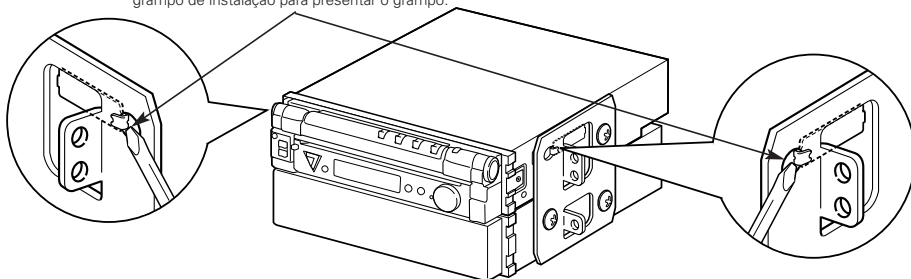

Remoção da unidade Écran/Leitor

■ Removendo a armação de borracha dura (protecção)

1. Prenda os pinos da alhete na ferramenta de remoção ⑥ e retire as duas trancas de baixo. Baixe a armação e puxe-a para frente como na ilustração.

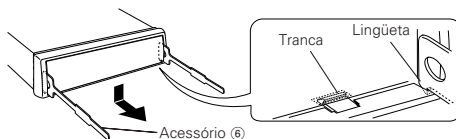

2. A armação pode ser removida pelo lado de cima da mesma maneira.



A armação pode ser removida pelo lado de cima da mesma maneira.

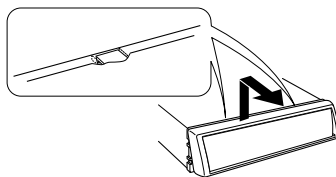

Retirando o aparelho

1. Leia primeiro a secção <Removendo a armação de borracha dura> antes de remover a armação de borracha dura.
2. Desaparafuse os parafusos de cabeça sextavada com anilha (M4 x 6) na parte de trás do aparelho.
3. Coloque as duas ferramentas de remoção ⑥ profundamente nas aberturas de cada lado, como mostra a figura.
4. Abaixa a ferramenta de remoção para baixo e puxe o aparelho para fora até a metade, ao mesmo tempo em que o pressiona em direção à parte de dentro.

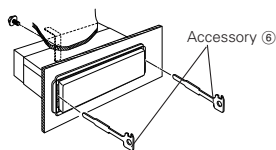

Tome cuidado para não se ferir com a ferramenta de remoção.

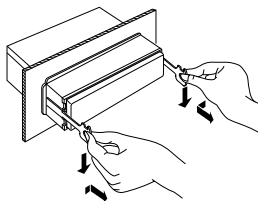

5. Puxe o aparelho completamente para a fora com as mãos, tendo o cuidado para não deixá-lo cair.

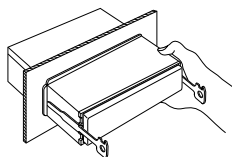

Free Manuals Download Website

<http://myh66.com>

<http://usermanuals.us>

<http://www.somanuals.com>

<http://www.4manuals.cc>

<http://www.manual-lib.com>

<http://www.404manual.com>

<http://www.luxmanual.com>

<http://aubethermostatmanual.com>

Golf course search by state

<http://golfingnear.com>

Email search by domain

<http://emailbydomain.com>

Auto manuals search

<http://auto.somanuals.com>

TV manuals search

<http://tv.somanuals.com>