

KENWOOD

TK-D740
TK-D740H
TK-D740HV
TK-D840
TK-D840H
TK-D840HU

VHF DIGITAL TRANSCEIVER
UHF DIGITAL TRANSCEIVER

USER MANUAL



JVCKENWOOD Corporation

B5A-0925-00/01

CONTENTS

PREPARATION	4
Connecting the power cable.....	4
Installing the Transceiver.....	4
ORIENTATION	6
FRONT AND REAR VIEWS	6
DISPLAY.....	8
PROGRAMMABLE FUNCTIONS	11
BASIC OPERATION	15
SWITCHING POWER ON/ OFF	15
Transceiver Password	15
ADJUSTING THE VOLUME	15
SELECTING A ZONE AND CHANNEL	15
TRANSMITTING.....	15
RECEIVING.....	16
Receiving Group Calls	16
Receiving Individual Calls.....	16
FleetSync: ALPHANUMERIC 2-WAY PAGING FUNCTION	17
SELCALL (SELECTIVE CALLING)	17
Transmitting.....	17
Receiving	17
Identification Codes	17
PAGING CALL	17
SCAN	18
PRIORITY SCAN.....	18
TEMPORARY CHANNEL LOCKOUT.....	18
SCAN DELETE/ ADD	18
DTMF CALLS	19
MANUAL DIALING	19
AUTODIAL.....	19
REDIALING	19

ADVANCED OPERATIONS..... 20

- EMERGENCY CALLS 20
 - Lone Worker Mode..... 20
- SCRAMBLER 21
- MONITOR/ SQUELCH OFF 21
 - Squelch Level..... 22
- PUBLIC ADDRESS (PA) 22
- HORN ALERT 22
- GPS REPORT 22

DMR..... 23

- INDIVIDUAL/GROUP CALLS 23
 - Receiving 23

BACKGROUND OPERATIONS..... 24

- TIME-OUT TIMER (TOT)..... 24
- AUXILIARY PORT 24
- DISPLAY BRIGHTNESS 24
- BUSY CHANNEL LOCKOUT (BCL) 24
- PTT ID 25
- SIGNALING 25
- COMPANDER..... 25
- VOICE ANNUNCIATION..... 25

PREPARATION



WARNING

Various electronic equipment in your vehicle may malfunction if they are not properly protected from the radio frequency energy which is present while transmitting. Typical examples include electronic fuel injection, anti-skid braking, and cruise control. If your vehicle contains such equipment, consult the dealer for the make of vehicle and enlist his/her aid in determining if they will perform normally while transmitting.

Connecting the power cable



CAUTION

The transceiver operates in 12 V negative ground systems only! Check the battery polarity and voltage of the vehicle before installing the transceiver.

- 1 Check for an existing hole, conveniently located in the firewall, where the power cable can be passed through.
 - If no hole exists, use a circle cutter to drill a hole, then install a rubber grommet.
- 2 Run the power cable through the firewall and into the engine compartment.
- 3 Connect the red lead to the positive (+) battery terminal and the black lead to the negative (-) battery terminal.
 - Place the fuse as close to the battery as possible.
- 4 Coil the surplus cable and secure it with a retaining band.
 - Be sure to leave enough slack in the cables so the transceiver can be removed for servicing while keeping the power applied.

Installing the Transceiver



WARNING

For passenger safety, install the transceiver securely using the supplied mounting bracket and screw set so the transceiver will not break loose in the event of a collision.

Note:

- ◆ Before installing the transceiver, check how far the mounting screws will extend below the surface. When drilling mounting holes, be careful not to damage vehicle wiring or parts.
-
- 1 Mark the position of the holes in the dash, using the mounting bracket as a template. Using a 4.2 mm (5/32 inch) drill bit, drill the holes, then attach the mounting bracket using the supplied screws.
 - Mount the transceiver within easy reach of the user and where there is sufficient space at the rear of the transceiver for cable connections.
 - 2 Connect the antenna and the supplied power cable to the transceiver.

- 3 Slide the transceiver into the mounting bracket and secure it using the supplied hex-headed screws.
- 4 Mount the microphone hanger in a location where it will be within easy reach of the user.
 - The microphone and microphone cable should be mounted in a place where they will not interfere with the safe operation of the vehicle.



CAUTION

When replacing the fuse in the DC power cable, be sure to replace it with a fuse of the same value. Never replace a fuse with one that is rated with a higher value.

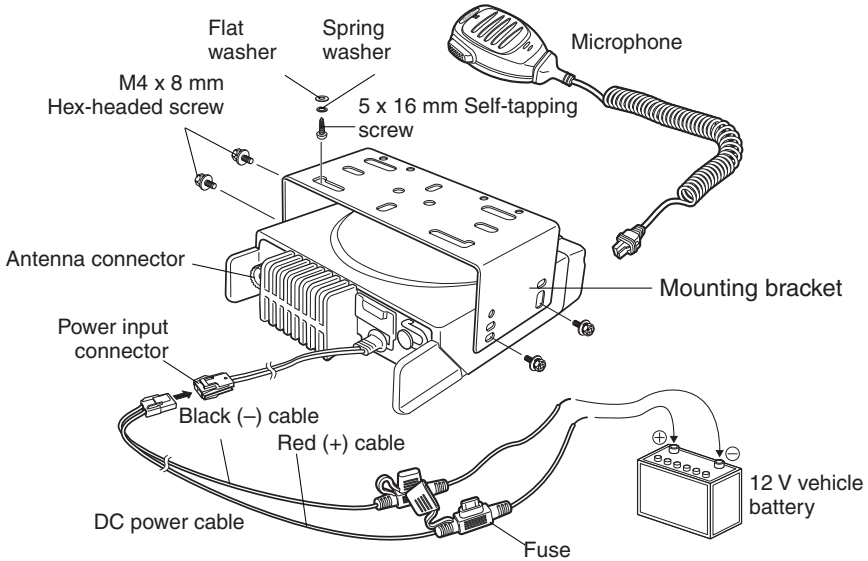

ORIENTATION

FRONT AND REAR VIEWS

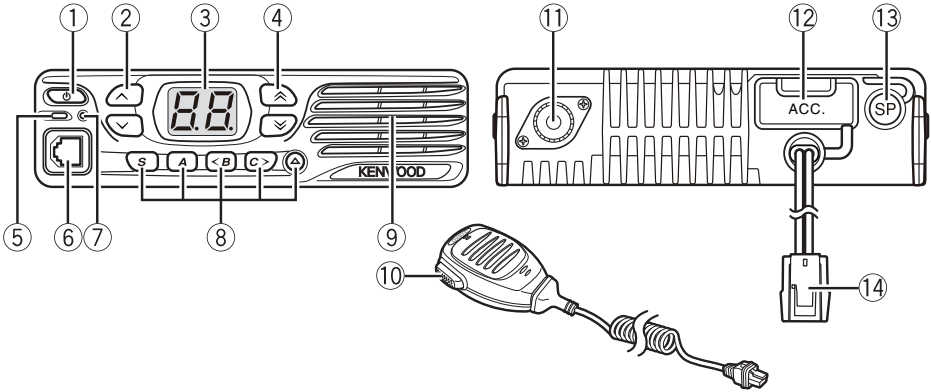

① **⏻ (Power) switch**

Press to switch the transceiver ON or OFF.

② **^ / v keys**

Press to activate their programmable functions.

③ **Display**

Refer to page 8.

④ **⤴ / ⤵ keys**

Press to activate their programmable functions.

⑤ **TX/RX Indicator**

Lights red while transmitting. Lights green while receiving a signal. Flashes orange when receiving an optional signaling call.

⑥ **Microphone jack**

Insert the microphone plug into this jack.

⑦ **Status Indicator**

Lights during a specified mode, based on dealer programming.

⑧ **S / A / <B / C> / Δ keys**

Press to activate their programmable functions.

⑨ **Speaker**

Internal speaker.

⑩ **PTT switch**

Press this switch, then speak into the microphone to call a station.

⑪ **Antenna connector**

Connect the antenna to this connector.

⑫ **ACC connector**

Connect the ACC to this connector, via the KCT-60.

⑬ **External speaker jack**

Connect an external speaker to this jack.

⑭ **Power input connector**

















Connect the DC Power Cable to this connector.

DISPLAY

The display shows the zone/ channel number and the left and right dots show various modes of operation.



Display	Description
	Zone Display (Zone 1)
	Channel Display (Channel 16)
	Appears during Scan. (Sc)
	Appears during the transceiver is stunned. (St)
	Appears when switch the transceiver ON. The Transceiver Password function is programmed. (PS)
	Appears when the Squelch Level setting is activated. (SL)
	Appears when the Talk Around function is activated. (TA)
	Appears when the Horn Alert function is activated. (HA)
	Appears when the Public Address function is activated. (PA)
	Appears when the AUX function is activated. (AU)
	Appears when a zone is added to the scan list. (GA)
	Appears when a zone is removed from the scan list. (Gd)
	Appears when a channel is added to the scan list. (cA)
	Appears when a channel is removed from the scan list. (cd)
	Appears when the Lone Worker function is activated. (Ln)

Display	Description
	Appears during Send Data. (dt)
	Appears during the channel is busy.
	The selected channel is the Priority channel 1. (P1)
	The selected channel is the Priority channel 2. (P2)
	The selected channels are the Priority channel 1 and 2. (PP)
	Appears when the Scrambler function is activated. (Sr)
	Appears when the Scrambler code mode is activated. (co)
	Appears when the Message is completed. (Ed)
	Appears when the Call Interrupt function is activated. (It)
	Appears when the External Speaker is selected. (SP)
	Appears when the Key Lock function is activated. (Lc)
	Emergency Status/ Lone Worker Status/ Man down Status/ Stationary Status/ Motion Status. (EG)
	Appears when the Autodial mode. (Ad)
	Appears when the Home channel. (Hc)
	Appears during the Broadcast group call. (bc)
	Appears when the Priority-channel select mode. (Pr)
	Appears when the OVCM function is activated. (oc)

The left and right dots on the display can be programmed to indicate specific

modes of operation, as listed below.

- AUX
- External Speaker
- Horn Alert
- Lone Worker
- Public Address
- Scan Delete/Add
- Scrambler
- Talk Around
- Priority Channel

The right dot will blink during special operations, as listed below.

- Scrambler Code
- Squelch Level
- Channel Entry

PROGRAMMABLE FUNCTIONS

The \wedge , \vee , $\hat{\wedge}$, $\hat{\vee}$, **S**, **A**, **<B**, **C>**, and \blacktriangle keys can be programmed with the functions listed below. Ask your dealer for details on these functions.

Note:

- ◆ The duration of pressing a key to activate a function is dependent on your dealer setting. Your dealer may have set some keys to be held down for a short duration instead of being momentarily pressed. Ask your dealer for details on which keys need to be held down to activate their functions.
-

■ None

No function has been programmed.

■ Autodial

Autodial allows you to make a private DTMF call to another party.

■ AUX

Activate the auxiliary port. The auxiliary port is used with optional boards.

■ Broadcast

Toggles the call type between Broadcast Call and Conference Call.

■ Call 1/ Call 2

Initiates a call on the selected channel.

■ Call Interruption

Interrupts a call, stopping it from being received.

■ Channel Down

Decreases the Channel number in steps of 1.

■ Channel Down (Continuous)

Hold down this key to continuously decrease the Channel number.

■ Channel Entry

Selects the channel number.

■ Channel Up

Increases the Channel number in steps of 1.

■ Channel Up (Continuous)

Hold down this key to continuously increase the Channel number.

■ Emergency

Places the transceiver into Emergency mode. Emergency mode is used to carry out emergency actions.

Note:

- ◆ This function can be programmed only on the ▲ key.
-

■ Home Channel

Press this key to immediately select your home channel.

■ Home Channel Select

Hold down this key to set the current channel as the Home Channel.

■ Fixed Volume

Cycles the various tone levels of the transceiver between low, high, and off.

■ External Speaker

Toggles Optional External Speaker ON and OFF.

■ Horn Alert

Enables the Horn Alert terminal when a call is received. It activates the car headlights and horn to alert you of the incoming call when you are away from the transceiver.

■ LED Brightness

Adjust the LED display brightness between High, Low, and Off.

■ Lone Worker

Toggles Lone Worker mode ON and OFF.

■ Monitor

Turns the transceiver signaling off, to listen to all calls that are received on the channel. Press this key again to turn the transceiver signaling back on.

■ Monitor Momentary

Turns the transceiver signaling off while holding down this key. Release this key to turn the transceiver signaling back on. While signaling is off, you can listen to all calls that are received on the channel.

■ OVCM

Toggles OVCM (Open Voice Channel Mode) between ON and OFF.

■ Paging Call

To transmit your PTT ID list, to request a call.

■ Priority-channel Select

Enters the Priority-channel Select mode.

■ Public Address

The PA system can only be used with an optional relay unit and external speaker.

■ Scan

Press this key to start scanning the transceiver channels.

■ Scan Delete/Add

Adds or removes the selected Channel to or from the scan sequence.

■ Scrambler

Toggles the Scrambler function ON and OFF. Hold this key to enter Scrambler Code mode, to change the Privacy List number. Hold the key again exit Scrambler Code mode. Additionally, the Privacy List becomes the Scrambler List.

Note:

- ◆ This function cannot be used in certain countries. Contact your KENWOOD dealer for further information.
-

■ Send the GPS data

Manually sends your GPS data to the base station.

■ Squelch Level

Adjusts the transceiver squelch level.

■ Squelch Off

Press to hear background noise. Press this key again to return to normal operation.

■ Squelch Off Momentary

Hold down this key to hear background noise. Release this key to return to normal operation.

■ Talk Around

Toggle Talk Around function ON and OFF. Talk Around function allows you to communicate directly with other transceivers, without the use of a repeater.

■ Volume Down

Decreases the Volume level in steps of 1.

■ Volume Down (Continuous)

Hold down this key to continuously decrease the Volume level.

■ Volume Up

Increases the Volume level in steps of 1.

■ Volume Up (Continuous)

Hold down this key to continuously increase the Volume level.

■ **Zone Delete/Add**

Toggles the Zone status between deleted and added.

■ **Zone Down**

Decreases the zone number in steps of 1.

■ **Zone Down (Continuous)**

Hold down this key to continuously decrease the Zone number.

■ **Zone Up**

Increases the zone number in steps of 1.

■ **Zone Up (Continuous)**

Hold down this key to continuously increase the Zone number.

BASIC OPERATION

SWITCHING POWER ON/ OFF

Press [⏻] to switch the transceiver ON.

Press [⏻] again to switch the transceiver OFF.

Transceiver Password

If the Transceiver Password function is programmed, “PS” will appear on the display when the power is turned ON.

To enter the password:

- 1 Press \wedge / \vee to select a digit.
 - When using an optional microphone with a keypad, simply enter the password digits and proceed to step 3.
- 2 Press **S** or \times to accept the entered digit and move to the next digit.
 - Press **A** or **#** to delete an incorrect digit. Press and hold **A** or **#** to delete all digits.
 - Repeat steps 1 and 2 to enter the entire password.
- 3 Press **S** or \times to confirm the password.
 - If you enter an incorrect password, the transceiver remains locked.

ADJUSTING THE VOLUME

Press the key programmed as [**Volume Up**] to increase the volume. Press the key programmed as [**Volume Down**] to decrease the volume.

SELECTING A ZONE AND CHANNEL

Select the desired zone and channel using the keys programmed as [**Zone Up**]/ [**Zone Down**] and [**Channel Up**]/ [**Channel Down**].

- “G1” (Zone 1)/ “16” (Channel 16) appears on the display.

TRANSMITTING

- 1 Select the desired zone and channel.
- 2 Press the key programmed as [**Monitor**] or [**Squelch Off**] to check whether or not the channel is free.
 - If the channel is busy, wait until it becomes free.
- 3 Press the **PTT** switch and speak into the microphone. Release the **PTT** switch to receive.
 - For best sound quality at the receiving station, hold the microphone approximately 1.5 inches (3 cm to 4 cm) from your mouth.

RECEIVING

Select the desired zone and channel. If signaling has been programmed on the selected channel, you will hear a call only if the received signal matches your transceiver settings.

Receiving Group Calls

When you receive a group call and the received group ID matches the ID set up on your transceiver, you can hear the caller's voice.

Receiving Individual Calls

When you receive an individual call, a ringing tone will sound. To respond to the call, press and hold the **PTT** switch and speak into the transceiver as you would during a normal transmission.

FleetSync: ALPHANUMERIC 2-WAY PAGING FUNCTION

FleetSync is an Alphanumeric 2-way Paging Function and is a protocol owned by JVC KENWOOD Corporation.

SELCALL (SELECTIVE CALLING)

A Selcall is a voice call to a particular station or to a group of stations.

Transmitting

- 1 Select your desired zone and channel.
- 2 Press the **PTT** switch to transmit your PTT ID list and begin your conversation.

Receiving

If enabled by your dealer, an alert tone will sound and the LED will blink when a Selcall has been received.

To respond to the call, press the **PTT** switch and speak into the microphone.

Identification Codes

An ID code is a combination of a 3-digit Fleet number and a 4-digit ID number. Each transceiver must have its own Fleet and ID number.

Note:

- ◆ The ID range may be limited by programming.
-

PAGING CALL

- 1 Select your desired zone and channel.
- 2 Press the key programmed as [**Paging Call**] to transmit your PTT ID list, to request a call.

SCAN

Scan monitors for signals on the transceiver channels. While scanning, the transceiver checks for a signal on each channel and only stops if a matching signal is present.

To start/ stop scanning, press the key programmed as **[Scan]**.

- “Sc” appears on the display during Scan.
- When a signal is detected, Scan pauses at that channel. The transceiver will remain on the busy channel until the signal is no longer present, at which time Scan resumes.

Note:

- ◆ To use Scan, there must be at least 2 channels added to the scanning sequence.
-

PRIORITY SCAN

If a Priority channel has been programmed, the transceiver will automatically change to the Priority channel when a call is received on that channel, even if call is being received on a normal channel.

- “P1” appears on the display to indicate the Priority channel 1.
- “P2” appears on the display to indicate the Priority channel 2.
- “PP” appears on the display to indicate the Priority channels 1 and 2.

TEMPORARY CHANNEL LOCKOUT

During scan, you can temporarily remove specific channels from the scanning sequence by pressing the key programmed as **[Scan Delete/Add]** while Scan is paused at the undesired channel.

- The channel is no longer scanned. However, when scanning is ended and restarted, the Scan settings return to normal.

SCAN DELETE/ ADD

You can add and remove zones and/or channels to and from your scan list.

- 1 Select your desired zone and/or channel.
- 2 Press the key programmed as **[Zone Delete/Add]** (to add/remove zones) or **[Scan Delete/Add]** (to add/remove channels).
 - When a zone is added to scan, “GA” appears on the display. When it is removed, “Gd” appears on the display.
 - When a channel is added to scan, “cA” appears on the display. When it is removed, “cd” appears on the display.

DTMF CALLS

Note:

- ◆ For keypad operation, you must use an optional microphone with a keypad.
-

MANUAL DIALING

- 1 Press and hold the **PTT** switch.
- 2 Enter the desired digits using the keypad.
 - If Keypad Auto-PTT is enabled by your dealer, you do not need to press the **PTT** switch to transmit; you can make the call simply by pressing the keys.

AUTODIAL

Autodial allows you to quickly call DTMF numbers that have been programmed onto your transceiver.

- 1 Press the key programmed as [**Autodial**].
 - “Ad” appears on the display.
- 2 Press the \wedge / \vee key to select your desired Autodial list number, or enter the list number directly (1 ~ 9)
 - “A1” (Autodial list 1) appears on the display.
- 3 Press the **PTT** switch to make the call.

REDIALING

- 1 Press the key programmed as [**Autodial**].
 - “Ad” appears on the display.
 - 2 Press the **0** key.
 - “rd” appears on the display.
 - If there is no data in the redial memory, an error tone will sound.
 - 3 Press the **PTT** switch to make the call.
-

Note:

- ◆ Switching the transceiver power OFF clears the redial memory.
-

ADVANCED OPERATIONS

EMERGENCY CALLS

If your transceiver has been programmed with the Emergency function, you can make emergency calls.

- 1 Press and hold the key programmed as **[Emergency]**.
 - Ask your dealer for the length of time necessary to hold this key before the transceiver enters Emergency mode.
 - When the transceiver enters Emergency mode, it will change to the Emergency channel and begin transmitting based on how it is set up by your dealer.
- 2 To exit Emergency mode, press the **[Emergency]** key again.
 - If the Emergency mode completes a preset number of cycles, Emergency mode will automatically end and the transceiver will return to the zone and channel that was in use before Emergency mode was entered.

Note:

- ◆ Your dealer can set the transceiver to emit a tone when transmitting in Emergency mode.
 - ◆ Your dealer can set the transceiver to emit tones and received signals as normal, or mute the speaker during Emergency operation.
-

Lone Worker Mode

Lone Worker Mode is a safety feature built into the transceiver. If the transceiver is not operated for a pre-programmed period of time, the transceiver will emit a tone and automatically enter Emergency operation.

Press the key programmed as **[Lone Worker]** to toggle the Lone Worker function ON or OFF.

- “Ln” appears on the display for 1 second.

SCRAMBLER

The Scrambler function allows you to hold a conversation in complete privacy. When activated, any other party listening in on your channel will be unable to understand your conversation. Press this key to toggle the Scrambler function ON or OFF.

Press the key programmed as [**Scrambler**] to toggle the Scrambler function ON or OFF.

- “Sr” appears on the display for 1 second.

You can change the scrambler codes:

- 1 Press and hold the key programmed as [**Scrambler key**].
 - “co” (code) appears on the display, followed by the current scrambler code.
- 2 Press \wedge / \vee to select your desired scrambler code.
- 3 Press **S**, **A**, **C>**, or \blacktriangle to store the new setting.
 - After changing your scrambler code, be sure to inform all of your group members of the new code so they can also reset their transceivers. The scrambler function will not work with transceivers set up with different scramble codes.

MONITOR/ SQUELCH OFF

You can use the key programmed as [**Monitor**] or [**Squelch Off**] to listen to weak signals that you cannot hear during normal operation and to adjust the volume when no signals are present on your selected channel.

Your dealer can program a key with one of 4 functions:

- **Monitor:**
Press to deactivate QT, DQT, FleetSync Signaling, or DMR. Press again to return to normal operation.
- **Monitor Momentary:**
Press and hold to deactivate QT, DQT, FleetSync Signaling or DMR. Release to return to normal operation.
- **Squelch Off:**
Press to hear background noise. Press again to return to normal operation.
- **Squelch Off Momentary:**
Press and hold to hear background noise. Release to return to normal operation.

Squelch Level

If a key has been programmed as **[Squelch Level]**, you can readjust your transceiver's squelch level:

- 1 Press the key programmed as **[Squelch Level]**.
 - “SL” appears on the display, followed by the current squelch level.
- 2 Press \wedge / \vee to select the desired squelch level from 0 to 9.
- 3 Press **S**, **A**, **C>**, or \blacktriangle to store the new setting.

PUBLIC ADDRESS (PA)

The PA system can only be used with an optional relay unit and external speaker.

- 1 Press the key programmed as **[Public Address]** to activate the Public Address function.
 - “PA” appears on the display for 1 second.
- 2 Press and hold the **PTT** switch, then speak into the microphone to make your address through the external speaker.
- 3 Press the **[Public Address]** key again to exit Public Address.

HORN ALERT

The Horn Alert function can only be used with an optional relay unit.

Press the key programmed as **[Horn Alert]** to toggle the Horn Alert function ON or OFF.

- “HA” appears on the display for 1 second.

GPS REPORT

If a GPS unit (NMEA-0183 format) is installed on your transceiver, you can press the key programmed as **[Send the GPS data]** to send your location data.

DMR

DMR is a generic name for a digital communication system protocol utilizing 4-level FSK.

In a DMR Conventional system, communications are realized by sending and receiving digital signals on a DMR digital channel. Using a DMR ID (Unit ID or Group ID) allows the various communications

INDIVIDUAL/GROUP CALLS

Each channel is set up with an individual or group ID list number. To make a call, select the channel with the ID list number you wish to call, then press the **PTT** switch to start the call.

- Your dealer may also have set Selcall on PTT for Individual or Group calls, allowing you to make an Individual or Group call when pressing the **PTT** switch.
- To page the target transceiver instead of initiating a voice call, press the key programmed as [**Paging Call**].
- If PTT Proceed tone is enabled, the Proceed tone will sound. After the tone ends, you can begin the call.

Receiving

When you receive an individual call, a ringing tone will sound. Respond to the call by pressing the **PTT** switch.

- If the auto reset timer expires before you respond to the call, the call will end. Your dealer can set the duration for the auto reset timer (default is 10 seconds).

When you receive a group call and the received group ID matches the ID set up on your transceiver, a ringing tone will sound and you can hear the caller's voice.

BACKGROUND OPERATIONS

TIME-OUT TIMER (TOT)

The Time-out Timer is used to prevent you from using a channel for an extended duration. If you continuously transmit for a preset time, the transceiver will stop transmitting and a warning tone will sound. Release the **PTT** switch to stop the tone.

AUXILIARY PORT

Press the key programmed as [**AUX**] to activate the auxiliary port. The auxiliary port is used with optional boards.

- “AU” appears on the display for 1 second.

DISPLAY BRIGHTNESS

You can cycle the display brightness between high, low, and off by pressing the key programmed as [**LED Brightness**].

BUSY CHANNEL LOCKOUT (BCL)

When activated, BCL prevents you from interfering on a channel that is already in use. Pressing the **PTT** switch will cause a warning tone to sound and the transceiver will not transmit. Release the **PTT** switch to stop the tone.

Note:

- ◆ Ask your dealer for an explanation on how BCL functions when using QT, DQT, or Optional signaling.

If BCL Override has been programmed, you can transmit over the current signal:

- 1 Press and hold the **PTT** switch.
 - If the channel is already in use, a warning tone will sound.
- 2 Quickly release and then press the **PTT** switch again.
- 3 Speak into the transceiver as you would during a normal call.

PTT ID

PTT ID is the transceiver unique ID code which is sent each time the **PTT** switch is pressed and/or released.

Note:

- ◆ PTT ID can be made only in analog operation.
-

SIGNALING

QT/ DQT

The Encoder/Decoder function uses QT/ DQT to segregate talk groups, so users only hear calls from their own group.

DTMF

A DTMF PTT ID is included for dispatch operations or simple remote control applications. The DTMF decode capabilities include Selective Call ID, Transpond with ID, and “Wild Card” Group Calling.

2-Tone

2-tone Signaling opens the squelch only when your transceiver receives a call containing matching 2 tones.

5-Tone

5-tone Signaling opens the squelch only when the transceiver receives the 5 tones programmed in your transceiver. Transceivers that do not transmit the correct tones will not be heard.

COMPANDER

If programmed by your dealer for a channel, the compander will remove excessive noise from transmitted signals, to provide higher clarity of signals.

Note:

- ◆ The compander is used only in analog operation.
-

VOICE ANNUNCIATION

If enabled by your dealer, when changing the zone and channel, an audio voice will announce the new zone and channel number.

KENWOOD

© 2016 JVCKENWOOD Corporation

Free Manuals Download Website

<http://myh66.com>

<http://usermanuals.us>

<http://www.somanuals.com>

<http://www.4manuals.cc>

<http://www.manual-lib.com>

<http://www.404manual.com>

<http://www.luxmanual.com>

<http://aubethermostatmanual.com>

Golf course search by state

<http://golfingnear.com>

Email search by domain

<http://emailbydomain.com>

Auto manuals search

<http://auto.somanuals.com>

TV manuals search

<http://tv.somanuals.com>