

5KCF0103



KitchenAid

TABLE OF CONTENTS

COOK PROCESSOR SAFETY	
Important safeguards.....	4
Electrical requirements	6
Electrical equipment waste disposal.....	6
PARTS AND FEATURES	
Parts and features	7
Control panel	8
Accessories.....	8
COOKING MODES GUIDE	10
Automatic cooking modes.....	10
ADDITIONAL FUNCTIONS	
Timer option	12
Quick Stir.....	13
Pulse	13
MiniBowl and Mini MultiBlade.....	13
GETTING STARTED	
Preparing the Cook Processor for use.....	14
Using the Cook Processor.....	14
START UP AND CONTROL SETUP	
Welcome screen.....	15
Display language	15
Changing between degrees Fahrenheit and Celsius	15
USING AUTOMATIC COOKING MODES	16
USING STEAMING BASKETS	
Using the round internal steamer basket	19
Using the upper and lower steamer baskets	20
USING MANUAL COOKING MODES	21
Cooking with manual settings.....	22
CARE AND CLEANING	
Cleaning your Cook Processor.....	24
Storing Accessories	25
TROUBLESHOOTING	26

For more information, visit our website at:
KitchenAid.com.au

Your safety and the safety of others are very important.

We have provided many important safety messages in this manual and on your appliance. Always read and obey all safety messages.



This is the safety alert symbol.

This symbol alerts you to potential hazards that can kill or hurt you and others.

All safety messages will follow the safety alert symbol and either the word "DANGER" or "WARNING." These words mean:

 **DANGER**

You can be killed or seriously injured if you don't immediately follow instructions.

 **WARNING**

You can be killed or seriously injured if you don't follow instructions.

All safety messages will tell you what the potential hazard is, tell you how to reduce the chance of injury, and tell you what can happen if the instructions are not followed.

IMPORTANT SAFEGUARDS

When using electrical appliances, basic safety precautions should always be followed to reduce the risk of fire, electric shock, and/or injury to persons including the following:

1. Read all instructions.
2. To protect against risk of electrical shock do not put appliance in water or other liquid.
3. Unplug the appliance from outlet when not in use, before putting on or taking off parts and before cleaning.
4. Avoid contacting moving parts. Keep hands, hair, clothing, as well as spatulas and other utensils away from beater during operation to reduce the risk of injury to persons and/or damage to the appliance.
5. Do not operate appliance with damaged cord or plug or after the appliance malfunctions, or is dropped or damaged in any manner. Return the appliance to the nearest Authorised Service Center for examination, repair or electrical or mechanical adjustment.
6. The use of attachments not recommended or sold by KitchenAid may cause fire, electrical shock or injury.
7. Do not use the appliance outdoors.
8. Do not let the cord hang over edge of table or counter.

COOK PROCESSOR SAFETY

9. Appliances can be used by persons with reduced physical, sensory or mental capabilities or lack of experience and knowledge if they have been given supervision or instruction concerning use of the appliance in a safe way and if they understand the hazards involved.
10. The temperature of accessible surfaces may be high when the appliance is operating.
11. The appliance is not intended to be operated by means of an external timer or separate remote-control system.
12. Do not immerse the drive assembly in water.
13. This appliance is intended for household use only.
14. To reduce the risk of injury, never place cutting blade or discs on base without first putting bowl properly in place.
15. Be certain cover is securely locked in place before operating appliance.
16. Do not attempt to defeat the cover interlock mechanism.
17. Be careful if hot liquid is poured into the Cook Processor as it can be ejected out of the appliance due to a sudden steaming.
18. Care shall be taken when handling the sharp cutting blades, emptying the bowl, and during cleaning.
19. This appliance shall not be used by children. Keep the appliance and its cord out of reach of children.
20. Children shall not play with the appliance.
21. If the bowl is overfilled, boiling water may be ejected.
22. The appliance is only to be used with the base provided.
23. CAUTION: Ensure that the appliance is switched off before removing it from its base.
24. The heating element surface is subject to residual heat after use.
25. The Cook Processor should be positioned in a stable situation with the handles positioned to avoid spillage of hot liquids.
26. Avoid spillage on the connector.
27. This appliance is intended to be used in household and similar applications such as:
 - staff kitchen areas in shops, offices, and other working environments
 - farm houses
 - by clients in hotels, motels, and other residential-type environments
 - bed and breakfast type environments.

SAVE THESE INSTRUCTIONS

COOK PROCESSOR SAFETY

Electrical requirements

Voltage: 220–240 VAC

Frequency: 50-60 Hz

Wattage: 1050 Watts

Motor: 450 Watts

NOTE: This product has a grounded (earthed) plug. To reduce the risk of electrical shock, this plug will fit in an outlet only one way. If the plug does not fit in the outlet, contact a qualified electrician. Do not modify the plug in any way.

Do not use an extension cord. If the power supply cord is too short, have a qualified electrician or technician install an outlet near the appliance.

Electrical equipment waste disposal

Disposal of packing material

The packing material is 100% recyclable and is marked with the recycle symbol . The various parts of the packing must therefore be disposed of responsibly and in full compliance with local authority regulations governing waste disposal.

Scrapping the product

- This appliance is marked in compliance with European Directive 2012/19/EU, Waste Electrical and Electronic Equipment (WEEE).
- By ensuring this product is disposed of correctly, you will help prevent potential negative consequences for the environment and human health, which could otherwise be caused by inappropriate waste handling of this product.

- The symbol  on the product or on the accompanying documentation indicates that it should not be treated as domestic waste but must be taken to an appropriate collection centre for the recycling of electrical and electronic equipment.

For more detailed information about treatment, recovery and recycling of this product, please contact your local city office, your household waste disposal service or the shop where you purchased the product.

PARTS AND FEATURES

Parts and features

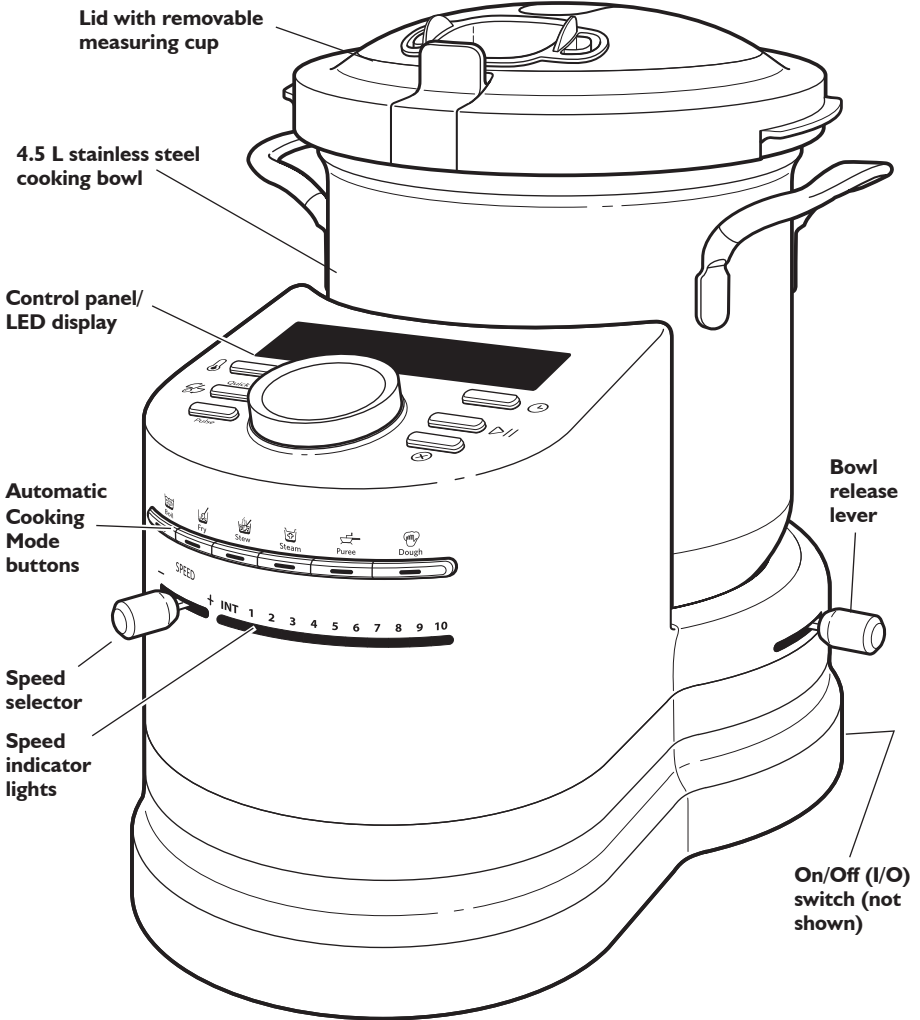

PARTS AND FEATURES

Control panel

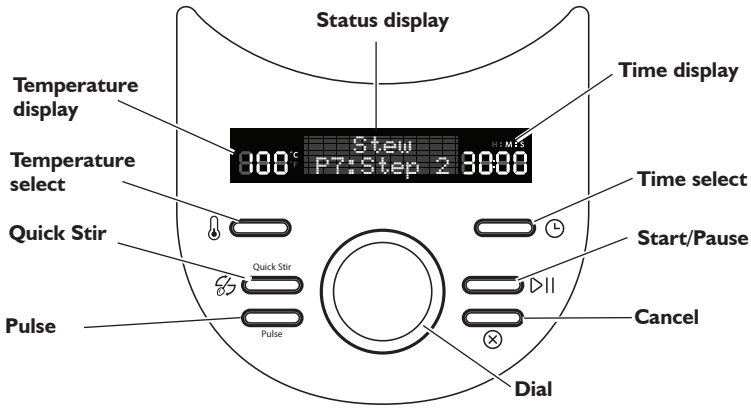

Accessories

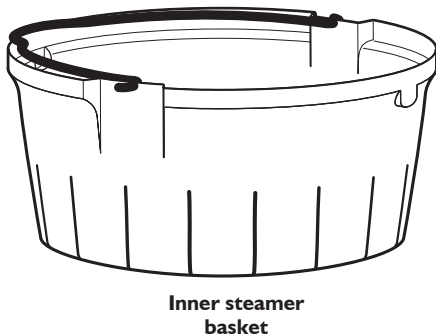
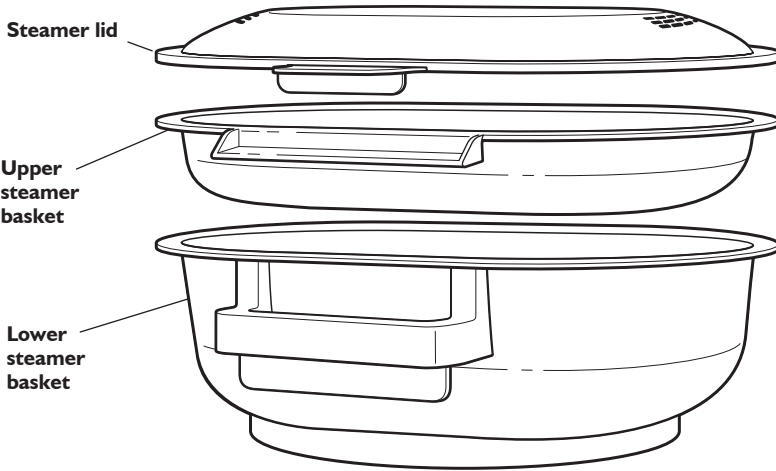

Steamer Capacity

Basket	Capacity (examples)
Upper	3-4 small fish
Lower	500 g chopped or sliced vegetables 3-4 large or 6-8 small potatoes
Inner	6-8 medium-sized shrimp

Food quantities for capacity are recommendations only.

PARTS AND FEATURES

Accessories

IMPORTANT: To avoid splashing, always follow recommended speeds when using the Egg Whip, Dough Blade, or MultiBlade.

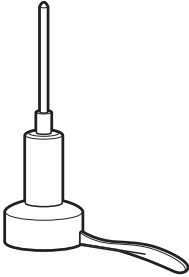

StirAssist

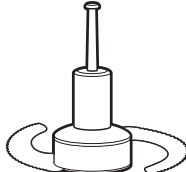

MultiBlade

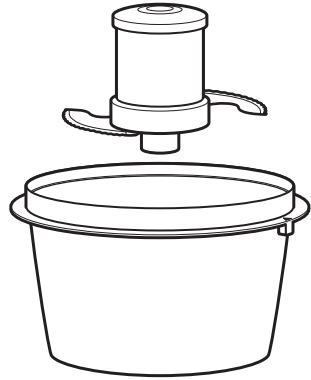

Mini Bowl and Mini MultiBlade

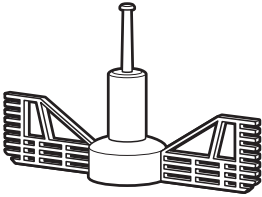

Egg Whip

(max. temperature = 100°C)*

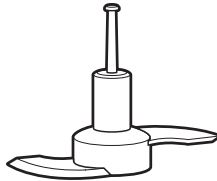

Dough Blade

(max. temperature = 40°C)*

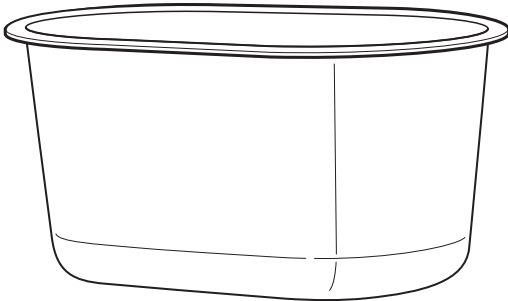

Storage case

* Do not exceed these temperatures unless specified in a recipe in the KitchenAid cookbook or app.

COOKING MODES GUIDE

Your Cook Processor features 6 automatic cooking modes, each with specialty modes, designed for a variety of cooking tasks.

The included recipe book features a selection of recipes optimized to work with these cooking modes.

Refer to the provided cookbook for directions on selecting attachments, cooking modes, and settings when using Automatic Cooking modes.

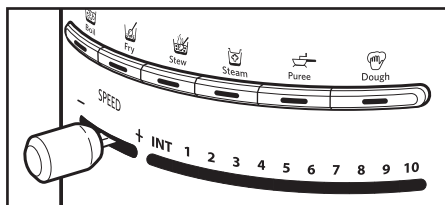

Reference quick guide below for Cooking Mode operations and tips.

You can also use it to cook in manual mode, to develop your own recipes, or create cold dishes such as Mayonnaise, Guacamole, Tapenades, Tartare, and Rouille.



Automatic cooking modes





Temperatures, times, and speeds for multistep Cooking Modes are indicated with an → to show the value for each step.

Cooking Mode	Temp (°C)	Time (minutes)	Speed	Recipes (see included recipe book for details)
 Boil (MultiBlade/StirAssist)				
Boil P1	120	20	2	Carrot-Ginger Soup, Zucchini Cappuccino, Jams/Jellies, Fruit Coulis
Boil P2	130→110	5→30	INT→2	Artichoke Soup, Clear Gyoza Bouillon, Tomato Soup, Pea Soup, Bisque, Onion Soup
Boil P3	130→100→100	5→8→13	2→2→2	Minestrone, Asparagus Soup
 Fry (MultiBlade/StirAssist)				
Fry P1	140	10	INT	Stir-Fried Asparagus, Gyros
Fry P2	130→130	10→3	2→2	Oriental Noodles with Scampis, Fried Rice with Tofu, Chop-Choy
Fry P3	130→120	2→1.3	1→2	Scrambled Eggs with Bacon

COOKING MODES GUIDE

Automatic cooking modes

Temperatures, times, and speeds for multistep cooking modes are indicated with an → to show the value for each step.

Cooking Mode	Temp (°C)	Time (minutes)	Speed	Recipes (see included recipe book for details)
 Stew (MultiBlade/StirAssist/Inner Steamer)				
Stew P1	100	7	2	Bavarois, Panna Cotta, Pesto
Stew P2	110	45	1	Couscous with Lamb, Chutney, Tajini Chicken, Coq au Vin, Chicken Tikka Masala, Chili con/sin Carne
Stew P3	120	10	2	Moroccan Meatballs, Pepper Cream Sauce, Tomato Sauce, Bouillabaisse, Curry Sauce
Stew P4	95	90	1	Rillettes, Beef Stew
Stew P5	120→100	10→25	2→2	Rice Pudding
Stew P6	100→100	60→10	1→1	Cassoulet, Irish Stew
Stew P7	130→100→100	5→30→12	1→1→1	Fish Stew, Bolognaise + Pasta
Stew P8	80→80	6→2	3→3	Béarnaise, Sabayon
Stew P9	120→100→ 110→100	2→3→ 3→15	2→2→ 2→2	Risotto
Stew P10	120	9	0	Vongole
Stew P11	120→100	10→15	2→2	Ratatouille, Chicken Green Curry
 Steam (MultiBlade/StirAssist/Steamers)				
Steam P1	130	10	0	Fish in Oriental Bouillon, Salmon in Papilotte, Dim Sum/Scampi
Steam P2	120	5	2	Mussels in White Wine, Steamed Vegetables
 Puree (MultiBlade/StirAssist/Inner Steamer)				
Puree P1	120	5	2	Hummus
Puree P2	120	25	2	Salt Cod Brandade (Puree), Potato-Savoy
Puree P3	80→110→130	20→5→10	2→1→2	Cheese and Shrimp Croquettes
Puree P4	120	10	2	Baby Food
Puree P5	120	15	0	Broccoli Mousse
 Dough (Dough Blade)				
Dough P1	40→0→40	2→2→30	2→2→0	Pizza Dough, Raisin Bread, Spelt Bread, White Bread, Whole Grain Bread

AUTOMATIC COOKING MODES

Boil



Select Boil to create delicious soups and bisques. It is also great for creating jams and jellies, stock, and other foods that need to cook at a boil for several minutes.

Fry



Use Fry modes to create delicious stir-fries, oriental-style dishes, and easy scrambled eggs and bacon.

Stew



Stew mode features a wide range of preprogrammed modes for creating everything from sauces to risotto. Whether you want Irish Stew, Béarnaise sauce, or Ratatouille, stew mode presets allow you to prepare everyday dishes quickly and easily.

Steam



Steam mode uses upper, lower, and inner steamer baskets to allow you to steam vegetables, fish, mussels, and more. This mode is excellent for delicate foods and cooking with indirect heat.

Puree



Puree combines the cooking and chopping abilities of the KitchenAid Cook Processor to make preparing hummus or shrimp croquettes a snap.

Dough





Knead and proof doughs easily and with minimum effort. Whether you are preparing homemade pizza crust or making bread, the KitchenAid Cook Processor makes it easy.

ADDITIONAL FUNCTIONS

Timer option

The timer can be used as a cooking timer, or as a kitchen timer. For use with cooking modes, see Manual Cooking section.

To use as a kitchen timer:

1. Press  (time). The time indicator will blink 00:00.
2. Turn the dial clockwise to increase the time, counterclockwise to decrease the time.
3. Press  (start) to begin the countdown. A tone will sound when the countdown reaches 00:00.

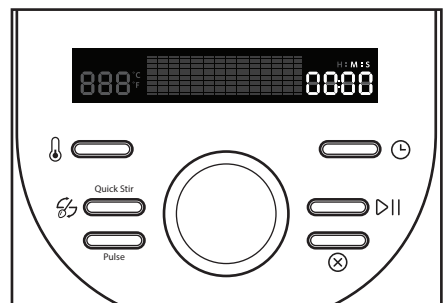

ADDITIONAL FUNCTIONS

Quick Stir

With the StirAssist paddle installed, press  (Quick Stir) once to stir for 2 seconds at low speed.

You may also press and hold the  (Quick Stir) button; the StirAssist paddle will operate at low speed until the button is released.

The timer will count up as long as the  (Quick Stir) button is held down.

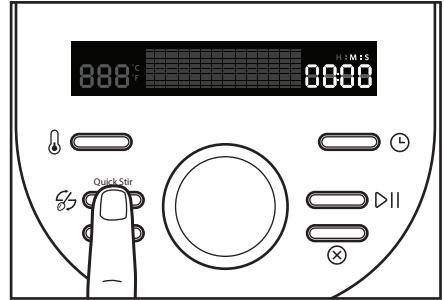

Pulse

Press Pulse to run the installed attachment at high speed. Release to stop.

NOTE: If the StirAssist paddle is installed, it will turn at low speed only.

The timer will count up as long as Pulse is held down.

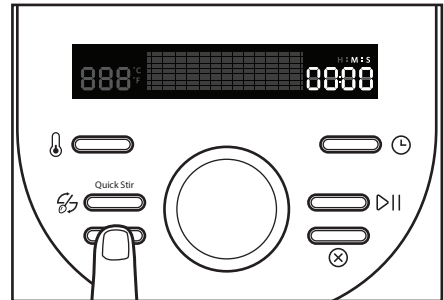

MiniBowl and Mini MultiBlade

Use the MiniBowl and Mini MultiBlade for processing smaller quantities.

1. Insert the MiniBowl into the Cook Processor Bowl, aligning the arrows on the MiniBowl with the arrows on the Cook Processor bowl.
2. Insert the Mini MultiBlade.
3. Add foods to be processed.
4. Close and latch lid.

Use the MiniBowl for food processing only. Do not use the MiniBowl with cooking cycles.

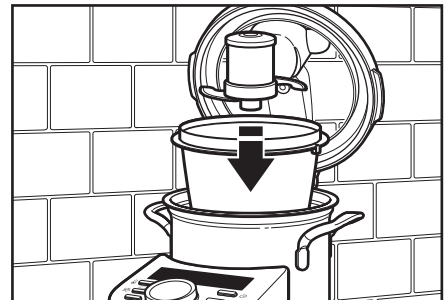

GETTING STARTED

Preparing the Cook Processor for use

1. Place the Cook Processor on a dry, flat, level surface such as a countertop or table.
2. Be sure to provide enough room above the Cook Processor to open lid and remove bowl.
3. Remove all packaging materials, if present.
4. Wash lid and attachments in hot, sudsy water and rinse thoroughly. Wipe out inside of bowl with a damp cloth. Do not immerse bowl. Dry thoroughly.

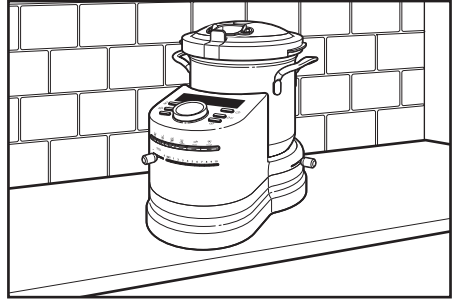

Using the Cook Processor

⚠ WARNING



Electric Shock Hazard

- Plug into a grounded outlet.**
- Do not use with an adaptor or T.**
- Do not use with an extension cord.**
- Failure to follow these instructions could result in death, fire, or electric shock.**

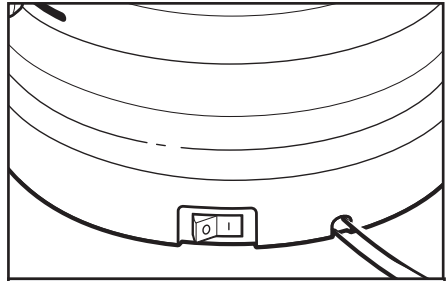

Plug into an earthed (grounded) outlet. The Cook Processor should be the only appliance operating on the circuit. The Cook Processor is now ready to use. Turn the main power switch to I (ON).

START UP AND CONTROL SETUP

Welcome screen

A welcome screen will be displayed any time the Cook Processor is first turned on after being plugged in, after the main power switch is turned on, or after a power outage.

Press any key on the control panel to continue.



Display language

You will be asked to select the display language the first time the Cook Processor is turned on:

1. Turn the dial until the desired language is displayed.
2. Press $\triangleright||$ (Start/Pause) to select and save.

To change the display language:

1. Press and hold $\triangleright||$ (Start/Pause) and \odot (Time) at the same time for 3 seconds.
2. The display will show the current language.
3. Turn the dial until the desired language is displayed.
4. Press $\triangleright||$ (Start/Pause) to select and save.



Changing between degrees Fahrenheit and Celsius

The default setting for the Cook Processor temperature is degrees Celsius.

To change between Celsius ($^{\circ}\text{C}$) and Fahrenheit ($^{\circ}\text{F}$):

1. Press and hold the \odot (Temperature) button for 3 seconds to switch between Celsius and Fahrenheit.

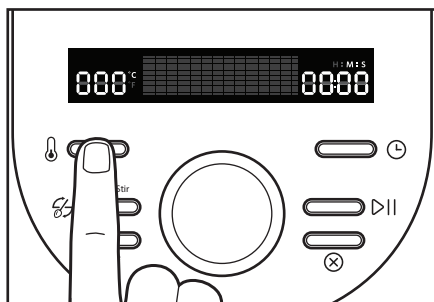

USING AUTOMATIC COOKING MODES

IMPORTANT: Refer to the provided cookbook for directions on selecting attachments, cooking modes, and settings when using Automatic Cooking modes.

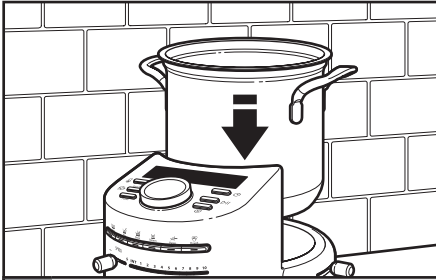

- 1** Place the bowl on the base, making sure it locks into place. If the bowl is not locked in place, UNLOCKED will show in the display.

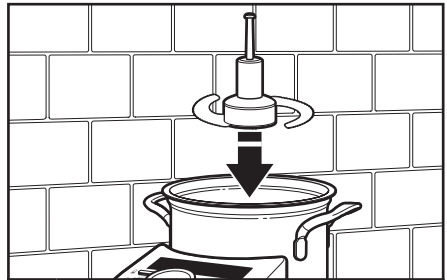

- 2** Insert the accessory indicated by the recipe into the bowl, sliding it onto the drive shaft.

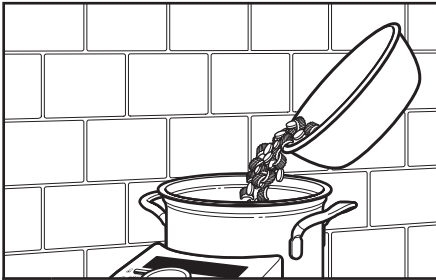

- 3** Add the ingredients for the first step of cooking. Do not exceed the MAX FILL line.



- 4** Close and latch the lid. Make sure the measuring cup is in place. If the lid is not properly installed, LID OPEN will show in the display if any mode except STEAM PI is selected.

USING AUTOMATIC COOKING MODES

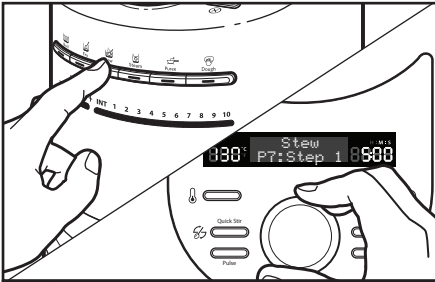

- 5** Select the desired preset cooking mode by pressing the mode button, then use the dial to select the mode version, for example, Stew P7. The default time and temperature will flash in the display.

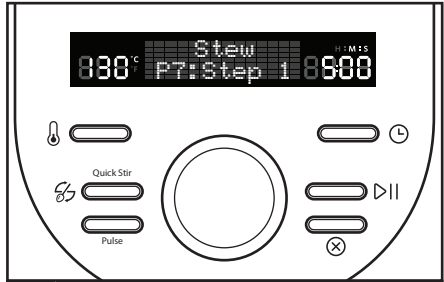

- 6** Press **▶▶** (Start). For cooking modes with multiple steps, the next cooking step will appear in the lower part of the display, and the default time and temperature will flash in the display. Use the dial to change the step, if desired.

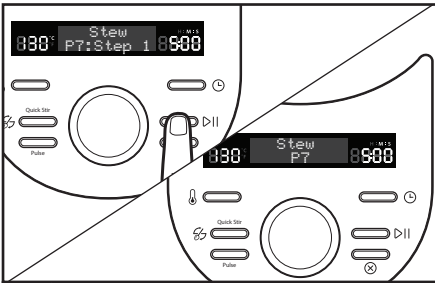

- 7** Press **▶▶** (Start) again. The temp and time will stop flashing. Once the set temperature is reached, the time will begin counting down.

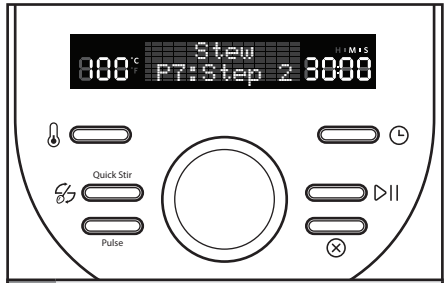

- 8** Once the first step is complete, a tone will sound and the settings for the next step will blink in the display.

USING AUTOMATIC COOKING MODES

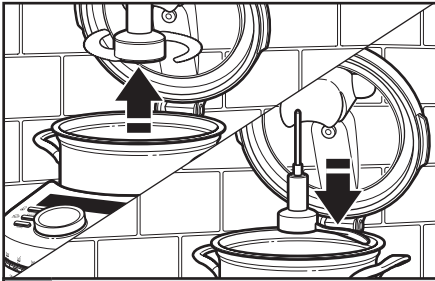

- 9** Change accessories, if necessary, and add any additional ingredients for the next step.

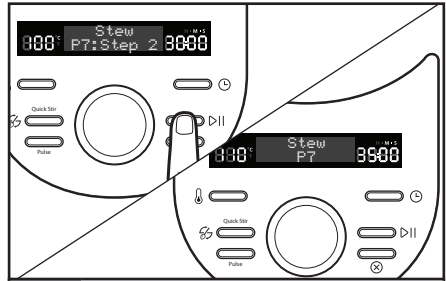

- 10** Press **▶||** (Start). The temp and time will stop flashing, and the time will begin counting down.



- 11** A tone will sound at the end of the next step. Repeat steps 9-10 until all cooking steps are complete. After the last step, the Cook Processor will automatically go into Keep Warm mode for 45 minutes. After 45 minutes, a tone will sound and the Cook Processor will turn off.

In the event of a power outage, the welcome screen will be displayed when power is restored.

! WARNING

Food Poisoning Hazard

Do not eat food from the cook processor if “KitchenAid Press Any key to Continue” shows in the display.

Doing so can result in food poisoning or sickness.

If a cooking cycle was interrupted, be sure that food is cooked completely, to a minimum internal temperature of at least 74°C (165°F).

IMPORTANT: To avoid splashing, always turn motor OFF before unlatching the lid.

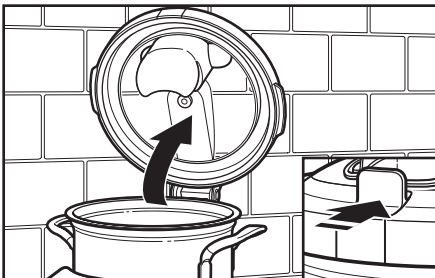

- 12** Using oven mitts or pot holders, open the lid and remove any accessory before removing the bowl and serving.

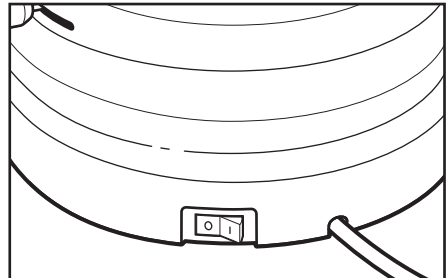

- 13** Turn the main power switch to **○** (OFF).

USING STEAMER BASKETS

The Cook Processor includes two different types of steamer baskets that can be used when cooking in certain modes. **NOTE:** Steamer baskets cannot be used with food processing attachments such as the MultiBlade, StirAssist, Dough Blade, or Egg Whip.

Using the round internal steamer basket

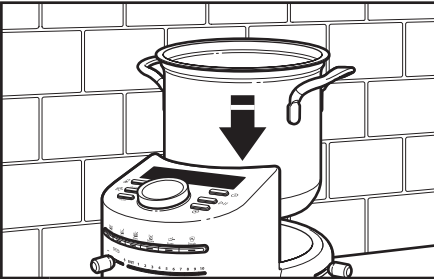

1 Place the bowl on the base, making sure it locks into place. If the bowl is not locked in place, UNLOCKED will show in the display.

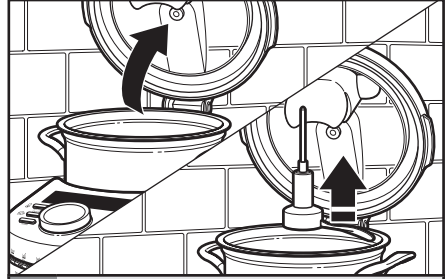

2 Open the lid of the bowl and remove any food processing attachments, if installed.

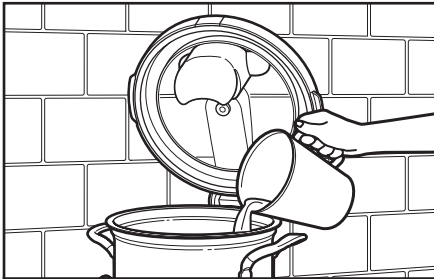

3 Add ingredients or water to the bowl, according to the recipe.

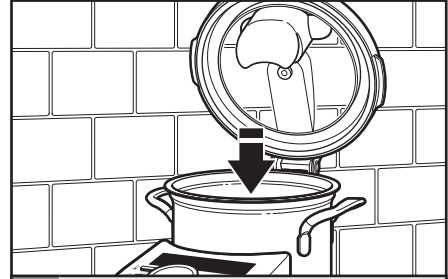

4 Place the internal steamer basket in the bowl.

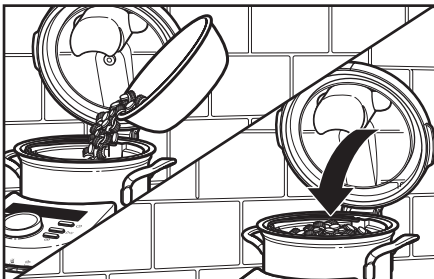

5 Place food to be steamed in the basket and close and latch the lid. Be sure the measuring cup is in place.

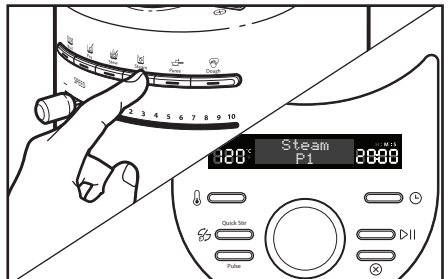

6 Proceed with the Steam cooking mode specified by your recipe, or with Manual cooking mode.

USING STEAMER BASKETS

You can use the upper and lower steamer baskets together, or just the lower steamer basket. You may also use the lower steamer basket with the inner steamer basket. The instructions below show an example of using both upper and lower baskets.

Using the upper and lower steamer baskets

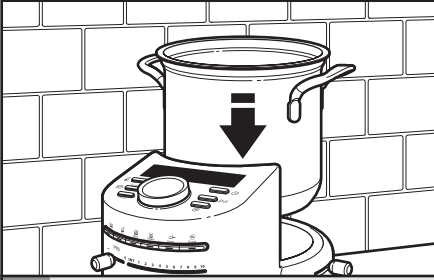

1 Place the bowl on the base, making sure it locks into place. If the bowl is not locked in place, UNLOCKED will show in the display.

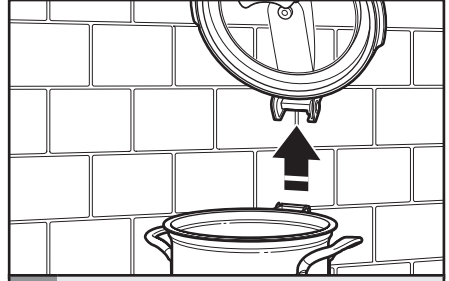

2 Remove the lid by opening it, then disconnecting it from the hinge.

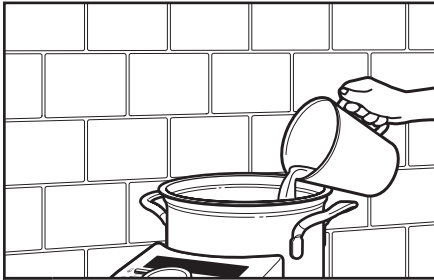

3 Add ingredients or water to the bowl, according to the recipe.

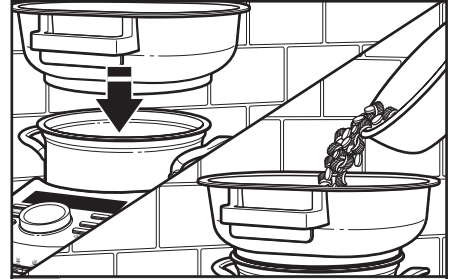

4 Place food to be steamed in the lower steamer basket, then place the basket on top of the bowl.

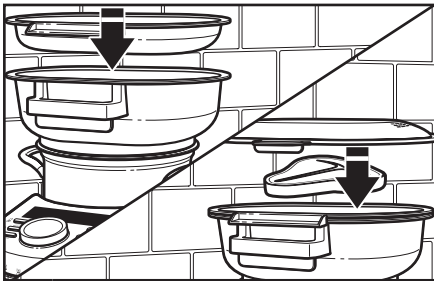



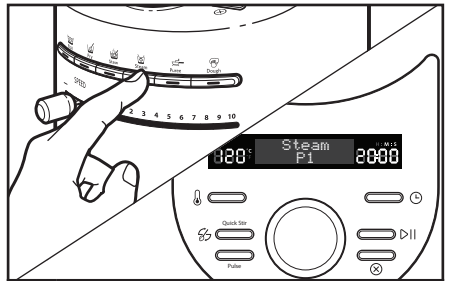

5 The upper and lower steamer baskets can be stacked together to steam two different foods at once. After ingredients are added, cover with the steamer lid.

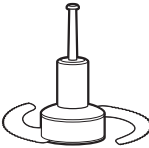

6 Proceed with the Steam cooking mode specified by your recipe, or with Manual cooking mode.

USING MANUAL COOKING MODES

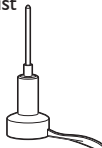
Refer to the guide below for recommended speeds and quantities for accessories when using manual cooking modes. **IMPORTANT:** To avoid splashing, always follow recommended speeds when using the Egg Whip, Dough Blade, or MultiBlade.

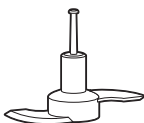
Accessory	Food	Speed	Quantity	Operating Time
	Pureed soups	10	2.5 L	Up to 1 min. for puree†
	Meat (boneless)	10	1.0 kg	Up to 1 min. for puree†
	Fish (boneless)	10	1.0 kg	Up to 1 min. for puree†
	Vegetables	10	1.0 kg	2 min.†
	Compote	10	500 g	30 sec.
	Nuts (almonds, pecans, walnuts, peanuts)	10	700 g	30 sec.
	Pureed soups	10	1.0 L	Up to 1 min. for puree†
	Meat, fish (boneless).	10	500 g	Up to 1 min. for puree†
	Nuts (almonds, pecans, walnuts, peanuts)	10	300 g	30 sec.
	Pesto	10	450 g	30 sec.
	Fry (2x2 cm cubed meats, bacon, onion)	1	600 g	5 min.
	Risotto	1	1.5 kg (350 g of rice)	20 min.
	Mijotes	1	2.5 L	30–45 min.
	Egg whites	7–9	8 eggs	5–10 min.
	Mayonnaise, whipped cream	7–9	1.3 L	5–8 min.
	Crèmes, sauces	4–6	1.2 L	5–10 min.
	Bread dough	2	1.2 kg	2–4 min.
	Pastry	5	1.2 kg	2–3.5 min.
	Brioche bread	5	1.2 kg	2–3.5 min.
	Cake batter	6	1.5 L	2 min.
	Crepe batter	8	1.5 L	2 min.

†Cut into 2 cm pieces

USING MANUAL COOKING MODES

Cooking with manual settings

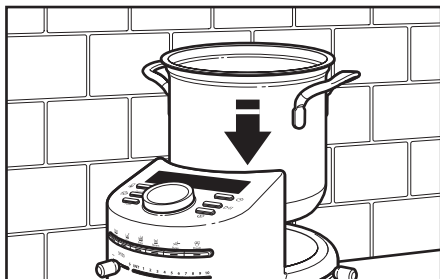

- 1** Place the bowl on the base, making sure it locks into place.

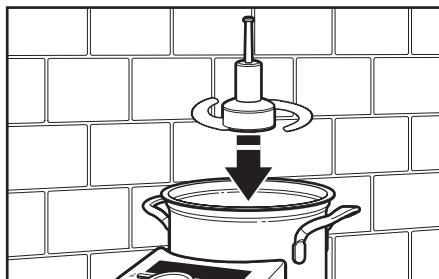

- 2** OPTIONAL: Insert the desired accessory into the bowl, sliding it onto the drive shaft.



- 3** Add the ingredients for the first step of cooking. Do not exceed the MAX FILL line.

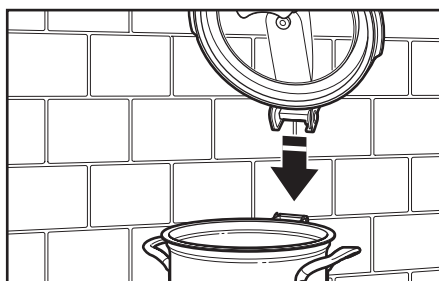

- 4** Close and latch the lid. If the lid is not properly installed, LID OPEN will show in the display if the speed lever, Pulse, or  (Quick Stir) buttons are activated.

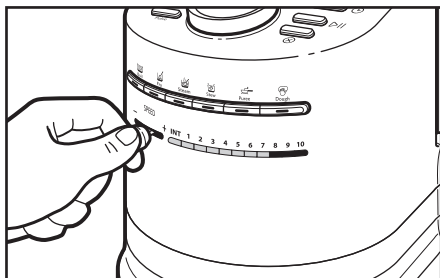

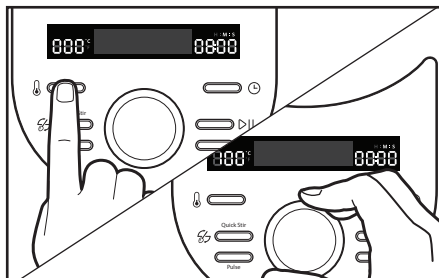

- 5** If using an accessory: Press the speed lever right (+) or left (-) to select the desired speed, or press the Pulse or  (Quick Stir) button.



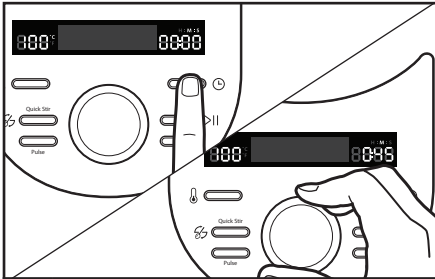

- 6** Press  (Temperature) and use the dial to set the desired cooking temperature.

USING MANUAL COOKING MODES

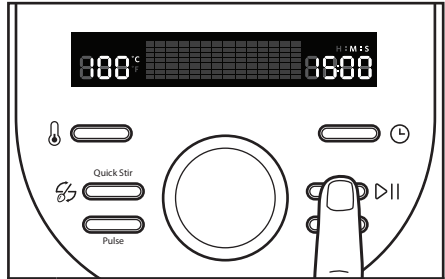

7 Press  (Time) and use the dial to set the desired cooking time.



8 Press  (Start). The temperature and time will stop flashing and the time will begin counting down. **PREHEATING** will appear in the display until the set temperature is reached.

NOTE: If the Cook Processor is at a higher temperature, and a lower temperature is selected, **COOLING** will appear in the display until the lower temperature is reached.

IMPORTANT: To avoid splashing, always turn motor off before unlatching the lid.

In the event of a power outage, the welcome screen will be displayed when power is restored.

WARNING

Food Poisoning Hazard

Do not eat food from the cook processor if “KitchenAid Press Any key to Continue” shows in the display.

Doing so can result in food poisoning or sickness.

If a cooking cycle was interrupted, be sure that food is cooked completely, to a minimum internal temperature of at least 74°C (165°F).

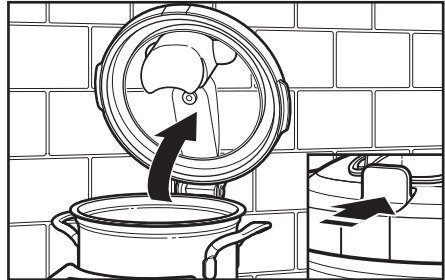

9 When the timer reaches 00:00, a tone will sound and the Cook Processor will turn off. Use oven mitts or pot holders to open the lid and remove any accessory before removing the bowl and serving.

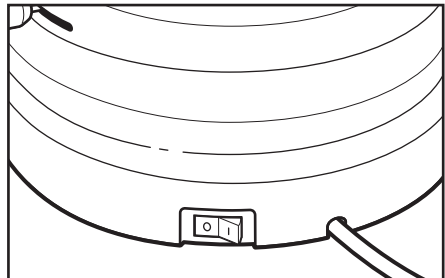

10 Turn the main power switch to **O** (OFF).

CARE AND CLEANING

Cleaning your Cook Processor

The bowl and lid are dishwasher safe, however handwashing is recommended.

Unplug your Cook Processor from the wall socket before cleaning.

- Allow Cook Processor and accessories to cool completely before cleaning.

Exterior Surfaces:

- Do not use abrasive cleaners or metal scouring pads. They could scratch the surface.
- Wipe the outside of the Cook Processor with a clean, damp cloth and dry thoroughly.

Bowl:

To clean the inside of the bowl, wipe with a nonabrasive damp, sudsy cloth, then wipe out with a clean damp cloth. To remove tough cooked-on foods, fill bowl with hot, soapy water and allow to soak before cleaning.

- To remove baked-on stains, scrub with a paste made from baking soda and water. Rinse and dry thoroughly.

The bowl is also dishwasher safe.

- 1 Remove the drive shaft before washing.
- 2 After washing, thoroughly dry the bowl with a soft cloth.
- 3 Reinstall the drive shaft before use.

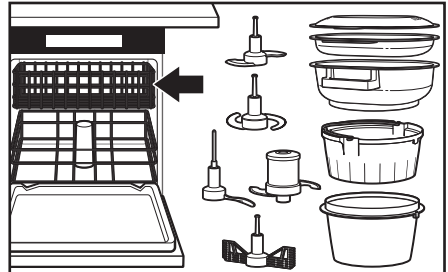

All accessories and blades are top rack dishwasher-safe. Thoroughly dry all parts after washing. Use gentle dishwashing cycles such as normal. Avoid high temperature cycles.

Drive Shaft Removal/Installation

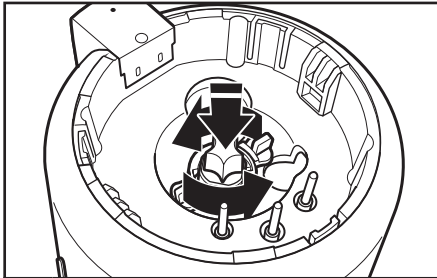

- 1 Remove the drive shaft when washing bowl.

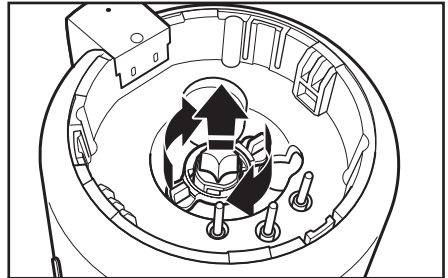

- 2 Reinstall the drive shaft before use.

CARE AND CLEANING

Lid and Inner Lid Seal:

The lid contains drain holes covered by an inner rubber seal.

- When washing the lid in the dishwasher or by hand, remove the inner seal from the lid by pulling it from under the tabs on the bottom of the lid. Wash the seal in the dishwasher or in warm, soapy water, and dry before reinstalling. Reinstall the seal before placing the lid back on the Cook Processor.

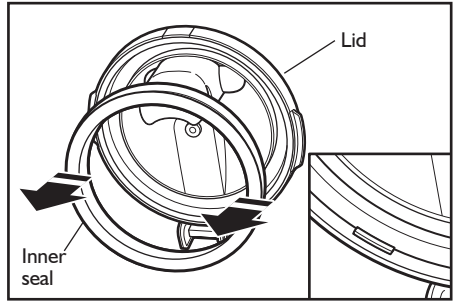

To reinstall the inner lid seal:

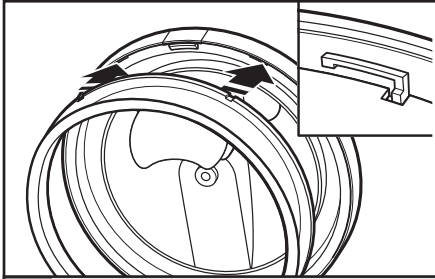

- 1 Insert the front edge under the tabs, as shown.

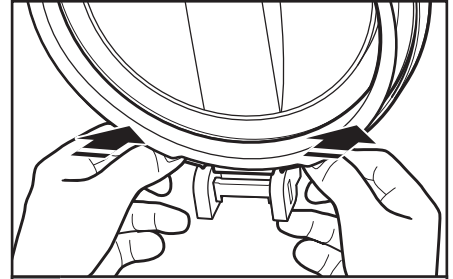

- 2 Starting at the back and working around to the front, press the seal into place until it clicks into place.

Storing accessories

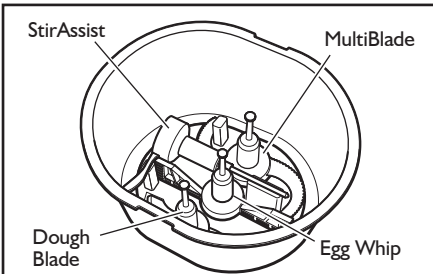

- 1 The MultiBlade, Dough Blade, Egg Whip, and StirAssist fit into the storage case, as shown.

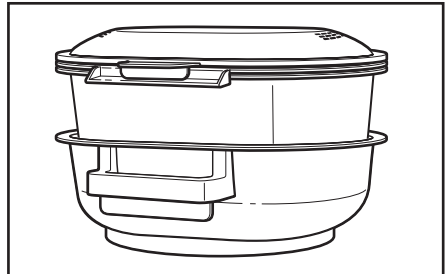

- 2 The Storage Case nests with the upper and lower Steamer Baskets and steamer lid.

If your Cook Processor malfunctions or fails to operate

WARNING



Electrical Shock Hazard

Plug into a grounded outlet.

Do not remove ground prong.

Do not use an adapter.

Do not use an extension cord.

Failure to follow these instructions can result in death, fire, or electrical shock.

- **Is the Cook Processor plugged into a grounded outlet?**

Plug the Cook Processor into a grounded outlet.

- **Is the fuse in the circuit to the Cook Processor in working order?**

If you have a circuit breaker box, make sure the circuit is closed. Try unplugging the Cook Processor, then plug it back in.

- **Display shows UNLOCKED:**

Bowl is not locked into the base correctly. Check the bowl to be sure it is locked into place.

- **Display shows LID OPEN:**

Lid is not latched on the bowl and an Automatic Cooking Mode other than Steam P1 or a manual attachment speed, Pulse or Quick Stir is being selected. Check the lid to be sure it is latched into place.

- **Display shows MODE:**

The display will show MODE if Quick Stir or Pulse is pressed during an Automatic Cooking Mode. These functions are disabled during Automatic Cooking modes.

- **Display shows ACCESSORY:**

The display will show ACCESSORY if the StirAssist blade is installed and Pulse or a higher speed is selected.

- **Display shows COOLING:**

Unit is cooling down if a temperature lower than the current cooking temperature is selected.

Error messages:

- **Motor turns off during processing and display shows “Error 1”:**

The motor is overloaded. Reduce the amount of ingredients and turn off the unit to allow the motor to cool down for several minutes.

- **Motor and/or heater will not turn on and display shows “Error 2”:**

Turn off and unplug the Cook Processor. Call for service.

- **Cook Processor turns off before the end of the cycle and display shows “Error 3”:**

Unit is malfunctioning. Turn off and unplug the Cook Processor. Call for service.

- **If the problem cannot be corrected:**

See the “Warranty and Service” section. Do not return the Cook Processor to the retailer – retailers do not provide service.

KitchenAid

© 2015. All rights reserved.
Specifications subject to change without notice.

Free Manuals Download Website

<http://myh66.com>

<http://usermanuals.us>

<http://www.somanuals.com>

<http://www.4manuals.cc>

<http://www.manual-lib.com>

<http://www.404manual.com>

<http://www.luxmanual.com>

<http://aubethermostatmanual.com>

Golf course search by state

<http://golfingnear.com>

Email search by domain

<http://emailbydomain.com>

Auto manuals search

<http://auto.somanuals.com>

TV manuals search

<http://tv.somanuals.com>