



KitchenAid

Corded Hand Blender 5KHBV83



EN	Use & Care manual	2	NO	Håndbok for bruk og vedlikehold	113
DE	Gebrauchs- und Pflegeanleitung	15	FI	Käyttö- ja huolto-opas	125
FR	Manuel d'utilisation et d'entretien	27	DA	Vejledning til anvendelse og vedligehold	137
IT	Manuale d'uso e manutenzione	41	IS	Notenda & Meðhöndlunar handbók	149
NL	Gebruiks- en onderhoudshandleiding	53	RU	Руководство по эксплуатации и уходу	161
ES	Manual de uso y cuidado	65	PL	Instrukcja obsługi i konserwacji	173
PT	Manual de utilização e manutenção	77	CS	Návod k použití a údržbě	185
EL	Εγχειρίδιο Χρήσης και Φροντίδας	89	TR	Kullanım ve Bakım kılavuzu	197
SV	Handbok för skötsel och användning	101	AR	دليل الاستخدام والعناية	1





PARTS AND FEATURES

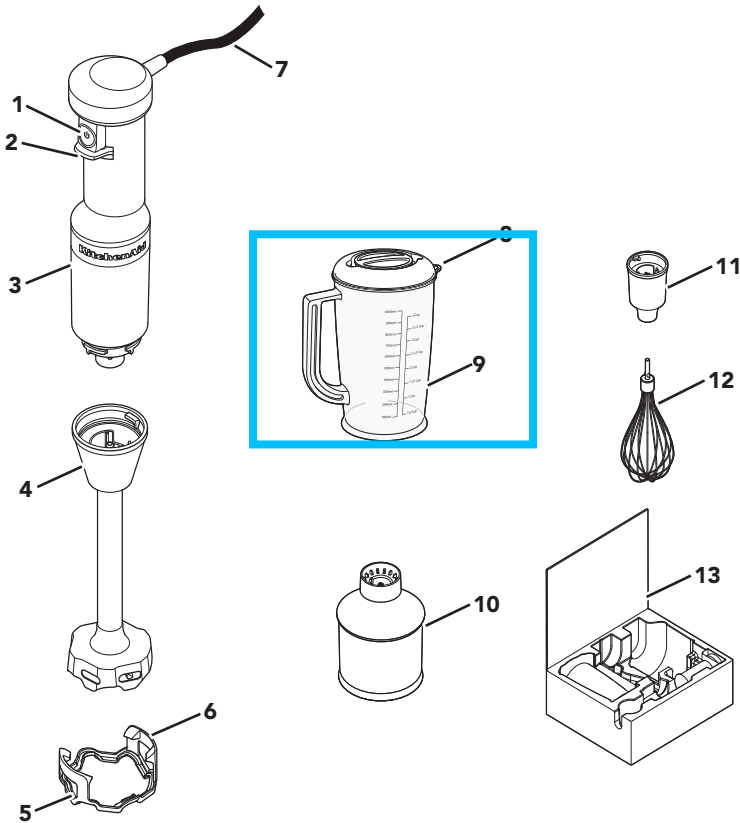

- | | | | |
|----------|--|-----------|---|
| 1 | Variable Speed Controller | 7 | Power Cord (5 ft.) |
| 2 | Speed Controller Guard | 8 | Pour Spout |
| 3 | Motor Body | 9 | 1 Litre (4 Cup) BPA-free Blender Pitcher with Lid |
| 4 | Blending Arm 20.3 cm (8") | 10 | Chopper Attachment |
| 5 | Pan Guard - Use the pan guard to avoid damage to cookware while using the Hand Blender | 11 | Whisk Adapter |
| 6 | Mounting Clips | 12 | Whisk |
| | | 13 | Storage Case |





PRODUCT SAFETY

Your safety and the safety of others are very important.

We have provided many important safety messages in this manual and on your appliance. Always read and obey all safety messages.



This is the safety alert symbol.

This symbol alerts you to potential hazards that can kill or hurt you and others.

All safety messages will follow the safety alert symbol and either the word "DANGER" or "WARNING." These words mean:

⚠ DANGER

You can be killed or seriously injured if you don't immediately follow instructions.

⚠ WARNING

You can be killed or seriously injured if you don't follow instructions.

All safety messages will tell you what the potential hazard is, tell you how to reduce the chance of injury, and tell you what can happen if the instructions are not followed.

IMPORTANT SAFEGUARDS

When using electrical appliances, basic safety precautions should always be followed, including the following:

1. Read all instructions. Misuse of appliance may result in personal injury.
2. To protect against risk of electrical shock do not put motor body, cord, or electrical plug of this Hand Blender in water or other liquid.
3. This appliance is not intended for use by persons (including children) with reduced physical, sensory, or mental capabilities, or lack of experience or knowledge, unless they are closely supervised and instructed concerning use of the appliance by a person responsible for their safety.
4. This appliance shall not be used by children. Keep the appliance and its cord out of reach of children.
5. Never leave the appliance unattended while it is in operation.
6. Turn the appliance OFF, then unplug from the outlet if it is left unattended and before, assembling, disassembling, cleaning or when not in use. To unplug, grasp the plug and pull from the outlet. Never pull from the power cord.
7. If the supply cord is damaged, it must be replaced by a special cord or assembly available from the manufacturer or its service agent.
8. European Union only: This appliance shall not be used by children, Keep the appliance and its cord out of reach of children. Cleaning and user maintenance shall not be made by children without supervision.
9. European Union only: This appliance can be used by persons with reduced physical, sensory or mental capabilities or lack of experience and knowledge if they have been given supervision or instruction concerning use of the appliance in a safe way and understand the hazards involved. Children shall not play with the appliance.
10. Avoid contacting moving parts.



PRODUCT SAFETY

11. Do not operate any appliance with a damaged cord or plug, or after the appliance malfunctions, or is dropped or damaged in any manner. Return appliance to the nearest Authorised Service Facility for examination, repair, or electrical or mechanical adjustment.
12. The use of attachments not recommended or sold by the manufacturer may cause fire, electric shock, or injury.
13. Do not use the appliance outdoors.
14. Do not let cord hang over edge of table or counter.
15. Do not let cord contact hot surfaces, including the stove.
16. Keeps hands and utensils out of the container while blending to prevent the possibility of severe injury to persons or damage to the unit. A scraper may be used but must be used only when the unit is not running.
17. **Blades are sharp. Handle Carefully. Care should be taken when handling the sharp cutting blades, emptying the Bowl and during cleaning.**
18. When mixing liquids, especially hot liquids, use a tall container or make small quantities at a time to reduce spillage.
19. To reduce the risk of injury, never place cutting blade on Base without first putting bowl properly in place.
20. **Be certain cover is securely locked in place before operating the Food Chopper.**
21. **Be careful if hot liquid is poured into the Food Processor or Blender as it can be ejected out of the appliance due to a sudden steaming.**
22. Keep hands and utensils away from the cutting blade while chopping food to reduce the risk of severe injury to person, or damage to the Hand Blender. A scraper may be used, but only when the Hand Blender is not running.
23. Refer to the “Care and Cleaning” section for instructions on cleaning the surfaces in contact with food.
24. This appliance is intended to be used in household and similar applications such as:
 - staff kitchen areas in shops, offices, or other working environments;
 - farmhouses;
 - by clients in hotels, motels and other residential type environments;
 - bed and breakfast type environments.

SAVE THESE INSTRUCTIONS

Instructions are also available online, visit our website at:

www.KitchenAid.co.uk or www.KitchenAid.eu





PRODUCT SAFETY

ELECTRICAL REQUIREMENTS

Voltage: 220-240 VAC

Frequency: 50 - 60 Hz

Wattage: 180 W

NOTE: If the plug does not fit in the outlet, contact a qualified electrician. Do not modify the plug in any way. Do not use an adapter.

Do not use an extension cord. If the power supply cord is too short, have a qualified electrician or service technician to install an outlet near the appliance.

The cord should be arranged so that it will not drape over the countertop or tabletop where it can be pulled on by children or tripped over unintentionally.

NOTE: Maximum rating is based on Chopper accessory. Other attachments may draw different power or current.

ELECTRICAL EQUIPMENT WASTE DISPOSAL

Disposal of packing material

The packing material is recyclable and is marked with the recycle symbol (♻️). The various parts of the packing must therefore be disposed of responsibly and in full compliance with local authority regulations governing waste disposal.

Scrapping the product

- This appliance is marked in compliance with European Directive 2012/19/EU, Waste Electrical and Electronic Equipment (WEEE).

- By ensuring this product is disposed of correctly, you will help prevent potential negative consequences for the environment and human health, which could otherwise be caused by inappropriate waste handling of this product.



- The symbol  on the product or on the accompanying documentation indicates that it should not be treated as domestic waste but must be taken to an appropriate collection centre for the recycling of electrical and electronic equipment.

For more detailed information about treatment, recovery and recycling of this product, please contact your local city office, your household waste disposal service or the shop where you purchased the product.

DECLARATION OF CONFORMITY

This appliance has been designed, constructed and distributed in compliance with the safety requirements of EC Directives: 2014/35/EU, 2014/30/EU, 2009/125/EC and 2011/65/EU (RoHS Directive).

PRODUCT USAGE

ASSEMBLING THE BLENDING ARM

Before first use, clean all parts (see "Care and Cleaning" section).

IMPORTANT: Always unplug the Hand Blender, before attaching or removing parts.

1

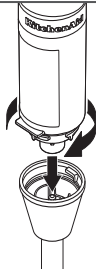

Insert the Blending Arm into the Motor Body and twist until it clicks to lock in place.

2

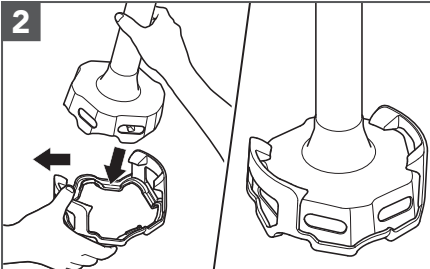

If using a Pan Guard, place it on a flat surface. To insert the Pan Guard, angle the Blending Arm to one side of the Mounting Clip. Then, gently pull the other Mounting Clip outward and push down the Blending Arm. Ensure the Mounting Clips are secured into place.

NOTE: U.S. patented removable Pan guard to help protect your cookware.

USING THE BLENDING ARM

Use for smoothies, milkshakes, soup, cooked vegetables, frosting, or baby food, etc.

1

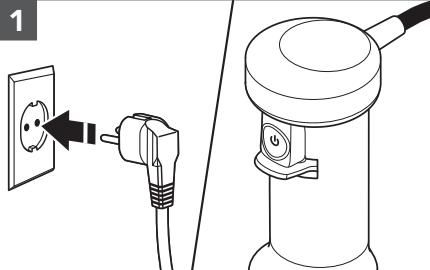

Plug the Hand Blender into an earthed electrical outlet.

2

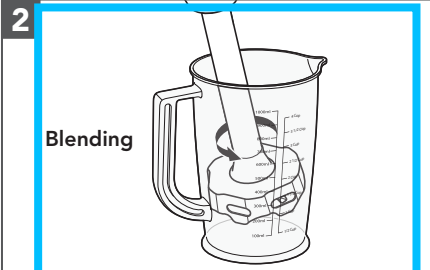

Blending

Insert the Hand Blender into the mixture. Press the Variable Speed Controller to start. Use your free hand to cover the top of the Blending Pitcher for better stability and avoid splashing.

NOTE: Do not immerse Motor Body into liquids or other mixtures.



PRODUCT USAGE

USING THE BLENDING ARM

3

Drawing up

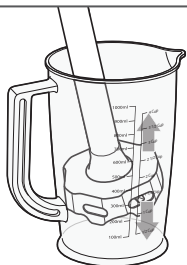

Use the draw up motion with the Hand Blender to move the ingredients within the Pitcher. Slowly draw it upwards against the side of the Pitcher. Repeat the process until the ingredients are at the desired consistency.

4

Wrist movement

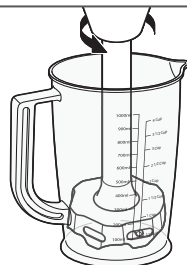

With your wrist, make a circular motion to draw the Hand Blender up slightly and let it blend again into the ingredients.

5

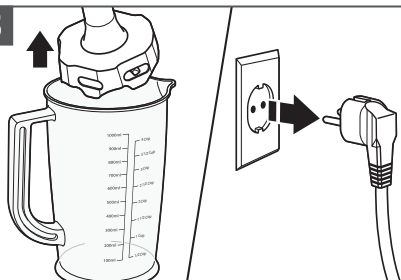

Release the Variable Speed Controller to stop; then remove Hand Blender from mixture. Unplug the Hand Blender before removing or attaching the parts.





PRODUCT USAGE

USING THE CHOPPER ATTACHMENT

Use to cut and chop beef, onion, garlic, cheese, carrots, nuts, etc.

! WARNING

Cut Hazard
Handle blades carefully.
Failure to do so can result in cuts.

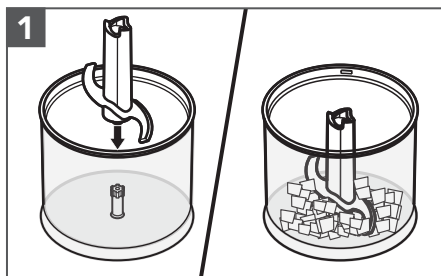

1

Insert the Chopper blade into Chopper bowl. Add ingredients into the Bowl. For best results, cut the food items into 3/4" (2 cm) pieces.

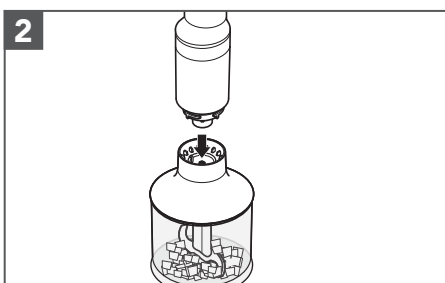

2

Align the Chopper Attachment with the Motor Body and press together. Do not twist the Motor Body into place.



3

Press the Variable Speed Controller. For best results, "pulse" the power by pressing and releasing the Variable Speed Controller until ingredients reach the desired consistency.

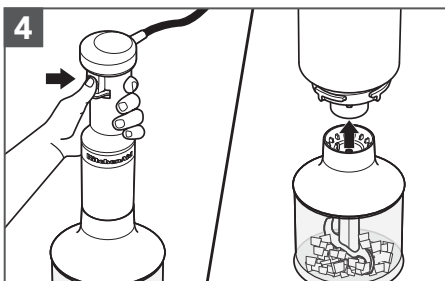

4

When chopping is complete, release the Variable Speed Controller.



PRODUCT USAGE

USING THE WHISK ATTACHMENT

Use the Whisk to whip cream, beat egg whites, mix instant puddings, vinaigrettes, mousse, or for making mayonnaise.

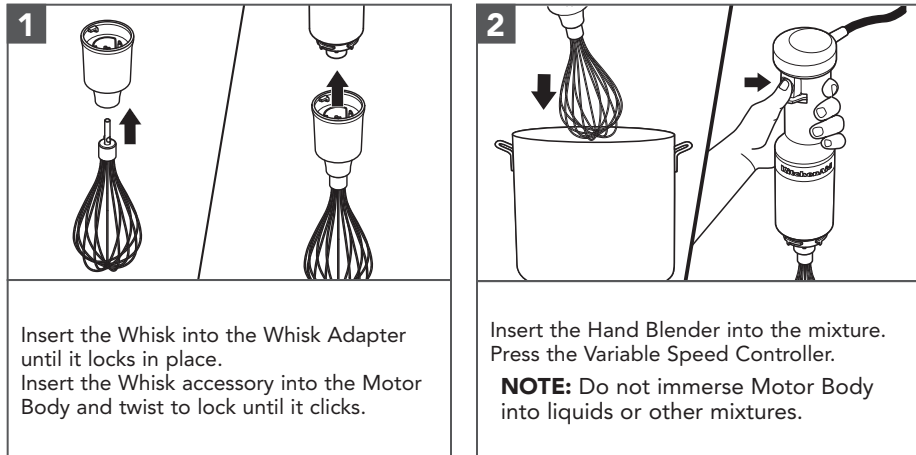

TIP: The stainless steel Whisk may scratch or mark non-stick coatings; avoid using the Whisk with non-stick cookware.

NOTE: After whisking is complete, release the Variable Speed Controller; then remove Hand Blender from mixture.

SUGGESTED FOOD ITEMS - FOOD CHOPPER ATTACHMENT

Food	Quantity	Preparation	Speed	Pulse
Almonds/Nuts	200 gm (7 oz)	Place in whole nuts	High	Quick pulse 15 to 25 times
Beef*		Cut into 2 cm (3/4 inch) cubes	High	Quick pulse 10 to 15 times
Carrots**		Cut average carrot into quarters	High	Quick pulse 15 to 20 times
Garlic	10 to 12 cloves	Place in whole cloves	High	Quick pulse 10 to 15 times
Onion	100 gm (3.5 oz)	Cut into quarters	High	Quick pulse 6 to 10 times
Parmesan cheese		Cut into 1 cm (3/8 inch) cubes	High	Quick pulse 20 to 30 times

Processing settings are approximate. Actual settings may vary depending on quality of food and desired blending results.

TIP: A Quick Pulse is one second On and one second Off operation. Do not operate Blending Arm or Whisk continuously for more than 1 minute.

*Beef is better treated with Chopper attachment.

** Carrots are better treated with Blending Arm.

CARE AND CLEANING

IMPORTANT: Always unplug the Hand Blender before attaching or removing parts.

1



Dishwasher safe parts - top rack only:
Whisk, Pan Guard, Chopper Bowl, Chopper Blade, Chopper Attachment, Whisk Adapter, Blender Arm, Blender Pitcher, and Lid.

2

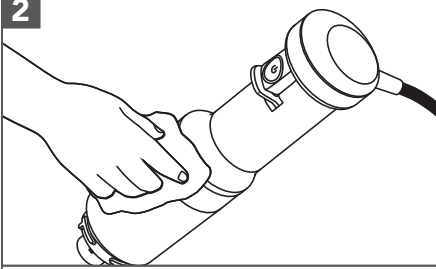

Wipe the Motor Body with a damp cloth. Mild dish soap may be used, but do not use abrasive cleansers.

For detailed information on the Hand Blender:

Visit www.kitchenaid.eu for additional instructions with videos, inspiring recipes, and tips on how to use and clean your Hand Blender.

TROUBLESHOOTING GUIDE

Problem	Solution
If the Hand Blender fails to start:	Check to see if the Hand Blender is securely plugged into an earthed electrical outlet.
	If you have a circuit breaker box, check to make sure that the circuit is closed.
If the Hand Blender stops while blending:	When overloaded or jammed, it will automatically shut off to prevent motor damage. Divide contents into smaller batches. For certain recipes, adding liquid in the Pitcher may also reduce the load.
If the problem cannot be corrected:	See the "Terms of KitchenAid Guarantee ("Guarantee")" section. Do not return the Hand Blender to the retailer. Retailers do not provide service.



TERMS OF KITCHENAID GUARANTEE ("GUARANTEE")

Covering U.K. - Ireland - South Africa - UAE

KitchenAid Europa, Inc., Nijverheidslaan 3, Box 5, 1853 Strombeek-Bever, Belgium ("Guarantor") grants the end-customer, who is a consumer, a Guarantee pursuant to the following terms.

FOR U.K.:

The Guarantee applies in addition to and does not limit or affect the statutory warranty rights of the end-customer against the seller of the product. In summary, the Consumer Rights Act 2015 says products must be as described, fit for purpose and of satisfactory quality. During the expected lifespan of your product your legal rights entitle you to the following:

- Up to 30 days: if your product is faulty, then you can get an immediate refund.
- Up to six months: if your product can't be repaired or replaced, then you're entitled to a full refund, in most cases.
- Up to six years: if your product does not last a reasonable length of time you may be entitled to some money back.

These rights are subject to certain exceptions. For detailed information please visit the Citizens Advice website www.adviceguide.org.uk or call 03454 04 05 06.

FOR IRELAND:

The Guarantee applies in addition to and does not limit or affect the statutory warranty rights of the end-customer against the seller of the product under the European Communities (Certain Aspects of the Sale of Consumer Goods and Associated Guarantees Regulations 2003 (S.I. No. 11/2003)) and other enactments governing the sale of consumer goods.

FOR SOUTH AFRICA:

The Guarantee applies in addition to and does not limit or affect the statutory warranty rights of the end-customer against the seller of the product. In summary, the Consumer Protection Act, 2008 says that products must be: (i) reasonably suitable for the purpose for which they are intended; (ii) in good working order, of good quality and free of any defects; (iii) useable and durable for a reasonable period of time, having regard to the use to which they would normally be put and to all the surrounding circumstances; and (iv) in compliance with any applicable standards or any other public regulations.

During the expected lifespan of your product and where the products are not purchased online, your legal rights will entitle you to the following:

- You will be entitled to a full refund, if you did not have the opportunity to examine the product before delivery and if you rejected delivery of the product on the basis that the type and quality of the product was not as reasonably expected or did not reasonably conform to the material specifications.
- Within 5 business days after delivery: you may rescind your purchase and request a refund, if your purchase resulted from direct marketing.
- Within 10 business days after delivery: you will be entitled to a full refund, if it is found that the product was unsuitable for a particular purpose specifically communicated to you by the Guarantor.
- Within 15 business days after delivery: you will be entitled to a refund if: (i) the product was not delivered to you; or (ii) if you returned the product to the Guarantor.
- Within 6 months after delivery: you will be entitled to a refund or a replacement product, if the product is defective or fails to operate in terms of its specifications.





TERMS OF KITCHENAID GUARANTEE ("GUARANTEE")

Where you have purchased a product online your legal rights will be governed by the Electronic Communications and Transactions Act, 2002 and you will be entitled to the following:

- Within 7 days after conclusion of the transaction or after delivery: you may cancel your purchase without reason and without penalty.
- Within 30 days of the date of cancellation of the transaction: you will be entitled to receive a refund, if you have already made payment.
- You will only be liable for the direct costs of returning the product to the Guarantor.

FOR UAE:

The Guarantee applies in addition to and does not limit or affect the statutory warranty rights of the end-customer against the seller of the product.

1) SCOPE AND TERMS OF THE GUARANTEE

a) The Guarantor grants the Guarantee for the products mentioned under Section 1.b) which a consumer has purchased from a seller or a company of the KitchenAid-Group within the following countries: U.K., Ireland, or South Africa, or the United Arab Emirates (UAE).

b) The Guarantee period depends on the purchased product and is as follows:

5KHBV83 Two years full guarantee from date of purchase.

c) The Guarantee period commences on the date of purchase, i.e. the date on which a consumer purchased the product from a dealer or a company of the KitchenAid-Group.

d) The Guarantee covers the defect-free nature of the product.

e) The Guarantor shall provide the consumer with the following services under this Guarantee, at the choice of the Guarantor, if a defect occurs during the Guarantee period:

- Repair of the defective product or product part, or
- Replacement of the defective product or product part. If a product is no longer available, the Guarantor is entitled to exchange the product for a product of equal or higher value.

f) If the consumer wishes to make a claim under the Guarantee, the consumer has to contact the country specific KitchenAid service centres or the Guarantor directly at KitchenAid Europa, Inc. Nijverheidslaan 3, Box 5, 1853 Strombeek-Bever, Belgium;

Email-Address U.K.: CONSUMERCARE.UK@kitchenaid.eu

Email-Address IRELAND: CONSUMERCARE.IE@kitchenaid.eu

Toll Free Number U.K. & IRELAND: **00 800 381 040 26**

FOR SOUTH-AFRICA:

Our local KitchenAid Distributor:

KitchenAid Africa
PO Box 52102
V&A Waterfront
Cape Town
8002





TERMS OF KITCHENAID GUARANTEE ("GUARANTEE")

Contact our distributor:

Telephone: +27 21 555 0700

You can contact our Customer Service Centre for Small Domestic Appliances from 8.30 am to 1.00pm and from 1.30 pm to 5.00 pm or write to us at the following address: hello@kitchenaidafrica.com

FOR UAE:

AL GHANDI ELECTRONICS.

POST BOX NO. 9098,

DUBAI, UNITED ARAB EMIRATES

Toll free number: +971 4 2570007

g) The costs of repair, including spare parts, and any postage costs (if applicable) for the delivery of a defect-free product or product part shall be borne by the Guarantor. The Guarantor shall also bear the postage costs for returning the defective product or product part if the Guarantor or the country specific KitchenAid customer service centre requested the return of the defective product or product part. However, the consumer shall bear the costs of appropriate packaging for the return of the defective product or product part.

h) To be able to make a claim under the Guarantee, the consumer must present the receipt or invoice of the purchase of the product.

2) LIMITATIONS OF THE GUARANTEE

a) **The Guarantee applies only to products used for private purposes and not for professional or commercial purposes.**

b) **The Guarantee does not apply in the case of normal wear and tear, improper or abusive use, failure to follow the instructions for use, use of the product at the wrong electrical voltage, installation and operation in violation of the applicable electrical regulations, and use of force (e.g. blows).**

c) **The Guarantee does not apply if the product has been modified or converted, e.g. conversions from 120 V products to 220-240 V products.**

d) **The provision of Guarantee services does not extend the Guarantee period, nor does it initiate the commencement of a new Guarantee period. The Guarantee period for installed spare parts ends with the Guarantee period for the entire product.**

e) **FOR SOUTH-AFRICA & UAE ONLY:**

Further or other claims, in particular claims for damages, are excluded unless liability is mandatory by law.

After expiry of the Guarantee period or for products for which the Guarantee does not apply, the KitchenAid customer service centres are still available to the end-customer for questions and information.

Further information is also available on our website:

- For U.K. & Ireland www.kitchenaid.eu

- For South-Africa: www.kitchenaidafrica.com

- For UAE: www.KitchenAid-MEA.com

PRODUCT REGISTRATION

Register your new KitchenAid appliance now: <http://www.kitchenaid.eu/register>





Free Manuals Download Website

<http://myh66.com>

<http://usermanuals.us>

<http://www.somanuals.com>

<http://www.4manuals.cc>

<http://www.manual-lib.com>

<http://www.404manual.com>

<http://www.luxmanual.com>

<http://aubethermostatmanual.com>

Golf course search by state

<http://golfingnear.com>

Email search by domain

<http://emailbydomain.com>

Auto manuals search

<http://auto.somanuals.com>

TV manuals search

<http://tv.somanuals.com>