

5KICA0WH



# TABLE OF CONTENTS

<b>PARTS AND FEATURES</b> .....	6
Parts and accessories.....	6
<b>ICE CREAM MAKER ATTACHMENT SAFETY</b> .....	7
Important safeguards .....	7
<b>USING THE ICE CREAM MAKER ATTACHMENT</b> .....	8
Attaching the ice cream maker for tilt-head mixers.....	8
Attaching the drive assembly for tilt-head mixers .....	9
Attaching the ice cream maker for bowl-lift mixers .....	10
Attaching the drive assembly for bowl-lift mixers.....	11
Making ice cream .....	13
Tips for great results.....	14
<b>CARE AND CLEANING</b> .....	15
<b>RECIPES</b> .....	16
<b>WARRANTY AND SERVICE</b> .....	21

# PARTS AND FEATURES

## PARTS AND ACCESSORIES

---

**NOTE:** The freeze bowl must be completely frozen to make ice cream.

**IMPORTANT:** The freeze bowl is not dishwasher safe. Hand wash only.

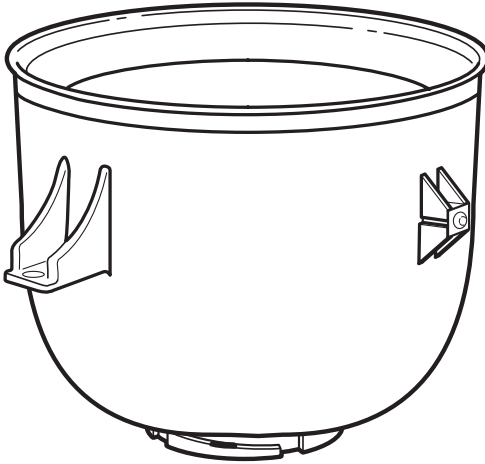

Freeze bowl

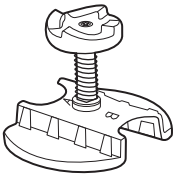

Drive  
Assembly

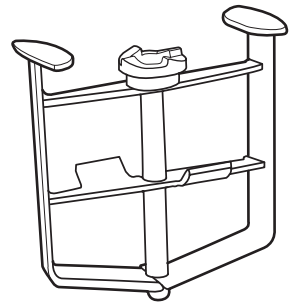

Dasher

# ICE CREAM MAKER ATTACHMENT SAFETY

## Your safety and the safety of others are very important.

We have provided many important safety messages in this manual and on your appliance. Always read and obey all safety messages.



This is the safety alert symbol.

This symbol alerts you to potential hazards that can kill or hurt you and others.

All safety messages will follow the safety alert symbol and either the word "DANGER" or "WARNING." These words mean:

**! DANGER**

**You can be killed or seriously injured if you don't immediately follow instructions.**

**! WARNING**

**You can be killed or seriously injured if you don't follow instructions.**

All safety messages will tell you what the potential hazard is, tell you how to reduce the chance of injury, and tell you what can happen if the instructions are not followed.

## IMPORTANT SAFEGUARDS

**When using electrical appliances, basic safety precautions should always be followed, including the following:**

1. Read all instructions. Misuse of appliance may result in personal injury.
2. To protect against risk of electrical shock, do not put Stand Mixer in water or other liquid.
3. Close supervision is necessary when this or any appliance is used near children.
4. Unplug Stand Mixer from outlet when not in use, before putting on or taking off parts, and before cleaning.
5. Avoid contacting moving parts. Keep fingers out of hopper inlet and discharge opening.
6. Do not operate the Stand Mixer with a damaged cord or plug, or after the Stand Mixer malfunctions, or is dropped or damaged in any manner. Return the Stand Mixer to the nearest Authorised Service Centre for examination, repair, or electrical or mechanical adjustment.
7. The use of attachments not recommended or sold by KitchenAid may cause fire, electric shock, or injury.
8. Do not use the Stand Mixer outdoors.
9. Do not let the cord hang over the edge of table or counter.
10. Do not let the cord contact hot surfaces, including the stove.

## SAVE THESE INSTRUCTIONS

**This product is designed for household use only.**

# USING THE ICE CREAM MAKER ATTACHMENT

## ATTACHING THE ICE CREAM MAKER FOR TILT-HEAD MIXERS

### Before first use

Before using your attachment, remove the "Do not immerse in water" label. The dasher is dishwasher safe. The freeze bowl and drive assembly must be washed by hand.

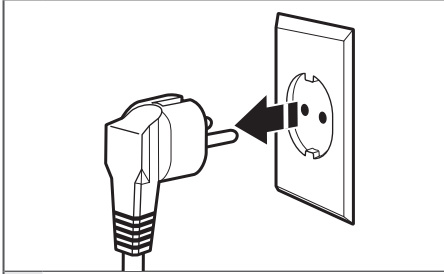

**1** Turn Stand Mixer OFF and unplug.

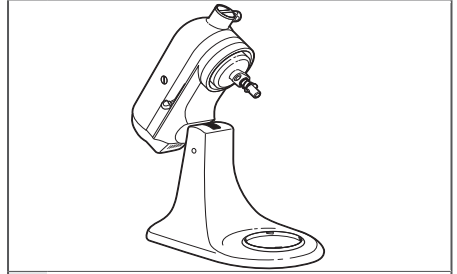

**2** Tilt motor head back and remove the mixing bowl.

**IMPORTANT:** Do not pour ice cream batter into the freeze bowl until all parts are assembled and the mixer is running.

**NOTE:** Use the freeze bowl immediately upon removal from freezer, as it begins to thaw once removed.

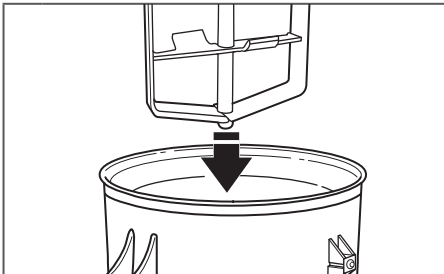

**3** Place the dasher inside the freeze bowl.

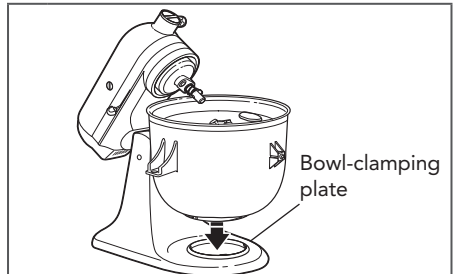

**4** Place the freeze bowl on the bowl-clamping plate.

# USING THE ICE CREAM MAKER ATTACHMENT

## ATTACHING THE DRIVE ASSEMBLY FOR TILT-HEAD MIXERS

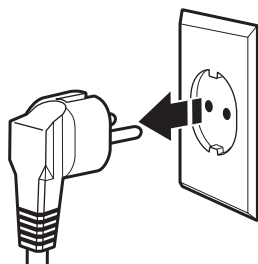

- 1** Be sure the Stand Mixer is off and unplugged. Keep the motor head tilted back and put the dasher and freeze bowl into place.

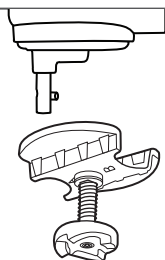

- 2** Position the drive assembly onto the mixer so that side A is closest to the beater shaft. Slide drive assembly onto the motor head until it will not slide any further.

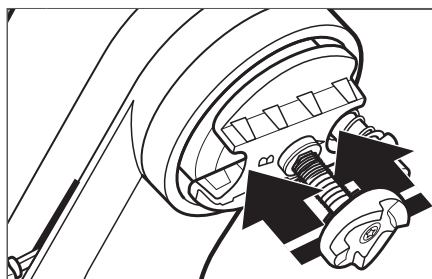

- 3** When properly assembled, the outer curved edges of the drive assembly should centre on the motor head. If they are not centred, slide the drive assembly either back or forward until it is centred on the motor head. Make sure the drive assembly is securely in place by pressing upward.



- 4** Lower the motor head to engage the drive assembly with the dasher. If the drive assembly doesn't engage the dasher, slide the drive assembly either back or forward until it does engage the dasher properly.

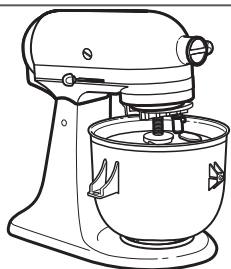

- 5** Make sure the motor head is down completely.

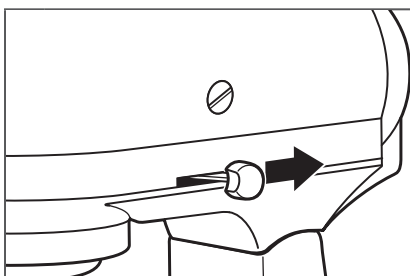

- 6** Place locking lever in the LOCK position. Before mixing, test the lock by attempting to raise the motor head.

# USING THE ICE CREAM MAKER ATTACHMENT

## ⚠ WARNING



### Electrical Shock Hazard

- Plug into an earthed outlet.
- Do not remove earth prong.
- Do not use an adapter.
- Do not use an extension cord.
- Failure to follow these instructions can result in death, fire, or electrical shock.

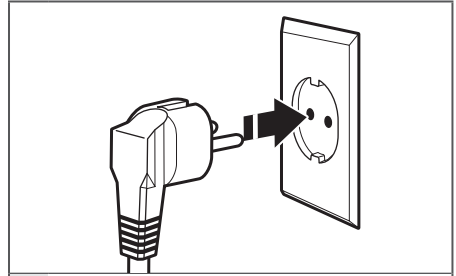

- 7 Plug the Stand Mixer into an earthed outlet.

## ATTACHING THE ICE CREAM MAKER FOR BOWL-LIFT MIXERS

### Before first use

Before using your attachment, remove the "Do not immerse in water" label. The dasher is dishwasher safe. The freeze bowl and drive assembly must be washed by hand.

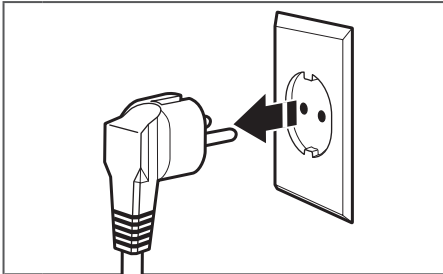

- 1 Turn Stand Mixer OFF and unplug.

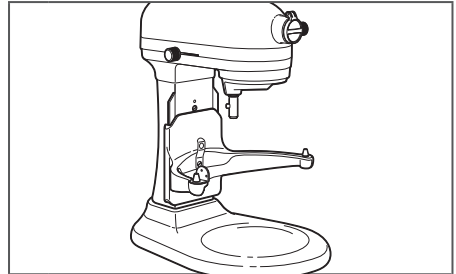

- 2 Place bowl-lift handle in down position and remove mixing bowl.

**IMPORTANT:** Do not pour ice cream batter into the freeze bowl until all parts are assembled and the mixer is running.

**NOTE:** Use the freeze bowl immediately upon removal from freezer, as it begins to thaw once removed.

## USING THE ICE CREAM MAKER ATTACHMENT

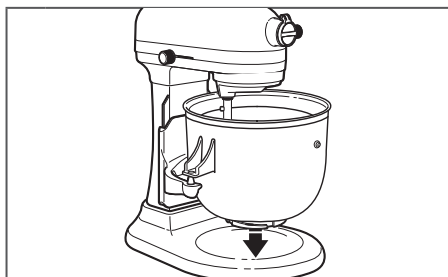

3

Fit the freeze bowl into place over the locating pins. Press down on the back of the freeze bowl until the bowl pin snaps into the spring latch.

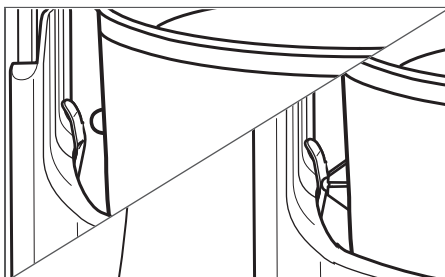

**NOTE:** The freeze bowl is designed to fill all bowl-lift mixers. If the bowl pin at the back of the bowl is too short or too long to snap into the spring latch, remove, and rotate the bowl so the opposite bowl pin faces the spring latch. Repeat step 3.

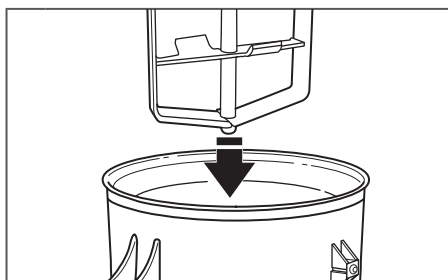

4

Place the dasher inside the freeze bowl.

## ATTACHING THE DRIVE ASSEMBLY FOR BOWL-LIFT MIXERS

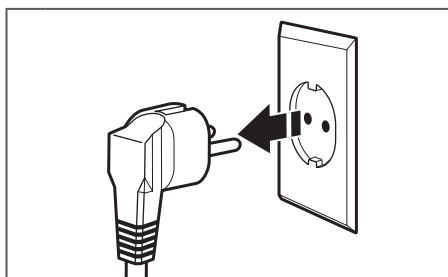

1

Be sure the Stand Mixer is OFF and unplugged.

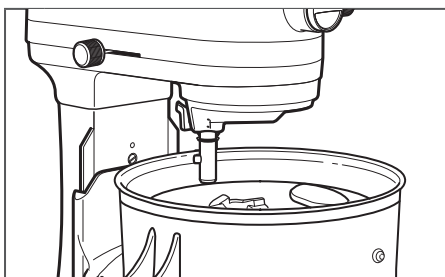

2

Make sure the bowl-lift handle is still in the down position and the freeze bowl and dasher are in place.



# USING THE ICE CREAM MAKER ATTACHMENT

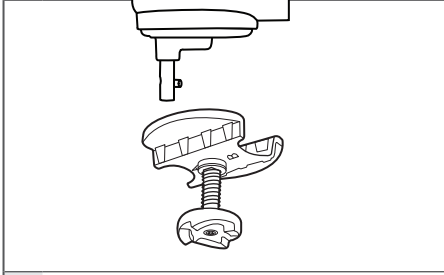

- 3** Position the drive assembly onto the mixer so that side B is closest to the beater shaft. Slide drive assembly onto the motor head until it will not slide any further.

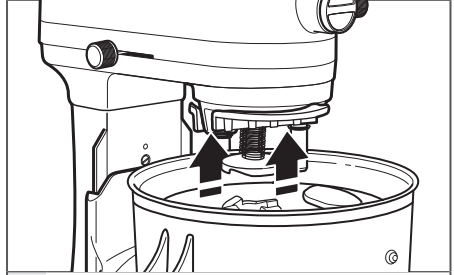

- 4** When properly assembled, the outer curved edges of the drive assembly should centre on the motor head. If they are not centred, slide the drive assembly either back or forward until it is centred on the motor head. Make sure the drive assembly is securely in place by pressing upward.

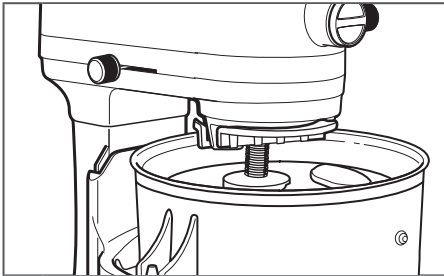

- 5** Raise the bowl to engage the dasher with the drive assembly before mixing. If the drive assembly doesn't engage the dasher, slide the drive assembly either back or forward until it does engage the dasher properly.

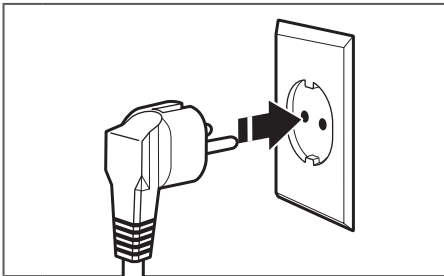

- 6** Plug the Stand Mixer into an earthed outlet.

## **⚠ WARNING**



### **Electrical Shock Hazard**

**Plug into an earthed outlet.**

**Do not remove earth prong.**

**Do not use an adapter.**

**Do not use an extension cord.**

**Failure to follow these instructions can result in death, fire, or electrical shock.**

# USING THE ICE CREAM MAKER ATTACHMENT

## MAKING ICE CREAM

**IMPORTANT:** Pouring batter into the freeze bowl before starting the Stand Mixer may cause the batter to freeze prematurely and lock the dasher.

### Before first use

Set freezer to coldest setting. Store the freeze bowl in the freezer for a minimum of 15 hours. Prepare ice cream batter in advance. Please see "Tips for great results".

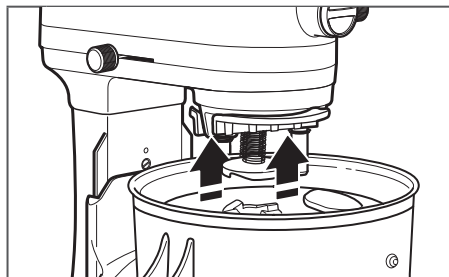

- 1** Assemble and engage the freeze bowl, dasher, and drive assembly.

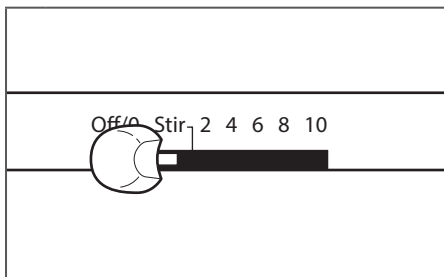

- 2** Set the mixer to "STIR" speed and pour the ice cream batter into the freeze bowl; mix 20-30 minutes, or to desired consistency. Add any solid ingredients such as fruits, nuts, candies, or chocolate chips, after 12-15 minutes of the mixing process.

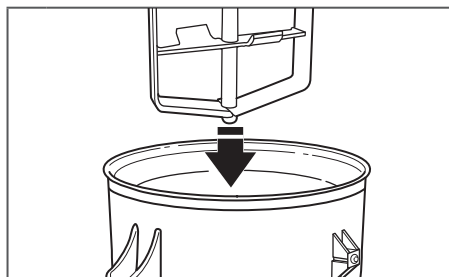

- 3** Remove the dasher and the freeze bowl and, using a rubber spatula or a plastic or wooden spoon, transfer ice cream to dessert dishes or to an airtight container for storage.

**NOTE:** If the dasher begins to slip and make a clicking noise, this is an audible indicator that the ice cream is done.

**NOTE:** The Ice Cream Maker Attachment will create a soft-consistency ice cream. For firmer consistency, store ice cream in a shallow airtight container in the freezer for 2-4 hours.

**IMPORTANT:** Do not store ice cream in the freeze bowl in the freezer. Prying hard ice cream out of the freeze bowl with metal scoops or utensils may damage the freeze bowl.

# USING THE ICE CREAM MAKER ATTACHMENT

## TIPS FOR GREAT RESULTS

---

- The freeze bowl must be completely frozen to make ice cream or other frozen desserts.
- For best results, store the freeze bowl in the back of your freezer where the temperature is coldest for at least 15 hours. Adjusting your freezer to its coldest setting will help the freeze bowl make firmer ice cream faster.
- Storing the freeze bowl in the freezer at all times allows you the flexibility to make your favourite frozen desserts on a whim.
- For recipes that need to be pre-cooked, allow the mixture to cool completely in the refrigerator.
- All batter recipes need to be completely chilled in the refrigerator before making ice cream.
- Most ice cream recipes call for a combination of cream, milk, eggs, and sugar. The type of cream you choose will determine how rich in flavour and how creamy the texture of the finished result. The higher percentage of fat in the cream, the richer and creamier your ice cream will be. Any combination can be used, as long as the liquid measurement stays the same. Lighter ice creams can be made by using more milk than cream, or by eliminating cream. Skim milk will work, but there will be a noticeable difference in texture.
- When mixing an ice cream recipe that calls for solid ingredients such as fruits, nuts, candies, or chocolate chips, it is best to wait until the final two minutes of the mixing process to add them.
- Ice cream making is a two-part process: conversion and ripening. Mixing batter into ice cream is the conversion process in which the ice cream consistency will be similar to soft serve. The ripening process takes place in the freezer, where the ice cream will harden over a period of 2-4 hours.
- Follow recommended mixer speeds. Faster speeds will slow the conversion process.
- Batter volume grows significantly during the conversion process.
- Initial batter volume should not exceed 46 oz. (1.4 L) to produce 2 quarts (1.9 L) of ice cream.
- Keep in mind that freezing subdues sweetness, so recipes won't taste quite as sweet once they are frozen.

<b>TYPE OF CREAM</b>	<b>FAT %</b>
Heavy Cream	36%
Whipping Cream	30%
Light Cream	18%
Half and Half	10%

# CARE AND CLEANING

## CLEANING THE ICE CREAM MAKER ATTACHMENT

**IMPORTANT:** Allow the freeze bowl to reach room temperature before attempting to clean it.

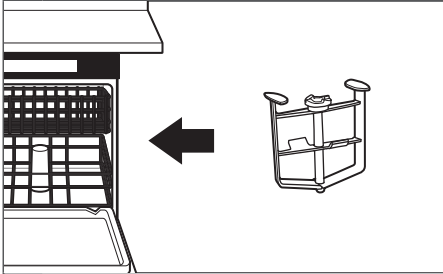

- 1 The dasher is dishwasher safe, top-rack only.

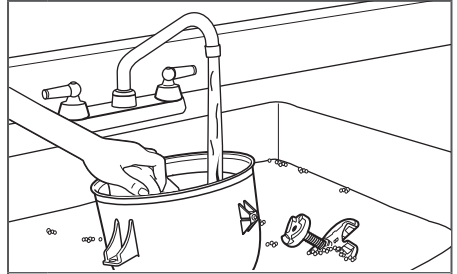

- 2 Hand wash the freeze bowl and drive assembly in warm water with mild detergent. Never wash the freeze bowl or drive assembly in the dishwasher. Thoroughly dry the freeze bowl before storing in freezer. Do not store the drive assembly in the freezer.

# RECIPES

## WARNING

### Food Poisoning Hazard

**Do not let foods that contain perishable ingredients such as eggs, dairy products, and meats remain unrefrigerated for more than one hour.**

**Doing so can result in food poisoning or sickness.**

## CARAMEL PECAN ICE CREAM

---

830 mL (3 ½ cups )  
whole milk

415 mL (1 can [14 oz.])  
sweetened  
condensed milk

235 mL (1 cup)  
prepared hot  
caramel or  
butterscotch  
caramel topping  
(about 340 g  
[12 oz.])

100 g (1 package [3.4 oz.])  
instant cheesecake  
pudding and pie  
filling mix

5 mL (1 teaspoon) vanilla

.5 mL (1/8 teaspoon) salt

235-355 mL (1-1½ cups)  
coarsely  
chopped pecans

In medium bowl, place all ingredients except pecans. Whisk until well blended and pudding is dissolved. Cover and chill thoroughly, at least 6 hours.

Assemble and engage freeze bowl, dasher, and drive assembly as directed in attachment instructions. Turn to STIR (Speed 1). Using container with spout, pour mixture into freeze bowl. Continue on STIR (Speed 1) for 15-20 minutes or until desired consistency, adding pecans during last 1 minute of freeze time. Immediately transfer ice cream into serving dishes, or freeze in an airtight container.

Yield: 16 servings (120 mL [1/2 cup] per serving).

Per Serving: About 240 cal, 5 g pro, 35 g carb, 10 g total fat, 3.5 g sat fat, 15 mg chol, 230 mg sod.

# RECIPES

## FRENCH VANILLA ICE CREAM

590 mL (2½ cups)  
half-and-half  
8 egg yolks  
235 mL (1 cup) sugar  
590 mL (2½ cups)  
whipping cream  
20 mL (4 teaspoons)  
vanilla  
.5 mL (1/8 teaspoon) salt

In medium saucepan over medium heat, heat half-and-half until very hot but not boiling, stirring often. Remove from heat; set aside.

Place egg yolks and sugar in mixer bowl. Attach bowl and wire whip to mixer. Turn to Speed 2 and mix about 30 seconds, or until well blended and slightly thickened. Continuing on Speed 2, very gradually add half-and-half; mix until blended. Return half-and-half mixture to medium saucepan; cook over medium heat until small bubbles form around edge and mixture is steamy, stirring constantly. Do not boil. Transfer half-and-half mixture into large bowl; stir in whipping cream, vanilla, and salt. Cover and chill thoroughly, at least 8 hours.

Assemble and engage freeze bowl, dasher, and drive assembly as directed in attachment instructions. Turn to STIR (Speed 1). Using a container with a spout, pour mixture into freeze bowl. Continue on STIR (Speed 1) for 15 to 20 minutes or until desired consistency. Immediately transfer ice cream into serving dishes, or freeze in airtight container.

Yield: 16 servings (120 mL [1/2 cup] per serving).

Per Serving: About 260 cal, 3 g pro, 16 g carb, 20 g total fat, 12 g sat fat, 165 mg chol, 50 mg sod.

### VARIATIONS

#### Fresh Strawberry Ice Cream

In medium bowl, combine 475 mL (2 cups) chopped, fresh strawberries (or other fresh fruit) and 10 to 15 mL (2 to 3 teaspoons) sugar, if desired. Let stand while ice cream is processing. Add during last 3 to 5 minutes of freeze time.

Yield 20 servings (120 mL [1/2 cup] per serving).

Per Serving: About 210 cal, 3 g pro, 14 g carb, 16 g total fat, 10 g sat fat, 135 mg chol, 40 mg sod.

#### Cookies 'n Cream Ice Cream

Add 355 mL (1½ cups) chopped, cream-filled chocolate sandwich cookies (or other cookies, nuts, or candy) during last 1 to 2 minutes of freeze time.

Yield 19 servings (120 mL [1/2 cup] per serving).

Per Serving: About 230 cal, 3 g pro, 16 g carb, 18 g total fat, 10 g sat fat, 140 mg chol, 70 mg sod.

# RECIPES

## CREAMY LEMON-ORANGE GELATO

---

475 mL (2 cups) reduced-fat (2%) milk  
4 (5 x 2 cm [2 x 3/4 -inch]) strips orange peel  
4 (5 x 2 cm [2 x 3/4 -inch]) strips lemon peel  
6 coffee beans  
5 egg yolks  
175 mL (3/4 cup) sugar

Scald milk with orange peel, lemon peel, and coffee beans in heavy medium saucepan.

Whisk yolks and sugar in medium bowl to blend. Gradually whisk half of milk mixture into yolks. Return yolks to saucepan with remaining milk. Stir over low heat until mixture thickens slightly and leaves path on back of spoon when finger is drawn across, about 8 minutes; do not boil. Strain into medium bowl. Refrigerate until well chilled.

Assemble and engage freeze bowl, dasher, and drive assembly as directed in attachment instructions. Turn to STIR (Speed 1). Using a container with a spout, pour mixture into freeze bowl. Continue on STIR (Speed 1) for 15 to 20 minutes or until desired consistency. Transfer ice cream to airtight container and freeze several hours to allow flavours to ripen. Can be prepared up to 4 days ahead. If frozen solid, soften slightly in refrigerator about 20 minutes before serving.

Yield: 8 servings (1/2 cup [120 mL] per serving).

Per serving: About 135 cal, 4 g pro, 21 g carb, 4 g total fat, 2 g sat fat, 133 mg chol, 30 mg sod.

# RECIPES

## FRESH RASPBERRY SORBET

1.5 L (6 cups) raspberries  
60 mL (1/4 cup) plus 30 mL (2 tablespoons) water  
295 mL (1¼ cups) Simple Syrup (recipe follows)

Combine raspberries and water in bowl of food processor fitted with metal blade. Process until very smooth; pour through fine mesh strainer, pressing down lightly on solids trapped in strainer to extract as much liquid as possible without forcing solids through strainer. Discard solids. Pour liquid into airtight container and refrigerate until thoroughly chilled, at least 8 hours.

Assemble and engage freeze bowl, dasher, and drive assembly as directed in attachment instructions. Turn to STIR (Speed 1). Combine chilled raspberry juice and chilled simple syrup. Using a container with a spout, pour mixture into freeze bowl. Continue on STIR (Speed 1) for 7 to 12 minutes or until desired consistency. Immediately transfer sorbet into airtight container and freeze at least 2 hours before serving.

Yield: 8 servings (235 mL [1 cup] per serving).

Per serving: About 234 cal, 1 g pro, 59 g carb, 1 g total fat, 0 mg chol, 1 mg. sod.

### Simple Syrup

475 mL (2 cups) sugar  
475 mL (2 cups) water

Combine sugar and water in saucepan. Bring to a boil over medium-high heat; cook and stir until sugar dissolves completely, about 10 minutes. Transfer to ice bath, stirring until well chilled. Refrigerate until ready to use.

## OTHER SORBETS

**TIP:** Substitute the following quantities of ingredients for the ingredients listed above to make these sorbets.

FLAVOUR	FRUIT	PLUS WATER	PLUS SIMPLE SYRUP
Lemon	475 mL (2 cups) lemon juice	None	295 mL (1¼ cups)
Mango	475 mL (2 cups) chopped	60 to 120 mL (1/4 to 1/2 cup)	295 mL (1¼ cups)
Kiwi	475 mL (2 cups) chopped	120 mL (1/2 cup) plus 15 mL (1 tablespoon) lime juice	295 mL (1¼ cups)
Pineapple	475 mL (2 cups) chopped	60 mL (1/4 cup) plus 15 mL (1 tablespoon) lime juice	295 mL (1¼ cups)
Blueberry	1.2 L (5 cups)	60 mL (1/4 cup) plus 15 mL (1 tablespoon) lime juice	295 mL (1¼ cups)



# RECIPES

## MINTED MANGO SHERBERT

---

235 mL (1 cup) sugar  
710 mL (2 cups)  
whole milk  
60 mL (1/4 cup)  
light corn syrup  
3 ripe mangoes, peeled,  
seeded, and  
chopped (about  
710 mL [3 cups])  
30 mL (2 tablespoons)  
fresh lime or  
lemon juice  
10 mL (2 teaspoons)  
finely chopped fresh  
mint, if desired

In medium saucepan, combine sugar, milk, and corn syrup. Heat over medium heat, stirring often, until very hot but not boiling. Remove from heat; set aside.

Place mangoes and lime juice in food processor work bowl; use the multipurpose blade to process until smooth. Add mango mixture and mint to milk mixture. Cover and chill thoroughly, at least 8 hours.

Assemble and engage freeze bowl, dasher, and drive assembly as directed in attachment instructions. Turn to STIR (Speed 1). Using a container with a spout, pour mixture into freeze bowl. Continue on STIR (Speed 1) for 7 to 12 minutes or until desired consistency. Immediately transfer sherbet into serving dishes, or freeze in an airtight container.

Yield: 14 servings (120 mL [1/2 cups] per serving).

Per Serving: About 130 cal, 2 g pro, 29 g carb,  
2 g total fat, 1 g sat fat, 5 mg chol, 30 mg sod.

# WARRANTY AND SERVICE

## KITCHENAID ICE CREAM MAKER ATTACHMENT WARRANTY

Length of Warranty:	KitchenAid Will Pay For:	KitchenAid Will Not Pay For:
<b>Europe, Middle East and Africa:</b> <b>5KICA0WH</b> <b>Two years full warranty from date of purchase.</b>	<b>The replacement parts and repair labour costs to correct defects in materials or workmanship. Service must be provided by an Authorised KitchenAid Service Centre.</b>	<b>A. Repairs when the Ice Cream Maker Attachment is used for operations other than normal household food preparation.</b>  <b>B. Damage resulting from accident, alterations, misuse, abuse, or installation/operation not in accordance with local electrical codes.</b>

**KITCHENAID DOES NOT ASSUME ANY RESPONSIBILITY FOR INDIRECT DAMAGES.**

## CUSTOMER SERVICE

### In U.K. and Ireland:

For any questions, or to find the nearest KitchenAid Authorised Service Centre, please find our contact details below.

**NOTE:** All service should be handled locally by an KitchenAid Authorised Service Centre.

Contact number for U.K. and Northern Ireland:

Tollfree number 0800 988 1266 (calls from mobile phones are charged standard network rate) or call 0194 260 5504

Contact number for Ireland:

Tollfree number +44 (0) 20 8616 5148

E-mail contact for U.K. and Ireland:

Go to [www.kitchenaid.co.uk](http://www.kitchenaid.co.uk), and click on the link "Contact Us" at the bottom of the page.

Address for U.K. and Ireland:

KitchenAid Europa, Inc.  
 PO BOX 19  
 B-2018 ANTWERP 11  
 BELGIUM

General hotline number:  00800 3810 4026

### In other countries:

For all product related questions and after sales matters, please contact your dealer to obtain the name of the nearest Authorised KitchenAid Service/Customer Centre.

**For more information, visit our website at:**

**[www.KitchenAid.co.uk](http://www.KitchenAid.co.uk)**  
**[www.KitchenAid.eu](http://www.KitchenAid.eu)**

©2017 KitchenAid. All rights reserved. KITCHENAID and the design of the stand mixer are trademarks in the U.S. and elsewhere.

# **KitchenAid**

©2017 All rights reserved. KITCHENAID and the design of the stand mixer are trademarks in the U.S. and elsewhere.

## Free Manuals Download Website

<http://myh66.com>

<http://usermanuals.us>

<http://www.somanuals.com>

<http://www.4manuals.cc>

<http://www.manual-lib.com>

<http://www.404manual.com>

<http://www.luxmanual.com>

<http://aubethermostatmanual.com>

Golf course search by state

<http://golfingnear.com>

Email search by domain

<http://emailbydomain.com>

Auto manuals search

<http://auto.somanuals.com>

TV manuals search

<http://tv.somanuals.com>