



KitchenAid

Stand Blender
5KSB4026A
5KSB4027A





PARTS AND FEATURES

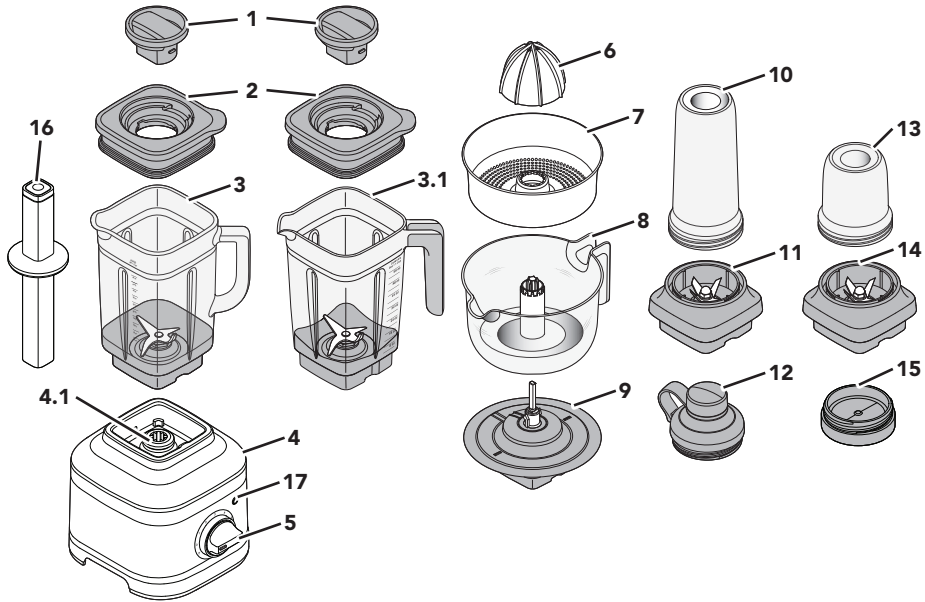

- | | | | |
|-----|---------------------------------|----|--------------------------------------|
| 1 | Lid Centre Cap | 9 | Gear Assembly* |
| 2 | Lid with Vent Well | 10 | Personal Jar** (0.5 L capacity) |
| 3 | Glass Jar**** (1.4 L capacity) | 11 | Blade Assembly of Personal Jar** |
| 3.1 | Jar (1.6 L capacity) | 12 | Personal Jar Easy-Drink Lid** |
| 4 | Base | 13 | Small Batch Jar*** (0.2 L capacity) |
| 4.1 | Interlock | 14 | Blade Assembly of Small Batch Jar*** |
| 5 | Control Dial | 15 | Small Batch Jar Lid*** |
| 6 | Reamer* | 16 | Tamper |
| 7 | Pulp Strainer/Basket* | 17 | START/STOP Button with LED Ring |
| 8 | Juice Container* (1 L capacity) | | |

*Accessories only included with Citrus Press models.

**Accessories only included with Personal Jar models.

***Accessories only included with Small Batch Jar models.

****Accessories only included with Glass Jar Blender models.





PRODUCT SAFETY

Your safety and the safety of others are very important.

We have provided many important safety messages in this manual and on your appliance. Always read and obey all safety messages.



This is the safety alert symbol.

This symbol alerts you to potential hazards that can kill or hurt you and others.

All safety messages will follow the safety alert symbol and either the word “DANGER” or “WARNING.” These words mean:

! DANGER

You can be killed or seriously injured if you don't immediately follow instructions.

! WARNING

You can be killed or seriously injured if you don't follow instructions.

All safety messages will tell you what the potential hazard is, tell you how to reduce the chance of injury, and tell you what can happen if the instructions are not followed.

IMPORTANT SAFEGUARDS

When using electrical appliances, basic safety precautions should always be followed, including the following:

1. Read all instructions. Misuse of appliance may result in personal injury.
2. To protect against risk of electrical shock do not put the Stand Blender Base in water or other liquid.
3. This appliance is not intended for use by persons (including children) with reduced physical, sensory or mental capabilities, or lack of experience and knowledge, unless they have been given supervision or instruction concerning use of the appliance by a person responsible for their safety.
4. Children should be supervised to ensure that they do not play with the appliance.
5. Turn the appliance OFF, then unplug from the outlet when not in use, before assembling or disassembling parts and before cleaning. To unplug, grasp the plug and pull from the outlet. Never pull from the power cord.
6. Avoid contacting moving parts.
7. Do not operate any appliance with a damaged cord or plug, or after the appliance malfunctions, or is dropped or damaged in any manner. Return appliance to the nearest Authorised Service Facility for examination, repair, or electrical or mechanical adjustment.
8. Do not use outdoors.
9. Do not let cord hang over edge of table or counter.
10. Keep hands and utensils other than the provided tamper, out of container while blending to reduce the risk of severe injury to persons or damage to the Blender. The cover must remain in place when using the tamper through the cover opening. A scraper may be used but must be used only when the Blender is not running.
11. Blades are sharp. Care should be taken when handling the sharp cutting blades, emptying the jar and during cleaning.





PRODUCT SAFETY

12. Be careful if hot liquid is poured into the blender as it can be ejected out of the appliance due to sudden steaming.
13. If the supply cord is damaged, it must be replaced by the manufacturer, its service agent or similarly qualified persons in order to avoid a hazard.
14. Refer to the “Care and Cleaning” section for instructions on cleaning the surfaces in contact with food.
15. Always operate the Blender with cover in place.
16. When blending hot liquids or ingredients, Lid Centre Cap shall remain in place over the lid opening. Always start on lowest speed and slowly ramp to desired speed when blending hot liquids or ingredients.
17. Do not blend hot liquids and ingredients in the Personal Jar or Small Batch Jar.
18. To reduce the risk of injury, never place cutter-assembly blades on Base without Personal Jar or Small Batch Jar properly attached.
19. The use of attachments, including canning jars, not recommended or sold by the manufacturer may cause a risk of injury to persons.
20. This appliance is intended to be used in household and similar applications such as:
 - staff kitchen areas in shops, offices, or other working environments;
 - farmhouses;
 - by clients in hotels, motels and other residential type environments;
 - bed and breakfast type environments.

SAVE THESE INSTRUCTIONS

ELECTRICAL REQUIREMENTS

WARNING



Electrical Shock Hazard

Plug into an earthed outlet.

Do not remove earth prong.

Do not use an adapter.

Do not use an extension cord.

Failure to follow these instructions can result in death, fire, or electrical shock.

Voltage: 220-240 VAC

Frequency: 50-60 Hz

NOTE: If the plug does not fit in the outlet, contact a qualified electrician. Do not modify the plug in any way. Do not use an adapter.

Do not use an extension cord. If the power supply cord is too short, have a qualified electrician or serviceman install an outlet near the appliance.

The power rating of your Stand Blender is printed on the serial plate.

The maximum rating is based on the attachment that draws the greatest load (power). Other recommended attachments may draw significantly less power.









PRODUCT SAFETY





MOTOR HORSEPOWER

Motor horsepower for the blender motor was measured using a dynamometer, a machine that laboratories routinely use to measure the mechanical power of motors. Our 1.5 peak horsepower (HP) motor reference reflects the horsepower output of the motor itself and not the Blender's horsepower output in the blender jar. As with any blender, the power output in the jar is not the same as the horsepower of the motor itself.

GET STARTED

BLENDER FUNCTION GUIDE

It features variable speeds (from 1 to 5) and Pulse (P) function to customize blending. Also, pre-programmed recipe settings like, Ice Crush (), Icy Drink () and, Smoothie () are designed to deliver optimal results. Use the self-cleaning cycle () after blending for easy clean up. We encourage you to experiment to find the best speed for your favorite recipes.

Setting	Description	Blending Time (min:sec)	Suggested Items to Blend
Pulse P	Allows precise control of the duration and frequency of blending.	Manual	Salsa, crumb topping, chopped nuts, fruits or vegetables & more.
Variable speeds 1 - 5	Manual speeds offer ultimate control of the Blender.	3:00	Fruits, Soups, Sauces, Doughs, Vegetables, Butters, Nuts, Dips, Frozen desserts, Purees.
Ice Crush 	The Blender runs at optimal speed to crush ice.	00:30	To crush and chop ice without adding any liquid ingredients.
Icy Drink 	Gradually ramp up to full power to blend hard foods.	00:30	Ice, whole fruits or vegetables, or frozen fruits. Use for drinks as Margaritas, Daiquiris, and blended ice coffee drinks.
Smoothie 	The Blender will operate at the high speed to make puree of items or ingredients.	00:45	Fruits, vegetables, ice cream and yoghurt into thick smoothie, blended drinks and milkshakes, etc.
Clean 	Quick pulses of power and high speeds work to clean the Blender jar.	00:45	Half of the Jar filled with warm water and 1-2 drops of dish soap.

BLENDER ACCESSORY GUIDE

Accessories	Capacity	Speed	Suggested Items to Blend
Blender Jar	1.6 L	All Speeds, Pulse, and Preset recipes	Full recipe smoothie, icy drinks, shakes / malts, dips, spreads and more.
Glass Blender Jar	1.4 L		
Personal Jar	0.5 L		Individual smoothies, icy drinks, shakes / malts and lower volume recipes.
Small Batch Jar	0.2 L		Small volume recipes - Purees, sauces, baby food, dressings, marinades, pesto and more.
Citrus Press	1 L	Speed 1	Citrus juice, Grapefruit juice and more.



USING THE BLENDER

Before first use, clean all parts and accessories (see "Care and Cleaning" section).
Be sure the countertop beneath the Blender and surrounding areas are dry and clean.

IMPORTANT : When moving your Blender, always support/lift from Blender Base.
Base will become disengaged from jar if carried by Blender jar or Blender jar handle only.

⚠ WARNING

Electrical Shock Hazard



Plug into an earthed outlet.

Do not remove an earth prong.

Do not use an adapter.

Do not use an extension cord.

Failure to follow these instructions can result in death, fire, or electrical shock.

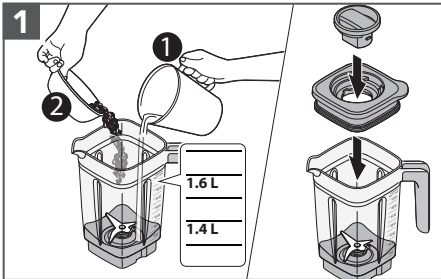

1 Add ingredients into Jar
(max. 1.6 L or 1.4 L for Glass Jar).
Secure the Lid and Lid Centre Cap.

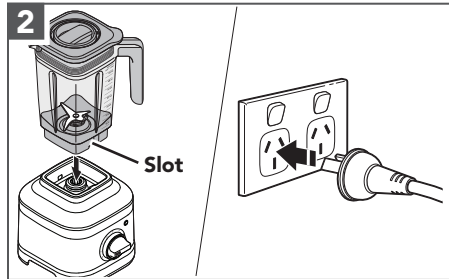

2 Place and align the Jar with the Slot to fit inside the jar pad, facing Jar handle towards Control Dial.
Plug the Blender into an earthed outlet.

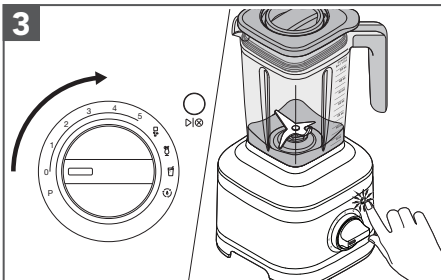

3 Turn from (O) to desired speed or preset recipe programme. Press (▶|⊗) to START.
See "Blender Function Guide" for more details.

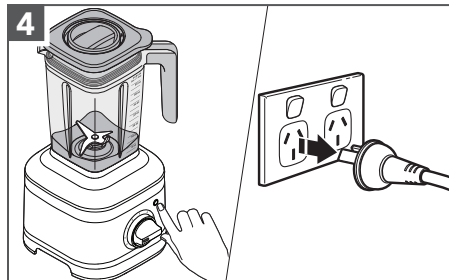

4 When finished, press (▶|⊗) to STOP.
Unplug before removing the Blender Jar.

NOTE: For variable speeds (from 1 to 5), the Blender will stop automatically after 3 minutes of run time. For preset recipe programmes, the Blender will automatically stop blending once the cycle is complete.



USING THE BLENDER

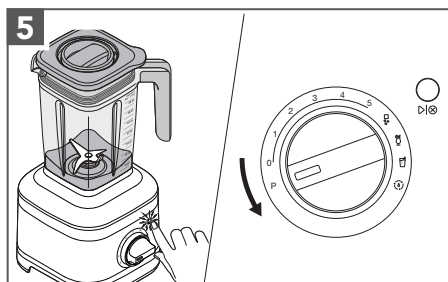

5 **Pulse mode:** Press (▷|⊗). Turn and hold the Control Dial from (O) to (P) as per desired interval of time.

When finished, release the Control Dial to STOP.



6 **Tamper Accessory:** Remove the Lid Centre Cap only. Stir or press contents down towards the blade. Then, place the Lid Centre Cap back before resuming blending.

NOTE: If blending hot liquids and ingredients, start on a low speed and then ramp up to the desired speed. Use variable speed and run for 1-2 minutes.

NOTE: Blender will automatically stop when removing the Jar from Base.

IMPORTANT: Allow the Blender to fully stop before removing the Lid, Blender Jar, or pouring out blended ingredients.

USING THE PERSONAL JAR/SMALL BATCH JAR

The Personal Jar is perfect in size for single servings or smaller recipes and handy to carry with you on the go. And, the Small Batch Jar is perfect for smaller recipes like sauces, dressings, marinades and more.

IMPORTANT: Do not blend hot liquids and ingredients in the Personal Jar.

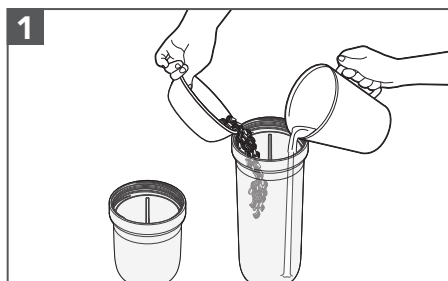

1 **Personal Jar:** Add ingredients (max. 0.5 L). Add ice or frozen items, then leafy greens, then soft foods and liquids at last.
Small Batch Jar: Add ingredients (max. 0.2 L).

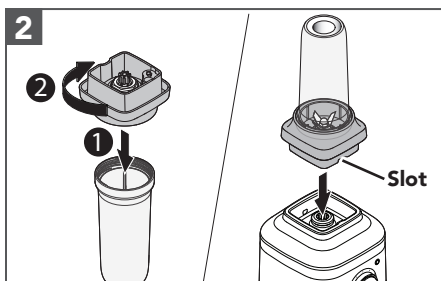

2 Secure the Blade Assembly on the Jar and rotate it clockwise until it is tight. Place it on the Base.





USING THE PERSONAL JAR/SMALL BATCH JAR

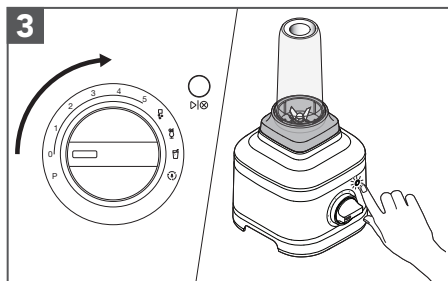

Turn from (0) to desired speed or preset recipe programme. Press (▶|⊗) to start. See “Blender Function Guide” for more details.

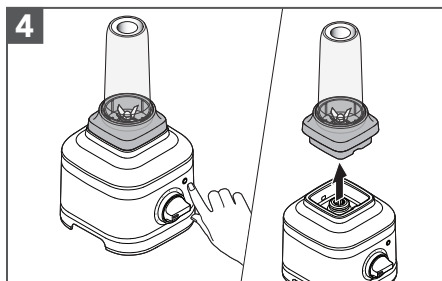

Press (▶|⊗) to stop. Always remove the Personal Jar or Small Batch Jar with Blade Assembly from the Base.

USING THE CITRUS PRESS

Before first use, clean all parts and accessories (see “Care and Cleaning” section).

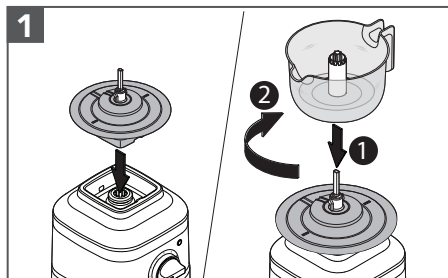

Place the Gear Assembly on Base. Place the Juice Container on the Gear Assembly and twist clockwise to lock in place.

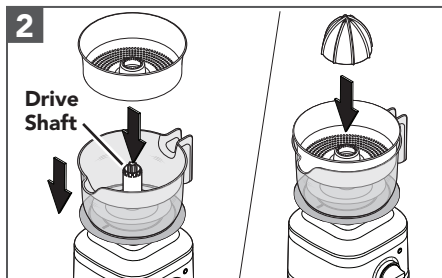

Place the Pulp Basket and then the Reamer into the Juice Container by aligning them with the Drive Shaft.

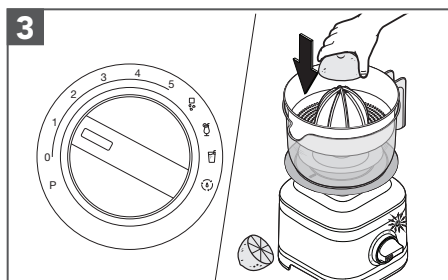

Turn from (0) to speed 1 or 2. Hold down the halved citrus fruit on the Reamer. Press (▶|⊗) to start.

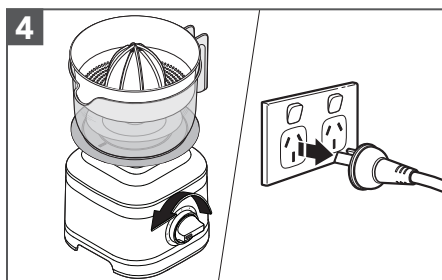

Press (▶|⊗) button to stop. Turn the Control Dial to (0). Unplug the Blender.





USING THE CITRUS PRESS

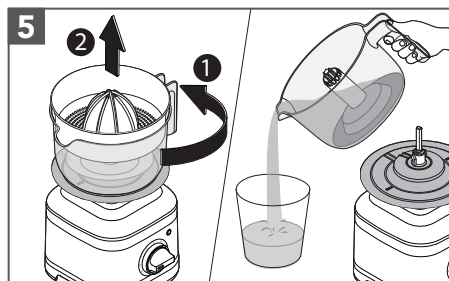

Twist the Juice Container counterclockwise and lift it by using handle. Pour and enjoy!

IMPORTANT: Allow the Blender to fully stop before removing the Reamer, Juice Container, or pouring out the juice.

CARE AND CLEANING

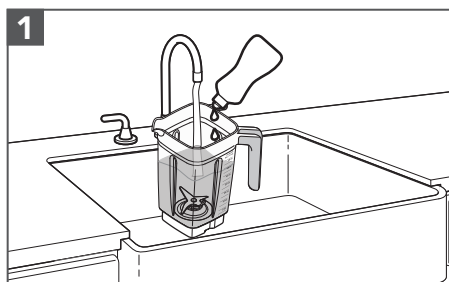

Fill half of the Jar with warm water and add 1 or 2 drops of dish-washing liquid. Place the Jar on the Base. Secure the Lid and Lid Centre Cap.

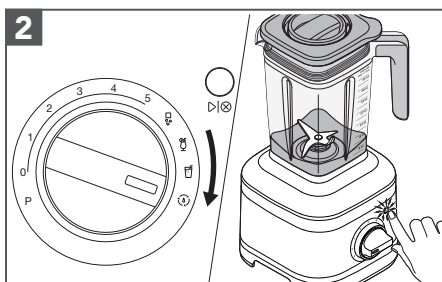

Turn from (O) to (Start). Press (Start) to START. When cycle ends, remove the Jar and empty contents and rinse with warm water and dry thoroughly.

NOTE: Do not immerse the Blender Base or Cord in water. Do not use abrasive cleansers or scouring pads to avoid scratching.

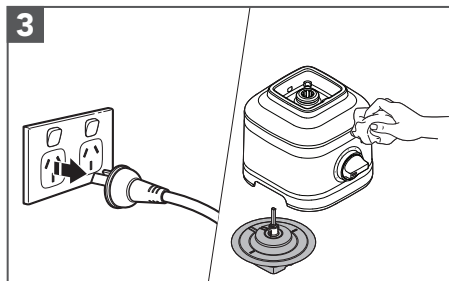

Unplug the Blender before cleaning. Wipe clean the Base, Power Cord and the Gear Assembly of the Citrus Press with a warm, damp cloth and dry with a soft cloth.

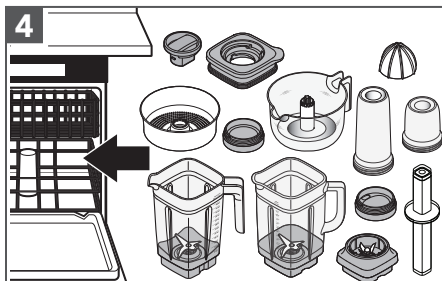

Dishwasher-safe, top rack only: Personal Jar, Small Batch Jar, Lids, Blade Assembly, Reamer, Juice Container, Pulp Basket, Tamper, and Lid Centre Cap. Blender Jar and Glass Jar can also be washed in the bottom rack.





TROUBLESHOOTING GUIDE



⚠ WARNING

Electrical Shock Hazard

Plug into an earthed outlet.

Do not remove an earth prong.

Do not use an adapter.

Do not use an extension cord.

Failure to follow these instructions can result in death, fire, or electrical shock.

Problem	Solution
If Blender fails to start:	<p>Check to see if the Blender is securely plugged into an earthed electrical outlet.</p> <p>If you have a circuit breaker box, make sure the circuit is closed.</p>
If Blender stops after 3 minutes:	<p>It's a part of the Blender operation to ensure lasting durability. Turn the Control Dial to (O) and repeat the process until desired consistency.</p>
If Blender stops while blending:	<p>When overloaded or jammed, it will automatically shut off to prevent motor damage. Unplug the Blender. Remove the Jar and use a spatula to rearrange ingredients.</p> <p>Or, divide contents into smaller batches. For certain recipes, adding liquid in the Jar may also reduce the load.</p>
If ingredients are stuck or not blending:	<p>Unplug the Blender. Remove the Jar from the Base, and use a spatula to rearrange ingredients in the Jar.</p>
If Blender stops while blending with Personal Jar or Small Batch Jar:	<p>Unplug the Blender. Remove the Personal Jar or Small Batch Jar with the Blade Assembly from the base. Shake it a little bit. Place it back on the base, plug in the Blender and turn it back on to continue regular use.</p>
If Blender stops while blending and the white LED ring flashes rapidly:	<p>An error is detected in the Blender.</p> <p>Contact an authorised Service Centre for assistance.</p> <p>See the "Customer Service" sections.</p>
If the white LED ring is off:	<p>After 10 minutes of no activity the Blender will go into Sleep mode. To wake up the Blender, press (▶ ⊗) button.</p>
If the problem cannot be corrected:	<p>See the "Customer Service" sections. Contact an Authorised Service Centre for assistance.</p> <p>Do not return the Blender to the retailer – retailers do not provide service.</p>





CUSTOMER SERVICE

In Australia:

For any questions, or to find the nearest Authorised KitchenAid Service Centre, please find our contact details below.

NOTE: All service should be handled locally by an Authorised KitchenAid Service Centre.

Toll free number: 1-800-990-990

Phone number: 02 49026500

Address Australia:

KitchenAid Australia Pty Ltd
6-8 Billbrooke Close
Cameron Park NSW 2285, Australia
Phone: 1-800-990-990
Mobile: 0249026500
Email: enquiries@KitchenAid.com.au

In New Zealand:

Website: www.KitchenAid.co.nz
Email: enquiries@KitchenAid.co.nz
Phone: 0800 881 200

In other countries:

For all product related questions and after-sales matters, please contact your dealer to obtain the name of the nearest Authorised KitchenAid Service/Customer Centre.

For more information, visit our website at:

www.KitchenAid.com.au



KitchenAid

©2020 All rights reserved.

W11359422C

10/20



Free Manuals Download Website

<http://myh66.com>

<http://usermanuals.us>

<http://www.somanuals.com>

<http://www.4manuals.cc>

<http://www.manual-lib.com>

<http://www.404manual.com>

<http://www.luxmanual.com>

<http://aubethermostatmanual.com>

Golf course search by state

<http://golfingnear.com>

Email search by domain

<http://emailbydomain.com>

Auto manuals search

<http://auto.somanuals.com>

TV manuals search

<http://tv.somanuals.com>