

5KSM1APC
5KSM2APC



KitchenAid

SPIRALIZER INSTRUCTIONS

TABLE OF CONTENTS

PARTS AND FEATURES	6
SPIRALIZER ATTACHMENT SAFETY	7
Important Safeguards.....	7
USING THE SPIRALIZER ATTACHMENT	9
Spiralizer Attachment Blade Chart.....	9
Attaching the Spiralizer to the Stand Mixer.....	11
Preparing to Process.....	12
CARE AND CLEANING/ TROUBLESHOOTING	14
Cleaning the Spiralizer Attachment and Accessories	14
Troubleshooting.....	14
WARRANTY AND SERVICE	15

PARTS AND FEATURES

PARTS AND ACCESSORIES

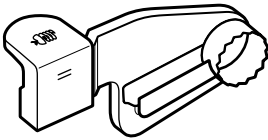

Slicing blade
(large core)

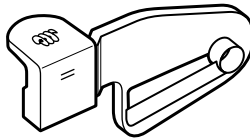

Slicing blade
(small core)

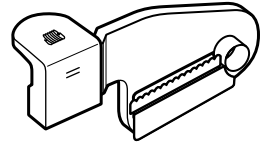

Thin slicing blade
(small core)*

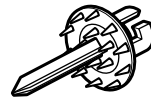
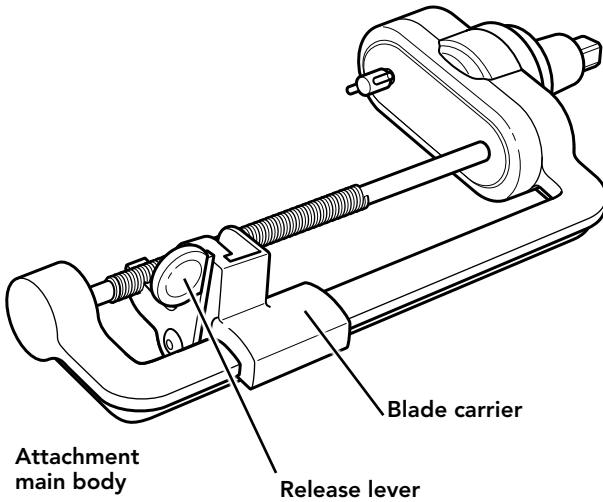

Fruit and vegetable
skewer

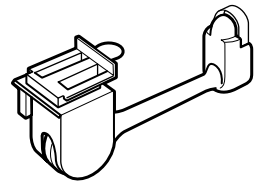

Peeling blade

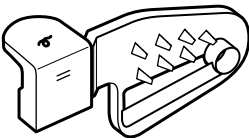

Medium spiralizing blade

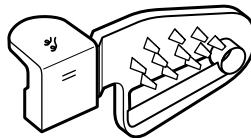

Fine spiralizing blade

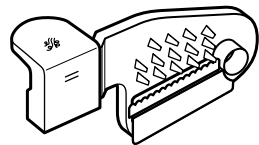

Extra fine spiralizing blade*

NOTE: Store your Spiralizer attachment and all accessories in the provided storage box. Be sure to keep out of the reach of small children.

*These blades are not included with 5KSM1APC.

IMPORTANT SAFEGUARDS

When using electrical appliances, basic safety precautions should always be followed, including the following:

1. Read all instructions. Misuse of appliance may result in personal injury.
2. To protect against risk of electrical shock, do not put Stand Mixer in water or other liquid.
3. This appliance can be used by children aged from 8 years and above and persons with reduced physical, sensory or mental capabilities or lack of experience and knowledge if they have been given supervision or instruction concerning use of the appliance in a safe way and understand hazards involved. Children shall not play with the appliance. Cleaning and user maintenance shall not be made by children without supervision.
4. This appliance is not intended for use by persons, including children, with reduced physical sensory or mental capabilities, or lack of experience and knowledge, unless they have been given supervision or instructions concerning use of the appliance in a safe way and understand the hazards involved.
5. The appliance is not to be used by children. The appliance and cord should be out of reach of children.
6. Be sure to turn the Stand Mixer off (turn speed to "0") and detach the Spiralizer attachment with peel, core, and slice from Stand Mixer after each use of the Spiralizer attachment and before cleaning. Make sure the motor stops completely before disassembling.
7. Keep hands, utensils or other objects away from the Spiralizer attachment with peel, core, and slice blades, skewer or moving parts while it is in operation to reduce the risk of severe injury to persons or damage to the Spiralizer attachment.

SPIRALIZER ATTACHMENT SAFETY

8. Never feed by hand. Always use the provided skewer.
9. If food becomes lodged in any blade or the skewer, turn the motor off and disassemble Spiralizer attachment to remove the remaining food.
10. Avoid contacting moving parts.
11. The use of attachments not recommended or sold by KitchenAid may cause fire, electric shock, or injury.
12. Close supervision is necessary when any appliance is used by or near children.
13. Do not use outdoors.
14. Do not use the appliance if the driver mechanism or rotating parts are damaged. Return appliance to the nearest Authorised Service Facility for examination, repair, or electrical or mechanical adjustment.
15. Do not let the Stand Mixer cord hang over the edge of table or counter.
16. Blades are sharp. Handle carefully when inserting or removing blades.
17. Do not remove food until Stand Mixer is OFF with speed turned to "0" and skewer stops.
18. To avoid damaging the gear assembly, do not immerse the Spiralizer attachment main assembly in water or other liquids.
19. This appliance is intended to be used in household and similar applications such as:
 - staff kitchen areas in shops, offices or other working environments;
 - farmhouses;
 - by clients in hotels, motels and other residential type environments;
 - bed and breakfast type environments.







SAVE THESE INSTRUCTIONS

USING THE SPIRALIZER ATTACHMENT

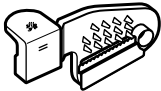
SPIRALIZER ATTACHMENT BLADE CHART

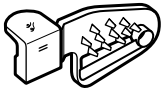
NOTE: Cut the ends off food items to ensure that the food will properly fit on the Spiralizer, and to create flat surfaces for best spiralizing, slicing, and coring results. Food should be 3.8 – 9.5 cm in diameter, and no longer than 14 cm. This step also ensures proper placement onto the fruit and vegetable skewer.

When beginning to cut, start at speed 1, then adjust to the recommended speed for your blade listed in the chart below.

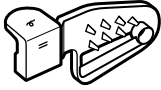
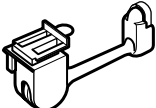
ICON	USE THESE PARTS	WITH THESE PARTS	SUGGESTED FOODS	SPEED
	EXTRA FINE SPIRALIZING BLADE* 	FRUIT AND VEGETABLE SKEWER and OPTIONAL PEELING BLADE	ZUCCHINI SWEET POTATO BEET	2
 or 	FINE SPIRALIZING BLADE 		ZUCCHINI SWEET POTATO BEET	4
 or 	MEDIUM SPIRALIZING BLADE 		ZUCCHINI SWEET POTATO POTATO	6







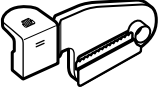

FOR DETAILED INFORMATION ON USING THE SPIRALIZER ATTACHMENT

Visit KitchenAid.eu for additional Instructions with videos, inspiring recipes, and tips on how to use your Spiralizer attachment.

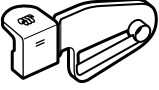
NOTE: This attachment is designed for use with a wide variety of fruits and vegetables. It is not designed for use with thick-skinned and/or soft fruits and vegetables, such as citrus and tomatoes.

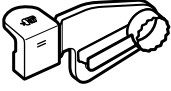
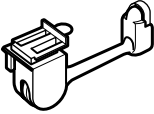
*These blades are not included with 5KSM1APC.

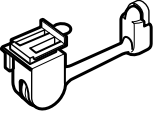
USING THE SPIRALIZER ATTACHMENT

ICON	USE THESE PARTS	WITH THESE PARTS	SUGGESTED FOODS	SPEED
	THIN SLICING BLADE (SMALL CORE)* 	FRUIT AND VEGETABLE SKEWER and OPTIONAL PEELING BLADE 	ZUCCHINI POTATO CUCUMBER	2
	SLICING BLADE (SMALL CORE) 		ZUCCHINI BEET	4
	SLICING BLADE (LARGE CORE) 		APPLE PEAR	6
	PEELING BLADE 	FRUIT AND VEGETABLE SKEWER 	POTATO APPLE	4

*These blades are not included with 5KSM1APC.

USING THE SPIRALIZER ATTACHMENT

ATTACHING THE SPIRALIZER TO THE STAND MIXER

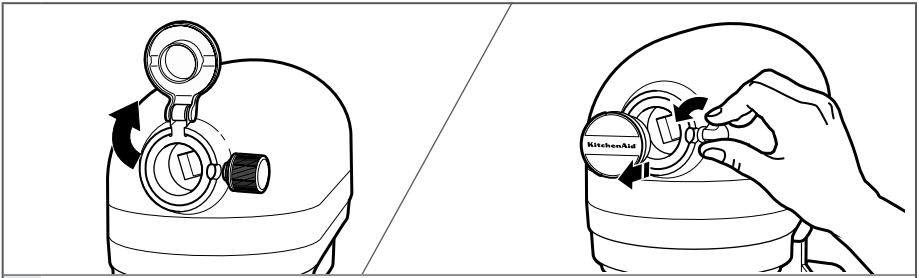

- 1 For Stand Mixers with a hinged attachment hub cover: Flip up to open.
1 For Stand Mixers with a removable attachment hub cover: Turn the attachment knob counterclockwise to remove attachment hub cover.

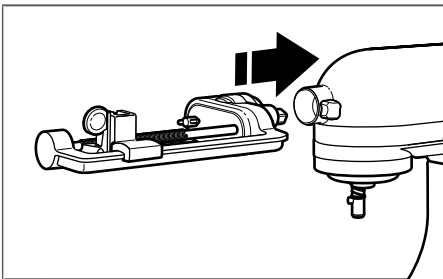

- 2 Insert the Spiralizer attachment shaft housing into the attachment hub, making certain that the power shaft fits into the square hub socket. Rotate the Spiralizer attachment back and forth if necessary. The pin on the shaft housing will slip fully into the notch on the hub rim when it's in the proper position.

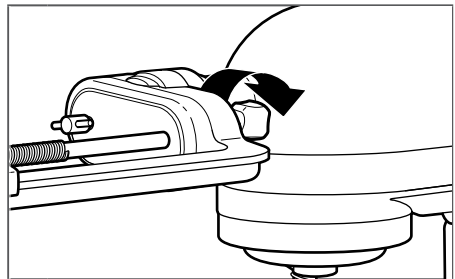

- 3 Tighten the attachment knob until the Spiralizer attachment is completely secured to the Stand Mixer. Visit KitchenAid.eu for detailed information on how to use your Spiralizer's different blades and features.

USING THE SPIRALIZER ATTACHMENT

PREPARING TO PROCESS

IMPORTANT: To prepare food before spiralizing, wash food, then remove stems, cut the ends off squarely, and remove any eyes, if applicable.

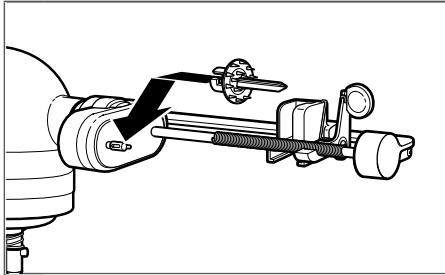

1 Install fruit and vegetable skewer by slipping onto the skewer mount, and twisting counterclockwise until it clicks into place.

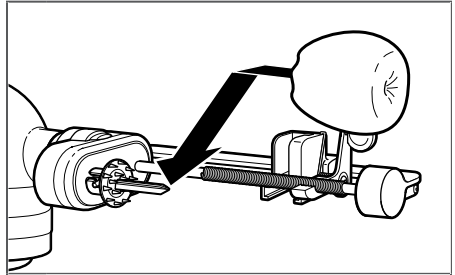

2 Place bowl or plate under the Spiralizer attachment, then affix food to the fruit and vegetable skewer.

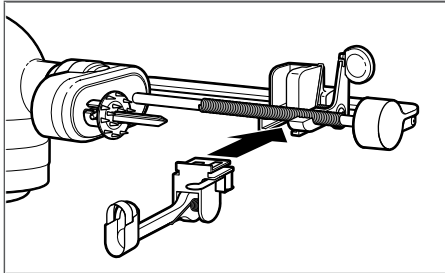

OPTIONAL: If using the peeler, install by sliding into the bottom of the blade carrier until it clicks into place.

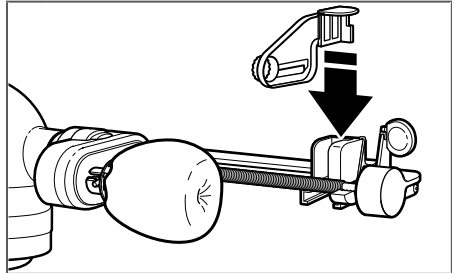

3 Install desired blade.

USING THE SPIRALIZER ATTACHMENT

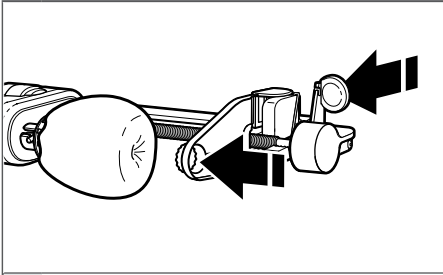

4 Pull the release lever, then push the blade carrier towards the Stand Mixer to align the blade core with the centre of the food.

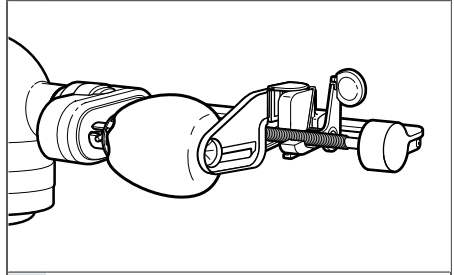

5 Press blade core into food for added stability. **IMPORTANT:** When finished, remove the blade before removing your food item.

FOR DETAILED INFORMATION ON USING THE SPIRALIZER ATTACHMENT

Visit KitchenAid.eu for additional Instructions with videos, inspiring recipes, and tips on how to use your Spiralizer attachment.

CARE AND CLEANING/TROUBLESHOOTING

CLEANING THE SPIRALIZER ATTACHMENT AND ACCESSORIES

IMPORTANT: To avoid damage, never wash or immerse the Spiralizer attachment main body in water or place in the dishwasher. The removable blades and accessories are dishwasher-safe, top rack only.

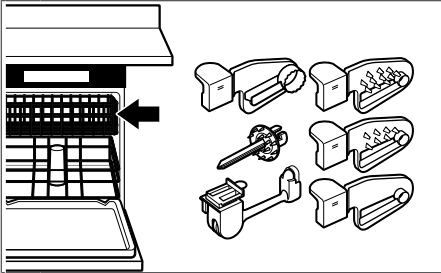

1 After using the Spiralizer, remove all blades and accessories. Wash the blades and accessory pieces by hand with a soft cloth, in warm sudsy water; or, wash in the top rack of the dishwasher.

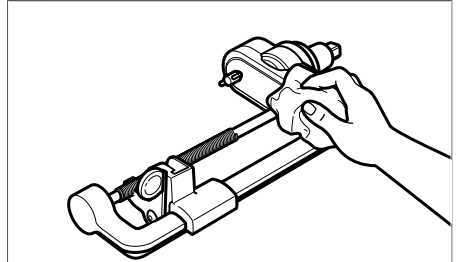

2 Clean the Spiralizer attachment main body by hand only. Wash with a soft, damp cloth. Dry thoroughly with a soft dry cloth. Do not wash in the dishwasher. Do not immerse in water.

NOTE: After washing, store your Spiralizer attachment and all accessories in the provided storage box. Be sure to keep out of the reach of small children.

TROUBLESHOOTING

If your Stand Mixer should malfunction or fail to operate while using the Spiralizer attachment, please check the following:

- Did you follow the preparation suggestions in the "Spiralizer attachment blade" chart?
- Did you choose a blade recommended for the type of food you are spiralizing?
- Is the Stand Mixer plugged in? Refer to the "Instructions" manual that came with your Stand Mixer to find possible solutions.

- Is the fuse in the circuit to the Stand Mixer in working order? Refer to the "Instructions" manual that came with your Stand Mixer to find possible solutions.

If the problem is not due to one of the above items, see the "Customer service" section in the "Warranty".

Do not return the Spiralizer attachment or the Stand Mixer to the retailer, as they do not provide service.

WARRANTY AND SERVICE

KITCHENAID SPIRALIZER WARRANTY

Length of Warranty:	KitchenAid Will Pay For:	KitchenAid Will Not Pay For:
Europe, Middle East and Africa: 5KSM1APC and 5KSM2APC Two years full warranty from date of purchase.	The replacement parts and repair labour costs to correct defects in materials or workmanship. Service must be provided by an Authorised KitchenAid Service Centre.	A. Repairs when Stand Mixer accessory is used for operations other than normal household food preparation. B. Damage resulting from accident, alterations, misuse, abuse, or installation/operation not in accordance with local electrical codes.

KITCHENAID DOES NOT ASSUME ANY RESPONSIBILITY FOR INDIRECT DAMAGES.

CUSTOMER SERVICE

In U.K. and Ireland:

For any questions, or to find the nearest KitchenAid Authorised Service Centre, please find our contact details below.

NOTE: All service should be handled locally by an Authorised KitchenAid Service Centre.

Contact number for U.K. and Northern Ireland:

Tollfree number 0800 988 1266 (calls from mobile phones are charged standard network rate) or call 0194 260 5504

Contact number for Ireland:

Tollfree number +44 (0) 20 8616 5148

E-mail contact for U.K. and Ireland:

Go to www.kitchenaid.co.uk, and click on the link "Contact Us" at the bottom of the page.

Address for U.K. and Ireland:

KitchenAid Europa, Inc.
PO BOX 19
B-2018 ANTWERP 11
BELGIUM

General hotline number:  00800 3810 4026

In other countries:

For all product related questions and after sales matters, please contact your dealer to obtain the name of the nearest Authorised KitchenAid Service/Customer Centre.

For more information, visit our website at:

www.KitchenAid.co.uk
www.KitchenAid.eu

©2016 All rights reserved. KITCHENAID and the design of the Stand Mixer are trademarks in the U.S. and elsewhere.

KitchenAid

©2016 All rights reserved. KITCHENAID and the design of the Stand Mixer are trademarks in the U.S. and elsewhere.

Free Manuals Download Website

<http://myh66.com>

<http://usermanuals.us>

<http://www.somanuals.com>

<http://www.4manuals.cc>

<http://www.manual-lib.com>

<http://www.404manual.com>

<http://www.luxmanual.com>

<http://aubethermostatmanual.com>

Golf course search by state

<http://golfingnear.com>

Email search by domain

<http://emailbydomain.com>

Auto manuals search

<http://auto.somanuals.com>

TV manuals search

<http://tv.somanuals.com>