

# Use and Care Guide

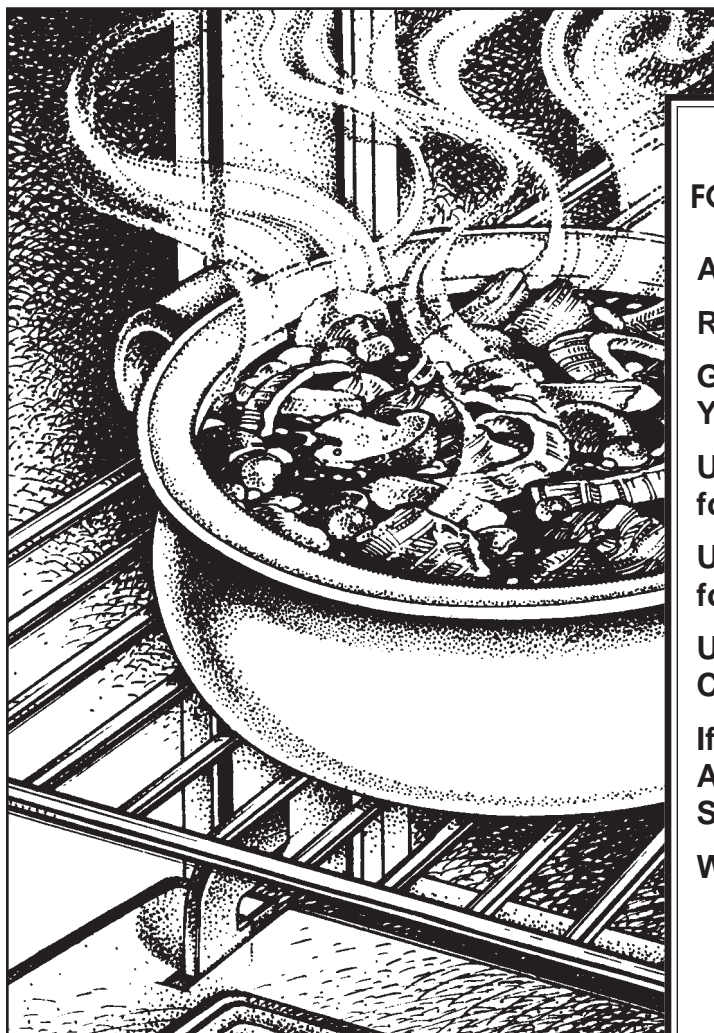

**KitchenAid®**  
FOR THE WAY IT'S MADE.™

A Note to You .....	2
Range Safety .....	3-5
Getting to Know Your Range .....	6
Using and Caring for Your Cooktop .....	9
Using and Caring for Your Oven .....	15
Using the Self- Cleaning Cycle .....	47
If You Need Assistance or Service .....	51
Warranty .....	56

**1-800-422-1230**

Call us with questions  
or comments.

**KITCHENAID®**  
**THERMAL-CONVECTION™ Electric Ranges**

**Models: KERC507  
KERH507**

# A Note to You

*Thank you* for buying a KITCHENAID® appliance!

KitchenAid designs the best tools for the most important room in your house. To ensure that you enjoy many years of trouble-free operation, we developed this Use and Care Guide. It contains valuable information concerning how to operate and maintain your new appliance properly and safely. Please read it carefully.

Also, please complete and mail the enclosed Product Registration Card.

## Please record your model's information.

Whenever you call our Consumer Assistance Center at **1-800-422-1230** or request service for your appliance, you need to know your complete model number and serial number. You can find this information on the model and serial number plate (see diagram on page 6 for location of plate).

Please also record the purchase information.

**NOTE:** You must provide proof of purchase or installation date for in-warranty service.

**Keep this book and the sales slip together in a safe place for future reference.**

**Model Number** \_\_\_\_\_

**Serial Number** \_\_\_\_\_

**Purchase/  
Installation Date** \_\_\_\_\_

**Builder/Dealer  
Name** \_\_\_\_\_

**Address** \_\_\_\_\_

**Phone** \_\_\_\_\_

# Range Safety

## IMPORTANT SAFETY INSTRUCTIONS

Your safety is important to us.

This guide contains safety symbols and statements. Please pay special attention to these symbols and follow any instructions given. Here is a brief explanation of the use of the symbol.



This symbol alerts you to hazards such as fire, electrical shock, or other injuries.

### **WARNING**

To reduce the risk of fire, electrical shock, injury to persons, or damage when using the range, follow basic precautions, including the following:

#### General

- Read all instructions before using the range.
- Install or locate the range only in accordance with the provided Installation Instructions. The range must be installed by a qualified installer. The range must be properly connected to electrical supply and grounded.



- **WARNING:** To reduce the risk of tipping the appliance, the appliance must be secured by a properly installed anti-tip bracket. To check if the bracket is installed properly, see "The anti-tip bracket" on page 8.
- **CAUTION:** Do not store things children might want above the range. Children could be burned or injured while climbing on it.
- Do not leave children alone or unattended in area where the range is in use. They should never be allowed to sit or stand on any part of the range. They could be burned or injured.

- Do not use the range for warming or heating the room. Persons could be burned or injured, or a fire could start.
- Use the range only for its intended use as described in this manual.



- Do not touch surface units, areas near units, heating elements, or interior surfaces of oven. Surface units and heating elements may be hot even though they are dark in color. Areas near surface units and interior surfaces of an oven become hot enough to cause burns. During and after use, do not touch, or let clothing or other flammable materials contact surface units, areas near units, heating elements, or interior surfaces of oven until they have had sufficient time to cool. Other surfaces of the range, such as the oven vent opening, the surface near the vent opening, the cooktop, and the oven door and window, could also become hot enough to cause burns.



- Do not operate the range if it is damaged or not working properly.



- Do not wear loose or hanging garments when using the range. They could ignite if they touch a hot surface unit and you could be burned.
- Use only dry pot holders. Moist or damp pot holders on hot surfaces could result in burns from steam. Do not let pot holder touch hot heating elements. Do not use a towel or bulky cloth for a pot holder. It could catch on fire.
- Keep range vents unobstructed.
- Do not heat unopened containers. They could explode. The hot contents could cause burns and container particles could cause injury.
- Use only cookware approved for oven use. Follow cookware manufacturer's instructions, especially when using glass or plastic cookware.
- Do not store flammable materials on or near the range. The fumes could create an explosion and/or fire hazard.
- Do not repair or replace any part of the range unless specifically recommended in this manual. All other servicing should be referred to a qualified technician.
- Disconnect the electrical supply before servicing the range.

## When using the cooktop

- Do not cook on a broken ceramic glass cooktop. If cooktop should break, cleaning solutions and spillovers could penetrate the broken cooktop and create a risk of electrical shock. Contact a qualified technician immediately.
- Select a pan with a flat bottom that is about the same size as the surface unit. If pan is smaller than the surface unit, some of the heating element will be exposed and could result in the igniting of clothing or pot holders. Correct pan size also improves cooking efficiency.
- Check to be sure glass cookware is safe for use on the range. Only certain types of glass, glass-ceramic, ceramic, earthenware, or other glazed cookware are suitable for cooktops without breaking due to the sudden change in temperature.
- Never leave surface units unattended at high heat settings. A boilover could result and cause smoking and greasy spillovers that could ignite.

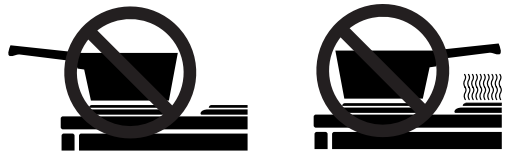

- Turn pan handles inward, but not over other surface units. This will help reduce the chance of burns, igniting of flammable materials, and spills due to bumping of the pan.

- Grease is flammable. Do not allow grease to collect around cooktop or in vents. Wipe spills immediately.



- Do not use water on grease fires. Never pick up a flaming pan. Smother flaming pan on range by covering with a well-fitting lid, cookie sheet, or flat tray. Flaming grease outside of pan can be extinguished with baking soda or, if available, a multipurpose dry chemical or foam-type extinguisher.
- Clean ceramic glass cooktop with care. Some cleaners could produce noxious fumes if applied to a hot surface. If a wet paper towel is used to wipe spills on a hot cooking area, be careful to avoid steam burns.

### **When using the oven**

- Always position oven rack(s) in desired location while oven is cool. If a rack must be removed while oven is hot, do not let pot holder contact hot heating elements in oven.
- Use care when opening oven door. Let hot air or steam escape before removing or replacing food.

- Small amounts of formaldehyde and carbon monoxide are given off in the Self-Cleaning cycle from fiberglass insulation and food decomposition. Significant exposure to these substances could cause cancer or reproductive harm. Exposure can be minimized by venting with a hood or open window and wiping out excess food spills prior to self-cleaning.



- Do not use oven cleaners. No commercial oven cleaner or oven liner protective coating of any kind should be used in or around any part of the oven.
- Before self-cleaning the oven, remove broiler pan, broiler grid, oven racks, and other cookware. Do not use your oven to clean miscellaneous parts unless you are instructed to do so in this Use and Care Guide.
- Do not clean door gasket. It is essential for a good seal. Care should be taken not to rub, damage, or move the gasket. Clean only parts recommended in this Use and Care Guide.

**– SAVE THESE INSTRUCTIONS –**

# Getting to Know Your Range

This section tells you what features your range has and where they are located. It also discusses some safety and convenience features that you should know about, but which are not needed to operate the range. Please review this information before using your range.

## Feature locations

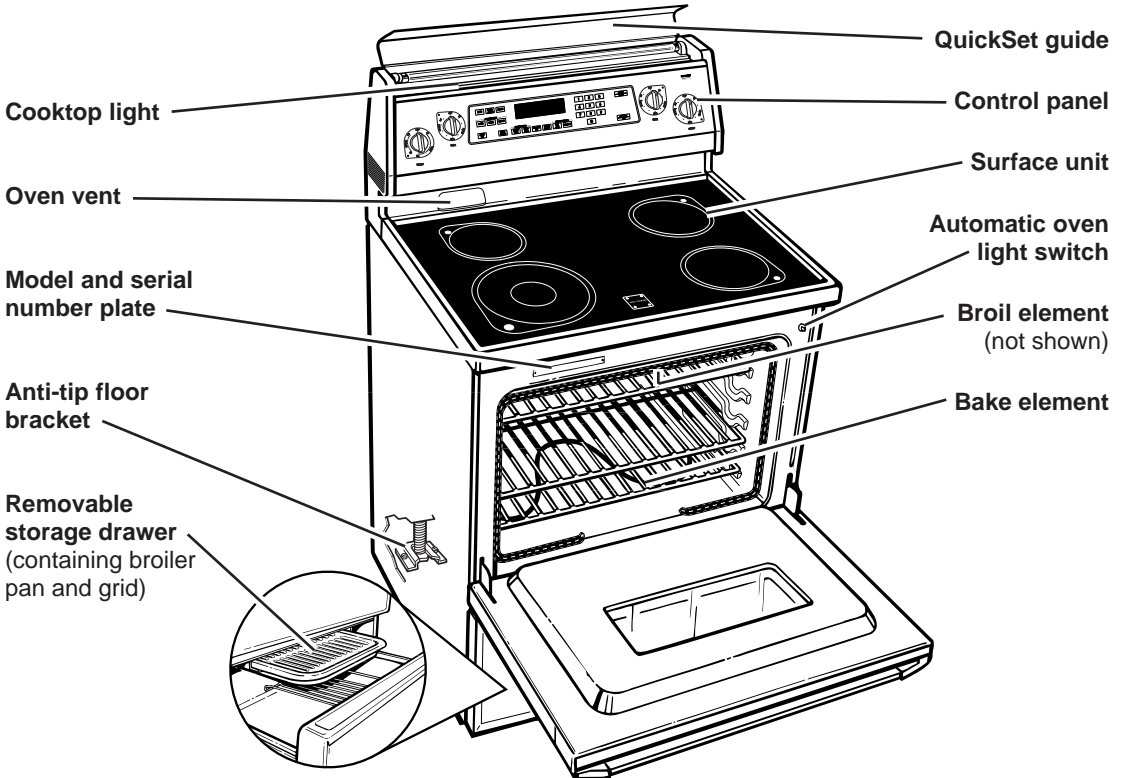

## Control panel

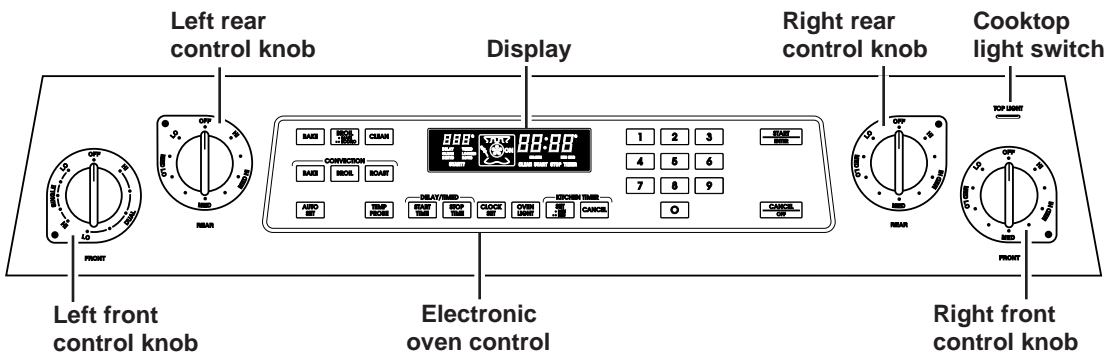



## The oven vent

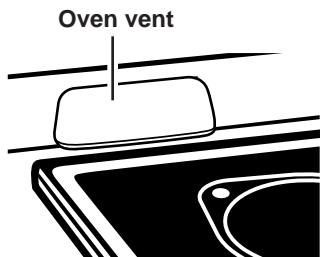

Hot air and moisture escape from the oven through a vent on the lower left side of the backguard. **Do not block the vent by using large pans or covers.** Poor baking/roasting can result.

## ⚠ WARNING



### Burn Hazard

**Use pot holders when touching items left near oven vent.**

**Failure to do so can result in burns.**

## The storage drawer

You can remove the storage drawer to make it easier to clean under the range and to check for installation of the anti-tip bracket. **Use care when handling the drawer.**

### Removing the storage drawer:

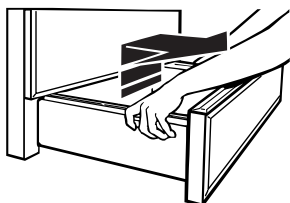

1. **Empty** drawer of any pots and pans before removing drawer. **Use** recessed area on top edge of drawer to pull drawer straight out to the first stop. **Lift** front and **pull out** to the second stop.
2. **Lift** back slightly and **slide** drawer all the way out.

### Replacing the storage drawer:



Drawer slide rail

1. **Fit** ends of drawer slide rails into the drawer guides on both sides of opening.
2. **Lift** drawer front and **press in** until metal stops on drawer slide rails clear white stops on drawer guides. **Lift** drawer front again to clear second stop and **slide** drawer closed.



## The anti-tip bracket

The range will not tip during normal use. However, tipping can occur if you apply too much force or weight to the open door without the anti-tip bracket properly secured.

	<b>! WARNING</b>
	<p><b>Tip Over Hazard</b></p> <p><b>Connect anti-tip bracket to the range.</b></p> <p><b>Reconnect anti-tip bracket, if the range is moved.</b></p> <p><b>Do not push down on the open oven door.</b></p> <p><b>Follow the Installation Instructions.</b></p> <p><b>Do not let children climb onto the oven door.</b></p> <p><b>Failure to follow these instructions can result in death, burns, or other injury.</b></p>

To verify the anti-tip bracket is engaged:

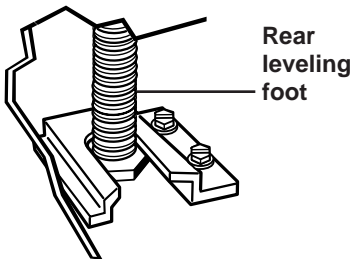

- **Remove** the storage drawer. (See page 7.)
- **Look** to see if the anti-tip bracket is attached to floor with screws.
- **Make sure** left rear leveling foot is positioned under the anti-tip bracket.
- **See** Installation Instructions for further details.



# Using and Caring for Your Cooktop

This section tells you how to operate the controls to the cooktop. It also discusses how the ceramic glass cooktop works, and includes tips on how to cook with and maintain the cooktop.

## IN THIS SECTION

Using the surface units ..... 9  
 Cookware tips ..... 11

Caring for your cooktop ..... 12  
 Using and replacing the cooktop light ..... 14

## Using the surface units

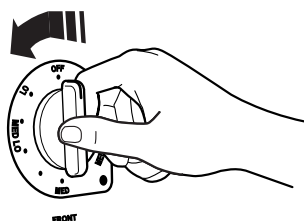

### Control knobs

Push in control knobs before turning them to a setting. Set them anywhere between HI and OFF.

### Power on lights

Each control knob has a Power On Light.

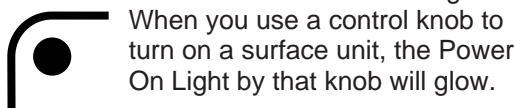

When you use a control knob to turn on a surface unit, the Power On Light by that knob will glow.

### Hot surface indicator lights

The Hot Surface Indicator Lights on the cooktop surface will glow when the surface units get hot. The Indicator Lights will continue to glow as long as the surface units are too hot to touch, even after they are turned off.

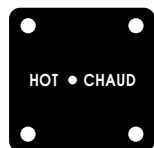

(“CHAUD” is French for “HOT”)

## ! WARNING



### Fire Hazard

Turn off all controls when done cooking.

Failure to do so can result in death, fire, or burns.

## Control setting guide

For best results, start cooking at the high setting; then turn the control knob down to continue cooking.

SETTING	RECOMMENDED USE
HI	<ul style="list-style-type: none"> <li>• To start foods cooking.</li> <li>• To bring liquids to a boil.</li> </ul>
MED HI	<ul style="list-style-type: none"> <li>• To hold a rapid boil.</li> <li>• To fry chicken or pancakes.</li> </ul>
MED	<ul style="list-style-type: none"> <li>• For gravy, pudding, and icing.</li> <li>• To cook large amounts of vegetables.</li> </ul>
MED LO	<ul style="list-style-type: none"> <li>• To keep food cooking after starting it on a higher setting.</li> </ul>
LO	<ul style="list-style-type: none"> <li>• To keep food warm until ready to serve.</li> </ul>



# Using and Caring for Your Cooktop

## Using the dual-size surface unit (some models)

You can use the left front surface unit as either a small diameter, lower wattage element or large diameter, full wattage element.

Use both elements for larger pans

Use small element for smaller pans

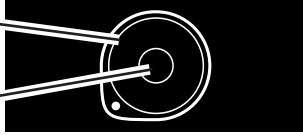

### To use the small element (for smaller pans):

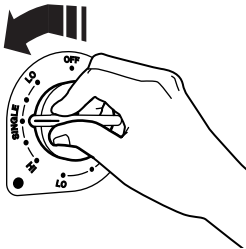

- **Push in and turn** the control knob to the left (counterclockwise) to the desired setting in the area marked "SINGLE."

### To use both elements (for larger pans):

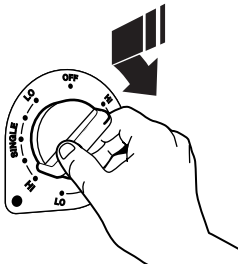

- **Push in and turn** the control knob to the right (clockwise) to the desired setting in the area marked "DUAL."

**NOTE:** You can turn the control knob in either direction to reach "OFF."

## The ceramic glass cooktop

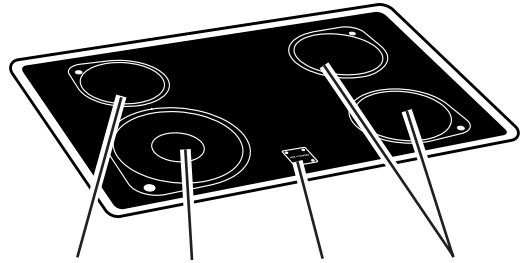

**Standard elements**   **Dual element (some models)**   **Hot surface indicator lights**   **Halogen elements (Model KERH507 only)**

Cooking on the ceramic glass cooktop is almost the same as cooking on coil surface units. There are, however, a few differences:

- **The cooking surface** area will glow red when the element is turned on. You will see the element cycling on and off – even on the HI setting – to help the area stay at the temperature setting you choose.
- **Make sure** the bottoms of pots and pans are clean and dry before cooking. Food and water particles left on the bottoms can leave deposits on the cooktop when it is heated.
- **Wiping off** the cooktop before and after each use will help keep the surface free from stains and give you the most even heating. See pages 12 and 13 for care and cleaning suggestions.
- **Do not cook** foods directly on the cooktop.
- **Lift pots and pans** onto and off of the cooktop. Sliding pots and pans on the cooktop could leave marks that are difficult to remove or could leave permanent marks.
- **Do not cook** popcorn that comes in prepackaged aluminum containers on the cooktop. The container could leave aluminum marks on the cooktop that cannot be removed completely.
- **Model KERH507:** The surface units on the right side of the cooktop feature halogen elements. These elements light up as soon as you turn them on, and are brighter than conventional coil elements.



- **Do not use** the cooktop as a cutting board.
- **Do not allow** anything that could melt, such as plastic or aluminum foil, to come in contact with the cooktop while it is hot.
- **Dropping** a heavy or hard object on the cooktop could crack it. Be careful when using heavy skillets and large pots. Do not store jars or cans above the cooktop.
- **Sugary spills** and soils can cause pitting. See pages 12 and 13 for more information.

## Cookware tips

- **Select a pan** that is about the same size as the surface unit.

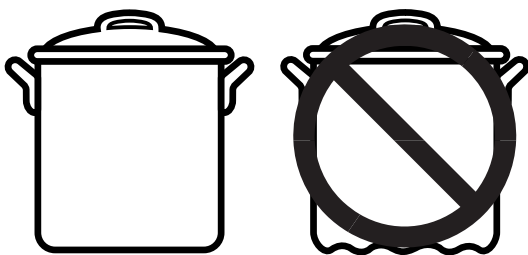

- **NOTE: For best results and greater energy efficiency**, use only flat-bottomed cookware that makes good contact with the surface units. Cookware with rounded, warped, ribbed (such as some porcelain enamelware), or dented bottoms could cause uneven heating and poor cooking results.

You can, however, use the newer cookware available with slightly indented bottoms or very small expansion channels. This cookware is specially designed to provide the good contact needed for best cooking results.

Also, woks, canners, and teakettles with flat bottoms suitable for use on your cooktop are now available in most stores that sell housewares.

- **The pan** should have straight sides and a tight-fitting lid.
- **Choose medium to heavy gauge** (thickness) pans that are fairly lightweight.
- **The pan material** (metal or glass) affects how fast heat transfers from the surface unit through the pan material and how evenly heat spreads over the pan bottom. Choose pans that provide the best cooking results.

- **Handles** should be made of sturdy, heat-resistant material and be securely attached to the pan.
- **With your hand**, feel the bottom of your pans while they are cool for nicks and scratches. Nicks and scratches on pan bottoms will scratch the ceramic glass cooktop.
- **Avoid spillovers** on cooktop. Use pans with tall sides.

**NOTE:** Do not leave empty cookware, or cookware which has boiled dry, on a hot surface unit. The cookware could overheat and damage the cookware or surface unit.

## Home canning information

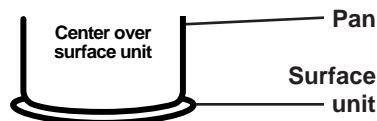

- **Use the largest surface unit** for best results. Also, use a canner/pan which can be centered over the surface unit.
- **Start with hot water.** This reduces the time the control is set on high. Reduce heat setting to lowest position needed to keep water boiling.
- **Refer** to your canner manual for specific instructions.



## Caring for your cooktop

This cooktop is designed for easy care. However, ceramic glass cooktops need to be maintained differently than standard electric coil elements. Foods spilled directly on the cooktop will not burn off as on coil elements. Because of this, the surface should be dust-free and soil-free before heating.

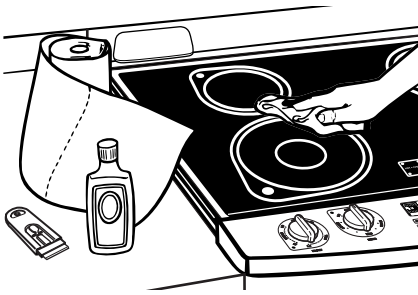

Your cooktop has been prepolished at the factory for improved protection and cleanability. The Cooktop Polishing Creme, a paper towel or a sponge, and a single-edge razor blade in a holder is all you need to clean your cooktop. For proper cleaning methods, please review the chart on page 13. Follow this chart after each use to ensure top performance and to preserve that uniquely elegant look.

**NOTE:** Let cooktop cool before cleaning.

**To avoid damaging the cooktop, follow these instructions:**

- **Remove sugar spills** and soils from the cooktop while the surface is still warm to avoid pitting on the surface.
- **Marks from sliding** metal pans on the cooktop are difficult to remove completely. Use cooktop polishing creme to clean the area. Several applications may be necessary.
- **Do not use** steel wool, plastic cleaning pads, abrasive powdered cleansers, chlorine bleach, rust remover, ammonia, or glass cleaning products with ammonia. These products could damage the cooktop surface.



## Cleaning tips

### What to use:

- **Cooktop Polishing Creme with a paper towel or clean, damp sponge** – This creme has been developed especially for cleaning and protecting your cooktop. When using, follow instructions on container.
- **Razor scraper** – Use to remove cooked-on soils from your ceramic glass cooktop. To avoid scratches, keep the razor blade as flat against the cooktop as possible. **Store razor blades out of reach of children.**

### Steps to follow:

1. **Most spills** (except sugary spills and soils – see chart on this page) can be wiped off easily using a paper towel or clean, damp sponge as soon as Hot Surface Indicator Light(s) goes off.
2. **For stubborn spills**, rub Cooktop Polishing Creme into cooked-on soil using a paper towel. If some soil remains, leave some creme on the spot(s) and follow Step 3.
3. **Carefully scrape** spots with a single-edge razor blade in a holder.
4. **Finish by polishing** entire cooktop with Cooktop Polishing Creme and a paper towel.

**To order Cooktop Polishing Creme (Part No. 3184477), call 1-800-422-1230** and follow the instructions and telephone prompts you hear.

## How to keep your cooktop looking like new:

IF THERE ARE	WHAT TO DO
<b>Sugary spills and soils</b> (such as jellies and candy syrups)	To prevent pitting on the cooktop, wipe up with a paper towel or clean, damp sponge <b>while ceramic glass surface is still warm.</b> Remove as soon as possible after spill occurs.
<b>Dark streaks, specks, and discoloration</b>	Use Cooktop Polishing Creme or nonabrasive cleanser with a damp paper towel or sponge.
<b>Metal marks</b> (from copper or aluminum pans)	Use Cooktop Polishing Creme or nonabrasive cleanser with a damp paper towel or sponge before heating the cooktop again. If heated before cleaning, metal marks may not come off.
<b>Tiny scratches or abrasions</b>	Scratches and abrasions do not affect cooking. In time, they will become less visible as a result of cleaning. To prevent scratches and abrasions, use Cooktop Polishing Creme regularly.

**NOTE:** Always wipe and dry your cooktop thoroughly after using cleanser to prevent streaking or staining.



# Using and Caring for Your Cooktop

## Using and replacing the cooktop light

The fluorescent light is on the top of the control panel. The cooktop light switch is on the control panel. **Press** it to turn on the cooktop light. **Press** it again to turn light off.

### Replacing the cooktop light:

1. **Unplug** appliance or **disconnect** at main power supply.

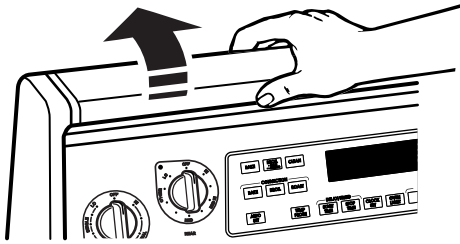

2. **Flip up** the top of the control panel.

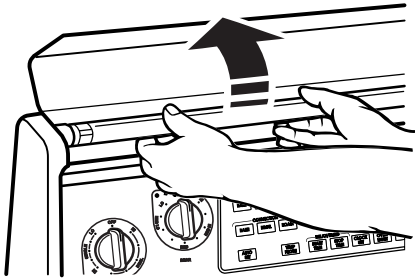

3. **Grasp** the fluorescent tube at both ends. **Turn** the tube approximately 90° in either direction until both ends come out of the receptacles. **Replace** with a 20-watt cool-white fluorescent tube.

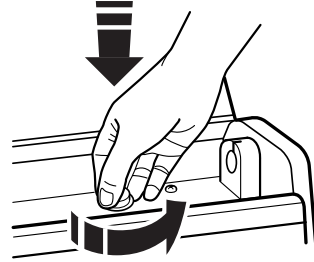

If the cooktop light still does not work, you may need to replace the starter. The starter is a knob-shaped part located on the right side of the backguard, under the light bulb. **To remove and replace the starter, first remove light bulb. Push** starter in and **turn** approximately 90° counterclockwise. **Pull** starter out of recessed area. You can find replacement starters at stores that sell fluorescent tubes.

4. **Close** the top panel. **Plug in** appliance or **reconnect** at main power supply.

# Using and Caring for Your Oven

This section tells you, step by step, how to operate all oven functions controlled by the electronic controls. Carefully follow these instructions, along with the cooking tips and cleaning information, for successful use of your range.

## IN THIS SECTION

Using the electronic oven control .....	15	Broiling .....	28
Oven settings .....	17	Convection broiling .....	31
Setting the clock .....	18	Timed cooking .....	34
Using the kitchen timer .....	18	Dehydrating .....	38
Baking or convection baking .....	20	Raising (proofing) bread .....	40
Roasting .....	21	Cooking tips .....	41
Adjusting oven temperature .....	23	Cleaning your oven and controls .....	44
Using the temperature probe .....	24	Using and replacing the oven light(s) .....	46
Using auto set .....	27		

## Using the electronic oven control

For a quick reference guide on using the electronic oven control, see the QuickSet Guide under the cooktop light cover.

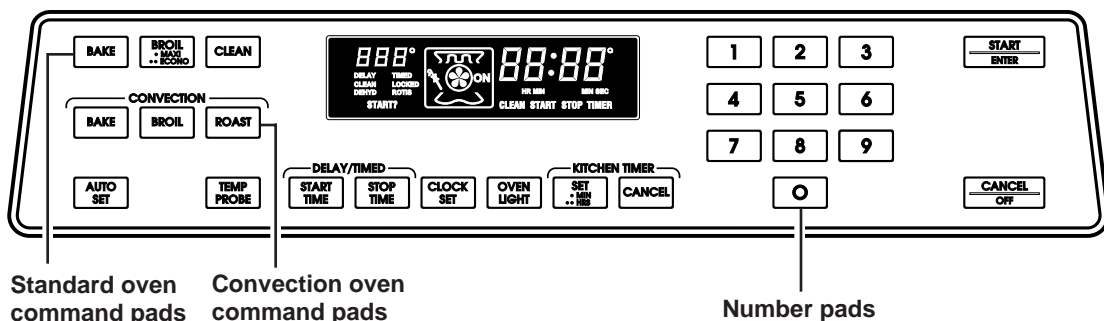

### Display/clock

- **When you first** plug in the range, a tone will sound and the display will show “88:88.” If, after you set the clock (page 18), the display again shows “88:88,” your electricity was off for a while. Reset the clock.
- **The time display** will show “Err” and three short tones will sound if a time or temperature is incorrectly entered.

### Starting an operation



After programming a function, you must press the Start/Enter pad to start the function. If you do not press the Start/Enter pad within 5 seconds of programming, “START?” will show in the display as a reminder.



# Using and Caring for Your Oven

## Canceling an operation



The Cancel/Off pad will cancel any function, except for the Clock Set and Kitchen Timer functions. When you press the Cancel/Off pad, the large display will show the time of day.

## Changing audible signals

Audible signals tell you if a function is entered correctly or not. They also tell you when a cycle is completed.

### To shut off audible signals during programming:

**PRESS  
and hold  
for 4  
seconds**



### To shut off all signals except for the end-of-timer tone:

**PRESS  
and hold  
for 4  
seconds**



### To change the end-of-timer tone to a 4-second tone:

**PRESS  
and hold  
for 4  
seconds**



A short tone will sound to tell you the signals have been changed. Repeat step above to turn the signals back on.





## Oven settings

This chart tells you when to use each setting. It also explains what elements heat up for each setting.

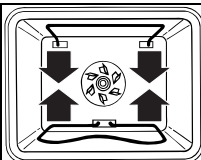
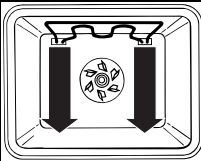
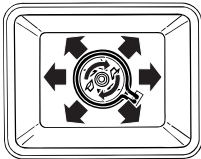
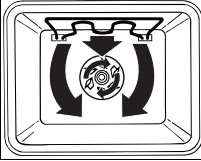
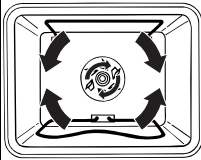
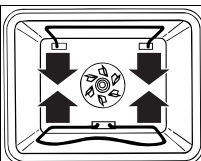
SETTING	DIAGRAM	SETTING INFORMATION
<p><b>BAKE</b> Use this setting for baking and heating casseroles.</p>		<ul style="list-style-type: none"> <li>• The bottom element and outer top element heat up.</li> <li>• During baking, the elements will turn on and off to maintain the oven temperature.</li> </ul>
<p><b>BROIL (MAXI/ECONO)</b> Use this setting for broiling regular-sized and smaller cuts of meat, poultry, and fish.</p>		<ul style="list-style-type: none"> <li>• Both top elements heat during Maxi Broil. (Maximum browning coverage)</li> <li>• Only the inner element heats up during Econo Broil. (Browning coverage in center only)</li> </ul>
<p><b>CONVECTION BAKE</b> Use this setting for foods which require gentle heating and for baking breads and cakes. Use also when baking large quantities of food on more than one oven rack.</p>		<ul style="list-style-type: none"> <li>• For faster preheating, the bottom element and outer top element heat up until oven reaches desired temperature. After preheat, only the rear element heats up.</li> <li>• For even heating, the fan at the back of the oven circulates air in the oven cavity.</li> </ul>
<p><b>CONVECTION BROIL</b> Use this setting for broiling thick cuts of meat.</p>		<ul style="list-style-type: none"> <li>• Both top elements heat up.</li> <li>• For even heating, the fan at the back of the oven circulates air in the oven cavity.</li> </ul>
<p><b>CONVECTION ROAST</b> Use this setting for roasting and baking on one rack.</p>		<ul style="list-style-type: none"> <li>• The bottom element and outer top element heat up.</li> <li>• For even heating and faster cooking, the fan at the back of the oven circulates air in the oven cavity.</li> </ul>
<p><b>CLEAN</b> Use this setting for self-cleaning only.</p>		<ul style="list-style-type: none"> <li>• The bottom element and outer top element heat up.</li> </ul>



# Using and Caring for Your Oven

## Setting the clock

### 1. Choose Clock Set.

PRESS



Example:  
YOU SEE



### 2. Set time.

Example:  
PRESS



Example:  
YOU SEE



### 3. Start clock.

PRESS



If the time has not been entered correctly, three short tones will sound and “Err” is displayed for 1 second. The previous display then reappears. Repeat Steps 1, 2, and 3 to re-enter the time of day.

## Using the kitchen timer

The Kitchen Timer does not start or stop the oven. It works like a regular kitchen timer.

It can be set in hours and minutes up to 99 hours, 99 minutes, or in minutes and seconds up to 99 minutes, 99 seconds.

### 1. Choose Kitchen Timer.

PRESS  
*once* to  
count down  
minutes  
and seconds



YOU SEE





PRESS  
twice to  
count down  
hours and  
minutes



YOU SEE



## 2. Set time.

Example:  
PRESS



Example:  
YOU SEE

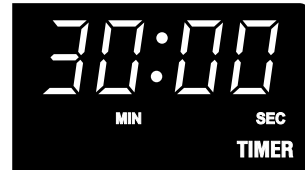

## 3. Start Kitchen Timer.

PRESS



The Kitchen Timer will begin counting down immediately after you press the Start/Enter pad.

When time is up, you will hear a single tone that sounds every 5 seconds.

PRESS  
to turn off tone

**KITCHEN/  
TIMER**



YOU SEE



**NOTE:** To change the end-of-timer tone to a 4-second tone, press and hold the Kitchen Timer Set pad for 4 seconds. A short tone will sound to tell you the tone has been changed.

## To cancel the Kitchen Timer:

PRESS

**KITCHEN/  
TIMER**





## Baking or convection baking

### 1. Position racks.

For correct rack placement, see “Rack positions” on page 41 and “Rack placement” chart on page 41.

#### NOTES:

- **Before turning on the oven** always place oven racks where you need them.
- **Be sure** rack(s) is level.
- **Use pot holders or oven mitts** to protect hands if rack(s) must be moved while oven is hot.
- **Do not let** pot holder or oven mitt touch hot elements.

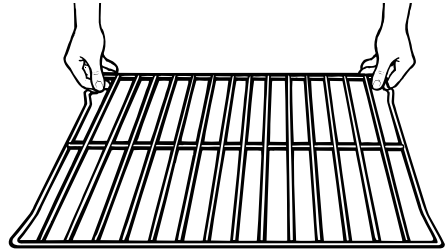

### 2. Choose setting.

PRESS



YOU SEE

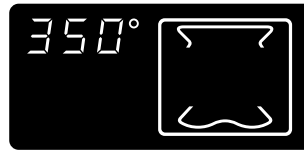

OR

CONVECTION

PRESS



YOU SEE

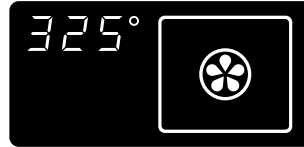

### 3. Set temperature (optional).

Do this step if you want to set a temperature other than 350°F (for Bake) or 325°F (for Convection Bake).

*Example:*  
PRESS



*Example For Bake:*  
YOU SEE



(See a reliable cookbook or your convection oven cookbook for temperature recommendations.)



## 4. Preheat oven.

PRESS



*Example  
For Bake:  
YOU SEE*

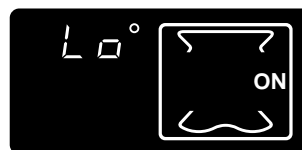

**NOTE:** After the temperature reaches 170°F, the red display will show the actual oven temperature at each 5°F increase and stop at the set temperature. To see the set temperature before it is reached, press the command pad you used to choose the cook setting. The set temperature will be displayed for 5 seconds.

## 5. Put food in oven.

**NOTE:** If you want to change the baking temperature after baking has begun, repeat Steps 2, 3, and 4.

## 6. After cooking, turn off oven.

PRESS



*Example:  
YOU SEE  
(time of day)*



## Roasting

### 1. Prepare oven.

Position the rack properly. For correct rack placement, see “Rack positions” on page 41. Place food in the oven. For large roasts and turkeys, place rack in position 1 (closest to oven bottom).

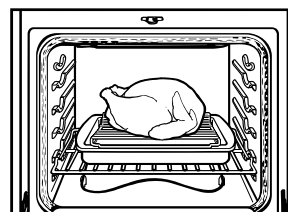



continued on next page



# Using and Caring for Your Oven

## 2. Choose setting.

**CONVECTION**

PRESS  YOU SEE 

## 3. Set temperature (optional).

Do this step if you want to set a temperature other than 300°F.

*Example:*  
PRESS   

(See convection oven cookbook for temperature recommendations.)

*Example:*  
YOU SEE 

## 4. Start oven.

PRESS 

*Example:*  
YOU SEE 

### NOTES:

- **After the temperature** reaches 170°F, the red display will show the actual oven temperature at each 5°F increase and stop at the set temperature. **To see the set temperature before it is reached, press** the Convection Roast pad. The set temperature will be displayed for 5 seconds.
- **If you want** to change the roasting temperature after roasting has begun, repeat Steps 2, 3, and 4.

## 5. After cooking, turn off oven.

PRESS 

*Example:*  
YOU SEE  
(time of day)  

## Adjusting oven temperature

Although your new oven is properly adjusted to provide accurate temperatures, it may cook faster or slower than your old oven.

If, after using the oven for a period of time, you are not satisfied with the baking/roasting results, you can change the offset temperature by following the steps below. The control will “remember” the selected offset even after the power has been interrupted or lost.

**NOTE:** Do not measure oven temperature with a thermometer. Opening the oven door will lower the oven temperature and give you an inaccurate reading. Also, the thermometer temperature reading will change as your oven cycles.

### 1. Choose Bake setting.

PRESS  
and hold  
for 4 seconds



*Example:*  
YOU SEE



Release the Bake pad when a number appears in the temperature display and you hear a tone.

“0” (the setting shown) is set at the factory.

### 2. Set new offset temperature.

PRESS



*Example:*  
YOU SEE

Adjustment 5°F cooler:



Each time you press the Bake pad, the displayed temperature will increase by 5°F. **To decrease the temperature, hold down** the Bake pad until the display goes past 35°F. At that point the display will return to 0 and will then decrease 5°F for every time you press the Bake pad. You can set the offset temperature adjustment as low as -35°F or as high as +35°F. (To determine the amount of adjustment needed, see the chart on page 24.)

### 3. Enter the adjustment.

PRESS



*Example:*  
YOU SEE  
(time of day)

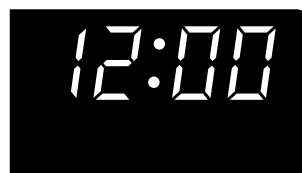



# Using and Caring for Your Oven

## How to determine the amount of adjustment needed

The following chart tells you how much to adjust the offset temperature to get the desired cooking results. You can determine cooking results by amount of browning, moistness, and rising times for baked foods.

TO COOK FOOD ...	ADJUST BY THIS NUMBER OF DEGREES
A little more	+5 to +10
Moderately more	+15 to +20
Much more	+25 to +35
A little less	-5 to -10
Moderately less	-15 to -20
Much less	-25 to -35

## Using the temperature probe

The Temperature Probe is the most accurate guide to the degree of doneness of meat. Use it when baking, roasting any type of meat or poultry, or cooking casseroles with liquid.

### 1. Insert probe into food.

Insert the probe into the center of the thickest portion of meat or into the inner thigh or breast of poultry, away from fat or bone.

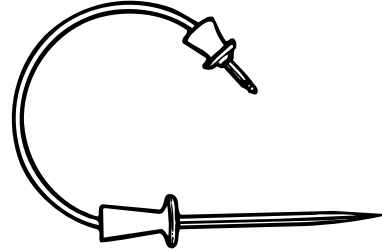

### 2. Put food in oven.

Place meat on the convection roasting rack, place rack on broiler pan, and place pan in the center of the oven.



### 3. Connect probe to oven.

Open the Temperature Probe cover located on the left side of the oven wall. Insert plug into jack. (Keep the top of the probe as far as possible from the heat source.)

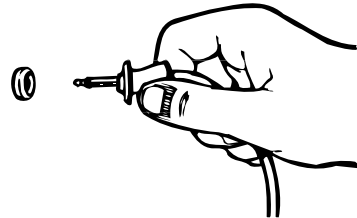

### 4. Close oven door.





## 5. Choose Temperature Probe setting.

PRESS



YOU SEE



## 6. Set temperature (optional).

Do this step if you want to set an internal food temperature (from 100°F-200°F) other than 160°F.

*Example:*  
PRESS



*Example:*  
YOU SEE



(See a reliable cookbook or your convection oven cookbook for internal food temperature recommendations.)

## 7. Choose cook setting.

PRESS



## 8. Set temperature (optional).

Do this step if you want to set an oven temperature other than the one displayed.

*Example:*  
PRESS



(See a reliable cookbook or your convection oven cookbook for oven temperature recommendations.)

**NOTE:** Do not use the Temperature Probe when broiling or convection broiling.

continued on next page



# Using and Caring for Your Oven

## 9. Start oven.

PRESS



*Example  
For Bake:  
YOU SEE*



### NOTES:

- **After the food temperature** reaches 100°F, the large display will show the actual food temperature at each 5°F increase and stop at the set temperature. Four short tones will sound when food reaches the set temperature. The oven then shuts off.
- **If you want** to change the probe temperature after cooking has begun, repeat Steps 5, 6, and 9.

If probe is not plugged in:

YOU SEE



Three short tones will also sound.

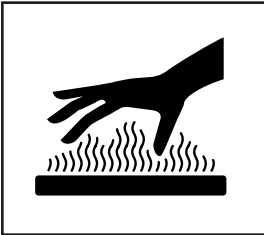

## ! WARNING

### Burn Hazard

Use an oven mitt or pot holder to remove temperature probe.  
Do not touch broil element.  
Failure to follow these instructions can result in burns.

## 10. After cooking, unplug probe.

One short tone will sound every minute, to remind you cooking is done, until you unplug the Temperature Probe.

## 11. Remove food from oven.

(This prevents overcooking.)

## 12. Clean probe.

Wash with a soapy sponge and dry thoroughly. Use a plastic scouring pad to remove cooked-on foods. You can also clean the probe in a dishwasher.

## Using auto set

Auto Set lets you choose from among ten preset oven cooking cycles. These cycles store commonly used cooking times, cooking temperatures, and probe temperature settings. Auto Set saves you time by limiting the number of pads you have to press when cooking at a favorite setting.

### 1. Place food in cold oven.

If you need the Temperature Probe for your cycle (settings 5-8), insert probe into food. (Follow Steps 1-4 in “Using the temperature probe” on page 24.)

### 2. Set Auto Set cycle.

PRESS



YOU SEE



Press desired Number pad.

*Example:*  
PRESS



*Example:*  
YOU SEE



(Use the “Auto set chart” on page 28 as your guide for selecting the correct cycle.)

#### NOTES:

- **You can change** the Auto Set cycle any time before pressing the Start/Enter pad by repeating Step 2.
- **The cooking** setting, time, or probe temperature will be displayed before you press the Start/Enter pad.

### 3. Start oven.

PRESS



*Example*  
For Auto  
Set 5:  
YOU SEE



**NOTE: Cycles 1-4, 9, 0:** To see the time when the Auto Set cycle will end, press the Stop Time pad.

**When the Auto Set cycle is done,** “End” and the time of day will show in the display. Four tones will sound, followed by one short tone every minute, until you open the door, remove the probe, or press the Cancel/Off pad.

*Example:*  
YOU SEE





# Using and Caring for Your Oven

## Auto set chart

CYCLE NUMBER	CONVECTION CYCLE	OVEN TEMP	TIME OR PROBE TEMP	FOOD OR MEAL
1	Conv. Bake	350°F	45 min	Meal # 1: Chicken pieces, Fruit crisp, Vegetable casserole
2	Conv. Bake	350°F	1 hr	Meal # 2: Macaroni and cheese, Baked winter squash, Fruit pie
3	Conv. Bake	350°F	1 hr 15 min	Meal # 3: Precooked ham, Baked potatoes, Quick bread loaf <b>OR</b> Baked potatoes only
4	Conv. Bake	375°F	55 min	Meal # 4: Beef stew, Scalloped potatoes, Frozen fruit pie
5	Conv. Roast	300°F	140°F	Beef roast rare
6	Conv. Roast	300°F	160°F	Beef roast medium
7	Conv. Roast	300°F	170°F	Beef roast well Pork roast Meat loaf
8	Conv. Bake	325°F	150°F	Casseroles
9	Conv. Bake	325°F	3 hr	Pot roast with vegetables – 3 lbs
0	Conv. Roast	400°F	18 min	Pizza

## Broiling

**NOTE:** Preheating is not necessary when broiling.

### 1. Position rack.

See “Thermal broiling chart” on page 33 for recommended rack positions.

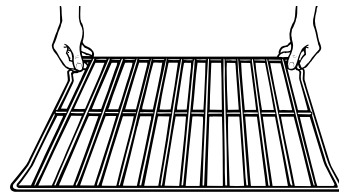

### 2. Put food in oven.

Place food on grid in broiler pan and place in center of the oven rack.

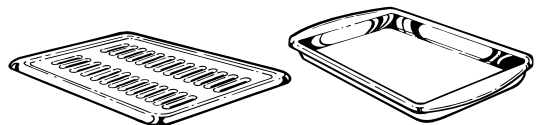

Broiler grid

Broiler pan



### 3. Close door.

Close the door to the Broil Stop position (open about 4 inches). The door will stay open by itself.

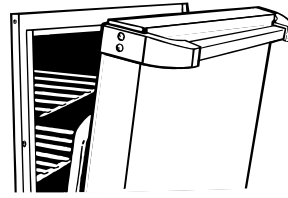

### 4. Choose Broil setting.

**PRESS**  
once for Maxi Broil



YOU SEE

Maxi broil:

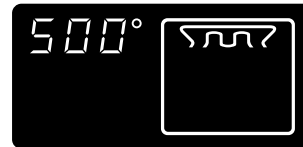

OR

**PRESS**  
twice for Econo Broil



YOU SEE

Econo broil:

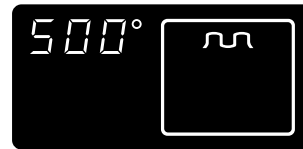

### 5. Set temperature (optional).

Do this step if you want to use variable temperature broiling (see page 30).

*Example:*  
**PRESS**



(See "Thermal broiling chart" on page 33 for temperature recommendations.)

*Example:*  
YOU SEE

Maxi broil:

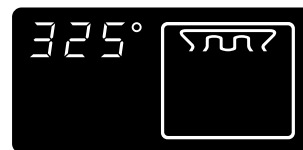

*Example:*  
YOU SEE

Econo broil:



continued on next page



# Using and Caring for Your Oven

## 6. Start oven.

PRESS



*Example:*  
YOU SEE  
(time of  
day)

Maxi broil:

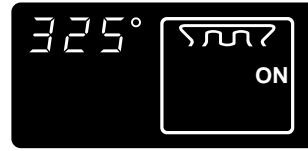

**NOTE:** Leave the door partly open whenever using the oven to broil. This allows the oven to maintain proper temperatures. If you want to change the broiling temperature after broiling has begun, repeat Steps 4, 5, and 6.

*Example:*  
YOU SEE

Econo broil:

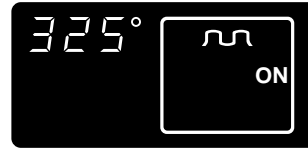

## 7. When broiling is done, turn off oven.

PRESS



*Example:*  
YOU SEE  
(time of  
day)



## Variable temperature broiling

- **If food is cooking** too fast or you want the food to broil slower from the start, set the broil temperature between 170°F and 325°F (77°C and 163°C). These temperature settings allow the broil heating element to cycle and to slow cooking. The lower the temperature, the slower the cooking.
- **Fish and chicken** are some foods that may cook better if you use lower broiling temperatures. (See the “Thermal broiling chart” on page 33 for temperature recommendations.)



## Convection broiling

Convection broiling is actually high-temperature convection roasting. Use this setting when broiling thick cuts of meat. Results are similar to those you get when using a rotisserie.

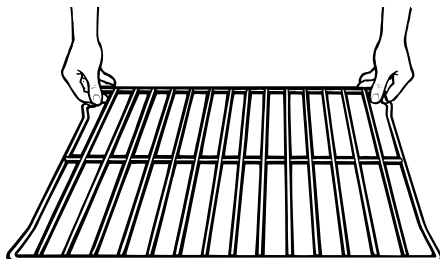

### 1. Position rack.

See "Thermal broiling chart" on page 33 for recommended rack positions.

### 2. Put food in oven.

Place food on grid in broiler pan and place in center of the oven rack. Turn the pan so the long side is parallel to the oven door for the most even heat and the best airflow.

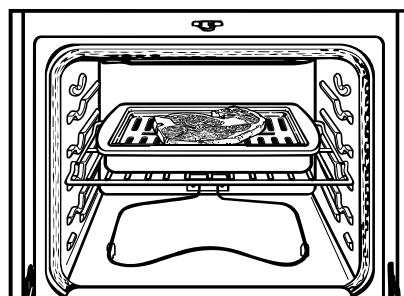

### 3. Close door.

**NOTE:** Do not try to convection broil with the door open. The fan will not operate.

### 4. Choose Convection Broil setting.

**CONVECTION**  
PRESS **BROIL**

YOU SEE



### 5. Set temperature (optional).

Do this step if you want to set a temperature (up to 450°F) other than 450°F.

*Example:*  
PRESS



(See convection oven cookbook for temperature recommendations.)

*Example:*  
YOU SEE



continued on next page



# Using and Caring for Your Oven

## 6. Start oven.

PRESS



*Example:*  
YOU SEE

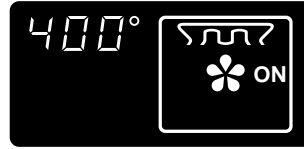

**NOTE:** If you want to change the convection broiling temperature after broiling has begun, repeat Steps 4, 5, and 6.

## 7. When broiling is over, turn off oven.

PRESS



*Example:*  
YOU SEE  
(time of day)

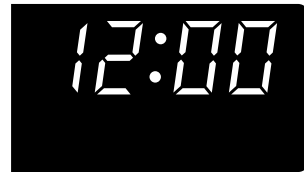

## Broiling tips

- **Always start** broiling with a cold broiler pan for even results.
- **To retain more natural juice**, do not pierce meat with a fork.
- **Trim** the outer layer of fat from steaks and chops.
- **Slit** fatty edges to prevent meat from curling during broiling.
- **Use a nonstick cooking spray or vegetable oil** on the broiler pan and grid when broiling fish to prevent sticking.

## Broiling rack positions

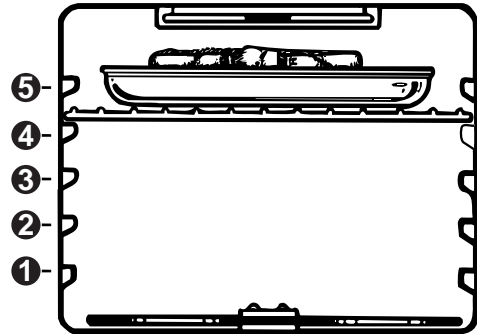





## Thermal broiling chart

– Press the Broil pad.

– The recommended rack position is numbered lowest (1) to highest (5).

MEAT	RACK POSITION	TEMPERATURE	APPROXIMATE TOTAL TIME (MINUTES)
<b>Steak, 1" thick</b>	4	500°F	
• rare			16
• medium			21
• well-done			25
<b>Steak, 1½" thick</b>	4	500°F	
• rare			23
• medium			28
<b>Hamburger patties or steaks, ½" thick or less</b>			
• medium	5	500°F	8-12
<b>Lamb chops, 1" thick</b>	4	400°F	18-20
<b>Ham slice, ½" thick</b>	4	500°F	10-12
<b>1" thick</b>	4	500°F	20-22
<b>Pork chops, 1" thick</b>	4	450°F	25-28
<b>Frankfurters</b>	4	500°F	8
<b>Chicken pieces</b>	3	500°F	32
<b>Fish, ½" thick</b>	3	350°F	20
<b>1" thick</b>	3	350°F	20-22
<b>Calves liver, ½" thick</b>	4	350°F	10-12



# Using and Caring for Your Oven

## Timed cooking

The electronic clock/oven control will turn the oven on and off at times you set, even when you are not around.

Delayed time cooking is ideal for foods which do not require a preheated oven, such as meats and casseroles. **Do not use delayed time cooking for cakes, cookies, etc. – they will not rise properly. Before using timed cooking, make sure the clock is set to the correct time of day.** (See “Setting the clock” on page 18.)

## **!WARNING**

**Food Poisoning Hazard**  
Do not let food sit in oven more than one hour before or after cooking. Doing so can result in death, food poisoning, or sickness.

## To start baking/roasting now and stop automatically:

### 1. Prepare oven.

Position the oven rack(s) properly and place the food in the oven. For correct rack placement, see “Rack positions” on page 41 and “Rack placement” chart on page 41.

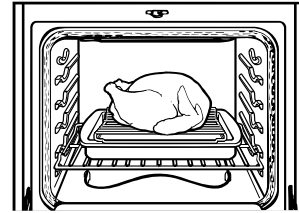

### 2. Choose setting.

PRESS **BAKE** OR **CONVECTION BAKE** OR **CONVECTION ROAST**

*Example For  
Convection  
Roast:  
YOU SEE*

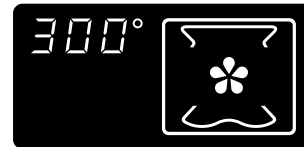



### 3. Set temperature (optional).

Do this step if you want to set a temperature other than the one displayed.

*Example:*  
PRESS



*Example:*  
YOU SEE



(See a reliable cookbook or your convection oven cookbook for temperature recommendations.)

### 4. Set stop time.

PRESS



*Example:*  
YOU SEE  
(time of day)



*Example:*  
PRESS



*Example:*  
YOU SEE



### 5. Start oven.

PRESS



When baking/roasting is done, "End" and the time of day will show in the display. Four tones will sound, followed by one short tone every minute, until you open the door or press the Cancel/Off pad.

*Example:*  
YOU SEE  
(time of day)





# Using and Caring for Your Oven

## To delay start and stop automatically:

### 1. Prepare oven.

Position the oven rack(s) properly and place the food in the oven. For correct rack placement, see "Rack positions" on page 41 and "Rack placement" chart on page 41.

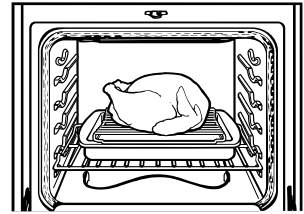

### 2. Choose setting.

PRESS **BAKE** OR **CONVECTION BAKE** OR **CONVECTION ROAST**

*Example For  
Convection  
Roast:  
YOU SEE*

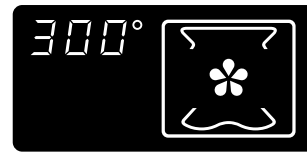

### 3. Set temperature (optional).

Do this step if you want to set a temperature other than the one displayed.

*Example:  
PRESS*

**3** **2** **5**

*Example:  
YOU SEE*

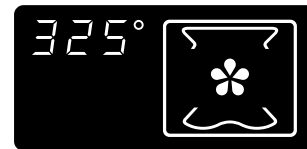

(See a reliable cookbook or your convection oven cookbook for temperature recommendations.)

### 4. Set start time.

PRESS **START TIME**

*Example:  
YOU SEE  
(time of  
day)*



*Example:  
PRESS*

**1** **0** **0**

*Example:  
YOU SEE*



## 5. Set stop time.

PRESS 

*Example:*  
YOU SEE  
(time of  
day)



*Example:*  
PRESS



*Example:*  
YOU SEE

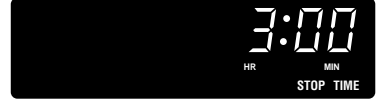

## 6. Complete entry.

PRESS 

*Example:*  
YOU SEE  
(time of  
day)

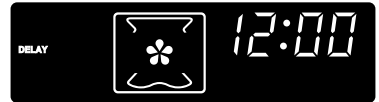

*Example:*  
YOU SEE

When start time is reached:



**When baking/roasting is done,** “End” and the time of day will show in the display. Four tones will sound, followed by one short tone every minute, until you open the door or press the Cancel/Off pad.

*Example:*  
YOU SEE  
(time of  
day)

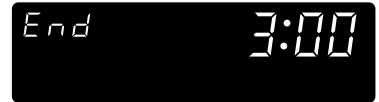

## To cancel timed cooking settings:

PRESS 

*Example:*  
YOU SEE  
(time of  
day)

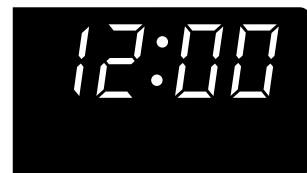



## Dehydrating

You can use your THERMAL-CONVECTION™ oven to dehydrate a variety of foods.

**NOTE:** To learn detailed information about dehydration, refer to a book written specifically about dehydrating and/or preserving foods.

### 1. Prepare food.

Prepare foods as recommended in recipe.

### 2. Arrange food on drying racks.

Racks are not included with oven. See below to order a dehydration kit\* which includes racks and a spacer or contact a local store handling specialty cookware.

### 3. Place drying racks in the oven to allow maximum air circulation around the racks.

NUMBER OF RACKS	USE OVEN RACK POSITION
1 rack	3
2 racks	2 and 4
3 racks	1, 3, and 5

### 4. Position door.

Attach the dehydration spacer\*, which is specially designed to depress the oven light plunger and maintain the operation of the fan during dehydration.

The spacer provides a 1 inch gap between the oven frame and the oven door allowing moisture to escape.

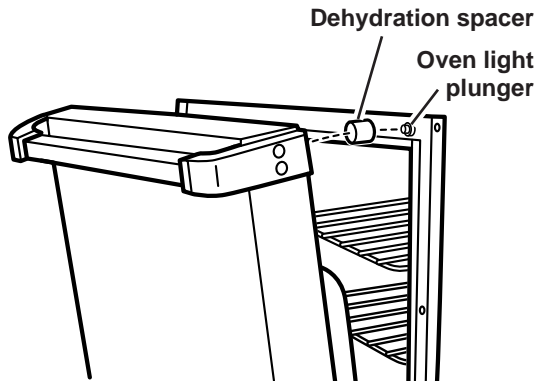

\* The dehydration spacer (Part No. 814166) or the dehydration kit which includes racks and a spacer (Part No. 4395974) can be ordered from your local KitchenAid dealer, or by calling **1-800-422-1230** and following the instructions and telephone prompts you hear.

## 5. Choose Convection Bake setting.

**CONVECTION**  
PRESS and hold for 2 seconds **BAKE** *Example: YOU SEE*



## 6. Set temperature (optional).

Do this step if you want to set a temperature (from 100°F to 200°F) other than 140°F.

*Example:*  
PRESS



*Example:*  
YOU SEE



## 7. Start oven.

PRESS **START**  
ENTER

*Example:*  
YOU SEE



**NOTE:** If you want to change the dehydrating temperature after dehydrating has begun, repeat Steps 5, 6, and 7.

## 8. When dehydrating is done, turn off oven.

PRESS **CANCEL**  
OFF

*Example:*  
YOU SEE  
(time of day)

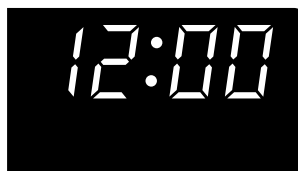



# Using and Caring for Your Oven

## Raising (proofing) bread

You can use your THERMAL-CONVECTION™ oven to proof bread.

### 1. Put bread in oven.

**NOTE:** Be sure to close the door.

### 2. Choose Convection Bake setting.

PRESS  
and hold for  
2 seconds

**CONVECTION**



YOU SEE

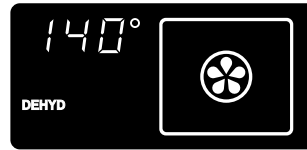

### 3. Set temperature.

Set temperature to 100°F.

*Example:*  
PRESS



*Example:*  
YOU SEE

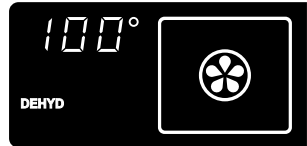

### 4. Start oven.

PRESS



*Example:*  
YOU SEE

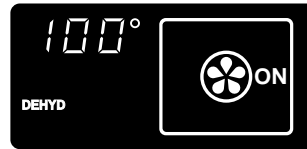

### 5. When proofing is done, turn off oven.

PRESS



*Example:*  
YOU SEE  
(time of  
day)

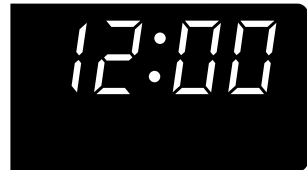





## Cooking tips

### Baking tips

The hot air must circulate around the pans in the oven for even heat to reach all parts of the oven. This results in better baking.

#### For best air circulation:

- **Place** the pans so that one is not directly over the other.



- **For best results**, allow 1 1/2 to 2 inches of space around each pan and between pans and oven walls.
- **When baking with one pan**, place pan in the center of the oven rack.

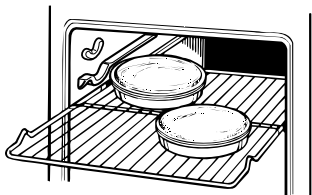

- **When baking with two pans**, place pans in opposite corners of the oven rack.

**NOTE:** “Oven peeking” may cause heat loss, longer cooking times, and unsatisfactory baking or roasting results. Rely on your timer.

### Rack positions

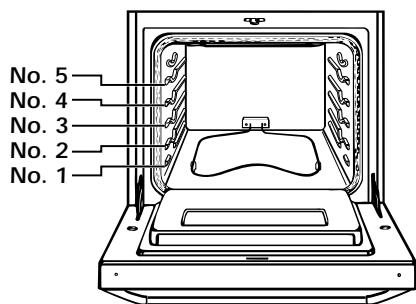

Your oven has two straight racks and five rack positions. Rack position 5 is the highest position, or farthest from the bottom of the oven. Rack position 1 is the lowest position, or closest to the bottom of the oven.

### For proper cooking, follow these guidelines:

- **When using one rack**, place the rack so the top of the food will be centered in the oven.
- **When using two racks**, place one rack in position 1 and the other rack in position 3.
- **Use only one** cookie sheet in the oven at a time when using the Bake setting.

### Bakeware tips

- **When baking with insulated cookie sheets or baking pans**, place them in the bottom third of the oven. You may need to increase the recommended baking times, so test for doneness before removing from the oven.
- **When using ovenproof glassware or dark bakeware**, reduce the oven temperature by 25°F, but use the same baking time. Because these pans absorb heat, producing darker bottom browning and crispier crusts, place the rack in the center of the oven. When baking pies and bread, you can use the temperature suggested in the recipe.

### Rack placement for specific foods:

(For rack positions, see “Rack positions” in previous column.)

FOOD	RACK POSITION
Frozen pies	2
Angel food and bundt cakes, most quick breads, yeast breads, casseroles, meats	1 or 2
Cookies, biscuits, muffins, cakes, nonfrozen pies	2 or 3



# Using and Caring for Your Oven

## Using aluminum foil in the oven (For thermal baking)

Use aluminum foil to catch spillovers from pies or casseroles.

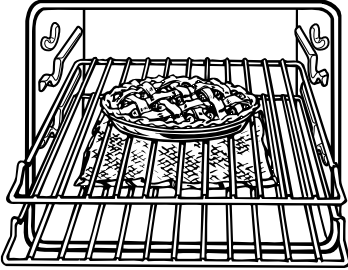

- **Place** the foil on the oven rack below the rack with the food. Turn foil edges up and make sure foil is about 1 inch larger all around than the dish holding the food.
- **Do not cover** the entire rack with aluminum foil. It will reduce air circulation and cause poor cooking results.
- **Do not line** oven bottom or entire oven rack with foil or other liners. It could affect the quality of your baking.

## Convection baking tips (convection bake pad)

- **Do not use** aluminum foil when convection baking. Aluminum foil may block airflow.
- **Reduce** recommended recipe oven temperature by approximately 25°F. See recipe adaption chart in your convection oven cookbook for recommended temperatures.
- **For most recipes**, you can reduce convection baking time compared to standard baking times. See convection baking chart in your convection oven cookbook for recommended baking times.

**NOTE:** Cooking time may be longer when you use more than one rack.

- **When baking on two or three racks**, use the Convection Bake setting for more even results. (You can, however, use only one rack when Convection Baking.)

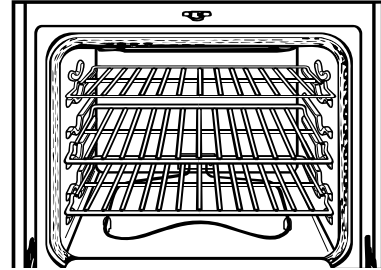

- **To use three racks during convection baking**, place racks in position 5 (the highest position), 3 and 1 (the closest to the oven bottom). This allows all three racks to be an equal distance apart for better baking.
- **Stagger** cake pans or other cookware in opposite directions on each rack when three racks are used.

## Roasting tips

- **Roast** meats fat-side up in a shallow pan using a roasting rack.
- **Use a roasting pan** that fits the size of the food to be roasted. Meat juices may overflow the sides of a pan that is too small. Too large of a pan will result in increased oven spatter.
- **Spatter can be reduced** by lining the bottom of the roasting pan with lightly crushed aluminum foil.

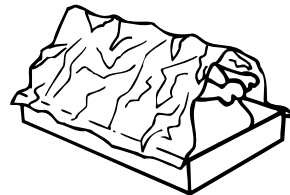

- **A foil tent** will slow down surface browning for long-term roasting, as when roasting a turkey. Place tent-shaped foil loosely over meat to allow for air circulation. Do not seal foil or meat will be steamed.



- **Use an accurate meat thermometer or temperature probe** (see page 24) to determine when meat has reached desired degree of doneness. Insert the thermometer or probe into the center of the thickest portion of the meat or inner thigh or breast of poultry. For an accurate reading, the tip of the thermometer or probe should not touch fat, bone, or gristle.
- **After reading the thermometer once,** push it further into the meat  $\frac{1}{2}$  inch or more and read again. If the temperature drops, return the meat to the oven for more cooking.
- **Check pork and poultry** with a thermometer in 2-3 places to ensure adequate doneness.
- **Poultry and roasts will be easier to carve** if loosely covered with foil and allowed to stand 10-15 minutes after removal from the oven.

- **You can reduce** roasting times and temperatures for most standard recipes when using the Convection Roast setting. See convection roasting chart in your convection oven cookbook for recommended roasting times and temperatures.

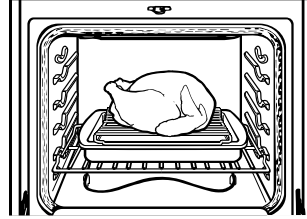

- **Use the convection roasting rack** on the broiler pan (both included with your range). (The convection roasting rack rests on the broiler pan, not inside it.) The long side of the rack should be parallel with the oven door for best heat distribution and airflow.

**NOTE:** Place the convection roasting rack on the broiler pan with grid to contain the drippings as the meat roasts.



## Cleaning your oven and controls



### **!WARNING**

#### **Explosion Hazard**

**Do not store flammable materials such as gasoline near this appliance.**

**Doing so can result in death, explosion, fire, or burns.**

<b>PART</b>	<b>WHAT TO USE</b>	<b>HOW TO CLEAN</b>
<b>Control knobs</b>	Sponge and warm, soapy water	<ul style="list-style-type: none"> <li>• Turn knobs to OFF and pull straight away from control panel.</li> <li>• Wash, rinse, and dry thoroughly. Do not soak.</li> <li>• <b>Do not use steel wool or abrasive cleansers. They may damage the finish of the knobs.</b></li> <li>• Replace knobs. Make sure all knobs point to OFF.</li> </ul>
<b>Control panel</b>	Sponge and warm, soapy water  <b>OR</b>  Paper towel and spray glass cleaner	<ul style="list-style-type: none"> <li>• Wash, wipe with clean water, and dry thoroughly.</li> <li>• <b>Do not use steel wool or abrasive cleansers. They may damage the finish.</b></li> <li>• Do not spray cleaner directly on panel. Apply cleaner to paper towel.</li> </ul> <p><b>NOTE:</b> Make sure you have not turned the oven on when cleaning panel. If you have, press the Cancel/Off pad.</p>
<b>Exterior surfaces</b> (other than ceramic cooktop and control panel)	Sponge and warm, soapy water	<ul style="list-style-type: none"> <li>• Wash, wipe with clean water, and dry thoroughly.</li> <li>• Use nonabrasive, plastic scrubbing pad on heavily soiled areas.</li> <li>• <b>Do not use abrasive or harsh cleansers. They may damage the finish.</b></li> </ul>
<b>Broiler pan and grid</b> (clean after each use)	Steel-wool pad and warm, soapy water	<ul style="list-style-type: none"> <li>• Wash, rinse, and dry thoroughly.</li> <li>• <b>Do not clean the pan and grid in the Self-Cleaning cycle.</b></li> </ul>



PART	WHAT TO USE	HOW TO CLEAN
<b>Oven racks</b>	Steel-wool pad and warm, soapy water <b>OR</b> The Self-Cleaning cycle	<ul style="list-style-type: none"> <li>• Wash, rinse, and dry thoroughly.</li> </ul> <p style="text-align: center;"><b>OR</b></p> <ul style="list-style-type: none"> <li>• Leave in oven during Self-Cleaning cycle.</li> </ul> <p><b>NOTE:</b> Racks will permanently discolor and become harder to slide if left in oven during the Self-Cleaning cycle. Apply a small amount of vegetable oil to the side rungs to aid sliding.</p>
<b>Oven door glass</b>	Paper towel and spray glass cleaner <b>OR</b> Warm, soapy water and a nonabrasive, plastic scrubbing pad	<ul style="list-style-type: none"> <li>• Make sure oven is cool.</li> <li>• Follow directions provided with the cleaner.</li> <li>• Wash, wipe with clean water, and dry thoroughly.</li> </ul>
<b>Oven cavity</b>	Self-Cleaning cycle	<ul style="list-style-type: none"> <li>• Wipe up food spills containing sugar as soon as possible after the oven cools down. (See “Using the Self-Cleaning Cycle” on page 47.)</li> <li>• See “Using the Self-Cleaning Cycle” on pages 47-50.</li> </ul>



## Using and replacing the oven light(s)

Your oven may have a standard oven light or two side halogen lights. The oven light(s) will come on when you open the oven door. To turn the light(s) on when the oven door is closed, **press** the Oven Light pad on the control panel. **Press** the pad again to turn off the light(s).

### Replacing the oven light (models with light on back wall):

1. **Disconnect** appliance at main power supply. Make sure the oven is cool before replacing the light bulb.

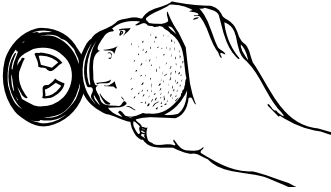

2. **Remove** the glass bulb cover in the back of the oven by screwing it out counter-clockwise.
3. **Remove** the light bulb from its socket. **Replace** the bulb with a 40-watt appliance bulb.
4. **Replace** the bulb cover by screwing it in clockwise. **Reconnect** appliance at main power supply.

**NOTE:** The oven light will not work during the Self-Cleaning cycle.

### Replacing oven lights (models with side halogen lights):

1. **Disconnect** appliance at the main power supply. Make sure the oven is cool before replacing the light bulb.

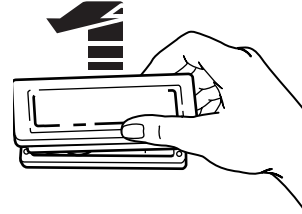

2. **Remove** glass light cover by grasping front edge of cover and pulling it away from the side wall of the oven.
3. **Remove** the light bulb from its socket. **Replace** the bulb with another halogen bulb (12 volt, 5 watt maximum, available at most hardware stores).
4. **Replace** the light cover by snapping it back into wall. **Reconnect** appliance at main power supply.

**NOTE:** The oven lights will not work during the Self-Cleaning cycle.

# Using the Self-Cleaning Cycle

The Self-Cleaning cycle saves you from the toil and mess that often come with hand-cleaning the oven interior. Like the other functions of your oven, you operate the Self-Cleaning cycle with the easy-to-use electronic control. To use this cycle properly, follow the step-by-step instructions in this section.



## ! WARNING

### Burn Hazard

**Do not touch the oven during the Self-Cleaning cycle.**  
**Keep children away from oven during Self-Cleaning cycle.**  
**Do not use commercial oven cleaners in your oven.**  
**Failure to follow these instructions can result in burns, or illness from inhaling dangerous fumes.**

## Before you start

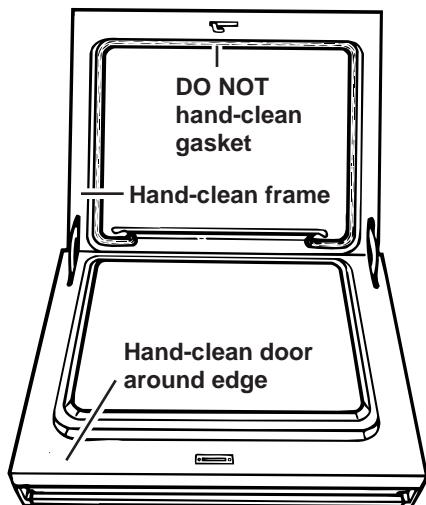

### Before you start the Self-Cleaning cycle, make sure you:

- **Hand-clean the areas shown.** They do not get hot enough during the Self-Cleaning cycle for soil to burn away. Use hot water and detergent or a soapy steel-wool pad for cleaning.  
**NOTE:** DO NOT clean, move, or bend the gasket. Poor cleaning, baking and roasting may result.
- **Remove** the broiler pan and grid and anything else being stored in the oven.
- **Wipe out** any loose soil or grease. This will help reduce smoke during the Self-Cleaning cycle.

- **Wipe up** food spills containing sugar as soon as possible after the oven cools down. When sugar is heated to a high temperature in the Self-Cleaning cycle, the high temperature can cause the sugar to burn and react with the porcelain. This can cause staining and etching or pitting.
- **Remove** the oven racks from the oven if you want them to remain shiny. You can clean racks in the Self-Cleaning cycle, but they will discolor and become harder to slide. If you clean racks in the Self-Cleaning cycle, place them on the rack guides.
- **Heat and odors** are normal during the Self-Cleaning cycle. Keep the kitchen well ventilated by opening a window or by turning on a vent hood or other kitchen vent during the cycle.

### NOTES:

- **Do not block** the vent during the Self-Cleaning cycle. Air must move freely for best cleaning results.
- **Do not leave** plastic utensils on the cooktop. They may melt.
- **Do not leave** any foil in oven during the Self-Cleaning cycle. Foil could burn or melt and damage the oven surface.
- **The oven lights** will not work during the Self-Cleaning cycle.



# Using the Self-Cleaning Cycle

## Setting the controls

**Make sure clock is set to correct time of day.**

(See "Setting the clock" on page 18.)

**To start cleaning immediately:**

### 1. Choose clean setting.

PRESS



YOU SEE



A 3-hour Self-Cleaning cycle will be set.

**NOTE:** You cannot open the door when LOCKED is on.

### 2. Set clean time (optional).

If you want a Self-Cleaning cycle other than 3 hours, **press** the desired number pads for the new time up to 4 hours.

*Example:*  
PRESS



*Example:*  
YOU SEE



- Use 2 hours for light soil.
- Use 3-4 hours for moderate to heavy soil.

### 3. Start oven.

PRESS



*Example:*  
YOU SEE

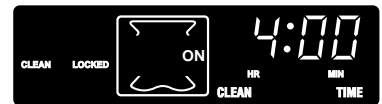

**NOTE:** If you want to change the cleaning time after cleaning has begun, repeat Steps 1-3.

**To delay clean using start time:**

### 1. Choose clean setting.

PRESS



YOU SEE



A 3-hour Self-Cleaning cycle will be set.

**NOTE:** You cannot open the door when LOCKED is on.





## 2. Set clean time (optional).

If you want a Self-Cleaning cycle other than 3 hours, **press** the desired number pads for the new time up to 4 hours.

*Example:*  
PRESS



- Use 2 hours for light soil.
- Use 3-4 hours for moderate to heavy soil.

*Example:*  
YOU SEE



## 3. Set start time.

PRESS



*Example:*  
PRESS



*Example:*  
YOU SEE  
(time of day)



*Example:*  
YOU SEE



## 4. Complete entry.

PRESS



**NOTE:** If you want to change the cleaning time after cleaning has begun, repeat Steps 1-4.

*Example:*  
YOU SEE



When the Self-Cleaning cycle starts:

*Example:*  
YOU SEE

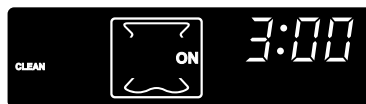

After the Self-Cleaning cycle is completed:

*Example:*  
YOU SEE  
(time of day)



When the oven cools to normal baking/roasting temperatures:

*Example:*  
YOU SEE  
(time of day)





# Using the Self-Cleaning Cycle

To stop the Self-Cleaning cycle at any time:

PRESS



Example:  
YOU SEE  
(time of  
day)

When the oven cools to normal  
baking/roasting temperature:



## For best cleaning results

- After the oven cools to room temperature, wipe up any residue or ash with a damp cloth or sponge. If any spots remain, clean with a mild abrasive cleanser or cleaning sponge.
- Clean the oven before it gets heavily soiled. Cleaning a very soiled oven takes longer and results in more smoke than usual.
- If the Self-Cleaning cycle does not get the oven as clean as you expected, the cycle may not have been set long enough or you may not have prepared the oven properly. Set the Self-Cleaning cycle longer the next time and hand-clean areas noted on page 47.

## How the cycle works

The Self-Cleaning cycle uses very high heat to burn away soil and grease. During the cycle, the oven gets much hotter than it does for normal baking or broiling. This high heat breaks up the soil or grease and burns it away.

Your oven is preset for a 3-hour Self-Cleaning cycle. However, the cycle time can be adjusted to the amount of soil in your oven. The cycle can be set anywhere between 2 and 4 hours. (See "Setting the controls" on page 48.)

The graph at the right is representative of a normal, 3-hour Self-Cleaning cycle. Note that the heating stops when the 3-hour setting is up, but it takes longer for the oven to cool enough to unlock.

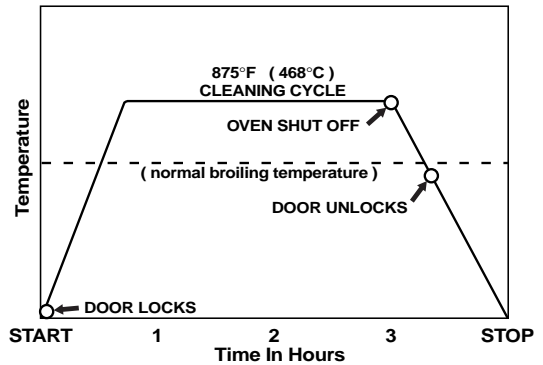

# If You Need Assistance or Service

**Questions or comments? Call our toll-free Consumer Assistance Center telephone number, 1-800-422-1230.**

This section is designed to help you save the cost of a service call. Part 1 of this section outlines possible problems, their causes, and actions you can take to solve each problem. Parts 2 and 3 tell you what to do if you still need assistance or service. When calling our Consumer Assistance Center for help or calling for service, please provide a detailed description of the problem, your appliance's complete model and serial numbers, and the purchase or installation date. (See page 2.) This information will help us respond properly to your request.

## 1. Before calling for service:

If your appliance should fail to operate, review the following list before calling your dealer. You could save the cost of a service call.

<b>PROBLEM</b>	<b>POSSIBLE CAUSE</b>	<b>WHAT TO DO</b>
<b>Nothing will operate</b>	The unit is not wired into a live circuit with proper voltage.	Wire the unit into a live circuit with proper voltage. (See Installation Instructions.)
	A household fuse has blown or a circuit breaker has tripped.	Replace household fuse or reset circuit breaker.
<b>The oven will not operate</b>	You have not set the electronic control correctly.	Refer to the section in this manual describing the function you are operating.
	You have programmed a delayed start time.	Wait for the start time to be reached or cancel and reset the controls.
<b>The surface units will not operate</b>	A household fuse has blown or a circuit breaker has tripped.	Replace household fuse or reset circuit breaker.
	You have not set the control knobs correctly.	Push control knobs in before turning to a setting.
<b>The control knob(s) will not turn</b>	You are not pushing in before turning.	Push control knob(s) in before turning to a setting.

**continued on next page**



## If You Need Assistance or Service

<b>PROBLEM</b>	<b>POSSIBLE CAUSE</b>	<b>WHAT TO DO</b>
<b>The Self-Cleaning cycle will not operate</b>	You have programmed a delayed start time.	Wait for the start time to be reached or cancel and reset the controls.
<b>Cooking results are not what you expected</b>	The range is not level. The oven temperature seems too low or too high. You did not preheat the oven before baking. The recipe you are using may need to be altered to improve the taste or appearance of the food. The pan used is not the correct type or size. There is not proper air circulation around pan when baking. Cookware does not fit the surface unit being used.	Level range. (See Installation Instructions.) Adjust the oven temperature. (See "Adjusting oven temperature" on page 23.) Preheat oven when called for in recipe. Alter recipe as needed. Refer to a reliable cookbook or recipe for recommended pan type and size. Allow 1½ to 2 inches of air space on all sides of pan. Pan should be the same size or slightly larger than surface unit being used.
<b>The display is flashing "88:88"</b>	There has been a power failure.	Reset the clock. (See page 18.)
<b>"F-" followed by a number shows in the display</b>		Call for service. (See Step 3 on page 53.)



## 2. If the problem is not due to one of the items listed in Step 1:

- Call KitchenAid Consumer Assistance Center:



**1-800-422-1230**

One of our trained consultants can instruct you in how to obtain satisfactory operation from your appliance or, if service is necessary, recommend a qualified service company in your area.

- If you prefer, write to:  
KitchenAid Brand Home Appliances  
Consumer Assistance Center  
c/o Correspondence Dept.  
2000 North M-63  
Benton Harbor, MI 49022-2692

Please include a daytime phone number in your correspondence.

## 3. If you need service\*:

- Call your dealer or the repair service he recommends.



- All service should be handled locally by the dealer from whom you purchased the unit or an authorized KitchenAid servicer.

- If you are unable to obtain the name of a local authorized KitchenAid servicer, call our Consumer Assistance Center telephone number (see Step 2).

## 4. If you are not satisfied with the action taken:

- Contact the Major Appliance Consumer Action Program (MACAP). MACAP is a group of independent consumer experts that voices consumer views at the highest levels of the major appliance industry.
- Contact MACAP only when the dealer, authorized servicer, and KitchenAid have failed to resolve your problem.

Major Appliance Consumer Action Program  
20 North Wacker Drive  
Chicago, IL 60606

- MACAP will in turn inform us of your action.

### \* When asking for help or service:

Please provide a detailed description of the problem, your appliance's complete model and serial numbers, and the purchase date. (See page 2.) This information will help us respond properly to your request.

### Don't forget, KitchenAid offers a full line of quality home appliances.

Built-In Refrigerators

Trash Compactors

Ranges & Cooktops

Freestanding Refrigerators

Hot Water Dispensers

Microwave Ovens

50-Pound Ice Makers

Food Waste Disposers

Washers & Dryers

Dishwashers

Built-In Ovens

Mixers & Blenders

For more information on these appliances, or the one you have purchased, call our toll-free Consumer Assistance Center telephone number, **1-800-422-1230**.

# KitchenAid® Electric Range Warranty

LENGTH OF WARRANTY:	KITCHENAID WILL PAY FOR:	KITCHENAID WILL NOT PAY FOR:
<b>ONE-YEAR FULL WARRANTY</b> FROM DATE OF PURCHASE.	Replacement parts and repair labor costs to correct defects in materials or workmanship. Service must be provided by an authorized KitchenAid servicing outlet.	<b>A.</b> Service calls to: <ol style="list-style-type: none"> <li>1. Correct the installation of the range.</li> <li>2. Instruct you how to use the range.</li> <li>3. Replace house fuses or correct house wiring.</li> </ol>
<b>SECOND-THROUGH FIFTH-YEAR LIMITED WARRANTY</b> FROM DATE OF PURCHASE.	Replacement parts for any electric element to correct defects in materials or workmanship. Replacement ceramic glass if breakage is due to defects in materials or workmanship.  Replacement parts for solid state touch control system to correct defects in materials or workmanship.	<b>B.</b> Repairs when range is used in other than normal home use. <b>C.</b> Damage resulting from accident, alteration, misuse, abuse, improper installation, or installation not in accordance with local electrical codes. <b>D.</b> Any labor costs during the limited warranties. <b>E.</b> Replacement parts or repair labor costs for units operated outside the United States. <b>F.</b> Pickup and delivery. This product is designed to be repaired in the home.
<b>SECOND-THROUGH TENTH-YEAR LIMITED WARRANTY</b> FROM DATE OF PURCHASE.	Replacement parts for the porcelain oven cavity/inner door if the part rusts through due to defects in materials or workmanship.	<b>G.</b> Repairs to ceramic glass cooktop if it has not been cared for as recommended in this Use and Care Guide. <b>H.</b> Repairs to parts or systems caused by unauthorized modifications made to the appliance.

7/95

**KITCHENAID DOES NOT ASSUME ANY RESPONSIBILITY FOR INCIDENTAL OR CONSEQUENTIAL DAMAGES.** Some states do not allow the exclusion or limitation of incidental or consequential damages, so this exclusion or limitation may not apply to you. This warranty gives you specific legal rights, and you may also have other rights which vary from state to state.

**Outside the United States, a different warranty may apply. For details, please contact your authorized KitchenAid dealer.**

If you need service, first see the "If You Need Assistance or Service" section of this book. After checking "If You Need Assistance or Service," additional help can be found by calling our Consumer Assistance Center telephone number, **1-800-422-1230**, from anywhere in the U.S.A.

KitchenAid  
Benton Harbor, Michigan 49022-2692

## Free Manuals Download Website

<http://myh66.com>

<http://usermanuals.us>

<http://www.somanuals.com>

<http://www.4manuals.cc>

<http://www.manual-lib.com>

<http://www.404manual.com>

<http://www.luxmanual.com>

<http://aubethermostatmanual.com>

Golf course search by state

<http://golfingnear.com>

Email search by domain

<http://emailbydomain.com>

Auto manuals search

<http://auto.somanuals.com>

TV manuals search

<http://tv.somanuals.com>