

# KitchenAid® Side by Side Built-in Refrigerator

## PRODUCT MODEL NUMBERS

KSSC36FM	KSSO42FM	KSSS36QM
KSSC36QM	KSSO42QM	KSSS42FM
KSSC42FM	KSSO48FM	KSSS42QM
KSSC42QM	KSSO48QM	KSSS48FM
KSSC48FM	KSSP36QM	KSSS48QM
KSSC48QM	KSSP42QM	KSSV42FM
KSSO36FM	KSSP48QM	
KSSO36QM	KSSS36FM	

**Electrical:** A 115-volt, 60-Hz, AC-only, 15- or 20-ampere, fused, electrical supply is required. A time-delay fuse or circuit breaker is recommended. It is recommended that a separate circuit serving only this appliance be provided.

**Cold Water Supply:** Connect the ice maker to a cold water line with water pressure between 20 and 120 psi (138 - 827 kPa). If you have questions about your water pressure, call your utility company).

## CABINET OPENING DIMENSIONS

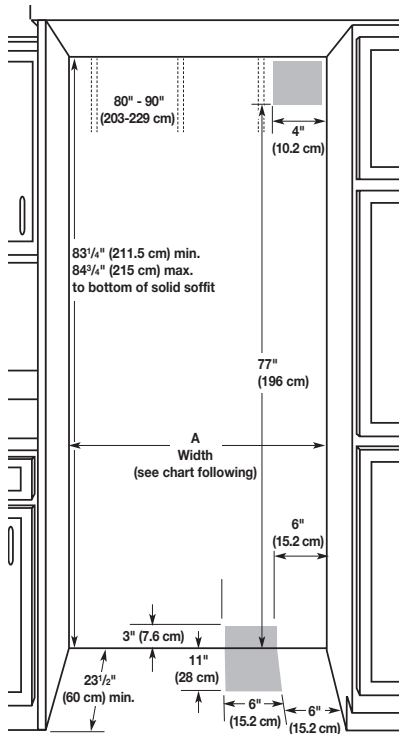

Model	Width A (as shown above)
36 in. (91.4 cm)	35 3/4 in. (90.2 cm)
42 in. (106.7 cm)	41 1/4 in. (105.4 cm)
48 in. (121.9 cm)	47 1/4 in. (120.7 cm)

## DOOR SWING DIMENSIONS

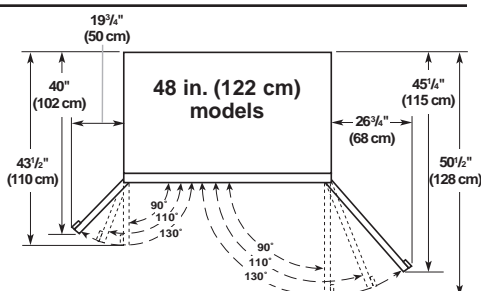
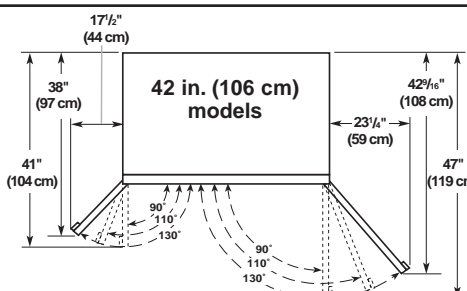
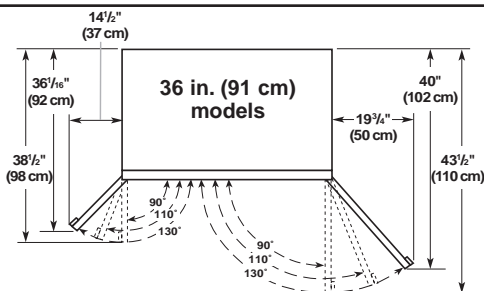

## OVERALL DIMENSIONS

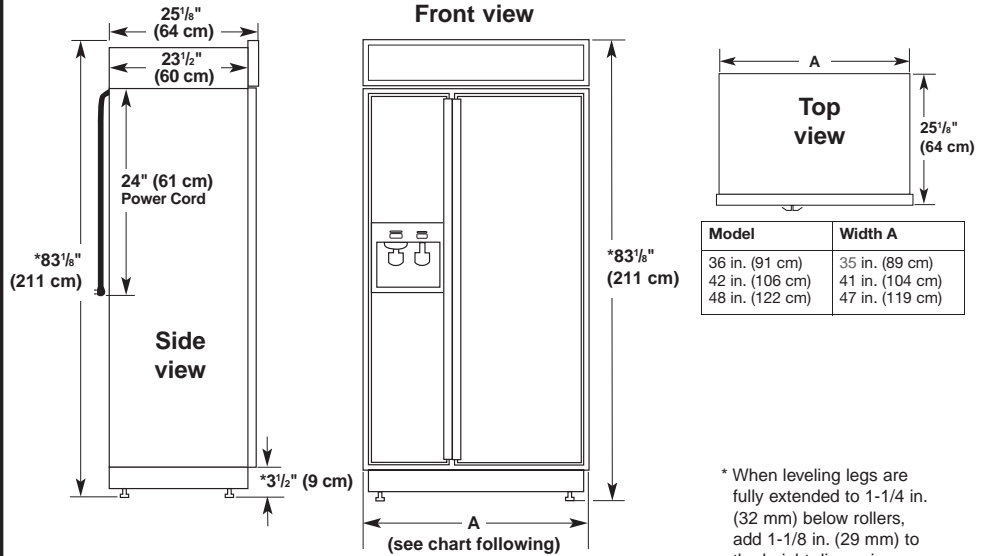

Model	Width A
36 in. (91 cm)	35 in. (89 cm)
42 in. (106 cm)	41 in. (104 cm)
48 in. (122 cm)	47 in. (119 cm)

\* When leveling legs are fully extended to 1-1/4 in. (32 mm) below rollers, add 1-1/8 in. (29 mm) to the height dimensions.

Other model series dispensing, and non-dispensing, with different styling are available.

Model	Width A (Trim edge to trim edge)
36 in. (91 cm)	36 3/4 in. (92 cm)
42 in. (106 cm)	42 1/4 in. (107 cm)
48 in. (122 cm)	48 1/4 in. (123 cm)

## WATER SUPPLY REQUIREMENTS

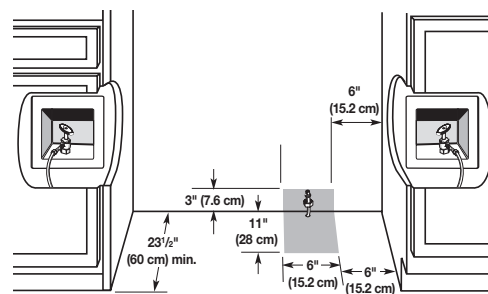

If water shutoff valve is located in base cabinet, access hole through side of cabinet must be within 1/2" (12.7 mm) of rear wall. Right side cabinet is recommended. If water shutoff valve is not in cabinets, water line can come through rear wall or floor in shaded area dimensioned above.

## ANTI-TIP REQUIREMENTS

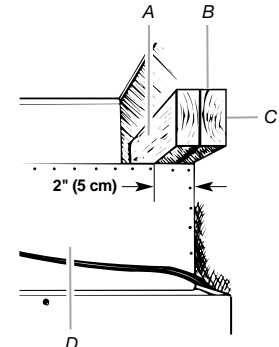

- A. Center board 1/4 in. (6 mm) max. above refrigerator
- B. Two, 2 in. x 4 in. x 32 in. (5 cm x 10 cm x 81 cm) boards
- C. Attach to studs with 6 - #8 x 3 in. (7.6 cm) screws
- D. Compressor cover

The solid soffit must be within 1 in. (2.5 cm) maximum above the refrigerator. If the solid soffit is higher than 1 in. (2.5 cm) or one is not available, prevent the refrigerator from tipping during use as shown.

Board(s) must be long enough to fully cover the width of the compressor cover.

Locate the board(s) so the bottom surface of the board(s) are 84 in. (213 cm) from the floor.

Securely attach one or two 2 in. x 4 in. x 32 in. (5 cm x 10 cm x 81 cm) wood boards to wall studs behind refrigerator. Use 6 - #8 x 3 in. (7.6 mm) (or longer) wood screws. The wood screws must be screwed into the studs at least 1-1/2 in. (3.8 cm). The board(s) must overlap the compressor cover.

## Free Manuals Download Website

<http://myh66.com>

<http://usermanuals.us>

<http://www.somanuals.com>

<http://www.4manuals.cc>

<http://www.manual-lib.com>

<http://www.404manual.com>

<http://www.luxmanual.com>

<http://aubethermostatmanual.com>

Golf course search by state

<http://golfingnear.com>

Email search by domain

<http://emailbydomain.com>

Auto manuals search

<http://auto.somanuals.com>

TV manuals search

<http://tv.somanuals.com>