



KOGAN SMARTERHOME™ 2400W GLASS PANEL HEATER

KASGSHT24BA & KASGSHT24WA

SAFETY & WARNINGS

- Read all instructions fully before using the product for the first time and retain for reference. If passing this product on to a new owner, include a copy of this guide.
- Do not leave this unit unattended while it is in use.
- Some parts of this product can become very hot and cause burns. Particular attention must be given when children and vulnerable people are present. Keep children and pets at a safe distance from the unit.
- This appliance can be used by children aged from 8 years and above and persons with reduced physical, sensory or mental capabilities or lack of experience and knowledge if they have been given supervision or instruction concerning use of the appliance in a safe way and understand the hazards involved.
- Children shall not play with the appliance. Cleaning and user maintenance shall not be made by children without supervision.
- This heater is not equipped with a device to control the room temperature. Do not use this heater in small rooms when occupied by persons not capable of leaving a room on their own, unless constant supervision is provided.
- In order to avoid overheating and potential fire hazard, ensure the heater is not covered. In particular, do not use it for drying clothes.
- Do not attempt to repair this product yourself. If the product or its power supply experiences any malfunction or damage, stop using it immediately and contact Kogan.com to arrange a repair.
- If the power cable is damaged, it must be replaced by the manufacturer, its service agent or similarly qualified persons in order to avoid a hazard.
- Do not handle the element with bare hands. If it is inadvertently touched, remove finger marks with a soft cloth and methylated spirits or alcohol: otherwise, the marks will burn into the element causing premature heater failure.
- This product is suitable for indoor use only.
- Do not use this heater in the immediate surroundings of a bath, shower or swimming pool.
- Do not touch the plug with wet or damp hands.
- Do not run the power cable under carpeting. Do not cover the power cable with rugs, runner or similar coverings. Arrange the power cable away from foot traffic and where it will not be tripped over.
- Do not wind the power cable around the unit.
- Do not insert or allow foreign objects to enter any ventilation or opening on the heater, as this may result in electric shock, fire or damage to the heater.
- Where possible, avoid the use of an extension cable as this may overheat and cause a fire. However, if you have to use an extension cable, ensure it is suitable for

the purpose, has been tested for outdoor use and preferably has an RCD device fitted or attached.

- Always ensure that the heater is plugged into a suitable socket.
- Do not position directly above or below an electrical socket.
- Always use on a dry, suitably strong, stable, flat and level surface.
- Always unplug the unit and ensure that the unit has cooled completely before moving, cleaning or storing.
- This heater is intended for domestic use only and should not be used commercially for contract purposes. Any alternative use, not recommended by Kogan.com, may result in fire, electric shock or injury to persons.
- Check exterior walls for areas of damage before installing the heater.
- Check exterior walls for communication and electrical cables and pipelines. Should any service lines be present in the immediate vicinity do not install your heater, find an alternative location to install this product.
- Do not remove any of the warning stickers or signs from the product.
- This appliance is not intended for use by persons (including children) with reduced physical, sensory or mental capabilities, or lack of experience and knowledge, unless they have been given supervision or instruction concerning use of the appliance by a person responsible for their safety.
- Children should be supervised to ensure that they do not play with the appliance.
- When the appliance is not in use and before cleaning, unplug the appliance from the outlet firstly.
- **WARNING:** In order to avoid overheating, do not cover the heater.
- The heater must not be located immediately below a socket outlet.
- Do not use this heater if it has been dropped.
- Do not use if there are visible signs of damage to the heater.
- Use this heater on a horizontal and stable surface, or attach it to the wall.
- **WARNING:** Do not use this heater in small rooms when they are occupied by persons not capable of leaving the room on their own, unless constant supervision is provided.
- **WARNING:** To reduce the risk of fire, keep textiles, curtains, or any other flammable material a minimum distance of 1 metre from the air outlet.
- The heater is to be installed so that switches and other controls cannot be touched by a person in the bath or shower.

OVERVIEW

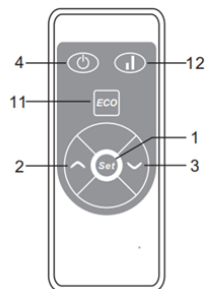
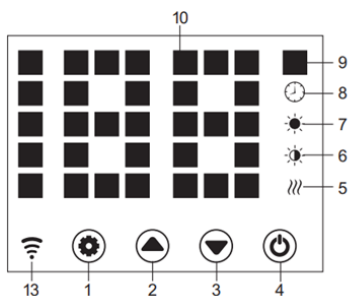
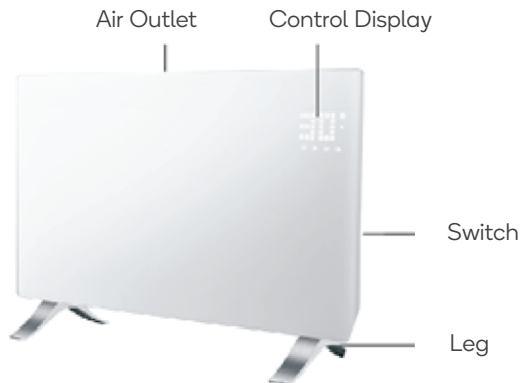

1	Setting button	8	Timer indicator
2	Up button	9	Temperature (°C) indicator
3	Down button	10	LED number display
4	Power button	11	LED screen on-off button
5	Heating element working indicator	12	Low/High heating selection
6	Low heating indicator	13	Wi-Fi Indicator (solid when connected; otherwise, flashing)
7	High heating indicator		

- Power Input: 220-240V-50-60Hz
- Power Consumption: 1200-2400W

INSTALLATION

Leg Installation

Remove the heater and all accessories from the packing.

1. Place the heater on a flat, dry and clean surface. Install the legs as illustrated:

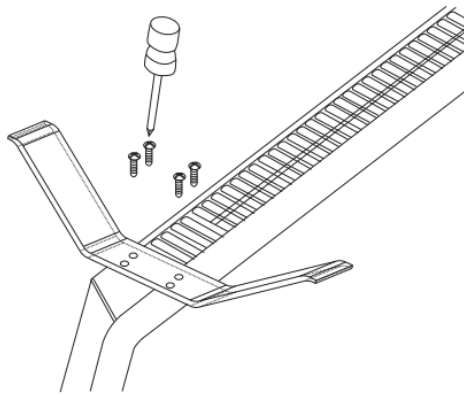

2. Turn the heater right-side up and ensure it sits firmly on its legs.
 - A. Make sure there is no breakage or crack on the power cord before its first use.
 - B. Make sure that the rating power on product is same with your local power and the socket with safety grounding equipment or replace the socket for safety use.

Wall Mount Installation

Note:

The heater MUST be installed with the minimum required distance at the four sides of the heater.

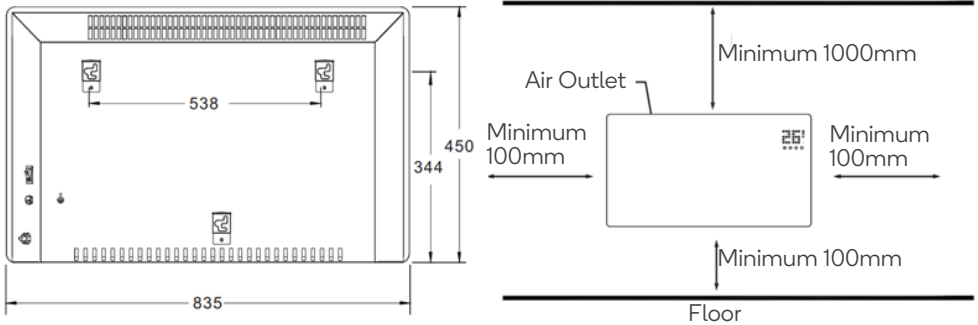

Drill holes at each side on the wall and insert the plastic expanded plugs within. Attach the bracket to the wall with screws.

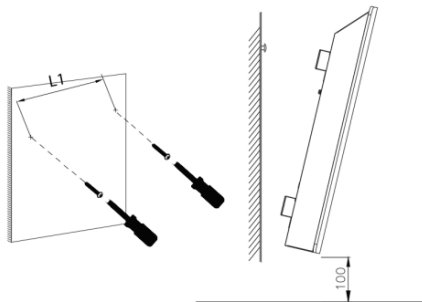

Place the heater onto the bracket, ensuring that the holes align.

Tighten screws on the top of bracket to secure.

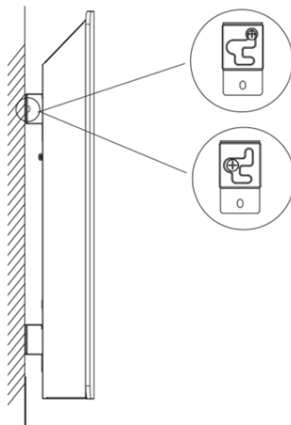

To remove the heater from the bracket, pull it 5mm outward and then move it 10mm to the left.

APP INSTALLATION

Download the “Kogan SmarterHome™” app from the Play Store (Android) or App Store (iOS).

If you do not have a Kogan SmarterHome™ account, register or sign in with a verification code sent by SMS.

To Register

1. Tap to enter registration page.
2. The system automatically recognises your country/area. You can also select your country code manually. Enter your mobile phone number/email address and tap “Next”.
3. If you choose the mobile phone number option, then enter the verification code in the message sent to you by SMS. Set a password as prompted and press “Confirm” to finish your registration.

← Register

Region Australia +61 >

Mobile Number/E-mail

Next

By clicking next, you agree to the [Kogan.com Terms & Conditions](#)

← Register

Region Australia +61 >

XXXXXXXXXX

Next

By clicking next, you agree to the [Kogan.com Terms & Conditions](#)

Add Device Through Network

1. Power the **SmarterHome™** device on and follow the product-specific instructions to enter the Wi-Fi-connect mode.
2. Open Kogan **SmarterHome™** app and tap “+” in the upper right to add a new device through the network.
3. Ensure the device’s indicator light rapidly flashes and tap “Confirm light is rapidly flashing”.
4. Select Wi-Fi network (note: Network must be 2.4GHz band) and enter the password.

The device will commence the pairing process and connect to the app.

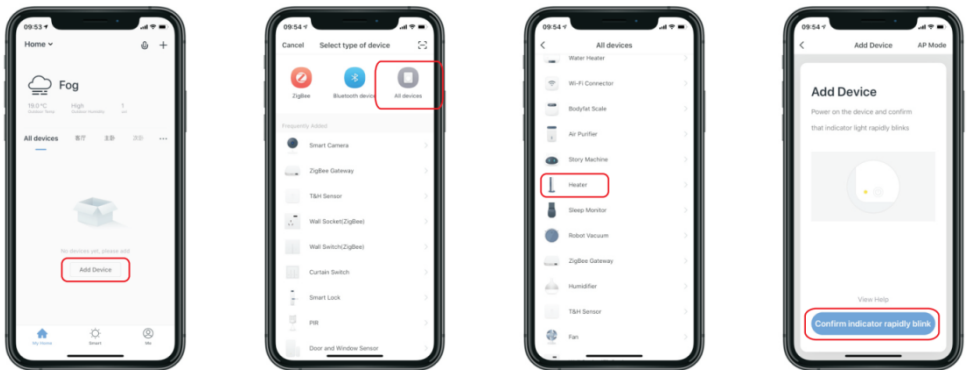

5. After successfully configuring the devices, the device will be shown on the home page. Tap to enter its control page.

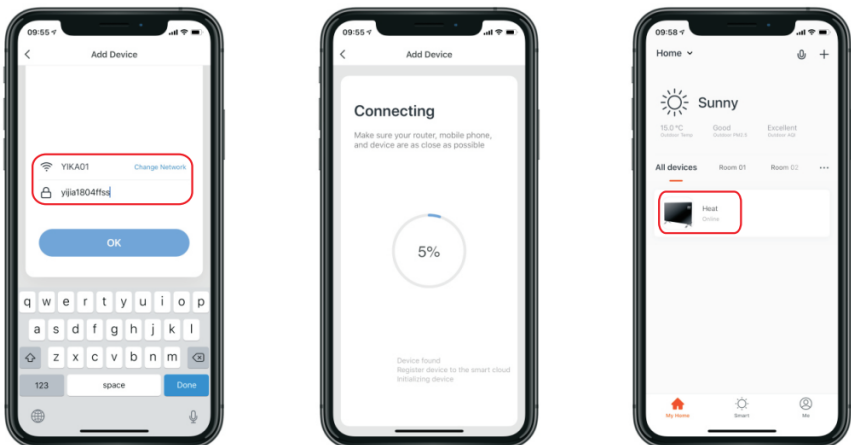

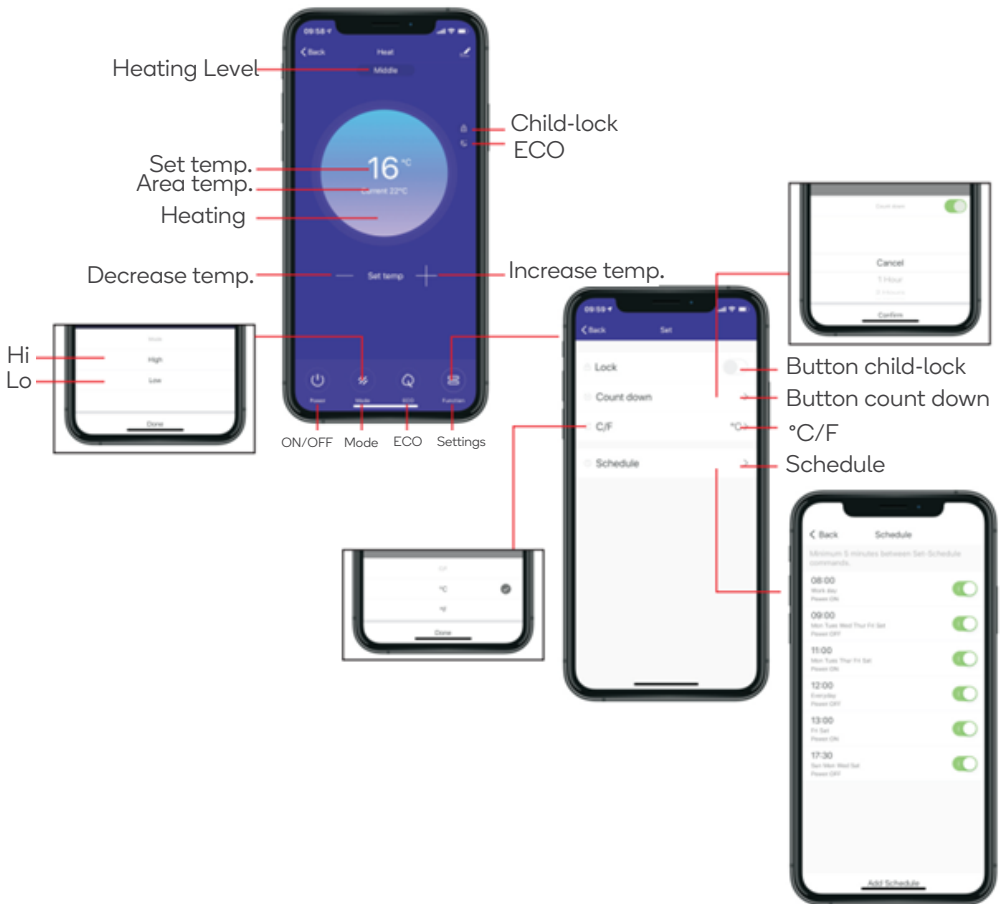

Note:

- When device is online, it can be controlled.
- When device is offline, it displays “Offline” and cannot be remotely powered on.

GOOGLE HOME CONTROL

Note: You will need to have set up a Google Home account prior to linking your Kogan SmarterHome™ device.

1. Select “Menu” and then “Home Control”.
2. In the “Home Control” screen, select the “+” icon in the bottom right.
3. A list will appear showing actions and a search function to access more apps: from here, install the SmarterHome™ app.

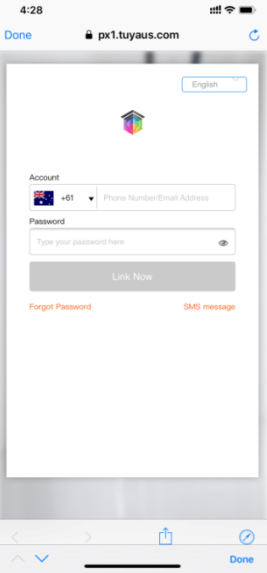
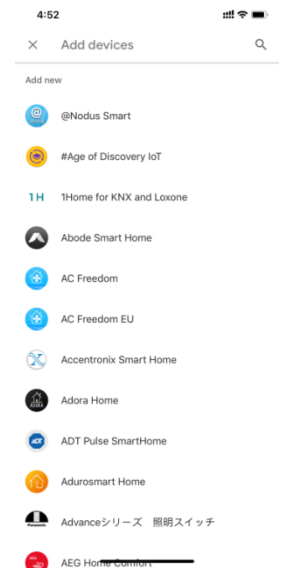
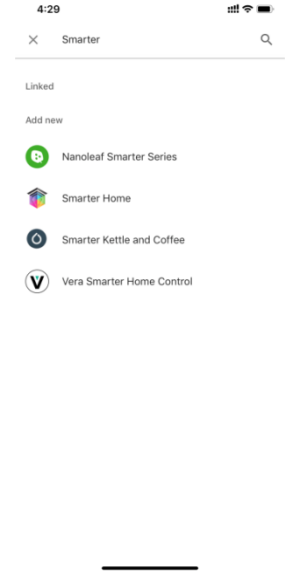
		
<p>Login to App</p>	<p>Add Device</p>	<p>Select Device</p>

4. Log into your SmarterHome™ account with your email address or mobile number.
5. Once linked, it will show the devices linked to your account: You can assign them to rooms. You will be prompted to authorise apps to sync.
6. Click “Done” and then it will give you a list of commands available.
7. When successfully linked, you will see it on your “Home Control” screen at the bottom of the app screen. You can now control your Kogan SmarterHome™ devices through Google Home.

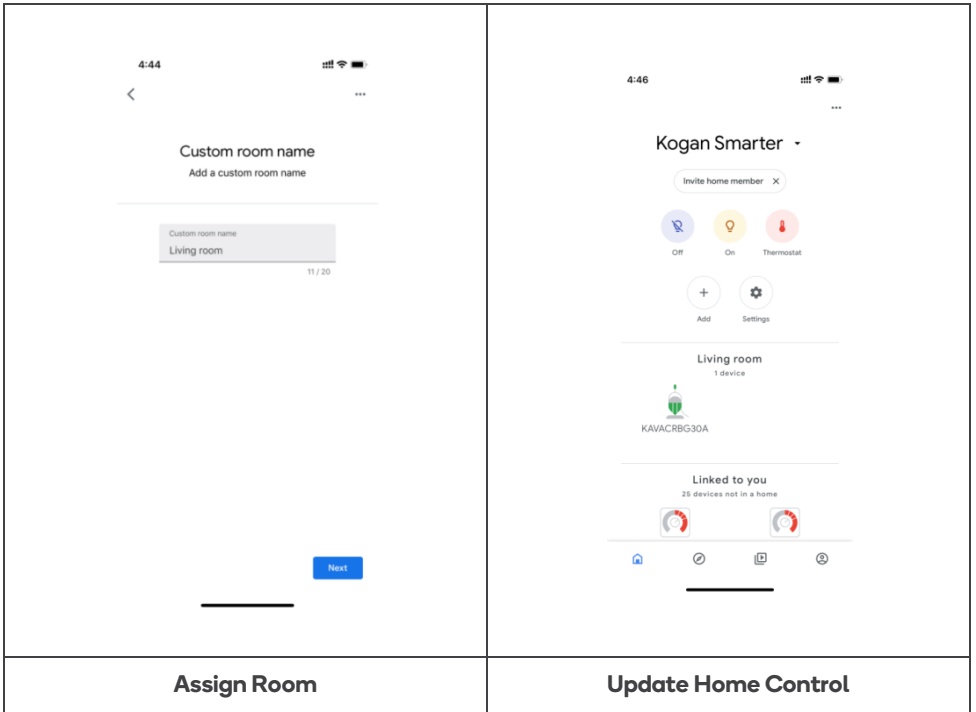
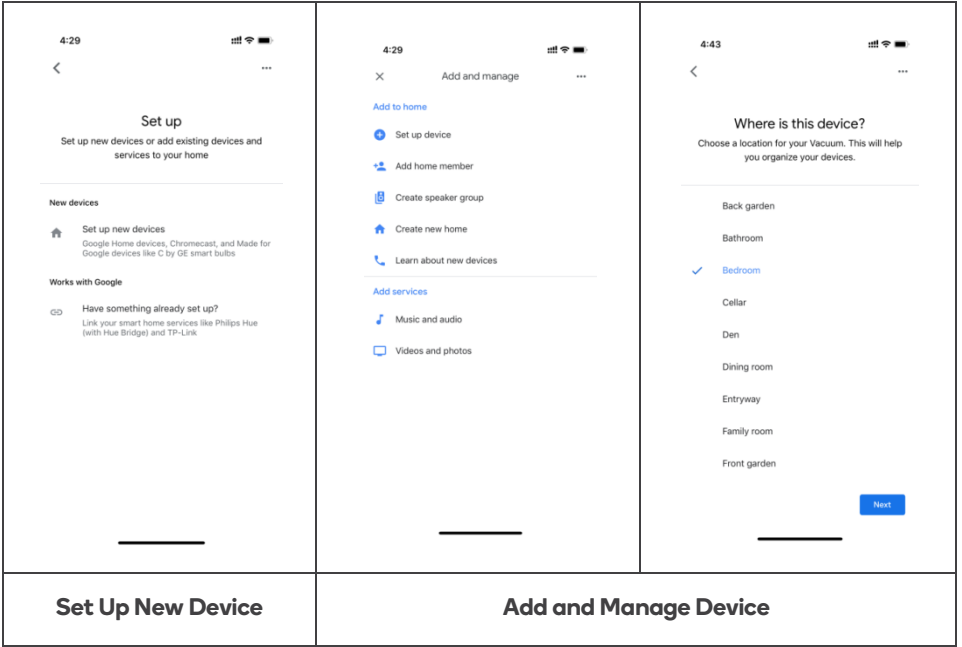

ALEXA

Note: You will need to have set up an Alexa account prior to linking your Kogan SmarterHome™ device.

1. Select “Menu” and then “Skills”.
2. Search for the app and enable it.
3. Login to your SmarterHome™ account with your email address or mobile number.
4. Select “Discover Devices” and the app will begin searching.
5. When successfully linked, you will see a list of connected Kogan SmarterHome™ devices. You can now control your Kogan SmarterHome™ devices through Alexa with your voice.

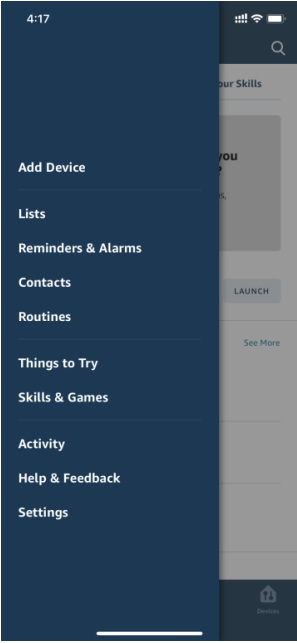
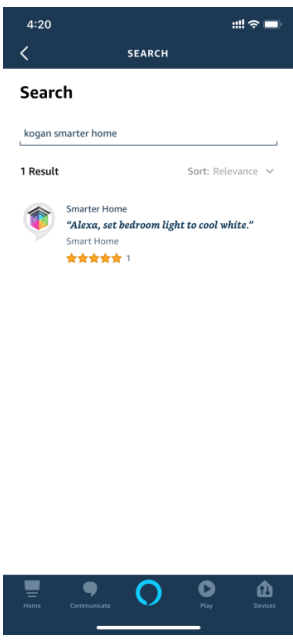
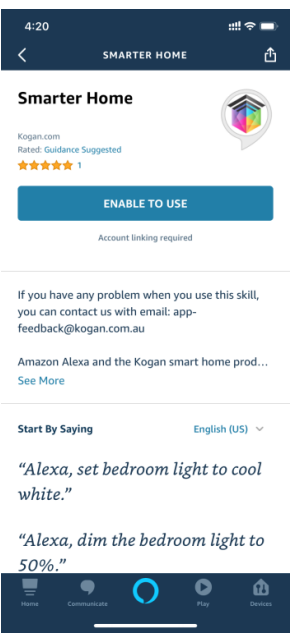
 <p>A screenshot of the Alexa mobile app interface. The time is 4:17. A dark blue menu is open on the left side, listing various categories: Add Device, Lists, Reminders & Alarms, Contacts, Routines, Things to Try, Skills & Games, Activity, Help & Feedback, and Settings. The background shows a blurred view of the Skills page.</p>	 <p>A screenshot of the Alexa mobile app search results page. The time is 4:20. The search bar contains "kogan smarter home". Below the search bar, it says "1 Result" and "Sort: Relevance". The result is for the "Smarter Home" skill, with a rating of 1 star and the text "Alexa, set bedroom light to cool white." The bottom navigation bar shows Home, Communicate, Play, and Devices.</p>	 <p>A screenshot of the Alexa mobile app skill enable page for "Smarter Home". The time is 4:20. The page shows the skill name, a rating of 1 star, and a blue "ENABLE TO USE" button. Below the button, it says "Account linking required". There is a link to contact support: "If you have any problem when you use this skill, you can contact us with email: app-feedback@kogan.com.au". There is also a link to "Amazon Alexa and the Kogan smart home prod..." and a "Start By Saying" section with the text "Alexa, set bedroom light to cool white." and "Alexa, dim the bedroom light to 50%." The bottom navigation bar shows Home, Communicate, Play, and Devices.</p>
<p>Alexa Account Setup</p>	<p>Search App in All Skills</p>	<p>Enable App</p>



Login to App

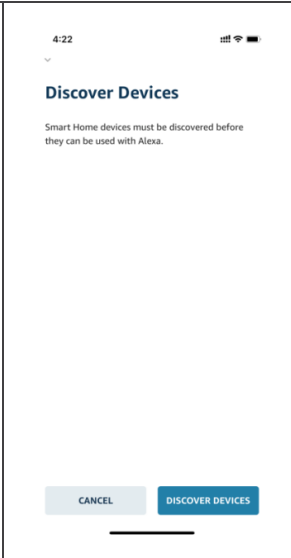

Discover Devices

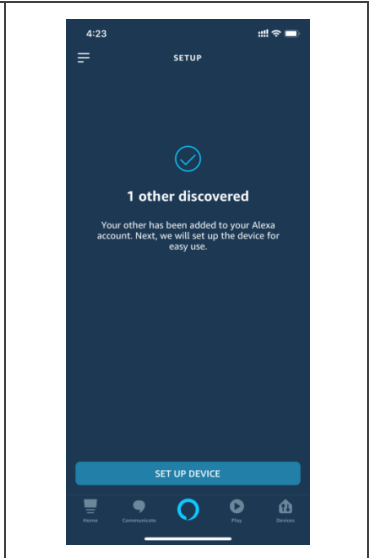

Setup Device

OPERATION

Turn On

1. Connect the heater to a power socket and turn on the main switch; the heater will be in standby.
2. Press the power buttons to begin heating operation; the display will show the current ambient temperature.
3. Press the setting button and the heater will enter temperature setting mode. Use the up and down buttons to select the desired temperature.

Temperature Setting

1. Press the setting button first to enter the temperature setting mode. Use the up and down buttons to select the desired temperature (5–45°C).
The selected temperature will be set when there is no input for 5 seconds.

Timer Setting

With a timer set, the heater will turn off automatically once the set time has been reached.

1. Press the setting button twice to enter the timer setting mode. Use the up and down buttons to select the desired timer (in hours).
2. The current timer setting will be accepted when there is no input for 5 seconds.

High/Low Heat Mode Selection

1. During operation:
 - The heating level button on the remote will toggle between high and low heat mode.
 - The up button on the heater and the remote will toggle between high heat mode and turning the heating off.
 - The down button on the heater and the remote will toggle between low heat mode and turning the heating off.
2. During operation, the relevant heating indicator will be illuminated.

Child-Lock Function

1. In heating mode, press and hold both up and down buttons for 3 seconds and the child lock function will be enabled. After 5 seconds, the display will show the ambient temperature.
2. To remove the child lock, press and hold both up and down buttons for 3 seconds again.

Display Buttons Activation

During operation, the display buttons will not be illuminated. Touch the panel below the display and they will come on.

Eco Function (Night Mode)

In heating mode, press 1 and 3 for 3 seconds (press ECO on Remote Control), ECO function runs. In this mode, display shows only some indicator (5 or 6 or 7 or 8, depending on which setting has been done before ECO runs)

Celsius/Fahrenheit Display

Press and hold both the setting and up buttons for 10 seconds.

Open Window Detection

- If the temperature decreases by 3°C or more in 2 minutes, the Open Window detection will take effect and the heater will stop heating. The temperature indicator will flash.
- To restore normal operation, use the power button to turn the heater off, then turn it on again after a few seconds.

Wi-Fi Reset

During operation, press and hold the setting button for 3 seconds.

Wi-Fi will now be reset, and the Wi-Fi indicator light will be on.

Turn Off

Press the power button to turn the heater off.



Need more information?

We hope that this user guide has given you the assistance needed for a simple set-up. For the most up-to-date guide for your product, as well as any additional assistance you may require, head online to **help.kogan.com**

kogan

Free Manuals Download Website

<http://myh66.com>

<http://usermanuals.us>

<http://www.somanuals.com>

<http://www.4manuals.cc>

<http://www.manual-lib.com>

<http://www.404manual.com>

<http://www.luxmanual.com>

<http://aubethermostatmanual.com>

Golf course search by state

<http://golfingnear.com>

Email search by domain

<http://emailbydomain.com>

Auto manuals search

<http://auto.somanuals.com>

TV manuals search

<http://tv.somanuals.com>