

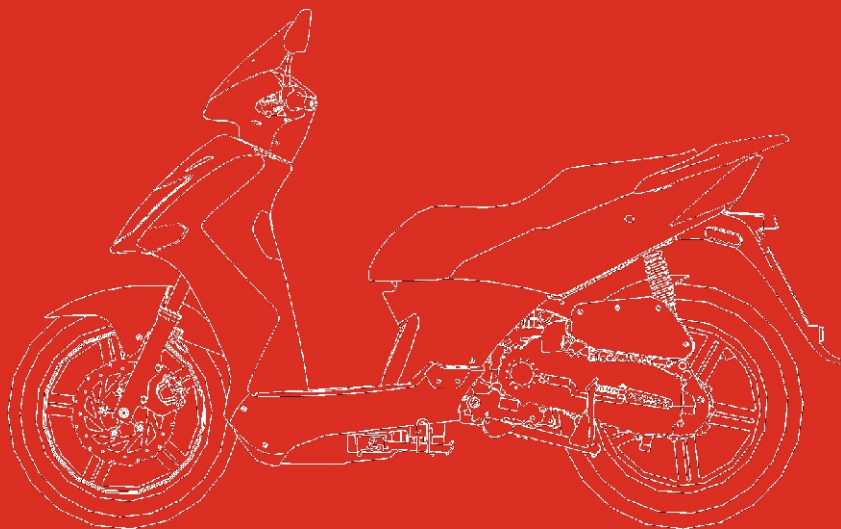

DRIVER'S MANUAL

KWANG YANG MOTOR CO.,LTD.

AGILITY CITY **50/125**





KWANG YANG MOTOR CO.,LTD.

NO.35 Wan Hsing Street, San Min District

Kaohsiung, Taiwan, Republic of PROC

Telephone : 886-7-3822526

FAX : 886-7-3950021

Dear KYMCO Motorcycle Users:

Thank you for purchasing this KYMCO motorcycle and welcome to the family of KYMCO motorcycle riders. To enjoy safety and more pleasant riding, become thoroughly familiar with this driver's manual before your ride the motorcycle.

Your safety depends not only on your own alertness and familiarity with the motorcycle but also the motorcycle mechanical condition. A pre-ride inspection before every outing and regular maintenance are essential. the quality of each KYMCO motorcycle is guaranteed.

Note:1.The information and specifications stated in this manual are for reference only and subject to change without notice.

2.When starting the engine, the battery must be installed to facilitate Starting and increase the engine performance.

3,Our company reserves the right to make any alteration in the design..If the product Is not the same as Manual.please according to the actual product.

We will not notice you again.

TABLE OF CONTENTS

1. PRECAUTIONS FOR A SAFE RIDING ————— 1

2. ASSEMBLY PARTS ————— 3

3. OPERATION INSTRUCTIONS ————— 5

 IGNITION SWITCH/STEERING&HANDLEBAR LOCK ————— 5

 ELECTRIC STARTER BUTTON. HEADLIGHT SWITCH ————— 6

 HEADLIGHT DIMMER SWITCH ————— 7

 HORN BUTTON/TURN SIGNAL SWITCH ————— 7

 SEAT LOCK/MET-IN BOX. HELMET BUCKLE ————— 8

 INSTRUMENTS ————— 9

4. PRE-RIDE INSPECTION ————— 10

 ADVANCE INSPECTION. ENGINE OIL LEVEL INSPECTION/REFILLING ————— 10

 BRAKE INSPECTION. TIRE INSPECTION ————— 11

 FUEL LEVEL INSPECTION/REFILLING ————— 13

 STEERING HANDLEBAR. INSTRUMENT LIGHTS INSPECTION ————— 14

 BRAKE LEVER FREE PLAY INSPECTION&ADJUSTMENT ————— 15

 CHOKE KNOB ————— 16



TABLE OF CONTENTS

5.ENGINE STARTING METHODS	18
USE THE ELECTRIC STARTER BUTTON	19
START WITH THE KICK LEVER	20
6.NORMAL RIDING METHOD	21
7.PRECAUTIONS FOR RIDING	23
8.HOW TO STOP RIDING	26
9.EASY MAINTENANCE	28
AIR CLEANER INSPECTION AND AIR CLEANER CLEANING&REPLACEMENT	28
BATTERY	30
FUSE CHANGE	31
ENGINE OIL CHANGE	32
SPARK PLUG INSPECTION	34
10.IMPORTANT NOTICES	36
11.EXEXHAUST EMISSION CONTROL SYSTEM	37
12.POLLUTION-FREE PERIODIC MAINTENANCE SCHEDULE	39
13.SPECIFICATIONS	40

1. PRECAUTIONS FOR A SAFE RIDING

(1) CLOTHES

To relax and wear comfortable clothes are the main points for a safe riding.

To observe traffic laws, keep a cool mind, relax and be careful will provide you a safe riding.

- ① Wear helmet and fasten it tightly.
- ② Have the clothes well-arranged. Fasten shirt cuffs and keep them from hooking the brake lever.
- ③ Wear low-heeled shoes for a safe riding.
- ④ When riding, use both hands to grasp the handlebar. It is very dangerous to hold the handlebar with one hand.

▲ CAUTION:

A motorcycle rider should not wear loose or too long clothes to avoid danger.

During riding or 10 minutes after the motorcycle is stopped, do not touch the exhaust muffler to avoid scalding.

When parking the motorcycle, keep it away from dry lawn or inflammables to avoid danger.

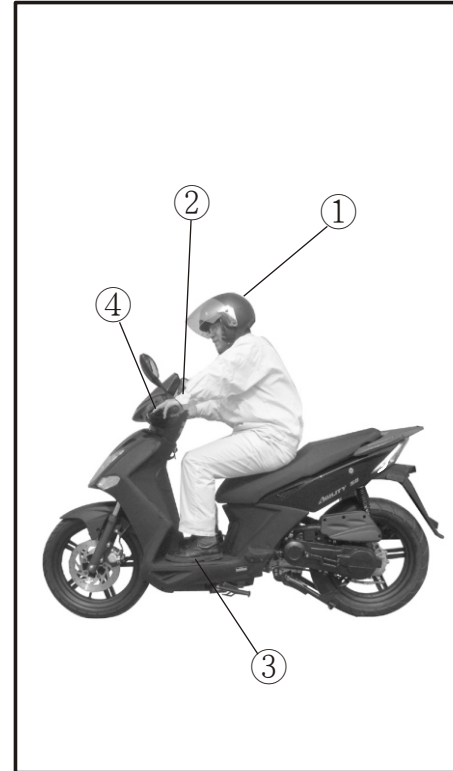

(2) RIDING METHOD

The safety of two-wheel vehicles is influenced by sitting position. The rider should sit on the central part of the seat cushion. If the rider sits on the rear part of the seat, the load of front wheel will decrease. As a result, the handlebar will swing and cause danger to the rider. When making a turn, it will be easier for the rider to steer the motorcycle by leaning the body inward slightly. The motorcycle will lose its balance if the rider fails to keep his body leaning inward.

When riding on a damaged or macadam road. Slow down the speed and hold the handlebar tightly.



(3) CARRYING GOODS

Keep a good sitting posture to operate the motorcycle properly.

The feel of the handlebar will be different when carrying goods on the motorcycle. Overloading may cause the handlebar to swing. Avoid riding with overload.

① Max. loading capacity of the met-in box is 5kg.



2. ASSEMBLY PARTS

- ① Met-in Box
- ② Rear Brake Lever
- ③ Taillight/Stoplight
- ④ L. Rear Turn Signal Light
- ⑤ Kick Lever
- ⑥ Engine Serial Number
- ⑦ Main Stand
- ⑧ L. Front Turn Signal Light
- ⑨ Fuel Filler
- ⑩ Turn Signal Switch
Headlight Dimmer
Switch
Passing Signal Switch
Horn Button

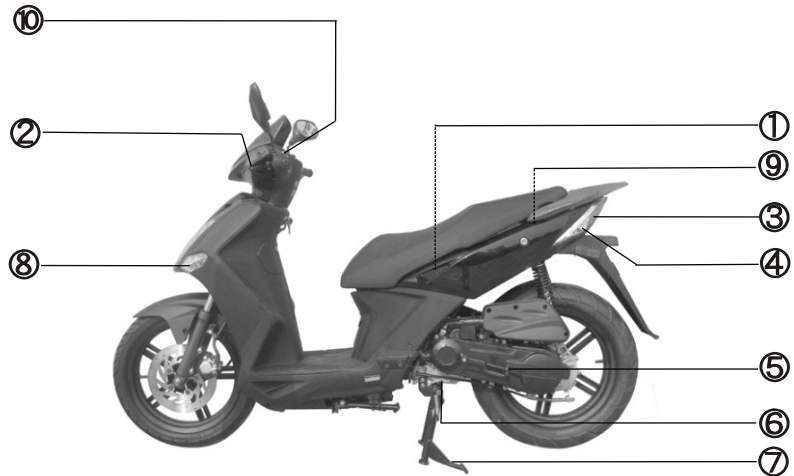

- ① Headlight Switch
Electric Starter Button
- ② Ignition Switch
- ③ R. Front Turn
Signal Light
- ④ Rear Brake Lever
- ⑤ Exhaust Muffler
- ⑥ R.Rear Turn
Signal Light
- ⑦ Rear Carrier
- ⑧ Battery
- ⑨ Frame Serial Number
- ⑩ Instruments

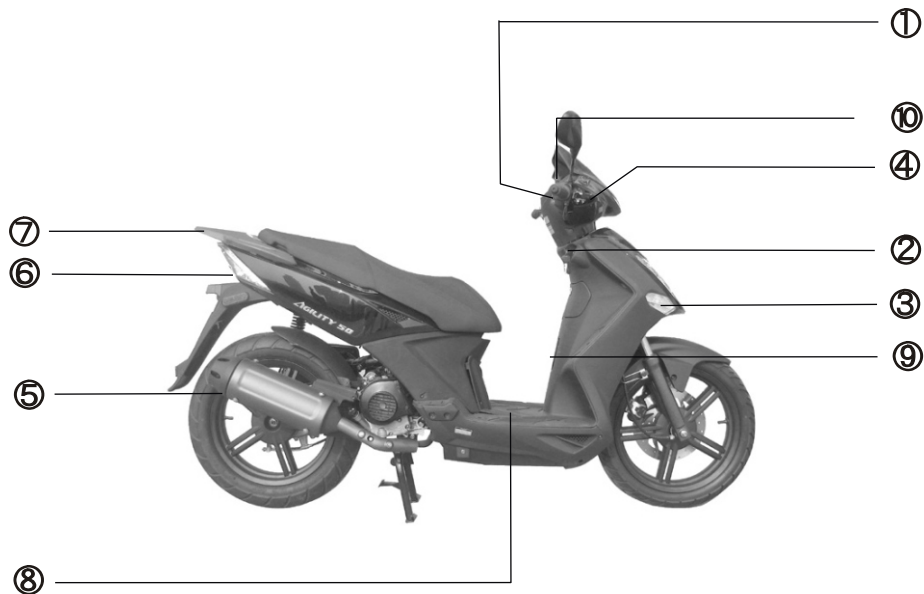

3. OPERATION INSTRUCTIONS

(1) IGNITION SWITCH/STEERING&HANDLEBAR LOCK

ON : At this position, power is connected to start the engine. The key cannot be taken out.

OFF : At this position, power is cut off and the engine stops. The key can be taken out.

LOCK : At this position, the steering handlebar is locked. The key can be taken out

Locking Method

Turn the steering handlebar left to the full and then push and turn the ignition switch key left to the "LOCK" position ,the handlebar can be locked.

Unlocking Method

Turn the ignition switch key right to the "OFF" and the "LOCK" is released automatically.

▲ CAUTION:

After locking, turn the handlebar gently to make sure that it is locked.

Do not turn the ignition switch to the "LOCK" Position during riding, otherwise the handlebar will be out of control and cause accidents.

Don't park your motorcycle at a place to hinder the traffic.

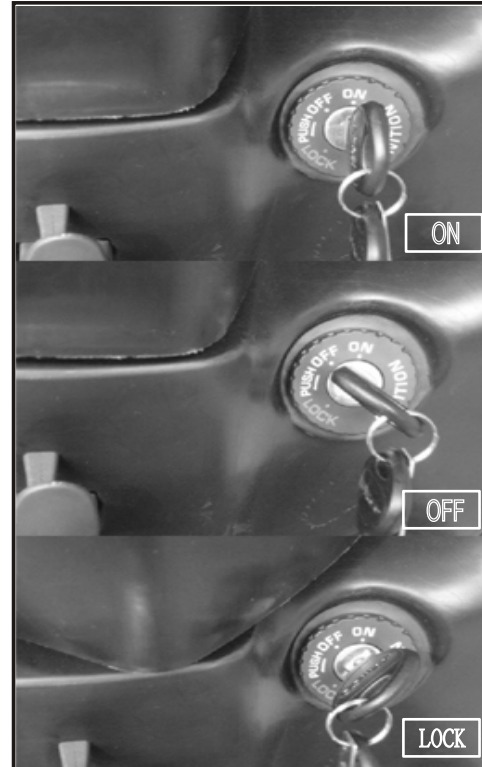

(2) ELECTRIC STARTER BUTTON

To start the engine, first turn on the ignition switch and then push the electric starter button. At this time, be sure to fully apply the front or rear brake lever (pedal) in order to connect the power.

▲ CAUTION:

During engine running, do not push the electric starter button to avoid engine damage.

Turn the headlight switch off and turn signal switch off before using the electric starter button.

Release the electric starter button immediately after the engine is started.

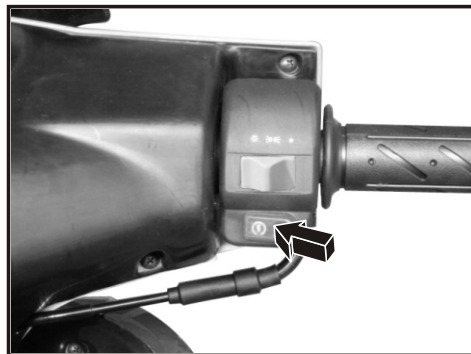

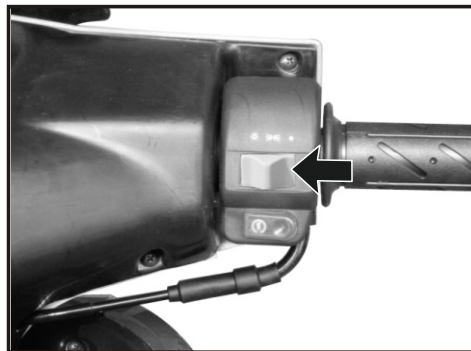

(3) HEADLIGHT SWITCH

- At this position, the position light, headlight, instrument lights and taillight turn off together.
- ☰ At this position, the position light, instrument lights and taillight light turn on.
- ☼ At this position, the position light, headlight, instrument lights and taillight light all turn on.



(4) HEADLIGHT DIMMER SWITCH



- ①  Switch to this position for using high beam.
- ②  When riding in downtown area or there is a car coming from the opposite direction, use low beam to avoid affecting the visibility of coming cars.

- ③ **PASSING**
When passing, if there are cars coming from the opposite direction, press and release the PASSING switch and the headlight will wink to warn the coming cars.

▲ CAUTION:

This indicator comes on when the long distance light is turned on.

(5) HORN BUTTON/TURN SIGNAL SWITCH

When the ignition switch key is turned the "ON" position, push the horn button and it will sound. For turning to the right.  For turning to the left.  Push the turn signal switch button to release it. Horn button. 

The horn and turn signal switch do not work when the ignition switch is the "OFF".

▲ CAUTION:

The turn signal light will not release automatically. Be sure to reset it after use; otherwise it may affect the traffic safety.

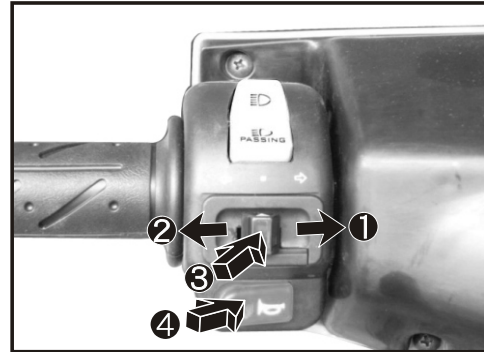
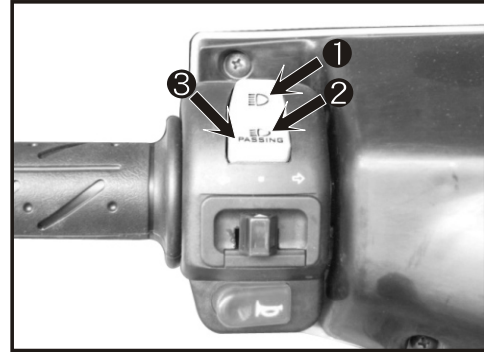

(6) SEAT LOCK/MET-IN BOX

Unlock the seat and put the helmet in the MET-IN box.

<<Unlocking Method>>

Stop the engine and turn the ignition switch to the "OFF" position. Insert the ignition switch key into the seat lock and turn it right.

To lock the seat, push on it until it lock automatically.

Make sure the seat is secure before riding.

▲ CAUTION:

Never put the key inside the seat cushion to lock the seat.



(7) HELMET BUCKLE

1. Open the seat with the ignition switch key and lift up the seat.

2. Put the helmet retaining ring into the helmet buckle.

3. Put down the seat and it will lock automatically.

Take out the helmet in the reserve order of the above steps.

▲ CAUTION:

When riding, wear the helmet and do not retain it on the motorcycle to avoid damage of coated parts.

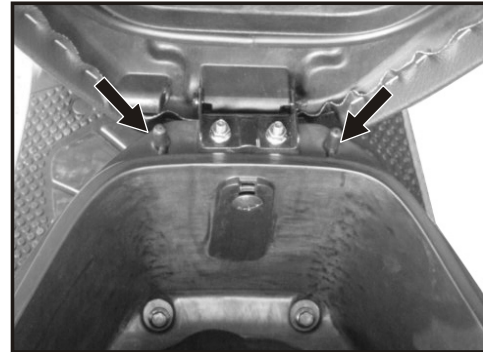

(8) INSTRUMENTS

- ① **MILIMETRE COUNTER:** The total riding mileage is indicated by kilometer. The figure in black and white is an unit of 100m.
- ② **TURN SIGNAL INDICATOR LIGHT:** When the turn signal switch is operated, this indicator will wink.
- ③ **HIGH BEAM INDICATOR LIGHT:** This indicator comes on when the long distance light is turned on.
- ④ **FUEL GAUGE:** The fuel gauge is to show the volume of gasoline in the fuel tank. If the fuel gauge pointer is at the red area, the fuel is insufficient. Refill nonleaded gasoline as soon as possible.
- ⑤ **SPEEDOMETER:** The riding speed is indicated by km/hour or mph.
- ⑥ **CLOCK:** Display the time.
- ⑦ **CLOCK SETTING BUTTON:** The clock time setting.
- ⑧ **CLOCK ADJUST BUTTON:** The clock time adjust.

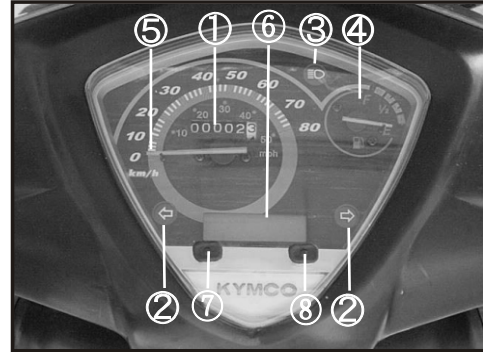

4. PRE-RIDE INSPECTION

(1) ADVANCE INSPECTION

Get into a good habit of inspection before riding. For the sake of safety and to prevent vehicle damage and traffic accidents, the pre-ride inspection is absolutely required.

▲ CAUTION:

Be sure to perform inspection and maintenance for your new motorcycle after it is ridden for 300km.

(2) ENGINE OIL LEVEL INSPECTION/REFILLING

Place the motorcycle on its main stand. Take out the oil dipstick and wipe it clean.

Directly insert the oil dipstick into the engine oil.

(Don't screw it in.)

Take out the oil dipstick and check the oil level. If it is close to the lower limit, add engine oil to the upper limit.

▲ CAUTION:

Check the oil level every 1000km.

The temperature of engine and exhaust muffler is very high. When checking the oil level, be careful to avoid scalding.

Riding with insufficient engine oil will cause breakdown easily.

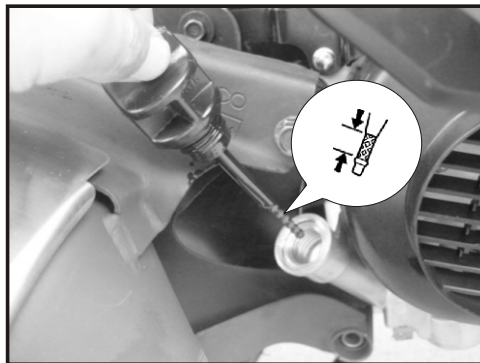

(3) BRAKE INSPECTION

Ride the motorcycle at low speed on a dry road and respectively apply the front brake lever and rear brake pedal to check the brake performance.

The brake lever should have proper free play.

"Free play" means the distance from the position of loose brake to the position of fully applied brake.

Measure the free play at the brake lever end and check if it is within the specified value of (1-2cm rear brake).

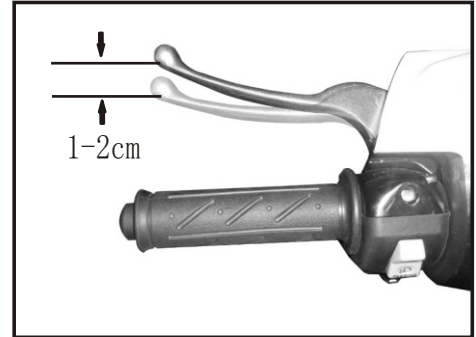

(4) TIRE INSPECTION

1. TIRE PRESSURE CHECK

Check if the tire pressure is normal when the tire is in contact with level ground.

If there is any abnormal condition, check the tire pressure with a tire pressure gauge.

Measure the tire pressure under room temperature.

The tire pressure must not overpass $2.50\text{kg}/\text{cm}^2$

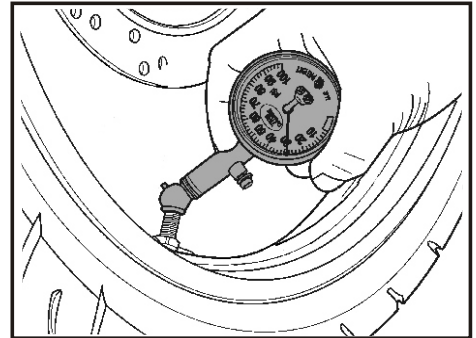

2. CRACKS & DAMAGE

Check the tire-contact area for crack or damage.

3. ABNORMAL WEAR

Check the tire-contact area for abnormal wear.

4. FOREIGN OBJECTS OF METAL PIECE & GRAVEL

Check the tires and tire-contact area for imbedded objects of metal piece and gravel.

5. DEPTH OF TIRE GROOVE

If the tire is worn to the wear limit indication mark, replace it with a new one.

NORMAL PRESSURE(1 Rider / 2 Riders)	
Front Wheel	1.75/kg/cm ²
Rear Wheel	2.0/2.25 kg/cm ²

▲ CAUTION:

Abnormal tire pressure, crack, damage and abnormal wear will cause unsteady handlebar and result in tire break.

If the tire has cracks or is worn to the wear limit indication mark, replace it with a new one.

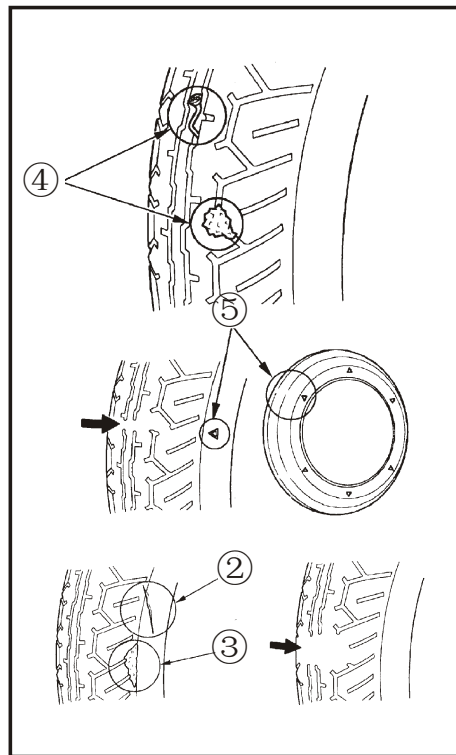

(5) FUEL LEVEL INSPECTION/REFILLING

Check if the fuel is sufficient.

If the fuel gauge pointer is at red grid, refill #92 or #95 nonleaded gasoline as soon as possible.

<<Refilling Method>>

1. Stop the engine and turn the ignition switch to the "OFF" position.
2. Insert the ignition switch key into seat lock (Refer to P8), and turn it right to unlock the seat.
3. Open the seat.
4. Turn the fuel tank cap counterclockwise with hand to open the cap.
5. Turn the fuel tank cap clockwise to tighten it.
6. Close the fuel tank cap in the reverse order of opening.

① Unlock ② Lock

▲ CAUTION:

Be sure to stop the engine before refilling.

The gasoline level shall not exceed the reference plate; otherwise the fuel will penetrate out.

When refilling, do not add other additives to avoid engine breakdown.

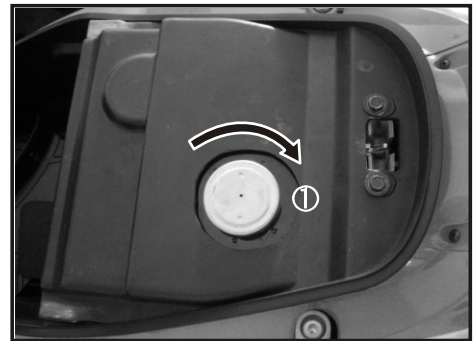
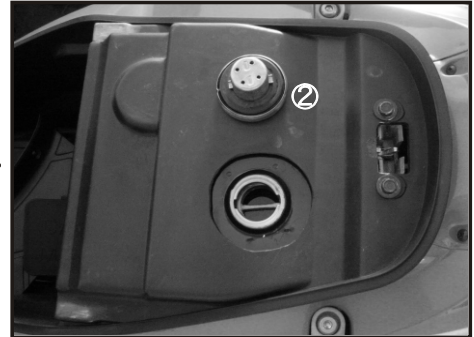

(6) STEERING HANDLEBAR

Visually inspect the steering handlebar for damage.

Apply the front brake and move the handlebar upward and downward to check for abnormal noise.

Move the steering handlebar upward, downward, rightward and leftward to check for any loose parts.

Check if the handlebar rotates freely.

If any abnormal condition is found, go to your motorcycle dealer or for inspection.

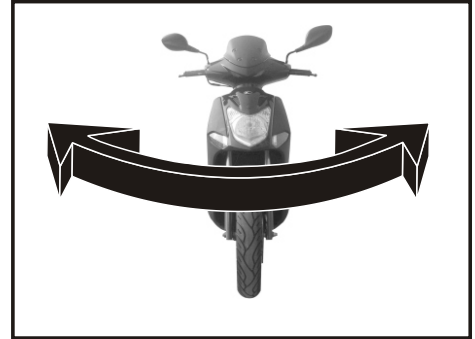

(7) INSTRUMENT LIGHTS INSPECTION

① Check the speedometer pointer for proper operation.

② Check the fuel gauge pointer for proper operation.

③ Check the turn signal indicator and high beam indicator for proper operation.

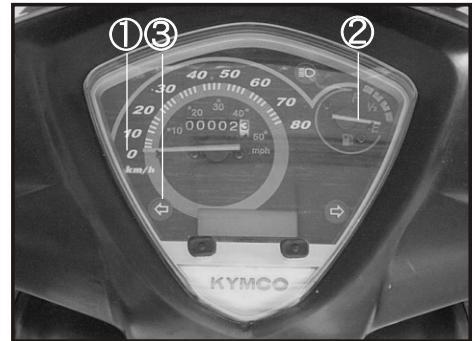

(8) BRAKE LEVER FREE PLAY INSPECTION & ADJUSTMENT

Adjust the rear brake pedal free play with the brake adjusting nuts.

After adjustment, fully apply the rear brake pedal and check if the free play is within the specified value (1-2cm).

▲ CAUTION:

After the brake is adjusted, align the groove of adjusting nut with the pin in order to avoid accident and danger during riding.

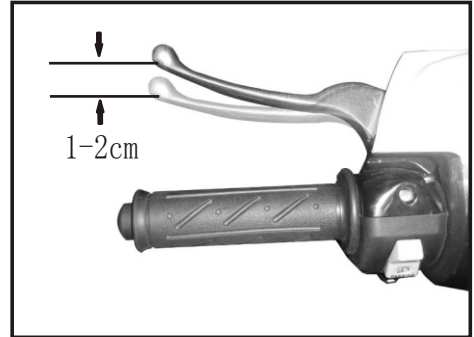

(9) BRAKE SHOE INSPECTION

When the brake lever is fully applied, if the mark "}" on the brake indicator aligns with the reference mark "}" on the brake panel, it means the brake shoe is worn out. Go to our designated distributors or service stations for brake shoe replacing.

Brake shoe service limit: ① Front ② Rear

▲ CAUTION:

Brake shoe will be worn more quickly if the brake lever is always applied lightly during riding.

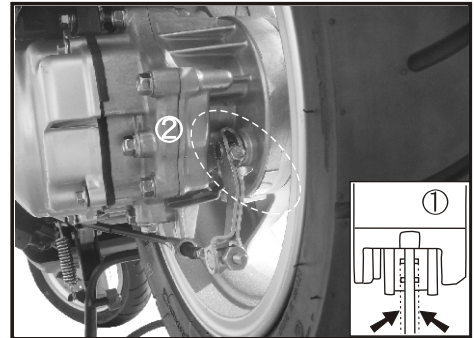

(10) HORN/LIGHTS INSPECTION

Turn the ignition switch to the "ON" position and push the horn button to check if it sounds.

Headlight/Taillight Inspection:

Start the engine and turn on the headlight switch to check if the headlight and taillight are good and check the light shells for dirt and damage.

Stoplight Inspection:

Apply the front and rear brake levers respectively to check if the stoplight is good. And also check the stoplight shell for dirt and damage.

Turn Signal Light Inspection:

Operate the turn signal switch to make sure whether the right/left front and rear turn signal lights can wink and buzz. Also check the light shells for dirt and damage.

- ① Headlight ② Taillight/ Stoplight ③ Turn signal light
④ Horn button

CAUTION:

Replace any dirty or damaged lights with new ones to avoid danger during riding.

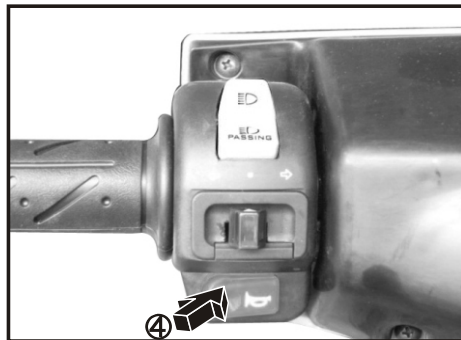
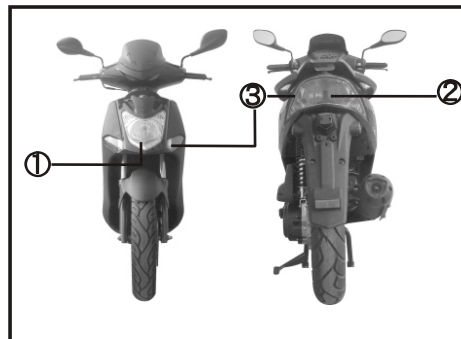

(11) FRONT/REAR SHOCK ABSORBER INSPECTION

Check the condition of the front/rear shock absorbers by pressing down on the handlebar and seat several times.

(12) BRAKE PERFORMANCE INSPECTION

Fully apply the front and rear brake lever pedal and move the motorcycle forward to see if the braking effect is good.

(13) REAR MIRROR ANGLE CHECK

Sit on the motorcycle uprightly and make a viewing test of the rear mirror angle.

(14) LICENSE PLATE CHECK

Check the license plate for dirt and damage, then tighten it.

(15) REFLECTOR CHECK

Check the reflector for dirt and damage.

(16) PREVIOUS ABNORMAL PARTS INSPECTION

Make sure that the previous abnormal parts are repaired.

(17) LUBRICATION POINT CHECK

Visually check if all motorcycle lubrication points are lubricated properly.

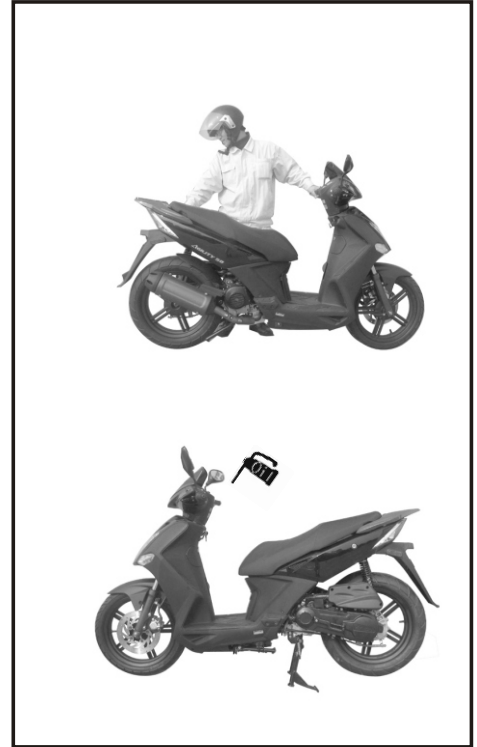

5. ENGINE STARTING METHODS

(1) TURN THE IGNITION SWITCH "ON"

Unlock the steering handlebar.

Turn the ignition switch to the "ON" position.

▲ CAUTION:

Check the gasoline volume and engine oil level before starting the engine.

Be sure to erect the main stand while starting the engine.

Before starting the engine, the side stand shall be kicked up to secure safety.



(2) LOCK THE REAR WHEEL

Apply the rear brake lever to connect the power for starting.

▲ CAUTION:

In order to prevent the motorcycle from rushing out at high speed, make sure to lock the rear wheel.

If free play of the rear brake lever is incorrect, the rear wheel cannot be braked and it will cause danger easily.

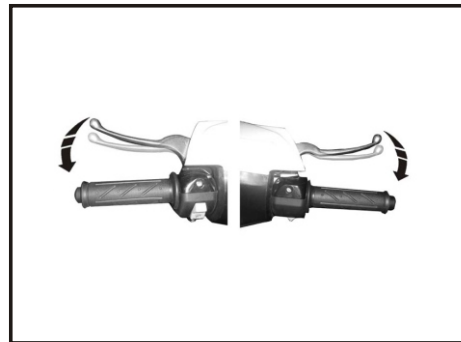

(3) USE THE ELECTRIC STARTER BUTTON

Push the electric starter button without rotating the throttle grip.

If the engine fails to start after the electric starter button is pressed for 3-4 seconds, rotate the throttle grip for 1/8-1/4 turn to facilitate starting.

When the motorcycle is not used for a long time or the fuel tank is empty, if the engine is still hard to start after the fuel tank is refilled with gasoline, push down the choke knob, slightly turn the throttle grip and push the electric starter button for several times to start the engine.

In order to avoid battery overcharge, do not push the starter button more than 5 seconds.

If the engine does not start after the electric starter button is pushed for 5 seconds, wait for more than 5 seconds and then push the button again or start the engine by the kick lever.

CAUTION:

Don't push the electric starter button while the engine is running; otherwise the engine will be damaged.

When starting the engine, the rear brake lever must be applied to connect power and the stoplight will come on when power is connected.

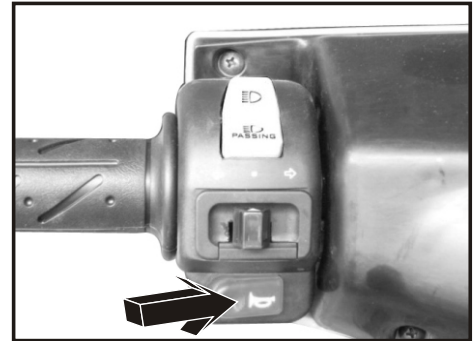

(4) START WITH THE KICK LEVER

1. Place the motorcycle on its main stand on level ground.
2. Depress the kick lever with force.

When the engine is cold and does not start after the kick lever is depressed for 3-4 times, rotate the throttle grip for 1/8-1/4 turn to facilitate starting.

Warm up the engine for a little while (about 2-3 minutes) after cold start.

After the engine is started, do not accelerate suddenly and keep riding at low speed to prolong the engine service life.

▲ CAUTION:

After the engine is started, the kick lever must be returned to its original position.

The exhaust contains poisonous carbon monoxide which is harmful to human body. Never run the engine in a closed area.

Turn off all light switches before starting the motorcycle.

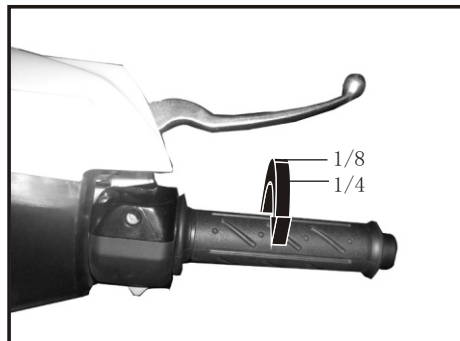

6. NORMAL RIDING METHOD

(1) STARTING THE ENGINE

Start the engine by referring to the starting methods specified in Section 5.

▲ CAUTION:

Keep your finger away from the button immediately after the engine is started to avoid engine damage.

The rear brake pedal should be kept at the braking position before riding.

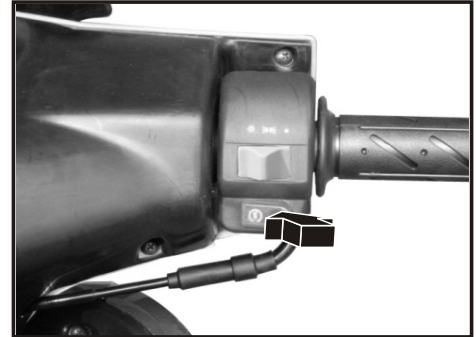

(2) REBOUND THE MAIN STAND

Keep the rear brake pedal at braking position and push the motorcycle forward, then the main stand will rebound automatically.

▲ CAUTION:

After starting the engine and before moving, do not turn the throttle grip to increase the engine rpm.



(3) CORRECT SITTING POSITION

Ride astride on the motorcycle from the left side and sit upright. Touch the ground with left foot to avoid slipping.

▲ CAUTION:

The rider must wear helmet, gloves and goggles.
Do not wear any clothes which will affect riding safety.



(4) ROTATE THE THROTTLE GRIP

Release the rear brake lever and slowly rotate the throttle grip, then the motorcycle will move smoothly.

▲ CAUTION:

After the rear wheel brake lever is released, do not rotate the throttle grip suddenly to prevent the motorcycle from rushing out.

During riding, do not accelerate or decelerate rapidly and suddenly to save fuel and prolong the motorcycle life.

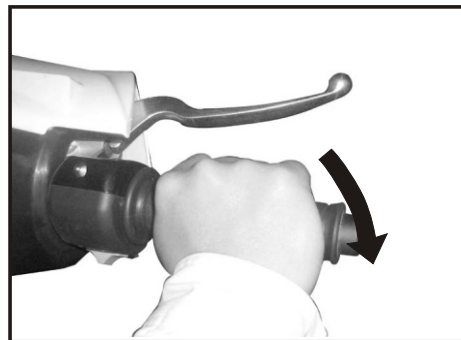

7. PRECAUTIONS FOR RIDING

(1) CORRECT RIDING

Before moving, turn on the turn signal light and make sure whether the rear side is safe.

Do not rush into the car lanes and always keep the motorcycle to the right side to avoid danger.

▲ CAUTION:

Moderate riding will prolong the engine service life. The clutch linings are worn more quickly when often ridden at low speed.

(2) SPEED CONTROL

The speed is controlled by the throttle grip.

① ROTATE The speed will become faster. Don't be hasty to accelerate.

When riding on an ascending road, rotate the throttle grip gradually to increase the horse power.

② RESTORE The speed will become slower. Restore the throttle grip quickly.

▲ CAUTION:

Apply the brake level while restoring the throttle grip. This will shorten the brake time required to slow down.

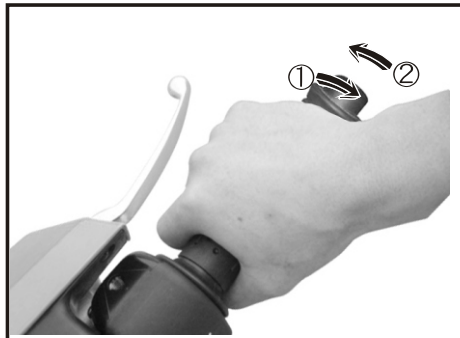
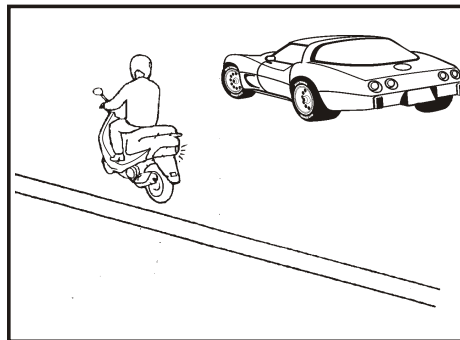

(3) PROPER RIDING WILL PROLONG THE ENGINE LIFE

For a new motorcycle, keep the speed below (50:30km 125: 60km) per hour within the first 1000km of riding.

Avoid sudden acceleration and long-time riding at high speed.

In hot weather, the engine overheats easily at long-time idling. Stop the engine in this case.

▲ CAUTION:

Moderate riding will prolong the engine life.

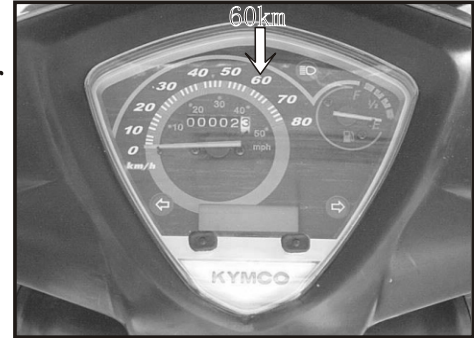

(4) APPLY BOTH FRONT LEVER AND REAR BRAKE LEVER WHEN BRAKING

First restore the throttle grip to the closed position and then pull the brake lever tight.

The best way to brake the motorcycle is to pull the brake lever "slowly" at the beginning, then pull them tight.

▲ CAUTION:

Apply single brake lever will cause the motorcycle to slip. During riding, never brake the motorcycle suddenly. It may cause the motorcycle to slip and could be very dangerous.

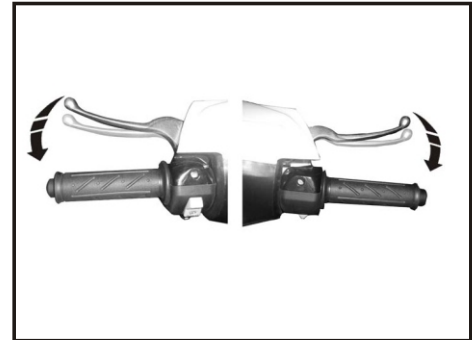

(5) DO NOT MAKE SUDDEN STOP OR SHARP TURN

Sudden stop and sharp turn are the main causes for slipping and could be very dangerous.

In rainy days the road is slippery. Sudden stop will cause the motorcycle to slip. Be careful to avoid danger.



(6) BE MORE CAREFUL WHILE RIDING IN RAINY DAYS

A longer braking distance is required in rainy days than in sunny days. Be sure to slow down and brake the motorcycle slowly as soon as possible.

When riding on a descending road, restore the throttle grip to closed position and slow down by making intermittent braking.

▲ CAUTION:

A longer braking distance is required in rainy days. Be sure to slow down and brake the motorcycle slowly as soon as possible.



8. HOW TO STOP RIDING

(1) WHILE GO NEAR THE PARKING PLACE

Turn on the turn signal light in advance. Watch out vehicles coming behind or aside and stop the motorcycle to the right side slowly.

Restore the throttle grip to closed position and apply the front (brake) level and rear brake pedal as soon as possible.

At this moment, the stoplight will come on to warn the vehicles coming behind.

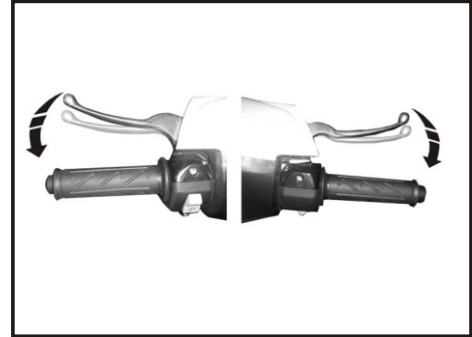

(2) WHILE THE MOTORCYCLE IS COMPLETELY STOPPED

Return the turn signal switch to its original position.

Turn the ignition switch key to the "OFF" position to stop the engine.

▲ CAUTION:

During riding, never operate the ignition switch key.

When the ignition switch key is turned to the "OFF" position, the electric system does not work. Turn off the ignition switch key after the motorcycle is fully stopped.

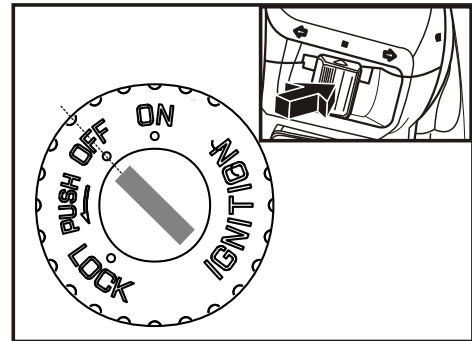

(3) PARKING

Place the motorcycle on its main stand on level ground and do not hinder the traffic.

Stand on the left side and grip the handlebar straight with left hand and the side rod or rear carrier with right hand. Then, step down the main stand evenly with right foot and pull the motorcycle backward by force with right hand.

▲ CAUTION:

The motorcycle may easily fall down if it is parked on an uneven ground.



(4) HANDLEBAR

After parking, be sure to lock the steering handlebar and take out the key to prevent pilferage. (Refer to P5.)

▲ CAUTION:

Don't park your motorcycle at a place to hinder the traffic. Park the motorcycle at a safe place and be sure to take out the key to prevent pilferage.

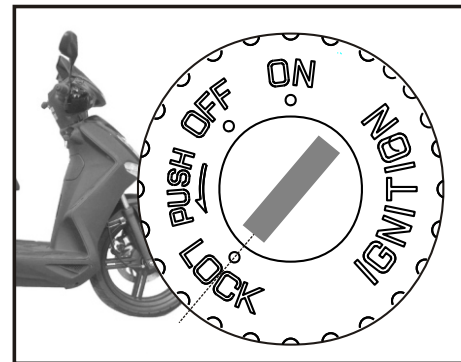

9. EASY MAINTENANCE

(1) AIR CLEANER INSPECTION AND AIR CLEANER CLEANING & REPLACEMENT

Take out the air cleaner and visually check if it is dirty or clogged.

1. Remove the screws attaching the air cleaner cover and remove the air cleaner cover.
2. Remove the air cleaner element.
3. The installation sequence is the reverse of removal.

Replace the air cleaner element at very 2000km.

The air cleaner requires more frequent cleaning or replacing when ridden in unusually dusty areas. When replacing, refer to P40 Periodic Inspection & Maintenance Schedule.

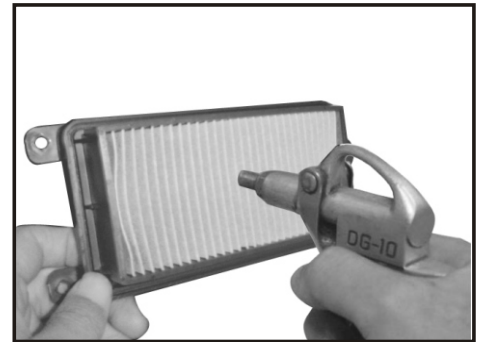
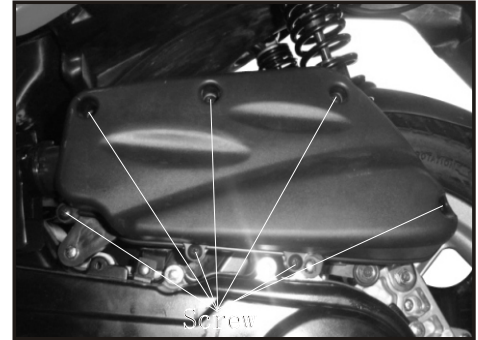

▲ CAUTION:

Never use oil or solvent to wash the wet type paper element.

Be careful not to allow water to enter the air cleaner; otherwise it may result in hard starting.

If the air cleaner is not installed properly, dust may be sucked into the cylinder directly to reduce engine horsepower and affect the service life of engine.

(2) FUEL SYSTEM

Fuel Leakage Inspection

Check the fuel line between the fuel tank and carburetor for fuel leakage.

- ① Fuel tank
- ② Fuel tube connector
- ③ Carburetor

▲ CAUTION:

Check and replace any broken or damaged tube connector to avoid breakdown due to running out of gasoline.



(3) APPEARANCE CLEANING

Often wipe clean the motorcycle appearance to prevent accumulated dust affecting the function of components.

▲ CAUTION:

If a motorcycle is not used for a long time, check the operation of each part and replace lubricants before riding. Ride the motorcycle only after its performance is confirmed.

When waxing the motorcycle, make sure that the ingredients of the wax will not damage the paint of the motorcycle.



(4) BATTERY

This model adopts the battery which needs no refilling of Distilled water.

When cleaning the battery terminals, remove the screws
Attaching the battery cover on the seat and then open the battery cover.

When battery terminals are corroded, take out the battery for cleaning.

After cleaning, apply a thin coat of grease or Vaseline to Battery terminals and then install the battery.

▲ CAUTION:

Never open the closed-type battery electrolyte cap.

If the motorcycle will not be used for a long time, the Battery will discharge electricity by itself. Remove the Battery and put it in a cool place after it is fully charged to Prevent electricity leakage.

If the motorcycle will not be used for a long time, remove the negative (-) terminal.

Do not smoke or allow flames or sparks near the battery
While removing and installing it.

Turn off the ignition switch before removal or installation.
The negative (-) terminal shall be removed first and the Positive (+) terminal shall be installed first.
Tighten the loose terminal nuts securely.

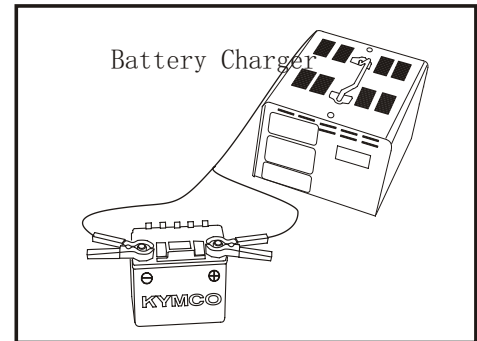

(5) FUSE CHANGE

Turn off the main switch and check if the fuse is burned out.

When the fuse is burned out, replace with a specified fuse. Check for the cause of breakdown before replacing. Ignition switch fuse specification: 7A×2

▲ CAUTION:

Be careful not to excessively expand the fuse clip during removal.

After a new fuse is installed, check the fuse clip for looseness which is the main cause of trouble.

Never use fuse of unspecified capacity, it may cause wire overheating and burning out.

When replacing electric appliances (lights, instruments), be sure to use the recommended genuine parts.

When washing the motorcycle, avoid flushing it.

If the cause can not be found, contact our distributor or service station for inspection

① Fuse Box ② Fuse clip ③ Fuse

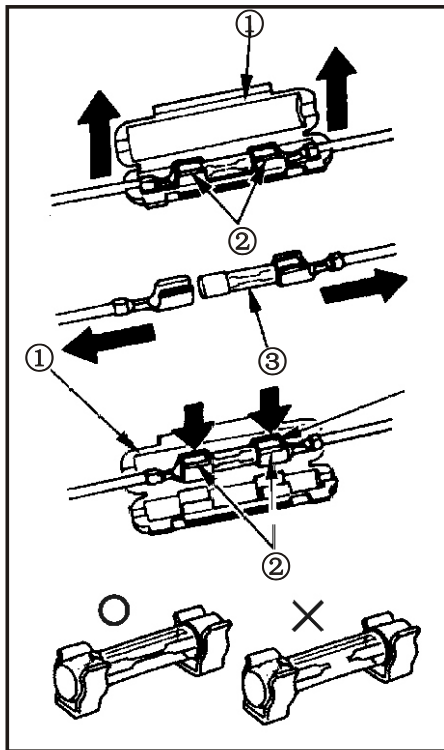

(6) ENGINE OIL CHANGE

1. Place the motorcycle on its main stand on level ground.
2. Remove the oil dipstick.
3. Remove the drain bolt to drain the oil.
4. Refill fresh engine oil for 50:0.8/125:0.9 liter. Firmly tighten the oil dipstick.
5. Warm up the engine and check the oil level again after the engine is stopped for 20-30 seconds.

Specified Oil: SAE 15W-40

API service classification: SG

Capacity/Exchanging Capacity: SUPER8 50:0.8/0.7L
SUPER8 125:0.9/0.8L

CAUTION:

When changing the engine oil, also clean the oil strainer and reinstall it.

Use the specified engine oil.

Change engine oil at first 300km and then change it at every 2000km.

Engine oil will deteriorate easily and require more frequent change if the motorcycle is often ridden in dusty and cold areas or ridden for short distance.

Do not mix engine oil of different classes or viscosities. It may cause damage for engine.

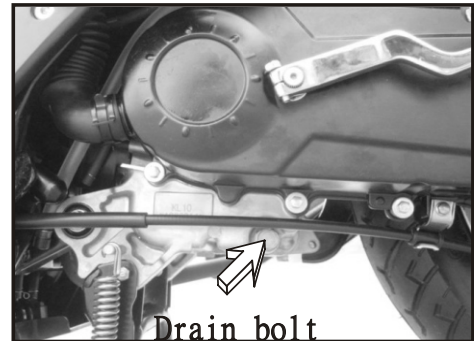

(7) TRANSMISSION GEAR OIL

Check the transmission gear oil tank for leakage.

1. Place the motorcycle on its main stand on level ground.
After the engine stops for 2-3 minutes, remove the gear oil check bolt to check the oil level.
2. If the oil level is lower than the check bolt hole lower edge, add gear oil to the lower edge.
3. After refilling, securely tighten the check bolt.

Recommended Gear Oil: SAE90

Capacity / Exchanging Capacity: 0.2L / 0.18 L

- ① Gear Oil Filler Oil (Check Bolt Hole) ② Drain Bolt
③ Oil Level

CAUTION:

Add gear oil through the oil check bolt hole.
After refilling, use a rag to wipe clean.
Excess or insufficient gear oil will affect the engine performance.
Never use gear oil of different brand or inferior quality which may result in engine breakdown.
Change gear oil at first 300km and then change at every 5000km. Add specified gear oil whenever it is necessary.

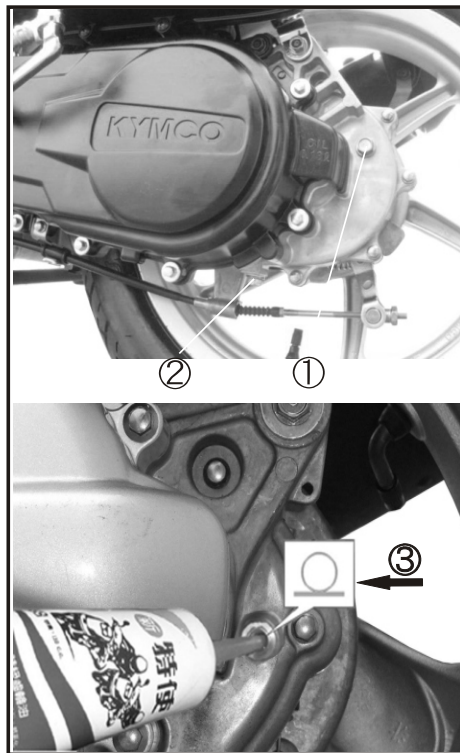

(8) SPARK PLUG INSPECTION

Check the spark plug side electrodes for wear.
Fouling deposits on spark plug electrodes and big gap may result in weak spark.

Spark Plug Removal:

1. Remove the spark plug with a spark plug remover.
2. The installation sequence is the reverse of removal.

Spark Plug Cleaning:

1. It is better to remove spark plug deposits with a spark plug cleaner.
2. If a spark plug cleaner is not available, clean with a wire brush.

The side electrode gap is 0.6-0.7mm.

Specified Spark Plug: NGK CR7HSA

CHAMPION-P-RZ9HC

- ① Decarbonizing ② Cracks, Damage ③ Gap, Wear, Fouling Deposits

▲ CAUTION:

Clean the spark plug at every 2000km and replace it with a new one at every 5000km or when the center electrode is burned out.

First screw in the spark plug with fingers and then tighten with a spark plug wrench.

Use unspecified spark plug may damage the engine.

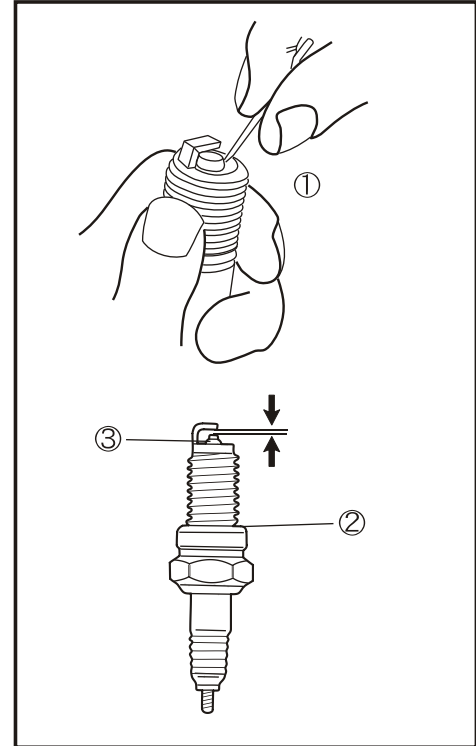

(9) BRAKE FLUID LEVEL INSPECTION /REFILLING

Remove the two screws from the brake fluid tank and take off the cover.

Add recommended brake fluid DOT-4 into the tank until the fluid level reaches the upper limit and then put on the cover and tighten the screws.

Recommended Brake Fluid: DOT-4

▲ CAUTION:

Do not mix brake fluid of different brands. It may cause brake failure and is very dangerous. When refilling brake fluid, use towels to cover and protect the painted and coated surfaces. (Replace at 10000km or every year.)

①Upper Lime ②Lower Lime

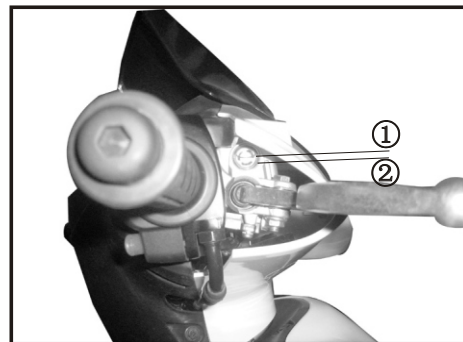

(10) RUBBER COVER INSPECTION FOR WIRE AND CABLE

The cable cores are protected by the rubber cover outside the connector. Check the rubber cover frequently for proper installation.

When washing the motorcycle, do not flush the rubber cover directly or brush it. Use a wet rag to wipe off dirt and dust.

① Rubber Cover

② Check Points

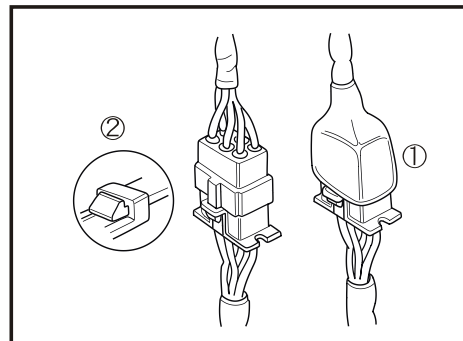

10. IMPORTANT NOTICES

(1) WHEN THE ENGINE FAILS TO START OR STOPS DURING RIDING

Is the gasoline enough?

If the fuel gauge pointer is at the red line, refill #92 or #95 nonleaded gasoline.

Is the way to start the engine correct?

Is there any other faulty parts?



(2) IN CASE OF BREAKDOWN

For any trouble occurred during riding, go to a KYMCO distributor or service station for inspection.

▲ CAUTION:

For the sake of safety and to prevent vehicle damage and save your precious time, the pre-ride inspection is absolutely required. Please read this User's Manual carefully and get into a good habit of inspection before riding.



11. EXHAUST EMISSION CONTROL SYSTEM (FOR EURO 3)

(1) The exhaust emission control system adopted in this model utilizes the reed valve to draw secondary air into the exhaust system for combustion by means of exhaust pulsation in order to minimize the exhaust emission.

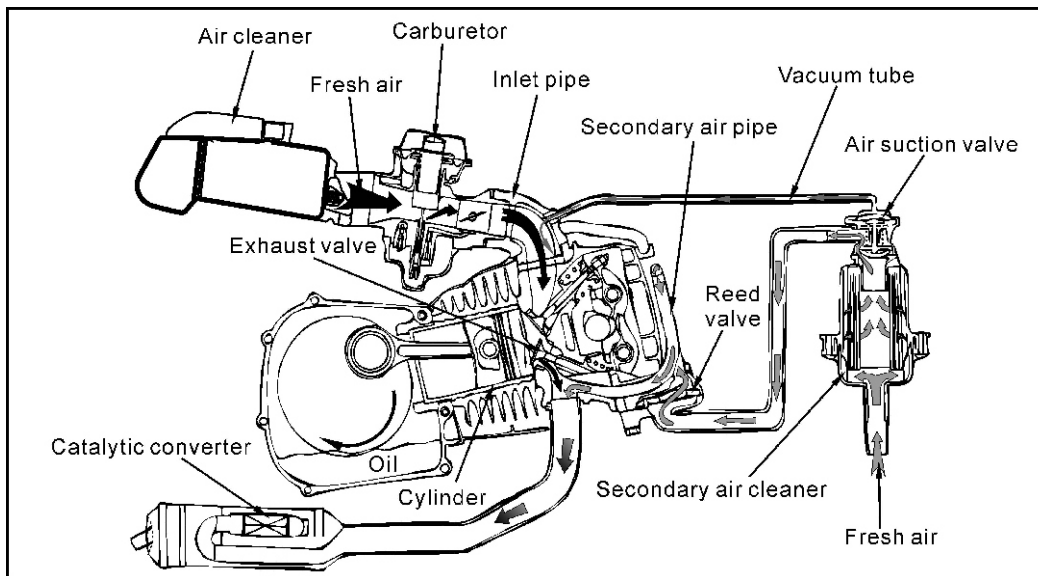

(2). EXHAUST EMISSION CONTROL SYSTEM MAINTENANCE OPERATION METHOD:

1. Refer to page 28 for air cleaner cleaning.
2. Engine Oil In order to have high combustion efficiency and reduce pollutants, make sure to change the engine oil at every 1000Km.
3. Gasoline: In order to prevent combustion efficiency being affected by the ignition system performance, make sure to use 92# or 95# unleaded gasoline. Leaded gasoline is strictly prohibited for use. (Leaded gasoline will cause the failure of catalytic converter due to aging).
4. Emission concentration Test At Idle Speed: Go to a service station with emission analyzer for analyzer for emission concentration test and carburetor adjustment.

WARNING:

The exhaust muffler is very hot. The motorcycle must be parked in a place where Pedestrians and children are unable to touch it.

▲ CAUTION:

1. In order to ensure the proper operation of the exhaust emission control system, be sure to perform the periodic inspection and maintenance.
2. In order to ensure the function of the exhaust emission control system, never modify the motorcycle at will to avoid penalty due to high emission concentration.
3. If any problem is found, go to KYMCO designated service stations for inspection.

12. PERIODIC INSPECTION & MAINTENANCE SCHEDULE

In order to have a safe riding, maintain good performance, prolong the motorcycle service life and reduce pollution, make sure to perform the periodic inspection and maintenance.

I: Inspect and clean, lubricate, refill, repair or replace if necessary.

A: Adjust C: Clean R: Replace T: Tighten

Item	Regular Service Mileage (KM)								Notes
	300	1000	3000	5000	7000	9000	11000	13000	
✓ Engine Oil	R	R	R	R	R	R	R	R	Check the oil level every 1000km
✓ Engine Oil Strainer	C		C		C		C		
Gear Oil	R			R	Replace (R) at every 5000km.				
Cooling Water									
✓ Spark Plug	Clean (C) at every 2000km or replace (R) at every 5000km.								
✓ Valve Clearance	Adjust (A) at every 4000km.								
✓ Carburetor			I		I		I		
Drive Belt									
Drive Chain									
✓ Air Cleaner	Clean (C) at every 1000km or replace (R) at every 2000km.								
✓ Battery Electrolyte	Inspect (I) at every 2000km.								
✓ Fuel Filter Screen	Replace (R) at every 8000km.								
✓ Brake System	I		I		I		I		
✓ Clutch Lever Free Play	A		A		A		A		
✓ Bolts & Nuts	T	Inspect (I) at every 8000km.							
✓ Tire Pressure	I		I		I		I		

The above items are applicable to different models. Perform suitable items for each model. When exceeding the listed mileages, perform maintenance according to the listed intervals. The air cleaner requires more frequent cleaning or replacing when ridden in unusually dusty areas.

13. SPECIFICATIONS

AGILITY CITE 125

Engine Type	OHC Air Cooled 4-Stroke Single Cylinder	Overall Length	2040 mm
Displacement	125 cc	Overall Width	740 mm
Bore x Stroke	52.4×57.8 mm	Overall Height	1240 mm
Compression Ratio	9.3	Dry Weight/Carry heavy	119kg/150kg
Rated Power	7.0/7500 kw/rpm	Wheel Base	1340 mm
Max. Torque	9.5/6500 N.m/rpm	Tire Size	FR:100/80-16 RR:120/80-16
Idle Speed	1700 rpm	Fuel Type	Nonleaded gasoline92#
Transmission Type	Automatic Centrifugal Type	Oil Tank Capacity	0.9 liter
Clutch	Dry Multi-Mass Clutch	Fuel Tank Capacity	6.0 liter
Ignition	C. D. I.	Engine Oil Type	SAE15W40 API: SF
Starting System	Starting Motor and Kick Starte	Battery	12V7AH
Spark Plug	NGK CR7HSA CHAMPION-P-RZ9HC	Fuse	7A/7A
Brake Type	Disk/Drum	Fuel Consumption (L/100km)	< 2L

AGILITY CITE 50

Engine Type	OHC Air Cooled 4-Stroke Single Cylinder	Overall Length	2045 mm
Displacement	50cc	Overall Width	740 mm
Bore x Stroke	39.0×41.4 mm	Overall Height	1240 mm
Compression Ratio	11	Dry Weight/Carry heavy	108kg/150kg
Maximum net power output	2.4/7500 kw/rpm	Wheel Base	1375 mm
Max. Torque	3.5/7000 N.m/rpm	Tire Size	FR:100/80-16 RR:120/80-16
Idle Speed	1900 rpm	Fuel Type	Nonleaded gasoline92#
Transmission Type	Automatic Centrifugal Type	Oil Tank Capacity	0.8 liter
Clutch	Dry Multi-Mass Clutch	Fuel Tank Capacity	6.0 liter
Ignition	C. D. I.	Engine Oil Type	SAE15W40 API: SF
Starting System	Starting Motor and Kick Starte	Battery	12V7AH
Spark Plug	NGK CR7HSA CHAMPION-P-RZ9HC	Fuse	7A/7A
Brake Type	Disk/Drum	Fuel Consumption (L/100km)	< 2L

Free Manuals Download Website

<http://myh66.com>

<http://usermanuals.us>

<http://www.somanuals.com>

<http://www.4manuals.cc>

<http://www.manual-lib.com>

<http://www.404manual.com>

<http://www.luxmanual.com>

<http://aubethermostatmanual.com>

Golf course search by state

<http://golfingnear.com>

Email search by domain

<http://emailbydomain.com>

Auto manuals search

<http://auto.somanuals.com>

TV manuals search

<http://tv.somanuals.com>