

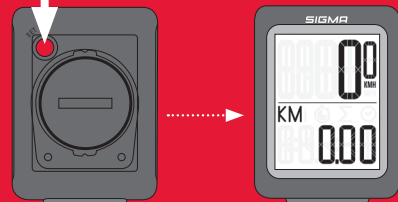

www.sigmasport.com

FIRST START

Press 5 sec.



Battery already installed / Batteriet er installeret på forhånd / Paristo valmiiksi asennettu / Batteri allerede installert / Batteri redan installerat / Источник питания уже установлен / Patarei on juba paigaldatud / Аккумулятор установлено / Bateria jau ievietota / 2 Bateria jau sumontuota

INSTALLATION MOUNT

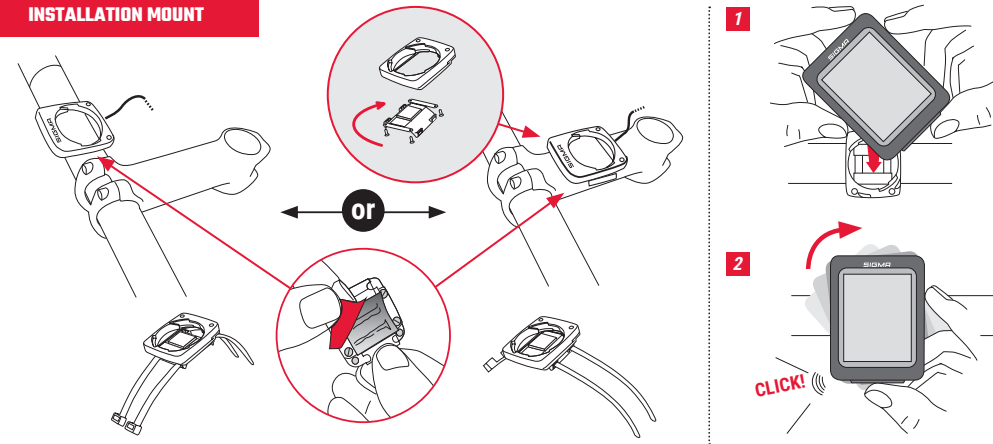

INSTALLATION WIRED SPEED SENSOR

WIRED

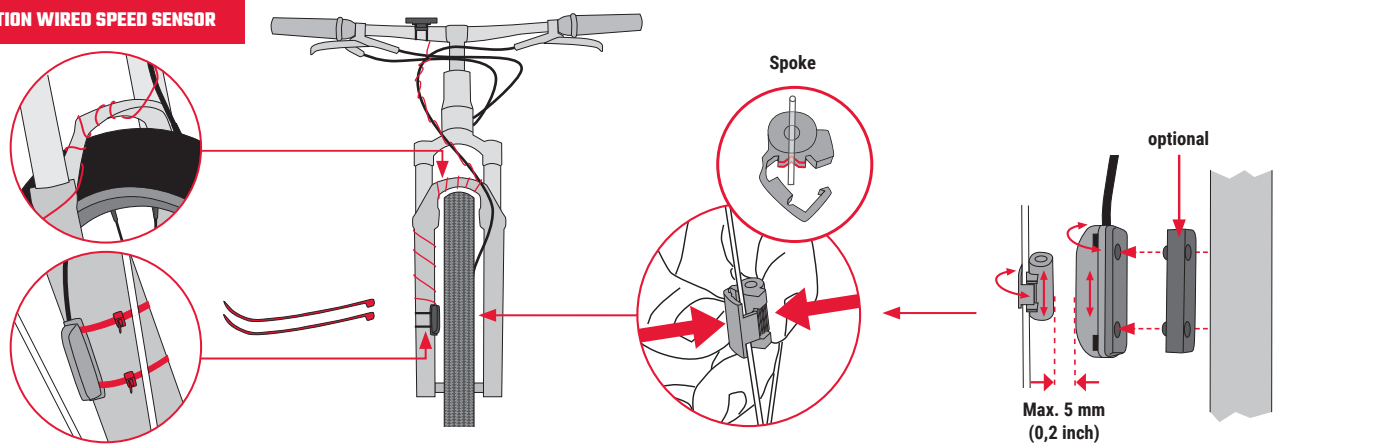

INSTALLATION WIRELESS SPEED TRANSMITTER

Emission frequency: 112 kHz, Max power < 11.37 dBm

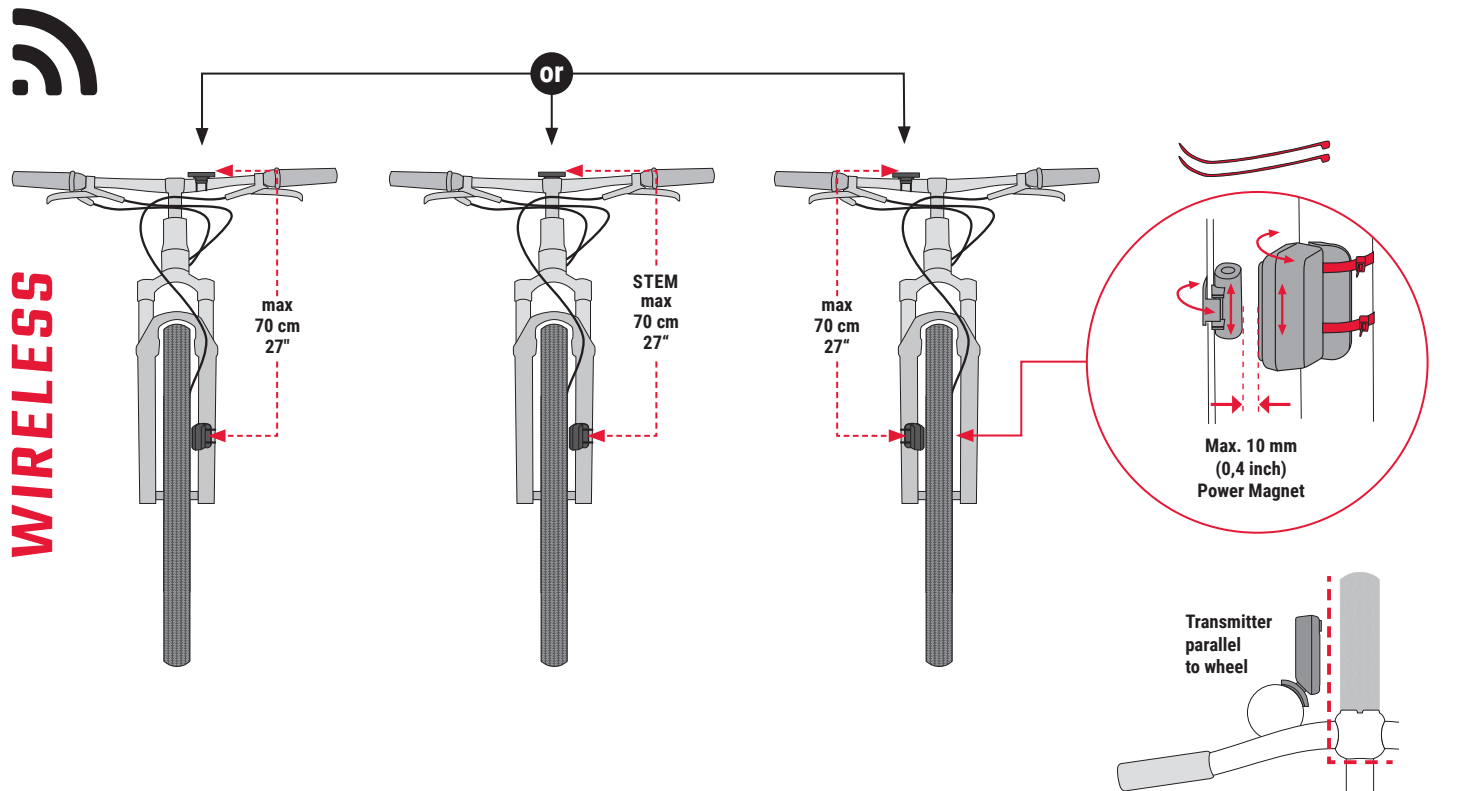

WIRELESS

INSTALLATION

CONTENTS

BC 5.0 wired
1 + 2 + 3

BC 5.0

1 Cable mount
Item no. 00530

2 Magnet
Item no. 00537

3 Cable ties

BC 5.0 wireless
3 + 4 + 5 + 6

BC 5.0 WL

4 Speed transmitter
Item no. 00540

5 Mount
Item no. 00534

6 Power Magnet
Item no. 00538

TECHNICAL DATA

<p>EN Computer WIRED:</p> <ul style="list-style-type: none"> - Battery type: CR 2032, 3V - Battery life: 3 years (When used for 1 hour per day) 	<p>Computer WIRELESS:</p> <ul style="list-style-type: none"> - Battery type: CR 2032, 3V - Battery life: 2 years (When used for 1 hour per day) <p>Transmitter:</p> <ul style="list-style-type: none"> - Battery type: CR 2032, 3V - Battery life: 1.5 years (When used for 1 hour per day)
<p>DK Computer KABLET:</p> <ul style="list-style-type: none"> - Batteritype: CR 2032, 3V - Batterilevetid: 3 år (Ved brug 1 time dagligt) 	<p>Computer TRÅDLØS:</p> <ul style="list-style-type: none"> - Batteritype: CR 2032, 3V - Batterilevetid: 2 år (Ved brug 1 time dagligt) <p>Sender:</p> <ul style="list-style-type: none"> - Batteritype: CR 2032, 3V - Batterilevetid: 1,5 år (Ved brug 1 time dagligt)
<p>FI JOHDOLLINEN tietokone:</p> <ul style="list-style-type: none"> - Pariston tyyppi: CR 2032, 3 V - Pariston kestoikä: 3 vuotta (käytettynä 1 tunti päivässä) 	<p>JOHDOTON tietokone:</p> <ul style="list-style-type: none"> - Pariston tyyppi: CR 2032, 3 V - Pariston kestoikä: 2 vuotta (käytettynä 1 tunti päivässä) <p>Lähetin:</p> <ul style="list-style-type: none"> - Pariston tyyppi: CR 2032, 3 V - Pariston kestoikä: 1,5 vuotta (käytettynä 1 tunti päivässä)
<p>NO Datamaskin KABLET:</p> <ul style="list-style-type: none"> - Batteritype: CR 2032, 3V - Batteriets levetid: 3 år (hvis brukt i 1 time per dag) 	<p>Datamaskin TRÅDLØS:</p> <ul style="list-style-type: none"> - Batteritype: CR 2032, 3V - Batteriets levetid: 2 år (hvis brukt i 1 time per dag) <p>Sender:</p> <ul style="list-style-type: none"> - Batteritype: CR 2032, 3V - Batteriets levetid: 1,5 år (hvis brukt i 1 time per dag)
<p>SE Dator TRÅDBUNDEN:</p> <ul style="list-style-type: none"> - Batterityp: CR 2032, 3V - Batteritid: 3 år (vid användning 1 timme per dag) 	<p>Dator TRÅDLÖS:</p> <ul style="list-style-type: none"> - Batterityp: CR 2032, 3V - Batteritid: 2 år (vid användning 1 timme per dag) <p>Sändare:</p> <ul style="list-style-type: none"> - Batterityp: CR 2032, 3V - Batteritid: 1,5 år (vid användning 1 timme per dag)
<p>RU Компьютер ПОДКЛЮЧЕН:</p> <ul style="list-style-type: none"> - Тип источника питания: CR 2032, 3В - Срок службы элемента питания: 3 года (Если используется в течение 1 часа в день) 	<p>Компьютер БЕСПРОВОДНОЕ СОЕДИНЕНИЕ:</p> <ul style="list-style-type: none"> - Тип источника питания: CR 2032, 3В - Срок службы элемента питания: 2 года (Если используется в течение 1 часа в день) <p>Трансмиттер:</p> <ul style="list-style-type: none"> - Тип элемента питания: CR 2032, 3В - Срок службы элемента питания: 1.5 года (Если используется в течение 1 часа в день)
<p>EE Kompuuter JUHTMEGA:</p> <ul style="list-style-type: none"> - Patarei tüüp: CR 2032, 3 V - Patarei tööiga: 3 aastat (kui kasutatakse 1 tund päevas) 	<p>Kompuuter JUHTMEVABA:</p> <ul style="list-style-type: none"> - Patarei tüüp: CR 2032, 3 V - Patarei tööiga: 2 aastat (kui kasutatakse 1 tund päevas) <p>Saaja:</p> <ul style="list-style-type: none"> - Patarei tüüp: CR 2032, 3 V - Patarei tööiga: 1,5 aastat (kui kasutatakse 1 tund päevas)
<p>LV Dators ar VADA pieslēgumu:</p> <ul style="list-style-type: none"> - Baterijas tips: CR 2032, 3 V - Baterijas kalpošanas laiks: 3 gadi (izmantojot 1 stundu dienā) 	<p>Dators ar BEZVADU pieslēgumu:</p> <ul style="list-style-type: none"> - Baterijas tips: CR 2032, 3 V - Baterijas kalpošanas laiks: 2 gadi (izmantojot 1 stundu dienā) <p>Raidītājs:</p> <ul style="list-style-type: none"> - Baterijas tips: CR 2032, 3V - Baterijas kalpošanas laiks: 1,5 gadi (izmantojot 1 stundu dienā)
<p>LT Kompiuteris LAIDINIS:</p> <ul style="list-style-type: none"> - Baterijos tipas: CR 2032, 3V - Baterijos tarnavimo laikas: 3 metai (naudojant po 1 val. per dieną) 	<p>Kompiuteris BELAIDIS:</p> <ul style="list-style-type: none"> - Baterijos tipas: CR 2032, 3V - Baterijos tarnavimo laikas: 2 metai (naudojant po 1 val. per dieną) <p>Siųstuvas:</p> <ul style="list-style-type: none"> - Baterijos tipas: CR 2032, 3V - Baterijos tarnavimo laikas: 1,5 metų (naudojant po 1 val. per dieną)

EU-DECLARATION OF CONFORMITY

We, SIGMA-ELEKTRO GmbH, Dr.-Julius-Leber-Str. 15, D-67433 Neustadt/Weinstraße declare under our responsibility that the product BC 5.0 WR are compliant with the essential requirements of the EMC Directive 2014/30/EU and the RoHS Directive 2011/65/EU. The declaration of conformity can be found at: ce.sigmasport.com/bc50wr

We, SIGMA-ELEKTRO GmbH, Dr.-Julius-Leber-Str. 15, D-67433 Neustadt/Weinstraße declare under our responsibility that the product BC 5.0 WL and the transmitter ATS2021 are compliant with the essential requirements and other relevant requirements of the RED Directive 2014/53/EU and the RoHS Directive 2011/65/EU. The declaration of conformity can be found at: ce.sigmasport.com/bc50wl

EU-KONFORMITÄTSERKLÄRUNG

Wir, SIGMA-ELEKTRO GmbH, Dr.-Julius-Leber-Str. 15, D-67433 Neustadt/Weinstraße, erklären, dass der Fahrradcomputer BC 5.0 WR bei bestimmungsgemäßer Verwendung den grundlegenden Anforderungen gemäß der EMC Directive 2014/30/EU und der RoHS Directive 2011/65/EU entspricht. Sie finden die Konformitätserklärung unter folgendem Link: ce.sigmasport.com/bc50wr

Wir, SIGMA-ELEKTRO GmbH, Dr. Julius Leber Str. 15, D-67433 Neustadt/Weinstraße erklären, dass der Fahrradcomputer mit Funkübertragung BC 5.0 WL und der Sender ATS2021 bei bestimmungsgemäßer Verwendung den grundlegenden Anforderungen gemäß RED Directive 2014/53/EU und der RoHS Directive 2011/65/EU entsprechen. Sie finden die Konformitätserklärung unter folgendem Link: ce.sigmasport.com/bc50wl

LEGAL STATEMENTS

FEDERAL COMMUNICATION COMMISSION INTERFERENCE STATEMENT

Caution: If any changes or modifications not expressly approved by the party responsible for compliance could void the user's authority to operate the equipment.

This device complies with Part 15 of the FCC Rules. Operation is subject to the following two conditions:
(1) This device may not cause harmful interference, and
(2) This device must accept any interference received, including interference that may cause undesired operation.

The grantee is not responsible for any changes or modifications not expressly approved by the party responsible for compliance. Such modifications could void the user's authority to operate the equipment.

The RF Exposure Compliance distance is 5 millimeters.

NOTE: This equipment has been tested and found to comply with the limits for a Class B digital device, pursuant to part 15 of the FCC Rules. These limits are designed to provide reasonable protection against harmful interference in a residential installation. This equipment generates, uses and can radiate radio frequency energy and, if not installed and used in accordance with the instructions, may cause harmful interference to radio communications. However, there is no guarantee that interference will not occur in a particular installation. If this equipment does cause harmful interference to radio or television reception, which can be determined by turning the equipment off and on, the user is encouraged to try to correct the interference by one or more of the following measures:

- Reorient or relocate the receiving antenna.
- Increase the separation between the equipment and receiver.
- Connect the equipment into an outlet on a circuit different from that to which the receiver is connected.
- Consult the dealer or an experienced radio/TV technician for help.

FCC ID ATS2021: M5LATS2021

INDUSTRY CANADA STATEMENT

This device complies with Innovation, Science and Economic Development Canada licence-exempt RSS standard(s). Operation is subject to the following two conditions:
(1) this device may not cause interference, and
(2) this device must accept any interference, including interference that may cause undesired operation of the device.

CAN ICES-3(B)/NMB-3(B)

Le présent appareil est conforme aux CNR Innovation, Sciences et Développement économique Canada applicables aux appareils radio exempts de licence. L'exploitation est autorisée aux deux conditions suivantes:
(1) il ne doit pas produire de brouillage et
(2) l'utilisateur du dispositif doit être prêt à accepter tout brouillage radioélectrique reçu, même si ce brouillage est susceptible de compromettre le fonctionnement du dispositif.

CAN ICES-3(B)/NMB-3(B)

The device meets the exemption from the routine evaluation limits in section 2.5 of RSS 102 and compliance with RSS-102 RF exposure, users can obtain Canadian information on RF exposure and compliance.

Le dispositif rencontre l'exemption des limites courantes d'évaluation dans la section 2.5 de RSS 102 et la conformité à l'exposition de RSS-102 rf, utilisateurs peut obtenir l'information canadienne sur l'exposition et la conformité de rf.

This transmitter must not be co-located or operating in conjunction with any other antenna or transmitter. This equipment should be installed and operated with a minimum distance of 5 millimeters between the radiator and your body.

Cet émetteur ne doit pas être Co-placé ou ne fonctionnant en même temps qu'aucune autre antenne ou émetteur. Cet équipement devrait être installé et actionné avec une distance minimum de 5 millimètres entre le radiateur et votre corps.

UKCA STATEMENT

Wireless Model

We, SIGMA-ELEKTRO GmbH, declare that the equipment above has been tested in our facility and found compliance with the requirement limits of applicable standards, in accordance with the Radio Equipment Regulations 2017 and the Restriction of the Use of Certain Hazardous Substances in Electrical and Electronic Equipment Regulations 2012. The test record, data evaluation and Equipment Under Test (EUT) configurations represented herein are true and accurate under the standards herein specified.

Wired Model

We, SIGMA-ELEKTRO GmbH, declare that the equipment above has been tested in our facility and found compliance with the requirement limits of applicable standards, in accordance with the Electromagnetic Compatibility Regulations 2016 and the Restriction of the Use of Certain Hazardous Substances in Electrical and Electronic Equipment Regulations 2012. The test record, data evaluation and Equipment Under Test (EUT) configurations represented herein are true and accurate under the standards herein specified.

CE INFORMATION

EN You can find the CE declaration at: ce.sigmasport.com/bc50wr

DK CE erklæringen kan findes på: ce.sigmasport.com/bc50wr

FI Löydät CE-ilmoituksen täältä: ce.sigmasport.com/bc50wr

NO Du kan finne CE-erklæringen på: ce.sigmasport.com/bc50wr

SE Du hittar CE-deklarationen på: ce.sigmasport.com/bc50wr

RU Текст декларации CE см. на сайте: ce.sigmasport.com/bc50wr

EE CE deklaratsiooni leiate aadressil: ce.sigmasport.com/bc50wr

LV Ar CE deklarāciju jūs varat iepazīties šajā adresē: ce.sigmasport.com/bc50wr

LT CE deklaraciją galite rasti adresu: ce.sigmasport.com/bc50wr

FUNCTIONS / SETTINGS

BUTTON OVERVIEW

EN

SET Button: **S**

- Long press >3 sec. = Open/Close Settings
- Short press = SET/OK

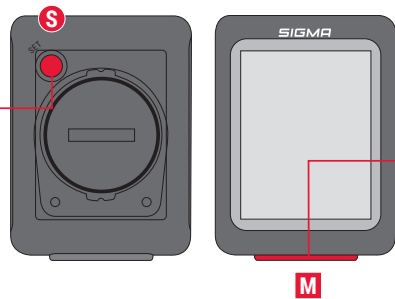

MENU Button: **M**

- Short press = Toggle/Increase value
- Long press >3 sec. = Reset tour data

MENU BASIC BIKE FUNCTIONS

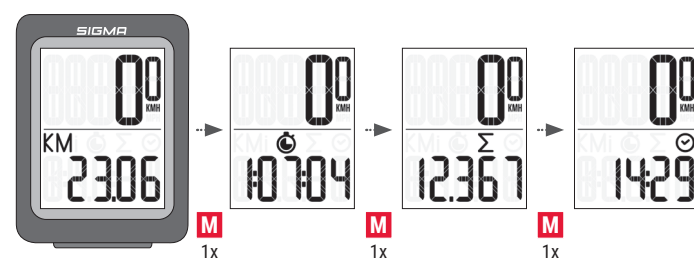

ICON OVERVIEW

- EN KM : trip distance
 ⌚ : trip time
 ∑ : total distance
 ⌚ : clock

- DK KM : aflagt distance
 ⌚ : aflagt tid
 ∑ : total distance
 ⌚ : ur

- FI KM : ajomatka
 ⌚ : ajoaika
 ∑ : kokonaismatka
 ⌚ : kello

- NO KM : turavstand
 ⌚ : turtid
 ∑ : total avstand
 ⌚ : klokke

- SE KM : trippdistans
 ⌚ : tripptid
 ∑ : total distans
 ⌚ : klocka

DK

- S: SET knap:
 • Langt tryk = Åbn/Luk Indstillinger
 • Kort tryk = SET/OK

- M:MENU knap:
 • Kort tryk = Skift/Værdiøgning
 • Langt tryk = Nulstilling af turdata

FI

- S: ASETA-painike:
 • Pitkä painallus = Avaa/sulje asetukset
 • Lyhyt painallus = ASETA/OK

- M:VALIKKO-painike:
 • Lyhyt painallus = Selaa / suurena arvoa
 • Pitkä painallus = Matkatietojen nollaus

NO

- S: SET-knapp:
 • Langt trykk = Åpne/lukk innstillinger
 • Kort trykk: SET/OK

- M:MENU-knappe:
 • Kort trykk = Bytt/verdiøgning
 • Langt trykk = Tilbakestilling av turdata

SE

- S: SET-knapp:
 • Långt tryck = Öppna/Stäng inställningar
 • Kort tryck = STÄLL IN/OK

- M:MENU-knapp:
 • Kort tryck = Bläddra/Öka värde
 • Långt tryck = Nollställ turdata/обнуление

RU

- S: Клавиша SET:
 • Долгое нажатие = Открыть/скрыть настройки
 • Короткое нажатие = SET/OK

- M:Клавиша MENU:
 • Короткое нажатие = Переключение/изменение параметра
 • Долгое нажатие = Сброс данных о поездке

EE

- S: SEADISTAMISE nupp:
 • Pikk vajutus = seadistuste avamine/sulgemine
 • Lühike vajutus = SEADISTA/OK

- M:MENUÜ nupp:
 • Lühike vajutus = lihitamine / väärtuse suurendamine
 • Pikk vajutus = retkeandmete lähtestamine

LV

- S: Poga SET (IESTATĪT):
 • Turēt nospiestu = atver un aizver iestatījumus
 • Nospiešot īslaicīgi = SET/OK (IESTATĪT/KĀRTĪBĀ)

- M:Poga MENU (IZVĒLNE):
 • Nospiešot īslaicīgi = pārslēdz vai palielina vērtību
 • Turēt nospiestu = atiestata maršruta datus

LT

- S: NUSTATYMO mygtukas:
 • Ilgas paspaudimas = Atidaryti/Uždaryti nustatymus
 • Trumpas paspaudimas = NUSTATYTI/OK

- M:MENU mygtukas:
 • Trumpas paspaudimas = Perjungti/Didinti reikšmę
 • Ilgas paspaudimas = Kelionės duomenų anulavimas

SETTINGS MENU

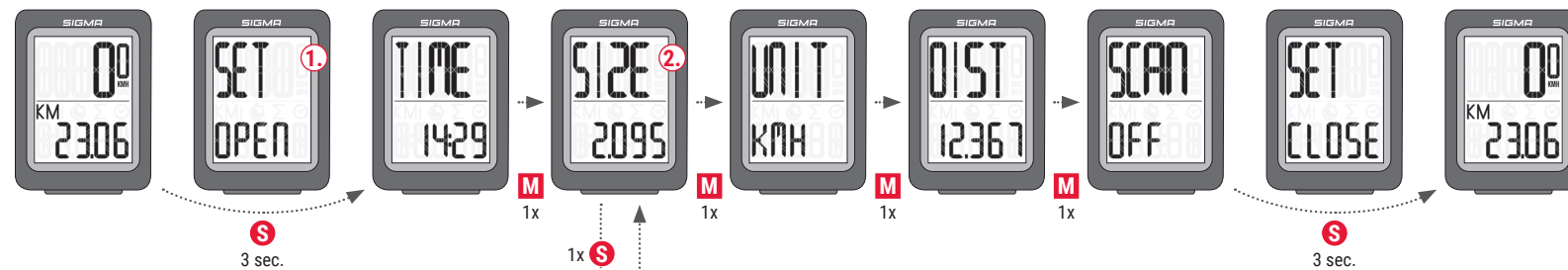

EXAMPLE OF A SETTING

Setting the wheel size:

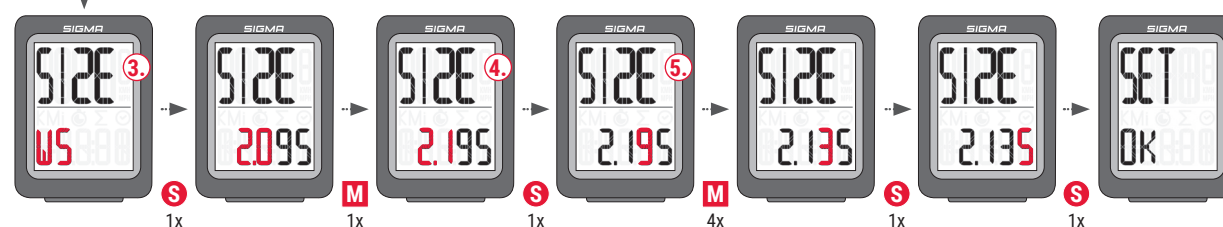

CHOOSE YOUR SPECIFIC WHEEL SIZE

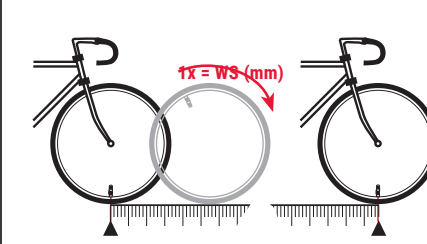

km/h:
 WS = mm
 mph:
 WS = mm
 Note: 1 inch = 25.4 mm

EXAMPLE VALUE: 2135 mm

mm	inch
16"	1253 49,3
18"	1411 55,6
20"	1590 62,6
22"	1770 69,7
24"	1907 75,1
26"	2085 82,1
27"	2195 86,4
27.5"	2180 85,8
28"	2200 86,6
29"	2300 90,5
700C	2095 82,5

EN EXAMPLE OF SETTING PROCEDURE:

1. Open settings: Press and hold **S** button >3 sec. until settings open.
2. Choose the relevant page: Press **M** button until desired value is displayed.
3. Open submenu: Press 1x **S** button.
4. Change value: Press **M** button until desired value is displayed.
5. Confirm chosen value: Press 1x **S** button.
 Note: Do steps No. 4 and No. 5 until the submenu is closed „Set Ok”. You are now back in the Settings Menu.
6. Close settings: Press and hold **S** button >3 sec.

DK EKSEMPEL PÅ INDSTILLINGSPROCEDURE:

1. Åbn Indstillinger: Tryk og hold **S** knappen >3 sek. til Indstillinger åbnes.
2. Vælg den relevante side: Tryk **M** knap til den ønskede værdi vises.
3. Åbn undermenu: Tryk **S** knap 1x
4. Skift værdi: Tryk **M** knap til den ønskede værdi vises.
5. Bekræft den valgte værdi: Tryk **S** knap 1x
 Bemærk: Gentag trin 4 og 5 til undermenuen er lukket „Set Ok”. Du er herefter tilbage i menuen Indstillinger.
6. Luk Indstillinger: Tryk og hold **S** knappen >3 sek.

FI ESIMERKKI ASETUSTOIMENPITEESTÄ:

1. Avaa asetukset: Paina ja pidä **S**-painiketta painettuna >3 s, kunnes asetukset aukeavat.
2. Valitse asiaankuuluva sivu: Paina **M**-painiketta, kunnes haluttu arvo näkyy.
3. Avaa alivalikko: Paina 1x **S**-painiketta.
4. Vaihda arvo: Paina **M**-painiketta, kunnes haluttu arvo näkyy.
5. Vahvista valittu arvo: Paina 1x **S**-painiketta.
 Huomaa: Toista vaiheita nro 4 ja 5, kunnes alivalikko sulkeutuu „Asetus OK”. Olet nyt takaisin asetusvalikossa.
6. Sulje asetukset: Paina ja pidä **S**-painiketta painettuna >3 s.

NO EKSEMPEL PÅ INNSTILLINGSPROSEDYRE:

1. Åpne innstillinger: Trykk og hold **S**-knappen i > 3 sek. inntil Innstillinger åpnes.
2. Velg relevant side: Trykk på **M**-knappen inntil ønsket verdi vises.
3. Åpne undermenyen: Trykk 1x på **S**-knappen.
4. Endre verdi: Trykk **M**-knappen inntil ønsket verdi vises.
5. Bekreft valgt verdi: Trykk 1x **S**-knappen.
 Merk: Gjennomfør trinn 4 og 5 inntil undermenyen er lukket „Set OK”. Du er nå tilbake i innstillingsmenyen.
6. Lukk innstillinger: Trykk og holde knappen **S** i > 3 sek.

SE EXEMPEL PÅ INSTÄLLNINGSFÖRFARANDE:

1. Öppna inställningar: Håll **S**-knappen intryckt > 3 s tills inställningar öppnas.
2. Välj relevant sida: Tryck på **M**-knappen tills önskat värde visas.
3. Öppna undermeny: Tryck en gång på **S**-knappen.
4. Ändra värde: Tryck på **M**-knappen tills önskat värde visas.
5. Bekräfta valt värde: Tryck en gång på **S**-knappen.
 Obs! Utför steg 4 och 5 tills undermenyn är stängd. "Ställ in OK". Nu är du tillbaka i inställningsmenyn.
6. Stäng inställningars: Håll **S**-knappen intryckt > 3 s.

RU ПРИМЕР НАСТРОЙКИ

1. Открыть настройки: нажать и удерживать клавишу **S** >3 с., пока не откроются настройки.
2. Перейти в соответствующий раздел: нажать клавишу **M** до появления требуемого параметра.
3. Открыть подменю: 1 раз нажать клавишу **S**.
4. Изменить параметр: нажать клавишу **M** до появления требуемого параметра.
5. Подтвердить выбранное значение: 1 раз нажать клавишу **S**.
 Примечание: выполните операции 4 и 5 до закрытия подменю „Set Ok”. Теперь вы вернулись обратно в меню настроек.
6. Закрыть настройки: нажать и удерживать клавишу **S** >3 с.

EE SEADISTAMISE PROTSEDUURI NÄIDE:

1. Avage seadistused: vajutage ja hoidke **S** nuppu >3 s kuni seadistused avanevad.
2. Valige asjakohane lehelül: vajutage **M** nuppu kuni kuvatakse soovitud väärtus.
3. Avage alamenuü: vajutage 1x **S** nuppu.
4. Muutke väärtust: vajutage **M** nuppu kuni kuvatakse soovitud väärtus.
5. Kinnitage valitud väärtus: vajutage 1x **S** nuppu.
 Märkus: korrake samme nr 4 ja nr 5 kuni alamenuü sulgemiseni „Set Ok”. olete nüüd tagasi seadistuste menüüs.
6. Sulgege seadistused: vajutage ja hoidke **S** nuppu >3 s.

LV IESTATĪŠANAS PROCEDŪRAS PIEMĒRS:

1. Atveriet iestatījumus: nospiediet un turiet pogu **S** (IESTATĪT) >3 s, līdz atveras iestatījumi.
2. Izvēlieties vajadzīgo lappusi: spiediet pogu **M** (IZVĒLNE), līdz ekrānā redzama vajadzīgā vērtība.
3. Atveriet apakšizvēlni: vienreiz nospiediet pogu **S** (IESTATĪT).
4. Izmainiet vērtību: spiediet pogu **M** (IZVĒLNE), līdz displejā parādās vajadzīgā vērtība.
5. Apstipriniet atlasīto vērtību: vienu reizi nospiediet pogu **S** (IESTATĪT).
 Piezīme: atkārtojiet 4. un 5. soli, līdz aizveras apakšizvēlne „Set Ok” (Iestatījumi saglabāti). Tagad jūs esat atpakaļ iestatījumu izvēlnē.
6. Aizveriet iestatījumus: turiet piespiestu pogu **S** (IESTATĪT) >3 sekundēm.

LT NUSTATYMO PROCEDŪROS PAVYZDYS:

1. Atidarykite nustatymus: Spauskite ir laikykite **S** mygtuką >3 sek., kol atsidarys nustatymai.
2. Pasirinkite atitinkamą puslapį: Spauskite **M** mygtuką, kol bus rodoma norima reikšmė.
3. Atidaryti submeniu: Spausi 1x **S** mygtuką.
4. Keisti reikšmę: Spauskite **M** mygtuką, kol bus rodoma norima reikšmė.
5. Patvirtinti pasirinktą reikšmę: Spausi 1x **S** mygtuką.
 Pastaba: Atlikite žingsnius Nr. 4 ir Nr. 5, kol submeniu užsidarys „Nustatymas Ok”. Dabar esate Nustatymų meniu.
6. Uždaryti nustatymus: Spauskite ir laikykite **S** mygtuką >3 sek.

BATTERY CHANGE

BC 5.0 WR/WL



Battery: CR 2032

SPEED TRANSMITTER (BC 5.0 WL)

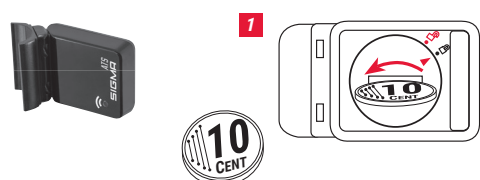

Battery: CR 2032

SIGMA-ELEKTRO GmbH
 Dr. Julius-Leber-Straße 15
 67433 Neustadt/Weinstraße, Germany
 kundenservice@sigmasport.com



Free Manuals Download Website

<http://myh66.com>

<http://usermanuals.us>

<http://www.somanuals.com>

<http://www.4manuals.cc>

<http://www.manual-lib.com>

<http://www.404manual.com>

<http://www.luxmanual.com>

<http://aubethermostatmanual.com>

Golf course search by state

<http://golfingnear.com>

Email search by domain

<http://emailbydomain.com>

Auto manuals search

<http://auto.somanuals.com>

TV manuals search

<http://tv.somanuals.com>