

SUZUKI

Pianos

HP-275e

HP-175e

COMPOSER ENSEMBLE



OWNER'S MANUAL

SUZUKI

WELCOME!

We would like to express our appreciation and congratulate you for purchasing this **Suzuki** composer ensemble piano. This piano has been designed to provide you with years of musical enjoyment. State of the art electronics are combined with an elegant cabinet that will add beauty and sophistication to any home environment. Some of the features your new piano is equipped with include:

- ◆ hammer action piano for an authentic acoustic piano feel
- ◆ 128 true binaural stereo sampled voices for ultra authentic acoustic sound
- ◆ 64 note polyphony
- ◆ a dynamic 8 speaker concert hall sound delivery system with EQ controls
- ◆ LCD display screen for user friendly controls
- ◆ built-in play along songs for your learning and enjoyment
- ◆ easy 5 track recording capabilities
- ◆ karaoke display and floppy disk drive (HP-275e only)
- ◆ complete MIDI controls



You will find many more features and functions listed within this owners manual. In order to fully appreciate all the unique features of this digital piano, please take a few minutes to read the following pages of instruction. We will cover general precautions, assembly, the function of each control button, and warranty information.



Thank you and congratulations again, for choosing this composer ensemble piano from the Suzuki Corporation's piano product line of portable pianos, home digital pianos, home composer ensembles pianos, elegant digital grand ensembles, and the acoustic upright and grand piano models.

SUZUKI

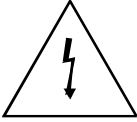
GENERAL PRECAUTIONS

	CAUTION RISK OF ELECTRIC SHOCK DO NOT OPEN	
CAUTION: TO REDUCE THE RISK OF ELECTRIC SHOCK, DO NOT REMOVE COVER OR BACK NO USER-SERVICEABLE PARTS INSIDE REFER SERVICING TO QUALIFIED SERVICE PERSONNEL		

INSTRUCTIONS PERTAINING TO A RISK OF FIRE, ELECTRIC SHOCK OR INJURY:

The lightning flash with arrowhead symbol, within an equilateral triangle, is intended to alert the user to the presence of uninsulated or “dangerous voltage” within the product’s enclosure that may be of sufficient magnitude to constitute a risk of electric shock to persons.

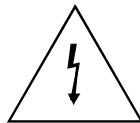

The exclamation point within an equilateral triangle is intended to alert the user to the presence of important operation and maintenance or servicing instructions.



1. **CAUTION:** Any changes or modifications in construction of this device which are not expressly approved by the party responsible for compliance could void the user’s authority to operate the equipment.
2. **NOTE:** This equipment has been tested and found to comply with the limit for a Class A digital device, pursuant to part 15 of the FCC rules. These limits are designed to provide reasonable protection against harmful interference when the equipment is operated in a noncommercial environment. This equipment generates, uses, and can radiate radio frequency energy and if not installed and used in accordance with the instruction manual, may cause harmful interference to radio communications. Operation of this equipment in a residential area is likely to cause harmful interference in which case the user will be required to correct the interference at his own expense.

TAKING CARE OF YOUR DIGITAL PIANO

This Suzuki digital piano will supply you with years of musical enjoyment if you follow the simple rules listed below.

SERVICE AND MODIFICATION

This product should be serviced by qualified service personnel when,

- ♦ the power supply cord or the plug has been damaged,
- ♦ liquid has been spattered into the unit or it has been exposed to rain,
- ♦ the instrument does not appear to operate normally or exhibits a marked change in performance or
- ♦ the instrument has been dropped or the cabinet has been damaged.
- ♦ Do not attempt to open the piano or make any change in the circuits or parts of the unit.

HANDLING AND TRANSPORT

- ♦ Never apply excessive force to the controls, connectors or other parts of the instrument.
- ♦ Always unplug cables by gripping the plug firmly, not by pulling on the cable.
- ♦ Disconnect all cables before moving the instrument.
- ♦ Physical shocks caused by dropping, bumping, or placing heavy objects on the instrument can result in scratches and/or more serious damage.
- ♦ Carefully check the amplifier volume control before starting to play. Excessive volume can cause permanent hearing loss.

CLEANING

- ♦ Clean the cabinet and panel with a soft dry cloth. A wax based polish may be used on the cabinet, although rubbing with a soft cloth will usually suffice. Do not use paint thinner or petrochemical based polishes.
- ♦ To maintain the luster of the keys and buttons wipe with a clean, slightly damp cloth, and then polish with a soft dry cloth.

LOCATION

Do not expose the instrument to the following conditions to avoid deformation,

discoloration, or more serious damage,

- ♦ direct sunlight (near a window),
- ♦ high temperatures (near a heat source, outside, or in a car during the daytime),
- ♦ excessive humidity,
- ♦ excessive dust or
- ♦ strong vibration.
- ♦ Leave enough space around the piano for it to be properly ventilated.
- ♦ This instrument contains digital circuitry and may cause interference if placed too close to radio or television receivers. If interference occurs, move the instrument further away from the affected equipment.
- ♦ Avoid placing vinyl objects on top of the instrument, vinyl can stick to and discolor the surface.

POWER

- ♦ Turn the power switch off when the instrument is not in use.
- ♦ To avoid damage to the instrument and other devices to which it is connected, turn the power switches of all related devices off prior to connection or disconnection of MIDI cables.
- ♦ Turn the power off if the main cable is damaged or the instrument is spattered with liquid.
- ♦ Do not switch the unit on and off in quick succession, this places an undue load on the electronic components.
- ♦ Unplug the AC power cord during an electrical storm.
- ♦ Avoid plugging the AC adaptor into the same AC outlet as appliances with high power consumption, such as electric heaters or ovens.

TABLE OF CONTENTS

EASY SET UP AND QUICK PLAY	7	SETUP continued	
ASSEMBLY	8	Harmony	51
CONNECTOR PANELS	12	Key Mode	
PANEL CONTROLS	13	Manual Bass	52
DISK DRIVE	24	Lower Hold	52
PEDALS	25	Sustain	53
DISPLAY SCREEN	26	Reverb	54
DEMO	27	Chord (Auto Accompaniment Fingering) ...	56
PIANO VOICES	28	Effects	57
Assigning a Mode	28	Pedal Assign	59
Voice Selection	29	Percussion (Drum Kit Assign)	60
Quick Select	31	Metronome	61
RHYTHM SECTION	33	REGISTRATION MEMORY	62
Rhythm Style Select	33	RECORD	63
Quick Select	34	Recording	65
Starting and Stopping the Rhythm Style	36	Playback	66
Fill-In	37	Mark	67
Fill to Variation.....	37	LESSON	68
Fade	37	Song Select	68
Adjusting the Tempo	38	Using the Lesson Feature	69
One Touch	38	DISK (HP-275e Only)	71
AUTO ACCOMP. (AUTO BASE CHORD) ..	39	Load Song	72
One Finger	41	Save Song	73
Fingered	42	Utility	
Piano	43	Format	74
Manual Bass Chord	43	Copy	74
Starting and Stopping the Auto Accomp... ..	44	Delete	75
Fill-In	45	Rename	75
Fill to Variation.....	45	Play Disk	76
Fade	45	MIDI	77
SET UP	46	MIDI IMPLEMENTATION CHART	80
Performance		VOICE LIST	81
Velocity	47	STYLE LIST	82
Split Point	47	DRUM KIT LIST 1	83
Transpose	48	DRUM KIT LIST 2	84
Screen Hold	48	SPECIFICATIONS	85
Tune	49	WARRANTY	86
Fixed Level	49		
Fade Time	50		
Octave Shift	50		

EASY SET UP AND QUICK PLAY

EASY SET UP AND QUICK PLAY IN FOUR SIMPLE STEPS

1

**CHECK THE
PACKAGE
CONTENTS**

2

**ASSEMBLE THE
PIANO STAND**

3

**PLACE THE PIANO
ON THE STAND,
ATTACH THE CABLES
AND PLUG IN**

4





**TURN THE POWER
SWITCH ON,
ADJUST THE
VOLUME AND
BEGIN TO PLAY**

ASSEMBLY

1

CHECK THE PACKAGE CONTENTS

CHECK THE PACKAGE CONTENTS - Please make sure your package contains the following items prior to assembly.

ITEM	QTY
1. PIANO	1
2. PEDAL STAND ASSEMBLY.....	1
3. RIGHT FOOT	1
4. LEFT FOOT	1
5. FOOT BOLTS	4 
6. PLASTIC SCREW COVERS	8 
7. METAL PIANO SUPPORT RODS	4 
8. SUPPORT RODS SCREWS	4 
11. CABLES	2
12. AC POWER CORD	1

2

ASSEMBLE THE PIANO STAND

ASSEMBLE THE PIANO STAND

Please note, do all your final tightening only after the assembly has been completed.

- Align each piano foot to the side of the piano pedal stand assembly by inserting the stub on the foot into the corresponding hole in the piano stand.
- Insert the foot bolts up through the holes in the foot and into the stand, tighten.

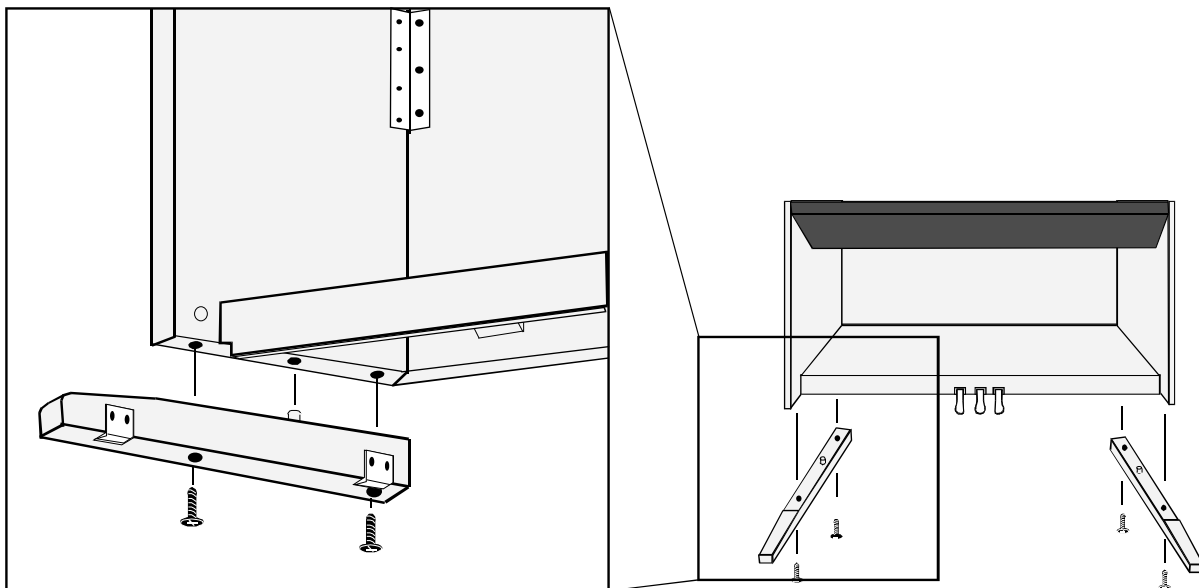

ASSEMBLY

3

**PLACE THE
PIANO
ON THE STAND,**

PLACE THE PIANO ON THE STAND, ATTACH THE CABLES AND PLUG IN

1. Place the four metal piano support rods into the stand. Insert the support rod screws into the stand and tighten securely. Put the plastic screw covers into the holes in the piano stand legs.

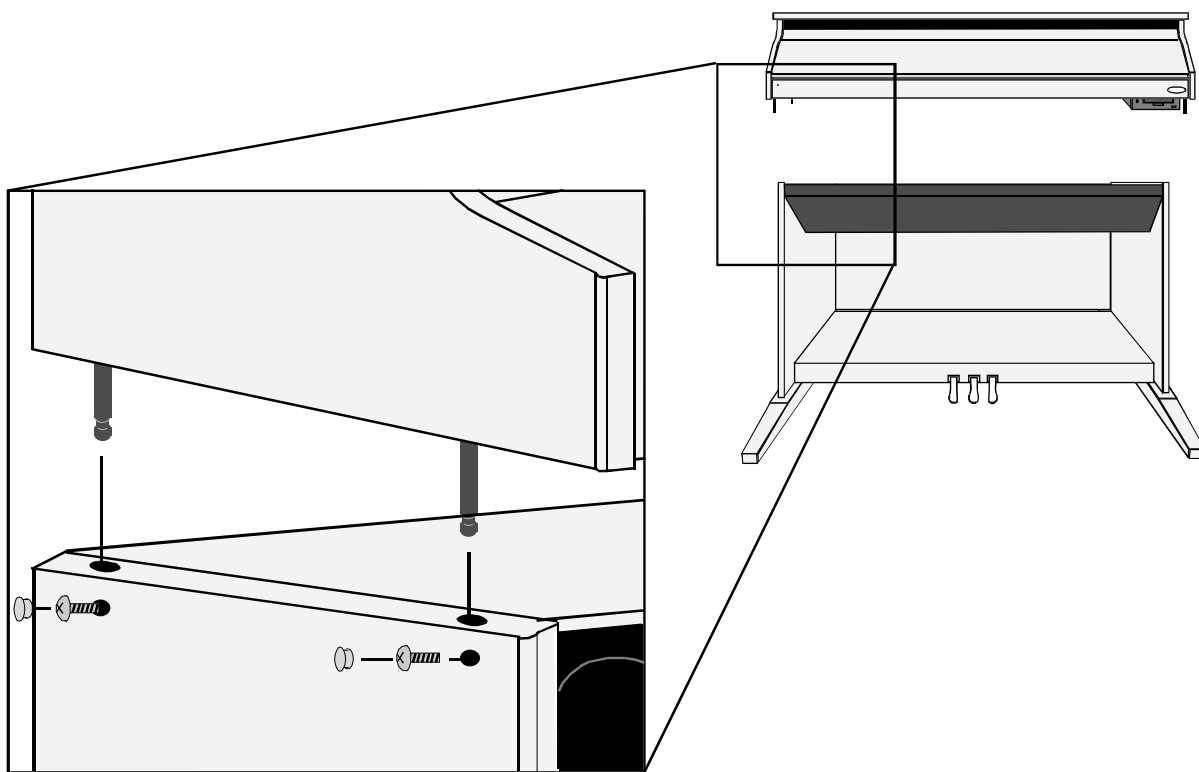

ASSEMBLY

3

ATTACH THE CABLES AND PLUG IN

2. Plug the pedal cable into its receptacle on the back of the piano. Plug the AC power cord into the "AC IN" jack, located on the back of the piano.

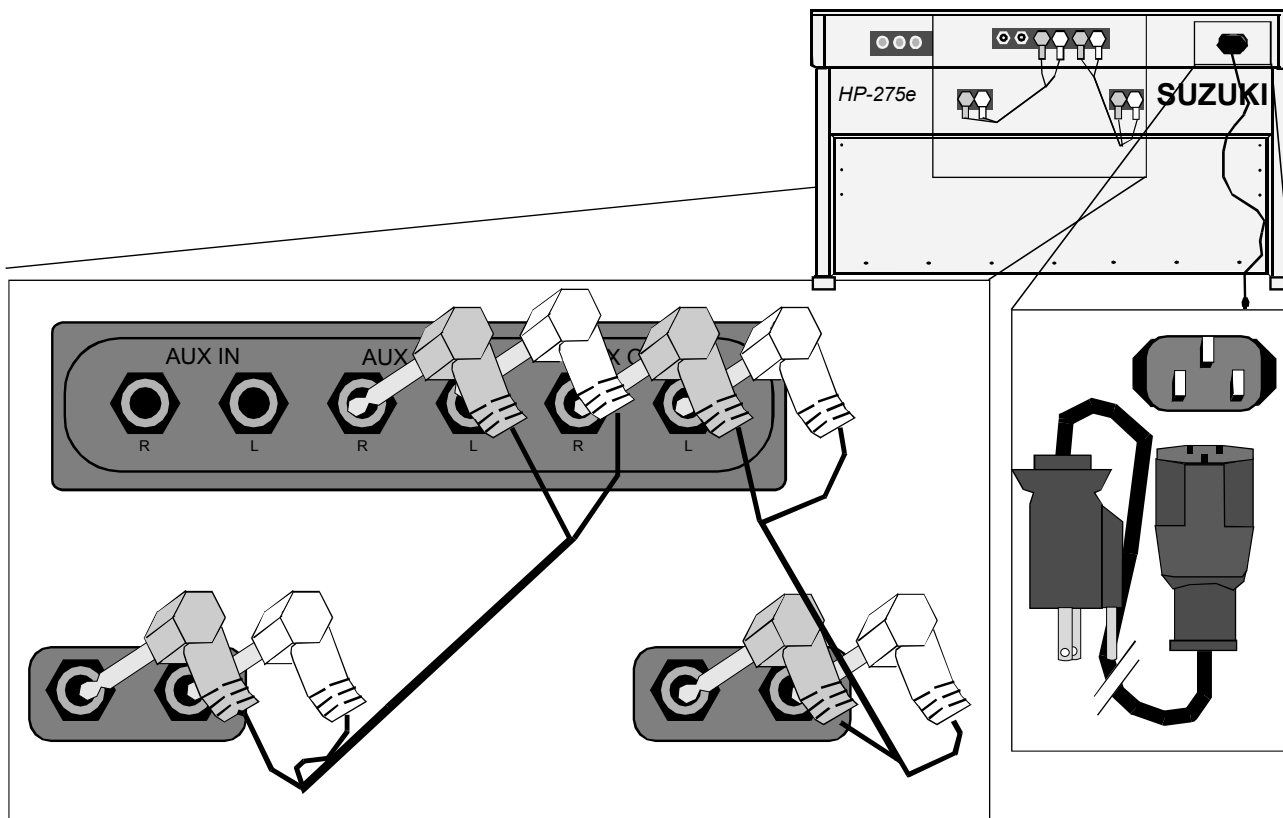

ASSEMBLY

Please note, to open the piano key cover gently lift up and then push inwards.

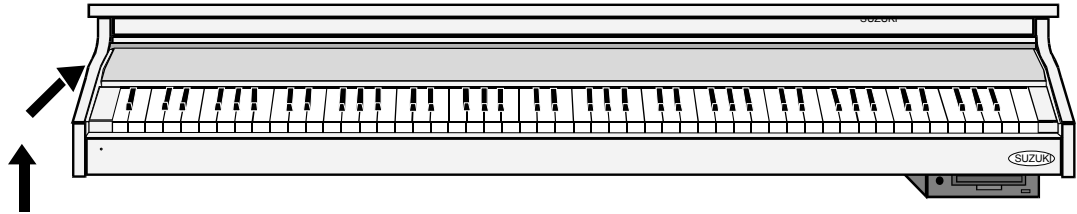

4

**TURN THE POWER SWITCH ON,
ADJUST THE VOLUME AND
BEGIN TO PLAY**

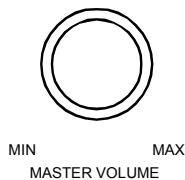
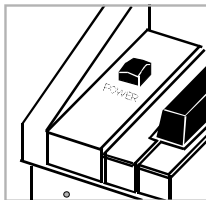

- 1. TURN THE POWER SWITCH ON** - Turn on the power switch located on the left side of the piano. The display will welcome you and set the instrument voice to Grand Piano automatically.
- 2. SET THE VOLUME TO THE DESIRED SETTING** - Adjust the volume control to a comfortable level by turning the Master Volume control left, for softer sound or right, for louder sound.
- 3. *BEGIN TO PLAY!***

CONNECTOR PANELS

These connector jacks are located on the back of the piano.

1. **MIDI OUT / MIDI IN / MIDI THRU** - This piano contains MIDI in, MIDI thru and MIDI output ports. MIDI jacks allow communication with other products equipped with MIDI interfaces. Please see the MIDI section of this manual for further details.

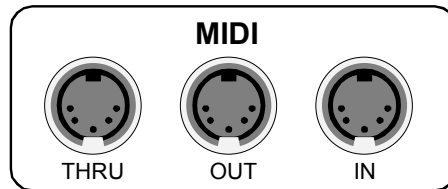

2. **AUX IN** - This stereo audio input jack will amplify the supplied signal through the internal sound delivery system.

AUX OUT - This audio output jack supplies the piano's output signal to external amplification.

3. **AUX OUT 1 / AUX OUT 2** - These jacks are used to connect the pedal stand assembly to the piano. Please see the Assembly section of this manual for more information.

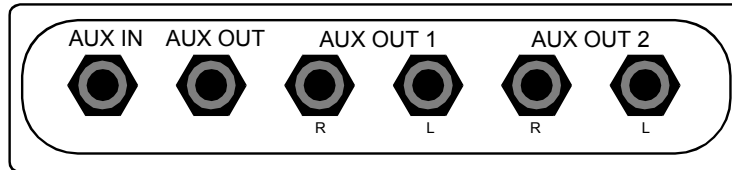

4. **A/C RECEPTACLE JACK** - Plug the supplied A/C cord into this A/C Receptacle Jack



4

These headphone jacks are located directly under the piano on the left side of the piano.

5. **PHONE 1 / PHONE 2** - You can play in total silence, without disturbing others in the room, by plugging a set of headphones into one of the appropriate sockets located on the left side of the piano. When headphones are plugged into either of these jacks the main speaker system is turned off. Two sets of headphones may be used.



5

PANEL CONTROLS

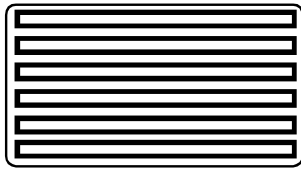

Composer Ensemble
HP-275e

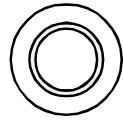

MIN MAX
MASTER VOLUME

1

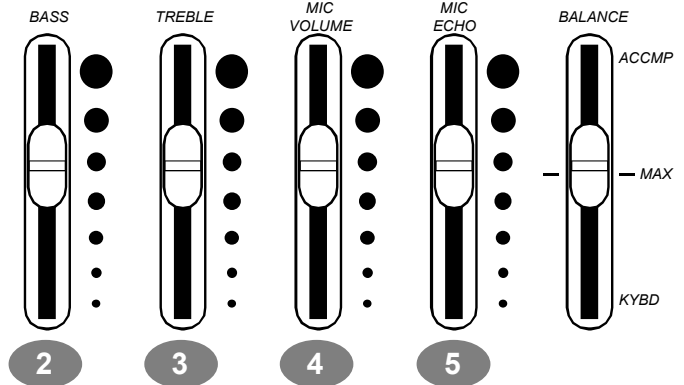

This Suzuki piano's control panel is simple and elegant. The following is a brief description of all the features located on the control panel.

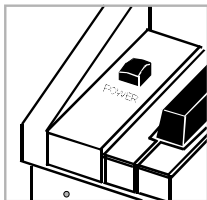

POWER SWITCH - The power switch is located to the left of the keys. Press the button to turn the power on and off. There is an indicator on the left front piano portion of the piano that will light when the power is turned on.

Please note, when you turn the power off, do not turn it back on immediately. Wait at least five seconds to turn the power back on so that the circuit can properly reset.

1. **MASTER VOLUME** - Turn this knob to the right to increase the overall volume of the piano, and to the left to decrease the volume.
2. **BASS** - Slide this controller to adjust the bass level. The mid-point is notched. At this mid-point all EQ controls are "flat."
3. **TREBLE** - Slide this controller to adjust the treble level. The mid-point is notched. At this mid-point all EQ controls are "flat."
4. **MIC (MICROPHONE) VOLUME** - Slide this controller to adjust the volume of the microphone input jack for the optional microphone. Please see the Connector Panels section of this manual for more information.
5. **MIC (MICROPHONE) ECHO** - Slide this controller to adjust the echo or reverb effect on the microphone input jack for the optional microphone.
6. **BALANCE** - This sliding control will adjust the piano volume in

PANEL CONTROLS

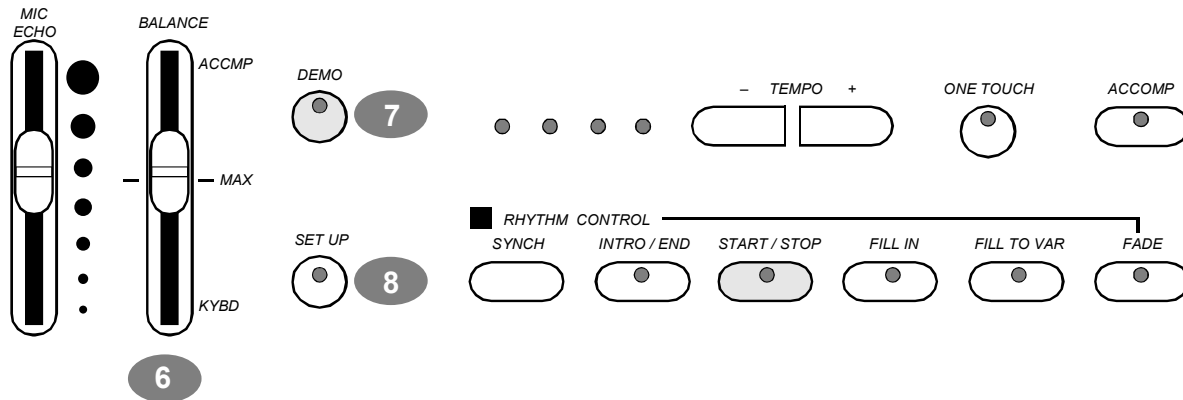

conjunction with the accompaniment volume. Slide the controller up to increase the accompaniment volume and decrease the piano voice, slide the controller down to increase the piano voice and decrease the accompaniment volume.

7. **DEMO (DEMONSTRATION)** - Press the DEMO button. The first demo song will play back instantly. This piano has thirteen different demonstration songs designed to showcase the instrument's capabilities. Please see the Demo section of this manual for more information.
There are also over 50 songs built into this piano to be used as reference for the Lesson exercises that can also be enjoyed. Please see the Lesson section of this manual for more information.
8. **SET UP** - The SET UP button is used to activate the set up menu screen. The majority of this pianos features and functions can be accessed and adjusted from the set up screen menu selections. Please see the Setup section of this manual for more information.
9. **TEMPO** - Press one of the TEMPO buttons, the current tempo

PANEL CONTROLS

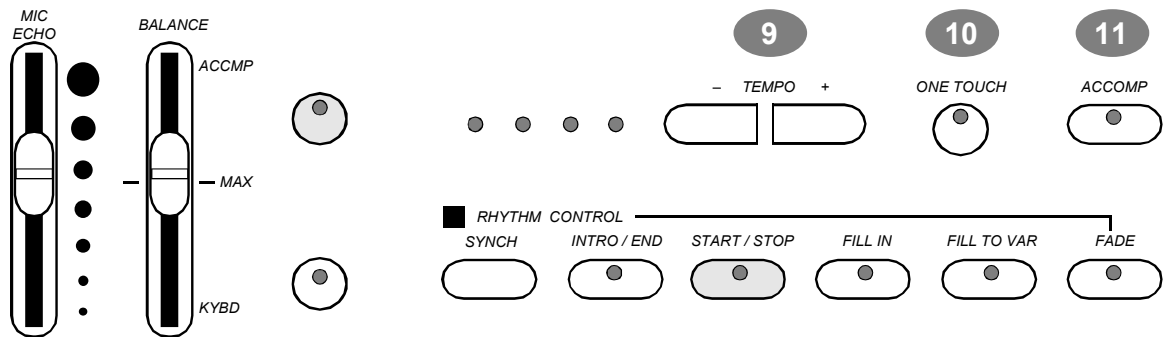

value will appear on the display. You can use the TEMPO +, TEMPO – buttons, or the +/- VALUE buttons to change the tempo value range from 40 to 240 bpm (beats per minute). Press the – TEMPO or + TEMPO buttons or the +/- VALUE buttons simultaneously to recall the default tempo setting for the selected rhythm style.

LED Rhythm light bar display - There is a four-dot beat indicator to the left of the tempo buttons. It indicates the tempo and beat for the accompaniment that is playing. The lights flash simultaneously on the first beat of each measure, then the indicators flash individually in sequence on the remaining beats.

10. **ONE TOUCH** - The ONE TOUCH button will automatically select predetermined optimum piano settings for the selected rhythm style. The voice, voice volume, the fingered accompaniment chord, mode, harmony and effects will automatically be engaged or altered when one touch is selected.
11. **ACCOMP (ACCOMPANIMENT)** - Each of the rhythm styles have an auto accompaniment mode, often called the auto bass chord. These accompaniments are dedicated to the selected rhythm style, and will create fully orchestrated rhythm, bass and chord accompaniments, based on the chord that you play with your left hand. The ACCOMP button activates the chord select screen. With the accompaniment function engaged, the keys to the left side of the split point act as the auto accompaniment piano keys, while the keys to the right are available for normal playing. The auto accompaniment fingering modes are single, fingered and piano. Please see the Auto Accompaniment section of this manual for more information.

12. **SYNC (SYNCHRONIZED START)** - Synchronized Start mode engages the auto accompaniment standby. Press the 15

PANEL CONTROLS

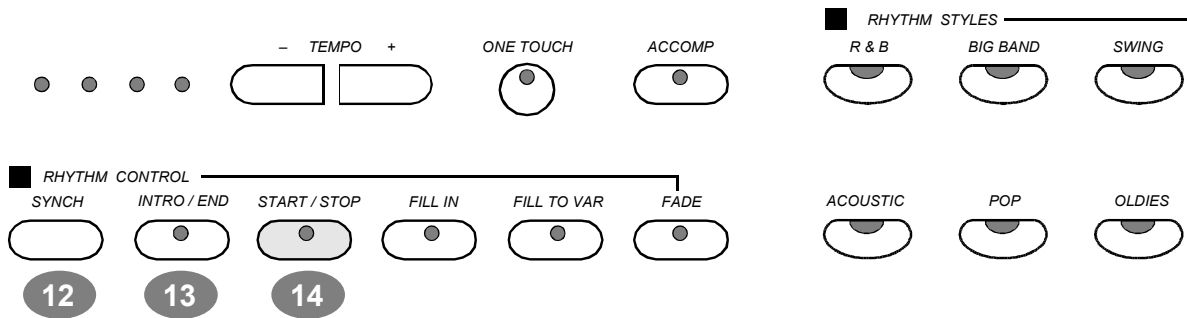

SYNC button and the indicator lights beside the tempo buttons will flash to the beat of the selected rhythm style. The rhythm style will start as soon as you play in the auto accompaniment section of the piano.

The auto accompaniment will start with the first recognized chord played in the auto accompaniment section of the piano, depending on which fingering mode is selected.

13. **INTRO/END (INTRODUCTION/ENDING PATTERN)** - All of the 50 rhythm styles can be started with an appropriate introduction. As soon as you press this button, the rhythm of the introduction will start followed by the main pattern. Each style also has an ending pattern.
The accompaniment can be ended with this pattern from the next measure by pressing the INTRO/ENDING button while the accompaniment is playing.
You can insert a fill-in during the ending to stop the ending and return to the main pattern.
14. **START/STOP** - This button starts and stops the selected rhythm style and/or the engaged auto accompaniment pattern.
This button will also start and stop a variety of features and functions throughout this piano.
15. **FILL IN** - This function provides the accompaniment with a short rhythm pattern of one or two measures for each style.

PANEL CONTROLS

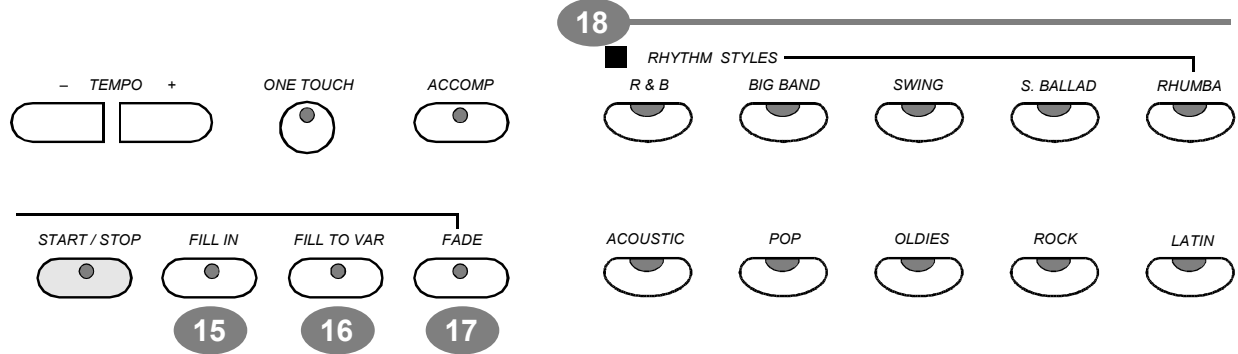

- Press the FILL IN button at any time while the accompaniment is playing.
If you hold down the FILL IN button, the fill-in pattern will repeat until the button is released, then the main pattern will play from the beginning of the next measure.
- 16. FILL TO VAR (VARIATION)** - All of the 50 rhythm styles include a variation of that style that can be played simply by engaging the FILL TO VAR button. If variation is selected the engaged rhythm style will proceed to the variation rhythm pattern.
- 17. FADE** - The FADE button allows the engaged rhythm style to fade in to full volume and fade out to the conclusion. When the fade out has finished the LED will flash while the previously set volume levels are being restored. Pressing the FADE button after it has already been engaged will switch the fade feature off. The fade in and fade out time is assignable in the setup menu screen "performance".
- 18. QUICK SELECT RHYTHM STYLES** - There are ten styles that can be selected quickly by pressing one of the ten quick select RHYTHM STYLE buttons. The style name is printed above the style select button. The style name and its number will be shown on the display. Press the RHYTHM STYLE button again to engage a rhythm select screen. Each button accesses related styles in one or two groups. Please see the Rhythm section of this manual for more information.
- 19. CURSOR** - The CURSOR button group allows you to access and highlight different areas within the display screen, espe-

PANEL CONTROLS

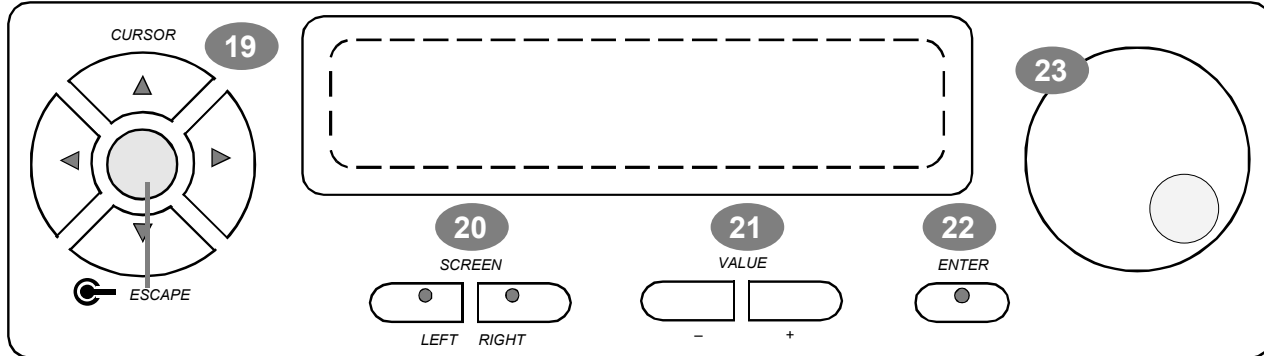

cially while in the Setup mode.

ESCAPE - The ESCAPE button will return the current display screen to the previous screen.

Continue pressing this button to return to the original default performance screen.

- 20. SCREEN LEFT, SCREEN RIGHT** - The SCREEN buttons are used to access different pages within a display screen. If an indicator light is on, there is additional screen information available for the selected function. Use the SCREEN LEFT or SCREEN RIGHT buttons to access the menu page that you want to view.
- 21. VALUE** - Use the VALUE + and - buttons to adjust levels on the currently selected feature. These buttons auto repeat when they are held down.
The default setting of the selected parameter can be recalled by pressing down both the VALUE + and - buttons at the same time.
- 22. ENTER** - Use the enter button to select your highlighted function or feature.
- 23. VALUE WHEEL** - Use the value wheel as an alternative method to change the value of the selected feature. To increase the value turn the wheel clockwise, to decrease the value turn the wheel counterclockwise.
- 24. UPPER** - This button is used to select the voice for the upper

PANEL CONTROLS

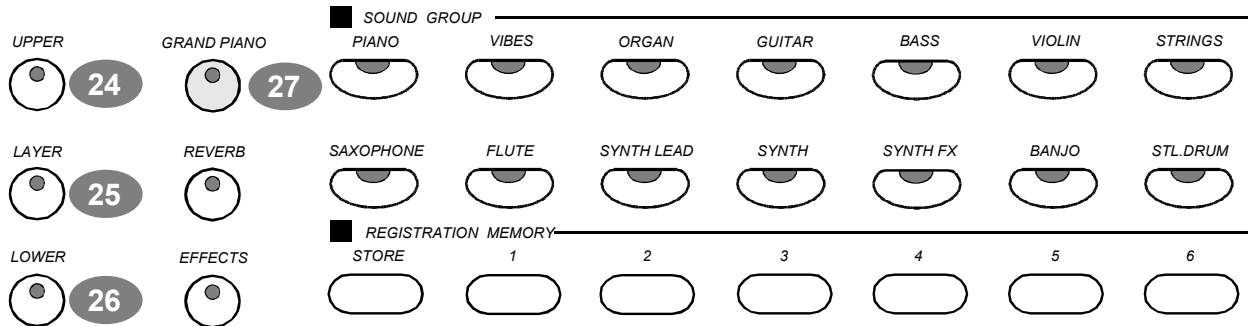

mode and engages the selected voice for all 88 piano keys. Please see the Piano Voices section of this manual for more information.

- 25. **LAYER** - Engaging the LAYER button will put the piano in the layer, or dual mode. Layer refers to an additional voice that is tone mixed with the selected upper voice. Please see the Piano Voices section of this manual for more information.
- 26. **LOWER** - With the LOWER feature engaged the piano operates in the split mode. In the split mode the piano is divided into two sections. In the right hand section the upper or the layered voice will sound, and in the left hand section a different voice can be selected to sound when the keys are played. Please see the Piano Voices section for more information.
- 27. **GRAND PIANO** - This button will reset the piano to its default (power up) settings while engaging the Grand Piano voice for all 88 keys.

- 28. **REVERB** - The reverb effect is engaged automatically when the power is turned on. Reverb simulates the effect of play-

PANEL CONTROLS

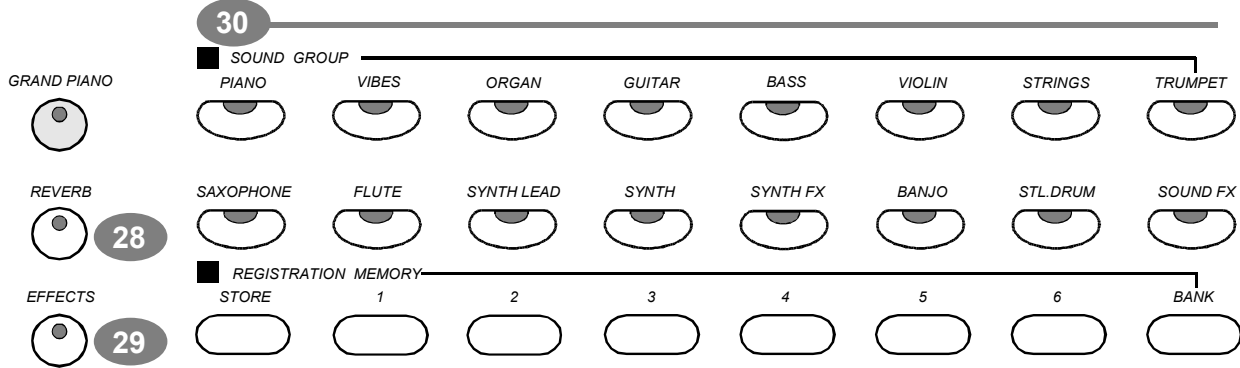

ing in a big room or hall where the sound reverberates off the walls and ceiling. Press the REVERB button to turn off the reverb effect, its indicator LED will turn off.

Reverb depth can be changed in the setup menu “Reverb”. Please see the Setup section for more information.

29. **EFFECTS** - The EFFECTS button will add chorus, flanger or delay effects to the selected instrument voice on the piano. There are eight DSP (Digital Signal Processing) effects available.
Use the setup menu “Effects” selection to change the effect. Please see the Setup section of this manual for more information.
30. **(QUICK SELECT VOICE) SOUND GROUP** - There are sixteen voices that can be selected quickly by pressing one of the voice select buttons. The voice name and its number will be shown on the display. To see a voice menu press the same voice button again. Each button accesses a group of eight related voices in two groups for a total of 128 GM voices. Please see the Piano Voices section of this manual for more information.
31. **STORE** - The STORE button engages the registration memory feature. Registration is used to save piano settings of rhythm, voice, accompaniment, and other features you

PANEL CONTROLS

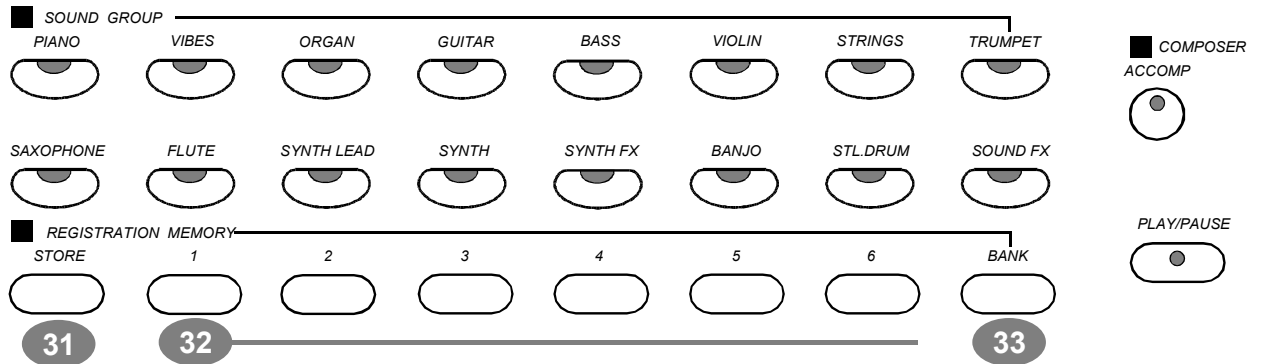

have engaged. The piano has four banks each with six registrations for a total of 24 registration memories. Please see the Registration Memory section of the manual for more information.

- 32. **REGISTRATION NUMBER BUTTONS** - Use the registration number buttons 1-6 to save or recall a setting in the registration memory.
- 33. **BANK** - There are four registration banks, A, B, C and D. Press the BANK button to cycle through these banks. Please see the Registration Memory section of this manual for more information.
- 34. **ACCOMP (ACCOMPANIMENT)** - The ACCOMP button is used to select the auto accompaniment track for recording or playback.

PANEL CONTROLS

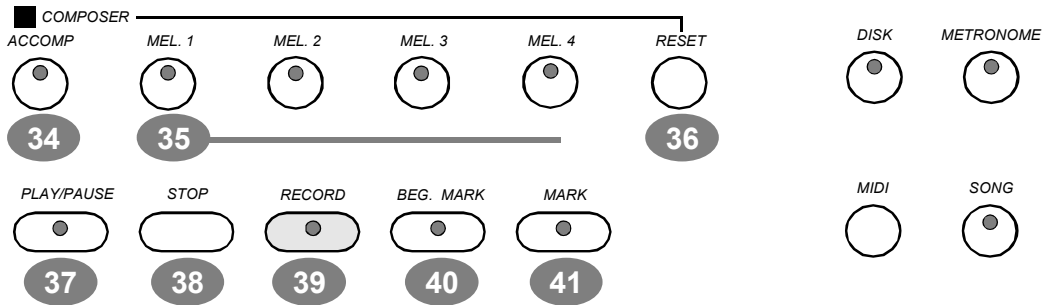

35. **MEL (MELODY) 1-4** - There are four tracks for recording melody, which are assigned by the MELODY 1-4 buttons.
36. **RESET** - The RESET button is used to erase a previously recorded track.
37. **PLAY/PAUSE** - Press the PLAY/PAUSE button to hear previously recorded tracks. Press the PLAY/PAUSE button again to pause the recording or playback.
38. **STOP** - Press the STOP button to stop the recording or playback.
39. **RECORD** - This contains a 5-track sequencer (recorder), that allows the user to record their music performances. It can record all note events exactly as they are performed. When the RECORD button is pressed it puts the selected tracks into the record standby mode. Recording begins as soon as you start to play on any section of the piano. Please see the Record section of the manual for more information.
40. **BEG (BEGIN) MARK** - Use this button to mark the beginning of a recorded passage. You can use this feature to isolate part of a recording for listening or embellishment.
41. **END MARK** - Use this button to mark the end of the recorded section you wish to isolate.
42. **DISK** - The DISK button toggles the disk menu screen on and off. Please see the Disk section of this manual for more information.

PANEL CONTROLS

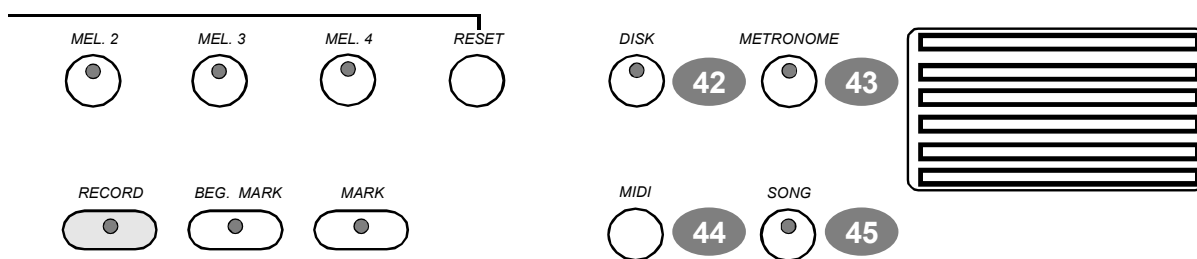

- 43. **METRONOME** - The METRONOME button toggles the metronome feature on and off and accesses the Metronome menu. The tempo can be increased or decreased using the TEMPO + and - buttons. Please see the Setup section of this manual for more information.
- 44. **MIDI** - MIDI is an abbreviation for Musical Instrument Digital Interface. The MIDI features in this piano are capable of communicating with and/or controlling other MIDI devices. Please see the MIDI section of this manual for more information.
- 45. **SONG** - Use the SONG button to access the music Lesson program and the Song Select screen. This “music teacher” feature can be used as an aid to learn the more than 50 songs built into this piano. The SONG button turns the music teacher on and off. Please see the Lesson section of this manual for more information.

DISK DRIVE

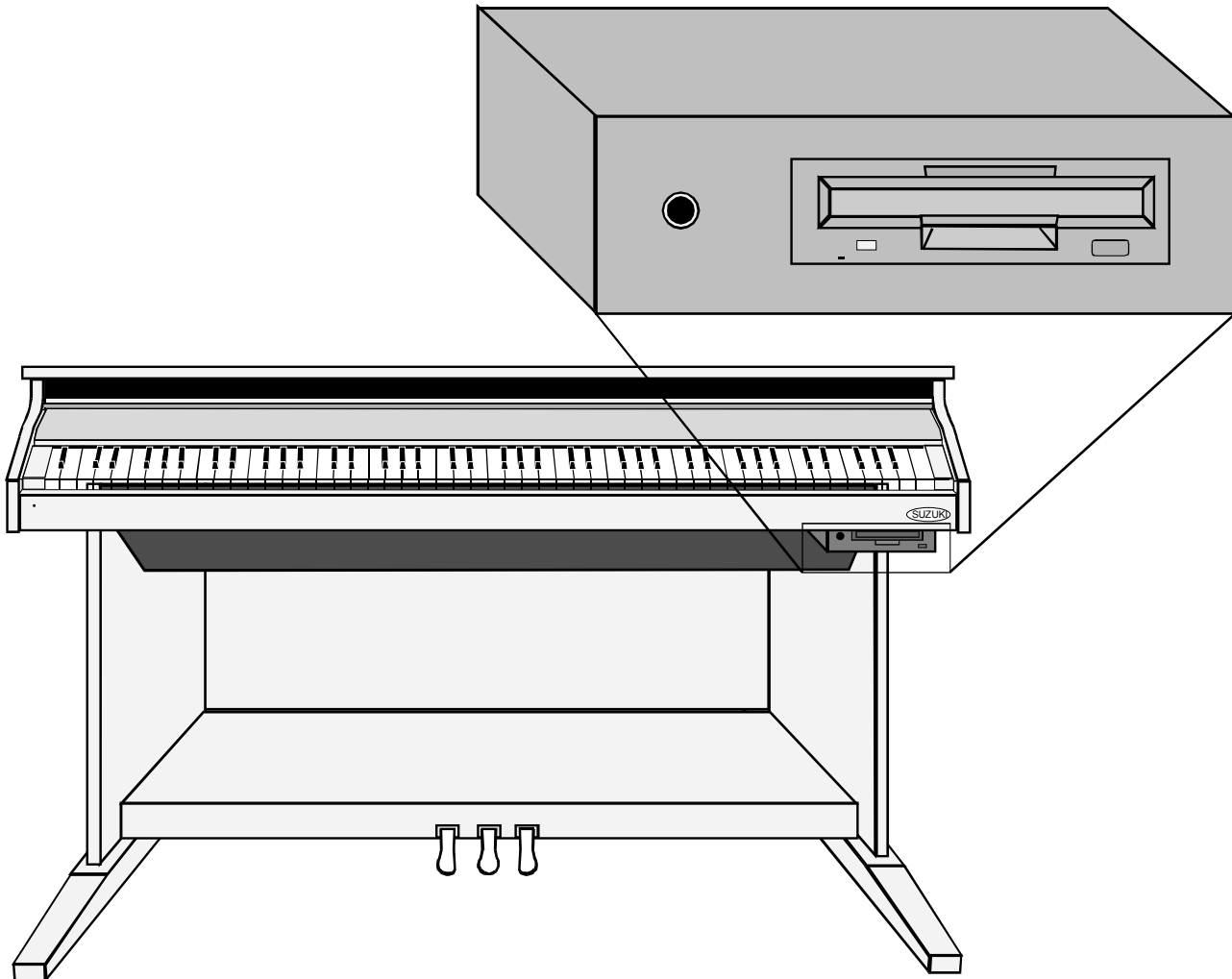

DISK DRIVE - The disk drive is located under the piano keys on the right hand side of the unit. It is used to drive a floppy diskette. Please see the Disk section of this manual for more information.

PEDALS

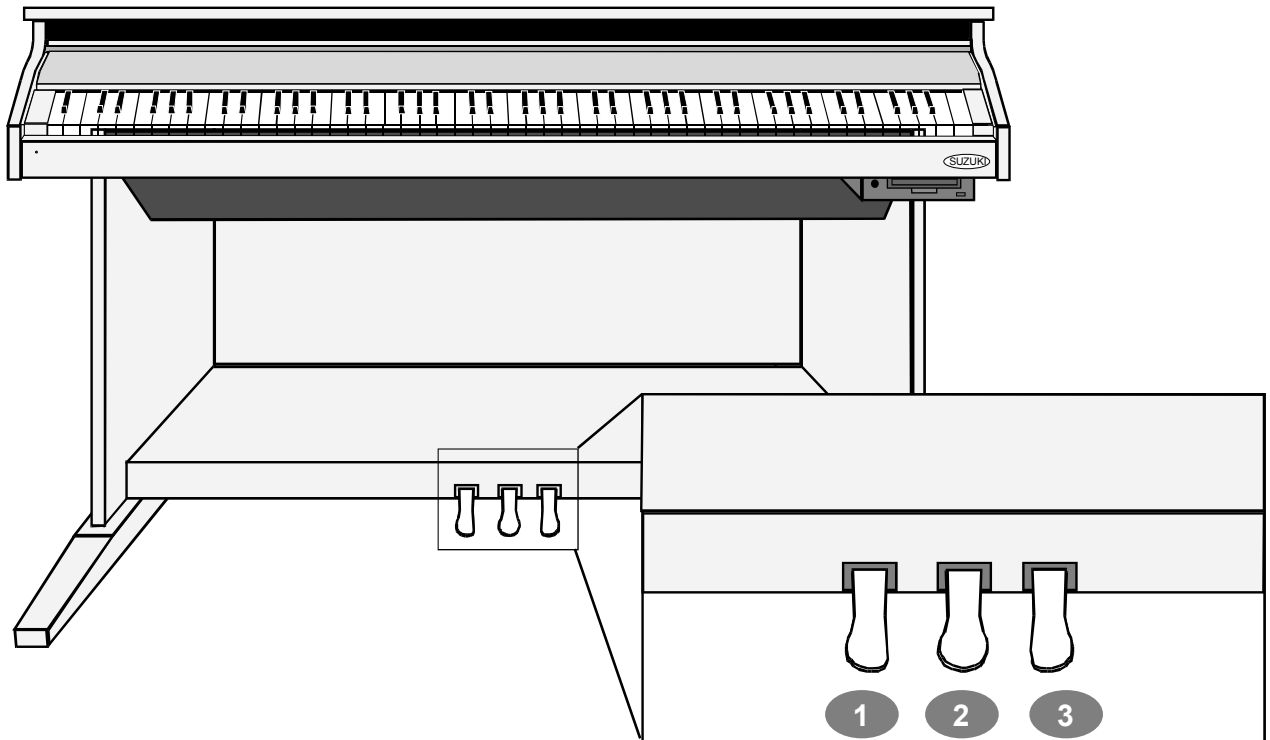

PEDALS

- 1. SOFT PEDAL** - When the left pedal is engaged the piano volume is reduced and the timbre slightly altered on the notes that are played.
- 2. FUNCTION PEDAL** - This center pedal can be used to trigger various events, such as start/stop. Pedal function is assigned in the setup menu, "Pedal Assign". Please see the Setup section of this manual for more information.
- 3. SUSTAIN PEDAL** - When the right pedal is engaged all volumes of the keys as they are played will decay gradually as if you were continuing to hold down the piano keys.

DISPLAY SCREEN

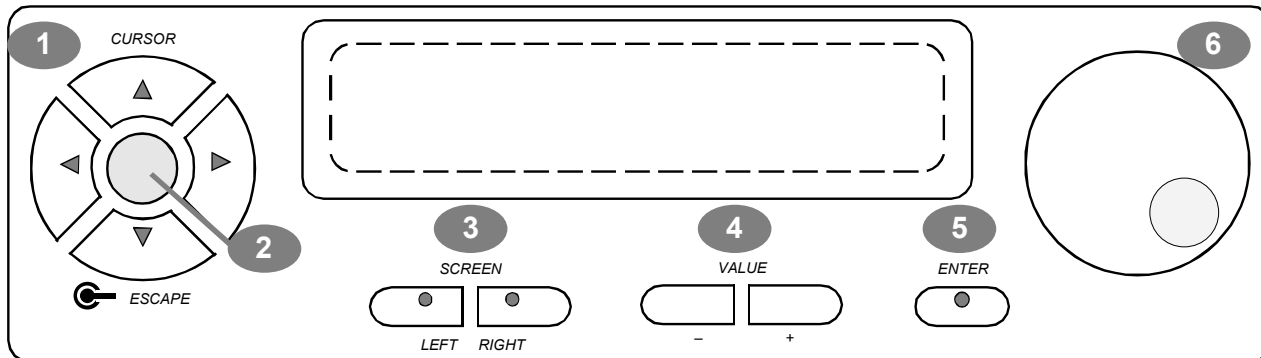

This screen displays the various Setup menus and performance screens.

1. Use the CURSOR keys to select the portion of the screen that you wish to manipulate. The portion of the screen that is selected will be highlighted.
2. The ESCAPE button in the middle of the cursor controls will return the current display screen to the previous screen. Continue pressing this button to return to the initial performance screen.
3. The Left and Right SCREEN buttons will move the display to additional pages within the selected menu. The indicator will be lit if there is additional screen information available.
4. Use the VALUE buttons to adjust the value on the selected menu item.
5. Use the ENTER button to engage a highlighted selection.
6. The VALUE wheel can be used as an alternative to the VALUE buttons.

The default performance screen shows:

UPPER	1 : Grand Piano		
STYLE	1 : R & B		
NC	A1	♪ = 100	

The instrument voice mode.

The currently selected voice number and name. Since this area is highlighted it is selected and available for changes.

The currently selected style number and name.

Auto Accompaniment: When auto accompaniment is engaged, this area shows the chord that is playing. (NC = no chord)

Registration: The current bank (A) and registration number (1).

The current tempo.

DEMO

PLAYING THE DEMO SONGS - This piano has thirteen different demonstration songs that are designed to showcase the different sampled voices that are available. The display will show the song name. All the songs will play back repeatedly until the demonstration is stopped. There are over 50 songs in the musical Lesson course that can also be played back as a demonstration. Please see the Lesson section of this manual for more information.

SELECT AND PLAY A DEMO SONG -

1. Press the DEMO button, the indicator will go on. The first demo song will playback instantly. This unit has thirteen demonstration songs.

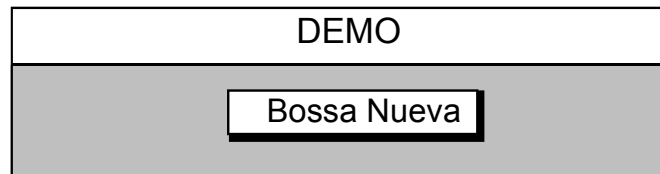

2. Press the DEMO button again to access the Demo Song Select menu.

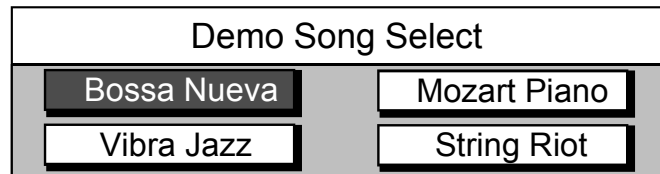

3. Use the SCREEN RIGHT or SCREEN LEFT buttons to access different pages within the Demo Song Select menu.

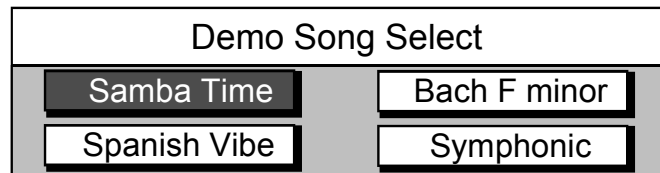
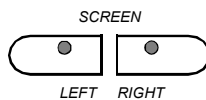

4. Use the CURSOR buttons to move the highlighted area to the song you wish to hear.

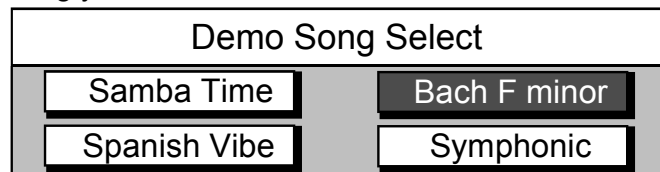
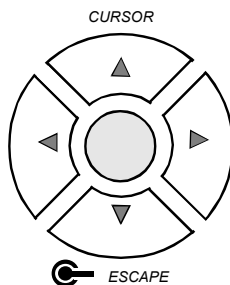

5. Press the ENTER button to confirm your selection. Your selected song will playback instantly. The song will play repeatedly until you press the START/STOP button to stop the song.

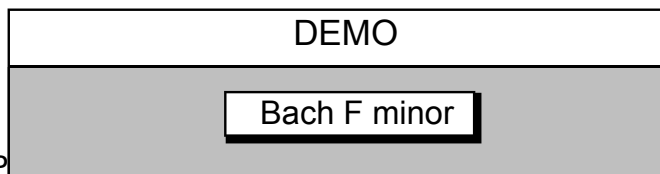

6. Press the DEMO button to return to the Demo mode, the indicator will turn off.



PIANO VOICES

ASSIGNING A MODE - This piano has four different piano modes or playing channels.

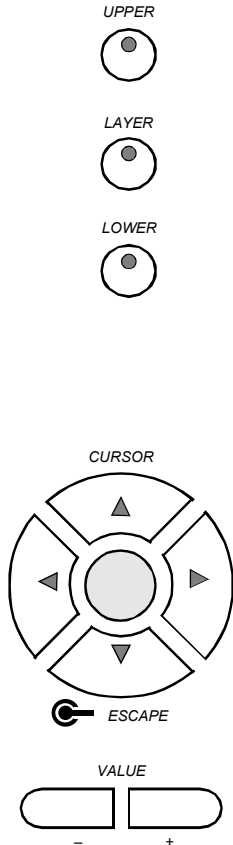

UPPER VOICE - Upper is used to select the upper or main voice of the piano. The upper mode engages the selected piano voice for all of the piano keys.

LAYER (DUAL) VOICE - Layer, or dual, refers to an additional voice that is tone mixed with the selected piano voice. The selected layer voice will be heard with the Upper voice when the layer feature is engaged.

LOWER VOICE - In the lower, or split, mode the piano is divided into two sections. In the right hand section the selected main voice, or the layer voice will sound. In the left hand section a different voice can be selected to sound when the keys are played.

You can change the voice selection for each mode only when it is highlighted on the display screen. To highlight one of the piano modes press the respective control panel button or use the CURSOR buttons in conjunction with the VALUE + and - buttons or the VALUE wheel.

UPPER	1 : Grand Piano	
STYLE	1 : R & B	
NC	A1	♪ = 100



PIANO PERCUSSION (DRUM) - The piano percussion mode refers to the percussion voices that can be played from eight different drum kits, there is also a sound effects kit that can be played while the piano is in this mode. When the percussion mode is engaged, the piano keys will only play percussive voices and not be available for normal play. The percussion mode and drum kits are selected in the setup menu "Percussion". Please see the Setup section of this manual for more information.



ASSIGNING THE SPLIT POINT FOR VOICE - The piano is split into two sections at the split point. The default split point is the G2 key for voice. A different voice split point can be assigned in the setup menu "Performance". Please see the Setup section of this manual for more information.

PIANO VOICES

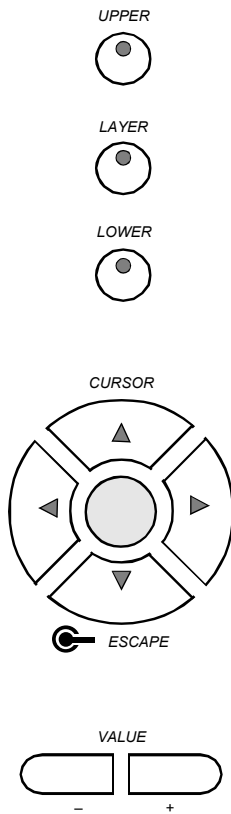

VOICE SELECTION - There are 128 GM (General MIDI) voices in 16 groups available on this piano. There is a complete list of all 128 voices in the back of the manual.

1. Select a mode, UPPER, LAYER or LOWER, by pressing their control panel buttons, or by highlighting the mode area using the CURSOR buttons and pressing the value buttons until the mode you want has been selected.

UPPER	1 : Grand Piano	
STYLE	1 : R & B	
NC	A1	♪ = 100

2. Use the CURSOR buttons to highlight the voice area.

UPPER	1 : Grand Piano	
STYLE	1 : R & B	
NC	A1	♪ = 100

3. Use the VALUE + and - buttons or the VALUE wheel to cycle through the piano voice numbers and names until you reach the voice that you would like to select. After pressing the enter button highlighted selection will be engaged.

UPPER	28 : Clean Guitar	
STYLE	1 : R & B	
NC	A1	♪ = 100

PIANO VOICES

GRAND PIANO



GRAND PIANO - This button will reset the piano to its default (power up) settings. The Grand Piano voice will be engaged for all 88 keys.

No matter what control, functions, features or modes that the piano is in, it will be “reset” to strictly the basic operating system of upper piano voice for all 88 piano keys.

REVERB



REVERB - The reverb effect is engaged automatically when the power is turned on. Reverb simulates the effect of playing in a big room or hall where the sound reverberates off the walls and ceiling. The reverb feature will toggle on and off by pressing the REVERB button. The reverb setting does not affect the auto accompaniment. Reverb depth can be changed in the setup menu “Reverb”. Please see the Setup section for more information.

EFFECTS



EFFECTS - The EFFECTS button will add chorus, flanger or the delay effect to the selected to the selected instrument voice (s). There are eight DSP (Digital Signal Processing) effects available. Use the setup menu “Effects” to change the effect. Please see the Setup section of this manual for more information.

PIANO VOICES

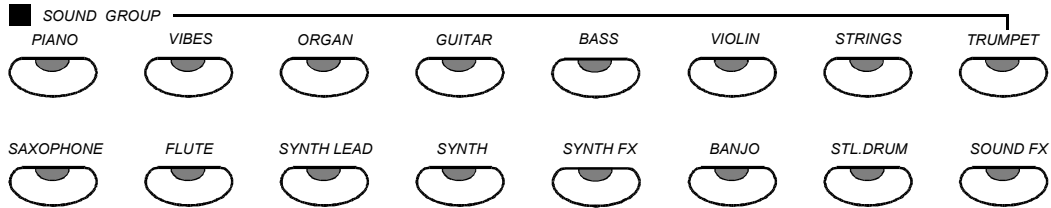

UPPER



LAYER



LOWER



SAXOPHONE



QUICK SELECT - There are 16 voices that can be selected quickly by pressing one of the 16 quick select SOUND GROUP buttons.

1. Select the mode button, UPPER, LAYER or LOWER, for the voice you want to change. The indicator will light and the screen will show the selected mode with the current voice number and name highlighted.

UPPER	1 : Grand Piano	
STYLE	1 : R & B	
NC	A1	♪ = 100

2. Press the SOUND GROUP button that corresponds to the desired voice and its the LED will light up. The voice will instantly be selected, the voice number and name will show on the display.

UPPER	65 : Soprano Sax	
STYLE	1 : R & B	
NC	A1	♪ = 100

PIANO VOICES

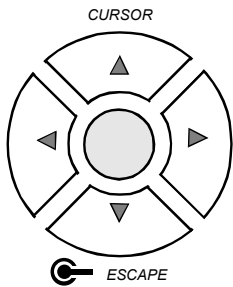
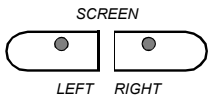

SELECTING ONE OF THE 128 VOICES

1. Press a quick select SOUND GROUP button twice, to engage a voice selection menu on the display screen. Each button is assigned eight related voices in two groups of four.

Reed		Group A
Soprano Sax		Alto Sax
Tenor Sax		Baritone Sax

2. Use the SCREEN RIGHT, SCREEN LEFT buttons to page through the voice groups.

Reed		Group B
Oboe		English Horn
Bassoon		Clarinet

3. Use the CURSOR buttons to move the highlighted area to the voice you would like to select.

Reed		Group B
Oboe		English Horn
Bassoon		Clarinet

4. Press the ENTER button to confirm your selection. The display will revert to the performance screen showing the new voice.

UPPER	70 : English Horn	
STYLE	1 : R & B	
NC	A1	♩ = 100

RHYTHM SECTION

RHYTHM STYLE SELECTION - This piano offers 50 rhythm styles and a variation of each style pattern to choose from. There is a complete list of all 50 styles in the back of the manual.

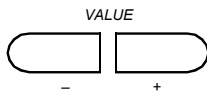
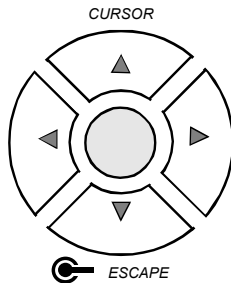

RHYTHM STYLE SELECTION - There are 50 rhythm styles in ten groups available on this piano. There is a complete list of all rhythm styles in the back of the manual.

1. Highlight the style name area using the CURSOR buttons.

UPPER	1 : Grand Piano	
STYLE	1 : R & B	
NC	A1	♪ = 100

2. Use the VALUE + and - buttons or the VALUE wheel to cycle through the piano rhythm style numbers and names until you reach the rhythm style that you would like to select. The name that is displayed is the currently selected rhythm style.

UPPER	1 : Grand Piano	
STYLE	22 : Rhumba	
NC	A1	♪ = 100

ASSIGNING THE SPLIT - The piano is split into two sections at the split point. The default split point is the G2 key for auto accompaniment. A different split point can be assigned in the setup menu "Performance". Please see the Setup section of this manual for more information.

RHYTHM SECTION

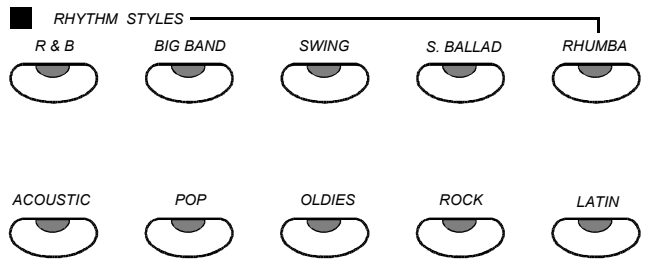

QUICK SELECT - There are ten rhythm styles that can be selected quickly by pressing one of the ten quick select RHYTHM STYLES buttons.



1. Press the RHYTHM STYLES button that corresponds to the desired rhythm style, the indicator will light up. The rhythm style will instantly be selected, the rhythm style number and name will show on the display.

UPPER	1 : Grand Piano	
STYLE	5 : Big Band	
NC	A1	♩ = 100

RHYTHM SECTION

SELECTING ONE OF THE 50 RHYTHM STYLES

1. Press a quick select RHYTHM STYLES button twice, to engage a rhythm style selection menu on the display screen. Each button is assigned four to six related rhythm styles.



Swing		Group A	
Swing		Swing Band	
Jazz 1		Jazz 2	

2. Use the SCREEN RIGHT, SCREEN LEFT buttons to page through the rhythm style groups.

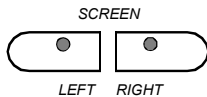

Swing		Group B	
Blues 1		Blues 2	

3. Use the CURSOR buttons to move the highlighted area to the rhythm style you would like to select.

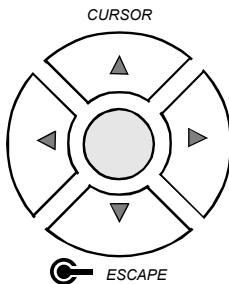

Swing		Group B	
Blues 1		Blues 2	

4. Press the ENTER button to confirm your selection. The display will revert to the performance screen showing the new rhythm style.



UPPER	70 : English Horn		
STYLE	14 : Blues 2		
NC	A1	♪ = 100	

RHYTHM SECTION

STARTING AND STOPPING THE RHYTHM STYLE - There are several ways to start and stop the rhythm style.

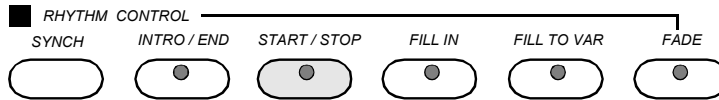

SYNCHRONIZED START - Synchronized Start mode engages the auto accompaniment mode to standby.

Press the SYNCH button, the beat indicator dots beside the TEMPO buttons will blink at the current tempo, showing that the synchronized start mode is ready. The rhythm style will start as soon as you play in the auto accompaniment section of the piano.

You may add an introduction by pressing the INTRO/ENDING button after pressing the SYNCH START button.

Press the START/STOP or the SYNCH button to stop the accompaniment. If the SYNCH button is used, the synchronized start mode will be on standby. Use the INTRO/ENDING button to finish with an ending pattern.



STARTING WITH AN INTRODUCTION - All of the 50 styles can be started with an appropriate introduction.

Press the INTRO/ENDING button, the rhythm of the introduction will start followed by the selected pattern. Press the START/STOP button to stop the accompaniment or press the INTRO/ENDING button again to stop with an ending pattern.

Please note, if you want the selected rhythm style to be engaged again after the ending pattern has been played, press a FILL-IN button while the ending pattern is engaged.



STRAIGHT START - The START/STOP button starts the selected rhythm style immediately with the percussive rhythm. Press the START/STOP button again to stop the rhythm style.

FILL IN - The fill feature will insert a short rhythmic pattern of one to two measures in length, depending on the rhythm style selected. There are two distinct fill patterns, Fill-in and Fill to

RHYTHM SECTION

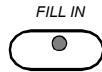
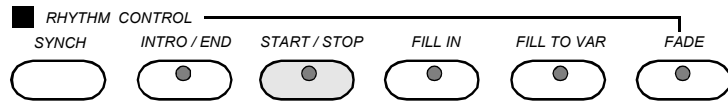

Variation. When the FILL-IN button is selected, after the fill the rhythm style will return to the main pattern. Holding down the FILL-IN button will extend the fill indefinitely. Pressing the FILL-IN button will start the rhythm style with a fill-in pattern.

FILL TO VAR (VARIATION) - The main pattern of the rhythm style is played in a loop. There is a main pattern and a variation for all style.

To select the variation of the main style, press the FILL TO VAR button. The indicator will light up.



The FILL TO VAR button functions the same as the FILL IN button but instead the variation pattern will be engaged.

FADE - The fade feature allow the user to fade in or fade out of the selected rhythm style or auto accompaniment. The fade time can be set for your playing style.

Please see the Setup section of this manual for more information.

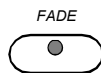

To fade in, press the FADE button, its indicator light will turn on. When you engage the selected rhythm style the selected pattern will fade in until full volume is reached and then the indicator will turn off.

To fade out, press the FADE button at any time during your musical performance. The indicator will turn on and the selected pattern will fade out until there is no volume and then the indicator will turn off. When the fade out has finished the LED will flash while the previously set volume levels are being restored.

Pressing the FADE button after it has already been engaged will switch the fade feature off.

RHYTHM SECTION

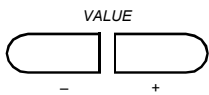
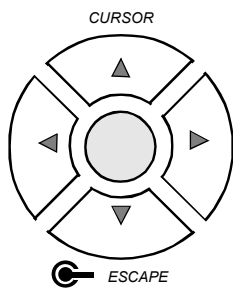
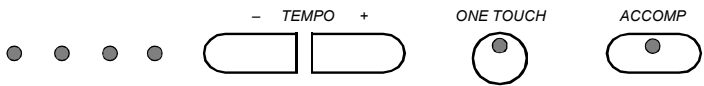

ADJUSTING THE TEMPO - There is a four-beat indicator next to the TEMPO buttons that indicate the tempo and the beat of the selected rhythm style. Each style has its own preset tempo. The tempo can be adjusted by pressing either of the Tempo + or - buttons.

Each rhythm style has its own preset Rhythm tempo. If you change the rhythm style during play, the tempo will keep its current value. However if you press the -/+ TEMPO buttons simultaneously it will set the tempo to the current rhythm styles' default value.

Note: The tempo can also be adjusted from the performance screen.

1. Use the CURSOR buttons to highlight the tempo area
OR
2. Use the - VALUE + buttons or the VALUE wheel to adjust the tempo from 40 to 250 bpm (beats per minute).

UPPER	1 : Grand Piano	
STYLE	1 : R & B	
NC	A1	♪ = 120



ONE TOUCH - Press the ONE TOUCH button to engage the one touch feature, the indicator will turn on. When the one touch feature is engaged it will automatically change the voice the voice settings and effects, and some accompaniment effects to a predetermined optimum setting, corresponding to the selected rhythm style.

Any change in the rhythm style will change the one touch settings automatically when the one touch feature is engaged.

AUTO ACCOMPANIMENT

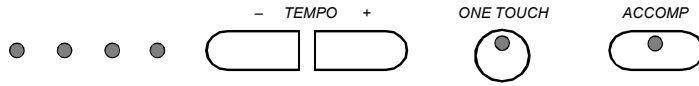

AUTO ACCOMPANIMENT (AUTO BASS CHORD) - All 50 rhythm styles have their own auto accompaniment, dedicated to that rhythm style. These auto accompaniments create fully orchestrated rhythm, bass and chord progressions based on the chords that you play with your left hand. The selected rhythm style determines the characteristics of the auto accompaniment. The auto accompaniment section of the piano is assigned by the split point. The keys on the left of the split point are reserved for the auto accompaniment. The keys to the right are available for normal playing.

Please note, when the auto accompaniment is engaged the performance display screen will show the engaged chord type in the bottom left of the screen.

1. Press the ACCOMP button, the indicator will light showing the auto accompaniment has been engaged. The display screen will show the accompaniment “Chord” menu. **Note:** this menu is also accessible from the SETUP button screen menus.

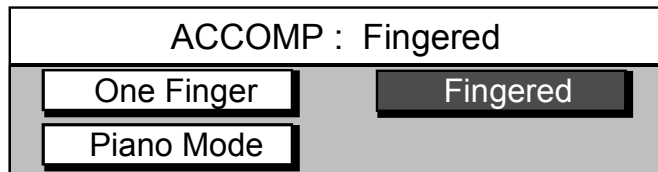
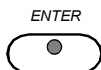
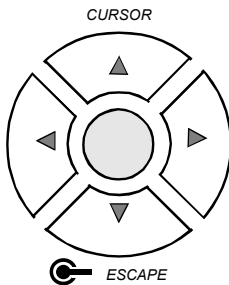

2. Use the cursor to move the highlighted area to the chord fingering mode that you want, One Finger, Fingered or Piano. The Fingered mode is the default mode.

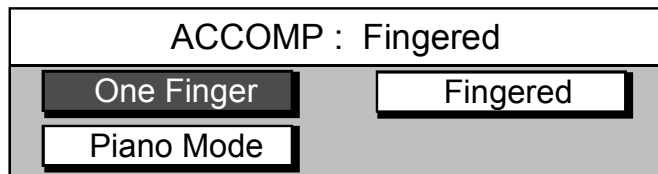

3. Press the ENTER button to confirm your selection.

AUTO ACCOMPANIMENT

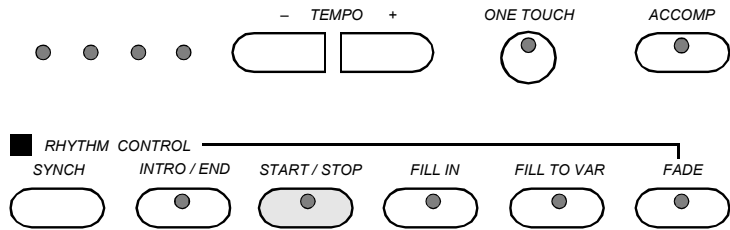

AUTO BASS CHORD FINGERING - This piano has three auto accompaniment fingering modes, one finger, fingered, and piano.



1. Press the ACCOMP button so the indicator light turns on.
2. Select the fingering mode that you want from the Chord menu. Please see the previous page for more information.

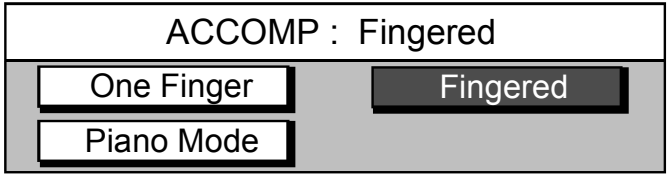

3. Press the START/STOP to start the rhythm style. Press the Sync button to start the accompaniment when you play a chord. Or press the INTRO/ENDING button to start with an introduction. Depending on the mode, you can play chords in the auto accompaniment section of the piano as described later in this section.
4. Press the START/STOP or the SYNCH buttons to stop the accompaniment, or press the INTRO/ENDING button to stop with an ending.

AUTO ACCOMPANIMENT

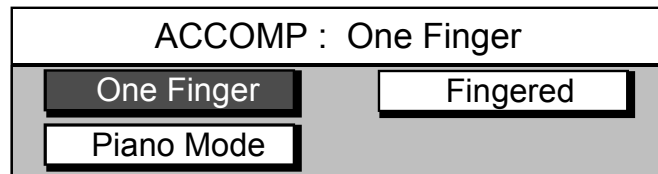

ONE FINGER MODE - Single fingering mode, or intelligent chord mode, makes it simple to produce four types of orchestrated accompaniment chords using a minimum of fingers, (one, two, or three fingers at the most), while playing in the auto accompaniment section of the piano. In this mode, keys in the auto accompaniment section of the piano are used to produce major, seventh, minor, and minor-seventh chords. The auto accompaniment will start with the percussive rhythm as soon as a recognized chord is played. The accompaniment produced is perfectly matched to the selected rhythm style. The one finger chord mode plays the nearest chord to the pressed key(s), when you press any key in the auto accompaniment section of the piano, to the left of the split point.

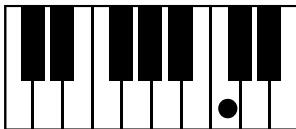

Major Chord: Press any key in the auto accompaniment section of the piano. The key you press determines the root note of the major chord.

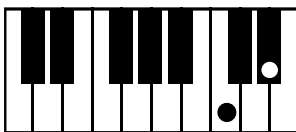

Minor Chord: Press the root key and the third piano key to its right (minor 3rd key) in the auto accompaniment section of the piano simultaneously.

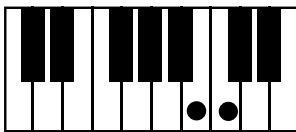

Seventh Chord: Press the root key and the piano key to its immediate left (7th key) in the auto accompaniment section of the piano simultaneously.

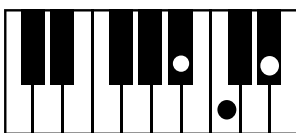

Minor-Seventh Chord: Press the root key and both the second piano key to its left (7th key) and the third piano key to its right (minor 3rd key) in the auto accompaniment section of the piano simultaneously.

AUTO ACCOMPANIMENT

ACCOMP : Fingered	
One Finger	Fingered
Piano Mode	

FINGERED MODE - The fingered mode is ideal if you already know how to play chords on the piano. It allows you to play the chords in the auto accompaniment section of the piano to produce the auto accompaniment pattern.

Please note, if a chord played cannot be recognized (fingered beyond the table shown below), the previous chord will keep playing.

An unrecognized chord cannot start the auto accompaniment in the synchronized start mode.

The "Fingering Guide" table below lists all of the 31 playable chords of this mode.

FINGERING GUIDE

Chord	Mark	Fingering
Major	M	1-3-5
Major sixth	M6	1-3-5-6
Major seventh	M7	1-3-(5)-7
Major seventh sharp eleventh	M7 #11	1-(2)-3-#4-(5)-7
Major add ninth	M 9	1-2-3-5
Major seventh add ninth	M7 9	1-2-3-(5)-7
Major sixth add ninth	M6 9	1-2-3-(5)-6
Augmented	Aug	1-3-#5
Minor	m	1-b3-5
Minor sixth	m6	1-b3-5-6
Minor seventh	m7	1-b3-(5)-b7
Minor seventh flatten fifth	m7b5	1-b3-b5-b7
Minor add ninth	m 9	1-2-b3-5
Minor seventh add ninth	m7 9	1-2-b3-(5)-b7
Minor seventh add eleventh	m7 11	1-(2)-b3-4-5-(b7)
Minor major seventh	mM7	1-b3-(5)-7
Minor major seventh add ninth	mM7 9	1-2-b3-(5)-7
Diminished	Dim	1-b3-b5
Diminished seventh	Dim7	1-b3-b5-6
Seventh	7	1-3-(5)-b7
Seventh suspend fourth	7sus4	1-4-5-b7
Seventh add ninth	7 9	1-2-3-(5)-b7
Seventh sharp eleventh	7 #11	1-(2)-3#4-(5)-b7
Seventh thirteenth	7 13	1-3-(5)-6-b7
Seventh flattened fifth	7 b5	1-3-b5-b7
Seventh flattened ninth	7 b9	1-b2-3-(5)-b7
Seventh flattened thirteenth	7b13	1-3-5-b6-b7
Seventh sharp ninth	7 #9	1-#2-3-(5)-b7
Major seventh augmented	M7aug	1-3-#5-7
Seventh augmented	7aug	1-3-#5-b7
Suspended fourth	Sus4	1-4-5

Please note, the notes listed in parentheses can be omitted.

The listed chord fingerings are all in root note position, other inversions can be used with the exception of:

1. The M6 chords are only recognized in root note position. All other inversions are interpreted as m7.
2. The 6 9 chords are only recognized in root note position. All other inversions are interpreted as minor chords.
3. The m6 chords are only recognized in root note position. All other inversions are interpreted as m7b5.
4. With aug and dim7 chords the lowest note played is assumed to be the root.
5. With 7#11 chords the lowest note played is assumed to be the root or b7.

AUTO ACCOMPANIMENT

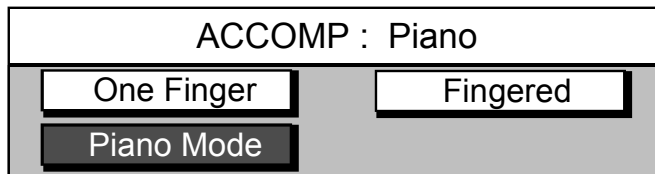

PIANO CHORD MODE - When the Piano fingering chord mode is engaged you may enter chords anywhere on the piano. The auto accompaniment will play the complete accompaniment arrangements from your chord input.

You are not limited to the auto accompaniment section or the range of the split point. Therefore there is no piano split point function for this Accompaniment mode.



MANUAL BASS CHORD - When the one finger or fingered mode is selected, you may play in the auto accompaniment section of the piano without starting the auto accompaniment.

Do not press the START/STOP or SYNCH START buttons.

The voice on this section of the piano will be a layered bass.

The chord voice is determined by the selected rhythm style.

This is a split voice mode, with the right hand playing the Upper or "main" voice.

AUTO ACCOMPANIMENT

STARTING AND STOPPING THE AUTO ACCOMPANIMENT

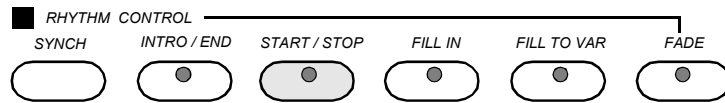

SYNCHRONIZED START - Synchronized Start mode makes the auto accompaniment standby. The auto accompaniment will start as soon as you play a recognized chord in the auto accompaniment section of the piano.



1. Press the SYNC button, the beat indicator dots beside the TEMPO buttons will blink at the current tempo, showing that the synchronized start mode is ready. You may add an introduction by pressing the INTRO/ENDING button after pressing the SYNCH button.
2. The auto accompaniment will start with the rhythm style, as soon as you play a recognized chord in the auto accompaniment section of the piano. If the auto accompaniment is off, (the ACCOMP button indicator is off), only the percussive rhythm will play.
3. Press the START/STOP or the SYNCH START button to stop the accompaniment. If the SYNCH START button is used, the synchronized start mode will be on standby.

STARTING WITH AN INTRODUCTION - All of the 50 auto accompaniments can be started with an appropriate introduction.



Press the INTRO/ENDING button, the introduction, followed by the selected pattern will start as soon as you play a recognized chord in the auto accompaniment section of the piano.

Press the START/STOP button to stop the accompaniment or press the INTRO/ENDING button again to stop with an ending pattern.

Please note, if you want the auto accompaniment to be engaged again after the ending pattern has been played, press a FILL-IN button while the ending pattern is playing.



STRAIGHT START - The START/STOP button starts the selected rhythm style immediately with the percussive rhythm. The auto accompaniment will start as soon as you play a recognized chord in the auto accompaniment section of the piano, depending on the mode selected. Press the START/STOP button again to stop the accompaniment.

AUTO ACCOMPANIMENT

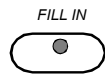

FILL - IN - The fill feature will insert a short rhythmic pattern of one to two measures in length, depending on the rhythm style selected. There are two distinct fill patterns, Fill-in and Fill to Variation.

When the FILL-IN button is selected it will return to the main pattern after the fill has been executed. Holding down the FILL-IN button will extend the fill indefinitely. Pressing the FILL-IN button will start the rhythm style with a fill-in pattern, the auto accompaniment will start as soon as a recognized chord is played in the auto accompaniment section of the piano, depending on the fingering mode selected.



FILL TO VARIATION - The main pattern of the rhythm style is played in a loop. There is a main pattern and a variation for most styles and their introduction, ending and fill-in patterns. To select the variation of the main patterns, press the FILL TO VARIATION button. The indicator will light up. The FILL TO VARIATION button will function the same as the FILL IN button but the variation pattern will be engaged. Only one pattern may be selected, if the other fill button is selected during rhythm style play, the indicator light will blink on standby until the end of the next measure. The new fill pattern will then play and the prior fill will deselect, the indicator light will go out.

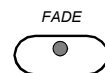

FADE - The fade feature allow the user to fade in or fade out of the selected rhythm style or auto accompaniment. The fade time can be set from 2 to 25 seconds in the setup menu "Performance". Please see the Setup section of this manual for more information.

To fade in, press the FADE button, its indicator light will turn on. When you engage the selected rhythm style the selected pattern will fade in until full volume is reached and then the indicator will turn off.

To fade out, press the FADE button at any time during your musical performance. The indicator will turn on and the selected pattern will fade out until there is no volume and then the indicator will turn off. When the fade out has finished the LED will flash while the previously set volume levels are being restored. Pressing the FADE button after it has already been engaged will switch the fade feature off.

SETUP

The setup mode is used to set up or to adjust various parameters related to the operation of this piano. The SETUP button will access menus for Performance, Harmony, Key Mode, Sustain, Reverb, Chord mode, Effects, Pedal, Percussion, and Metronome setup.

USING THE SETUP MENU

1. Press the SETUP button. The first menu screen that can be manipulated will appear on the display.

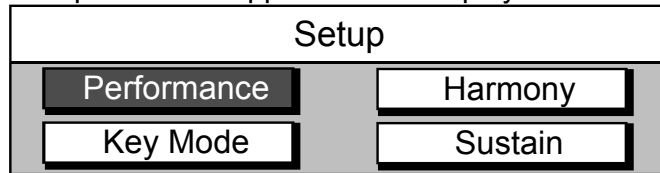

2. Press the SCREEN RIGHT button until the menu you wish to access appears on the display screen.

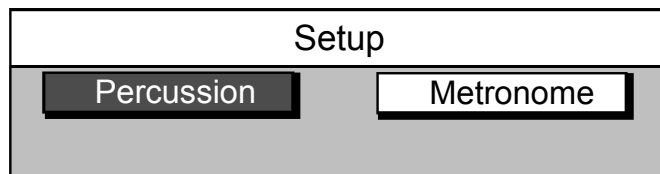
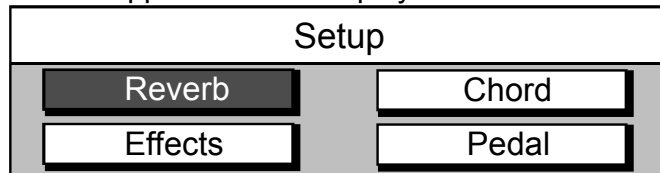

3. Use the CURSOR buttons to highlight the menu you want to use.

4. Press the ENTER button to confirm your selection. The screen for the menu you selected will appear on the display screen. If there are additional pages to the chosen menu the indicator on the SCREEN RIGHT or SCREEN LEFT buttons will be lit. Use the SCREEN RIGHT or SCREEN LEFT button if necessary to reach the parameter you need to adjust.

5. Use the CURSOR button to highlight the parameter and if necessary change it by using the – VALUE + buttons, or the VALUE wheel.

6. Press the ENTER button to confirm your selection. At any time you may use the ESCAPE button to revert to the previous screen. Continued pressing of the ESCAPE button will return the screen to the initial parameter screen, or press the SETUP button to turn the indicator off and disengage the setup mode.

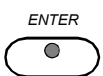
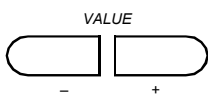
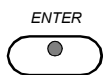
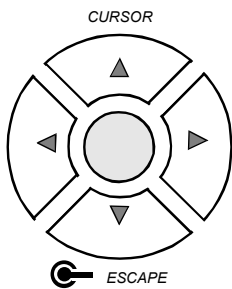
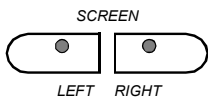

SETUP

PERFORMANCE SETUP MENU

1. Press the SETUP button.
2. Press the ENTER button to access the Performance menu.
3. Use the CURSOR button to access the following options.

Velocity

Performance Setup			
Velocity	Norm	Split Point	G2
Transpos	0	Screen Hold	45

The piano offers four types of piano velocity settings, low, normal, high, and fixed. These are also known as touch sensitivity or dynamic curves and are designed to suit your style of playing. The normal setting is selected automatically when the piano is turned on. Use the VALUE buttons to select a velocity, press the ENTER button to confirm.

Low is a less sensitive piano response which requires a heavier touch to obtain maximum sound levels.

Normal is an intermediate response suitable for most styles of music. Normal is the default setting.

High is the most sensitive piano response which permits maximum sound levels with a light touch.

Fixed does not offer any touch sensitivity. Each key plays at full volume no matter how hard the piano key is hit. It is commonly used on Harpsichord and Organ voices.

Split Point

Performance Setup			
Velocity	Norm	Split Point	G2
Transpos	0	Screen Hold	45

The split point divides the piano into two sections for both the voice, and the auto accompaniment.

In the lower mode, the right hand section the main or the layered voice will sound, and in the left hand section a different voice can be assigned, the lower voice, to sound when the keys are played. Please see the Piano Voices section for more information.

The auto accompaniment split point divides the piano into an accompaniment section and a melody section. Please see the Auto Accompaniment section for more information.

The default split point is the G2 key. Use the – VALUE + buttons or the VALUE wheel to select a split point in the range of C2-C4. Press the – VALUE + buttons simultaneously to recall the default setting.

SETUP

PERFORMANCE SETUP MENU

1. Press the SETUP button.
2. Press the ENTER button to access the Performance menu.
3. Use the CURSOR button to access the following options.

Transpose

Performance Setup			
Velocity	Norm	Split Point	G2
Transpos	0	Screen Hold	45

The transpose feature can shift the pitch of the piano up or down in semitone intervals. Use the VALUE + or VALUE – buttons to set the transpose value range from –5, five keys lower, to 6, six keys higher. Press the + and – VALUE buttons simultaneously to recall the default value of 0. Transpose does not affect notes that are sounding and it does not affect the piano percussion.

Screen Hold

Performance Setup			
Velocity	Norm	Split Point	G2
Transpos	0	Screen Hold	4S

The screen hold sets the time for which the selected screen will stay on the display before automatically returning to the prior screen. Use the – VALUE + buttons or the VALUE wheel to select a screen hold in the range of 1second to 44 seconds. Press the – VALUE + buttons simultaneously to recall the default setting of 4 seconds.

SETUP

PERFORMANCE SETUP MENU (PAGE 2)

1. Press the SETUP button.
2. Press the ENTER button to access the Performance menu.
3. Press the SCREEN RIGHT button to access the second page of the Performance menu.
4. Use the CURSOR button to access the following options.

Tune

Performance Setup			
Tune	0	Fixed Level	100
Fade Time	105	Octave Shift	0

The pitch of this piano is very accurate and stable, it is automatically set to standard A440 pitch when the piano is turned on. The tuning feature makes it possible to tune the pitch of the instrument in fine intervals. If necessary, you can match the piano to another instrument or singer. Use the – VALUE + buttons or the VALUE wheel to select a tuning value in the range of –50 to +50 semitone steps, or cents. Press the – VALUE + buttons simultaneously to recall the default setting of 0.

Fixed Level

Performance Setup			
Tune	0	Fixed Level	100
Fade Time	105	Octave Shift	0

The fixed level adjusts the volume output when the velocity sensitivity is set to fixed. Use the – VALUE + buttons or the VALUE wheel to select a fixed level volume value in the range of 10-127. Press the – VALUE + buttons simultaneously to recall the default setting of 100.

SETUP

PERFORMANCE SETUP MENU (PAGE 2)

1. Press the SETUP button.
2. Press the ENTER button to access the Performance menu.
3. Press the SCREEN RIGHT button to access the second page of the Performance menu.
4. Use the CURSOR button to access the following options.

Fade Time

Performance Setup			
Tune	0	Fixed Level	100
Fade Time	105	Octave Shift	0

Fade time adjusts the length of time that an accompaniment fade introduction or fade out ending takes. Use the VALUE + and - buttons or the VALUE wheel to select a fade tune value in the range of 2-25 seconds. Press the VALUE + and - buttons simultaneously to recall the default setting of 105 seconds.

Octave Shift

Performance Setup			
Tune	0	Fixed Level	100
Fade Time	105	Octave Shift	0

The octave shift will transpose the entire piece one octave down, 12 semitone steps. Use the VALUE + and - buttons to select an octave shift of -1, and the keys will play as if they were an octave lower on the piano. Press the VALUE + and - buttons simultaneously to recall the default setting of 0, and return the octave setting to normal.

HARMONY SETUP MENU

SETUP

1. Press the SETUP button.
2. Use the CURSOR button to highlight the Harmony menu.
3. Press the ENTER button to access the Harmony menu.
4. Use the CURSOR button to select a harmony type, then use the VALUE buttons to turn that harmony type on or off. Only one harmony type can be selected at a time.

Harmony		
Trio	Duet	Oct
OFF	OFF	OFF

Harmony Type Selecting – Harmony is used to enhance a single note melody played while the auto accompaniment is engaged. With the harmony feature engaged, a single note on the right-hand section of the piano will sound with additional auto harmony notes. The note played in the right-hand section of the piano determines the root key of the harmony. If more than one note is played only the highest note will add harmony.

Please note, auto harmony is only available when the auto accompaniment is engaged.

Trio adds two harmonizing notes sounding below the single right hand melody note that you supply, when the chord accompaniment is playing.

Duet adds a harmonizing note sounding below the single right hand note that you supply when the chord accompaniment is playing.

Octave add a note one octave below the note(s) you play in the right hand section of the piano when the chord accompaniment is playing.

KEY MODE SETUP MENU

SETUP

1. Press the SETUP button.
2. Use the CURSOR button to highlight the Key Mode menu.
3. Press the ENTER button to access the Key Mode menu.
4. Use the CURSOR button to select a key mode type, then use the VALUE buttons to turn that key mode type on or off.

Manual Bass

Key Mode	Manual Bass	OFF
	Lower Hold	OFF

The manual bass feature will automatically select a split piano with the keys below the split point playing notes on the bass channel, thus allowing you to play a manual bass line with your left hand. If the rhythm style is engaged, manual bass replaces the accompaniment bass. The accompaniment bass will return at the start of the next var, or when a new chord is generated. Manual bass is disabled when the lower voice mode is engaged. The fingered chord stores its own version of manual bass, which will be on by default.

Lower Hold

Key Mode	Manual Bass	OFF
	Lower Hold	OFF

When the lower hold feature is selected and turned on, the notes below the split point will remain playing even though the keys have been released. The notes are cancelled when new keys are pressed, or when the pedal, assigned to lower hold, is engaged. If the auto accompaniment is engaged, in the one finger or fingered mode, and the harmony feature is on, selecting lower hold will play the lower sound's harmony.

SUSTAIN SETUP MENU - The sustain pedal can affect the Upper, Layer and/or Lower channels of this piano. This menu allows you to configure which melody channels will

SETUP

be affected by the sustain pedal.

1. Press the SETUP button.
2. Use the CURSOR button to highlight the Sustain menu.
3. Press the ENTER button to access the Sustain menu.
4. Use the CURSOR button to select a sustain type, then use the VALUE buttons to turn that sustain type on or off. Sustain defaults to all options on.

Upper

Sustain		
UPPER	LAYER	LOWER
ON	ON	ON

When sustain upper is turned on the right pedal when engaged, pressed down, the upper voice keys will sustain.

Layer

Sustain		
UPPER	LAYER	LOWER
ON	ON	ON

When sustain layer is turned on the right pedal when engaged, pressed down, the layer voice keys will sustain.

Lower

Sustain		
UPPER	LAYER	LOWER
ON	ON	ON

When sustain lower is turned on the right pedal when engaged, pressed down, the lower voice keys will sustain.

REVERB SETUP MENU - Reverb simulates the effect of playing in a big room or hall where the sound reverberates off the walls and ceiling. The reverb effect is engaged automatically when

SETUP

the power is turned on.

Pressing the REVERB button will toggle this effect on or off. When reverb is engaged the indicator light will be lit. **To select a type of reverb and to adjust the reverb levels use the Reverb setup menu.**

1. Press the SETUP button.
2. Use the SCREEN RIGHT button to access the second page of the setup menu options.
3. Press the ENTER button to access the Reverb menu.
4. Use the CURSOR button to access the following options:

Reverb Setting			
Reverb	UPPER	LAYER	LOWER
Room 3	100	100	100

Reverb - Use the VALUE + and - buttons to select a reverb type below. Press the VALUE + buttons simultaneously to recall the default setting of Room 3.

Room 1 is dense reverb with short decay.

Room 2 is sparse reverb with short decay.

Room 3 is sparse reverb with medium decay.

Hall 1 is reverb with clear reverberation and medium decay.

Hall 2 is reverb with rich reverberation and greater late reflections.

Plate is a delay type.

Delay is stereo delay that produces two delay sound, left and right.

Panning emphasizes the stereo location of the processor delay, the effect will be spaced at 30 degrees from the center.

REVERB SETUP MENU continued

Upper - When reverb upper is turned on the upper voice keys will reverberate. Use the VALUE + and - buttons to select a reverb level from 0-127. Press the VALUE + and - buttons

SETUP

simultaneously to recall the default level of 100.

Reverb Setting			
Reverb	UPPER	MIDDLE	LOWER
Room	100	100	100

Layer - When reverb layer is turned on the layer voice keys will reverberate. Use the VALUE + and - buttons to select a reverb level from 0-127. Press the VALUE + and - buttons simultaneously to recall the default level of 100.

Lower - When reverb lower is turned on the lower voice keys will reverberate. Use the VALUE + and - buttons to select a reverb level from 0-127. Press the VALUE + and - buttons simultaneously to recall the default level of 100.

CHORD SETUP MENU - Pressing the ACCOMP button engages the auto accompaniment. In this mode, the keys to the left of the split point can be used to create fully orchestrated chord progressions, based on the chords that you play with your left

SETUP

hand.

There are three fingering modes to choose from, One finger, Fingered or Piano.

Use the Chord menu to select a mode, please see the Auto Accompaniment section of this manual for more information on fingering modes.

1. Press the SETUP button.
2. Use the SCREEN RIGHT button to access the second page of the setup menu options.
3. Use the CURSOR button to highlight the Chord menu.
4. Press the ENTER button to access the Chord menu.
5. Use the CURSOR button to select a fingering mode. Use the ENTER button to confirm your selection.



section of the piano. It takes only one finger to engage your desired chord, the nearest chord to the pressed key(s) in the auto accompaniment section of the piano.

Fingered - The fingered mode is for the user who knows how to play chords on the piano, it allow the user to supply the actual full three or four note chords to produce the desired auto accompaniment pattern.

Piano - When the piano fingering chord mode is selected, you may enter chord into the auto accompaniment mode from anywhere on the piano. You are not limited to the auto accompaniment section or the range of the split point, so in this regard there is no split point for this mode.

EFFECTS (CHORUS) SETUP MENU - The effect or chorus enriches your performance by adding depth, texture and spaciousness to the selected instrument voice.

SETUP

Pressing the EFFECTS button on the control panel will toggle the Effects Function on and off.

The effects setting does not affect the auto accompaniment. Select the type of effect and adjust the level in the Effect menu.

1. Press the SETUP button.
2. Use the SCREEN RIGHT button to access the second page of the setup menu options.
3. Use the CURSOR button to highlight the Effects menu.
4. Press the ENTER button to access the Effects menu.
5. Use the CURSOR button to access the following options:

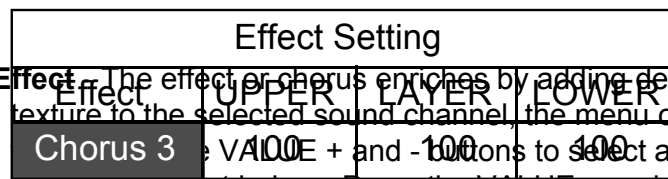

The effect or chorus enriches by adding depth and texture to the selected sound channel, the menu offers eight type from the list below. Press the VALUE + and - buttons simultaneously to recall the default setting of Chorus 3.

- Chorus 1.
- Chorus 2.
- Chorus 3.
- Chorus 4.

F B (feedback) Chorus applies a repeated sound effect.

Flanger gives an electronic swirl effect.

Short Delay offers a short delay effect.

F B (feedback) Delay applies a delayed repeated sound effect.

EFFECTS (CHORUS) SETUP MENU continued

Upper - When effect upper is turned on the selected instrument voice for the upper sound channel will sound with the

SETUP

selected effect. Use the – VALUE + buttons to select a effect depth level from 0-127. Press the – VALUE + buttons simultaneously to recall the default level of 100.

Effect Setting			
Effect	UPPER	LAYER	LOWER
Chorus 3	100	100	100

Layer - When reverb layer is turned on the layer voice keys will sound will the selected effect. Use the – VALUE + buttons to select a effect depth level from 0-127. Press the – VALUE + buttons simultaneously to recall the default level of 100.

Lower - When reverb lower is turned on the lower voice keys will sound will the selected effect. Use the – VALUE + buttons to select a effect depth level from 0-127. Press the – VALUE + buttons simultaneously to recall the default level of 100.

PEDAL SETUP MENU - The center pedal is an assignable function pedal. The sustain pedal, on the right, can only control the melody channels, and the soft pedal, on the left, is not assignable.

SETUP

1. Press the SETUP button.
2. Use the SCREEN RIGHT button to access the second page of the setup menu options.
3. Use the CURSOR button to highlight the Pedal menu.
4. Press the ENTER button to access the Pedal menu.
5. Use the CURSOR button to select the following options, the pedal can only be assigned to one.

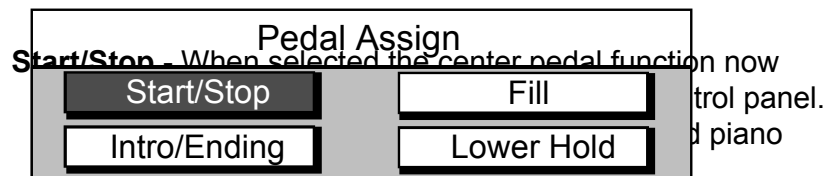

The pedal assign defaults to Start/Stop.

Fill - When selected the center pedal function now responds like the fill buttons on the control panel. Pressing the function pedal triggers the fill of the currently selected fill-in the main pattern or the fill to variation.

Intro/Ending - When engaged the center pedal function now responds like the Into/Ending button on the control panel. Therefore when selected pressing the center function pedal triggers an introduction or ending pattern.

Lower Hold - The lower hold setting sets the center pedal assignment to lower hold, pressing the pedal will prevent notes below the split point from being switched off until the pedal is released.

If lower hold from the key mode setup is engaged, the pedal can be used to cancel notes that are played.

PERCUSSION (DRUM KIT SELECTION) - When piano percussion is engaged by using the Percussion menu, the entire piano will play the percussion voices from the selected Drum kit.

The keys will not be available for normal play.

SETUP

There are eight drum kits, based on the standard kit, that can be assigned and a sound effects kit.

Please see the “Drum List” at the back of the manual for a complete listing.

1. Press the SETUP button.
2. Use the SCREEN RIGHT button to access the third page of the setup menu options.
3. Press the ENTER button to access the Percussion menu.
4. Use the – VALUE + buttons or the VALUE wheel to select one of following options. Press the – VALUE + buttons simultaneously to recall the default setting of OFF.

OFF - If OFF is selected the piano percussion mode will not be engaged, to engage the percussion mode select one of the following drum kits.

Percussion Setup	
Drum Kits	
Standard	
Room	OFF
Power	
Electronic	
TR-808	
Jazz	
Brush	
Orchestral	
SFX	

METRONOME SETUP MENU - The built in metronome is a timing device.

It is used as a timing reference to aid with practice or performance. Press the **METRONOME** button on the control panel to engage the metronome feature. The indicator will turn on, the display screen will show the Metronome

SETUP

menu and the metronome sound will start immediately. You can access the Metronome menu from the SETUP button as follows.

1. Press the SETUP button.
2. Use the SCREEN RIGHT button to access the third page of the setup menu options.
3. Use the CURSOR button to highlight the Metronome menu.
4. Press the ENTER button to access the Metronome menu.
5. Use the CURSOR button to access the following options:

Time Signature - The time signature can be set to 2/4, 3/4, 4/4, 6/8 and 9/8. Use the VALUE buttons to set the bottom time signature, then use the CURSOR button to highlight the top section, the VALUE buttons can then be used to complete the time signature with the available options.

Tempo - The tempo of the time signature can be adjusted, use the – VALUE + buttons or the VALUE wheel to adjust the tempo from 40-250 bpm (beats per minute). Press the – VALUE + buttons simultaneously to recall the default setting of 100 bpm. Adjusting the metronome tempo will also affect the rhythm style tempo.

Sound - The metronome can be assigned to sound as any of the percussive voices from the standard drum kit. The first measure of the beat is assigned in the first part of the sound section and the remaining beats are assigned in the second part of the sound section. Use the – VALUE + buttons to assign a sound by key number. Please see the drum kit list in the back of the manual for a list of available sound.

Volume - Use the – VALUE + buttons or the VALUE wheel to adjust the metronome sound volume level from 1-127. Press the – VALUE + buttons simultaneously to recall the default setting of 100.

REGISTRATION MEMORY

A registration is a particular set up of style, voice, chord and other parameters or features you are using.

By saving your “set up” it can be recalled by pressing a single button.

This piano has four banks with six registration numbers in each bank, for a total of 24 registrations.

The unit is equipped with a backup battery, so the data in the registration memory is nonvolatile and will not be lost when the power is turned off.

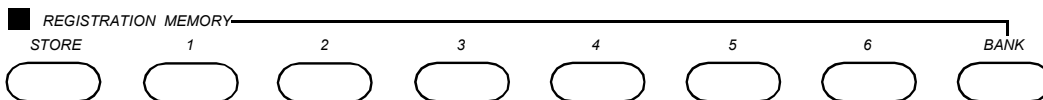

SAVE YOUR SETTINGS IN THE REGISTRATION MEMORY



1. Set the voice, rhythm, tempo, accompaniment, reverb effect and any other parameters that you wish to save.
2. Select the bank that you would like to use to store your setting A-D.
3. Hold down the STORE button.
4. Press one of the REGISTRATION NUMBERS buttons 1-6. The display will show the current registration memory number with the bank prefix. Your panel setting will be saved into that registration memory instantly.

Please note, storing a setting into the registration memory will erase the previously stored data in that registration location

UPPER	1 : Grand Piano	
STYLE	1 : R & B	
NC	A5	♪ = 100

RECALL CONTENTS IN THE REGISTRATION MEMORY



1. Press the BANK button to access the registration memory bank you would like to recall, the display screen will show the bank A-D.
2. Press one of the REGISTRATION NUMBER buttons 1-6, the stored setting will be recalled instantly and the display will show the memory number with the bank prefix. The relevant parameters will be set and the display will reflect the voice that has just been recalled.

RECORD

This piano is equipped with a real time 5 track recorder (sequencer).

It is designed to be very simple to use.

It will record all note events and the accompaniment patterns exactly as they are performed. All the recorded tracks can playback separately or together as a complete song.

This recorded information is nonvolatile and therefore will not be lost when the power is turned off.

You may also save your recorded information to disk.

Please see the Disk section of this manual for more information.

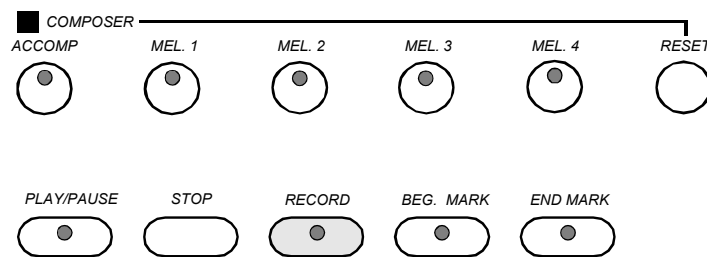

Record Melody Track Only - Any of the Melody tracks will record all piano note events, as they were performed. There are four tracks available for recording the melody, these are assigned by pressing one of the four MELODY buttons.

If one of the MELODY buttons is selected the recording will begin as soon as you play on the piano.

Note: Only one melody track can be recorded at a time.

Please note, While recording in a Melody only track with the Accompaniment mode is engaged, the auto accompaniment section of the piano will not be recorded, although the notes are sounding.

Record Auto Accompaniment Track Only - Auto Accompaniment

RECORD

will record, the chord changes, style, tempo, variation, intro, fill-in and ending.

Pressing The ACCOMP track button will select the accompaniment track for recording.

If only the ACCOMP Record track button has been selected, the auto accompaniment Record will be synchronized to start when the piano keys are played.

Recording will start as soon as a chord is played on the auto accompaniment section of the piano.

Any accompaniment performance, such as fill-ins, Intro's, Ending etc.. will be recorded exactly as it was performed.

Please note, notes played on the Melody section of the piano will not be recorded in the auto accompaniment track.

If the auto accompaniment is off, only the percussive rhythm will be recorded.

An unrecognized chord in the fingered mode cannot start the recording.

Recording both the Auto Accompaniment and a Melody Track at the same time

If you want to record a melody and the accompaniment at the same time,

Press a MELODY track button, then the ACCOMP track button and both indicators.

Both indicators will blink on standby.

Recording will begin as soon as you start to play on any section of the piano.

RECORD

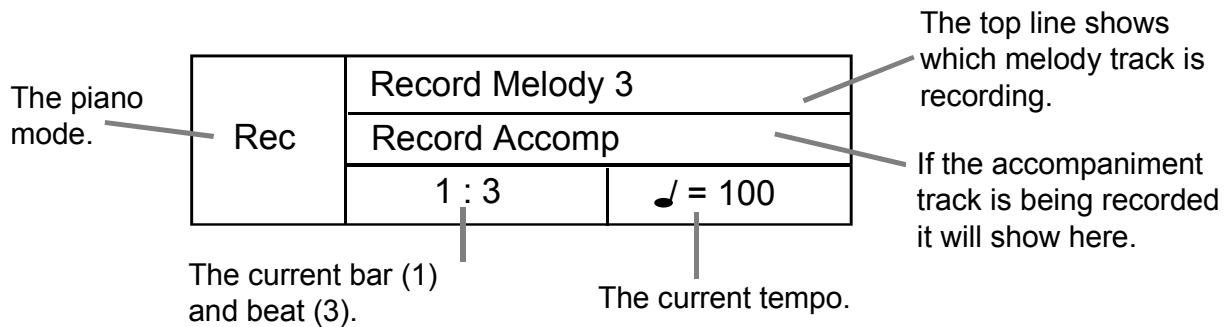

RECORDING

1. **Prepare** - Prepare to record by setting the voice, style, tempo and reverb level and other parameters as desired. These settings can be stored into a registration memory for easy recall, please see the Registration Memory section for more information.



2. **Select a track** - Press the RECORD button, the indicator will blink. The first available melody track will also be selected and the corresponding indicator will also blink. The four LEDS of the beat indicator will blink with the current tempo, to show that the recorder is on standby.

NOTE: If you have a recorded track(s) or if there is data in a track, its indicator will also be lit and the recorded music will play, as a reference, while you record the new track. If you do not wish for previously recorded tracks to play while you are recording, press the corresponding track button to turn the indicator light off.



If you wish to record on a different melody track or the accompaniment track, simply press the corresponding button to select.

4. **Record** - Recording will start as soon as you play on the piano, depending on the track(s) that are selected.



5. **Stop Recording** - Press the STOP button, the PLAY/PAUSE button or the REC button again to stop recording. If the accompaniment track is being recorded, you may also press the INTRO/ENDING button to stop the recording with an ending pattern in the accompaniment track.



Please note, when the record memory is full, recording will stop automatically.



6. **Erase a Track** - If you would like to erase or rerecord a track, hold the RESET button down while you press the track button that you would like to erase. The information will be erased immediately, and the track will be cleared.

RECORD

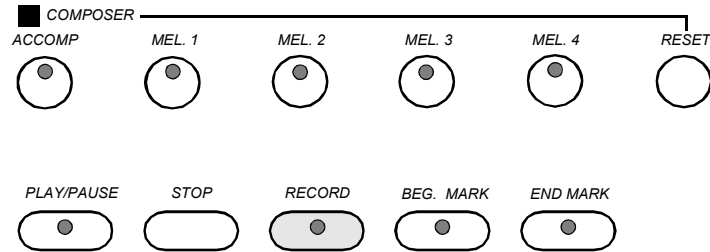

PLAYBACK - To hear your recording follow these directions.

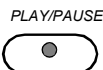
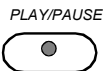

1. The indicators of the tracks with recorded information in them will be lighted.
If you do not wish to hear a track, press the corresponding track button to turn that track off.
The track can be turned on again by pressing the track button after playback.
2. Press the PLAY/PAUSE button to start the recorded track(s), the indicator will stay on until the playback is complete. The dots of the beat indicator will flash with the recorded tempo. You can change the tempo by pressing the +TEMPO- buttons.
You may play on the piano while the recording is playing back.
3. While the playback is in process press the PLAY/PAUSE button to pause the playback.
The indicator will blink, press again to restart the playback where you left off.
Press the STOP button to stop the playback and reset it to the beginning, or it will stop automatically when the recording reaches its end.

RECORD

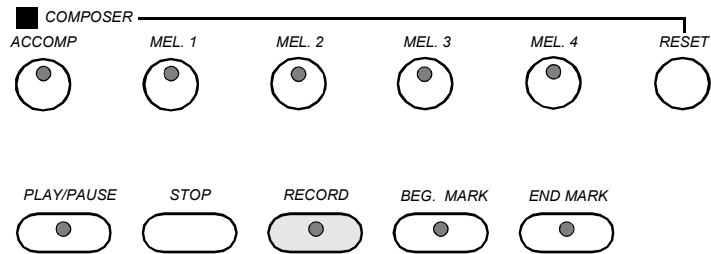

MARK - The mark feature allows you to isolate a section of the recording of the song.

This marked sequence will function under the same parameters as the real-time recording, except it is only that portion of the song instead of the entire track. If you would like study or to embellish a segment of your recording or to correct a mistake it can be easily accomplished with the BEG MARK, END MARK buttons.

PLAY/PAUSE



BEG. MARK



END MARK



PLAY/PAUSE



RECORD



1. With your musical performance recorded into the sequencer, press the PLAY/PAUSE button.
2. While listening to the playback press the BEG MARK button at the place you would like to begin to isolate the sequence, the indicator will light up.
3. As your recording or sequence continues to playback when the portion you would like to isolate is finished press the END MARK button. Its indicator will light up.
4. Stop the recording by pressing the STOP button. Press the PLAY/PAUSE button again to listen to the marked section.
5. Press the RECORD button and choose a track. The recorded passage will playback from the beginning of the marked section until the end mark. You may now record in only the marked section.
6. Press the BEG MARK and END MARK buttons again to disengage the marked section, the recording can now be played back in its entirety.

LESSON

The SONG button will access a music Lesson package that can be used for fun and entertainment to improve your playing. There are over 50 songs built into the piano as reference for your Lesson entertainment.

SONG SELECT

1. Press the SONG button to display the Song Select Screen.

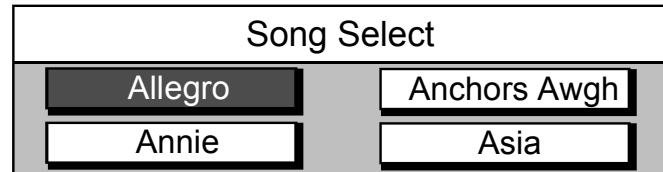
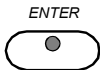
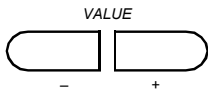
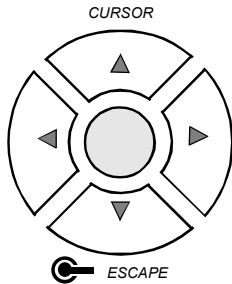
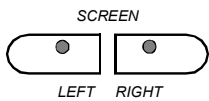

2. Use the SCREEN RIGHT button to access subsequent pages in the Song Select menu until the abbreviated song name you would like to use is displayed.

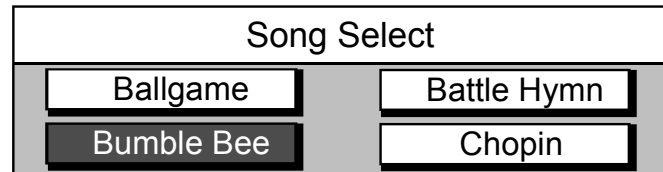

3. Use the CURSOR to highlight the song you would like to select. The display will change to the music Lesson screen after you press the "Enter" button for the song you you have selected.
4. Use the CURSOR buttons to highlight the areas you need to edit in the Lesson program as described following in the next section of this manual.
5. Use the VALUE buttons to edit the highlighted areas.
6. Highlight "Play" to hear the song or "Test" to test your playing on the song. Press ENTER to confirm your selection and start the playback or test.

Bumble Bee	Measure	
Play	RHnd=Y LHnd=Y Acmp=Y	
Test	R=Y L=Y	♩ = 110

LESSON

The name of the selected song.

Use "Play" to listen to the selected parts of the song.

Use "Test" to test yourself on the selected parts of the song.

Bumble Bee	Measure	
Play	RHnd=Y LHnd=Y Acmp=Y	
Test	R=Y L=Y	♩ = 110

This area will count the songs measure during play or test.

On this line select the parts of the song you would like to hear during playback are listed. The right hand melody, the left hand accompaniment and the rhythm accompaniment (where applicable).

Select the "Hands" that you would like to be tested on: right hand melody, left hand accompaniment or both hands.

The selected songs tempo.

USING THE LESSON FEATURE

1. **Engage the Lesson mode** - Press the SONG button to engage the performance Lesson function. The Song Select menu will appear on the display. Use the SCREEN RIGHT/LEFT, the CURSOR and the ENTER buttons to select the song you would like to use.
2. **Listen to the selected Song** - Highlight "Play" and press the ENTER button to listen to the song demonstration. You may listen to the right hand melody, the left hand accompaniment, the rhythm accompaniment (where applicable) or any combination of the three by highlighting the appropriate area and using the VALUE buttons to turn those parts on, Y(Yes) or off, N (No).

LESSON

USING THE LESSON FEATURE continued

3. **Test** - Highlight "Test" and press the ENTER button to test your playing on the selected song.
You may test yourself on the right hand melody, the left hand accompaniment or both hands by highlighting the appropriate area and using the VALUE buttons to toggle those parts on, Y (Yes) or off, N (No).
Right hand exercise - Select R=Y L=N. Then press the ENTER button, after the metronome sound the auto accompaniment will playback, and you should play the right hand melody following it's rhythm.
Left hand exercise - Select R=N L=Y. Then press the ENTER button, after the metronome sound the melody will playback with rhythm accompaniment (where applicable), you should play the left hand accompaniment to match the melody.
Right and Left hand exercise - Select R=Y L=Y. Then press the ENTER button, after the metronome sound, you should play the entire section with both hands following the rhythm accompaniment (where applicable).
4. **Check you progress** - You will hear a vocal grading when you finish evaluating the performance. The vocal grades are "Try Again", "Good", "Very good" and "Excellent".
5. **Stop the Lesson** - Press the SONG button again to exit the Lesson course.

DISK (HP-275e Only)

The disk feature allows you to load, save, delete or rename your recorded musical performances (songs).

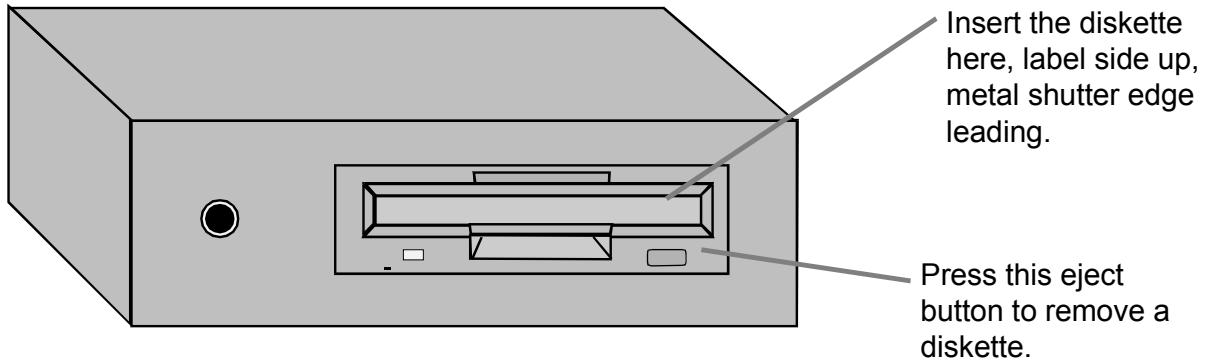

INSERT THE DISK - Insert the 3.5 disk into the disk drive with the label side up and the metal shutter leading into the drive. Slide the diskette into the drive until it clicks into place. The disk eject button on the drive pops out when the disk is properly inserted.

REMOVE THE DISK - To remove the diskette press the eject button on the disk drive.

Please note, to avoid loss or damage to the disk or the disk drive, do not remove the disk drive from the unit, or turn the power off when the disk drive indicator light is on.

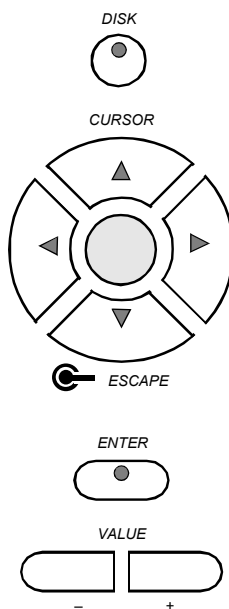

DISK MAIN MENU SCREEN

1. Press the DISK button to activate the Disk Menu screen, the indicator will turn up.

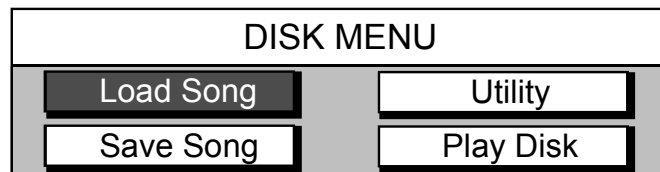

2. Use the CURSOR buttons to highlight the menu you would like to access.

3. Press the ENTER button to confirm your selection, follow the instructions on the screen as they are displayed

4. Use the VALUE buttons to enter or change information as requested.

DISK (HP-275e Only)

Load Song - Load Song retrieves a previously stored MIDI song from the floppy disk drive. If you want to permanently edit a song you must load the file into the music recorder (sequencer). Since the Standard MIDI file that you have on disk and your musical performance in the recorder (sequencer) share the same memory, selecting a song file may bring up a confirmation pop up screen, saying it will overwrite the song that is currently in the sequencer.

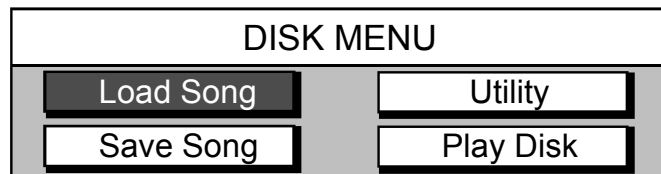

1. Make sure the disk you have selected has song data files on it. Any standard MIDI file formatted song will be recognized by the piano's recorder (sequencer).
2. Select the Load Song menu, and the list of song files contained on the disk will be displayed on the screen. If there are more than 4 songs on the disk, the SCREEN RIGHT/LEFT indicators will be lit. Press them to access the additional song files on the disk.
3. Highlight the song file you would like to load and press the ENTER button. A caution screen will appear asking if you are sure you want to load the song file sequence.
4. "OK" the command. A progress bar will be displayed showing the status of the load. The main disk menu screen will be displayed after your selected song file has been loaded.
5. Press the PLAY/PAUSE button, the song you have just loaded into the sequencer will begin to play.

DISK (HP-275e Only)

Save Song - Save song lets you save your musical performance data that you recorded in the 5 track sequencer and save it onto a floppy disk so that it can be accessed later.

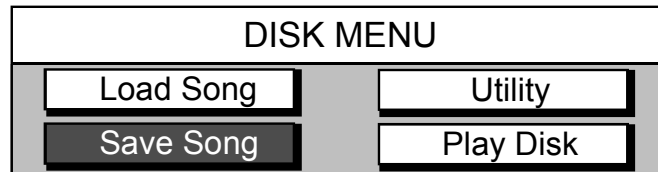

1. Make sure the disk you have selected has room to store the song data files on it.
2. Select the Save Song menu, the menu will be dedicated to naming the song (sequence) you want to save.
3. Use the VALUE buttons or Value wheel to obtain the desired name by increments up or down. A caution screen will appear asking if you are sure you want to save the song file sequence.
4. "OK" the command to save the song to floppy disk. A progress bar will be displayed showing the status of the save. The main disk menu screen will be displayed after your selected song file has been saved.

DISK (HP-275e Only)

Utility - Selecting Utility will access a Disk Utility sub-menu.

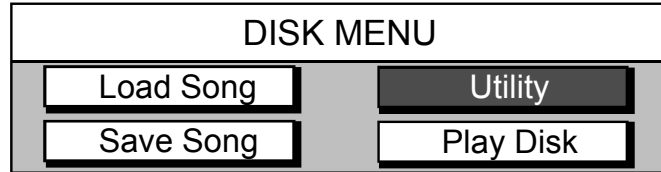

Use the Utility sub-menu to access the following options.

Format - Format prepares a new disk for use. Most Floppy disks have been formatted but if you happen to have a disk that is not formatted then data cannot be stored on it. Format will erase all previous files on a disk, so make sure you can afford to erase all the data on the floppy disk that you are formatting.

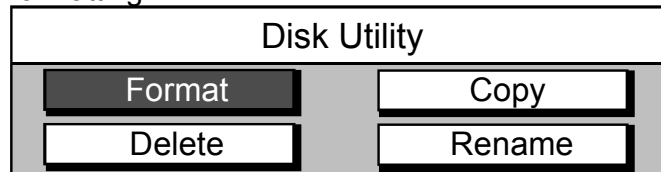

1. Load the disk into the disk drive. Make sure that the disk you have selected can be completely erased.
2. Select the Format menu, a progress bar will be displayed. When formatting is complete the main disk menu screen will be displayed.

Copy - Copy is used to duplicate a file from the disk.

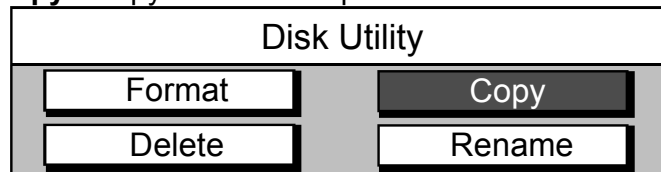

1. Load the disk into the disk drive. Make sure that the disk you have selected has the song data file you want to copy.
2. Select the Copy menu, the menu will show the available songs on the disk. If there are additional pages the indicator light on the SCREEN RIGHT/LEFT buttons will light.
3. Select the song you want to copy, and press the ENTER button.
4. Use the VALUE buttons or wheel to rename the copied song, a progress bar will be displayed. When copying is complete the main disk menu screen will be displayed.

DISK (HP-275e Only)

Utility Menu continued

Delete - Delete is used to remove unwanted files from the disk to make more space available.

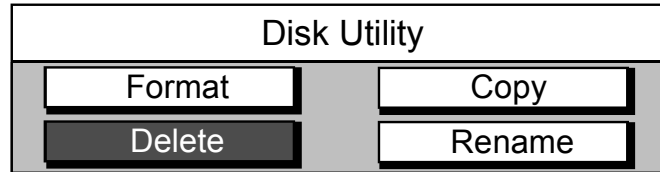

1. Load the disk into the disk drive. Make sure that the disk you have selected has the song data file you want to delete on the disk.
2. Select the Delete menu, the menu will show the available songs on the disk. If there are additional pages the indicator light on the SCREEN RIGHT/LEFT buttons will light.
3. Select the song that you want to delete, and press the ENTER button. A progress bar will be displayed. Once the file has been removed the main disk menu screen will be displayed. This file operation is irreversible.

Rename - Rename is used to change the name of a file already saved to the disk.

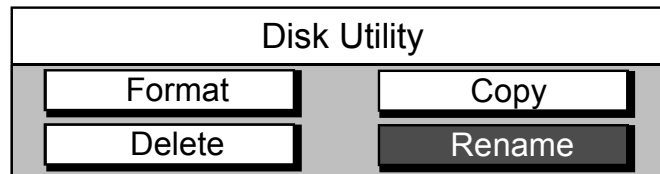

1. Load the disk into the disk drive. Make sure that the disk you have selected has song data files on it.
2. Select the Rename menu, the menu will show the available songs. If there are additional pages the indicator light on the SCREEN RIGHT/LEFT buttons will light.
3. Select the song you want to rename.
4. Use the VALUE buttons or wheel to rename the selected song.
5. Press the ENTER button to save the renamed song to floppy disk. A progress bar will be displayed. When renaming is complete the main disk menu screen will be displayed.

Play Disk - Play displays a directory of the MIDI files found on the

DISK (HP-275e Only)

disk that you can play. It will play the selected MIDI file directly from the floppy disk.

Please note, if you want to permanently edit the song you must load the file into the sequencer.

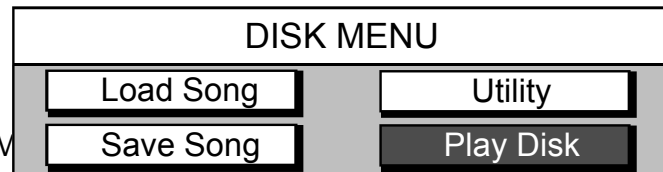

1. M Any standard MIDI file formatted song will be recognized by the piano sequencer.
2. Select the Play Disk menu, a menu of song files contained on the disk will be displayed on the screen. If there is more than one page to the disk, the SCREEN RIGHT/LEFT indicators will be lit. Press them to access additional information.
3. Highlight the song file you would like to play and press the ENTER button. A caution screen will appear asking if you are sure you want to play the song file sequence.
4. "OK" the command. A progress bar will be displayed showing the status. The main disk menu screen will be displayed when your song is ready.
5. Press the PLAY/PAUSE button, the song you have selected will play.

MIDI

MIDI stands for Musical Instrument Digital Interface. This is a world wide standard communication interface that enables electronic musical instruments and computers (of all brands) to communicate with each other so that instructions and other data can pass between them. This exchange of information makes it possible to create a system of MIDI instruments and devices that offers far greater versatility and control than is available with isolated instruments. Whether you interface with computers, sequencers, expanders or other pianos your **Suzuki** piano's technical capabilities, and your musical horizons will be greatly enhanced. For further information on MIDI and MIDI equipment that is available, please contact your local **Suzuki** music store.

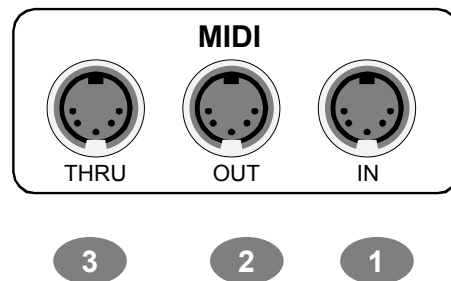

MIDI CONNECTION - The MIDI terminals are located on the back panel of the piano.

1. **MIDI In:** This terminal receives MIDI data from an external MIDI device.
2. **MIDI Out:** This terminal transmits data from this instrument to other MIDI devices. The transmitted data includes the note and touch velocity produced while playing on the piano, as well as voice changes, wheel operation, and recorded playback for the melody tracks. Demo songs and auto accompaniment are not transmitted.
3. **MIDI Thru** - This terminal transfers data from the IN terminal directly to other MIDI devices.

MIDI

MIDI CHANNELS - The MIDI system in this unit has 16 channels numbered from 1-16. Each of the channels is responsible for a voice. When the instrument receives from an external device, the active channel is determined by the control message. The transmission channels on this piano are fixed as follows:

- Channel 1: Master voice
- Channel 2: Layer voice
- Channel 3: Split voice
- Channel 4: Bass in manual bass chord mode
- Channel 7: Chord in manual bass chord mode
- Channel 10: Percussion sound

Please see the MIDI Implementation Chart for more detail.

BASIC MIDI SETUPS

Output to an external sound generator - MIDI pianos transmit note and velocity (touch sensitivity) information via the MIDI Out connector. Connect the MIDI Out terminal of the piano and the MIDI IN terminal of an external device, piano, synthesizer, or sound module, and the external device should respond to your playing.

By connecting this **Suzuki** piano to another piano in this way you can essentially play two instruments at the same time or play on your piano to the sound of another MIDI device to produce thick, layered multi-instrument sounds.

Output from an external MIDI device - Connect the MIDI In terminal of the piano and the MIDI Out terminal of an external device. Data generated on another device can through your pianos sound delivery system.

Connect with a computer - Although the **Suzuki** piano offers a built in sequencer, the music recorder is a real-time five track sequencer, the same type of musical information transfer that is described above can be used for more sophisticated MIDI sequence recording using an external sequencer or computer. These devices could be used to record MIDI data received from this piano. You can transmit your performance to a computer to utilize advanced recording, composing and editing available from software on the computer. MIDI music stored on the computer can be played back through your instrument.

MIDI

MIDI LOCAL CONTROL MODE - Local control refers to the fact that normally, this **Suzuki** piano controls the internal tone generator. This is the normal play mode. Local control can be turned off, so that the piano does not play the internal voices, however, the MIDI information is still transmitted via the MIDI Out connector when notes are played on the piano. At the same time, the internal tone generator can respond to MIDI data received via the MIDI In connector.

MIDI INPUT CHANNEL SELECTION - You may select an individual MIDI channel to receive MIDI data on. The power up default setting is the OMNI mode which receives MIDI data on all channels.

MIDI SPLIT INPUT LOWER CHANNEL MODE - This MIDI input channel mode is used to select which MIDI input channel you want to receive for the lower split piano MIDI data. The previous MIDI input mode will receive the upper split piano data.

MIDI OUTPUT CHANNEL SELECTION - You may select an individual MIDI channel to transmit MIDI data on. The power up default setting to transmit MIDI data is channel 1.

MIDI SPLIT OUTPUT LOWER CHANNEL MODE - This MIDI output channel mode is used to select which MIDI output channel that you want to transmit on for the lower split piano data. This MIDI data can be sent separately on a discrete MIDI channel. The previous MIDI input mode will transmit the upper split piano data. The default setting for this mode transmits on channel two.

MIDI IMPLEMENTATION CHART

Function	Transmitted	Recognized	Remark
Basic Channel	1 CH	1-16 CH	
Channel changed		1-16 CH 1-16 CH	
Default Mode	3	3	
Note Number	9-120	0-127	
Velocity: Note On	●	●	
Velocity: Note Off	X	●	
Pitch Bender	●	●	
Control Change: 0	●	X	Variation page
1	X	X	Modulation
5	X	X	Portamento value
7, 10	●	●	Volume, Pan
11	X	●	Expression
64, 66, 67	●	●	Sustain, Sostenuto, Soft Pedal 65
X X			Portamento yes/no
80, 81	●	●	Reverb, Chorus program
91	●	●	Reverb, Chorus send level
98, 99	X	X	NRPNL, NRPHH
100, 101	X	X	RPNL, RPNH
121	●	●	Reset all controllers
123	●	●	All notes off
Program Change	0-127	0-127	
System Exclusive	X	X	
System Common: Song Select	X	X	
System Common: Song Position	X	X	
System: Clock	X	X	
Real Time: Commands	X	X	











Mode 1: OMNI ON, POLY
 Mode 2: OMNI ON, MONO
 Mode 3: OMNI OFF, POLY
 Mode 4: OMNI OFF, MONO

VOICE LIST

Please note: The MIDI program number for any voice listed is one less than the display number.

	Group A	Group B
Piano		
 <small>PIANO</small>	1 : Grand Piano 3 : Elec. Piano	2 : Bright Piano 4 : Honky Tonk Pno 5 : Rhodes Piano 6 : Chorus Piano 7 : Harpsichord 8 : Clavinet
Chromatic Percussion		
 <small>VIBES</small>	9 : Celesta 11 : Music Box	10 : Glockenspiel 12 : Vibraphone 13 : Marimba 14 : Xylophone 15 : Tubular Bells 16 : Dulcimer
Organ		
 <small>ORGAN</small>	17 : Hammond Organ 19 : Rock Organ	18 : Percuss. Organ 20 : Church Organ 21 : Reed Organ 22 : Accordion 23 : Harmonica 24 : Tango Accdn
Guitar		
 <small>GIUITAR</small>	25 : Nylon Guitar 27 : Jazz Guitar	26 : Steel Guitar 28 : Clean Guitar 29 : Muted Guitar 30 : Overdriven Gtr 31 : Distortion Guitar 32 : Gtr. Harmonics
Bass		
 <small>BASS</small>	33 : Acoustic Bass 35 : Pick Bass	34 : Finger Bass 36 : Fretless Bass 37 : Slap Bass 1 38 : Slap Bass 2 39 : Synth Bass 1 40 : Synth Bass 2
Strings		
 <small>VIOLIN</small>	41 : Violin 43 : Cello	42 : Viola 44 : Contrabass 45 : Tremolo Strings 46 : Pizzicato
Ensemble		
 <small>STRINGS</small>	49 : String Ensmbl1 51 : Synth Strings 1	50 : String Ensmbl2 52 : Synth Strings 2 53 : Choir Aahs 54 : Voice Oohs 55 : Synth Voice 56 : Orchestra Hit
Brass		
 <small>TRUMPET</small>	57 : Trumpet 59 : Tuba	58 : Trombone 60 : Muted Trumpet 61 : French Horn 62 : Brass Section 63 : Synth Brass 1 64 : Synth Brass 2
Reed		
 <small>SAXOPHONE</small>	65 : Soprano Sax 67 : Tenor Sax	66 : Alto Sax 68 : Baritone Sax 69 : Oboe 70 : English Horn 71 : Bassoon 72 : Clarinet
Pipe		
 <small>FLUTE</small>	73 : Piccolo 74 : Flute	77 : Bottle Blow 78 : Shakuhachi
Synth. Lead		
 <small>SYNTH LEAD</small>	81 : Square Lead 82 : Sawtooth Lead	85 : Charang Lead 86 : Voice Lead
Synth. Pad		
 <small>SYNTH</small>	89 : New Age Pad 90 : Warm Pad	93 : Bowed Pad 94 : Metallic Pad
Synth. Effects		
 <small>SYNTH FX</small>	97 : Rain 98 : Sound Track	01 : Brightness 102 : Goblins
Ethnic		
 <small>BANJO</small>	105 : Sitar 106 : Banjo	09 : Kalimba 110 : Bagpipe
Percussion		
 <small>STL.DRUM</small>	113 : Tinkle Bell 114 : Agogo	117 : Taiko Drum 118 : Melodic Tom
Sound Effects		
 <small>SOUND FX</small>	121 : Gtr. Fret Noise 123 : Seashore	122 : Breath Noise 124 : Bird Tweet 125 : Phone Ring 126 : Helicopter 127 : Applause 128 : Gunshot

STYLE LIST

	Group A	Group B	
R & B			
 <i>R & B</i>	1 : R & B 3 : Dance	2 : Rap 4 : Funk	
Big Band			
 <i>BIG BAND</i>	5 : Big Band 7 : Jazz Waltz 1	6 : Jazz Band 8 : Jazz Waltz 2	
Swing			
 <i>SWING</i>	9 : Swing 11 : Jazz 1	10 : Swing Band 12 : Jazz 2	13 : Blues 1 14 : Blues 2
S. Ballad			
 <i>S. BALLAD</i>	15 : Ballad 1 17 : Slow Rock	16 : Ballad 2 18 : 8 Beat 1	19 : 8 Beat 2 20 : 8 Beat 3
Rhumba			
 <i>RHUMBA</i>	21 : Rhumba Tyme 23 : Cha Cha	22 : Rhumba 24 : Cha Cha Twist	25 : Mambo
Acoustic			
 <i>ACOUSTIC</i>	26 : March 28 : Gospel 1	27 : Calypso 29 : Gospel 2	30 : Polka
Pop			
 <i>POP</i>	31 : Pop 33 : Dance	32 : Disco 34 : Dance Pop	35 : 16 Beat
Oldies			
 <i>OLDIES</i>	36 : Jive Band 38 : Waltz	37 : Boogie 39 : Fox Trot	40 : Tango
Rock			
 <i>ROCK</i>	41 : Rock 43 : Shuffle Rock	42 : Shuffle 44 : Country 1	45 : Country 2
Latin			
 <i>LATIN</i>	46 : Bossa Nova 48 : Samba	47 : Bossa Nueva 49 : Salsa	50 : Reggae

DRUM KIT LIST

DRUM KIT LIST 1

Please note: In the first title row the number in the bracket, after the kit name, is the MIDI program number. The Drum kits name and number that are shown on the LCD display are listed in the second title row. The "No." refers to MIDI note number, and "Key" refers to the key on the piano. A blank space in the table mean there is no sound there. Keys from A0 to D1 sound as timpani, except for in Kit 9, the effects kit. Keys from E6 to C8 sound the same as the D#1 to B6 keys.

No.-Key	Standard (0) P-1: Standard	Room (8) P-2: Room	Power (16) P-3: Power	Electronic (24) P-4: Electronic	TR-808 (25) P-5: TR-808
27-E ^b 1	High Q	High Q	High Q	High Q	High Q
28-E1	Slap	Slap	Slap	Slap	Slap
29-F1	Scratch Push	Scratch Push	Scratch Push	Scratch Push	Scratch Push
30-F#1	Scratch Pull	Scratch Pull	Scratch Pull	Scratch Pull	Scratch Pull
31-G1	Stick	Stick	Stick	Stick	Stick
32-G#1	Square Click	Square Click	Square Click	Square Click	Square Click
33-A1	Metronome Click	Metronome Click	Metronome Click	Metronome Click	Metronome Click
34-B ^b 1	Metronome Bell	Metronome Bell	Metronome Bell	Metronome Bell	Metronome Bell
35-B1	Kick Drum 2	Kick Drum 2	Kick Drum 2	Kick Drum 2	Kick Drum 2
36-C2	Kick Drum 1	Kick Drum 1	Power Kick Drum	Elec Kick Drum	Synth Kick Drum 1
37-C#2	Side Stick	Side Stick	Side Stick	Side Stick	Synth Side Stick
38-D2	Snare Drum 2	Snare Drum 2	Power Snare Drum 2	Elec Snare Drum 2	Synth Snare Drum
39-E ^b 2	Hand Clap	Hand Clap	Hand Clap	Hand Clap	Hand Clap
40-E2	Snare Drum 1	Snare Drum 1	Power Snare Drum 1	Power Snare Drum 1	Snare Drum 1
41-F2	Low Floor Tom 2	Room Low Floor Tom 2	Low Floor Tom 2	Elec Low Floor Tom 2	Synth Low Floor Tom 2
42-F#2	Close Hi-hat	Close Hi-hat	Close Hi-hat	Close Hi-hat	Synth Close Hi-hat
43-G2	Low Floor Tom 1	Room Low Floor Tom 1	Low Floor Tom 1	Elec Low Floor Tom 1	Synth Low Floor Tom 1
44-G#2	Pedal Hi-hat	Pedal Hi-hat	Pedal Hi-hat	Pedal Hi-hat	Synth Pedal Hi-hat
45-A2	Low Tom	Room Low Tom	Low Tom	Elec Low Tom	Synth Low Tom
46-B ^b 2	Open Hi-hat	Open Hi-hat	Open Hi-hat	Open Hi-hat	Synth Open Hi-hat
47-B2	Low-mid Tom	Room Low-mid Tom	Low-mid Tom	Elec Low-mid Tom	Synth Low-mid Tom
48-C3	Hi-mid Tom	Room Hi-mid Tom	Hi-mid Tom	Elec Hi-mid Tom	Synth Hi-mid Tom
49-C#3	Crash Cymbal 1	Crash Cymbal 1	Crash Cymbal 1	Crash Cymbal 1	Synth Crash Cymbal 1
50-D3	High Tom	Room High Tom	High Tom	Elec High Tom	Synth High Tom
51-E ^b 3	Ride Cymbal 1	Ride Cymbal 1	Ride Cymbal 1	Ride Cymbal 1	Ride Cymbal 1
52-E3	Chinese Cymbal	Chinese Cymbal	Chinese Cymbal	Reverse Cymbal	Chinese Cymbal
53-F3	Ride Bell	Ride Bell	Ride Bell	Ride Bell	Ride Bell
54-F#3	Tambourine	Tambourine	Tambourine	Tambourine	Tambourine
55-G3	Splash Cymbal	Splash Cymbal	Splash Cymbal	Splash Cymbal	Splash Cymbal
56-G#3	Cowbell	Cowbell	Cowbell	Cowbell	Cowbell
57-A3	Crash Cymbal 2	Crash Cymbal 2	Crash Cymbal 2	Crash Cymbal 2	Crash Cymbal 2
58-B ^b 3	Vibra Slap	Vibra Slap	Vibra Slap	Vibra Slap	Vibra Slap
59-B3	Ride Cymbal 2	Ride Cymbal 2	Ride Cymbal 2	Ride Cymbal 2	Ride Cymbal 2
60-C4	Hi Bongo	Hi Bongo	Hi Bongo	Hi Bongo	Hi Bongo
61-C#4	Low Bongo	Low Bongo	Low Bongo	Low Bongo	Low Bongo
62-D4	Mute Conga	Mute Conga	Mute Conga	Mute Conga	Mute Conga
63-E ^b 4	Hi Conga	Hi Conga	Hi Conga	Hi Conga	Hi Conga
64-E4	Low Conga	Low Conga	Low Conga	Low Conga	Low Conga
65-F4	High Timbale	High Timbale	High Timbale	High Timbale	High Timbale
66-F#4	Low Timbale	Low Timbale	Low Timbale	Low Timbale	Low Timbale
67-G4	High Agogo	High Agogo	High Agogo	High Agogo	High Agogo
68-G#4	Low Agogo	Low Agogo	Low Agogo	Low Agogo	Low Agogo
69-A4	Cabasa	Cabasa	Cabasa	Cabasa	Cabasa
70-B ^b 4	Maracas	Maracas	Maracas	Maracas	Maracas
71-B4	Short Whistle	Short Whistle	Short Whistle	Short Whistle	Short Whistle
72-C5	Long Whistle	Long Whistle	Long Whistle	Long Whistle	Long Whistle
73-C#5	Short Guiro	Short Guiro	Short Guiro	Short Guiro	Short Guiro
74-D5	Long Guiro	Long Guiro	Long Guiro	Long Guiro	Long Guiro
75-E ^b 5	Claves	Claves	Claves	Claves	Claves
76-E5	Hi Wood Block	Hi Wood Block	Hi Wood Block	Hi Wood Block	Hi Wood Block
77-F5	Low Wood Block	Low Wood Block	Low Wood Block	Low Wood Block	Low Wood Block
78-F#5	Mute Cuica	Mute Cuica	Mute Cuica	Mute Cuica	Mute Cuica
79-G5	Open Cuica	Open Cuica	Open Cuica	Open Cuica	Open Cuica
80-G#5	Mute Triangle	Mute Triangle	Mute Triangle	Mute Triangle	Mute Triangle
81-A5	Open Triangle	Open Triangle	Open Triangle	Open Triangle	Open Triangle
82-B ^b 5	Cabasa	Cabasa	Cabasa	Cabasa	Cabasa
83-B5	Shaker	Shaker	Shaker	Shaker	Shaker
84-C6	Belltree	Belltree	Belltree	Belltree	Belltree
85-C#6	Castanets	Castanets	Castanets	Castanets	Castanets
86-D6	Mute Surdo	Mute Surdo	Mute Surdo	Mute Surdo	Mute Surdo
87-E ^b 6	Open Surdo	Open Surdo	Open Surdo	Open Surdo	Open Surdo

DRUM KIT LIST

DRUM KIT LIST 2

Please note: In the first title row the number in the bracket, after the kit name, is the MIDI program number. The Drum kits name and number that are shown on the LCD display are listed in the second title row. The "No." refers to MIDI note number, and "Key" refers to the key on the piano. A blank space in the table mean there is no sound there. Keys from A0 to D1 sound as timpani, except for in Kit 9, the effects kit. Keys from E6 to C8 sound the same as the D#1 to B6 keys.

No.-Key	Jazz (32) P-6: Jazz	Brush (40) P-7: Brush	Orchestra (48) P-8: Orchestra	Effects (56) P-10: SFX
27-E ^b 1	High Q	High Q	High Q	
28-E1	Slap	Slap	Slap	
29-F1	Scratch Push	Scratch Push	Scratch Push	
30-F#1	Scratch Pull	Scratch Pull	Scratch Pull	
31-G1	Stick	Stick	Stick	
32-G#1	Square Click	Square Click	Square Click	
33-A1	Metronome Click	Metronome Click	Metronome Click	
34-B ^b 1	Metronome Bell	Metronome Bell	Metronome Bell	
35-B1	Jazz Bass Drum	Jazz Bass Drum	Orche Bass Drum 2	
36-C2	70 Bass Drum 1	70 Bass Drum	Orche Bass Drum 1	
37-C#2	Side Stick	Side Stick	Side Stick	
38-D2	Snare Drum 2	Brush Tap	Orche Snare Drum 2	
39-E ^b 2	Hand Clap	Brush Slap	Hand Clap	High-Q
40-E2	Snare Drum 1	Brush Swirl	Orche Snare Drum 1	Slap
41-F2	Low Floor Tom 2	Low Floor Tom 2	Timpani F	Scratch Push
42-F#2	Close Hi-hat	Close Hi-hat	Timpani F#	Scratch Pull
43-G2	Low Floor Tom 1	Low Floor Tom 1	Timpani G	Stick
44-G#2	Pedal Hi-hat	Pedal Hi-hat	Timpani G#	Square Click
45-A2	Low Tom	Low Tom	Timpani A	Metronome Click
46-B ^b 2	Open Hi-hat	Open Hi-hat	Timpani A#	Metronome Bell
47-B2	Low-mid Tom	Low-mid Tom	Timpani B	Gr. Cut Noise1 (down)
48-C3	Hi-mid Tom	Hi-mid Tom	Timpani C	Gr. Cut Noise2 (up)
49-C#3	Crash Cymbal 1	Crash Cymbal 1	Timpani C#	Bass Slap
50-D3	High Tom	High Tom	Timpani D	Bass Pick
51-E ^b 3	Ride Cymbal 1	Ride Cymbal 1	Timpani D#	Key Click
52-E3	Chinese Cymbal	Chinese Cymbal	Timpani E	Laughing
53-F3	Ride Bell	Ride Bell	Timpani F	Screaming
54-F#3	Tambourine	Tambourine	Tambourine	Punch
55-G3	Splash Cymbal	Splash Cymbal	Splash Cymbal	Heart Beat
56-G#3	Cowbell	Cowbell	Cowbell	Footstep 1
57-A3	Crash Cymbal 2	Crash Cymbal 2	Orche Crash Cymbal	Footstep 2
58-B ^b 3	Vibra Slap	Vibra Slap	Vibra Slap	Applause
59-B3	Ride Cymbal 2	Ride Cymbal 2	Orche Cymbal	Door Creaking
60-C4	Hi Bongo	Hi Bongo	Hi Bongo	Door Closing
61-C#4	Low Bongo	Low Bongo	Low Bongo	Scratch
62-D4	Mute Conga	Mute Conga	Mute Conga	Wind Chime
63-E ^b 4	Hi Conga	Hi Conga	Hi Conga	Car Engine Starting
64-E4	Low Conga	Low Conga	Low Conga	Car Crash
65-F4	High Timbale	High Timbale	High Timbale	Car Pass
66-F#4	Low Timbale	Low Timbale	Low Timbale	Police Siren
67-G4	High Agogo	High Agogo	High Agogo	Train
68-G#4	Low Agogo	Low Agogo	Low Agogo	Jet Plane
69-A4	Cabasa	Cabasa	Cabasa	Helicopter
70-B ^b 4	Maracas	Maracas	Maracas	Starship
71-B4	Short Whistle	Short Whistle	Short Whistle	Gun Shot
72-C5	Long Whistle	Long Whistle	Long Whistle	Laser Gun
73-C#5	Short Guiro	Short Guiro	Short Guiro	Explosion
74-D5	Long Guiro	Long Guiro	Long Guiro	Horse Gallop
75-E ^b 5	Claves	Claves	Claves	Birds
76-E5	Hi Wood Block	Hi Wood Block	Hi Wood Block	Rain
77-F5	Low Wood Block	Low Wood Block	Low Wood Block	Thunder
78-F#5	Mute Cuica	Mute Cuica	Mute Cuica	Wind
79-G5	Open Cuica	Open Cuica	Open Cuica	Sea Shore
80-G#5	Mute Triangle	Mute Triangle	Mute Triangle	Stream
81-A5	Open Triangle	Open Triangle	Open Triangle	Bubble
82-B ^b 5	Cabasa	Cabasa	Cabasa	
83-B5	Shaker	Shaker	Shaker	
84-C6	Belltree	Belltree	Belltree	
85-C#6	Castanets	Castanets	Castanets	
86-D6	Mute Surdo	Mute Surdo	Mute Surdo	
87-E ^b 6	Open Surdo	Open Surdo	Open Surdo	

SPECIFICATIONS

SPECIFICATIONS

PIANO

88-note, hammer-action piano

POLYPHONY: 64

VOICES

128 Voices

16 quick select voice buttons

VOICE MODE

Upper

Layer (dual) voice

Lower (split) voice

AUTO ACCOMPANIMENT STYLE

50 Auto accompaniment styles

ten quick select style buttons

AUTO BASS CHORD MODE

One Finger

Fingered

Piano

Off

CONTROLS

Power: On/Off

Main Volume Control: Min-Max

Bass Level

Treble Level

Microphone Volume Level

Microphone Echo Level

Accomp Volume/Piano Volume Balance

DISPLAY: Graphic Backlit LCD

REGISTRATION MEMORY: 24

DEMONSTRATION: 13 songs plus

55 Lesson songs

RECORDING: Four melody tracks and
one accompaniment track

ACCOMPANIMENT CONTROL

Synchronized Start

Introduction/Ending

Start/Stop

Fill-In

Fill to Variation

Fade

Auto harmony (three types)

SETUP CONTROL

Performance: Velocity, Split point, Transpose, Screen

Hold, Tune, Fixed Level, Fade Time, Octave Shift

Key Mode: Manual Bass, Lower Hold

Harmony: Trio, Duet, Octave

Sustain: Upper, Layer, Lower

Reverb: 8 Reverb settings, Upper, Layer, Lower Levels

Effects: 8 Effects settings, Upper, Layer, Lower Levels

Chord (Accomp Finger Mode): One Finger, Fingered,
Piano, OFF

Pedal Assign: Start/Stop, Fill, Intro/Ending, Lower Hold

Percussion Setup: OFF, 8 Drum Kits, 1 Sound Effect Kit

Metronome Setup: Time Signature, Tempo, Sound, Volume

AUXILIARY JACKS

Headphone x 2

Line Out

Power In

MIDI In/Out

PEDALS

Sustain Pedal

Assignable Function Pedal

Soft Pedal

VOLTAGE: AC 120V

AMPLIFIER: 60W X 60W, 4 speakers

DIMENSIONS

58.5"W X 23.5"D X 34"H

WEIGHT: 235 lbs

STANDARD ACCESSORIES

AC Chord

Owner's manual

OPTIONAL ACCESSORIES

Matching Bench

Headphones

WARRANTY

WARRANTY

This product, except the exterior cosmetic parts, is warranted by the Suzuki Corporation to the original purchaser to be free from defects in material and workmanship under normal use as follows:

- 1. For a period of one year from the date of purchase, the Suzuki Corporation will pay the labor charges to repair the defective product. After this one year period, you must pay all labor charges.**
- 2. In addition, the Suzuki Corporation will supply, at no charge, new or rebuilt replacements for defective parts for a period of one year from the date of purchase.**

In the event repairs are needed, the original purchaser will return the product to an Authorized Suzuki Retail Center with the proof of purchase. The dealer will then repair the product or return it to the Suzuki distribution center in San Diego, California for repairs. Upon completion of the repair, the unit will be returned to the dealer freight prepaid. This warranty will not apply to this product if it has been misused, abused, or altered. This warranty is void if the product has been opened. Without limiting the foregoing, bending, dropping of unit, or visible cracks and/or scratches are presumed to be defects resulting from misuse or abuse.

Neither this warranty nor any other warranty expressed or implied, including implied warranties of merchantable, shall extend beyond the warranty period. No responsibility is assumed for any incidental or consequential damages.

In the United States Contact:

Suzuki Corporation
San Diego Distribution Center
P.O. Box 261030
San Diego, CA 92196

In all other Countries Contact: Original retailer where product was purchased for additional warranty details.

SUZUKI

composer ensemble

HP-275e

HP-175e

OWNER'S MANUAL



P.O. BOX 261030
SAN DIEGO, CALIFORNIA 92196
(858) 566-9710
Visit us on the web at www.suzukipianos.com

Copyright 2003 Suzuki Musical Instrument Corporation

Free Manuals Download Website

<http://myh66.com>

<http://usermanuals.us>

<http://www.somanuals.com>

<http://www.4manuals.cc>

<http://www.manual-lib.com>

<http://www.404manual.com>

<http://www.luxmanual.com>

<http://aubethermostatmanual.com>

Golf course search by state

<http://golfingnear.com>

Email search by domain

<http://emailbydomain.com>

Auto manuals search

<http://auto.somanuals.com>

TV manuals search

<http://tv.somanuals.com>