

HP-275e

Composer Ensemble



Owner's Manual

WELCOME!

We would like to express our appreciation and congratulate you for purchasing this **Suzuki** Composer Ensemble piano. This piano has been designed to provide you with years of musical enjoyment. State of the art electronics are combined with an elegant cabinet that will add beauty and sophistication to any home environment. Just a few of the features your new piano is equipped with include:

- hammer action piano for an authentic acoustic piano feel
- 128 instrument sounds stereo sampled for ultra authentic acoustic realism
- 64 note polyphony - which ensures acoustic piano performance
- a dynamic 6 speaker concert hall sound delivery system with EQ controls
- 100 professional quality orchestrated rhytm accompaniments with variations
- built-in play along songs for your learning and enjoyment
- easy 5 track music recorder for writing songs or to record your lesson progress
- karaoke feature for musical enjoyment, and fun for the entire family
- Floppy Disk Drive to save Performances or Lessons plus play thousands of MIDI songs!!
- complete MIDI controls allows for computer hook up and enables you to update your pianos features so that it never becomes obsolete

You will find many more features and functions listed within this owners manual. In order to fully appreciate all the impressive features of this digital piano, please take a few minutes to read the following pages of instruction. We will cover general precautions, assembly, the function of each control button, and warranty information.



Thank you and congratulations again, for choosing this Mini-Grande Digital Piano from the Suzuki Corporation's piano product line of portable pianos, home digital pianos, home composer ensembles pianos, elegant digital grand ensembles, and the acoustic upright and grand piano line.

SUZUKI

GENERAL PRECAUTIONS

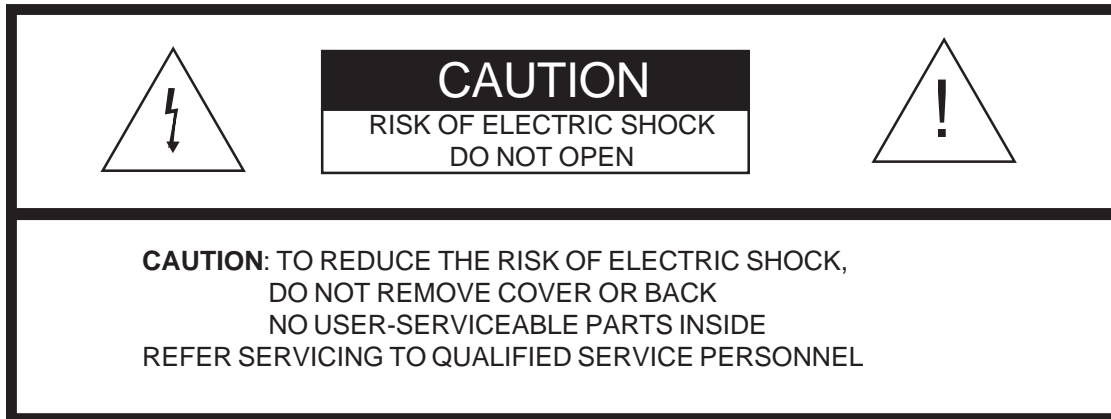

INSTRUCTIONS PERTAINING TO A RISK OF FIRE, ELECTRIC SHOCK OR INJURY:

The lightning flash with arrowhead symbol, within an equilateral triangle, is intended to alert the user to the presence of uninsulated or “dangerous voltage” within the product’s enclosure that may be of sufficient magnitude to constitute a risk of electric shock to persons.

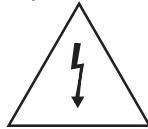

The exclamation point within an equilateral triangle is intended to alert the user to the presence of important operation and maintenance or servicing instructions.



1. **CAUTION:** Any changes or modifications in construction of this device which are not expressly approved by the party responsible for compliance could void the user’s authority to operate the equipment.

2. **NOTE:** This equipment has been tested and found to comply with the limit for a Class A digital device, pursuant to part 15 of the FCC rules. These limits are designed to provide reasonable protection against harmful interference when the equipment is operated in a noncommercial environment. This equipment generates, uses, and can radiate radio frequency energy and if not installed and used in accordance with the instruction manual, may cause harmful interference to radio communications. Operation of this equipment in a residential area is likely to cause harmful interference in which case the user will be required to correct the interference at his own expense.

TAKING CARE OF YOUR DIGITAL PIANO

This Suzuki digital piano will supply you with years of musical enjoyment if you follow the simple rules listed below.

IMPORTANT SAFETY INSTRUCTIONS

WARNING

When using electrical products, basic safety precautions should always be followed, including the following:

SAFETY

Power Source - The product should always be connected to a power supply only of the type described in the operating instructions or as marked on the product.

Periods of Non-use - The power-supply cord of the product should be unplugged from the outlet when left unused for a long period of time.

SERVICE AND MODIFICATION

This product should be serviced by qualified service personnel when,

- the power supply cord or the plug has been damaged,
- liquid has been spattered into the unit or it has been exposed to rain,
- the instrument does not appear to operate normally or exhibits a marked change in performance
- the instrument has been dropped or the cabinet has been damaged.
- Do not attempt to open the piano or make any change in the circuits or parts of the unit.

HANDLING AND TRANSPORT

- Never apply excessive force to the controls, connectors or other parts of the instrument.
- Always unplug cables by gripping the plug firmly, not by pulling on the cable.
- Disconnect all cables before moving the instrument.
- Physical shocks caused by dropping, bumping, or placing heavy objects on the instrument can result in scratches and/or more serious damage.
- Carefully check the amplifier volume control before starting to play. Excessive volume can cause permanent hearing loss.

CLEANING

- Clean the cabinet and panel with a soft nonabrasive dry cloth. This cloth should be for High Gloss Lacquer Finish Furniture. A wax based polish specifically for High Gloss Lacquer Finish Furniture may be used on the cabinet. Do not use paint thinner or petrochemical based polishes.
- To maintain the luster of the keys and buttons wipe with a clean, slightly damp cloth, and then polish with a soft dry cloth.

LOCATION

Do not expose the instrument to the following conditions to avoid deformation, discoloration, or more serious damage:

- direct sunlight (near a window)
- high temperatures (near a heat source, outside, or near a window)
- excessive humidity
- excessive dust
- strong vibration
- Leave enough space around the piano for it to be properly ventilated.
- This instrument contains digital circuitry and may cause interference if placed too close to radio or television receivers. If interference occurs, move the instrument further away from the affected equipment.
- Avoid placing vinyl objects on top of the instrument, vinyl can stick to and discolor the surface.

POWER

- Turn the power switch off when the instrument is not in use.
- To avoid damage to the instrument and other devices to which it is connected, turn the power switches of all related devices off prior to connection or disconnection of MIDI cables.
- Turn the power off if the main cable is damaged or the instrument is spattered with liquid.
- Do not switch the unit on and off in quick succession, this places an undue load on the electronic components.
- Unplug the AC power cord during an electrical storm.
- Avoid plugging the AC power cord into the same AC outlet as appliances with high power consumption, such as electric heaters or refrigerators.

TABLE OF CONTENTS

ASSEMBLY	7
CONNECTOR PANELS	16
PANEL CONTROLS	17
DISK DRIVE	28
PEDALS	29
DISPLAY SCREEN	30
DEMO	31
PIANO VOICES	32
Assigning a Mode	32
Voice Selection	33
Quick Select	34
RHYTHM SECTION	37
Rhythm Style Select	37
Quick Select	38
Starting and Stopping the Rhythm Style	40
Fill-In	41
Fill to Variation	41
Fade	41
Adjusting the Tempo	42
One Touch	42
AUTO ACCOMP. (AUTO BASE CHORD)	43
One Finger	45
Fingered	46
Piano	47
Manual Bass Chord	47
Starting and Stopping the Auto Accomp.	48
Fill-In	49
Fill to Variation	49
Fade	49
SETUP	50
Performance	
Velocity	51
Split Point	51
Transpose	52
Screen Hold	52
Tune	53
Fixed Level	53
Fade Time	54
Octave Shift	54

SETUP continued

Harmony	55
Key Mode	
Manual Bass	56
Lower Hold	56
Sustain	57
Reverb	58
Chord (Auto Accompaniment Fingering)	60
Effects	61
Pedal Assign	63
Percussion (Drum Kit Assign)	64
Metronome	65
REGISTRATION MEMORY	66
RECORD	67
Recording	68
Playback	70
Mark	71
LESSON	72
Song Select	72
Using the Lesson Feature	73
DISK	75
Load Song	76
Save Song	77
Utility	
Format	78
Copy	78
Delete	79
Rename	79
Play Disk	80
MIDI & VIDEO OUTPUT	81
MIDI IMPLEMENTATION CHART	84
VOICE LIST	85
STYLE LIST	86
DRUM KIT LIST 1	87
DRUM KIT LIST 2	88
SPECIFICATIONS	89
WARRANTY	90

ASSEMBLY

1. Unpacking

A. The HP-275e includes 3 boxes; The Piano, The Stand and The Bench. Make sure you have all 3.

Unpacking and assembly should take place on a soft surface such as carpeting or a furniture blanket to protect the fine finish.



B. Open the Stand box first and remove the foam end blocks, accessories and assembly parts.

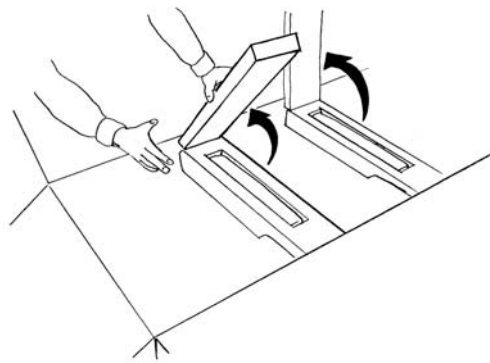

C. The feet for the stand are stored inside the 2 foam blocks in the center of the stand box. Cut the tape and remove them from the foam blocks and set aside.

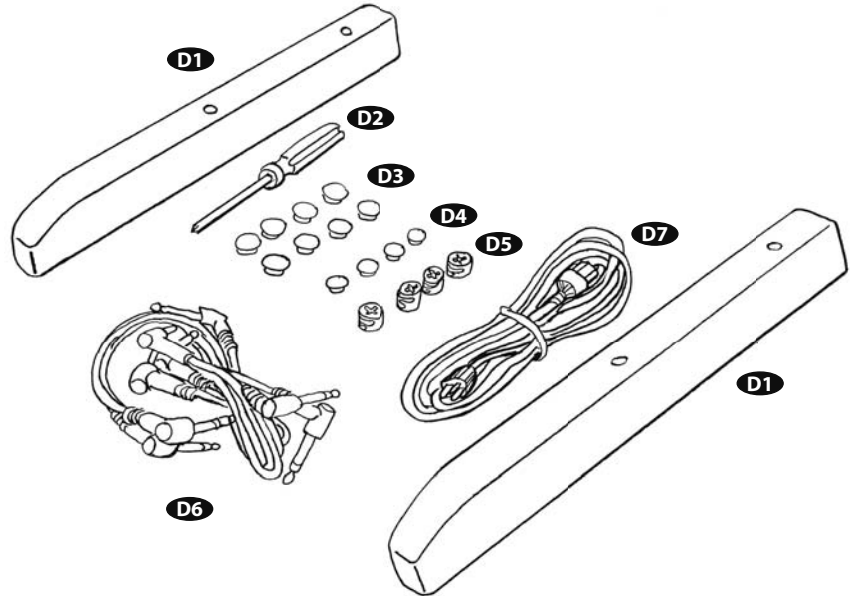

D. Unpack the assembly parts.
You should have:

1. 2 Stand Feet wrapped in protective film
2. 1 Phillips Screwdriver
3. 8 Large cover caps
4. 4 Small covers caps
5. 4 Cam Locks
6. 2 Paired speaker connection wires
7. 1 Power cord
8. 1 Instruction Manual

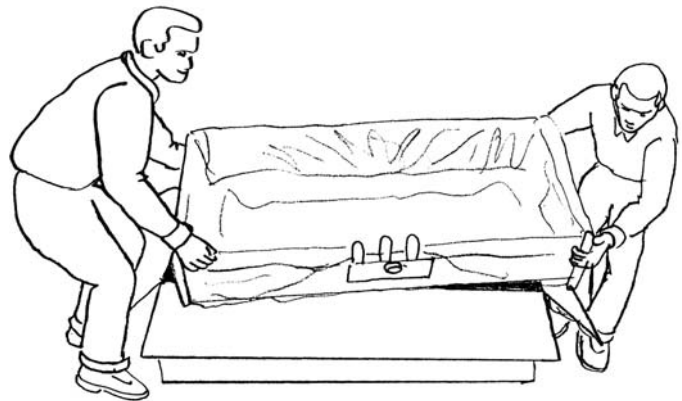

E. Using 2 people, lift the stand out of the box and place it on a soft surface upside down. Remove the protective outer packing materials. Leave the clear, thin protective film in place for now.

2. Stand Assembly

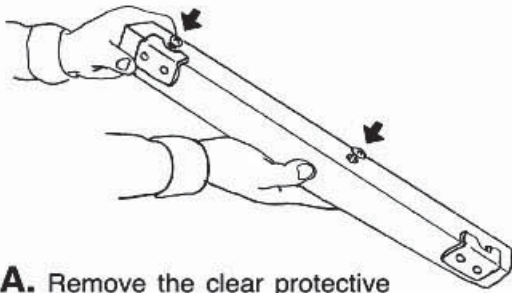

A. Remove the clear protective film from the stand feet. You will notice the attaching hardware is already in place.

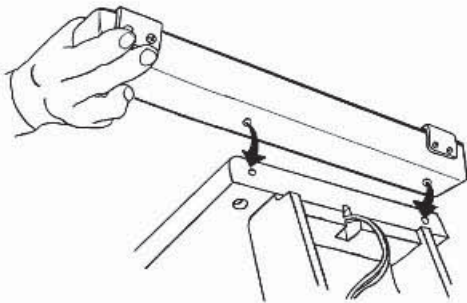

B. Locate the 2 holes in the stand leg bottom. This is where you will thread in the screws that are already in the feet.

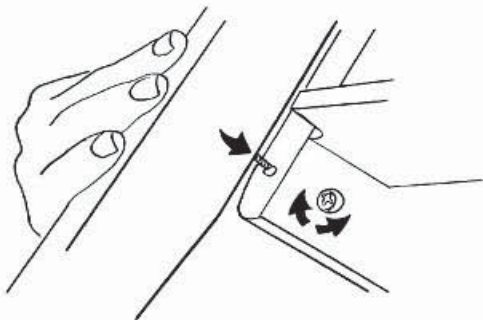

C. Go to the inside of the stand leg and locate the barrel nuts already in their holes. Notice the barrel nut has a Phillips head X in it as well as a large straight slot. Align the straight slot to point to the intersecting hole in the leg bottom. This will align the threads in the barrel nut with the intersecting hole and the feet screws.

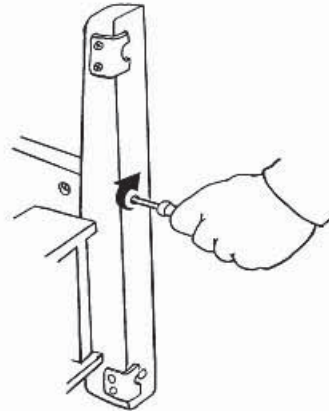

D. Push the screws into the holes in the feet and align them to thread into the stand barrel nuts. Make sure the pads mounted on the bottom of the feet face to the inside of the stand before you tighten the feet screws.

NOTE:

You may have to realign the barrel nuts during the attachment process. Do Not force the screws into the barrel nuts, they should screw in smoothly.

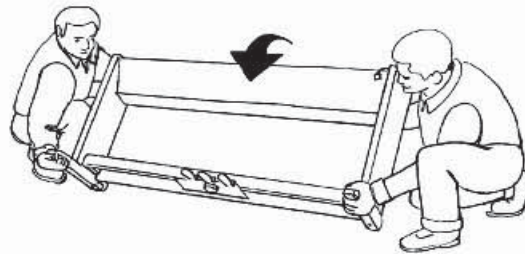

E. Once you have attached the feet, using 2 people turn the stand over and place it on its feet.

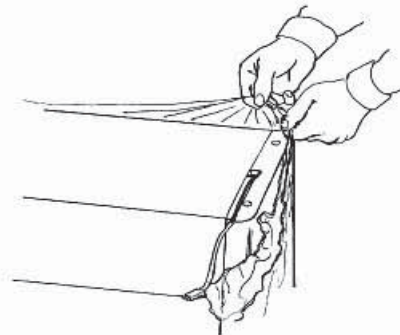

F. Peel the clear protective film away from the attachment surface where the piano will sit.

3. Unpacking the Piano

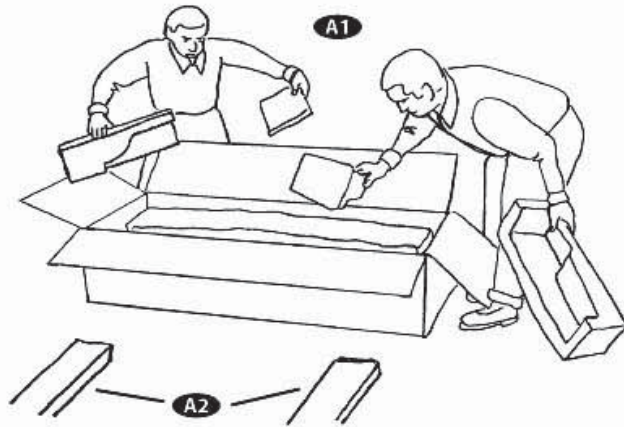

A1. Open the piano carton and remove the foam blocks.

A2. Prior to lifting the piano out of the carton place 2 of the foam packaging blocks where you will place the piano for unwrapping.

NOTE:

The piano has protruding from its bottom 4 small stand attachment rods that may be damaged if the piano is allowed to rest on them.

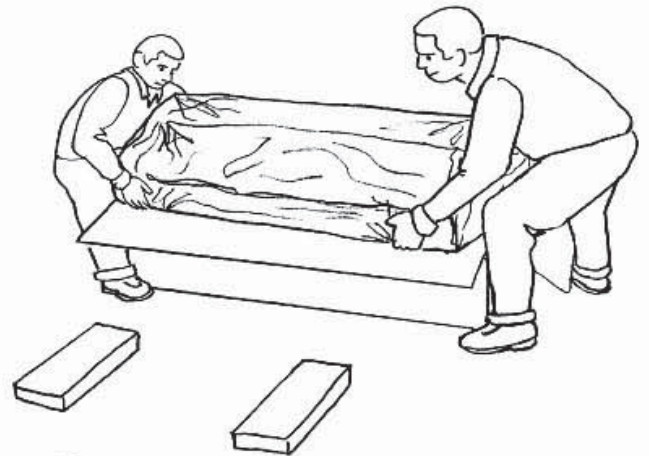
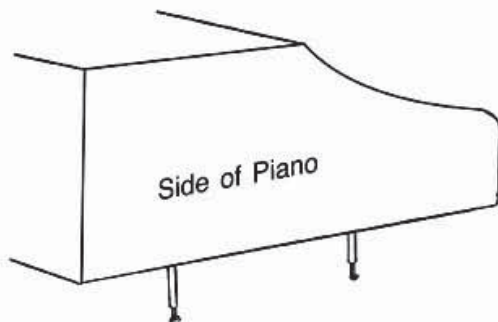

B. Lift the piano out of the box and place it on the foam blocks. This will protect the stand attachment rods. Remove the outer protective packing, leaving the clear protective film and fiberglass tape holding the fallboard in place for now.

NOTE:

The fiberglass tape will hold the fallboard in place while you are moving the piano around. If the tape is removed the fallboard can slam open or closed during movement and damage may occur.

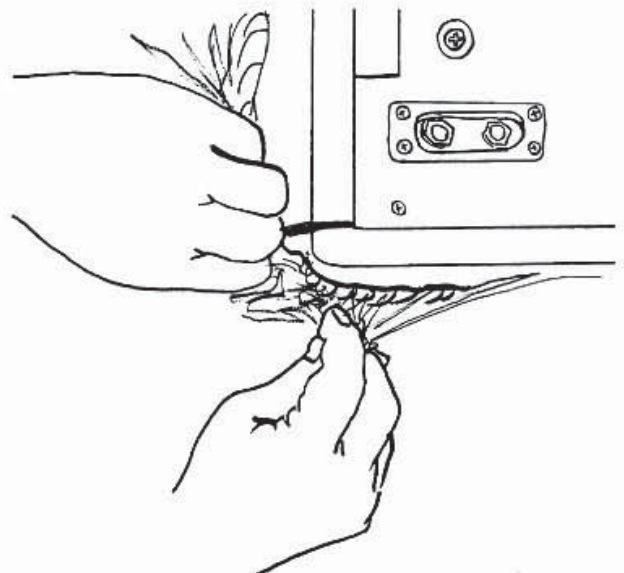

C. Peel the clear protective film away from the attachment surfaces on the piano bottom.

4. Attaching the Piano to the Stand

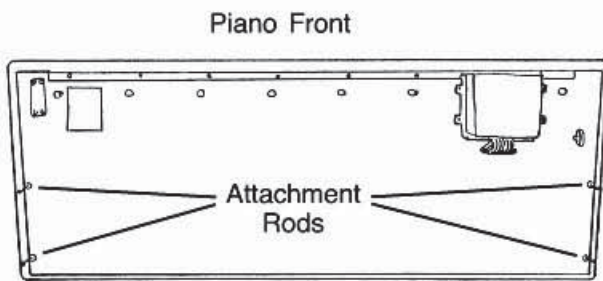

Pictured are the attachment rods on the piano bottom.

A. Locate the 4 cam locks in the assembly hardware.

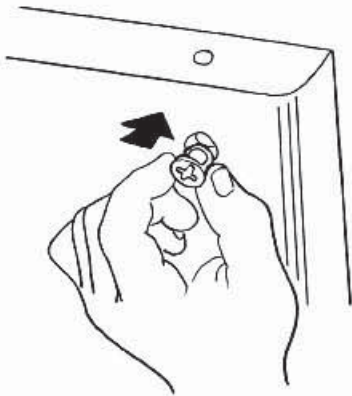

B. On the outside of the stand leg tops, locate the 4 large holes where the cam locks will be inserted.

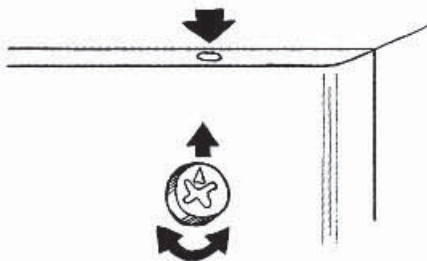

C. The cam locks have a Phillips head X with a small arrowhead. Slide the cam lock into the stand hole with the Phillips head facing out and the arrow pointing up towards the small hole in the top of the stand.

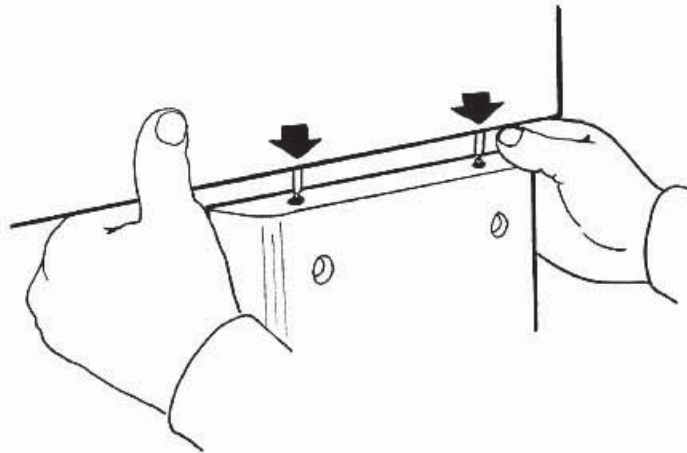

D. Using 2 people, align and slide the piano attachment rods into the holes in the top of the stand and into the cam locks.

NOTE:

The cam locks must be properly aligned to allow the attachment rods to easily slide in. Damage may occur if this alignment is not done correctly. Do Not force the piano rods down into the cam locks. With proper alignment, the piano rods will slide in smoothly. You may have to lift the piano and realign the cam locks.

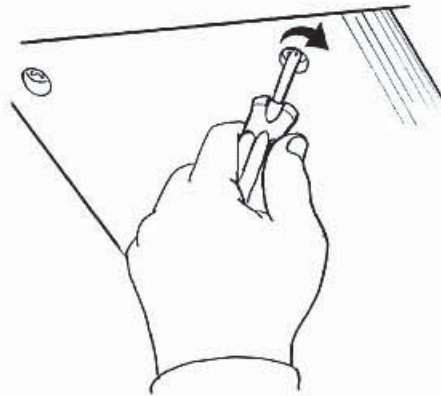

E. With the piano rods seated in the cam locks, rotate the cam locks clockwise 3/4 of a turn.

NOTE:

Do Not over rotate the cam locks. This will not make the connection any tighter and may break the cam lock barrel.

4. Attaching the Piano to the Stand (continued)

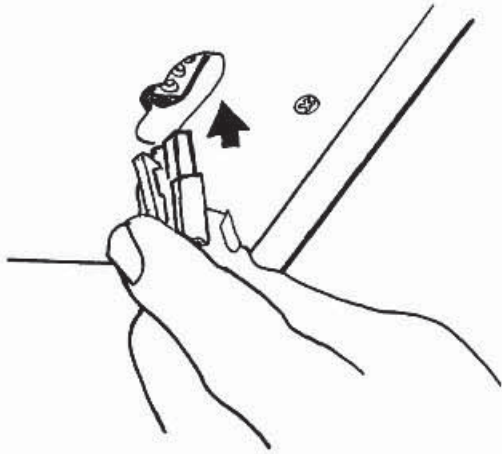

F. Under the right front of the keyboard locate the pedal control plug. It is coming out of the top front of the right stand leg. Plug it into its receptacle on the bottom of the piano.

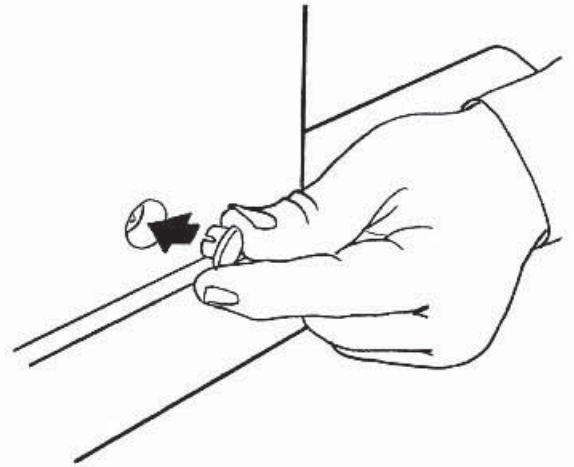

H. Locate the 8 large cover caps and push them into the large barrel nut holes on the outside of the stand legs.

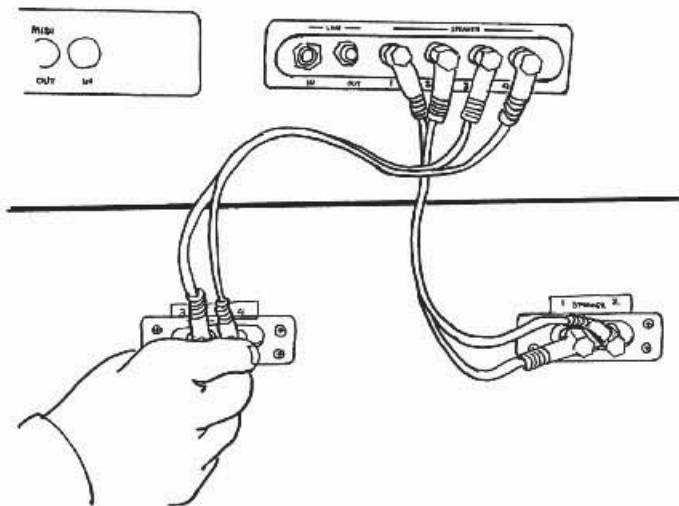

G. Locate the speaker connection cables. They have red and white 1/4" male plugs. On the back of the piano locate the receptacles marked speaker 1 2 3 4 and on the back of the stand locate the 2 dual receptacles marked (3 speaker 4) and (1 speaker 2). Using the connecting cables connect the matching numbers i.e. 1 to 1, 2 to 2, and so on.

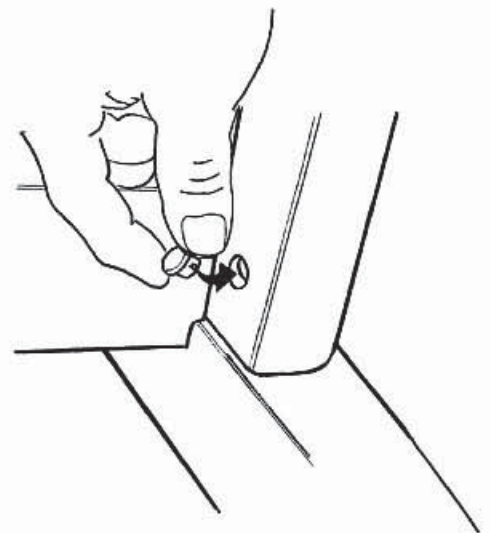

I. Locate the 4 small cover caps and push them into the small barrel nut holes on the inside bottom of the stand legs.

5. Placing Your Piano

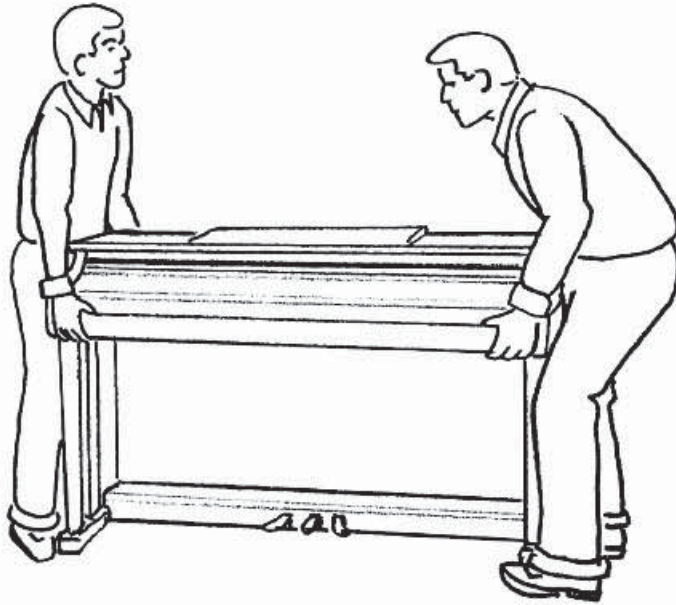

A. Carefully lift and carry your piano to its place in your home.

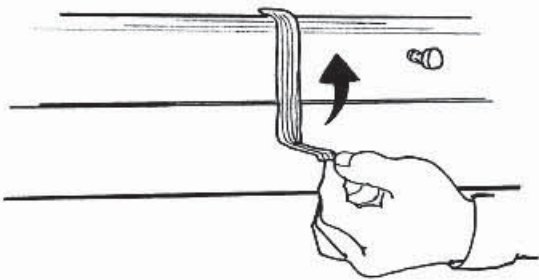

B. After you have placed your piano in your home, now remove all the clear protective film and the fiberglass tape holding the fallboard in place.



C. Plug the power cord into the rear of the piano and into an appropriate wall receptacle.

NOTES

NOTES

NOTES

CONNECTOR PANELS

This connector panel with its various connector jacks are located on the bottom left of the piano.

1. **MIDI OUT / MIDI IN / MIDI THRU** - This piano contains MIDI in, MIDI thru and MIDI output ports. MIDI jacks allow communication with other products equipped with MIDI interfaces. Please see the MIDI section of this manual for further details.

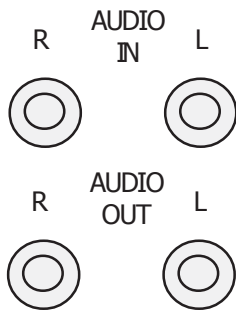
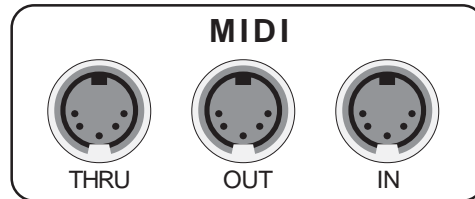

2. **AUDIO IN** - These stereo audio input jacks will amplify the supplied signal through the internal sound delivery system. Could be used to hook up items such as CD players, MP3 player or Cassette player.

3. **AUDIO OUT** - These stereo audio output jacks supplies the piano's output signal to external amplification, such as home stereo, PA system or other stand alone amplifiers.



4. **A/C RECEPTACLE JACK** - The A/C Receptacle Plug is located on the bottom left hand side of the piano. Plug the supplied A/C cord into the A/C Receptacle Jack



5. **PHONE 1 / PHONE 2** - You can play in total silence, without disturbing others in the room, by plugging a set of headphones into one of the appropriate sockets located on the left side of the piano. When headphones are plugged into either of these jacks the main speaker system is turned off. Two sets of headphones may be used simultaneously.

These headphone jacks are located directly under the piano keys on the left side of the piano.

6. **MICROPHONE INPUT** - The Microphone Input is located on the Floppy Disk Drive Assembly, which is located under the upper right hand portion of the piano keys.

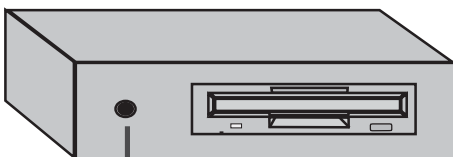

Microphone Jack Input

PANEL CONTROLS

Composer Ensemble
HP-275e

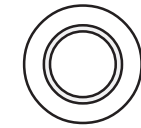

MIN MAX
MASTER VOLUME

1

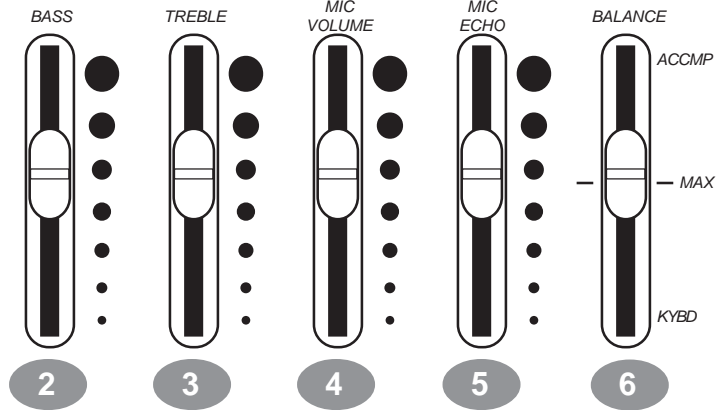

This Suzuki piano's control panel is designed for ease of use and intuitive playing. The following is a brief description of all the features located on the control panel.

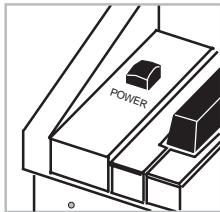

POWER SWITCH - The power switch is located to the left of the piano keys.

Press the button to turn the power on and off. There is an indicator light on the Floppy Disk Drive located on right front portion of the piano. This light will be lit when power is on.

Please note, when you turn the power off, do not turn it back on immediately. Wait at least five seconds to turn the power back on so that the electronic circuits can properly reset.

1. **MASTER VOLUME** - Turn this knob to the right to increase the overall volume of the piano, and to the left to decrease the volume.
2. **BASS** - Slide this controller to adjust the bass level. The midpoint is notched. At this midpoint all EQ controls are "flat." You may want to adjust this control to sound sculpt your personal sound preferences
3. **TREBLE** - Slide this controller to adjust the treble level. The midpoint is notched. At this midpoint all EQ controls are "flat." You may want to adjust this control to sound sculpt your personal sound preferences
4. **MIC (MICROPHONE) VOLUME** - Slide this knob to adjust the volume of the microphone output. Please see the Connector Panels section of this manual for more information on Microphone Input Jack Location.
5. **MIC (MICROPHONE) ECHO** - Slide this controller to adjust the echo or reverb effect on the microphone.
6. **BALANCE** - This sliding control will adjust the piano volume in conjunction with the accompaniment volume. Slide the controller up to increase the accompaniment volume and decrease the selected piano's instrument voice, slide the controller down to increase the selected piano's instrument voice and decrease the accompaniment volume.



NOTE: If this Keyboard Balance sliding knob is placed all the way in the up position then you will not hear any sound when you play the piano keys!

PANEL CONTROLS

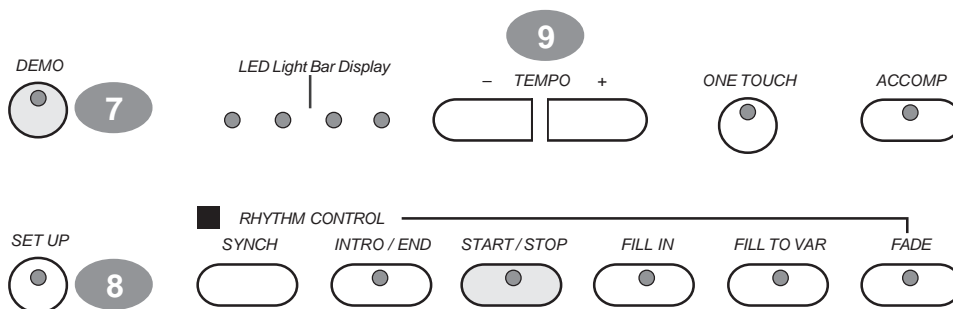

7. **DEMO (DEMONSTRATION SONGS)** - Press the DEMO button. The first demo song will begin to play instantly. This piano has thirteen different demonstration songs designed to showcase the instrument's capabilities. Please see the "Demo" section of this manual for more information.



NOTE: There are also over 50 songs built into this piano to be used as reference for the Lesson exercises that can also be enjoyed. Please see the Lesson section of this manual for more information.

8. **SET UP** - The SET UP button is used to activate the set up menu screen. The majority of this pianos features and functions can be accessed and adjusted from the Set Up screen menu selections. Please see the "Setup" section of this manual for more information.

9. **TEMPO** - Press one of the TEMPO buttons, the current tempo value will appear on the display. You can use the TEMPO +, TEMPO – buttons, or the +/- VALUE buttons to increase or decrease the tempo of Orchestrated Accompaniment Patterns and other Recorded features. The Tempo value range is from 40 to 240 bpm (beats per minute).



NOTE: Press the – TEMPO or + TEMPO buttons or the +/- VALUE buttons simultaneously to recall the default tempo setting for the selected rhythm style.

LED Rhythm light bar display - There is a four-dot beat indicator to the left of the tempo buttons. It indicates the Tempo and beat for the accompaniment that is playing. The lights flash simultaneously on the first beat of each measure, then the indicators flash individually in sequence on the remaining beats.

PANEL CONTROLS

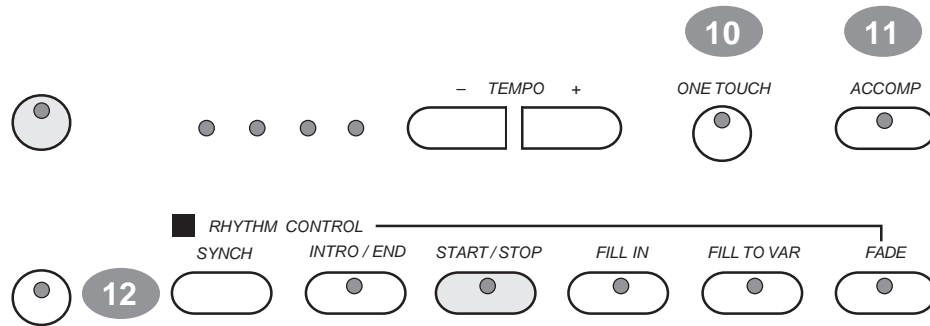

- 10. ONE TOUCH** - This button works in association with your selected Rhythm Style. The ONE TOUCH button will automatically select the predetermined optimum instrument voice settings for the selected rhythm style.
Function: The voice, voice volume, the fingered accompaniment chord, mode, harmony and effects will automatically be engaged or altered when the One Touch button is engaged.
- 11. ACCOMP (AUTOMATIC ACCOMPANIMENT)** - Each of the 70 rhythm styles have an auto accompaniment pattern, often called the auto bass chord. These accompaniments are dedicated to the selected rhythm style, and will create fully orchestrated rhythm, bass and chord accompaniments, based on the chord that you play with your left hand.
Function: The ACCOMP button activates the chord select screen. With the accompaniment function engaged, the keys to the left side of the split point act as the auto accompaniment piano keys, while the keys to the right are available for normal playing. The auto accompaniment fingering modes are single, fingered and piano. Please see the Auto Accompaniment section of this manual for more information.
- 12. SYNC (SYNCHRONIZED START)** - Synchronized Start mode engages the auto accompaniment standby mode. This means that your selected Auto Accompaniment pattern will begin when you press the piano keys to the left of the split point.
Function: Press the SYNC button and the indicator lights beside the tempo buttons will flash to the beat of the selected rhythm style. The rhythm style will start as soon as you play in the auto accompaniment section of the piano. The auto accompaniment will start with the first recognized chord played in the auto accompaniment section of the piano.

PANEL CONTROLS

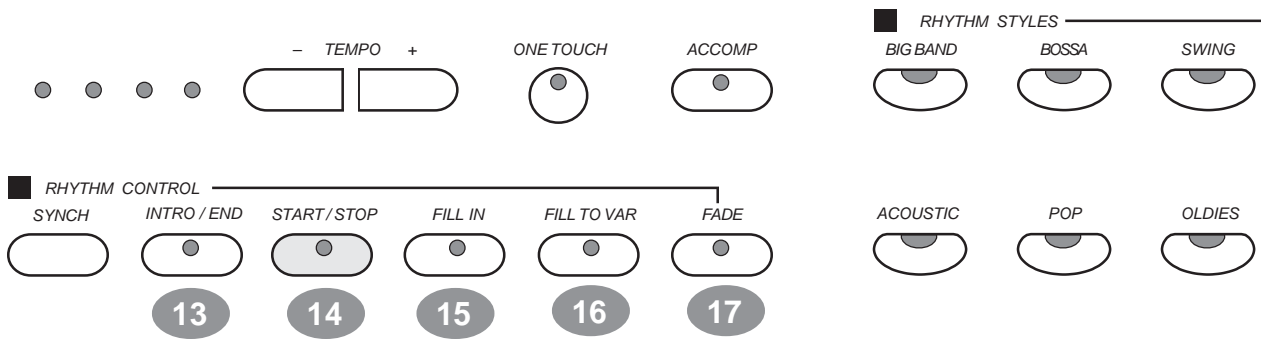

13. INTRO/END (INTRODUCTION/ENDING PATTERN) - All of the 70 rhythm styles can be started with their own introduction.

Function: When the Intro Button is engaged, the Introduction pattern for the selected rhythm Style will start.

This is followed by the main pattern.

Each style also has an ending pattern that can be accessed by pressing this button while the rhythm/accompaniment pattern is engaged.



Note: You can insert a fill-in during the ending pattern to stop the ending and return to the main accompaniment pattern.

14. START/STOP - This button starts and stops the selected rhythm style, the recording in the music recorder, Demonstration Song, Song on Floppy Disk or other prerecorded items.

Function: Press to Start or Stop your selected feature.

15. FILL IN - This function provides the Orchestrated Rhythm Accompaniment with a short rhythm pattern of one or two measures for each style.

Function: Press the FILL IN button at any time while the Accompaniment is playing.



Note: If you hold down the FILL IN button, the fill-in pattern will repeat until the button is released, then the main pattern will play from the beginning of its next measure.

16. FILL TO VAR (VARIATION) - All of the 70 rhythm styles include a variation of that style that can be accessed simply by engaging the FILL TO VAR (Fill To Variation of Engaged Rhythm Style) button.

Function: If the variation button is selected the engaged rhythm style will proceed to the variation of that rhythm pattern.

17. FADE - The FADE button allows the engaged rhythm style/accompaniment pattern to fade from its full volume to its conclusion. When the fade out has finished the LED will flash while the previously set volume levels are being restored.



Note: Pressing the FADE button after it has already been engaged will switch the fade feature off.

The fade in and fade out time is assignable in the Setup Button menu screen under the "performance" title.

PANEL CONTROLS

18

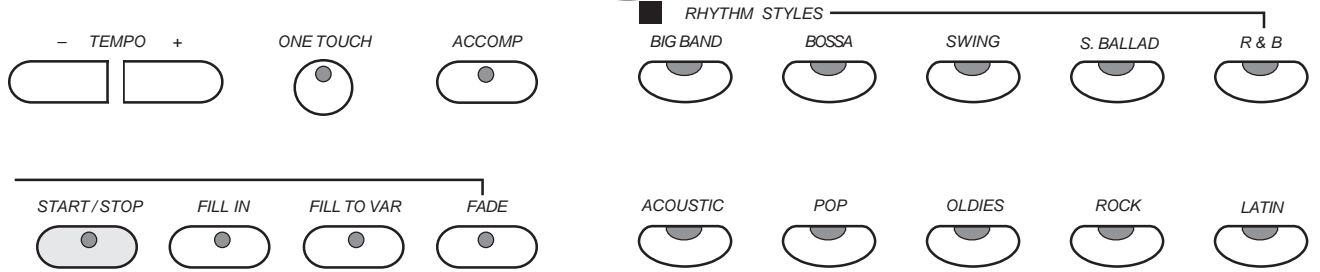

- 18. QUICK SELECT RHYTHM STYLE BUTTONS** - There are a total of 70 Rhythm Style Accompaniments in the HP-275e Piano. There are ten Rhythm Styles that can be selected quickly by pressing one of the ten quick select RHYTHM STYLE buttons. The Rhythm Style Group Name is printed above the style select button. The style name and its number will be shown on the Display LCD when selected.



Note: Pressing the same RHYTHM STYLE button a **Second** time will engage a rhythm style menu screen from which you can pick from the entire list of 70 Rhythm Styles. Each Quick Select Rhythm button can access up to eight related styles. At least four Rhythm Styles will be displayed on the LCD Screen. If there are more than four styles available from the Rhythm Style Button that you selected, then the Screen Right LED indicator will light up. Press the lit Screen Right Button to view all available Styles. Use the Cursor and the Enter Button to select your desired Rhythm Style. Please see the Rhythm Section of this manual for more information.

PANEL CONTROLS

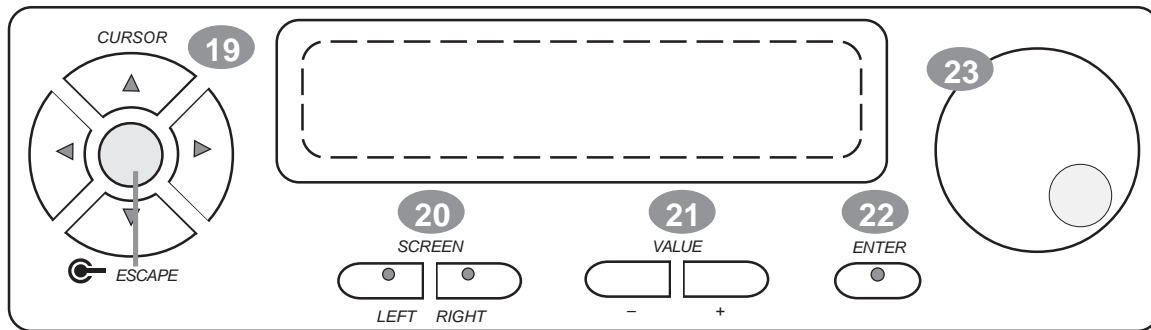

- 19. CURSOR** - The CURSOR button group (right arrow, left arrow, up arrow and down arrow) allows you to access and highlight different areas within the LCD Display screen.
Please note - After your selection has been highlighted Press the Enter button to engage your selected item.

ESCAPE - The ESCAPE button is located in the center of the Cursor Button Group. When this button is pressed it will return the current LCD Display screen to the previous LCD Display screen.
Continue pressing this button to return to the original default performance LCD Display screen.
- 20. SCREEN LEFT, SCREEN RIGHT** - The SCREEN buttons are available for use when there is more information than can be viewed on the LCD Display Screen. If your selected feature or function has additional LCD Display Screen information the Screen Left and/or Screen Right LED buttons will lit up.
Therefore, If an indicator light is on, on either the Screen Left Button or the Screen Right LCD Button then there is additional screen information available for the selected function.
Use the SCREEN LEFT or SCREEN RIGHT buttons to access the additional menu pages that you want to view.
- 21. VALUE** - Use the VALUE + and - buttons to adjust levels on the currently selected feature.
These buttons auto repeat when they are held down, therefore they will continue to cycle upward or downward until the button is released.
Please Note - the default factory setting of the selected parameter can be recalled by pressing down both the VALUE + and - buttons at the same time.
- 22. ENTER** - Use the Enter button to select the highlighted function or feature on the LCD Display Screen of the piano. This will engage your selected highlighted item.
- 23. VALUE WHEEL** - Use the value wheel to change the function parameters or levels of the selected item or it's highlighted feature. It has the same function as the Value + or - buttons.
To increase the value turn the wheel clockwise, to decrease the value turn the wheel counterclockwise.

PANEL CONTROLS

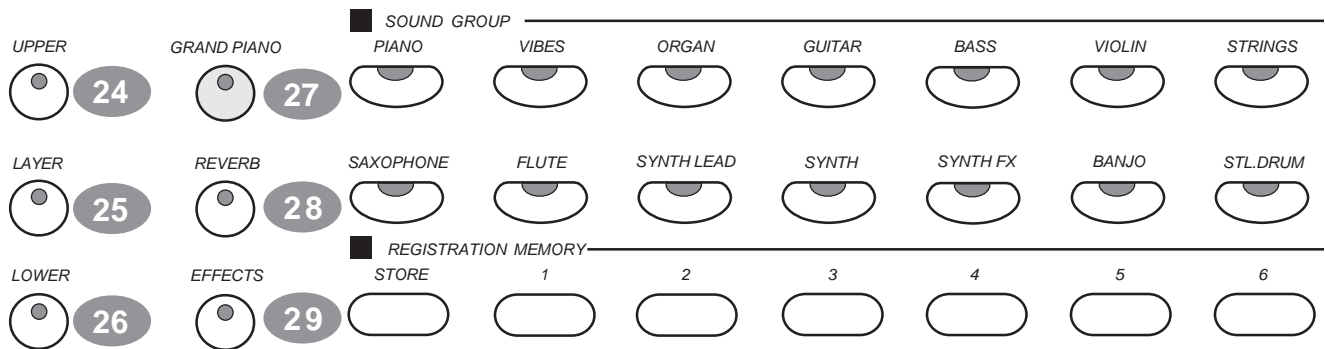

- 24. UPPER** - This is the Main 88 note Instrument Voice Selection Button. This button is used to select the voice for the “Upper Mode” and engages the selected voice for all 88 piano keys. When the Lower Button is engaged the Instrument Voice Selected for the Upper Mode will play on the piano keys to the right of the piano key “Split Point”. Please see the Piano Instrument Voices section of this manual for a listing of the instrument voices available on this piano.
- 25. LAYER** - Engaging the LAYER button will put the piano in the layer, or dual mode. Layer refers to an additional Instrument Voice that is “tone mixed” or “Layered” with the selected Upper Instrument Voice. Please see the “Piano Voices” section of this manual for more information.
- 26. LOWER** - When the LOWER feature is engaged the piano operates in the “Split Mode.” In the split mode the Piano’s 88 Piano Keys are divided into two sections. In the right hand section the “Upper” and (if engaged) the “Layered” Voice is heard. In the left hand section of the 88 Piano Keys the “Lower” function Instrument Voice can be selected to sound when the Lower Piano Keys are played. Please see the Piano Voices section for more information.
- 27. GRAND PIANO** - This button will reset the piano to its default (power up) settings while engaging the Grand Piano voice for all 88 piano keys. **NOTE:** The Grand Piano Button is very useful to quickly escape from any feature and/or functions modes that are currently engaged. Use this button when you want to leave a current setting or to restart a feature or function that didn’t seem to engage properly.
- 28. REVERB** - The reverb effect is engaged automatically when the power is turned on. Reverb simulates the effect of playing in a big room or hall where the sound reverberates off the walls and ceiling. **Function:** *Press the REVERB button once to select or deselect the function. When first engaging the Reverb button the Reverb Type and Depth (amount of Reverb) can be selected from the LCD Menu Screen. Confirm*
- 29. EFFECTS** - The EFFECTS button will add chorus, flanger or delay effects to the selected Instrument Voice. There are eight DSP (Digital Signal Processing) effects available. **Function:** *Press the Effect button once to select or deselect the function. When first engaging the Effect button the Effect Type and Depth (amount of the Effect) can be selected from the LCD Menu Screen. Confirm*

PANEL CONTROLS

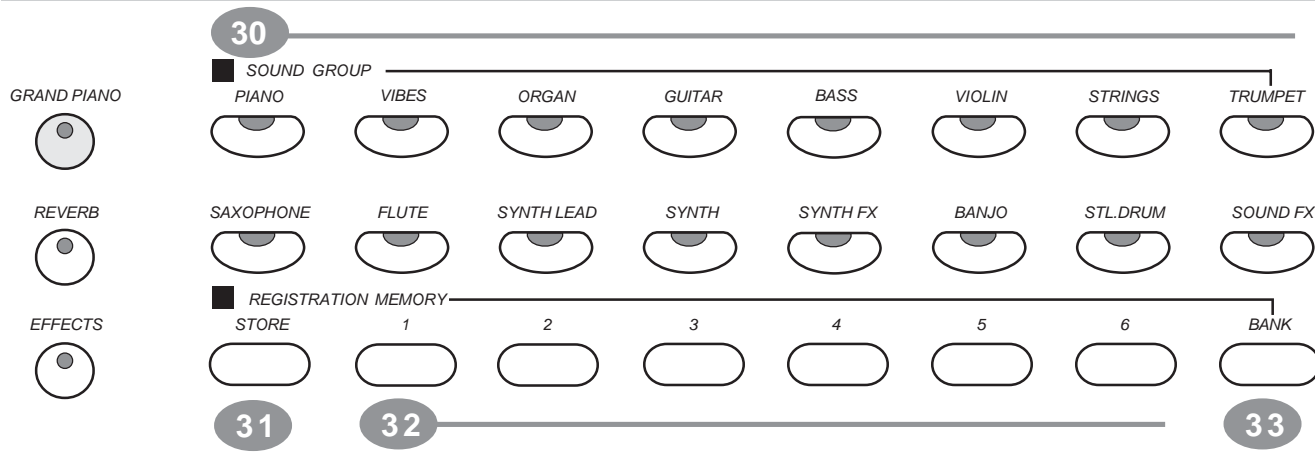

- 30. (QUICK SELECT INSTRUMENT VOICE) SOUND GROUP** - There are sixteen voices that can be selected quickly by pressing one of the Instrument Voice select buttons. The voice name and its number will be shown on the LCD Display Screen.



NOTE: To see the selected Sound Group Instrument Voice menu press the Instrument Voice button twice. Each button accesses a group of eight related voices in two groups of four for a total of 128 GM voices. Please see the Piano Voices section of this manual for more information.

- 31. STORE** - The STORE button engages the registration memory feature. Registration is used to save your current piano settings of rhythm, voice, accompaniment, and other features you have engaged. The piano has four banks with six registrations in each bank for a total of 24 Registration memories locations. Please see the Registration Memory section of the manual for more information.

- 32. REGISTRATION NUMBER BUTTONS** - Use the registration number buttons 1-6 to save or recall a setting in the registration memory. Please see the Registration Memory section of the manual for more information.

- 33. BANK** - There are four registration banks, A, B, C and D. Press the BANK button to cycle through these banks. Please see the Registration Memory section of this manual for more information.

PANEL CONTROLS

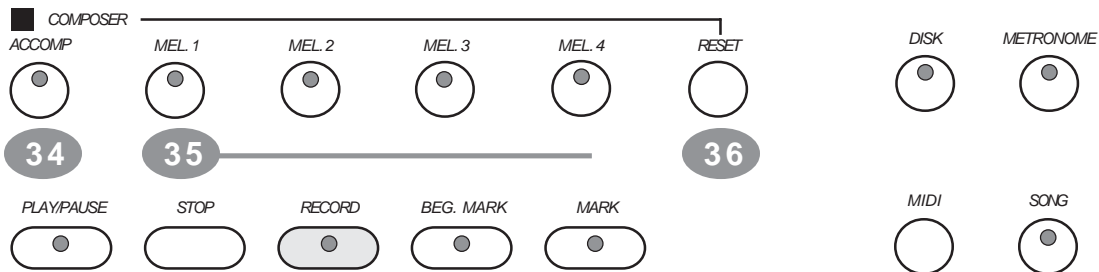

34. **ACCOMP (ACCOMPANIMENT)** - Music Recorder Section - The ACCOMP button is used to record the selected auto Accompaniment Rhythm Style for your music recording session.
See Record Section of the manual for further information.
35. **MEL (MELODY) 1-4** - Music Recorder Section - There are four tracks for recording melody or piano keys to the right side of the Split Point if the Accompaniment Rhythm Style is engaged. These Melody recording tracks will record all 88 piano keys when the Accompaniment is not engaged.
See Record Section of the manual for further information.
36. **RESET** - Music Recorder Section - The RESET button is used to erase a previously recorded track.
Press and hold the Reset Button while you press the Accomp. or Mel. 1-4 Button that you want to erase.
See Record Section of the manual for further information.

PANEL CONTROLS

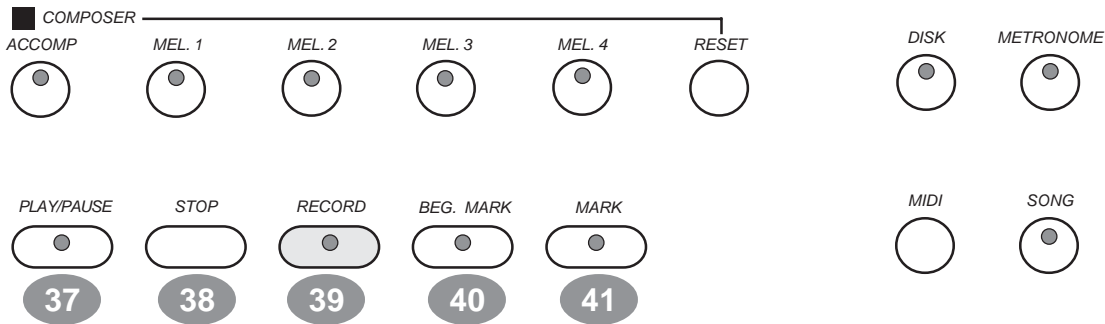

- 37. PLAY/PAUSE** - Press the PLAY/PAUSE button to hear previously recorded tracks. Press the PLAY/PAUSE button again to pause the recording or playback.
See Record Section of the manual for further information.
- 38. STOP** - Press the STOP button to stop the recording or playback.
See Record Section of the manual for further information.
- 39. RECORD** - This Piano contains a 5-track Music Recorder (Sequencer), that allows the user to record their music performances. It can record all **Upper Voice** (not Layer Voice or LowerVoice) note events exactly as they are performed. When the RECORD button is pressed it puts the selected Music Record tracks into the record standby mode. Recording begins as soon as you start to play on any section of the piano.
Please see the Record section of the manual for more information.
-  **NOTE:** Mel. 1-4 Music Recording tracks only record the Upper Instrument Voice notes that are played.
- 40. BEG (BEGIN) MARK** - Use this button to mark the beginning section of a recorded passage that you want to isolate. You can use this feature to isolate part of a recording for listening, correcting or embellishing.
See Record Section of the manual for further information.
- 41. END MARK** - Use this button to mark the end of the recorded section you wish to isolate for listening, correcting or embellishing. .
See Record Section of the manual for further information.

PANEL CONTROLS

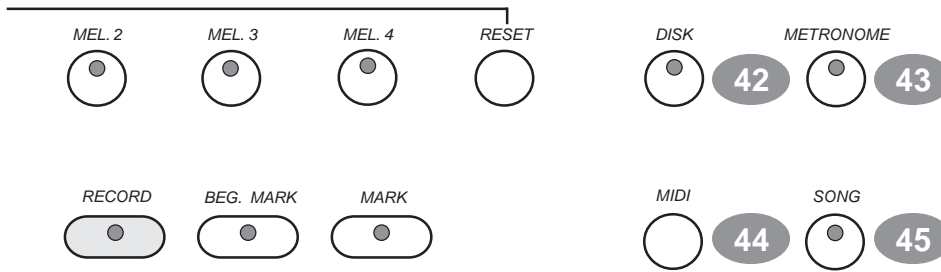

42. **DISK** - The DISK button toggles the disk the LCD Display Screen on and off. Please see the Disk section of this manual for more information.
43. **METRONOME** - The METRONOME button toggles the metronome feature on and off and accesses the Metronome menu. The tempo can be increased or decreased using the TEMPO + and - buttons. Please see the Setup section of this manual for more information.
44. **MIDI** - MIDI is an acronym for Musical Instrument Digital Interface. The MIDI features in this piano are capable of communicating with and/or controlling other MIDI Musical Instruments or MIDI devices such as computers etc... Please see the MIDI section of this manual for more information.
45. **SONG** - Use the SONG button to access the music Lesson program and the Song Select screen. This “music teacher” feature can be used as an aid to learn and play along with the more than 50 songs built into this piano. The SONG button turns the music teacher function on and off. Please see the Lesson section of this manual for more information.

DISK DRIVE

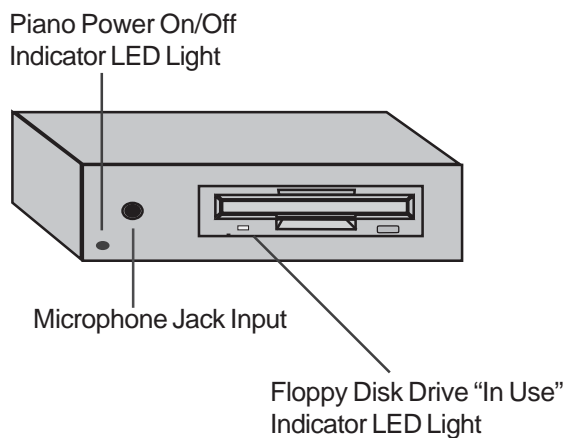

DISK DRIVE - The disk drive is located under the piano keys on the right hand side of the unit. It is used to play a floppy disk. Please see the Disk section of this manual for more information.

PEDALS

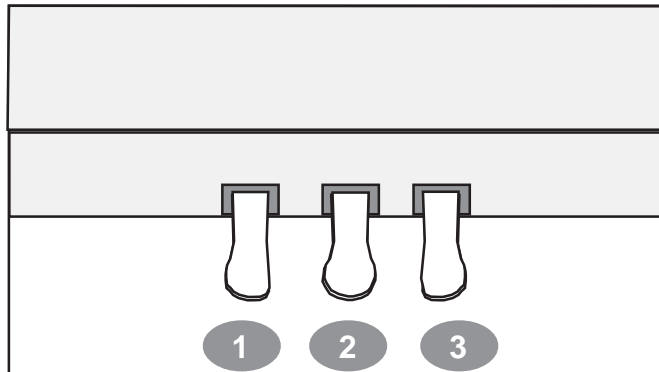

PIANO PEDALS

1. **SOFT PEDAL** - When the left pedal is engaged the piano volume is reduced and the timbre slightly altered on the notes that are played.
2. **FUNCTION PEDAL** - This center pedal can be used to trigger various events, such as start/stop and Fill In. Pedal function is assigned in the setup menu, "Pedal Assign". Please see the Setup section of this manual for more information.
3. **SUSTAIN PEDAL** - When the right pedal is engaged the piano keys will continue to sustain as they are played. Thereby the piano note will decay gradually) as if you were continuing to hold down the piano keys.

DISPLAY SCREEN

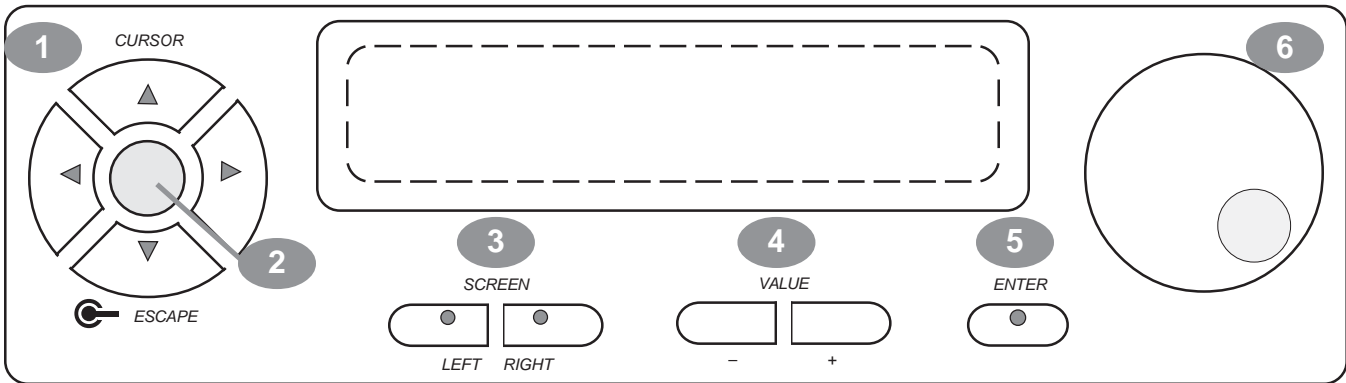

Simple Selecting and Engaging of various Features and Functions:
The Main Performance Menu Screen is shown and explained below.

How to select and engage a Menu Item on the LCD Display Screen:

- Use the CURSOR keys to select Function or Feature that you wish to engage. When this item is selected it will be highlighted.
- Use the Escape Button to go back to the previous Display Screen. The ESCAPE button in the middle of the cursor controls will return the current LCD Display screen to the previous LCD Display screen. Continue pressing the Escape button to return to the initial Menu Screen.
- The Left and Right SCREEN buttons will move the Screen Display to additional Menu Screens within the selected Menu. The Left and Right Screen Button LED indicators will be lit if there is additional Screen Menu information available.
- Use the (+ and -) VALUE buttons to adjust the parameter of the selected Screen Menu item.
- Use the ENTER button to engage a highlighted selection. You must press the Enter Button to engage your selected Feature or Function.
- The VALUE or DATA wheel can be used as an alternative to the VALUE buttons.

MAIN PERFORMANCE SCREEN

The sound channel mode.

UPPER	1 : Grand Piano		
	1 : Big Band		
	NC	A1	♪ = 100

The currently selected Instrument Voice Number and Name. Since this area is highlighted it is selected and available for changes.

The currently selected Style number and name.

Auto Accompaniment: When auto accompaniment is engaged, this area shows the chord that is playing. (NC = no chord)

The current selected tempo.

Registration: The current bank (A) and registration number (1).

DEMOMONSTRATION SONGS

PLAYING THE DEMONSTRATION SONGS - This piano has thirteen different demonstration songs that are designed to showcase the different Instrument Voices that are available on this Mini-Grande Piano. The LCD Screen Display will show the demonstration song name.

All the demonstration songs will play back repeatedly until the Start/Stop or Demo Button is pressed.

In addition there are over 50 Play Along Songs in the Lesson Portion of this piano that can also be listened to for their musical enjoyment. Please see the Lesson section of this manual for more information.

SELECT AND PLAY A DEMO SONG -

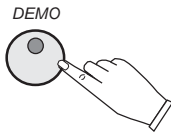

1. Press the DEMO button, the indicator will turn on. The first demo song will playback instantly. The piano will now play all thirteen demonstration songs unless the Start/Stop or Demo Button is pressed..

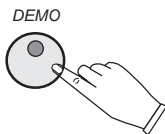
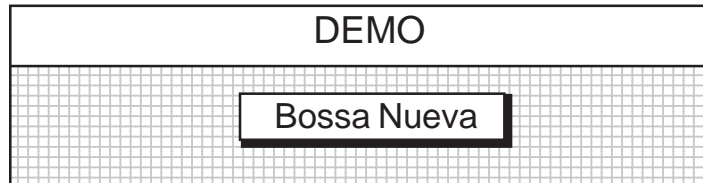

2. Press the DEMO button again to play a specific Demo Song.

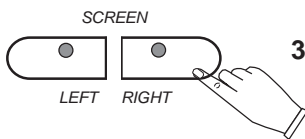
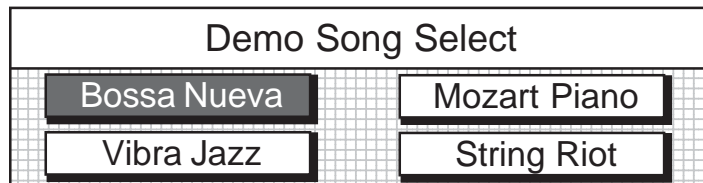

3. Use the SCREEN RIGHT or SCREEN LEFT buttons to access all thirteen Demo Songs within the Demo Song Select menu.

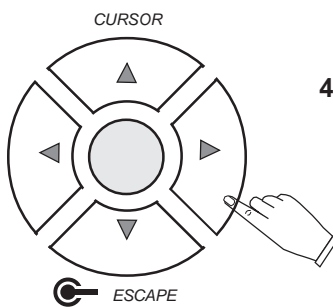
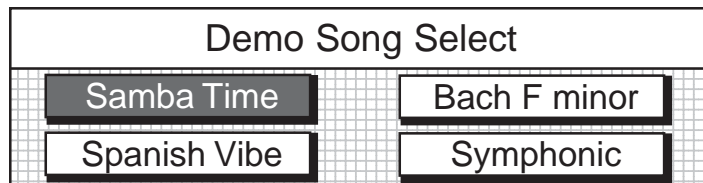

4. Use the CURSOR buttons to move the highlighted area to the song you wish to hear.

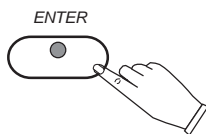
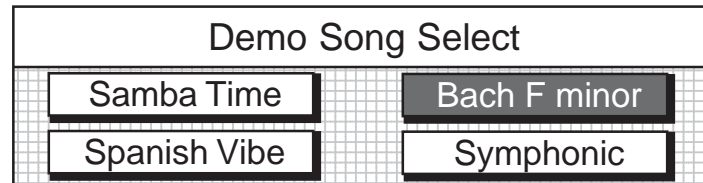

5. Press the ENTER button to confirm your selection. Your selected song will playback instantly. When the song has finished the next Demo Song will begin to play. To Stop press the START/STOP or Demo Button.

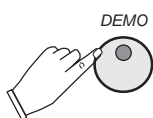
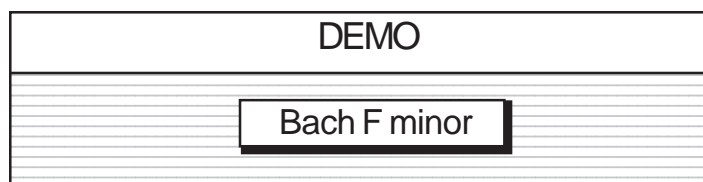

6. Press the DEMO button again to exit the Demonstration Song Mode, the LED Indicator Light will turn off.

PIANO VOICES - SOUND CHANNEL MODES

ASSIGNING DIFFERENT PIANO SOUND CHANNEL MODES -

Depending on your playing style this piano can be set up to play in 4 different Piano Sound Channel Modes: Upper, Layer, Lower and Drum.

UPPER



LAYER



LOWER



CURSOR

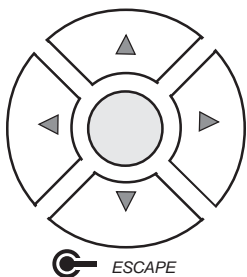

VALUE



SET UP



SET UP



TO SELECT AND ENGAGE ONE OF DIFFERENT SOUND CHANNEL MODES PRESS ONE OF THEIR RESPECTIVE BUTTONS.

UPPER VOICE - Upper is use to select the Upper or MAIN voice of the piano. The upper mode engages the selected piano voice for all of the piano keys.

LAYER (DUAL) VOICE - Layer, or dual, refers to an additional voice that is tone mixed with the selected Upper or Main Instrument Voice. The selected Layer voice will be heard with the Upper voice when the layer feature is engaged.

LOWER VOICE - In the lower, or split, mode the piano is divided into two sections. In the right hand section the selected main voice, or the layer voice will sound. In the left hand section a different voice can be selected to sound when the keys are played.



NOTE: You can change the Instrument Voice selection for each Piano Sound Channel Mode only when it is highlighted on the LCD Display Screen.

To highlight one of the Piano Sound Channel Modes press the respective control panel button.

To Change the Instrument Voice of your selected Piano Sound Channel Highlight the Instrument Voice listed and use the VALUE + and - buttons or the VALUE wheel to access your desired Instrument Voice.

See the Set Up mode section of this manual for further information on setting the Lower Voice Piano Key Split Point
example of LCD Display Screen when the Layer Button is pressed

LAYER	49 : Strings 1		
	1 : Big Band		
	NC	A1	♪ = 100

DRUM (PIANO KEY PERCUSSION) - To engage this feature:

Press the Setup Button once

Press the Screen Right Button Twice

Highlight the Percussion Box on the LCD Display Screen Menu Box.



NOTE: The Piano Key Percussion Mode refers to the Percussion Voices that can be played by the Piano Keys from the eight internal drum kits in this pianos sound library.

There is also a sound effects kit that can be played while the piano is in this mode.

NOTE ALSO: When this Piano Key Drum Percussion Mode is engaged, **the piano keys will only play percussive voices - the piano keys will not play normal piano sounds.** The percussion mode and drum kits are selected in the setup menu "Percussion".

Please see the Setup section of this manual for more information.

PIANO VOICES - VOICE SELECTION

VOICE SELECTION FOR UPPER, LAYER AND LOWER SOUND MODES -

There are 128 GM (General MIDI) Instrument Voices available on this piano.

There is a complete list of all 128 Instrument Voices in the back of the manual.

THERE ARE TWO WAYS TO SELECT AN INSTRUMENT VOICE

- A) Selecting one of the quick Voice Select Buttons as shown on page
- B) Scroll through the Instrument Voices as shown below

SCROLL THROUGH THE INSTRUMENT VOICES

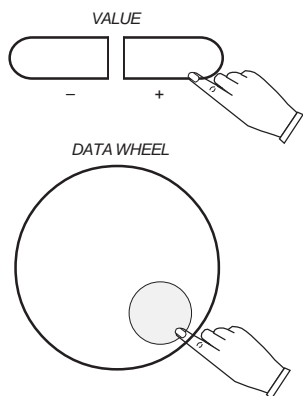

1. Press the VALUE + and - Buttons or the DATA Wheel to cycle through the Instrument Voice Names until you reach the Instrument Voice or Sound Mode that you would like to select. After pressing the enter button highlighted selection will be engaged. For our example we selected Church Organ Voice number 20.

UPPER	20 : Church Organ		
	1 : Big Band		
	NC	A1	♪ = 100



NOTE: To select a different Sound Channel Mode, (LAYER or LOWER). Press their respective control panel button.

If you want the UPPER Sound Channel and it is already selected do not press this button a second time, simply change the Instrument Voice as shown above.

PIANO VOICES - QUICK SELECTION

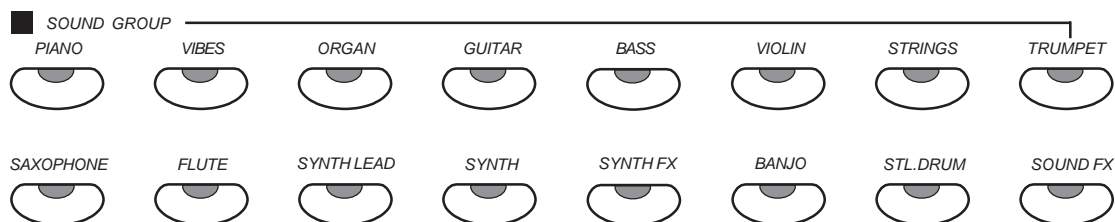

Quick Select Sound Group Buttons Shown Above.

To select an Instrument Voice for your Piano follow the easy steps shown below:

QUICK SELECT -

For all 88 Key voice selections (Upper Mode)

There are 16 voices that can be selected quickly by pressing one of the 16 quick select SOUND GROUP buttons.

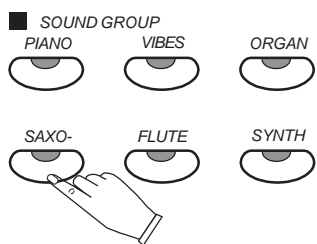

1. Select one of the 16 Quick Select Instrument Voice Buttons. The Instrument Voice Button indicator LED will light and the LCD Display Screen will show the selected Instrument Voice number and its name will be highlighted.
In our example we have selected the Saxophone Voice.

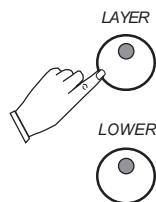

For the Layer and Lower Sound Mode Sections of the Piano

1. Select the Sound Mode Button LAYER or LOWER, for the Instrument Voice that you want to change. The Button's LED will turn on and the LCD Display will show the selected Sound Mode and its currently selected instrument voice.
In our example we have selected the Layer Sound Channel Mode

LAYER	1 : Grand Piano		
	1 : Big Band		
	NC	A1	♪ = 100

2. Select one of the 16 Quick Select Instrument Voice Buttons. The Instrument Voice Button indicator LED will light and the LCD Display Screen will show the selected Instrument Voice number and its name will be highlighted.
In our example above we have selected the Saxophone Voice.

LAYER	65 : Soprano Sax		
	1 : Big Band		
	NC	A1	♪ = 100

PIANO VOICES - SELECTING ALL VOICES

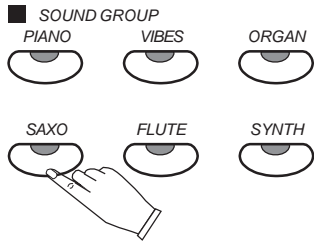

SELECTING ONE OF THE 128 VOICES

1. Press a quick select SOUND GROUP buttons twice, to engage an Instrument Voice selection menu on the display screen.
NOTE: Each Sound Group button is assigned eight related voices in two groups of four.

Reed		Group A	
Soprano Sax		Alto Sax	
Tenor Sax		Baritone Sax	

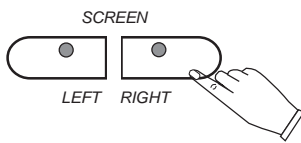

2. Press the SCREEN RIGHT or SCREEN LEFT buttons to “page” through all the voice groups that the piano offers.

Reed		Group B	
Oboe		English Horn	
Bassoon		Clarinet	

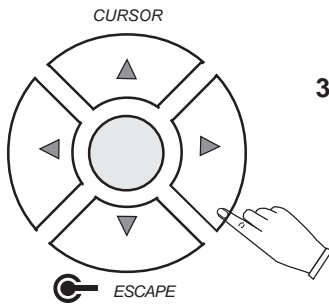

3. Press one of the CURSOR buttons to move the highlighted area to the voice you would like to select.

Reed		Group B	
Oboe		English Horn	
Bassoon		Clarinet	

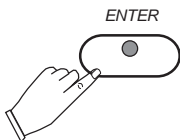

4. Press the ENTER button to confirm your selection. After a 4 second delay the LCD Display Screen will revert to the performance screen showing the new voice.

UPPER	70 : English Horn		
	1 : Big Band		
	NC	A1	♪ = 100

PIANO VOICES - EFFECTS AND RESET

The **Grand Piano, Reverb and Chorus Buttons** can reset your piano's current functions or add Digital Effects to your selected Instrument Voice.

GRAND PIANO



GRAND PIANO - This button will reset the piano to its default (power up) settings. The Grand Piano voice will be engaged for all 88 keys. No matter what control, functions, features or modes that the piano is in, it will be "reset" to strictly the basic operating system of upper piano voice for all 88 piano keys.

REVERB



REVERB - The reverb effect is engaged automatically when the power is turned on. Reverb simulates the effect of playing in a big room or hall where the sound reverberates off the walls and ceiling. The reverb feature will toggle on and off by pressing the REVERB button. The reverb setting does not affect the auto accompaniment. Reverb depth can be changed in the setup menu "Reverb". Please see the Setup section for more information.

EFFECTS



EFFECTS - The EFFECTS button will add chorus, flanger or the delay effect to the selected to the selected instrument voice(s). There are eight DSP (Digital Signal Processing) effects available. Use the setup menu "Effects" to change the effect. Please see the Setup section of this manual for more information.

RHYTHM SECTION - SELECTING A RHYTHM

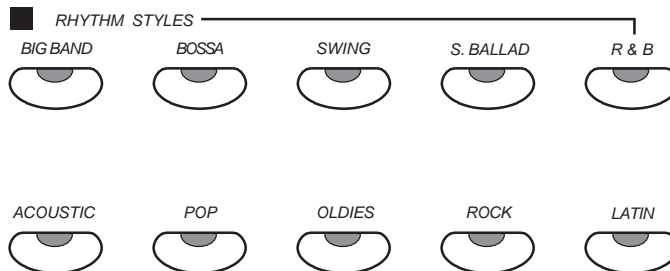

RHYTHM STYLE SELECTION - Your Suzuki HP-275e Piano has a large variety of exciting musical “Rhythm Styles” that you can “play along with” to back up your own performance. You can choose from a simple piano or percussion accompaniment to a full band or orchestra.

Stored in the memory of this Instrument are 70 Rhythm Styles plus a variation of each style pattern.

There is a complete list of all 70 Rhythm Styles in the back of the manual.

QUICK SELECT - There are ten Rhythm Style Buttons that can be selected quickly by pressing one of these ten quick select RHYTHM STYLE buttons shown above.

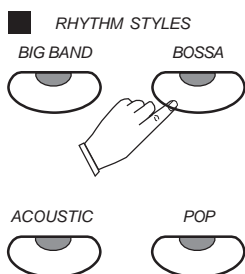

1. Press the RHYTHM STYLE button that corresponds to the desired rhythm style, the indicator will light up. The rhythm style will instantly be selected, the rhythm style number and name will show on the LCD Display Screen.

For our example we selected the Bossa Rhythm Style Button.

STYLE	1 : Grand Piano		
	8 : Cool Bossa		
	NC	A1	♩ = 120



NOTE: To hear just the Rhythm Percussion of your selected rhythm pattern press the Start/Stop Button.

To hear and play along with the entire accompaniment orchestration see the Auto Accompaniment Section of this manual a few pages ahead.

RHYTHM SECTION - SELECTING A RHYTHM

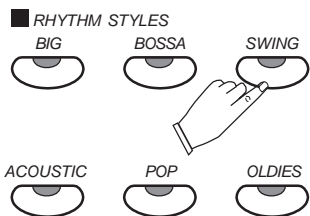

1. Press one of the quick select RHYTHM STYLE buttons twice, to display the Rhythm Style selection menu on the display screen. Each button will contain four to eight related Rhythm Styles. For our example we pressed the Swing Button.

Swing		Group A	
Swing Trio		Solo Piano Swing	
Swingin'Organ		Dixie	

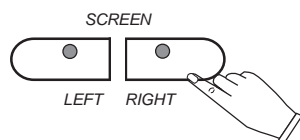

2. Use the SCREEN RIGHT, SCREEN LEFT buttons to page through the Rhythm Style groups. For our example we pressed the Screen Right Button once.

Swing		Group B	
Lounge		Jazz	
Swing			

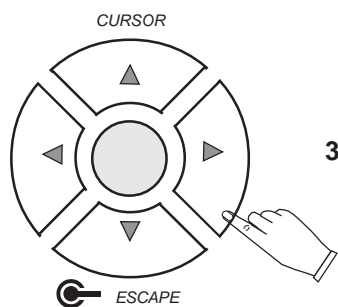

3. Use the CURSOR buttons to move the highlighted area to the rhythm style you would like to select. If there were more than 1 selection. For our example we pressed the Cursor Right Button once.

Swing		Group B	
Lounge		Jazz	
Swing			

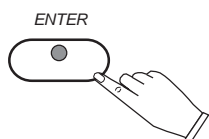

4. Press the ENTER button to confirm your selection. The display will revert to the performance screen showing your newly selected Rhythm Style.

STYLE	1 : Grand Piano		
	19 : Jazz		
	NC	A1	♪ = 100



NOTE: The Rhythm Style Button Group display will be shown on the LCD Display Screen for 4 seconds then it will revert back to the original Performance Display Screen.

To make the Display Screen hold longer than 4 seconds please see the Set Up Section of this manual under the Screen Hold Heading.

RHYTHM SECTION - SELECTING A RHYTHM

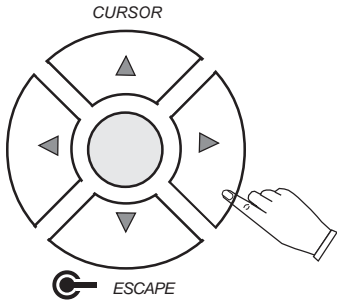

SELECTING A RHYTHM STYLE USING LCD DISPLAY PANEL CONTROLS

Selecting a Rhythm Style using only the Cursor and Value Buttons

1. Highlight the Rhythm Style name area using the CURSOR buttons.

STYLE	1 : Grand Piano		
	1 : Big Band		
	NC	A1	♪ = 100

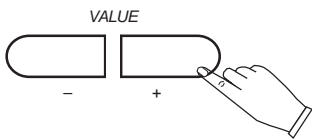

2. Press the VALUE + and - buttons or turn the Data Wheel to cycle through the Rhythm Style numbers and names until you reach the rhythm style that you would like to select.
For our example we pressed the Value + Button until we arrived at the Swing Trio Rhythm Style.

STYLE	1 : Grand Piano		
	14 : Swing Trio		
	NC	A1	♪ = 100



NOTE: If you hold down the + or - Value Button the Rhythm Styles will cycle up or down respectively until you release the Button.

RHYTHM SECTION - PLAYING THE RHYTHM

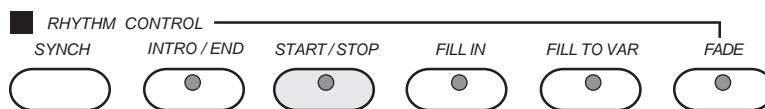

Intro, Fill-In and Ending Patterns fitting each different Rhythm Style are permanently recorded in your instrument, thus allowing a versatile Rhythm Performance.

START / STOP

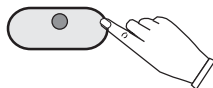

STRAIGHT START

1. Press the Start/Stop Button.
Your Selected Rhythm Style Drum Pattern will begin to play.

INTRO / END



START / STOP

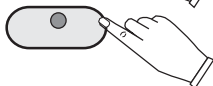

INTRO -

Begin the Rhythm Performance with an Intro Pattern.

1. Press the INTRO/ENDING Button
2. Press the Start/Stop Button.
An Intro pattern is played, after which the normal rhythm pattern begins.

SYNCH

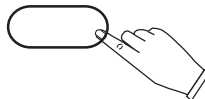

SYNCHRONIZED START -

Begin the Rhythm Performance when you play a chord with the piano keys on the left side of the piano.

1. Press the SYNC Button
2. Play a Chord on the piano keys on the Left Hand side of the piano.
The normal rhythm pattern begins to play as soon as the Chord is played.

START / STOP

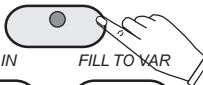

FILL IN

FILL TO VAR

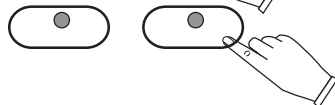

FILL IN -

You can insert a fill-in pattern any time during the rhythm performance. Choose from two different Fill In Patterns (Fill In or Fill to Var)

1. Press the Start / Stop Button
2. Press the piano Fill In or Fill to Var Button.
A Fill In Pattern is heard for the remainder of the measure. When a Fill In Button is pressed on the last beat of the measure, the Fill In pattern continues until the end of the following measure. Also, the Fill In Pattern will continue to Play for as long as you hold down a Fill In Button.

START / STOP

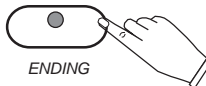

ENDING

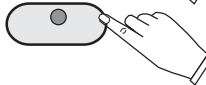

ENDING -

Finish the Rhythm Performance with an Ending Pattern.

1. Press the Start / Stop Button
2. Press the Intro / Ending Button.
An Ending is produced and then the Rhythm Performance stops.
NOTE: If you accidentally press the Intro / Ending Button in the middle of the tune Press a Fill In Button. The Ending Pattern will Stop and the normal rhythm performance continues.

RHYTHM SECTION - PLAYING THE RHYTHM

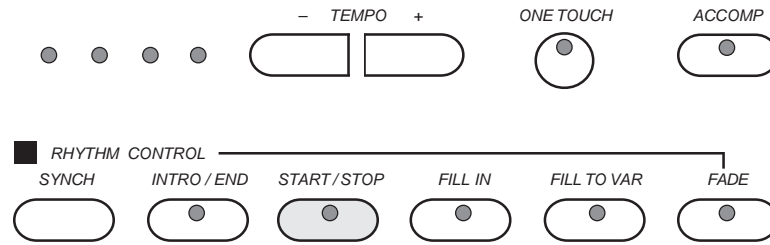

FADE -

Finish the Rhythm Performance with by Fading the Rhythm Volume to Zero.

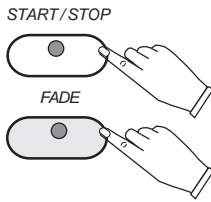

1. Press the Start / Stop Button
2. Press the Fade Button.
The normal rhythm pattern begins to gradually Fade until completion.

ADJUST THE TEMPO CONTROLS -

The Tempo of the Rhythm Pattern can be adjusted with the Tempo Buttons, the Value Buttons (+ -) or the Data Wheel.

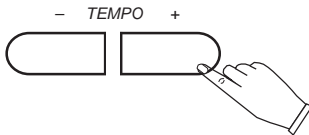

1. The Tempo is shown on the LCD Display as a numerical value from 40 to 250 BPM (Beats Per Minute).
2. Press the Tempo Buttons to adjust the Tempo.

TEMPO - There is a four-beat indicator next to the TEMPO buttons that visually indicate the tempo and the beat of the selected rhythm style. Each style has its own preset tempo.



NOTE: If you change the rhythm style during play, the tempo will keep the previous Rhythm Styles Default Tempo. However if you press the -/+ TEMPO buttons simultaneously it will set the tempo to the current rhythm styles' default value.

Also Note: The tempo can also be adjusted from the performance screen. When the Tempo Area of the LCD Display is highlighted then the Tempo can be adjusted using the Value Buttons or the Data Wheel. To adjust Tempo during Playback see below.

AUTO ACCOMPANIMENT

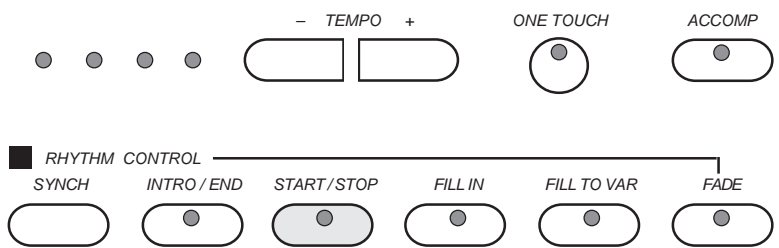

Simply by playing a chord on the keyboard, the AUTO ACCOMPANIMENT function automatically plays an accompaniment pattern which matches perfectly the selected rhythm. With a real accompaniment as a background, you can concentrate on playing the melody.

HOW AUTO ACCOMPANIMENT WORKS

When an Auto Accompaniment Chord is selected, an automatic accompaniment which matches the Rhythm Pattern you have chosen is played in the chord which you specify with your left hand. The melody is played with your right hand.

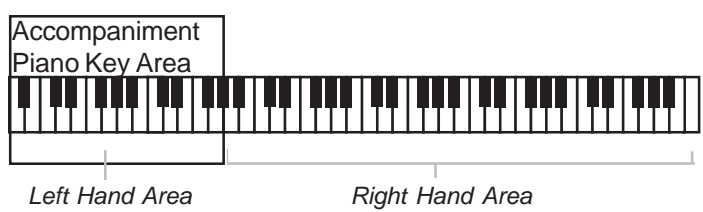

The Accompaniment Pattern of the Auto Accompaniment is composed of the DRUMS, BASS and ACCOMPANIMENT (Accomp. Chords).



NOTE: The Volume of each part can be adjusted with the LCD Volume Level Screen. Press the UPPER Sound Channel Button to view this Menu Screen.

AUTO ACCOMPANIMENT - TYPES

HOW TO PLAY CHORDS

There are 3 different ways to specify chords on the Keyboard.

Basic Mode (One Finger)

For beginner players, a left hand chord can be specified with just one finger. You can either press one key on the left keyboard section to specify the root note (one-finger), or play all the notes of the chord.

NOTE: When the rhythm is on, even if the keys are released, the accompaniment continues to play in the specified chord until you specify another chord.

ONE FINGER

Press a key in the left keyboard section to specify the root note. The major chord corresponding to this root note is automatically played in an accompaniment pattern.

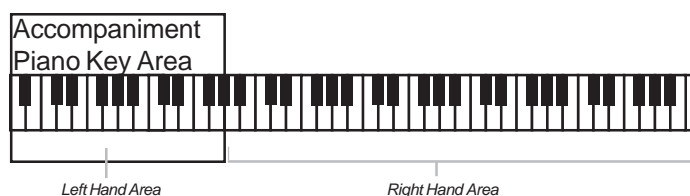

Major Chord: Press any key in the auto accompaniment section of the piano. The key you press determines the root note of the major chord.



Minor Chord: Press the root key and the third piano key to its right (minor 3rd key) in the auto accompaniment section of the piano simultaneously.



Seventh Chord: Press the root key and the piano key to its immediate left (7th key) in the auto accompaniment section of the piano simultaneously.



Minor-Seventh Chord: Press the root key and both the second piano key to its left (7th key) and the third piano key to its right (minor 3rd key) in the auto accompaniment section of the piano simultaneously.

AUTO ACCOMPANIMENT - TYPES

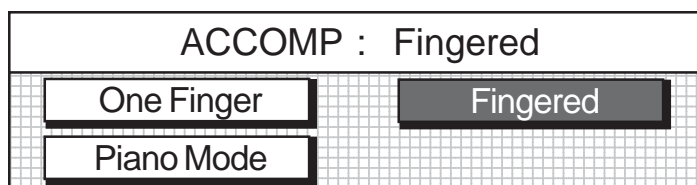

FINGERED MODE -

The fingered mode is ideal if you already know how to play chords on the piano.

Specify the chord by playing all the notes in the chord.

Play Chords by pressing a least three keys.

Please note, if a chord played cannot be recognized (fingered beyond the table shown below), the previous chord will keep playing.

An unrecognized chord cannot start the auto accompaniment in the synchronized start mode.

The “Fingering Guide” table below lists all of the 16 playable chords of this mode.

FINGERING GUIDE

Chord	Mark	Fingering
Major	M	1-3-5
Major sixth	M6	1-3-5-6
Major seventh	M7	1-3-(5)-7
Major add ninth	M 9	1-2-3-(5)-7
Augmented	Aug	1-3-#5
Minor	m	1-b3-5
Minor sixth	m6	1-b3-5-6
Minor seventh	m7	1-b3-(5)-b7
Minor seventh flatten fifth	m7b5	1-(b3)-b5-b7
Minor add ninth	m 9	1-2-b3-(5)-b7
Minor major seventh	mM7	1-b3-(5)-7
Diminished	Dim	1-b3-b5
Diminished seventh	Dim7	1-b3-b5-6
Seventh	7	1-3-(5)-b7
Seventh suspend fourth	7sus4	1-4-5-b7
Suspended fourth	Sus4	1-4-5

Please note, the notes listed in parentheses can be omitted.

The listed chord fingerings are all in root note position, other inversions can be used with the exception of:

1. The M6 chords are only recognized in root note position. All other inversions are interpreted as m7.
2. The 6 9 chords are only recognized in root note position. All other inversions are interpreted as minor chords.
3. The m6 chords are only recognized in root note position. All other inversions are interpreted as m7b5.
4. With aug and dim7 chords the lowest note played is assumed to be the root.

AUTO ACCOMPANIMENT - TYPES

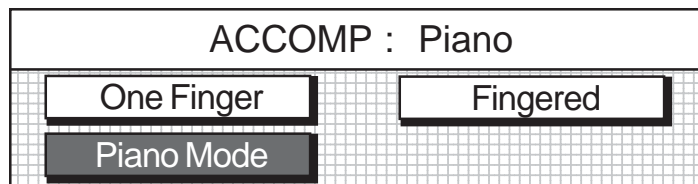

PIANO CHORD MODE -

In the Piano Mode the entire keyboard can be used to specify chords for the automatic accompaniment.

Please Note: In this Mode the keyboard does not Split.

Chords can be specified anywhere on the keyboard.

Chords are specified the same way as for the Fingered Mode and the types of Chords are also the same.

MANUAL BASS -

It is possible to play Single Note Bass Lines in the Accompaniment Piano Key Area of the Piano when the Manual Bass Function is engaged.

Please see the Key Mode area of the SET UP section of this manual.

SPLIT POINT -

The piano is split into two sections at the split point.

The default split point is the G2 key for auto accompaniment.

A different split point can be assigned in the setup menu "Performance".

Please see the Setup Section of this manual for more information.

AUTO ACCOMPANIMENT - HOW TO USE

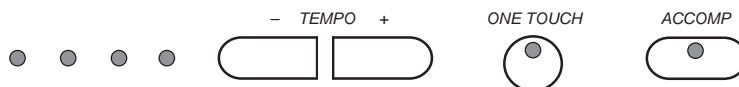

SELECTING YOUR AUTO CHORD TYPE

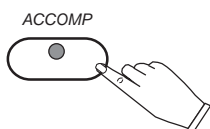

1. Press the ACCOMP button, Its indicator LED will turn on. The LCD Display Screen will show the accompaniment "Chord" menu.

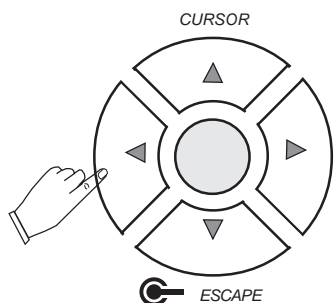
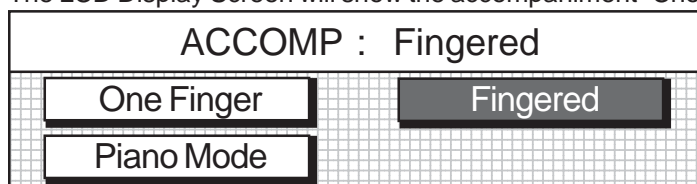

2. Use the cursor to move the highlighted area to the chord fingering mode that you want, One Finger, Fingered or Piano. The Fingered mode is the default mode.

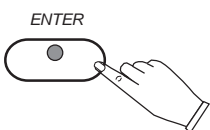
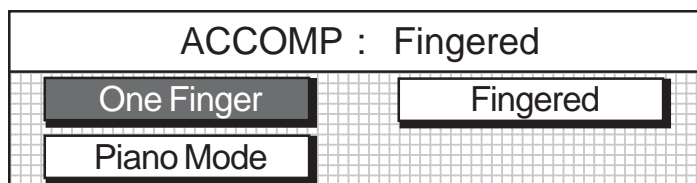

3. Press the ENTER button to confirm your selection. If you do not press the Enter Button your selection will not be engaged.



NOTE - when the Auto Accompaniment Mode is engaged the LCD Display Screen will show the specified Chord on the bottom left portion of the Performance Menu screen.

AUTO ACCOMPANIMENT - HOW TO PLAY

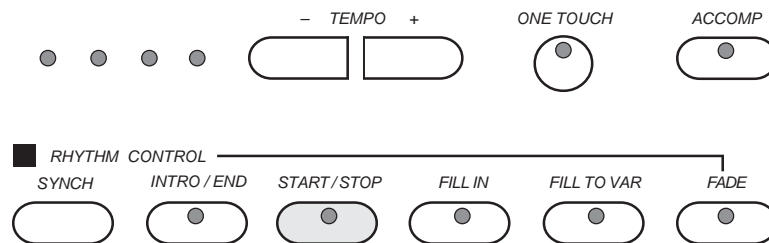

PLAYING IN THE AUTO ACCOMPANIMENT MODE -



1. Press the ACCOMP button its LED indicator light will turn on.
2. Select the Chord Finding Mode (see previous page).

SYNCHRONIZED START

Begin the Accompaniment Orchestration when you play a chord with the piano keys on the left side of the piano.

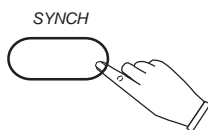

1. Press the SYNC Button
The Tempo LED Indicator lights will flash.
2. Play your Respective Chord Type on the Accompaniment area of the piano keys.
The Accompaniment Pattern begins to play as soon as the Chord is played.

SYNCHRONIZED INTRO START -

Begin the Accompaniment Orchestration with an Intro Pattern.

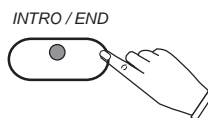
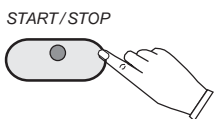

1. Press the SYNC Button
The Tempo LED Indicator lights will flash.
2. Press the INTRO/ENDING Button
3. Play your Respective Chord Type on the Accompaniment area of the piano keys.
The Accompaniment Pattern begins to play as soon as the Chord is played.

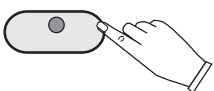

FILL IN -

You can insert a fill-in pattern any time during the rhythm performance. Choose from two different Fill In Patterns (Fill In or Fill to Var)

1. Press the Start / Stop Button
2. Press the piano Fill In or Fill to Var Button.
A Fill In Pattern is heard for the remainder of the measure. When a Fill In Button is pressed on the last beat of the measure, the Fill In pattern continues until the end of the following measure. Also, the Fill In Pattern will continue to Play for as long as you hold down a Fill In Button.

AUTO ACCOMPANIMENT - HOW TO PLAY

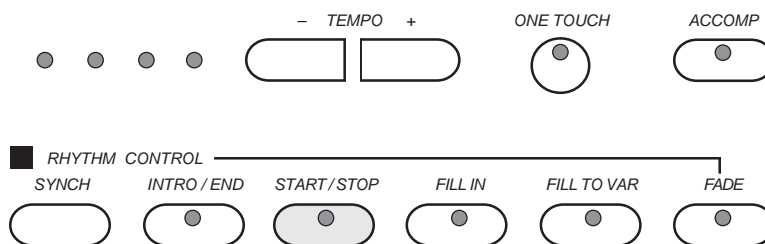

CONTINUED

FILL IN -

You can insert a fill-in pattern any time during the Accompaniment Orchestration.

Choose from two different Fill In Patterns (Fill In or Fill to Var).

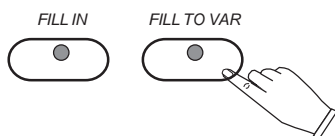

1. Press the piano Fill In or Fill to Var Button.

A Fill In Pattern is heard for the remainder of the measure.

When a Fill In Button is pressed on the last beat of the measure, the Fill In pattern continues until the end of the following measure.

Also, the Fill In Pattern will continue to Play for as long as you hold down a Fill In Button.

ENDING -

Finish the Accompaniment Orchestration with an Ending Pattern.

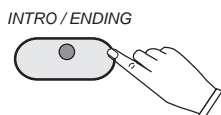

1. Press the Intro / Ending Button.

An Ending Pattern is produced and then the Accompaniment Orchestration stops.

NOTE: If you accidentally press the Intro / Ending Button in the middle of the tune Press a Fill In Button. The Ending Pattern will Stop and the normal rAccompaniment Orchestration will continues.

FADE -

Finish the Accompaniment Orchestration with by Fading the Orchestration Volume to Zero.

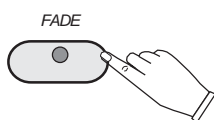

1. Press the Start / Stop Button
2. Press the Fade Button.
The normal rhythm pattern begins to gradually Fade until completion.

SETUP

The SETUP Function is used to set up or to adjust various parameters related to the operation of this piano. The SETUP button will access menus for **Performance**, **Harmony**, **Key Mode**, **Sustain**, **Reverb**, **Chord mode**, **Effects**, **Pedal**, **Percussion**, and **Metronome Mode**.

USING THE SETUP MENU

1. Press the SETUP button.
The Initial Set Up Screen Menu will appear on the LCD Display.
As Shown Below

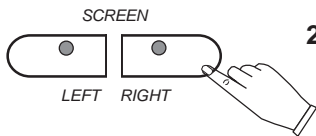
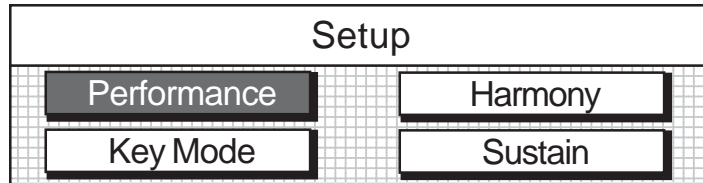

2. Press the SCREEN RIGHT Button to access all the Setup Menus.
There are a total of 3 Setup Menu Screens.
The remaining two Menu Screens are shown below.

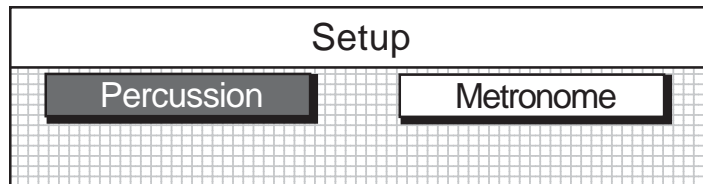
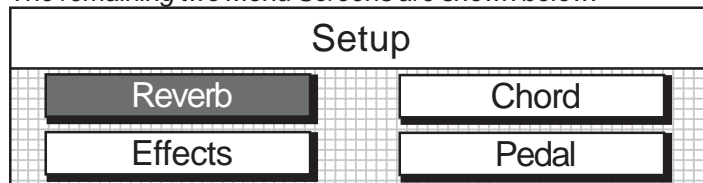

3. Use the SCREEN RIGHT (OR LEFT) AND CURSOR Buttons to navigate the Menu Screens and to highlight the Function or Mode that you want to access.
4. Press the ENTER button to confirm your selection.



NOTE: Press the ESCAPE Button at any time to revert to the previous screen. Continued pressing of the ESCAPE button will return the screen to the initial Performance Menu Screen.

ALSO NOTE: To leave the SETUP Mode press the SETUP button. Its LED indicator light will turn off.

SETUP - PERFORMANCE MENU

**SETUP MODE
PERFORMANCE SETUP MENU**

1. Press the SETUP button.
The first Set Up Menu Screen will appear on the LCD Screen
2. The Performance Listing will be highlighted.
Press the ENTER button to access the Performance menu.
3. Use the CURSOR buttons to access the following options shown below.

Performance Setup			
Velocity	Norm	Split Point	G2
Transpos	0	Screen Hold	45

Velocity - This adjusts the Piano Keybed's Touch Sensitivity Response. The piano offers four types of piano velocity settings, low, normal, high, and fixed.

The NORMAL setting is selected automatically when the piano is turned on.

Use the **VALUE** buttons to change the velocity setting. Press the ENTER button to confirm.

VELOCITY - Settings Explained

Low is a less sensitive piano response which requires a heavier touch to obtain maximum sound levels.

Normal is an intermediate response suitable for most styles of music. Normal is the default setting.

High is the most sensitive piano response which permits maximum sound levels with a light touch.

Fixed does not offer any touch sensitivity. Each key plays at full volume no matter how hard the piano key is hit. It is commonly used on Harpsichord and Organ voices.

SPLIT POINT FUNCTION

Performance Setup			
Velocity	Norm	Split Point	G2
Transpos	0	Screen Hold	45

Split Point - The split point divides the piano into two sections for both the Upper Piano Voice, and the Auto Accompaniment or Lower Voice. Please see the Piano Voices section for more information.

The Auto Accompaniment Split Point divides the piano into an Accompaniment section and a Melody Upper Piano section. Please see the Auto Accompaniment section for more information.



NOTE: The default split point is the G2 key. Use the - VALUE + buttons or the DATA wheel to select a split point in the range of C2-C4 Piano Key Range. Press the - VALUE + buttons simultaneously to recall the default setting.

SETUP - PERFORMANCE MENU

PERFORMANCE- SETUP MENU

1. Press the SETUP button.
The first Set Up Menu Screen will appear on the LCD Screen
2. The Performance Listing will be highlighted.
Press the ENTER button to access the Performance menu.
3. Use the CURSOR buttons to access the following options shown below.

TRANSCOPE -

The Transpose feature can shift the pitch of the piano up or down in semitone intervals.

Use the VALUE + or VALUE – buttons to set the transpose value range from –5, five consecutive piano keys lower, to six consecutive piano keys higher.

The Transpose setting of zero is pitch neutral or not engaged.

Transpose does not affect notes that are sounding and it does not affect the piano percussion.

Performance Setup			
Velocity	Norm	Split Point	G2
Transpos	0	Screen Hold	45

LCD SCREEN DISPLAY HOLD -

The Screen Hold sets the time for which the selected Menu Screen will stay on the LCD Display before automatically reverting to the prior screen.

Use the – VALUE + buttons or the VALUE wheel to select a screen hold in the range of 1 second to 44 seconds.

Press the – VALUE + buttons simultaneously to recall the default setting of 4 seconds.

Performance Setup			
Velocity	Norm	Split Point	G2
Transpos	0	Screen Hold	4S

SETUP - PERFORMANCE MENU

PERFORMANCE- SETUP MENU

1. Press the SETUP button.
The first Set Up Menu Screen will appear on the LCD Screen
2. The Performance Listing will be highlighted.
Press the ENTER button to access the Performance menu.
3. Use the SCREEN RIGHT BUTTON and the CURSOR buttons to access the following options shown below.

TUNE -

The pitch of this piano is very accurate and stable, it is automatically set to standard A440 pitch when the piano is turned on.

The Tuning feature of this piano makes it possible to adjust the pitch of this instrument in fine intervals.

If necessary, you can adjust the pitch of this piano to match the pitch of another instrument or singer.

Use the – VALUE + buttons or the VALUE wheel to select a tuning value in the range of –50 to +50 semitone steps, or cents.

Press the – VALUE + buttons simultaneously to recall the default setting of 0.

Performance Setup			
Tune	0	Fixed Level	100
Fade Time	105	Octave Shift	0

FIXED LEVEL -

When the Touch Response of the Piano Keys is Fixed or without Touch Sensitivity, the Fixed Level controls the overall sound output from the piano keys.

Fixed Touch Response is used when you would like the piano keyboard to play like an Organ.

Use the – VALUE + buttons or the VALUE wheel to select a fixed level volume value in the range of 10-127.

Press the – VALUE + buttons simultaneously to recall the default setting of 100.

Performance Setup			
Tune	0	Fixed Level	100
Fade Time	105	Octave Shift	0

SETUP - PERFORMANCE MENU

PERFORMANCE- SETUP MENU

1. Press the SETUP button.
The first Set Up Menu Screen will appear on the LCD Screen
2. The Performance Listing will be highlighted.
Press the ENTER button to access the Performance menu.
3. Use the SCREEN RIGHT BUTTON and the CURSOR buttons to access the following options shown below.

FADE TIME -

Fade time adjusts the length of time that an accompaniment fade introduction or fade out ending takes.

Use the VALUE + and - buttons or the VALUE wheel to select a fade tune value in the range of 2 - 25 seconds.

Press the VALUE + and - buttons simultaneously to recall the default setting of 10 seconds.

Performance Setup			
Tune	0	Fixed Level	100
Fade Time	10S	Octave Shift	0

OCTAVE SHIFT -

The Octave Shift will transpose the entire piano one octave down (12 semitone steps).

This Octave Shift only transposes one Octave down.

Use the VALUE + and - buttons to select an octave shift of -1, and the keys will play as if they were an octave lower on the piano.

The Octave Shift Setting of 0 is the normal default piano settings.

Performance Setup			
Tune	0	Fixed Level	100
Fade Time	10S	Octave Shift	0

SETUP - HARMONY MENU

HARMONY SETUP MENU

1. Press the SETUP button.
2. Use the CURSOR button to highlight the Harmony menu.
3. Press the ENTER button to access the Harmony menu.
4. Use the CURSOR button to select a harmony type, then use the VALUE buttons to turn that harmony type on or off. Only one harmony type can be selected at a time.

Harmony		
Trio	Duet	Oct
OFF	OFF	OFF

HARMONY -

Harmony is used to enhance a single note melody line that you would play while the auto accompaniment is engaged.

When the Harmony feature is engaged, the single note on the right-hand section of the piano will sound with additional auto harmony notes.

The note played in the right-hand section of the piano determines the root key of the harmony.

If more than one note is played only the highest note will add harmony.

NOTE: The Harmony Feature is only available when the auto accompaniment is engaged.

HARMONY TYPES -

Trio - adds two harmonizing notes sounding below the single note that you play.

Duet adds a harmonizing note sounding below the single note that you play.

Octave add a note one octave below the note you play in the right hand section of the piano.

SETUP - KEY MODE MENU

KEY MODE SETUP MENU

1. Press the SETUP button.
2. Use the CURSOR button to highlight the Key Mode menu.
3. Press the ENTER button to access the Key Mode menu.
4. Use the CURSOR button to select a key mode type, then use the VALUE buttons to turn that key mode type on or off.

MANUAL BASS -

The Manual Bass feature functions only when the piano is in the Auto Accompaniment Mode.

The Piano Keys below the Split Point will play notes on the bass channel, thus allowing you to play a manual bass line with your left hand.

The Manual Bass replaces the Auto Accompaniment Bass Line.

If you stop playing Manual Bass Notes the Auto Accompaniment Bass Line will return at the start of the next measure, or when a new Auto Accompaniment chord is generated.

Key Mode	Manual Bass	OFF
	Lower Hold	OFF

LOWER HOLD -

When the Lower Hold feature is on, some notes below the Split Point will remain playing even though the keys have been released.

The notes are cancelled when new keys are pressed, or when the pedal, assigned to lower hold, is engaged.

Key Mode	Manual Bass	OFF
	Lower Hold	OFF

SETUP - SUSTAIN MENU

SUSTAIN - SETUP MENU

1. Press the SETUP button.
2. Use the CURSOR button to highlight the Sustain menu.
3. Press the ENTER button to access the Sustain menu.
4. Use the CURSOR button to select a sustain type, then use the VALUE buttons to adjust your selected sustain type on or off. Sustain defaults to all options on.

SUSTAIN -

The Sustain Pedal can affect the Sound Channels Upper, Layer and/ or Lower of this piano.

This menu allows you to configure which Sound Channels will be affected by the sustain pedal.

Upper - When Sustain Upper is on, the right pedal when engaged, will Sustain the Upper Sound Channel Voice Notes.

Sustain		
UPPER	LAYER	LOWER
ON	ON	ON

Layer - When Sustain Layer is on, the right pedal when engaged, will Sustain the Layer Sound Channel Voice Notes.

Sustain		
UPPER	LAYER	LOWER
ON	ON	ON

Lower - When Sustain Lower is on, the right pedal when engaged, will Sustain the Lower Sound Channel Voice Notes.

Sustain		
UPPER	LAYER	LOWER
ON	ON	ON

SETUP - REVERB MENU

REVERB - SETUP MENU

1. Press the SETUP button.
2. Use the SCREEN RIGHT button to access the second page of the setup menu options.
3. Press the ENTER button to access the Reverb menu.
4. Use the CURSOR button to access the following options:

REVERB

Reverb simulates the effect of playing in a big room or hall where the sound reverberates off the walls and ceiling. Pressing the REVERB button will toggle this effect on or off. When reverb is engaged the indicator light will be lit. The reverb effect is engaged automatically when the power is turned on. **To select a type of reverb and to adjust the reverb levels use the Reverb setup menu.**

Reverb Setting			
Reverb	UPPER	LAYER	LOWER
Room 3	100	100	100

Use the VALUE + and - buttons to select a reverb type or to adjust the Reverb Depth from the list below.

Reverb Depth (amount of Reverb) range is from 0 to 127.

UPPER - When reverb upper is turned on the Upper Sound Channel Voice notes will reverberate.

Use the VALUE + and - buttons to select a reverb level from 0-127. Press the VALUE + and - buttons simultaneously to recall the default level of 100.

LAYER - When reverb layer is turned on the layer Sound Channel Voice notes will reverberate.

Use the VALUE + and - buttons to select a reverb level from 0-127. Press the VALUE + and - buttons simultaneously to recall the default level of 100.

LOWER - When reverb lower is turned on the lower Sound Channel voice notes will reverberate.

Use the VALUE + and - buttons to select a reverb level from 0-127. Press the VALUE + and - buttons simultaneously to recall the default level of 100.

REVERB TYPES

Room 1 is dense reverb with short decay.

Room 2 is sparse reverb with short decay.

Room 3 is sparse reverb with medium decay.

Hall 1 is reverb with clear reverberation and medium decay.

Hall 2 is reverb with rich reverberation and greater late reflections.

Plate is a delay type.

Delay is stereo delay that produces two delay sound, left and right.

Panning emphasizes the stereo location of the processor delay, the effect will be spaced at 30 degrees from the center.

SETUP - EFFECTS MENU

EFFECTS (CHORUS) - SETUP MENU

1. Press the SETUP button.
2. Use the SCREEN RIGHT button to access the second page of the setup menu options.
3. Use the CURSOR button to highlight the Effects menu.
4. Press the ENTER button to access the Effects menu.
5. Use the CURSOR button to access the following options:

EFFECTS (CHORUS)

The Effect or Chorus enriches your performance by adding depth, texture and spaciousness to your selected instrument voice.

Pressing the EFFECTS button on the control panel will toggle the Effects Function on and off.

Select the type of Effect and adjust the level in the Effect menu.

Effect Setting			
Effect	UPPER	LAYER	LOWER
Chorus 3	100	100	100

UPPER - When reverb upper is turned on the Upper Sound Channel Voice notes will sound with the selected Effect.

Use the VALUE + and - buttons to select a reverb level from 0-127. Press the VALUE + and - buttons simultaneously to recall the default level of 100.

LAYER - When reverb layer is turned on the layer Sound Channel Voice notes will sound with the selected Effect.

Use the VALUE + and - buttons to select a reverb level from 0-127. Press the VALUE + and - buttons simultaneously to recall the default level of 100.

LOWER - When reverb lower is turned on the lower Sound Channel voice notes will sound with the selected Effect.

Use the VALUE + and - buttons to select a reverb level from 0-127. Press the VALUE + and - buttons simultaneously to recall the default level of 100.

EFFECT TYPES

There are eight Effect types.

Use the VALUE + and - buttons to select an effect type from the list below.

Chorus 1.

Chorus 2.

Chorus 3.

Chorus 4.

F B (feedback) Chorus applies a repeated sound effect.

Flanger gives an electronic swirl effect.

Short Delay offers a short delay effect.

F B (feedback) Delay applies a delayed repeated sound effect.

SETUP - CHORD MENU

CHORD - SETUP MENU

1. Press the SETUP button.
2. Use the SCREEN RIGHT button to access the second page of the setup menu options.
3. Use the CURSOR button to highlight the Chord menu.
4. Press the ENTER button to access the Chord menu.
5. Use the CURSOR button to select a fingering mode. Use the ENTER button to confirm your selection.

CHORD MODE (AUTO ACCOMPANIMENT MODE)

The Chord Mode or Auto Accompaniment is explained in detail in the Auto Accompaniment Section of this manual.

Pressing the ACCOMP button engages the auto accompaniment.

In this mode, the keys to the left of the split point can be used to create fully orchestrated chord progressions, based on the chords that you play with your left hand.

There are three fingering modes to choose from, One finger, Fingered or Piano.

Use the Chord menu to select a mode, please see the Auto Accompaniment section of this manual for more information on fingering modes.

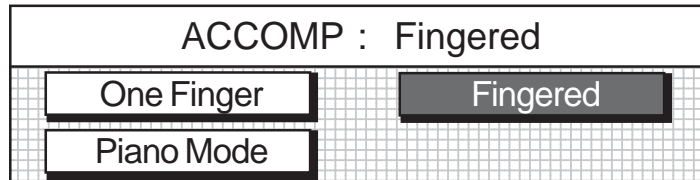

ONE FINGER

Press a key in the left keyboard section to specify the root note. The major chord corresponding to this root note is automatically played in an accompaniment pattern.

FINGERED MODE -

The fingered mode is ideal if you already know how to play chords on the piano.

Specify the chord by playing all the notes in the chord.

Play Chords by pressing a least three keys.

PIANO CHORD MODE -

In the Piano Mode the entire keyboard can be used to specify chords for the automatic accompaniment.

Please Note: In this Mode the keyboard does not Split.

Chords can be specified anywhere on the keyboard.

Chords are specified the same way as for the Fingered Mode and the types of Chords are also the same.

SETUP - PEDAL MENU

PEDAL ASSIGN - SETUP MENU

1. Press the SETUP button.
2. Use the SCREEN RIGHT button to access the second page of the setup menu options.
3. Use the CURSOR button to highlight the Pedal menu.
4. Press the ENTER button to access the Pedal menu.
5. Use the CURSOR button to select the following options, the pedal can only be assigned to one.

PEDAL ASSIGN

The center pedal is the only assignable function pedal.

The sustain pedal (the pedal on the right), can only control the Sound Channel Voice notes.

The soft pedal (on the left), is also not assignable like the Sustain Pedal.

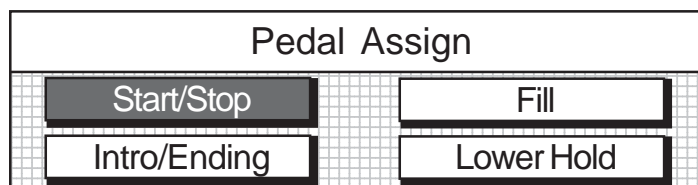

Start/Stop -

When selected the center pedal function now responds like the START/STOP button on the control panel.

Step on the center pedal to start or stop a selected Rhythm or Accompaniment feature.

The Center Pedal default mode is Start/Stop.

Fill -

When selected the center pedal function now responds like the Fill In Buttons on the control panel.

When engaged the pedal triggers the Fill In of the currently selected Fill-In to the main pattern or the Fill In to Variation.

Intro/Ending -

When engaged the center pedal function now responds like the Intro/Ending button on the control panel.

Therefore the pedal triggers an introduction or ending pattern.

Lower Hold -

When selected pressing the pedal will prevent notes below the split point from being switched off until the pedal is released.

If lower hold from the key mode setup is engaged, the pedal can be used to cancel notes that are played.

SETUP -PERCUSSION MENU

PERCUSSION (DRUM KIT SELECTION) -

1. Press the SETUP button.
2. Use the SCREEN RIGHT button to access the third page of the setup menu options.
3. Press the ENTER button to access the Percussion menu.
4. Use the – VALUE + buttons to change the current Value.

PERCUSSION (DRUM KIT SELECTION)

When piano percussion is engaged the piano keys will play the percussion voices from the selected Drum kit.

The Piano Keys will not be available for normal play.

There are eight drum kits, based on the standard kit, that can be assigned and a sound effects kit.

Please see the “Drum List” at the back of the manual for a complete listing.

Percussion Setup	
Drum Kits	
OFF	

NOTE: If OFF is selected the piano percussion mode will not be engaged, to engage the percussion mode select one of the following drum kits by pressing one of the Value Buttons.

Standard
Room
Power
Electronic
TR-808
Jazz
Brush
Orchestral
SFX

SETUP - METRONOME MENU

METRONOME - SETUP MENU

1. Press the SETUP button.
2. Use the SCREEN RIGHT button to access the third page of the setup menu options.
3. Use the CURSOR button to highlight the Metronome menu.
4. Press the ENTER button to access the Metronome menu.
5. Use the CURSOR button to access the following options:

METRONOME

The built in metronome is a timing device.

It is used as a timing reference to aid with practice or performance.

Press the **METRONOME Button** on the far right of the control panel to engage the metronome feature.

The button's LED Indicator will turn on, the display screen will show the Metronome menu and the metronome sound will start immediately.

You can access the Metronome menu from the SETUP button as listed above.

Metronome Setup				
Time Signature		4/4	Tempo	120
Sound	62	32	Volume	100

Time Signature - The time signature can be set to 2/4, 3/4, 4/4, 6/8 and 9/8.

Use the VALUE buttons to set the bottom time signature, then use the CURSOR button to highlight the top section.

Tempo - The tempo of the time signature can be adjusted, use the – VALUE + buttons or the VALUE wheel to adjust the tempo from 40-250 bpm (beats per minute).

Press the – VALUE + buttons simultaneously to recall the default setting of 100 bpm.

Adjusting the metronome tempo may also affect the rhythm style tempo.

Sound - The metronome can be assigned to sound as any of the percussive voices from the standard drum kit.

The first measure of the beat is assigned in the first part of the sound section and the remaining beats are assigned in the second part of the sound section.

Use the – VALUE + buttons to assign a sound by key number.

Please see the drum kit list in the back of the manual for a list of available sound.

Volume - Use the – VALUE + buttons or the Data wheel to adjust the metronome sound volume level from 1-127.

Press the – VALUE + buttons simultaneously to recall the default setting of 100.

REGISTRATION MEMORY

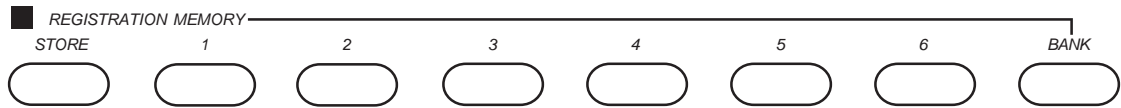

REGISTRATION

A registration is a particular group settings such as style, voice, chord and other parameters or features that you have engaged.

You can save these Settings or your “set up” so that it can be recalled by pressing a single button.

This piano has four banks with six registration numbers in each bank, for a total of 24 registrations memory locations.

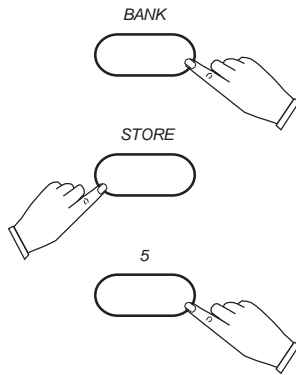

SAVE YOUR SETTINGS IN THE REGISTRATION MEMORY

1. Select the voice, rhythm, tempo, accompaniment, reverb, effect and any other parameters that you wish to save.
2. Select the bank that you would like to use to store your setting A-D.
3. Hold down the STORE button.
4. Press one of the REGISTRATION NUMBER buttons 1-6. The display will show the current registration memory number with the bank prefix. Your panel setting will be saved into that registration memory instantly. **NOTE:** Storing a setting into the registration memory will erase the previously stored data in that registration location

UPPER	1 : Grand Piano	
STYLE	1 : R & B	
NC	A5	♪ = 100

RECALL CONTENTS IN THE REGISTRATION MEMORY

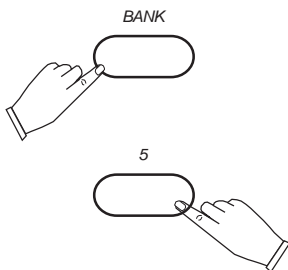

1. Press the BANK button to access the registration memory bank you would like to recall, the display screen will show the bank A thru D.
2. Press one of the REGISTRATION NUMBER buttons 1-6, the stored setting will be recalled instantly and the display will show the memory number with the bank prefix. The relevant parameters will be set and the display will reflect the Instrument Voice that has just been recalled.

RECORD FUNCTIONS

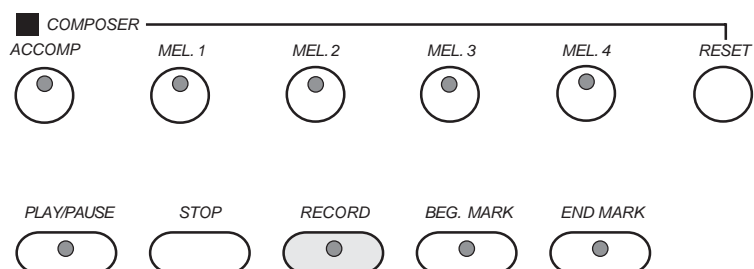

OUTLINE OF A MUSIC RECORDER (OR SEQUENCER)

A music recorder records your performance in a similar way to a tape recorder. This instrument's music recorder allows you to record and save up to 5 different ways.

You may want to record your entire performance at one time (especially if you are using Auto Accompaniment to provide the Orchestration), or build up a complex arrangement with several different parts playing together, like an ensemble score.

This Instrument's Music Recorder has 5 different tracks. This means that you can record 5 different parts. However you don't have to use all 5 tracks.

For some uses you may only need to use one or two tracks. This instrument's Music Recorder allows you to change a track's musical passage unlike a tape recorder.

This piano's 5 track music recorder (sequencer), is designed to be very simple to use.

It will record all note events and the accompaniment patterns exactly as they are performed.

All the recorded tracks can playback separately or together as a complete song. You may also save your recorded information to disk, to play back at a later date or to create your own sound library.

Please see the Disk section of this manual for more information.

RECORD FEATURES

Record Melody Only -

Any of the Melody tracks (2 thru 5) will record one Sound Channel (Upper, Layer and Lower) note events, as they are performed.

These are assigned by pressing one of the four MELODY (Mel) Buttons. If one of the MELODY buttons is selected the recording will begin as soon as you play on the piano.



NOTE: Only one melody track and only one Sound Channel Voice (Upper, Layer or Lower) can be recorded at a time.

ALSO NOTE: If recording one **Melody track ONLY** with the Accompaniment mode engaged, the auto accompaniment section of the piano will not be recorded, even though you can hear it being played.

RECORD FUNCTIONS

RECORD FEATURES - continued

Auto Accompaniment Track (Accomp Button) -

The Auto Accompaniment track will record the chord changes, style, tempo, variation, intro, fill-in and ending.

Pressing The ACCOMP track button and the Record Button will select the accompaniment track for recording.

If ACCOMP Record track button has been selected and it's LED Indicator light is Flashing, then the auto accompaniment will be synchronized to start when the piano keys are played.

Recording will start as soon as a chord is played on the auto accompaniment section of the piano.

All accompaniment, such as fill-ins, Intro's, Ending, will be recorded exactly as it is performed.



NOTE: Piano notes played on the Upper or Melody section of the piano will not be recorded on the auto accompaniment track, they will be recorded only on Mel 1-4 track buttons.

If the auto accompaniment section of the piano is off when the Accomp Button is selected, only the note played on the piano will be recorded. An unrecognized chord in the fingered mode cannot start the recording.

RECORDING

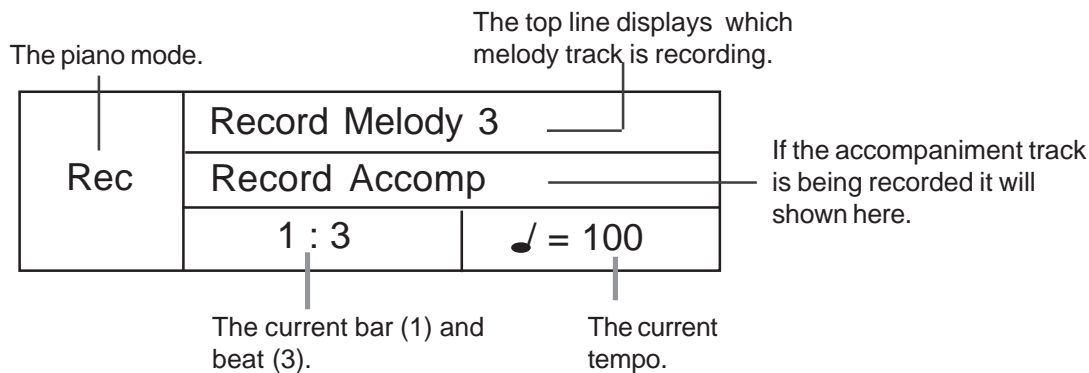

HOW TO RECORD

RECORDING

- 1. Prepare -**
Prepare to record by setting the voice, style, tempo and reverb level and other parameters as desired.
- 2. Select a track to record on-**
Press the RECORD button. It's Indicator LED will blink.

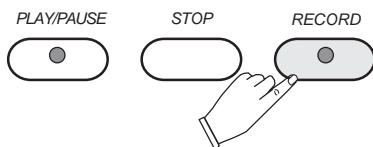

NOTE: The first available melody track will also be automatically selected and it's corresponding LED Indicator will also blink. The four LEDs of the Rhythm Beat Indicator (located to the left of the Tempo Buttons) will blink with the current tempo, to show that the music recorder is in standby mode.

- 3. Record -**
Play the Piano. Recording will start as soon as you play on the piano, depending on which track(s) has been selected.



- 4. Stop Recording -**
Press the STOP button, the PLAY/PAUSE button or the REC button to stop the recording process.

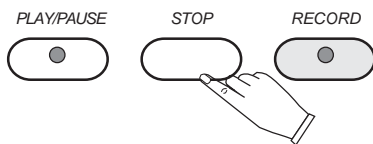

NOTE: When the record memory is full, recording will stop automatically.

- 5. Erase a Track -**
If you would like to erase a track- Hold the RESET button down **while** you press the track button that you would like to erase.

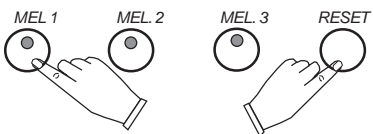

NOTE: If there is data in a track, its LED Indicator will also be lit. The previously recorded music will playback, as a reference, while you record the new track. If you do not wish for previously recorded tracks to play while you are recording, press the corresponding track button to turn the indicator light off.

RECORDING - PLAYBACK

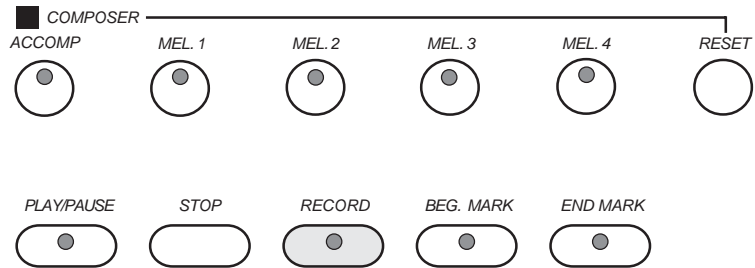

PLAYBACK

To listen to your recording follow these simple steps..

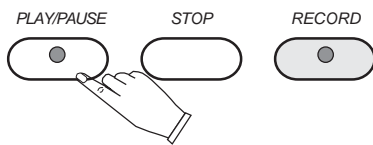

1. To Playback Your Recorded Music

Press the PLAY/PAUSE button.

The Play Buttons LED Indicator will stay on until the playback is complete.

You can play along on the piano keys while the recording is playing back.

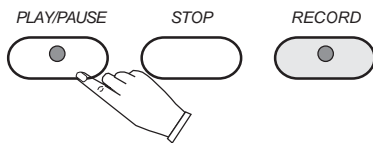

2. To Pause the Playback

While the playback is in process press the PLAY/PAUSE button to pause the playback.

The indicator will blink, press again to restart the playback where you left off.

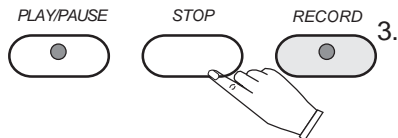

3. To Stop the Playback

Press the STOP button to stop the playback.

Your recording will be reset it's beginning.

RECORDING - MARK

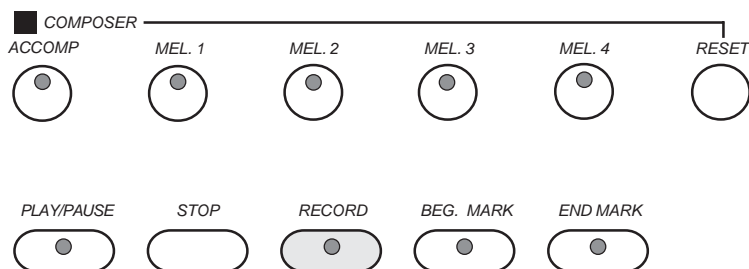

MARK -

The mark feature allows you to isolate a section of a track of your recording.

If you would like to study or to re-do a segment of your track recording, it can be easily accomplished with the BEG MARK, END MARK buttons.

The area that you mark by using the BEG MARK and END MARK buttons will function the same way as your previous recordings and playbacks except it is only that portion of the song instead of the entire song.

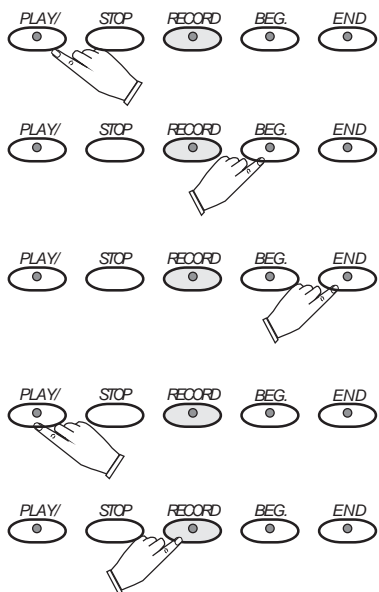

HOW TO USE BEG. MARK AND END MARK BUTTONS

1. With your musical performance recorded into the music recorder, **press the PLAY/PAUSE button.**
2. While listening to the playback **press the BEG MARK Button** at the place that you would like to begin to “isolate” your song. The Beg. Mark Button LED Indication will turn on.
3. As your song continues to playback **press the End Mark Button** at the end of the portion of your song that you want to “isolate.” The End Mark Button LED Indication will turn on. The playback of your song will automatically stop.
4. **Press the PLAY/PAUSE button** to listen to the section of the song that you marked.
5. **Press the RECORD button** to add a musical passage to your “marked or isolated area” of your song.



NOTE: You may also wish to select the track that you already recorded on

The recorded passage will playback from the beginning of the marked section until the end mark.

You can Record only the marked section and only on your selected track.

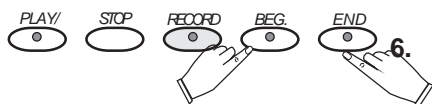

6. **Press the BEG MARK and END MARK buttons** to disengage the marked section. The Mark Buttons’ LED Indicators will turn on. Your song will now playback in its entirety.

SONG - PLAY ALONG SONG

This piano includes a range of songs covering a variety of genres that are enjoyable to listen to, or to play along with. You can begin practicing with just one hand, and you can play practice at your own tempo. This instrument will even evaluate and grade your performance for you!

SONG

The SONG button will access a play along music lesson guide that can be used as a fun way to learn new music.

There are approximately 50 songs built into the piano as reference for your Lesson entertainment.

HOW TO SELECT AND LISTEN TO YOUR SONG

1. Press the SONG button to display the Song Select Menu Screen.
See the first Song Select menu screen shown below



Song Select	
Allegro	Anchors Awgh
Annie	Asia

2. Press the SCREEN RIGHT button to access subsequent pages in the Song Select menu screens until the abbreviated song name you would like to use is displayed.
For our example we pressed the screen right button twice

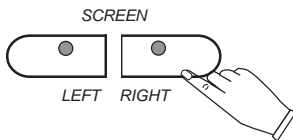

Song Select	
Ballgame	Battle Hymn
Bumble Bee	Chopin

3. Press the CURSOR Buttons to highlight the song you would like to select.

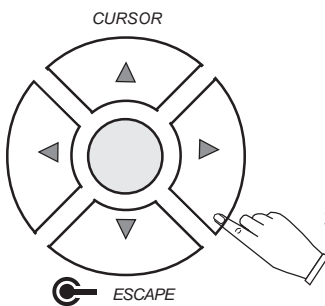

4. Press the Enter Button to select your desired Song.
The Play Along Song Lesson Menu Screen will appear as shown below

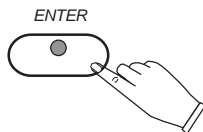

Bumble Bee	Measure
Play	RHnd=Y LHnd=Y Acmp=Y
Test	R=Y L=Y ♩ = 110

5. Press the Start/Stop Button or Play/Pause Button to listen to your selected song.

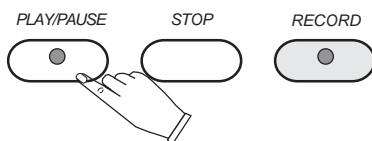

SONG - LESSON

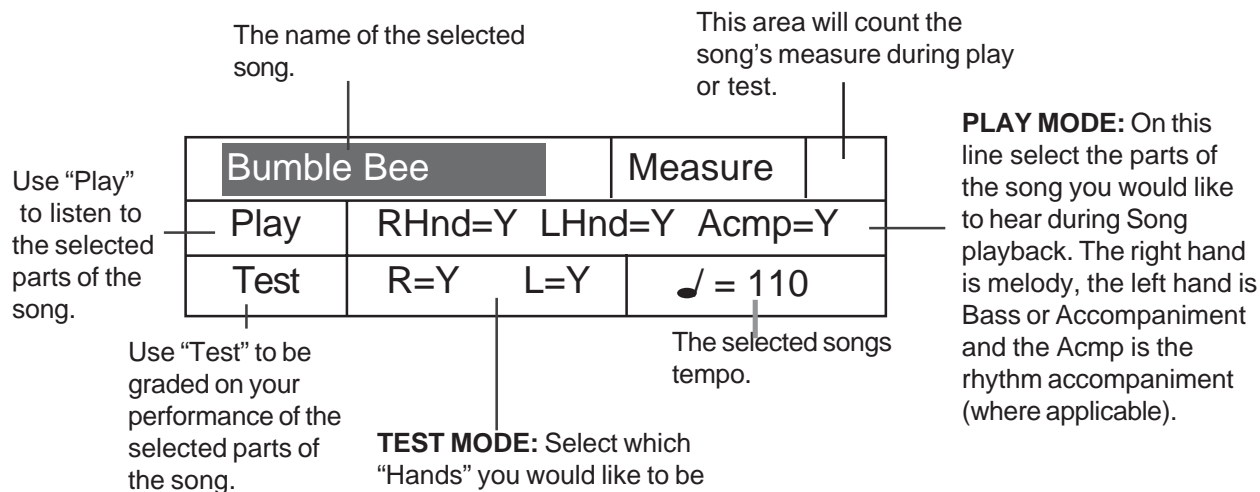

PLAY ALONG SONG - LESSONS

The Menu Screen Shown above lists many of the features of the Song Function.
Listed below is an example of how to access the various features of this Function.

USING THE LESSON FEATURE

From Song Selected Menu Screen Shown Above

EX: Test Left Hand Play (listen to right hand only and play left hand part)

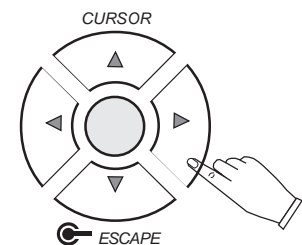

1. **Press the CURSOR Buttons to Highlight the L=Y Function.**
This function denotes which hand you would like to be tested on.
R = Right Hand
L = Left Hand
Y = Yes
N = No

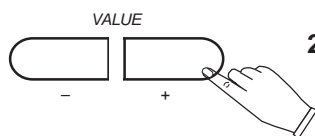

2. **Press the Value Button to select L=N (No).**
For our example we want L = N.
This indicates that we want to be tested on the Left Hand.

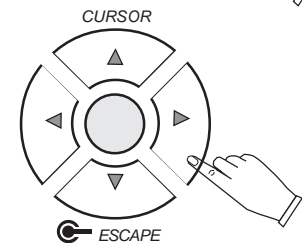

3. **Press the CURSOR Buttons to Highlight LHnd=Y.**
This function denotes which parts of the sound you will hear during your test.
RHnd=Right Hand Portion of the Song
LHnd=Left Hand Portion of the Song
Acmp=Rhythm Accompaniment Portion of the Song if applicable

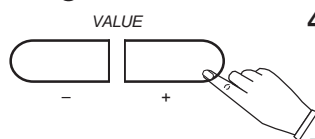

4. **Press the Value Button to select LHnd=N**
This denotes that we will not hear the Left Hand Portion of the Song when are tested playing along with the song.

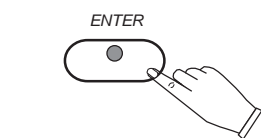

5. **Press the CURSOR Buttons to select the TEST mode.**
6. **Press the ENTER Button to begin the Test.**
The Metronome will count in and the Right Hand portion of the Song "Bumblebee" will begin to play. You should play the left hand portion of the song.

NOTE: Song Function must be in **TEST** mode to be Graded.

SONG - LESSON

LESSON FEATURES

TEST - Pressing the ENTER button engages the TEST mode when highlighted. You may test yourself on the right hand melody, the left hand accompaniment or both hands by highlighting the appropriate area and using the VALUE buttons to toggle those parts on, Y (Yes) or off, N (No).

TEST MODES

Right hand test - Select R=Y L=N.

Then highlight the TEST mode area and press the ENTER button. After the metronome sound the Left hand portion of the song and the auto accompaniment will playback (if applicable). You should play the right hand melody while listening to the Left Hand part.

Left hand test - Select R=N L=Y.

Then highlight the TEST mode area and press the ENTER button. After the metronome sound the Left hand portion of the song and the auto accompaniment will playback (if applicable). You should play the left hand part while listening to the Right Hand melody..

Right and Left hand exercise - Select R=Y L=Y.

Then highlight the TEST mode area and press the ENTER button. After the metronome sound you should play the piano parts of both hands. You will hear the rhythm accompaniment where applicable.

TEST RESULTS

You will hear a vocal grading when you finish your song in Test Mode. This vocal Grade will evaluate your performance. The vocal grades are "Try Again", "Good", "Very good" and "Excellent".

STOP THE SONG MODE

Press the SONG button to exit from the Song / Lesson course.

DISK

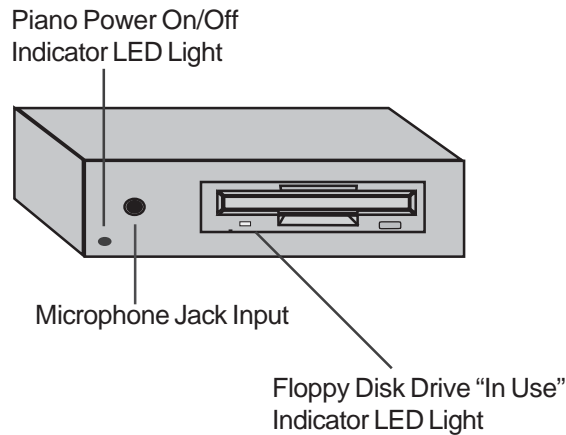

DISK FEATURES -

The Disk features allows you to Load Songs, Save Songs, Delete Song Files and Rename your song files.

INSERT THE DISK - Insert the 3.5" (**HD 1.4mb only**) disk into the disk drive with the label side up and the metal shutter leading into the drive. Slide the diskette into the drive until it clicks into place. The disk eject button on the drive pops out when the disk is properly inserted.

NOTE: This Piano only functions with HD (Hi Density) 1.4mb Floppy Disks. These HD 1.4mb disks are the only type currently sold in stores.

REMOVE THE DISK - To remove the diskette press the eject button on the disk drive.

NOTE: To avoid loss or damage to the disk or the disk drive, do not remove the disk drive from the unit, or turn the power off when the disk drive indicator light is on.

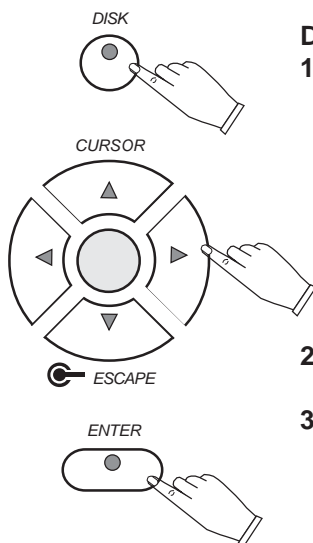

DISK MAIN MENU SCREEN

1. Press the DISK button to activate the Disk Menu screen. The Disk's Buttons LED Indicator will turn on.

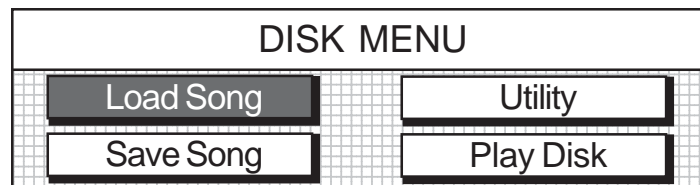

2. Use the CURSOR buttons to highlight the menu you would like to access.
3. Press the ENTER button to confirm your selection. Follow the instructions on the screen as they are displayed

DISK - LOAD SONG

Load Song -

Load Song retrieves one of your previously stored Music Performances or MIDI File songs from the floppy disk. Since the Standard MIDI file that you have on disk and your musical performance in the pianos music recorder share the same memory, selecting a song file may bring up a confirmation pop up screen, saying it will overwrite the song that is currently in the sequencer (music recorder).

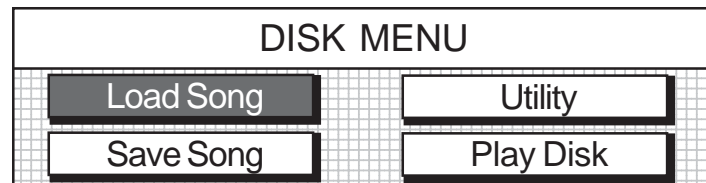

1. Place a Floppy Disk (HD 1.4mb) into the Disk Drive. Make sure that there are some of your previous musical performances on it or MIDI (SMF-Standard MIDI File) Format files on the floppy disk.
2. Press the Disk Button and select the **Load Song** menu. The list of song files contained on the disk will be displayed on the screen. If there are more than 4 songs on the disk, the SCREEN RIGHT/LEFT indicators will be lit. Press the Screen Right Button to access the additional song files on the disk.

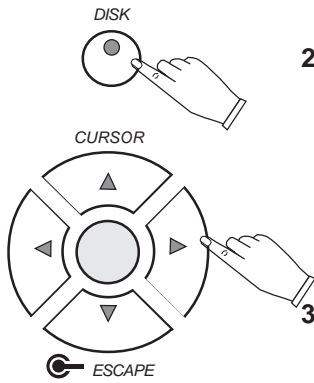

3. Using the Cursor Buttons highlight the song file you would like to load and press the ENTER button. **NOTE:** A caution screen will appear asking if you are sure you want to load the song file sequence.

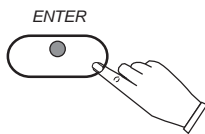

4. "OK" the command. A progress bar will be displayed showing the status of the load. A disk menu screen will be displayed after your selected song file has been loaded.

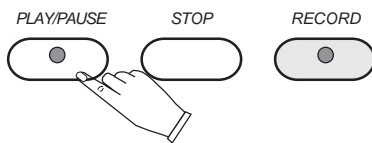

5. Press the START / STOP or the PLAY/PAUSE button. The song you have just loaded into the sequencer (music recorder) will begin to play.

DISK - SAVE SONG

SAVE SONG -

Save song function lets you save your musical performance data that you recorded in the 5 track music recorder (sequencer) and save it onto a floppy disk so that it can be accessed later.

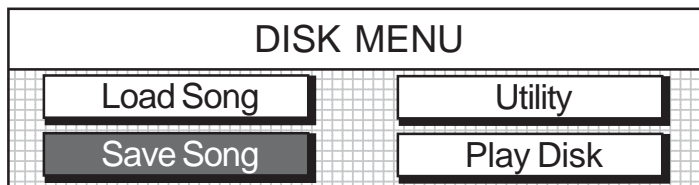

1. Make sure the floppy disk (HD 1.4mb) that you have selected has room to store song data files on it.
2. Select the Save Song Menu Item.
It's menu screen will be dedicated to naming the song (sequence) you want to save.
3. Use the VALUE buttons or Value Wheel to obtain the desired name by increments for each letter up or down.
NOTE: A caution screen will appear asking if you are sure you want to save the song file sequence.
4. "OK" the command to save the song to floppy disk.
A progress bar will be displayed showing the status of the save.
The main disk menu screen will be displayed after your selected song file has been saved.

DISK - PLAY DISK

PLAY DISK -

The Play Disk function lets you play all SMF MIDI Song Files that are on the floppy disk.

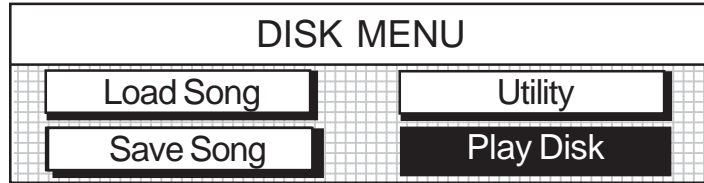

1. Place a Floppy Disk (HD 1.4mb) into the Disk Drive. Make sure that there are some of your previous musical performances on it or MIDI (SMF-Standard MIDI File) Format files on the floppy disk.
2. Press the Disk Button and select the **Play Disk** menu.
3. The music sequencer will automatically load the first MIDI File Song that is on the floppy disk and it will begin to play.
4. The music sequencer will load the second MIDI File Song after the first one has finished and it will begin to play.
5. The music sequencer will continue to play all songs listed in order on the floppy disk. It will repeat this Play Song Function until the Start/Stop Button is pressed.

DISK - PLAY DISK MENUS

Load Song Various Menu Screens -

Load Song function has various menu screens that allow you to view Song Lyrics and to play along with the disk.

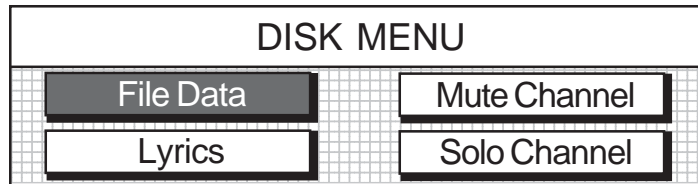

FILE DATA

The File Data Screen displays the song's MIDI file name and what Musical Instrument Voice for the piano has been selected. This Instrument Voice is called the Solo Instrument because you can solo by playing the piano keys while the MIDI song plays.

LYRICS

The Lyrics Screen displays the Lyrics of the Song that is being played. It will depend on your MIDI File Song if it has Lyrics attached to it or not.

NOTE: The Video Out Jack will supply this Lyric Screen to your TV when connected. See the Connector Panel section of this manual for more information.

MUTE CHANNEL

The Mute Channel Screen allows you to select certain individual tracks of your MIDI File Song to Mute.

Therefore depending on your Standard MIDI File Formatted Song you would be able to Mute the Bass or Melody Line of the Song if you so desired.

Mutable Channels are Channels 1 - 4.

SOLO CHANNEL

The Solo Channel Screen allows you to select certain individual tracks of your MIDI File Song to Solo on (play along with).

Therefore depending on your Standard MIDI File Formatted Song you would be able to Solo on one of four Channels.

Channels 1 - 4 are available for playing along with the MIDI Song.

DISK - UTILITY

UTILITY - Selecting Utility will access the Disk Utility Screen.

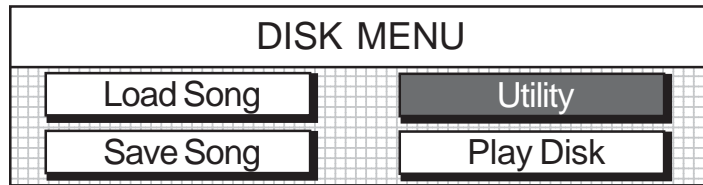

Use the Utility sub-menu to access the following options.

Format - Format prepares a new disk for use. Most Floppy disks have been formatted but if you happen to have a disk that is not formatted then data cannot be stored on it. Format will erase all previous files on a disk, so make sure you can afford to erase all the data on the floppy disk that you are formatting.

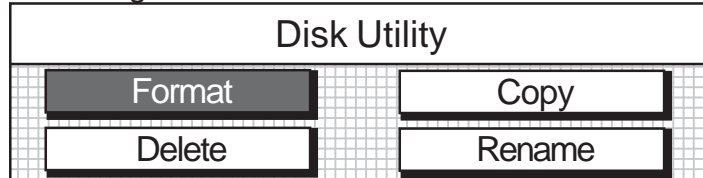

1. Load the disk into the disk drive. Make sure that the disk you have selected can be completely erased.
2. Select the Format menu, a progress bar will be displayed. When formatting is complete the main disk menu screen will be displayed.

Copy - Copy is used to duplicate a file from the disk.

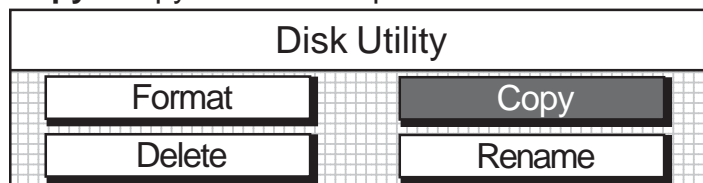

1. Load the disk into the disk drive. Make sure that the disk you have selected has the song data file you want to copy.
2. Select the Copy menu, the menu will show the available songs on the disk. If there are additional pages the indicator light on the SCREEN RIGHT/LEFT buttons will light.
3. Select the song you want to copy, and press the ENTER button.
4. Use the VALUE buttons or wheel to rename the copied song, a progress bar will be displayed. When copying is complete the main disk menu screen will be displayed.

UTILITY MENU - continued

Delete - Delete is used to remove unwanted files from the disk to make more space available.

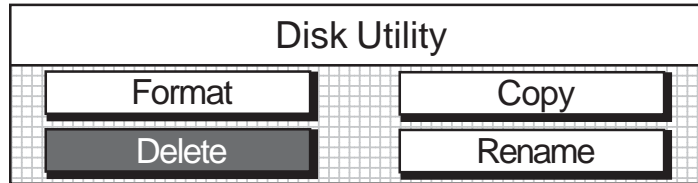

1. Load the disk into the disk drive. Make sure that the disk you have selected has the song data file you want to delete on the disk.
2. Select the Delete menu, the menu will show the available songs on the disk. If there are additional pages the indicator light on the SCREEN RIGHT/LEFT buttons will light.
3. Select the song that you want to delete, and press the ENTER button. A progress bar will be displayed. Once the file has been removed the main disk menu screen will be displayed. This file operation is irreversible.

Rename - Rename is used to change the name of a file already saved to the disk.

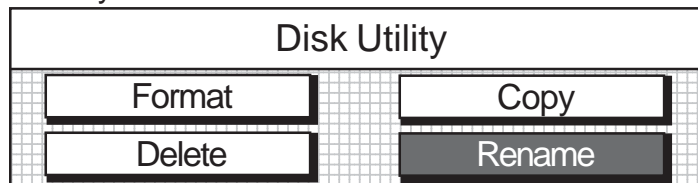

1. Load the disk into the disk drive. Make sure that the disk you have selected has song data files on it.
2. Select the Rename menu, the menu will show the available songs. If there are additional pages the indicator light on the SCREEN RIGHT/LEFT buttons will light.
3. Select the song you want to rename.
4. Use the VALUE buttons or wheel to rename the selected song.
5. Press the ENTER button to save the renamed song to floppy disk. A progress bar will be displayed. When renaming is complete the main disk menu screen will be displayed.

MIDI & VIDEO OUT JACKS

MIDI stands for Musical Instrument Digital Interface. This is a world wide standard communication interface that enables electronic musical instruments and computers (of all brands) to communicate with each other so that instructions and other data can pass between them. This exchange of information makes it possible to create a system of MIDI instruments and devices that offers far greater versatility and control than is available with isolated instruments. Whether you interface with computers, sequencers, expanders or other pianos your **Suzuki** piano's technical capabilities, and your musical horizons will be greatly enhanced.

For further information on MIDI and MIDI equipment please see the following pages and on the web visit Google.com and search under - Basic MIDI.

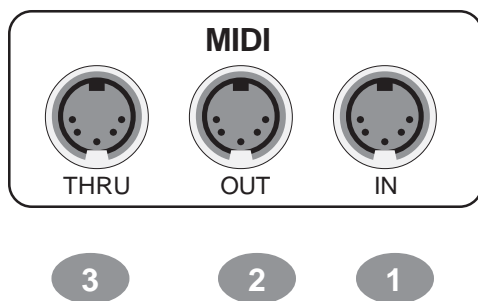

MIDI CONNECTION - The MIDI terminals are located on the bottom left portion of the piano

1. **MIDI In:** This terminal receives MIDI data from an external MIDI device.
2. **MIDI Out:** This terminal transmits data from this instrument to other MIDI devices. The transmitted data includes the note and touch velocity produced while playing on the piano, as well as voice changes, wheel operation, and recorded playback for the melody tracks. Demo songs and auto accompaniment are not transmitted.
3. **MIDI Thru** - This terminal transfers data from the IN terminal directly to other MIDI devices.

VIDEO OUTPUT - The Video Output Jack is located to the left of the MIDI terminals on bottom left of the piano.

1. **Video Out:** This terminal sends the NTSC (TV signal) to your RCA Jack Video Input terminal on your TV. The video output only sends the Karaoke Text information to your TV Screen

MIDI CHANNELS - The MIDI system in this unit has 16 channels numbered from 1-16. Each of the channels is responsible for a voice. When the instrument receives from an external device, the active channel is determined by the control message. The transmission channels on this piano are fixed as follows:

- Channel 1: Master voice
- Channel 2: Layer voice
- Channel 3: Split voice
- Channel 4: Bass in manual bass chord mode
- Channel 7: Chord in manual bass chord mode
- Channel 10: Percussion sound

Please see the MIDI Implementation Chart for more detail.

BASIC MIDI SETUPS

Output to an external sound generator - MIDI pianos transmit note and velocity (touch sensitivity) information via the MIDI Out connector. Connect the MIDI Out terminal of the piano and the MIDI IN terminal of an external device, piano, synthesizer, or sound module, and the external device should respond to your playing.

By connecting this **Suzuki** piano to another piano in this way you can essentially play two instruments at the same time or play on your piano to the sound of another MIDI device to produce thick, layered multi-instrument sounds.

Output from an external MIDI device - Connect the MIDI In terminal of the piano and the MIDI Out terminal of an external device. Data generated on another device can through your pianos sound delivery system.

Connect with a computer - Although the **Suzuki** piano offers a built in sequencer, the music recorder is a real-time five track sequencer, the same type of musical information transfer that is described above can be used for more sophisticated MIDI sequence recording using an external sequencer or computer. These devices could be used to record MIDI data received from this piano. You can transmit your performance to a computer to utilize advanced recording, composing and editing available from software on the computer. MIDI music stored on the computer can be played back through your instrument.

MIDI LOCAL CONTROL MODE - Local control refers to the fact that normally, this **Suzuki** piano controls the internal tone generator. This is the normal play mode. Local control can be turned off, so that the piano does not play the internal voices, however, the MIDI information is still transmitted via the MIDI Out connector when notes are played on the piano. At the same time, the internal tone generator can respond to MIDI data received via the MIDI In connector.

MIDI INPUT CHANNEL SELECTION - You may select an individual MIDI channel to receive MIDI data on. The power up default setting is the OMNI mode which receives MIDI data on all channels.

MIDI SPLIT INPUT LOWER CHANNEL MODE - This MIDI input channel mode is used to select which MIDI input channel you want to receive for the lower split piano MIDI data. The previous MIDI input mode will receive the upper split piano data.

MIDI OUTPUT CHANNEL SELECTION - You may select an individual MIDI channel to transmit MIDI data on. The power up default setting to transmit MIDI data is channel 1.

MIDI SLIT OUTPUT LOWER CHANNEL MODE - This MIDI output channel mode is used to select which MIDI output channel that you want to transmit on for the lower split piano data. This MIDI data can be sent separately on a discrete MIDI channel. The previous MIDI input mode will transmit the upper split piano data. The default setting for this mode transmits on channel two.

MIDI IMPLEMENTATION CHART

Function	Transmitted	Recognized	Remark
Basic Channel	1 CH	1-16 CH	
Channel changed	1-16 CH	1-16 CH	
Default Mode	3	3	
Note Number	9-120	0-127	
Velocity: Note On	●	●	
Velocity: Note Off	X	●	
Pitch Bender	●	●	
Control Change: 0	●	X	Variation page
1	X	X	Modulation
5	X	X	Portamento value
7, 10	●	●	Volume, Pan
11	X	●	Expression
64, 66, 67	●	●	Sustain, Sostenuto, Soft Pedal
65	X	X	Portamento yes/no
80, 81	●	●	Reverb, Chorus program
91	●	●	Reverb, Chorus send level
98, 99	X	X	NRPNL, NRPHH
100 ,101	X	X	RPNL, RPNH
121	●	●	Reset all controllers
123	●	●	All notes off
Program Change	0-127	0-127	
System Exclusive	X	X	
Sys. Common: Song Select	X	X	
Sys. Common: Song Position	X	X	
System: Clock	X	X	
Real Time: Commands	X	X	











Mode 1: OMNI ON, POLY
 Mode 2: OMNI ON, MONO
 Mode 3: OMNI OFF, POLY
 Mode 4: OMNI OFF, MONO

VOICE LIST

Please note: The MIDI program number for any voice listed is one less than the display number.

	Group A		Group B	
Piano				
	1 : Grand Piano 3 : Elec. Piano	2 : Bright Piano 4 : Honky Tonk Pno	5 : Rhodes Piano 7 : Harpsichord	6 : Chorus Piano 8 : Clavinet
Chromatic Percussion				
	9 : Celesta 11 : Music Box	10 : Glockenspiel 12 : Vibraphone	13 : Marimba 15 : Tubular Bells	14 : Xylophone 16 : Dulcimer
Organ				
	17 : Hammond Organ 19 : Rock Organ	18 : Percuss. Organ 20 : Church Organ	21 : Reed Organ 23 : Harmonica	22 : Accordion 24 : Tango Accdn
Guitar				
	25 : Nylon Guitar 27 : Jazz Guitar	26 : Steel Guitar 28 : Clean Guitar	29 : Muted Guitar 31 : Distortion Guitar	30 : Overdriven Gtr. 32 : Gtr. Harmonics
Bass				
	33 : Acoustic Bass 35 : Pick Bass	34 : Finger Bass 36 : Fretless Bass	37 : Slap Bass 1 39 : Synth Bass 1	38 : Slap Bass 2 40 : Synth Bass 2
Strings				
	41 : Violin 43 : Cello	42 : Viola 44 : Contrabass	45 : Tremolo Strings 47 : Orchestral Harp	46 : Pizzicato Strgs. 48 : Timpani
Ensemble				
	49 : String Ensmbl1 51 : Synth Strings 1	50 : String Ensmbl2 52 : Synth Strings 2	53 : Choir Aahs 55 : Synth Voice	54 : Voice Oohs 56 : Orchestra Hit
Brass				
	57 : Trumpet 59 : Tuba	58 : Trombone 60 : Muted Trumpet	61 : French Horn 63 : Synth Brass 1	62 : Brass Section 64 : Synth Brass 2
Reed				
	65 : Soprano Sax 67 : Tenor Sax	66 : Alto Sax 68 : Baritone Sax	69 : Oboe 71 : Bassoon	70 : English Horn 72 : Clarinet
Pipe				
	73 : Piccolo 75 : Recorder	74 : Flute 76 : Pan Flute	77 : Bottle Blow 79 : Whistle	78 : Shakuhachi 80 : Ocarina
Synth. Lead				
	81 : Square Lead 83 : Caliope Lead	82 : Sawtooth Lead 84 : Chiff Lead	85 : Charang Lead 87 : Fifth Lead	86 : Voice Lead 88 : Bass +Lead
Synth. Pad				
	89 : New Age Pad 91 : PolySynthPad	90 : Warm Pad 92 : Choir Pad	93 : Bowed Pad 95 : Halo Pad	94 : Metallic Pad 96 : Sweep Pad
Synth. Effects				
	97 : Rain 99 : Crystal	98 : Sound Track 100 : Atmosphere	01 : Brightness 103 : Echoes	102 : Goblins 104 : Sci-Fi
Ethnic				
	105 : Sitar 107 : Shamisen	106 : Banjo 108 : Koto1	09 : Kalimba 111 : Fiddle	110 : Bagpipe 112 : Shanai
Percussion				
	113 : Tinkle Bell 115 : Steel Drums	114 : Agogo 116 : Woodblock	117 : Taiko Drum 119 : Synth Drum	118 : Melodic Tom 120 : Rvrs. Cymbal
Sound Effects				
	121 : Gtr. Fret Noise 123 : Seashore	122 : Breath Noise 124 : Bird Tweet	125 : Phone Ring 127 : Applause	126 : Helicopter 128 : Gunshot

STYLE LIST

	Group A	Group B
BIG BAND <small>BIG BAND</small> 	1 : Big Band 1 3 : Latin Big Band	2 : Miller Band 4 : Broadway 5 : Orch. Waltz 6 : Jazz Waltz 7 : Jazz Band
BOSSA <small>BOSSA</small> 	8 : Cool Bossa 10 : Bossa Nova	9 : Pop Bossa 11 : Samba 12 : Salsa 13 : Tango
Swing <small>SWING</small> 	14 : Swing Trio 16 : Swingin' Organ	15 : Solo Piano Swing 17 : Dixie 18 : Lounge 19 : Jazz 20 : Swing
S. Ballad <small>S. BALLAD</small> 	21 : 50's Ballad 23 : Country Ballad	22 : Bolero 24 : Gospel Ballad 25 : Jazz Ballad
R & B <small>R & B</small> 	26 : Shuffle Blues 28 : Calypso	27 : Gospel Fast 29 : Reggae 1 30 : Reggae 2 31 : R&B Shuf 32 : R & B 33 : Motown
Acoustic <small>ACOUSTIC</small> 	34 : Hawaiiin 36 : Baroque	35 : Hula 37 : New Age 38 : Kids 1 39 : Kids 2 40 : March 41 : Polka
Pop <small>POP</small> 	42 : Bacharach 44 : Pop 16	43 : Funky Pop 45 : 8 Beat Pop 46 : Florida Keys 47 : Movie Th. 48 : Dance Pop 49 : Folk 50 : Disco
Oldies <small>OLDIES</small> 	51 : Hollywood 53 : Ragtime	52 : Stride Piano 54 : Solo Piano Boog 55 : Vienna Waltz 56 : Fox Trot 57 : Western Movie 58 : Boogie
Rock <small>ROCK</small> 	59 : Rock n Roll 61 : Bluegrass	60 : Jerry Lee 62 : Slow Blues 63 : Blues 64 : Country 65 : Country Waltz
Latin <small>LATIN</small> 	66 : Mambo Band 68 : Beguine	67 : Merenque 69 : Cha Cha 70 : Rhumba

DRUM KIT LIST

DRUM KIT LIST 1

Please note: In the first title row the number in the bracket, after the kit name, is the MIDI program number. The Drum kits name and number that are shown on the LCD display are listed in the second title row. The "No." refers to MIDI note number, and "Key" refers to the key on the piano. A blank space in the table mean there is no sound there. Keys from A0 to D1 sound as timpani, except for in Kit 9, the effects kit. Keys from E6 to C8 sound the same as the D#1 to B6 keys.

No.-Key	Standard (0) P-1: Standard	Room (8) P-2: Room	Power (16) P-3: Power	Electronic (24) P-4: Electronic	TR-808 (25) P-5: TR-808
27-E ^b 1	High Q	High Q	High Q	High Q	High Q
28-E1	Slap	Slap	Slap	Slap	Slap
29-F1	Scratch Push	Scratch Push	Scratch Push	Scratch Push	Scratch Push
30-F#1	Scratch Pull	Scratch Pull	Scratch Pull	Scratch Pull	Scratch Pull
31-G1	Stick	Stick	Stick	Stick	Stick
32-G#1	Square Click	Square Click	Square Click	Square Click	Square Click
33-A1	Metronome Click	Metronome Click	Metronome Click	Metronome Click	Metronome Click
34-B ^b 1	Metronome Bell	Metronome Bell	Metronome Bell	Metronome Bell	Metronome Bell
35-B1	Kick Drum 2	Kick Drum 2	Kick Drum 2	Kick Drum 2	Kick Drum 2
36-C2	Kick Drum 1	Kick Drum 1	Power Kick Drum	Elec Kick Drum	Synth Kick Drum 1
37-C#2	Side Stick	Side Stick	Side Stick	Side Stick	Synth Side Stick
38-D2	Snare Drum 2	Snare Drum 2	Power Snare Drum 2	Elec Snare Drum 2	Synth Snare Drum
39-E ^b 2	Hand Clap	Hand Clap	Hand Clap	Hand Clap	Hand Clap
40-E2	Snare Drum 1	Snare Drum 1	Power Snare Drum 1	Power Snare Drum 1	Snare Drum 1
41-F2	Low Floor Tom 2	Room Low Floor Tom 2	Low Floor Tom 2	Elec Low Floor Tom 2	Synth Low Floor Tom 2
42-F#2	Close Hi-hat	Close Hi-hat	Close Hi-hat	Close Hi-hat	Synth Close Hi-hat
43-G2	Low Floor Tom 1	Room Low Floor Tom 1	Low Floor Tom 1	Elec Low Floor Tom 1	Synth Low Floor Tom 1
44-G#2	Pedal Hi-hat	Pedal Hi-hat	Pedal Hi-hat	Pedal Hi-hat	Synth Pedal Hi-hat
45-A2	Low Tom	Room Low Tom	Low Tom	Elec Low Tom	Synth Low Tom
46-B ^b 2	Open Hi-hat	Open Hi-hat	Open Hi-hat	Open Hi-hat	Synth Open Hi-hat
47-B2	Low-mid Tom	Room Low-mid Tom	Low-mid Tom	Elec Low-mid Tom	Synth Low-mid Tom
48-C3	Hi-mid Tom	Room Hi-mid Tom	Hi-mid Tom	Elec Hi-mid Tom	Synth Hi-mid Tom
49-C#3	Crash Cymbal 1	Crash Cymbal 1	Crash Cymbal 1	Crash Cymbal 1	Synth Crash Cymbal 1
50-D3	High Tom	Room High Tom	High Tom	Elec High Tom	Synth High Tom
51-E ^b 3	Ride Cymbal 1	Ride Cymbal 1	Ride Cymbal 1	Ride Cymbal 1	Ride Cymbal 1
52-E3	Chinese Cymbal	Chinese Cymbal	Chinese Cymbal	Reverse Cymbal	Chinese Cymbal
53-F3	Ride Bell	Ride Bell	Ride Bell	Ride Bell	Ride Bell
54-F#3	Tambourine	Tambourine	Tambourine	Tambourine	Tambourine
55-G3	Splash Cymbal	Splash Cymbal	Splash Cymbal	Splash Cymbal	Splash Cymbal
56-G#3	Cowbell	Cowbell	Cowbell	Cowbell	Cowbell
57-A3	Crash Cymbal 2	Crash Cymbal 2	Crash Cymbal 2	Crash Cymbal 2	Crash Cymbal 2
58-B ^b 3	Vibra Slap	Vibra Slap	Vibra Slap	Vibra Slap	Vibra Slap
59-B3	Ride Cymbal 2	Ride Cymbal 2	Ride Cymbal 2	Ride Cymbal 2	Ride Cymbal 2
60-C4	Hi Bongo	Hi Bongo	Hi Bongo	Hi Bongo	Hi Bongo
61-C#4	Low Bongo	Low Bongo	Low Bongo	Low Bongo	Low Bongo
62-D4	Mute Conga	Mute Conga	Mute Conga	Mute Conga	Mute Conga
63-E ^b 4	Hi Conga	Hi Conga	Hi Conga	Hi Conga	Hi Conga
64-E4	Low Conga	Low Conga	Low Conga	Low Conga	Low Conga
65-F4	High Timbale	High Timbale	High Timbale	High Timbale	High Timbale
66-F#4	Low Timbale	Low Timbale	Low Timbale	Low Timbale	Low Timbale
67-G4	High Agogo	High Agogo	High Agogo	High Agogo	High Agogo
68-G#4	Low Agogo	Low Agogo	Low Agogo	Low Agogo	Low Agogo
69-A4	Cabasa	Cabasa	Cabasa	Cabasa	Cabasa
70-B ^b 4	Maracas	Maracas	Maracas	Maracas	Maracas
71-B4	Short Whistle	Short Whistle	Short Whistle	Short Whistle	Short Whistle
72-C5	Long Whistle	Long Whistle	Long Whistle	Long Whistle	Long Whistle
73-C#5	Short Guiro	Short Guiro	Short Guiro	Short Guiro	Short Guiro
74-D5	Long Guiro	Long Guiro	Long Guiro	Long Guiro	Long Guiro
75-E ^b 5	Claves	Claves	Claves	Claves	Claves
76-E5	Hi Wood Block	Hi Wood Block	Hi Wood Block	Hi Wood Block	Hi Wood Block
77-F5	Low Wood Block	Low Wood Block	Low Wood Block	Low Wood Block	Low Wood Block
78-F#5	Mute Cuica	Mute Cuica	Mute Cuica	Mute Cuica	Mute Cuica
79-G5	Open Cuica	Open Cuica	Open Cuica	Open Cuica	Open Cuica
80-G#5	Mute Triangle	Mute Triangle	Mute Triangle	Mute Triangle	Mute Triangle
81-A5	Open Triangle	Open Triangle	Open Triangle	Open Triangle	Open Triangle
82-B ^b 5	Cabasa	Cabasa	Cabasa	Cabasa	Cabasa
83-B5	Shaker	Shaker	Shaker	Shaker	Shaker
84-C6	Belltree	Belltree	Belltree	Belltree	Belltree
85-C#6	Castanets	Castanets	Castanets	Castanets	Castanets
86-D6	Mute Surdo	Mute Surdo	Mute Surdo	Mute Surdo	Mute Surdo
87-E ^b 6	Open Surdo	Open Surdo	Open Surdo	Open Surdo	Open Surdo

DRUM KIT LIST

DRUM KIT LIST 2

Please note: In the first title row the number in the bracket, after the kit name, is the MIDI program number. The Drum kits name and number that are shown on the LCD display are listed in the second title row. The "No." refers to MIDI note number, and "Key" refers to the key on the piano. A blank space in the table mean there is no sound there. Keys from A0 to D1 sound as timpani, except for in Kit 9, the effects kit. Keys from E6 to C8 sound the same as the D#1 to B6 keys.

No.-Key	Jazz (32) P-6: Jazz	Brush (40) P-7: Brush	Orchestra (48) P-8: Orchestra	Effects (56) P-10: SFX
27-E ^b 1	High Q	High Q	High Q	
28-E1	Slap	Slap	Slap	
29-F1	Scratch Push	Scratch Push	Scratch Push	
30-F#1	Scratch Pull	Scratch Pull	Scratch Pull	
31-G1	Stick	Stick	Stick	
32-G#1	Square Click	Square Click	Square Click	
33-A1	Metronome Click	Metronome Click	Metronome Click	
34-B ^b 1	Metronome Bell	Metronome Bell	Metronome Bell	
35-B1	Jazz Bass Drum	Jazz Bass Drum	Orche Bass Drum 2	
36-C2	70 Bass Drum 1	70 Bass Drum	Orche Bass Drum 1	
37-C#2	Side Stick	Side Stick	Side Stick	
38-D2	Snare Drum 2	Brush Tap	Orche Snare Drum 2	
39-E ^b 2	Hand Clap	Brush Slap	Hand Clap	High-Q
40-E2	Snare Drum 1	Brush Swirl	Orche Snare Drum 1	Slap
41-F2	Low Floor Tom 2	Low Floor Tom 2	Timpani F	Scratch Push
42-F#2	Close Hi-hat	Close Hi-hat	Timpani F#	Scratch Pull
43-G2	Low Floor Tom 1	Low Floor Tom 1	Timpani G	Stick
44-G#2	Pedal Hi-hat	Pedal Hi-hat	Timpani G#	Square Click
45-A2	Low Tom	Low Tom	Timpani A	Metronome Click
46-B ^b 2	Open Hi-hat	Open Hi-hat	Timpani A#	Metronome Bell
47-B2	Low-mid Tom	Low-mid Tom	Timpani B	Gr. Cut Noise1 (down)
48-C3	Hi-mid Tom	Hi-mid Tom	Timpani C	Gr. Cut Noise2 (up)
49-C#3	Crash Cymbal 1	Crash Cymbal 1	Timpani C#	Bass Slap
50-D3	High Tom	High Tom	Timpani D	Bass Pick
51-E ^b 3	Ride Cymbal 1	Ride Cymbal 1	Timpani D#	Key Click
52-E3	Chinese Cymbal	Chinese Cymbal	Timpani E	Laughing
53-F3	Ride Bell	Ride Bell	Timpani F	Screaming
54-F#3	Tambourine	Tambourine	Tambourine	Punch
55-G3	Splash Cymbal	Splash Cymbal	Splash Cymbal	Heart Beat
56-G#3	Cowbell	Cowbell	Cowbell	Footstep 1
57-A3	Crash Cymbal 2	Crash Cymbal 2	Orche Crash Cymbal	Footstep 2
58-B ^b 3	Vibra Slap	Vibra Slap	Vibra Slap	Applause
59-B3	Ride Cymbal 2	Ride Cymbal 2	Orche Cymbal	Door Creaking
60-C4	Hi Bongo	Hi Bongo	Hi Bongo	Door Closing
61-C#4	Low Bongo	Low Bongo	Low Bongo	Scratch
62-D4	Mute Conga	Mute Conga	Mute Conga	Wind Chime
63-E ^b 4	Hi Conga	Hi Conga	Hi Conga	Car Engine Starting
64-E4	Low Conga	Low Conga	Low Conga	Car Crash
65-F4	High Timbale	High Timbale	High Timbale	Car Pass
66-F#4	Low Timbale	Low Timbale	Low Timbale	Police Siren
67-G4	High Agogo	High Agogo	High Agogo	Train
68-G#4	Low Agogo	Low Agogo	Low Agogo	Jet Plane
69-A4	Cabasa	Cabasa	Cabasa	Helicopter
70-B ^b 4	Maracas	Maracas	Maracas	Starship
71-B4	Short Whistle	Short Whistle	Short Whistle	Gun Shot
72-C5	Long Whistle	Long Whistle	Long Whistle	Laser Gun
73-C#5	Short Guiro	Short Guiro	Short Guiro	Explosion
74-D5	Long Guiro	Long Guiro	Long Guiro	Horse Gallop
75-E ^b 5	Claves	Claves	Claves	Birds
76-E5	Hi Wood Block	Hi Wood Block	Hi Wood Block	Rain
77-F5	Low Wood Block	Low Wood Block	Low Wood Block	Thunder
78-F#5	Mute Cuica	Mute Cuica	Mute Cuica	Wind
79-G5	Open Cuica	Open Cuica	Open Cuica	Sea Shore
80-G#5	Mute Triangle	Mute Triangle	Mute Triangle	Stream
81-A5	Open Triangle	Open Triangle	Open Triangle	Bubble
82-B ^b 5	Cabasa	Cabasa	Cabasa	
83-B5	Shaker	Shaker	Shaker	
84-C6	Belltree	Belltree	Belltree	
85-C#6	Castanets	Castanets	Castanets	
86-D6	Mute Surdo	Mute Surdo	Mute Surdo	
87-E ^b 6	Open Surdo	Open Surdo	Open Surdo	

SPECIFICATIONS

SPECIFICATIONS

PIANO

88-note, hammer-action piano

POLYPHONY: 64

VOICES

128 Voices

16 quick select voice buttons

VOICE MODE

Upper

Layer (dual) voice

Lower (split) voice

AUTO ACCOMPANIMENT STYLE

70 Auto accompaniment styles

ten quick select style buttons

AUTO BASS CHORD MODE

One Finger

Fingered

Piano

Off

CONTROLS

Power: On/Off

Main Volume Control: Min-Max

Bass Level

Treble Level

Microphone Volume Level

Microphone Echo Level

Accomp Volume/Piano Volume Balance

DISPLAY: Graphic Backlit LCD

REGISTRATION MEMORY: 24

DEMONSTRATION: 13 songs plus

55 Lesson songs

RECORDING: Four melody tracks and one accompaniment track

ACCOMPANIMENT CONTROL

Synchronized Start

Introduction/Ending

Start/Stop

Fill-In

Fill to Variation

Fade

Auto harmony (three types)

SETUP CONTROL

Performance: Velocity, Split point, Transpose, Screen Hold, Tune, Fixed Level, Fade Time, Octave Shift

Key Mode: Manual Bass, Lower Hold

Harmony: Trio, Duet, Octave

Sustain: Upper, Layer, Lower

Reverb: 8 Reverb settings, Upper, Layer, Lower Levels

Effects: 8 Effects settings, Upper, Layer, Lower Levels

Chord (Accomp Finger Mode): One Finger, Fingered, Piano, OFF

Pedal Assign: Start/Stop, Fill, Intro/Ending, Lower Hold

Percussion Setup: OFF, 8 Drum Kits, 1 Sound Effect Kit

Metronome Setup: Time Signature, Tempo, Sound, Volume

AUXILIARY JACKS

Headphone x 2

Line Out

Power In

MIDI In/Out

PEDALS

Sustain Pedal

Assignable Function Pedal

Soft Pedal

VOLTAGE: AC 120V

AMPLIFIER: 60W X 60W, 4 speakers

DIMENSIONS

58.5"W X 23.5"D X 34"H

WEIGHT: 235 lbs

STANDARD ACCESSORIES

AC Chord

Owner's manual

OPTIONAL ACCESSORIES

Matching Bench

Headphones

QUESTIONS

QUESTIONS AND/OR PROBLEMS

Where is the serial number on my piano?

The serial number of the piano should be directly underneath the piano on the right hand side near the floppy disk drive.

Where can I buy recorded disks to play in my piano?

Visit www.suzukimusic.com/hg-425e.

You may purchase from other outlets but please remember to order only Standard MIDI File (SMF) floppy disks.

Problem: Power is not coming on. —

1. Check to make sure that the Piano is plugged into the AC Outlet Properly.
2. Have qualified technician check fuses under top lid
3. Call Suzuki customer service department (858-566-9710) for assistance

Problem: Keyboard's Control Panel Buttons don't operate or operate strangely.

1. Please see the next pages for how to do a Hard Reset on your Piano.
2. Call Suzuki customer service department (858-566-9710) for assistance

Problem: All pedals do not work. —

1. Check that the pedalrods are properly aligned beneath the piano.
2. Call Suzuki customer service department (858-566-9710) for assistance

Problem: "Blue screen" no control panel lights. —

1. Please see the next pages for how to do a Hard Reset on your Piano.
2. Have a qualified technician check fuses under top lid
3. Call Suzuki customer service department (858-566-9710) for assistance

Problem: How do you perform a "hard reset" —

Just like with your home computer, every now and then you may have to perform a Hard Reset on your Piano to clear its memory of any software conflicts.

With unit turned off depress and hold down the 2 tempo buttons. Turn power on while holding the 2 buttons for 10 seconds.

Piano will now be at its factory default settings.

All user memory has also been reset and therefore erased.

Problem: Disk Drive is not working. —

1. Try one of the Suzuki Demonstration Floppy Disks
2. Call Suzuki customer service department for assistance

Problem: Piano does power up, but no sound is heard. —

1. Make sure that the Balance Slider Knob is in the center position
2. Check theadphone connection to see if headphones are plugged in.
3. Test the piano with Headphones for sound
4. Call Suzuki customer service department for assistance

Problem: Disk drive seems too slow on play back. —

1. Try using a different floppy disk.
2. Call Suzuki customer service department for assistance.

Problem: There are no lyrics being displayed on the screen. —

1. Try a known working floppy disk that has lyric files not just song files
2. Press Lyric LCD Screen Menu Button to display the lyrics
3. Call Suzuki customer service department for assistance

NOTES

WARRANTY

This product, except the exterior cosmetic parts, is warranted by the Suzuki Corporation to the original purchaser to be free from defects in material and workmanship under normal use as follows:

- 1. For a period of one year from the date of purchase, the Suzuki Corporation will pay the labor charges to repair the defective product. After this one year period, you must pay all labor charges.**
- 2. In addition, the Suzuki Corporation will supply, at no charge, new or rebuilt replacements for defective parts for a period of one year from the date of purchase.**

In the event repairs are needed, the original purchaser will return the product to an Authorized Suzuki Retail Center with the proof of purchase. The dealer will then repair the product or return it to the Suzuki distribution center in San Diego, California for repairs. Upon completion of the repair, the unit will be returned to the customer. This warranty will not apply to this product if it has been misused, abused, or altered. This warranty is void if the product has been opened. Without limiting the foregoing, bending, dropping of unit, or visible cracks and/or scratches are presumed to be defects resulting from misuse or abuse.

Neither this warranty nor any other warranty expressed or implied, including implied warranties of merchantable, shall extend beyond the warranty period. No responsibility is assumed for any incidental or consequential damages.

In the United States Contact:

Suzuki Corporation
San Diego Distribution Center
P.O. Box 261030
San Diego, CA 92196

In all other Countries Contact: Original retailer where product was purchased for additional warranty details.

SUZUKI

**Composer
Ensemble**

HP-275e

OWNER'S MANUAL



P.O. BOX 261030
SAN DIEGO, CALIFORNIA 92196
(858) 566-9710

Visit us on the web at www.suzukimusic.com

Copyright 2004 Suzuki Musical Instrument Corporation

Free Manuals Download Website

<http://myh66.com>

<http://usermanuals.us>

<http://www.somanuals.com>

<http://www.4manuals.cc>

<http://www.manual-lib.com>

<http://www.404manual.com>

<http://www.luxmanual.com>

<http://aubethermostatmanual.com>

Golf course search by state

<http://golfingnear.com>

Email search by domain

<http://emailbydomain.com>

Auto manuals search

<http://auto.somanuals.com>

TV manuals search

<http://tv.somanuals.com>