

Assembly Instruction
Grill Gazebo with Terra Cotta Canopy
Item#:L-GG001PST-F

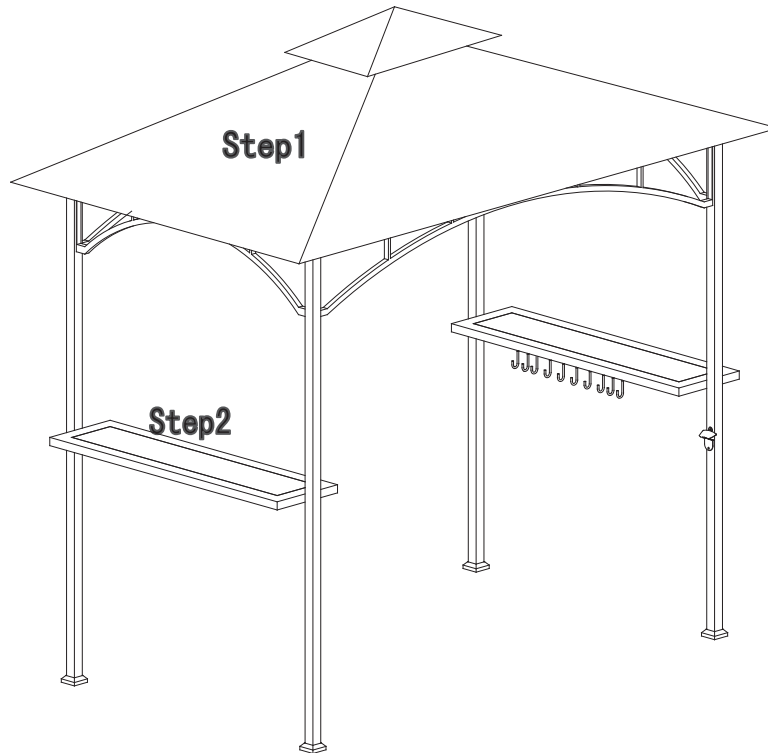

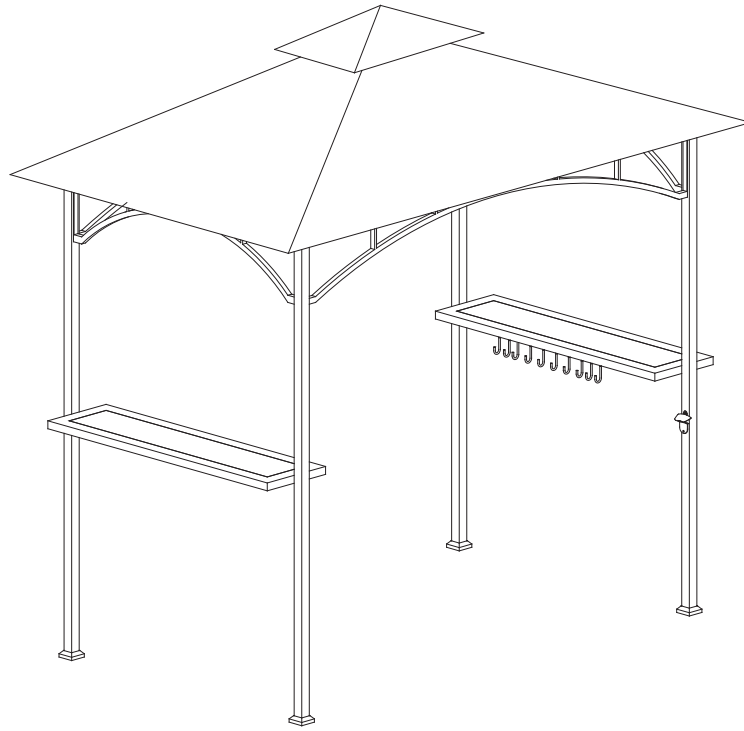







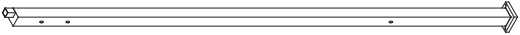
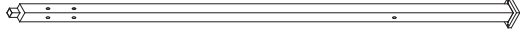
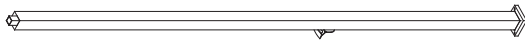

IMPORTANT:

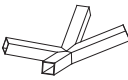
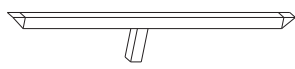
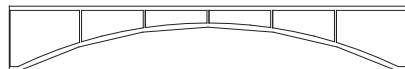
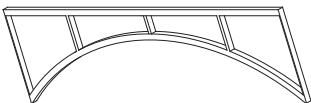
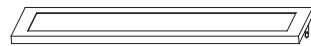
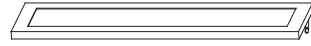
1. When installing and assembling your gazebo, it is recommended that two or more adults are involved.
2. Do not use the gazebo during an electrical storm, as there is a remote chance of getting struck by lightning.
3. Do not climb on top of the gazebo. Falling off the gazebo can result in serious injury, possibly even death.
4. Do not leave the gazebo assembled when there is a risk of high wind, as possible damage will occur to the structure.
5. Do not use lanterns that contain open flames.
6. This package contains small items and plastic bags that should be kept away from children.
7. Ensure that all connectors & poles are firmly secured in position fully. It is important to do so before use so as to avoid collapsing or damage to the item, which could result in injury.
8. KEEP ALL FLAME AWAY FROM THIS SHELTER FABRIC. The fabric may burn if it is exposed to prolonged contact with a flame source. The application of any foreign substance to the fabric may render the flame-resistant properties ineffective.

USE & CARE:

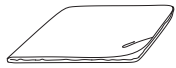
1. This gazebo is not a permanent structure and should be disassembled & stored away after use.
2. Do not repack your gazebo until completely dry.
3. This gazebo must not be left erect in windy conditions.
4. Steel components for garden accessories and furniture are treated with rust inhibiting paint that protects them from rust. However, due to the nature of steel, surface oxidation (rusting) will occur if this protective coating is scratched. This is a natural process. To minimize this condition, it is recommended that care be taken when assembling and handling the product in order to prevent the paint from being scratched. Surface rust can be removed easily using a very light application of common cooking oil. If surface oxidation (rusting) occurs and no measures are taken to correct it, the oxidation may start dripping onto the deck or patio, which may cause damaging stains that may be difficult to remove.

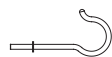
Parts List

Post (1)	A1	2	
Post (2)	A2	1	
Post (3)	A3	1	
Big Beam	B	4	
Big Connector	C	1	
Small Beam	D	4	
Long Screen	E	2	
Short Screen	F	2	
Glass Panel	G1	1	
Glass Panel	G2	1	
Hook rack	H	1	
Bolt	I	20	
Bolt	II	3	
Big Canopy	J	1	
Small Canopy	K	1	
Hook	L	1	
LED Light	M	4	
Batteries 7#	N	12	

Step 1

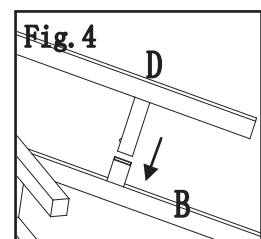
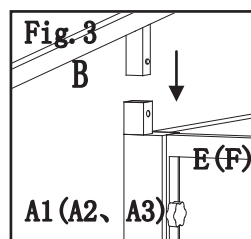
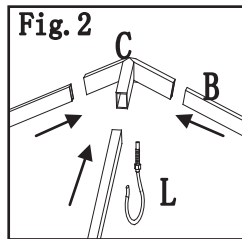
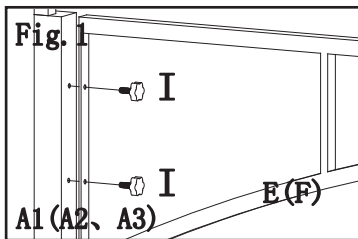
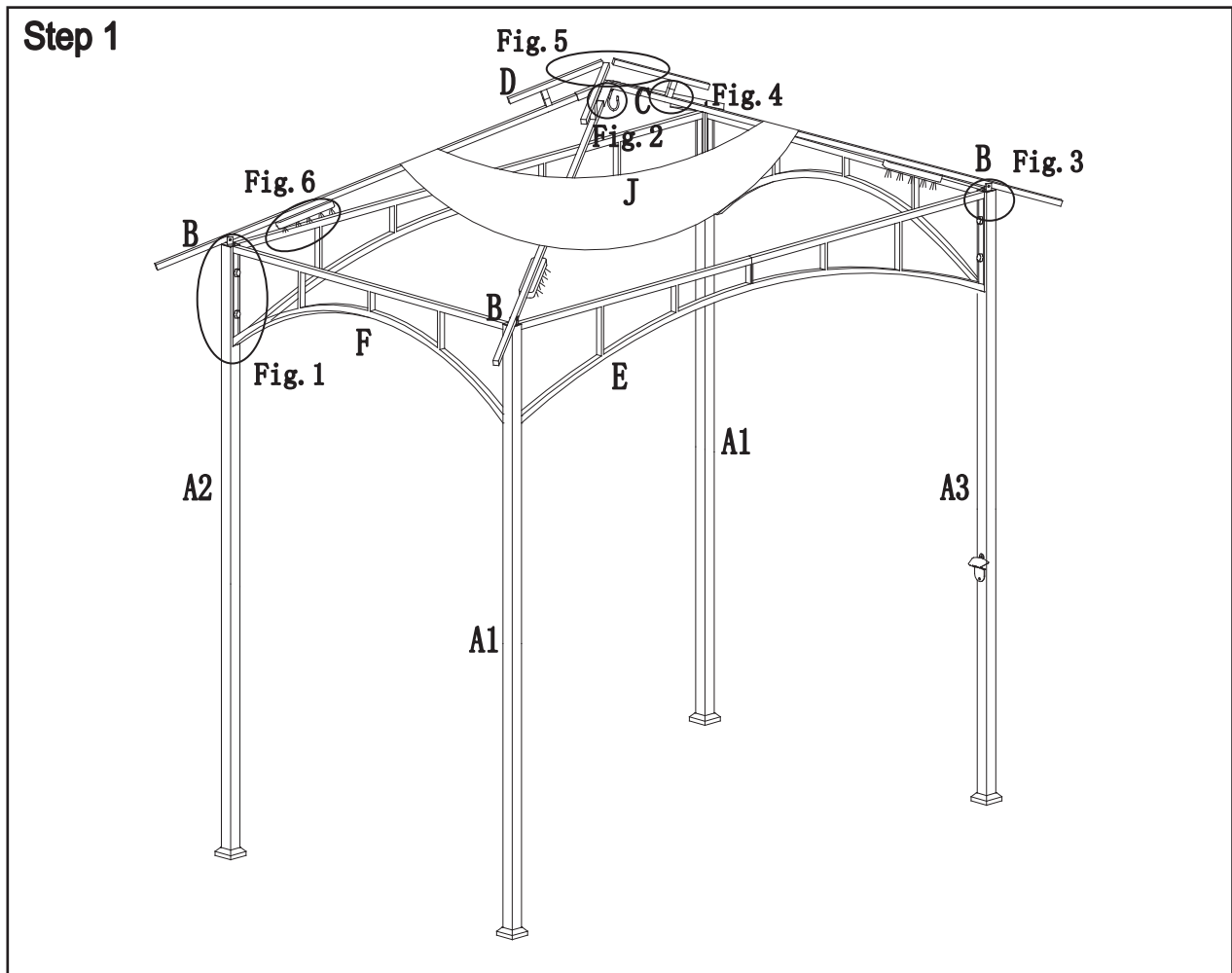

Fig. 1: Attach the Long Screen (E) and the Short Screen (F) to Post (A1, A2, A3) with the Bolt (I).

Fig. 2: Attach the Big Beam (B) to the Big Connector (C), and then attach the Hook (H) to the Big Connector (C).

Fig. 3: Insert the connector of the Big Beam (B) into the intubation tube of Post (A1, A2, A3), then put the Big Canopy (J) on big top, do not fully spread.

Fig. 4: Insert the bottom connector of the Small Beam (D) to the upper pole of the Big Beam (B).

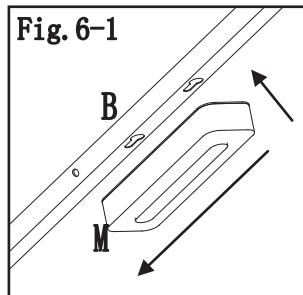
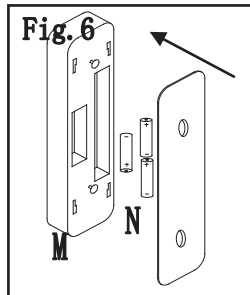
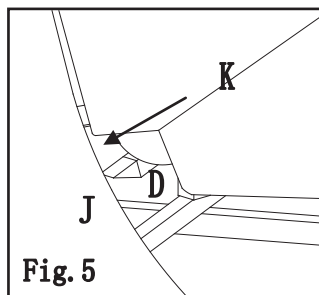



Fig. 5: Extend the Small Canopy (K) onto the small top by fixing the canopy at four corners of top.

Fig. 6: Take off the back cover of LED light (M), and match batteries (N) into sockets. Attach back cover to LED light (M).

Fig. 6-1: Hang the assembled LED light (M) into holes of Beam (B) (Note: Pull down forward tightly after LED lights hung into Beam holes).

Hardware Pack

FF	Φ 6X180MM Floor Nail	8PCS	
----	----------------------	------	---

Step 2

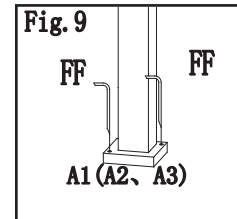
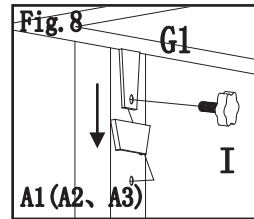
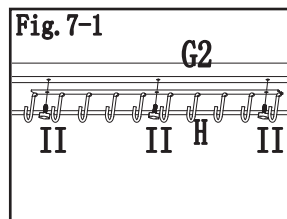
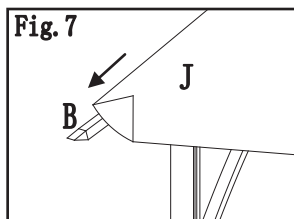
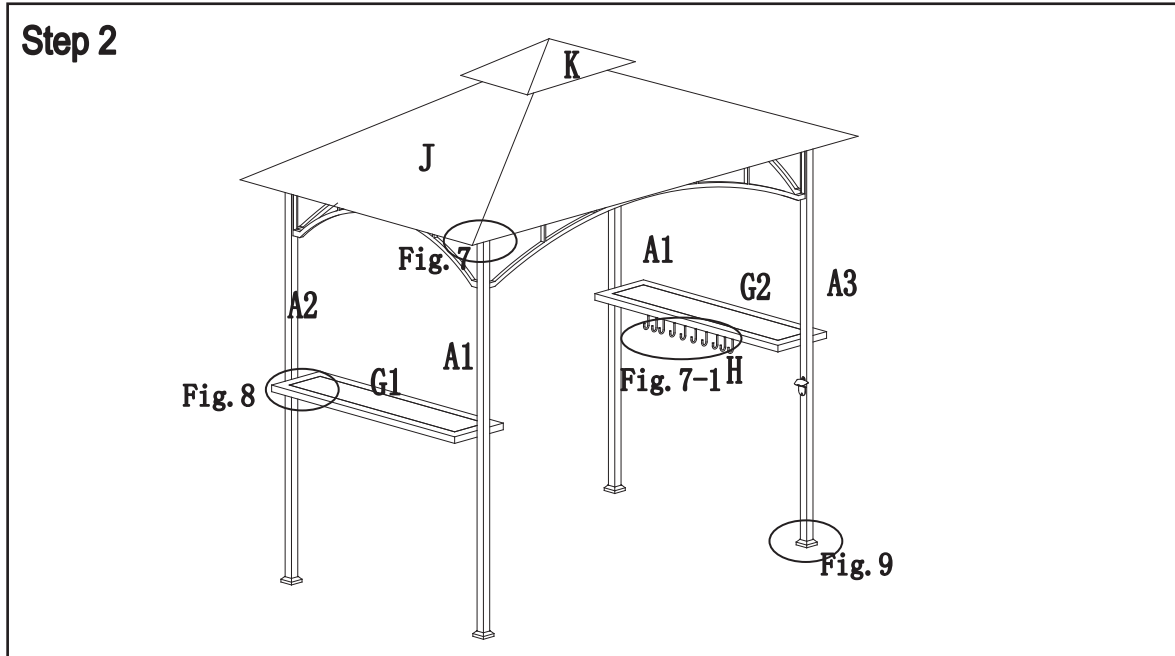

Fig.7: Extend the Big Canopy (J) onto the big top by fixing the canopy at four corners of top.

Fig.7-1: Attach the Hook (H) to Glass Panel (G2) with the Bolt (II).

Fig.8: Insert the Glass Panel (G1, G2) into the Post (A1, A2, A3), then attached them tightly with the Bolt (I).

Fig.9: Fix the gazebo to the lawn by using the Floor Nail (FF).

IMPORTANT:

Please do not return this product to the store. For technical assistance on assembly or replacement parts. Please call Sunjoy Industries at 1-866-578-6569 from 8:00 am EST to 8:00 pm PST or fax the replacement part form which is in the box to 1-740-283-3549 or Email customer.care@sunjoygroup.com for assistance.

Free Manuals Download Website

<http://myh66.com>

<http://usermanuals.us>

<http://www.somanuals.com>

<http://www.4manuals.cc>

<http://www.manual-lib.com>

<http://www.404manual.com>

<http://www.luxmanual.com>

<http://aubethermostatmanual.com>

Golf course search by state

<http://golfingnear.com>

Email search by domain

<http://emailbydomain.com>

Auto manuals search

<http://auto.somanuals.com>

TV manuals search

<http://tv.somanuals.com>