

T-fal®

EASY PRO



www.t-fal.com

IMPORTANT SAFEGUARDS

When using fryer, basic safety precautions should always be followed, including the following:

1. Read all instructions before using.
2. Do not touch hot surfaces. Use handles or knobs.
3. To protect against electric shock, do not immerse cord, plugs or fryer in water or other liquid.
4. Close supervision is necessary when the fryer is used by or near children.
5. Unplug from outlet when not in use and before cleaning. Allow to cool before putting on or taking off parts, and before cleaning the fryer.
6. Do not operate the fryer with a damaged cord or plug or after the fryer malfunctions, or has been damaged in any manner. Return the fryer to the nearest authorized service facility for examination, repair or adjustment.
7. The use of accessory attachments not recommended by the fryer manufacturer may cause injuries.
8. Do not use outdoors.
9. Do not let cord hang over edge of table or counter, or touch hot surfaces.
10. Do not place on or near a hot gas or electric burner, or in a heated oven.
11. Extreme caution must be used when moving fryer containing hot oil.
12. Always attach plug to the fryer first (depending on model), then plug cord in the wall outlet. To disconnect, turn any control to "off", then remove plug from wall outlet.
13. Do not use the fryer for other than intended use.
14. Be sure handles are properly assembled to basket and locked in place. See detailed assembly instructions. Ensure the two metallic parts of the basket handle are correctly positioned before locking the handle on the basket.

15. **Save these instructions. For household use only.**

16. Before use, check that your local voltage corresponds with the specifications shown on the appliance nameplate located under the fryer.
17. Only connect the appliance to electrical sockets which have a minimum load of 15A. If the sockets and the plug on the appliance should prove incompatible, get a professionally qualified technician to replace the socket with a more suitable one.
18. This electrical equipment operates at high temperatures which may cause burns. Do not touch the filter, window, metal walls (depending on model), or other apparent metal parts.
19. To ensure safe operation, oversized foods must not be inserted into the fryer.
20. Ensure that the lid and bowl are completely dry after washing and before use.
21. Never immerse the fryer basket into the hot oil - or drain it - without the fryer lid in place.
22. The oil level must always be between the Min. and Max. markings.
23. Do not overload the basket. For safety reasons never exceed the maximum quantity.
24. Never operate your fryer without any oil.
25. The cooking times are given as guidelines only.
26. The oil must be filtered regularly and changed after 8 to 12 uses.
27. Do not mix different types of oil.
28. If you use solid vegetable shortening, cut it into pieces and melt it over low heat in a separate pot beforehand, then slowly pour it into the deep fryer pot. Never put solid shortening directly into the deep fryer pot or basket, as this will lead to deterioration of the fryer.
29. If the fryer has a removable pot, never remove it while the deep fryer is on.
30. This model is equipped with a permanent metallic filter, which does not need to be changed.
31. This appliance is not designed to be used by people (including children) with a physical, sensory or mental impairment, or people without knowledge or experience, unless they are supervised or given prior instructions concerning the use of the appliance by someone responsible for their safety. Children must be supervised to ensure that they do not play with the appliance.

32. If you have any problems, contact the authorized after-sales service center or the internet address www.t-falusa.com.

Polarization instructions (USA)

If this appliance has a polarized plug (one blade is wider than the other), it is to reduce the risk of electric shock.

This plug is intended to fit into a polarized outlet only one way. If the plug does not fit fully into the outlet, reverse the plug. If it still does not fit, contact a qualified electrician. Do not attempt to modify the plug in any way.

Short Cord instructions

Do not use with an extension cord. A short power supply cord is provided to reduce the risks resulting from being tangled in, or tripping over, a long cord.

Magnetic connector (USA)

The cord is equipped with a detachable magnetic connector. The magnetic connector should be attached directly to the fryer. THIS SHOULD BE DONE PRIOR TO PLUGGING THE CORD INTO THE WALL OUTLET.

Environment protection first!

Your appliance contains valuable materials which can be recycled.

When you decide to replace your appliance, leave it at a local civic waste collection point.

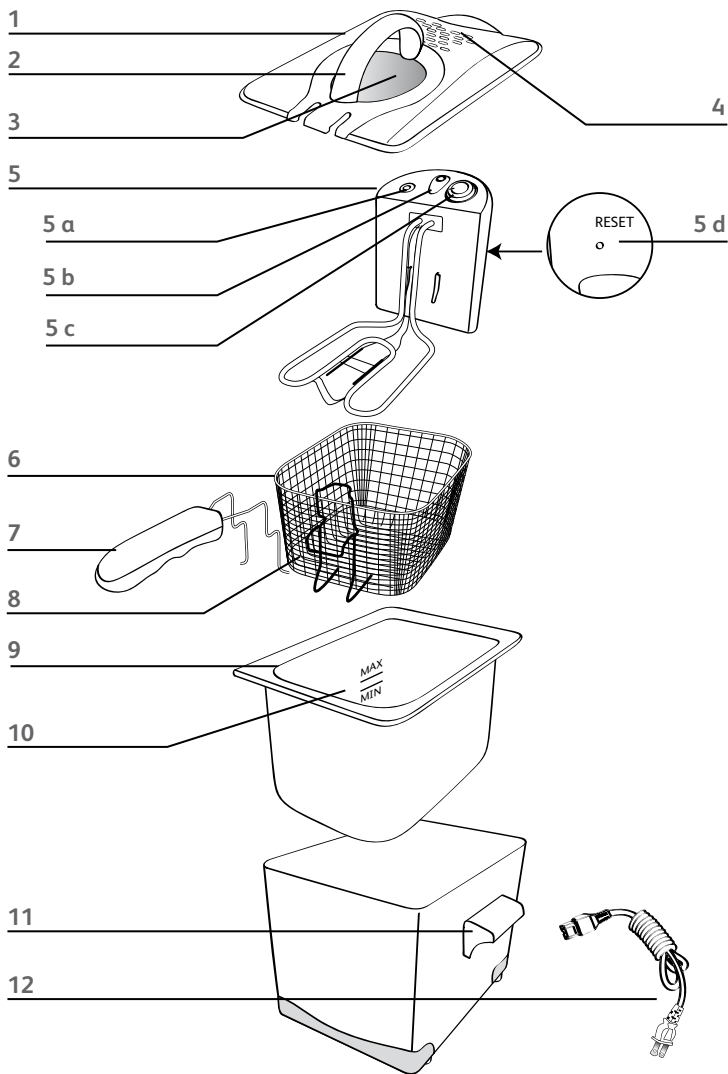

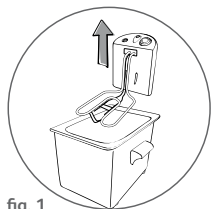

fig. 1

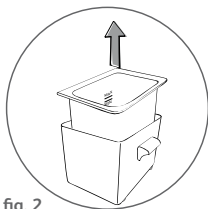

fig. 2

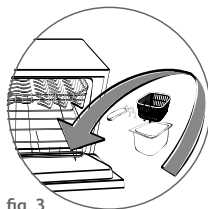

fig. 3

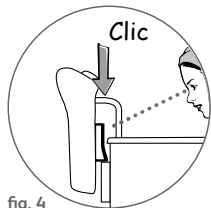

fig. 4

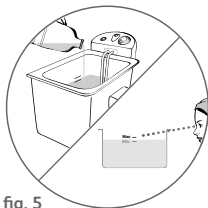

fig. 5



fig. 6

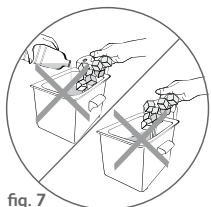

fig. 7

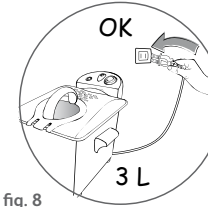

fig. 8

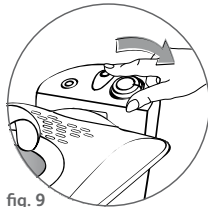

fig. 9

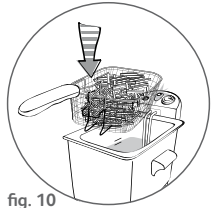

fig. 10

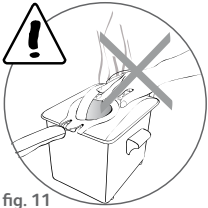

fig. 11

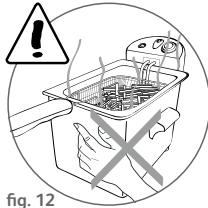

fig. 12

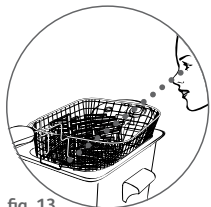

fig. 13

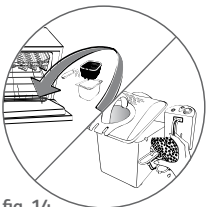

fig. 14

Description

1. Removable lid
2. Lid handle
3. Window
4. Filtration zone
5. Removable control unit and heating element
 - a. Power indicator light
 - b. Oil temperature ready light
 - c. Adjustable thermostat
 - d. RESET button
6. Basket
7. Basket handle
8. Basket high position
9. Removable Bowl
10. Min and Max oil level markers
11. Carrying handles
12. Electric cord

Preparation

Before using for the first time

- The fryer can be completely dismantled.
- Remove the lid, the basket and handle, the control unit - fig. 1 and the bowl - fig. 2.
- Clean the bowl and the basket with a sponge and soapy water or put them in the dishwasher - fig. 3.
- Clean the housing, the lid, the control unit and the heating element with a damp cloth.
- Dry all components thoroughly.
- Place the bowl and the heating element in position - fig. 4.

Do not immerse the control unit with the heating element in water. Never wash the lid in the dishwasher. Make sure that the control unit is correctly positioned otherwise the fryer cannot function.

Filling the bowl

Do not mix different types of oil or fat as this may cause the oil to overflow.

The oil/fat level must always be between the min. and max. markers, stamped inside the bowl. Check this each time prior to cooking and add some of the same type of oil if necessary.

- Fill the bowl with oil – fig. 5.
- Never exceed the maximum level indicated in the bowl – fig. 6.

	Oil Solid	Vegetable fat
Min.	11 ³ / ₄ cups / 2.8 L	5.62 lbs / 2550 g
Max.	12 ³ / ₄ cups / 3.0 L	5.95 lbs / 2 700 g

- For best results use oil recommended for deep frying: vegetable oil, corn oil, canola oil, etc. If using sunflower oil ensure the oil is changed every 5 uses. Oils which should NOT be used under any circumstances and may cause overflowing/smoking/risk of fire are: ground nut oil, soya oil, olive oil, lard or drippings.
- If you use solid vegetable oil, cut it into small pieces and melt it in a separate pan – fig. 6. Pour the melted oil into the fryer bowl. Never melt solid fat on the heating element or in the frying basket – fig. 7.

Preheating

- After the bowl has been filled with oil, put the lid on.
- Plug in the fryer – fig. 8.
- The power indicator light will come on and the fryer will begin to heat up.
- Turn the thermostat knob to the desired temperature without the frying basket – fig. 9.

Place the fryer:

- on a flat, stable, heat-resistant surface
- out of the reach of children
- away from water or heat sources.

Never operate your fryer without any oil or fat in the bowl.

Loading the basket

Never exceed the maximum capacity. Shake frozen food to remove excess pieces of ice away from the deep fryer. No matter what the recipe, food must be dried thoroughly before frying. This will prevent the oil from overflowing and extend the life of the oil.

- Remove excess water, ice or frost from food.
- Fill the basket before placing it in the deep fryer (see the cooking tables page 8). Do not overfill the basket. Reduce the quantities for frozen foods.
- Cooking tips: Cut food into similar-sized pieces so that they cook evenly. Avoid using pieces that are too thick. For crispier frozen fries, wash them in cold water and dry them carefully. Not all frozen foods are ready to use, check the manufacturer's instructions.

Cooking

Lowering the basket

- After the ready light has come on, place and lower the basket slowly into the oil – fig. 10.
Plunging the basket too rapidly in the oil may cause it to overflow.
- Watch cooking during 1 minute before putting the lid on.
- Note: During cooking, it is normal for the ready light to go on and off.

Never leave the lid on during cooking – fig. 11. When the fryer is in use, some parts will be extremely hot and can cause severe burns. Only touch the knobs and handles of the fryer for your safety – fig. 12.

At the end of cooking time

Frying is complete when the cooking time has elapsed and food is of the desired color and texture.

- Allow excess oil to drain by hooking the basket on the support on the inner bowl – fig. 13.
- Serve.
- To use a second time, correct the oil level if necessary, then wait for the ready light to turn on again before lowering food into oil.

Switching off the deep fryer

Never move the fryer while the oil or fat is still hot.

- When you have finished frying, turn the thermostat down to the lowest setting, then unplug the deep fryer.
- Allow the oil to cool completely in the fryer (approx. 2 hours).
- Move the fryer using the carrying handles.

Table of cooking times

- The cooking times are a guide only, they may vary depending on the size of the food, the amount of the food, individual preferences and the voltage.
- Cooking tips: For the best results, use the traditional French method of frying homemade chips:
 - first frying at 320°F / 160°C
 - second frying at 374°F / 190°C.
- When cooking battered food and doughnuts, remove the wire basket to prevent food from sticking to it and use tongs to slowly lower the food into the hot oil.

Take great care when handling the food and use tongs. Gradually place the food into the hot oil, submerging it an inch at a time to prevent it from sinking too quickly.

Fresh food	Quantity	Temperature	Cooking time
French fries (maximum quantity)	2.20 lbs / 1000 g	1) 320°F / 160°C	12-13 min.
		2) 374°F / 190°C	4-5 min.
French fries (maximum quantity)	1.98 lbs / 900 g	374°F / 190°C	16-17 min.
French fries (quantity recommended for best results)	1.32 lbs / 600 g	338°F / 170°C	13-14 min.
Fried chicken (leg portions)	8	356°F / 180°C	19-20 min.
Fish fillets	.88 lbs / 400 g	320°F / 160°C	8-9 min.
Fried whole mushrooms	.88 lbs / 400 g	302°F / 150°C	8-10 min.
Apple fritters	6	338°F / 170°C	8-9 min.

Frozen food	Quantity	Temperature	Cooking time
French fries (maximum quantity)	1.98 lbs / 900 g	374°F / 190°C	15-16 min.
French fries	1.65 lbs / 750 g	374°F / 190°C	11-12 min.
French fries (quantity recommended for best results)	.99 lbs / 450 g	374°F / 190°C	7-8 min.
Chicken nuggets	2.64 lbs / 1200 g	374°F / 190°C	9-10 min.
Breaded fish fillets	.99 lbs / 450 g	374°F / 190°C	6-8 min.
Fried whole mushrooms	8 - 9	374°F / 190°C	9-11 min.

Cleaning

Filtering the oil

- You may store the oil in the fryer, or in a separate airtight container.
- Do not pour used oil/fat into the sink. Leave it to cool, and throw it away with household waste according to the local community regulations.
- If you use solid shortening, we advise you to store it separately from the fryer.
- Crumbs that break away from foods tend to burn and alter the quality of the oil more rapidly. Over time, this increases the risk of catching fire. For this reason, filter the oil regularly.

Let the fryer with the oil in the removable bowl cool completely before filtering the oil (2 hours). We recommend changing the oil/fat after a maximum of 8 to 10 uses. If using sunflower oil, ensure the oil is changed after every 5 uses.

Cleaning the fryer

Never immerse the control unit in water and never wash it under running water.

Never wash the lid, the housing and the control unit in the dishwasher. Do not store your deep fryer outside.

Do not use aggressive or abrasive cleaning products.

- **Always unplug your fryer and leave it to cool completely before cleaning it (approx. 2 hours).**
- The bowl and the frying basket are dishwasher safe or can be immersed in soapy water – fig. 14.
- Clean the lid, the housing, the control unit and the heating element with a damp cloth – fig. 14.
- Ensure all components are dry before placing them back inside the fryer.
- Put the lid on the fryer for clean storage.

Reset function

- Your appliance is equipped with an overheating security feature located in the back of the control unit.
- If you use your fryer without oil the safety cut-off is activated and the appliance will shut off automatically.
- In this case, unplug the appliance and let it cool.
- After the bowl has been filled with oil, plug the appliance in. Then press the safety cut-off RESET button with a toothpick or similar non-metallic object.
- If the problem with the safety cut-off persists, please contact our Helpline (see details on page 11).

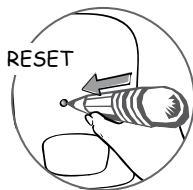

If your fryer does not work properly

PROBLEMS AND POSSIBLE CAUSES	SOLUTIONS
The fryer is not heating	
The appliance is not plugged in.	Plug-in the appliance and check the connection between the cord and the fryer.
The cooking temperature is not being reached.	Set the thermostat control to the required temperature.
The control unit is not correctly positioned.	To prevent this, use the guide slots to correctly position the control unit.
The safety cut-off is activated.	Let it cool and press the RESET button, which is located on the back of the control unit of the fryer. If the problem persists, please contact our Consumer Service Department (see contact details page 11).
Oil overflows	
The basket was lowered too quickly.	Lower the basket slowly and keep a close eye on the oil level.
Cooking freshly made fries at 356°F/374°F - 180°C/190°C for the first fry.	It is important to double-fry freshly made fries and to respect the recommended cooking temperature (see page 8).
The Max. marker for filling the bowl has been exceeded.	Check the level (Max.) and remove the excess.
The frying basket has been overfilled with food.	Check that the basket is not too full.
Food is wet or contains too much water (frozen food).	Remove any ice and dry the food thoroughly. Lower the basket slowly.
Wrong oil or different types of oil/fat have been mixed.	Empty and clean the bowl. Refill the bowl with one type of oil (see recommendations of what oil to use page 6).
Emits unpleasant smells	
The fat/oil has deteriorated.	Replace the frying oil (after 8 uses max.), more frequently depending on the oil.
The fat/oil is unsuitable.	Use a good quality blended vegetable oil.
Food does not become golden, and remains soft	
Food is moist and contains too much water (frozen food).	Remove as much ice from the frozen food as possible before frying.
Pieces are too thick and contain water.	Experiment by lengthening the cooking time or by slicing food smaller and thinner.
Too much food is being cooked at the same time and the cooking oil is not at the right temperature.	Fry food in small quantities (especially when frozen).
The temperature of the frying oil may not be high enough: the temperature is set incorrectly.	Set the thermostat control to the recommended temperature.
French Fries stick together	
Unwashed food immersed in hot oil.	Wash potatoes well and dry them thoroughly.

WARRANTY USA AND CANADA

In USA

Groupe SEB USA (T-Fal) warrants this product to be defect free in material and workmanship for a period of one year from the date of purchase. This warranty extends to the original purchaser and any subsequent owner within the warranty period. If a defect is found to exist, T-fal will, at its option, either repair or replace the product or the defective component, including labor. Replacement will be made with new or rebuilt product or components. Proof of purchase is required to obtain warranty service, so keep the register receipt. If a product or component is returned without proof of purchase it will be reviewed based on the manufacturing production week and year to determine if there is warranty coverage.

This warranty does not apply to any unit that has been tampered with, nor to damages incurred through improper use and care, faulty packaging by you or mishandling by any common carrier.

T-fal's sole obligation and your exclusive remedy under this warranty is limited to such repair or replacement.

THE DURATION OF ANY IMPLIED WARRANTY WHATSOEVER, INCLUDING BUT NOT LIMITED TO THE WARRANTIES OF MERCHANTABILITY AND FITNESS FOR A PARTICULAR PURPOSE, SHALL BE LIMITED TO THE DURATION OF THE EXPRESS WARRANTY PROVIDED HEREIN.

Some states do not allow limitations on how long an implied warranty lasts, so the above limitation may not apply to you.

T-FAL SHALL NOT BE LIABLE FOR ANY INCIDENTAL OR CONSEQUENTIAL DAMAGES WHATSOEVER.

Some states do not allow the exclusion or limitation of incidental or consequential damages, so the above limitation or exclusion may not apply to you.

This warranty gives you specific legal rights, and you may also have other legal rights which vary from State to State.

To obtain warranty service:

1. Do not return the product to the retailer from which it was purchased.
2. Please contact our consumer service department 1-800-395-8325 for assistance and to ensure the fastest possible resolution to the problem. Please have the model or type number of your product on hand. If it is determined that you should return your product or a component of the product for warranty service, you will be given a return authorization number.
3. Send the product or component, postage-paid, together with proof of purchase, a description of the problem, and the return authorization number you were given, to the closest authorized T-fal return facility (see www.t-falusa.com or call 1-800-395-8325).
4. Be sure to include your name, address and home telephone number with your shipment. Another contact number is suggested in case you need to be contacted.
5. We suggest that you carefully wrap your package for shipping and send by insured and/or traceable means.

In Canada

- Take your appliance to the nearest authorized T-fal Service Center, along with proof of purchase.
- T-fal agrees to repair or replace the defective part or product at no charge, provided that the product is returned with all shipping charges prepaid to:

Groupe SEB Canada
Customer Service
345 Passmore Avenue Scarborough Ont. M1V 3N8

accompanied by proof of purchase and a letter detailing the nature of the defect. Be certain that the appliance is wrapped carefully when shipping. The T-fal Customer Service Department should be contacted by mail or by phone at 1800 418 3325 or by email at info@t-fal.ca, in case the defect can be corrected with out returning the product.

Canada (1800 418 3325) or www.t-fal.ca

If you have any product problems, please contact our Consumer Service Department for expert help and advice:

- in Canada : 1800 418 3325 or consult our web site: www.t-fal.ca.

Any repairs must only be carried out by an Approved Service Center with the manufacturer's own replacement parts.

Ref : NC00012662
Conception : www.batoteam.fr



Free Manuals Download Website

<http://myh66.com>

<http://usermanuals.us>

<http://www.somanuals.com>

<http://www.4manuals.cc>

<http://www.manual-lib.com>

<http://www.404manual.com>

<http://www.luxmanual.com>

<http://aubethermostatmanual.com>

Golf course search by state

<http://golfingnear.com>

Email search by domain

<http://emailbydomain.com>

Auto manuals search

<http://auto.somanuals.com>

TV manuals search

<http://tv.somanuals.com>