

**TCL**

# OWNER'S MANUAL PORTABLE AIR CONDITIONER

Please read this manual carefully before operating your appliance and retain it for future reference.



**MODEL:TAC-08CPA/HA  
TAC-10CPA/HA**

## THANK YOU!

Congratulations on your purchase and welcome to the TCL family.

Your new TCL Air Conditioner combines high-efficiency operation with portable convenience.

By following the operating and care instructions in this manual, your air conditioner will provide you with many years of reliable service.

# INTRODUCTION

---

## **IMPORTANT SAFETY INSTRUCTIONS**

Basic Safety Precautions -----	01
Electrical Safety -----	03

## **PARTS AND FEATURES**

Key Parts and Components -----	05
Control Panel -----	06

## **HOW TO USE**

Remote Controller -----	09
Using the remote control -----	10

## **INSTALLATION INSTRUCTIONS**

Preparing For Installation -----	13
Set Up & Use -----	14

## **CARE AND CLEANING**

Cleaning -----	17
Emptying the Water Collection Tank -----	17
Start-End Of Season Operations -----	18

## **TROUBLESHOOTING**

Before Calling for Service -----	19
----------------------------------	----

# IMPORTANT SAFETY INSTRUCTIONS

## READ ALL INSTRUCTIONS BEFORE USE

### Your safety and the safety of others is very important.

We have provided many important safety messages in this manual and on your appliance. Always read and obey all safety messages.



This is the safety alert symbol.  
This symbol alerts you to potential hazards that can hurt you and others.

All safety messages will follow the safety alert symbol and either the word “WARNING” or “CAUTION”.

These words mean:



**WARNING** This symbol indicates the possibility of death or serious injury.



**CAUTION** This symbol indicates the possibility of injury or damage to property.

### BASIC SAFETY PRECAUTIONS



**WARNING** To reduce the risk of fire, electric shock, or injury

to persons when using this appliance, follow basic precautions, including the following:

- Do not attempt to repair or replace any part of your air conditioner unless it is specifically recommended in this manual. All other services should be referred to a qualified technician.
- If the power cord becomes worn or damaged, the cord should only be replaced by a qualified service technician using genuine replacement parts.
- The air conditioner should be plugged into its own grounded circuit (15A, 60Hz, 115VAC).
- Do not plug other appliances into the same outlet; it can overload the circuit and cause a fire or electric shock.
- Do not remove the round grounding prong from the plug. It can result in the risk of electric shock.
- Young children should be supervised to ensure that they do not play with or climb on the air conditioner.
- Be sure all packaging materials are removed from the air conditioner before use.
- Do not disassemble or modify the air conditioner or the power cord. It can result in the risk of electric shock or fire.
- Do not place the power cord or air conditioner near a heater, radiator, or other heat source. It can result in the risk of electric shock or fire.
- Do not use this or any appliance near flammable gases or liquids or other combustibles, such as gasoline, benzene, thinner, etc. It can result in the risk of electric shock or fire.
- Make sure the power cord is plugged firmly and completely into the outlet. It can result in the risk of electric shock or fire.

# IMPORTANT SAFETY INSTRUCTIONS

## READ ALL INSTRUCTIONS BEFORE USE

- Do not start or stop operation by plugging in or unplugging the power cord. It can result in the risk of electric shock.
- If the air conditioner is making unusual sounds or is emitting smoke or an unusual odor, unplug it immediately.
- Do not use if the electrical socket is loose or damaged. It can result in the risk of electric shock or fire.
- Do not operate with wet hands or in a damp environment.
- Do not use this or any electrical appliance if you smell gas. It can result in the risk of fire or explosion.
- Turn off and unplug the air conditioner before cleaning to avoid the risk of electric shock.
- Do not clean the unit with water. Water can enter the unit and damage the insulation, creating a shock hazard. If water enters the unit, unplug it immediately and contact Customer Service. It can result in the risk of electric shock.
- Utilize two or more people to lift and install the unit.

## BASIC SAFETY PRECAUTIONS



### **CAUTION** To reduce the risk of fire, electric shock, or injury

to persons when using this appliance, follow basic precautions, including the following:

- To avoid possible cuts, avoid contacting the metal parts of the air conditioner when removing or re-installing the filter. It can result in the risk of personal injury.
- Do not block the air inlet or outlet of the air conditioner. Reduced air flow will result in poor performance and could damage the unit.
- Always grasp the plug when plugging in or unplugging the air conditioner. Never unplug by pulling on the cord. It can result in the risk of electrical shock and damage.
- Always turn off and unplug the air conditioner when it will not be used for extended period of time. This conserves energy and reduces the chance of accidents.
- Secure the wheels with wheel locks to prevent the air conditioner from rolling on smooth floors.
- Install the air conditioner on a sturdy, level floor capable of supporting up to 110 lbs (50 kg). Installation on a weak or unlevel floor can result in the risk of property damage and personal injury.
- Make sure the air conditioner is the correct size for the area you wish to cool.
- Close all doors and windows to the room for most efficient operation.
- To prevent damage to the surface finish, use only a soft cloth to clean the air conditioner. Do not use wax, thinner, or a strong detergent.

# IMPORTANT SAFETY INSTRUCTIONS

## READ ALL INSTRUCTIONS BEFORE USE

- Do not position the air conditioner so that pets or house plants are exposed to the direct air flow.
- This air conditioner is designed for normal household use.
- Do not drink the water from the drain pan. Dispose of it properly outdoors or down the drain.
- Do not operate air conditioner without the filter securely in place. Operation without the filter could damage the unit.
- Clean the filter every two weeks, or more often if needed.

## ELECTRICAL SAFETY



### WARNING

#### Electrical Shock Hazard

- Failure to follow these instructions can result in death, fire, or electrical shock.
- This unit must be properly grounded.
- Do not, under any circumstances, cut or remove the ground prong.
- If you do not have a properly grounded outlet, or if there is any doubt that the outlet is not properly grounded, a qualified electrician should check the outlet and circuit, and, if necessary, install a properly grounded outlet.
- This air conditioner must be plugged into a grounded 60 Hz, 115 VAC outlet protected by a 15 amp time delay fuse or circuit breaker.
- This air conditioner must be installed in accordance with national wiring codes.
- Do not use an extension cord.

# IMPORTANT SAFETY INSTRUCTIONS

## READ ALL INSTRUCTIONS BEFORE USE

### ELECTRICAL SAFETY

#### INTEGRATED CIRCUIT BREAKER

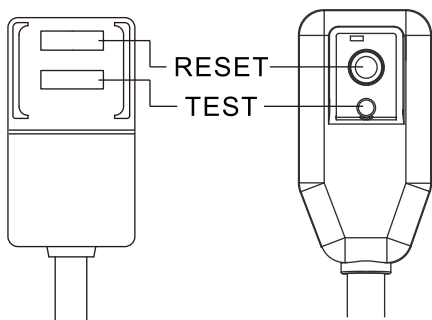

For additional safety, the power cord features an integrated circuit breaker. Test and reset buttons are provided on the plug case.

The circuit breaker should be tested periodically by pressing the TEST button. If it does not cause the circuit breaker to trip, or if the RESET button will not stay engaged, unplug the air conditioner immediately and contact your TCL service technician.

**Note:** Your unit's power cord and plug may differ from above the picture shows.

#### PREFERRED GROUNDING METHOD

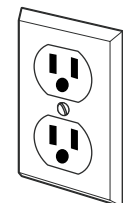
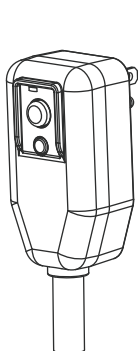

Ensure proper ground exists before use.

#### TEMPORARY GROUNDING METHOD

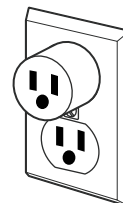
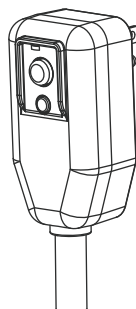

(Use of adapter plugs is not permitted in Canada)

Ensure proper ground exists before use.

**Due to potential safety hazards, the use of an adapter plug is strongly discouraged.**

To prevent damage to the adapter's ground terminal, hold the adapter in place while plugging in or unplugging the air conditioner.

**Attaching the adapter ground terminal to the wall receptacle cover screw does not ground the appliance unless the cover screw is metal and not insulated, and the wall receptacle is grounded through the house wiring.**

**Frequent connection and disconnection can damage the ground terminal on the adapter. Never use a broken or damaged adapter.**

## SAVE THESE INSTRUCTIONS

# PARTS AND FEATURES

## KEY PARTS AND COMPONENTS

1. Air Outlet Grill
2. Control Panel
3. Carrying Handle
4. Casters/wheels
5. Power cord
6. Air Filter
7. Middle drainage
8. Air Exhaust
9. Air Intake Grill
10. Condensation Drain hole
11. Exhaust Hose
12. Window Kit Adapter
13. Exhaust hose connector
14. Window Kit Adapter Extension
15. Window Kit
16. Caster Locks
17. Drainage Hose
18. Remote Controller
19. Rubber plug
20. Screws
21. Foam seal type 1
22. Foam seal type 2
23. Drain pan(only for heating & cooling model)
24. Product manual(Not shown)

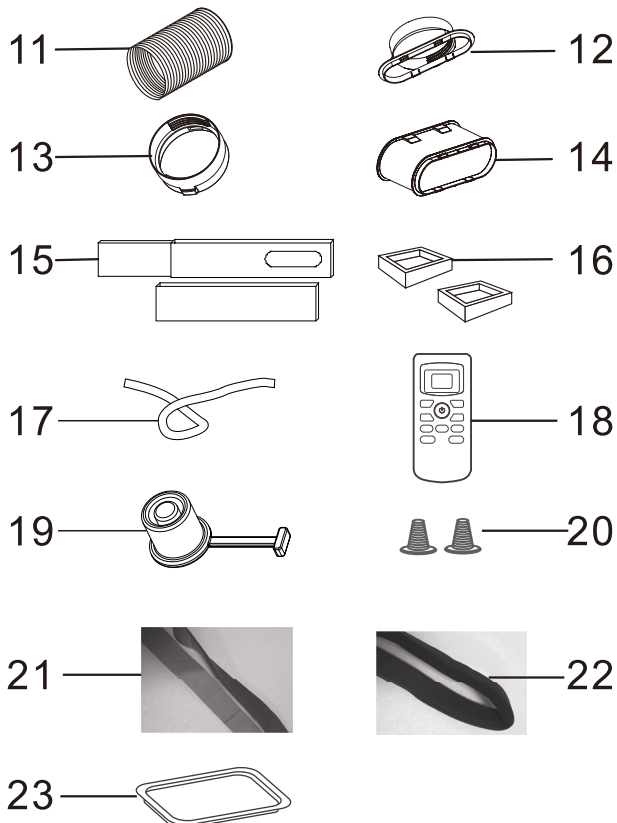
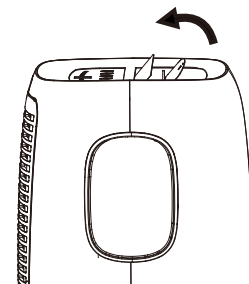
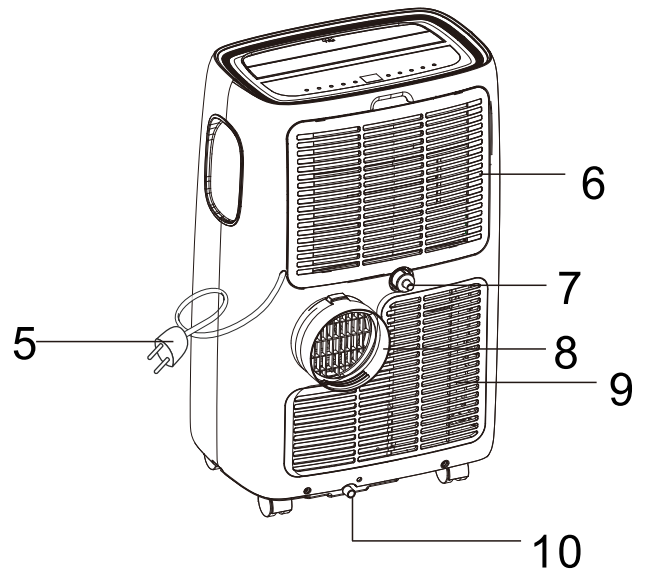
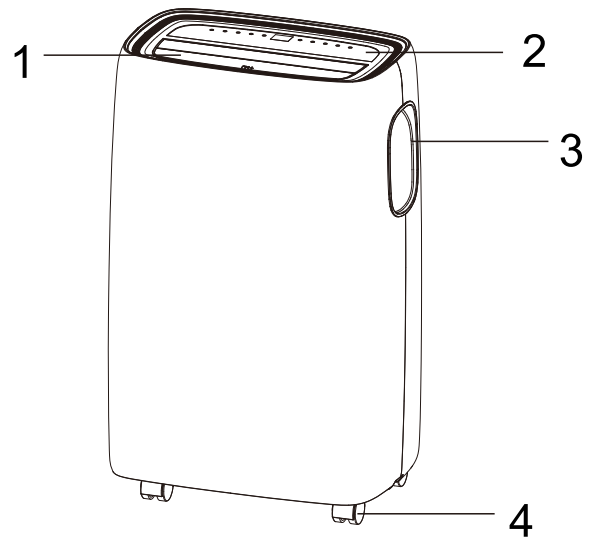

\* Open the louver before use the unit.



# PARTS AND FEATURES

## CONTROL PANEL

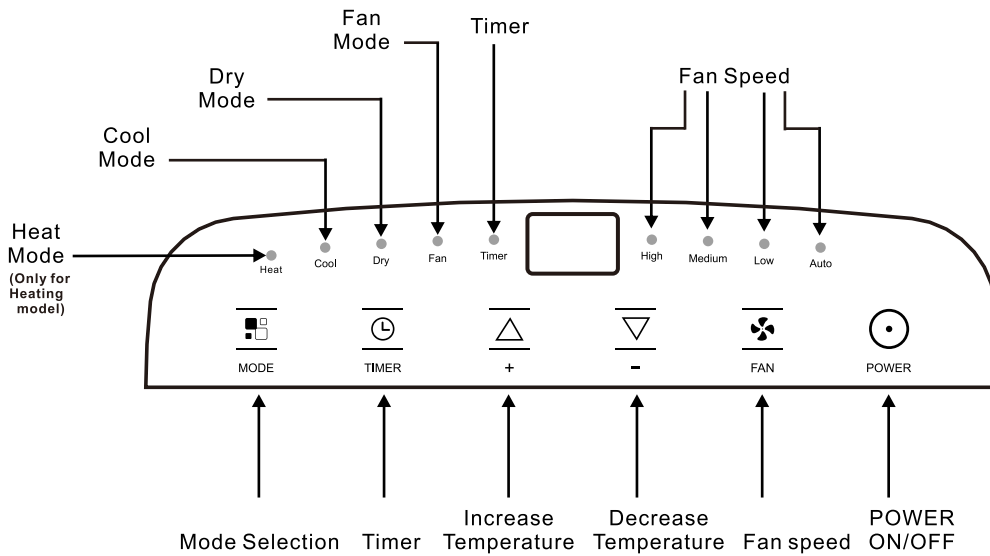

## CONTROL PANEL

### 1) Power On and Off

Plug into the main socket. And the screen will display “ -- ”, like the picture below. Press the POWER button once to manually turn the unit on. Press the POWER button once more to turn the unit off.

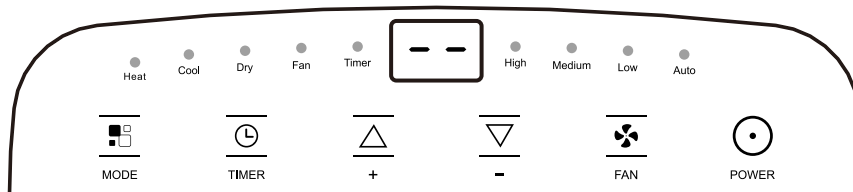

### 2) Cool mode

Press the POWER button to manually turn the unit on. Press the MODE button until the Cool mode indicator is light. Press the Fan speed button to choose the fan speed you want then the fan speed indicator will light. You can choose the High, Medium, Low, and Auto. Press the “ ▲ ” and “ ▼ ” button to choose the temperature you want.

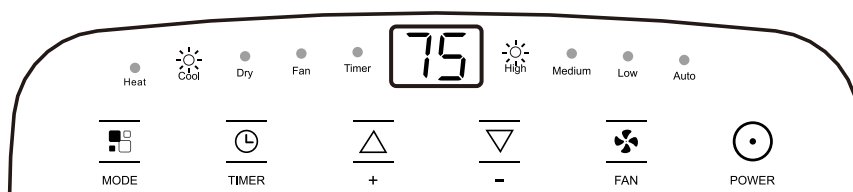

# PARTS AND FEATURES

### 3) Dry mode

Press the POWER button to manually turn the unit on.

Press the MODE button until the Dry mode indicator is light. The screen display “ dH ”.

At the same time, the AUTO fan indicator is light. In this mode, other speeds cannot be selected.

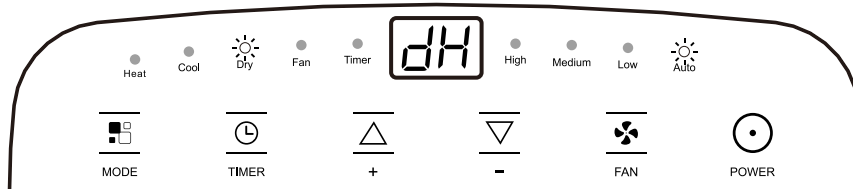

**NOTE:** The unit can use the drainage at middle of unit back when dehumidifier mode.

1. Counterclockwise to loose the cover.
2. Connect the hose on connector.



### 4) Fan mode

Press the POWER button to manually turn the unit on.

Press the MODE button until the Fan mode indicator is light.

In this mode, you can selected fan speed High, Medium, Low by press the Fan speed button.

The AUTO speed cannot be selected.

The screen display “ ≡≡ ” as High speed, “ ≡ ” as Medium speed, “ ≡ ” as Low speed.

In this mode the air exhaust hose does not need to be connected.

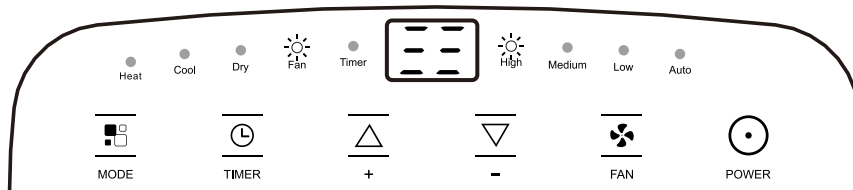

### 4) Heat mode (Only for Heating & Cooling model)

Press the POWER button to manually turn the unit on.

Press the MODE button until the Heat mode indicator is light.

Press the Fan speed button to choose the fan speed you want then the fan speed indicator will light. You can choose the High, Medium, Low, and Auto.

Press the “ ▲ ” and “ ▼ ” button to choose the temperature you want.

# PARTS AND FEATURES

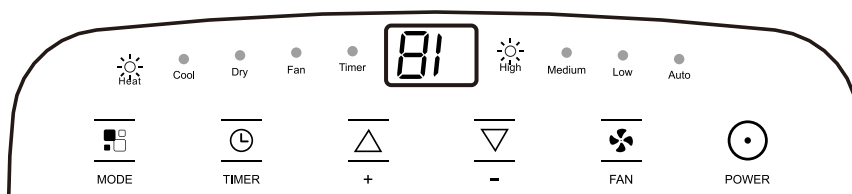

When operating in very cold rooms, the unit defreezes automatically, momentarily interrupting normal operation. “LE” appears on the display. During this operation, it is normal for the noise made by the unit to change.

In this mode, you may have to wait a few minutes before the unit starts giving out hot air.

In this mode, the fan may not operate for short periods, even though the set temperature has already been reached.

It may happen that the display shows “FL” alarm. In this case, empty the internal safety tank following the instruction in the Section “End of Season operations”. At the end, press again the POWER button to restore the heating function.

### 3) Timer mode

The timer can be used to delay the appliance start up or shutdown. This avoids wasting electricity by not operating the unit when it is not needed.

#### How to program the delayed start up

Plug the unit into the mains and turn the unit to standby.

Press the Timer button, the Timer indicator and the number of hours flash.

Press the “▲” or “▼” buttons to set the number of hours delay before the unit comes on.

The timer can be set in intervals of 0.5 hours up to 10 hours, then in intervals of 1 hour to 24 hours.

A few second after set, the setting is memorized, the timer indicator is light and the display shows that the appliance is in standby.

The unit will start working using the mode previously set.

To delete the setting, press the Timer button again. The timer indicator switches off.

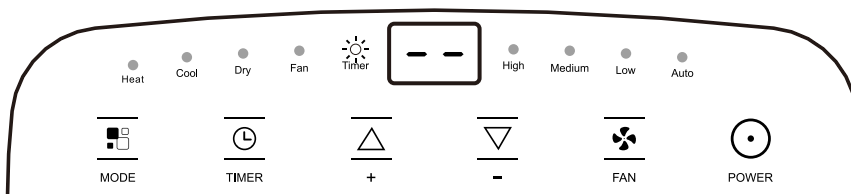

#### How to program the delayed shutdown

With the unit on, in every mode, it is possible to set the delayed shutdown.

Press the Timer button: the Timer indicator and the hours flash.

Use the “▲” or “▼” buttons to set the number of hours delay before the unit turns off.

A few second after set, the setting is memorized, the timer indicator is light and the display shows the current mode. At the end of the set time the unit automatically turns in standby mode.

To delete the setting, press the Timer button again. The timer indicator switches off.

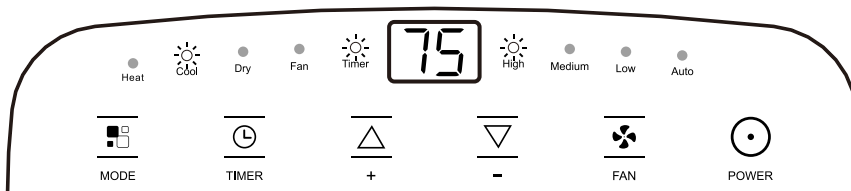

# HOW TO USE

## REMOTE CONTROL

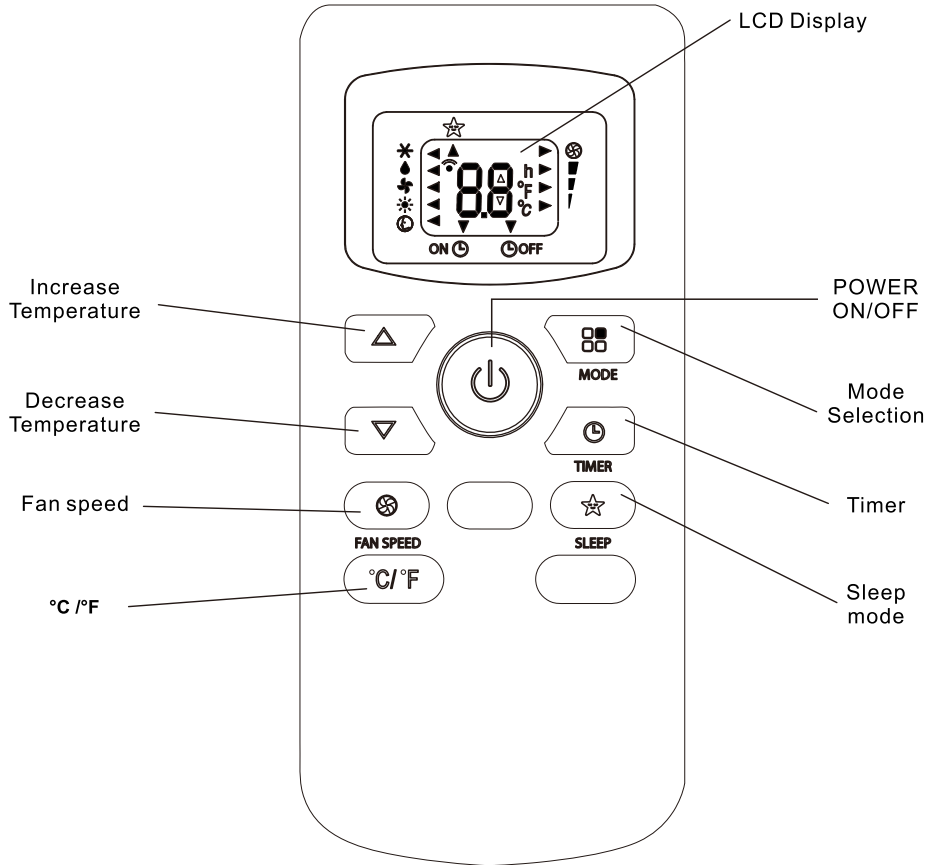

### INSERTING OR REPLACING THE BATTERIES

Remove the cover on the rear of the remote control;

Replace the old batteries with two new R03 “AAA” 1.5V batteries, inserting them correctly (see the instructions inside the battery compartment);

Replace the cover.

Point the remote control at the control panel on the unit. The remote control must be no more than 16 ft (5 meters) away from the unit (without obstacles between the remote control and the unit).

The remote control must be handled with extreme care. Do not drop it or expose it to direct sunlight or sources of heat.

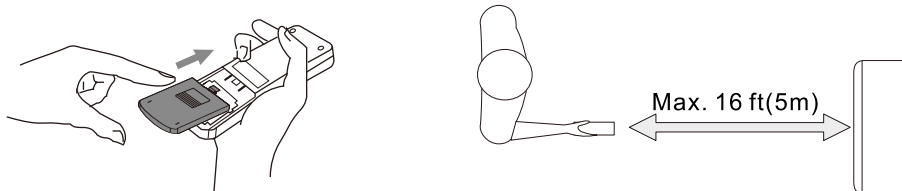

**If the remote control unit is replaced or discarded, the batteries must be removed and disposed of in accordance with current legislation as they are harmful to the environment. Do not mix old and new batteries. Do not mix alkaline, standard (carbon-zinc) or rechargeable (nickel-cadmium) batteries. Do not dispose of batteries in fire. Batteries may explode or leak. If the remote control is not be used for a certain length of time, remove the batteries.**

# HOW TO USE

## USING THE REMOTE CONTROL

### TURNING THE UNIT ON

Plug into the outlet. Press the ON/OFF button (when turned on, the unit starts operating in the same mode as when it was turned off).

To switch the unit off, press ON/OFF button again, then remove the plug.



Do NOT switch the unit off by removing the plug.

Always switch it off by pushing on the ON/OFF button and waiting few minutes before removing the plug. Only in this way the unit will perform the standard checkings.



### Cool mode

Press the ON/OFF button to manually turn the unit on.

Press the MODE button "  " until the left side control LCD screen display an arrow "  " light up next " \* " .

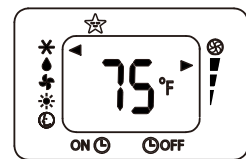
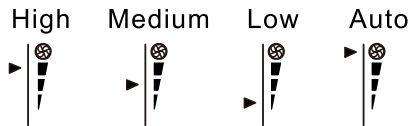

Press the Fan Speed button "  " to choose the fan speed you want then "  " indicator will light. You can choose the High, Medium, Low, and Auto.



Press the "  " and "  " button to choose the temperature you want.

### 3) Dry mode

Press the ON/OFF button to manually turn the unit on.

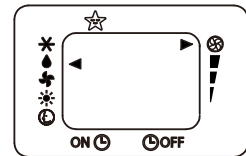

Press the MODE button "  " until the arrow "  " light up next "  " .

At the same time, the "  " indicator is light next Auto speed, other speeds cannot be selected.



### 4) Fan mode

Press the ON/OFF button to manually turn the unit on.

Press the MODE button "  " until the arrow "  " light up next "  " .



In this mode, you can selected fan speed High, Medium, Low by press the Fan speed button. The AUTO speed cannot be selected.

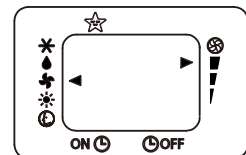

In this mode the air exhaust hose does not need to be connected.



### Heat mode (Only for Heating & Cooling model)

Press the ON/OFF button to manually turn the unit on.

Press the MODE button "  " until the left side control LCD screen display an arrow "  " light up next "  " .

Press the Fan speed button "  " to choose the fan speed you want then "  " indicator will light. You can choose the High, Medium, Low, and Auto.

Press the "  " and "  " button to choose the temperature you want.

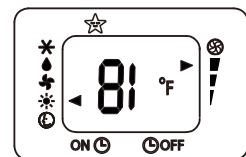

# HOW TO USE

## **Auto mode**

Press the ON/OFF button to manually turn the unit on.

Press the MODE button “  ” until the left side control LCD screen display an arrow “  ” light up next “  ”.

Press the Fan speed button to choose the fan speed you want then “  ” indicator will light. You can choose the High, Medium, Low, and Auto.

If the unit is cooling only model, the unit operates in Fan mode when the room temperature is below 73°F (23°C), and Cool mode when the room temperature is above 73°F (23°C).

If the unit is cooling and heating model, the unit operates in Heat mode when the room temperature is below 68°F (20°C), and Fan mode when the room temperature is from 68°F (20°C) to 73°F (23°C), and Cool mode when the room temperature is above 73°F (23°C).

Display on the control panel:

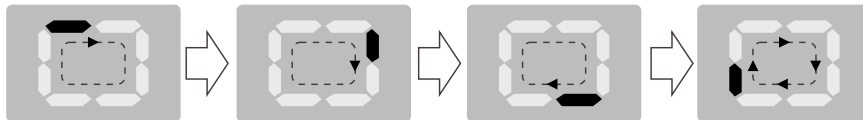

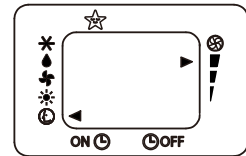

It is AUTO mode when the display will be running circulating.



## **Sleep mode**

Press the ON/OFF button to manually turn the unit on.

Make sure the unit is in Cool mode, or Auto mode, or Heat mode, or Dry mode.

Press the Sleep button “  ”, then an arrow “  ” light up under “  ”. When in Sleep mode, the fan will run on low to keep fan noise at a minimum.

In Cool mode, the temperature setting will gradually increase to 1°F above the original set temperature for each of first 2 hours. Then the unit will keep operating the same temperature for 6 hours and switch to standby mode.

In Heat mode, the temperature setting will gradually decrease to 1°F below the original set temperature for each of first 3 hours. Then the unit will keep operating the same temperature for 5 hours and switch to standby mode.

In Auto mode and Dry mode, the temperature setting automatically, and the fan speed is low.

In Fan mode cannot set Sleep mode.

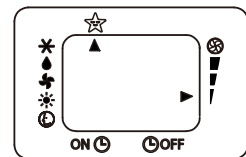

# HOW TO USE

## Timer mode

### **How to program the delayed start up**

Plug the unit into the outlet and turn the unit to standby.

Press the Timer button “⌚”, the arrow “▼” flash above “ON ⌚”.

Now make all the desired settings for when the unit will switch on (operating mode, fan speed and temperature). Confirm the settings by pressing the timer button “⌚”. The time is displayed and the “h” symbol flashes.

Set the time when you want the unit to switch off using the buttons “▲” or “▼” (from 30 minutes to 24 hours). During the first ten hours, you can select half hour intervals. For times greater than ten hours, one hour intervals can be selected.

Press the Timer button “⌚” again to confirm the start-up time. A beep sounds a countdown of the time left on remote control display.

At the end of the set time the unit start up automatically, with the settings made previously.

To cancel the timer programming, press the timer button “⌚” again. The unit emits a beep and display reset to stand-by.

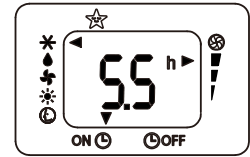

## Timer mode

### **How to program the delayed shutdown**

With the unit on, in every mode, it is possible to set the delayed shutdown.

Press the Timer button, the arrow “▼” will show above “⌚ OFF” indicator and “h” flash.

Press “▲” or “▼” to set the number of hours delay before the unit turns off.

Press Timer button again to conform the shutdown time. A beep sounds a countdown of the time left on remote control display.

At the end of the set time the unit shutdown automatically.

To cancel the timer programming, press the Timer button again. The timer indicator switches off.

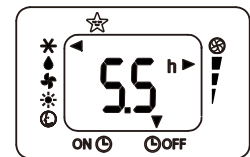

# INSTALLATION INSTRUCTIONS

## PREPARING FOR INSTALLATION

**! WARNING** The air conditioner is heavy! Use two or more people to lift and install the unit!

### WINDOW SLIDER KIT INSTALLATION

Your window slider kit has been designed to fit most standard "Vertical" and "Horizontal" window applications; however, it may be necessary for you to improvise/modify some aspect of the installation procedures for certain types of window. Minimum and maximum window openings:

**MAXIMUM : 56"**

**NOTE:** If the window opening is less than 20.5" the minimum length of the window slider kit, cut the one with a hole in it short to fit for the window opening. Never cut out the hole in window slider kit.

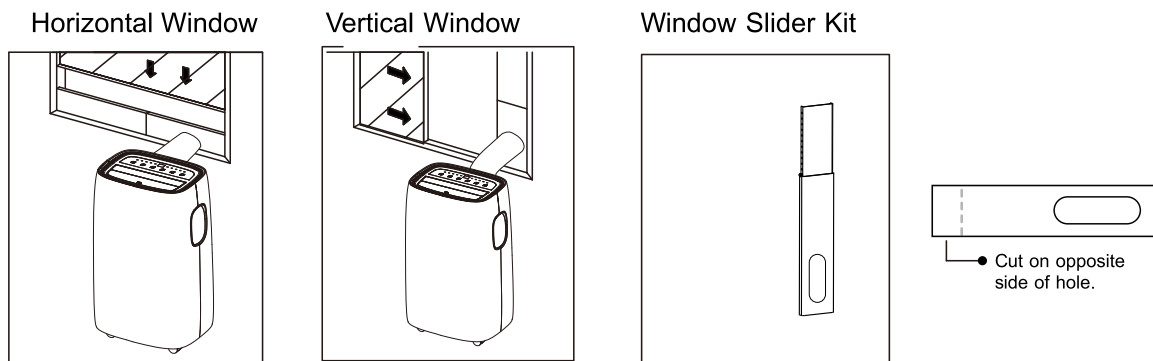

1. Parts:  
A) Panel  
B) Panel with one hole  
C) Panel without hole  
D) Screw to lock window kit in place

2. Assembly:  
Slide Panel B and C into Panel A and size to window width. Windows sizes vary. When sizing the window width, be sure that the window kit assembly is free from gaps from gaps and/or air pockets when taking measurements.

3. Lock the screw into the holes that correspond with the width that your window requires to ensure that there are no gaps or air pockets in the window kit assembly after installation.

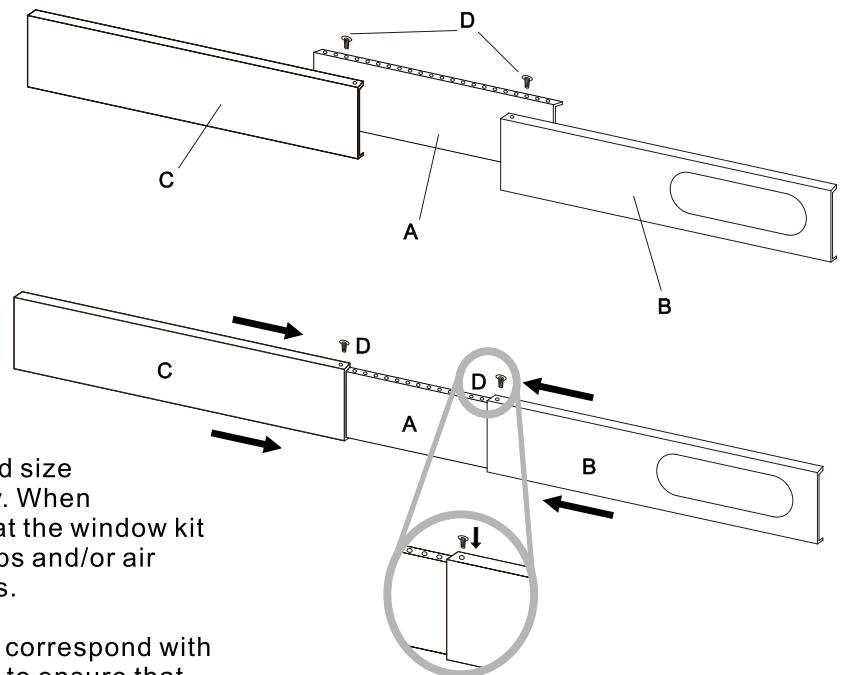



# INSTALLATION INSTRUCTIONS

## PREPARING FOR INSTALLATION

### DOUBLE-HUNG/SASH/SLIDING CASEMENT WINDOW INSTALLATION

1. Cut the foam seal (adhesive type) to the proper length and attach it to the window sash.
2. Attach the window slider kit to the window sash. Adjust the length of the window slider kit according to the window slider kit according to adjustable window kit if the width of window is less than 20.5".
3. Cut the foam seal (adhesive type) to the proper length and attach it on the top of the window.
4. Close the window securely against the window slider kit.
5. Secure the window slider kit to the window sash.
6. Cut the foam seal to an appropriate length and seal the open gap between the top window frame and outer window frame.

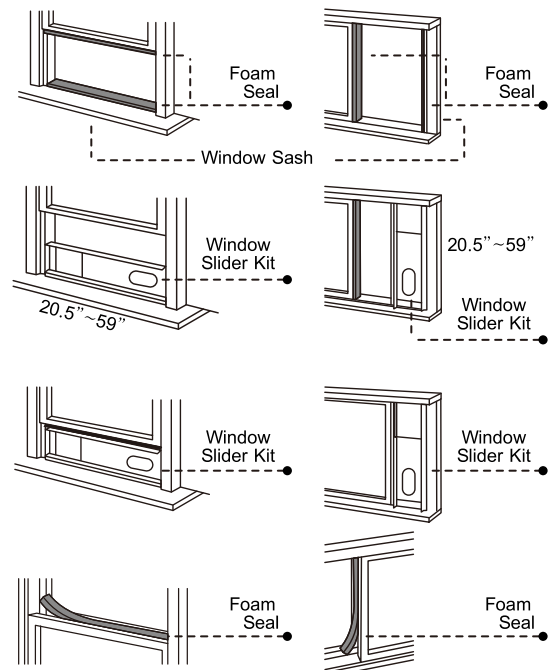

## SET UP & USE

### EXHAUST HOSE INSTALLATION

The air exhaust hose and hose inlet must be installed or removed from the portable air conditioner in accordance with the way it is being used:

**COOL, AUTO, DRY:** Air exhaust hose and hose inlet should be connected to the portable air conditioner.

**FAN:** Air exhaust hose and hose inlet should be disconnected from the portable air conditioner.

To install:

1. Connect hose inlet to one end of air exhaust hose. Push hose inlet over the end of the hose, push in slightly and then start threading it on in a counter clockwise direction. (see Fig 1)
2. Connect hose outlet to other end of air exhaust hose. Push hose outlet over the end of the hose, push in slightly and then start threading it on in a counter clockwise direction. (see Fig 2)
3. Align window bracket/air intake hose connector with hose outlet and push in until it locks into place. You will hear a clicking sound when it does. (see Fig 3)
4. Place the hose inlet against the air outlet opening hook on the back of the portable air conditioner and firmly push and rotate counter clockwise to lock it into place. (see Fig 4)
5. After connecting the hose inlet to the unit, insert the window bracket/air intake hose connector into the opening of the window bracket. Align connector with the opening on the inside (side with the channels) of the window bracket and push in until it locks into place. You will hear a clicking sound when it does. (see Fig 5).

# INSTALLATION INSTRUCTIONS

## SET UP & USE

Fig. 1

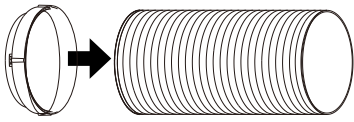

Fig. 2

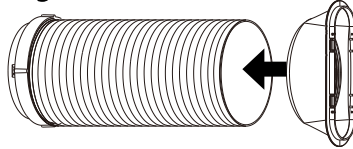

Fig. 3

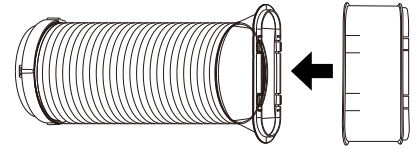

Fig. 4

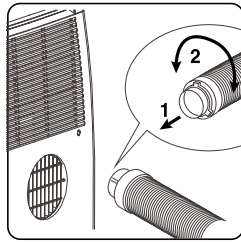
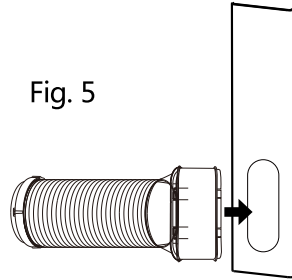
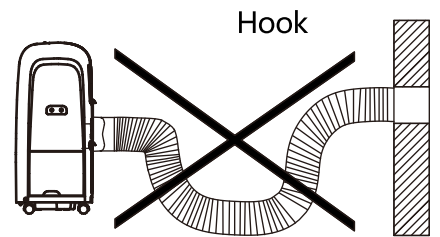

Fig. 5



### NOTE:

The exhaust hose can be compressed or extended moderately, but it is desirable to keep the length to a minimum. Also make sure that the hose does not have any sharp bends.



# INSTALLATION INSTRUCTIONS

## SET UP & USE

### INTERMITTENT DRAINAGE (FIG. 10 AND FIG. 11)

Turn the air conditioner off then drain the water tank by unplugging the drain cap and allowing the water to flow into a receptacle pan. Your pan may not hold the full contents of the water tank. A number of fills of your pan may be required.

To insure all water has been removed tilt the unit by lifting it slightly upwards from the front until no more water drains from the outlet.

Restart the air conditioner by pressing the power button. Ensure that the unit is in COOL or DRY mode. The compressor will start approximately 3 minutes after the unit is switched on.

Figure 10

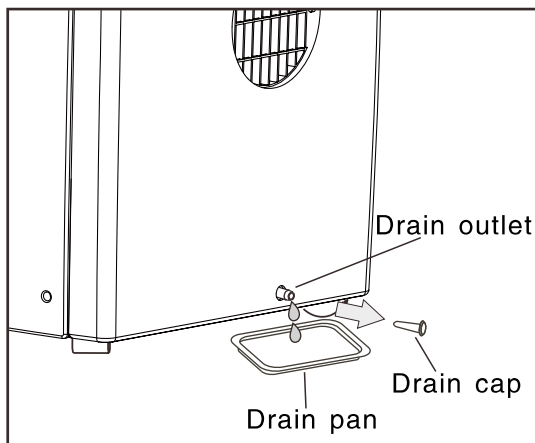
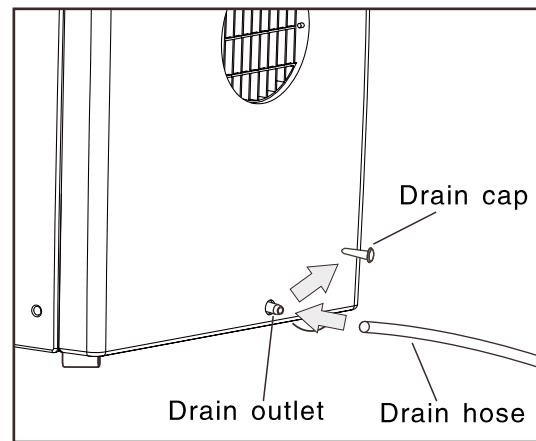

Figure 11



# CARE AND CLEANING

## CLEANING

Before cleaning or maintenance, turn the appliance off by pressing the POWER ON/OFF button on the control panel or ON/OFF button on the remote control. Wait for a few minutes then unplug from the electrical outlet.

### CLEANING THE UNIT

You should clean the appliance with a slightly damp cloth then dry with a dry cloth.

Never wash the air conditioner with water. It could be dangerous.

Never use petrol, alcohol or solvents to clean the appliance.  
Never spray insecticide liquids or similar.

### CLEANING THE FILTERS

To keep your air conditioner working efficiently, you should clean the filters every week of operation.

The evaporator filter can be removed as shown the left Fig.

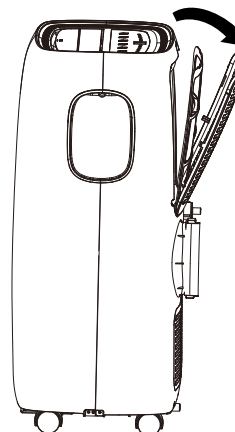

Use a vacuum cleaner to remove dust accumulations from the filters. If it is very dirty, immerse in warm water and rinse a number of times. The water should be lukewarm. After washing, leave the filters to dry then re-insert.

## EMPTYING THE WATER COLLECTION TANK

### Using the bottom drain port

When the internal water collection tank is full, FL will appear in the display and the air conditioner will turn off until the tank is emptied.

1. Unplug the air conditioner, disconnect the exhaust hose from the back, and move the air conditioner to a suitable drain location or outdoors. You may also place a pan under the drain that will hold up to 1 quart of water.

2. Remove the drain cap and the rubber plug from the drain outlet.

3. Once the water collection tank is drained, reinstall the rubber plug and the drain cap, making sure it is on securely.

4. Place the air conditioner in the desired location, reconnect the exhaust hose, and plug in the air conditioner.

5. When need dehumidification in high humidity, or running in Heat mode, install a drain hose and place the open end of the hose a suitable drain location or outdoors.

6. Under the Cool or Fan mode, there's no need of water drainage.

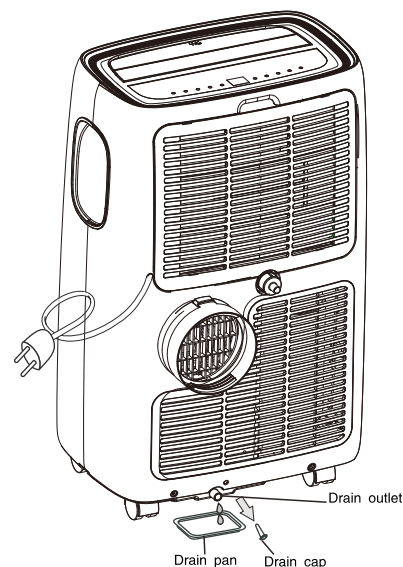

### NOTICE: “ FL ” appears in the display

The water tank is full, drain the tank and reset.

# CARE AND CLEANING

## START - END OF SEASON OPERATIONS

If the air conditioner will not be used for an extended period of time:

1. Drain the water collection tank completely and leave the bottom drain cap and rubber plug long enough to allow any residual water to drain out. Once the tank is completely drained and no more water flows out, reinstall the rubber plug and cap.

2. Remove and clean the filter, allow it to dry completely, then reinstall it.

3. Remove the batteries from the remote.

4. Store the air conditioner in a cool, dry location, away from direct sunlight, extreme temperatures, and excessive dust.

Before using the air conditioner again:

1. Make sure the filter and drain cap are in place.

2. Check the cord to make sure it is in good condition, with no cracks or damage.

3. Place new batteries in the remote.

4. Install the air conditioner as described in the Installation Instructions.

# TROUBLE SHOOTING

## BEFORE CALLING FOR SERVICE

Before you call for service, review this list. It may save you time and expense.

Problem	Possible Causes	Solutions
Air conditioner will not start	<ul style="list-style-type: none"> <li>The air conditioner plug is not completely inserted into the electrical outlet.</li> <li>The fuse is blown or the circuit breaker has tripped.</li> <li>Power failure.</li> <li>"F<sub>L</sub>" appears in the display.</li> <li>Room temperature is less than the set temperature.</li> </ul>	<ul style="list-style-type: none"> <li>Make sure electrical plug is plugged completely into alive, properly grounded outlet.</li> <li>Replace the fuse or reset the circuit breaker. Make sure that there are no other appliances on the same circuit.</li> <li>If a power failure occurs, turn the power OFF. When power is restored, wait 3 minutes before restarting the air conditioner.</li> <li>The water collection tank is full. Drain the tank and reset your settings. See the Care and Cleaning section.</li> <li>This is normal. The air conditioner automatically shuts off when the room equals or is less than (Cool mode) or is more than (Heat mode) the set temperature. Adjust the temperature setting, if needed.</li> </ul>
Air conditioner does not cool properly	<ul style="list-style-type: none"> <li>Airflow is restricted.</li> <li>The air filter is dirty.</li> <li>The room is very hot, or not enough time allowed for cooling.</li> <li>Cold air is escaping.</li> <li>Cooling coils have iced up.</li> </ul>	<ul style="list-style-type: none"> <li>Make sure there is sufficient clearance around the air conditioner and that the air inlet and outlet are not blocked.</li> <li>Clean the air filter at least every two weeks. See the Care and Cleaning section.</li> <li>When first turned on, allow the air conditioner sufficient time to cool the room.</li> <li>Check for open furnace, floor registers, cold air returns, open windows or doors.</li> <li>In especially cool, humid weather and when the air conditioner is running frequently or for extended periods, ice can form on the cooling coils, blocking air flow. It is normal, please adjust the temperature higher and High fan speed.</li> </ul>
Air conditioner runs too often or too long	<ul style="list-style-type: none"> <li>Area to be cooled is too large for the air conditioner.</li> <li>Doors or windows are open.</li> </ul>	<ul style="list-style-type: none"> <li>Consult your dealer for the air conditioner capacity necessary to cool the desired area.</li> <li>Make sure doors and windows are closed.</li> </ul>



## Free Manuals Download Website

<http://myh66.com>

<http://usermanuals.us>

<http://www.somanuals.com>

<http://www.4manuals.cc>

<http://www.manual-lib.com>

<http://www.404manual.com>

<http://www.luxmanual.com>

<http://aubethermostatmanual.com>

Golf course search by state

<http://golfingnear.com>

Email search by domain

<http://emailbydomain.com>

Auto manuals search

<http://auto.somanuals.com>

TV manuals search

<http://tv.somanuals.com>