



PORTABLE AIR CONDITIONERS

SERVICE MANUAL

No. _____

Models

TAC-08CPA/HA

TAC-10CPA/HA

CONTENTS

1. IMPORTANT NOTICE
2. TECHNICAL SPECIFICATION
3. REFRIGERATION CYCLE DIAGRAM
4. OPERATION DETAILS
5. WIRING DIAGRAM
6. EXPLOSION VIEW AND PART LISTS
7. PRECAUTION
8. NAMES OF PARTS
9. INSTALLATION MANUAL
10. MAINTENANCE
11. TROUBLE SHOOTING
12. DISASSEMBLY PROCEDURE



1. IMPORTANT NOTICE

This service manual is intended for use by individuals possessing adequate backgrounds of electrical, electronic and mechanical experience. Any attempt to repair the appliance may result in personal injury and property damage. The manufacturer or seller cannot be responsible for the interpretation of this information, nor can it assume any liability in connection with its use.

The information, specifications and parameters are subject to change due to technical modification or improvement without any prior notice. The accurate specifications are presented on the nameplate label.

How to order spare parts

To have your order filled promptly and correctly, please furnish the following information:

- Model No. with Indoor or Outdoor
- Part No. in the Explosion View
- Part Name
- The quantity you ordered

2. REFRIGERATION CYCLE DIAGRAM

Cooling only

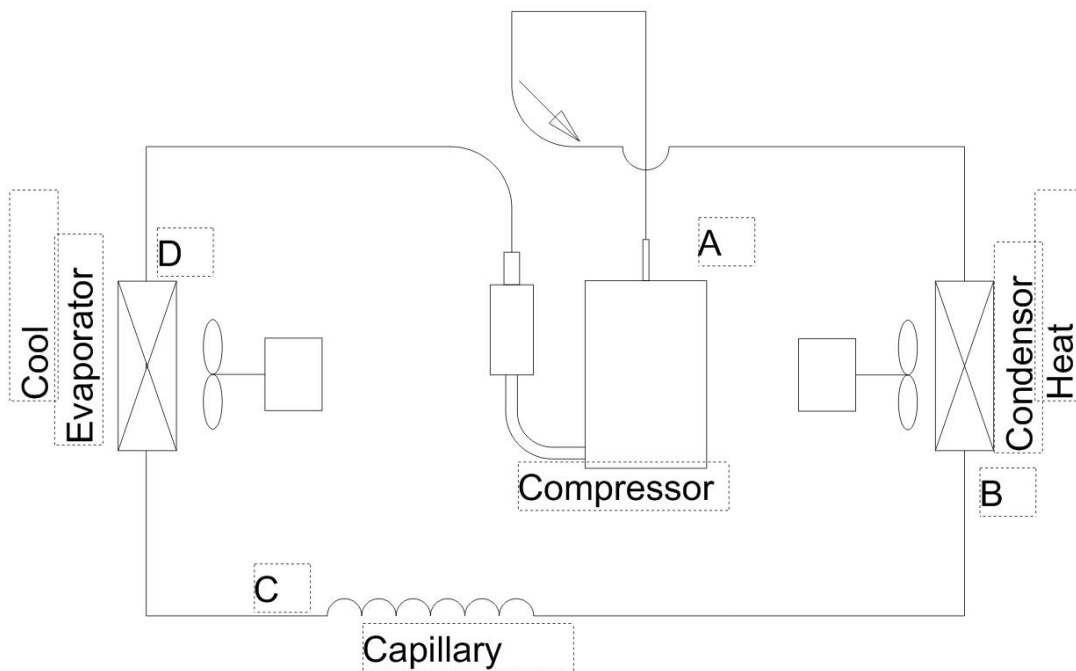

Heat Pump

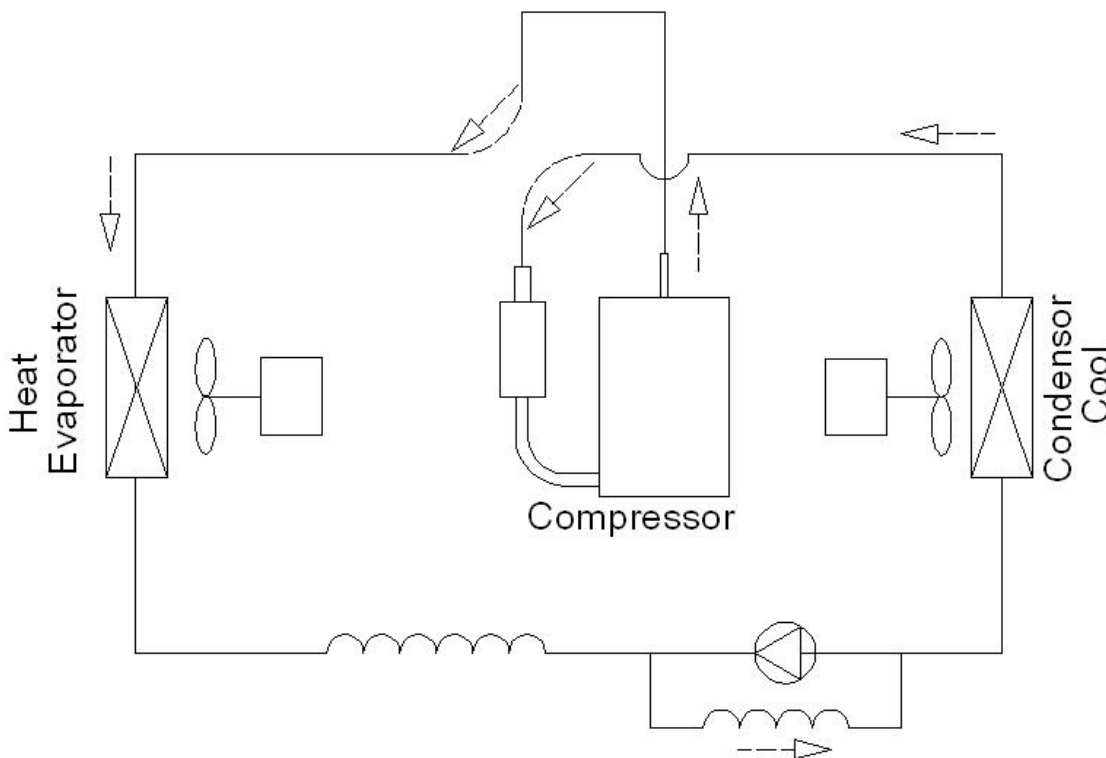

3. TECHNICAL SPECIFICATIONS

SPECIFICATIONS

- The cooling capacity is measured at an ambient temperature of DB 95°F, WB 83 °F.
- Noise level is measured at a distance of 3.28 ft away from the front of the unit, when the unit is in cooling mode.
- Power consumption is measured when the fan runs at the highest speed setting.
- These specifications are for reference only. For actual data, please refer to the rating label on the back of the unit.
- If the environment temperature is higher than the max operating temperature or lower than the minimum operating temperature, the air conditioner may not work properly.

MODEL NUMBER	TAC-08CPA/HA	TAC-10CPA/HA	TAC-12CPA/HA
COOLING CAPACITY	8,000 BTU/Hr	10,000 BTU/Hr	12,000 BTU/Hr
DEHUMIDIFYING CAPACITY	91 pts per Day	117 pts per Day	137 pts per Day
COOLING POWER USAGE	950 Watts, 8.7 Amps	1220 Watts, 10.9 Amps	1200 Watts, 10.2 Amps
AIR FLOW VOLUME	176 CFM	176 CFM	206 CFM
POWER SOURCE	115 V / 60 HZ	115 V / 60 HZ	115 V / 60 HZ
SOUND PRESSURE LEVEL	49 dB(A)	50 dB(A)	54 dB(A)
PRODUCT WEIGHT	50.7 Lbs	52.8 Lbs	62.8 Lbs
OPERATING TEMPERATURE	70°F -95°F	70°F -95°F	70°F -95°F
PRODUCT DIMENSIONS	17.7" W X 28.1" H X13.0" D	17.7" W X 28.1" H X13.0" D	17.7" W X 28.1" H X13.0" D
REFRIGERANT	R-410A	R-410A	R-410A

4. OPERATION DETAILS

Remote controller

The remote controller transmits signals to the system.

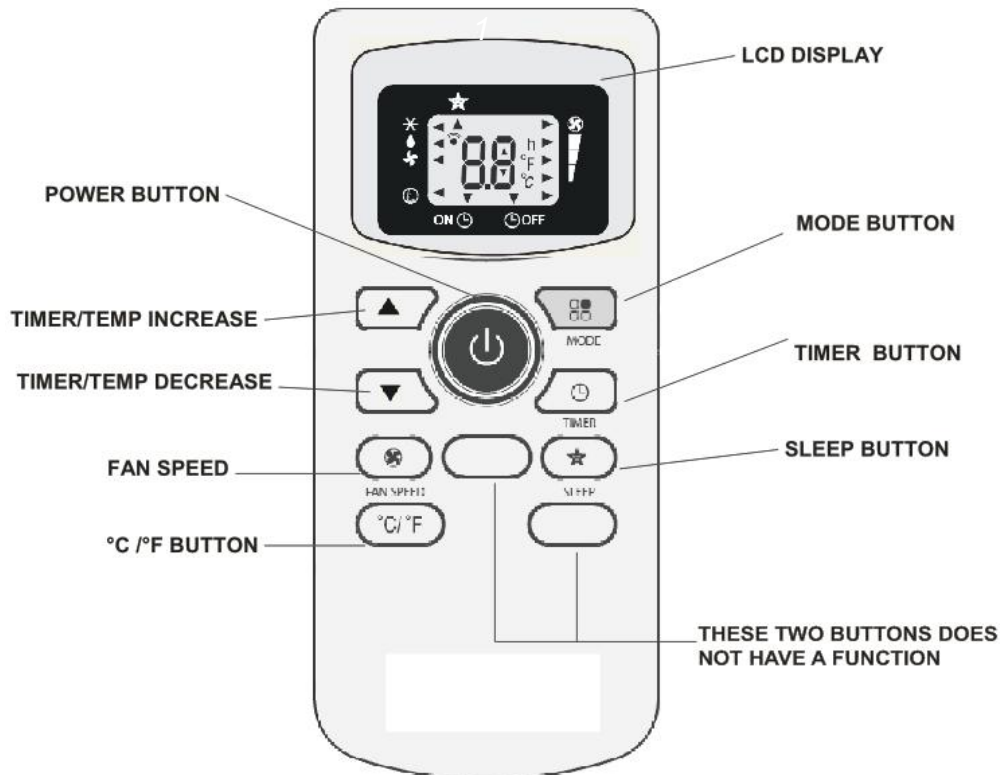

* Remote Colors may differ from the image above.

Remote Control Operating Instructions

- 1) **Power On and Off** - If the unit is already on, press the **POWER**  button on the remote while pointing the remote away from the unit. This will turn the remote on. If the unit is off, now press the **POWER** button once to manually turn the unit on. Press the **POWER** button once more to turn the unit off. When in Air Conditioner mode, the selected temperature will appear on the remote control LCD display. When the unit is in Fan mode, Dehumidifier mode and Auto mode, you will not see anything displayed instead of the set temperature. This shows that temperature selection is not available when the unit is in Fan mode, Dehumidifier mode, and Auto mode.
- 2) **Mode Selection** - Press the **MODE** Button repeatedly to cycle between the different modes: Air Conditioner, Dehumidifier, Fan-Only mode, and Auto. The left side of the remote control LCD display will light up showing which mode is selected. An arrow ◀ will display next to the mode that is selected, indicating which mode the unit is currently operating in.
- 3) **Fan Speed** - Press the **FAN** speed button to cycle through high, medium, low, and auto fan speeds. The display on the remote control will show an arrow ▶ by the current fan speed on the remote control LCD display. When the unit is in Air Conditioner mode and Auto mode, the fan speeds will cycle through in this order: High, Medium, Low, Auto. When the unit is in Dehumidifier mode, the fan speeds will only in auto fan speed. When the unit is in Fan mode, the fan speeds will cycle through in this order: High, Medium, Low. Each change in speed will be associated with a “beep” sound from the unit.

- 4) **Temperature Setting** - When the unit is in Air Conditioner mode you can select your desired temperature. Press the ▲ or ▼ to select your desired temperature setting. The temperature on the LCD display on the remote control will increase or decrease accordingly. Pressing the °C /°F button will change the temperature select between °C and °F.
- 5) **SLEEP MODE** - To set Sleep mode, make sure the unit is in Air Conditioner mode, Dehumidifying mode or Auto mode. Press the **SLEEP** Button on the remote control, the remote control will show an arrow ▲ under the “SLEEP” icon on the remote control LCD display. When in **SLEEP** mode, the fan will run on low to keep fan noise at a minimum. The temperature setting will gradually increase to 1°F above the original set temperature for each of first 2 hours. The unit will keep operating the same temperature for 6 hours and switch to standby mode.
- 6) **TIMER** -
- Auto-On:** To program the timer, when the unit is off, point the remote at the unit and press the **TIMER** button. Once **TIMER** is pressed, the arrow ▼ will display above the **TIMER ON** icon on the remote control LCD display as standby mode. Press the arrow buttons ▲ or ▼ to set the timer. The timer can be set in intervals of 0.5 hours up to 10 hours, then in intervals of 1 hour up to 24 hours. Once the desired time is selected, press the **TIMER** button once more to set it. The arrow ▼ will display above the **TIMER ON** icon on the remote control LCD display to indicate that the timer has been set.

Auto-Off: While the unit is operating, point the remote at the unit and press the **TIMER** button. Once the **TIMER** is pressed, the arrow ▼ will display above the **TIMER OFF** icon on the remote control LCD display. Press the arrow buttons ▲ or ▼ to set the timer. The timer can be set in intervals of 0.5 hours up to 10 hours, then in intervals of 1 hour up to 24 hours. Once the desired time is selected, press the **TIMER** button once more to set it. The arrow ▼ will display above the **TIMER OFF** icon on the remote control LCD display to indicate that the timer has been set.

Operating The Unit

Air Conditioner Mode

- 1) Install the exhaust hose and window kit properly (see pages 7 & 8).
- 2) Plug the Power Cord into an electrical outlet.
- 3) Turn on the unit by pressing the **POWER** button.
- 4) Press the Mode button until the air conditioner mode icon lights up on the control panel display.
- 5) Press the ▲ or ▼ until the desired room temperature appears on the control panel display. The temperature ranges from 64°F - 90°F (18°C - 32°C).
- 6) Select the desired fan speed by pressing the **FAN** button by using the Remote control.

NOTE: During hot days, the unit will cool the room most efficiently by setting the temperature at the lowest setting and the fan speed on high. Reducing the length of the exhaust duct, insulating the exhaust hose and window kit, and keeping direct sunlight to a minimum will also improve the cooling efficiency.

NOTE: When the unit is running on air conditioning mode, the exhaust hose is required and must be vented outside using the supplied window kit.

Dehumidifier Mode

- 1) Install the exhaust hose and window kit properly (see pages 7 & 8).
- 2) Plug the Power Cord into an electrical outlet.
- 3) Turn on the unit by pressing the **POWER** Button.
- 4) Press the **MODE** button until the dehumidifier mode icon lights up on the control panel display.

NOTE: The unit operates at low fan speed during dehumidifier mode. The unit cools room slightly during the dehumidification process. Keep the windows and doors closed to aid the effectiveness of the unit in removing the moisture from the room.

NOTE: When the unit is running on dehumidifier mode, the exhaust hose is required and must be vented outside using the supplied window kit.

NOTE: The unit will not perform in dehumidifier mode when the room temperature is lower than 61°F .

NOTE: The unit can use the drainage at middle of unit back when dehumidifier mode.

1. Counterclockwise to loose the cover.
2. Clockwise to install drainage connector.
3. Connect the hose on connector.



Fan Mode

- 1) Plug the Power Cord into an electrical outlet.
- 2) Turn on the unit by pressing the **POWER** button on the control panel.
- 3) Press the **MODE** button until the fan mode icon lights up on the control panel display.
- 4) Select the fan speed by pressing the **FAN** button.

NOTE: It is not necessary for the exhaust hose and window kit to be installed to operate the unit in fan mode.

Auto Mode

- 1) Install the exhaust hose and window kit properly (see pages 7 & 8).
- 2) Plug the Power Cord into an electrical outlet.
- 3) Turn on the unit by pressing the **POWER** button.
- 4) Press the **MODE** button until the **Auto mode** indicator appears on the control panel display.

NOTE: During Auto mode, the unit operates in Fan mode when the room temperature is below 73°F, and Air Conditioner mode when the room temperature is above 73°F.

CONDENSATE EVAPORATION

Emergency Condensate Holding Tank

When the room temperature is low and the indoor humidity is high, the air conditioner may not be able to evaporate some of the moisture fast enough. When this happens, the water will accumulate in an emergency condensate tank inside the unit. Once the emergency condensate tank is full, the unit will automatically shut off and the control panel will display “Ft” (Full Tank). To empty the condensate tank, pull the drain plug at the bottom back of the unit. You will need a small pan, approximately 1” high to catch the water coming out of the condensate tank. Connect the supplied drainage hose to the back of the unit to aid in drainage into the pan. Once the condensate tank is drained, the unit will begin working within a few minutes. The emergency condensate tank is approximately 1.5 Liters of water. Another option is to purchase a small hose from a hardware store that can fit around the 9/16” drain plug on the back of the unit and drain the unit into a gravity drain or larger pan for continuous drainage. It is not advised to use continuous drainage when the room temperature is higher than 90°F .

The unit, along with the fan will automatically shut off when the unit displays “Ft” (Full Tank).

To resume operation quickly, empty the water container according to the following steps:

1. Do not move the unit when the water container is full.
2. Place the drain pan accessory under the drainage port at the back of the unit.
3. Remove the rubber plug from the drain hole. The condensate water will drain out automatically.
4. When the drain pan is full, install the rubber plug back onto the drainage hole to stop the water flow.
5. Empty the drain pan.
6. Repeat steps 2-5 until all the water is emptied.

NOTE: Once the water container has been emptied, install the rubber plug back onto the drain hole. It is not advised to use continuous drainage when the room temperature is higher than 90°F .



5. WIRING DIAGRAM

MODEL: TAC-08CPA/HA , TAC-10CPA/HA

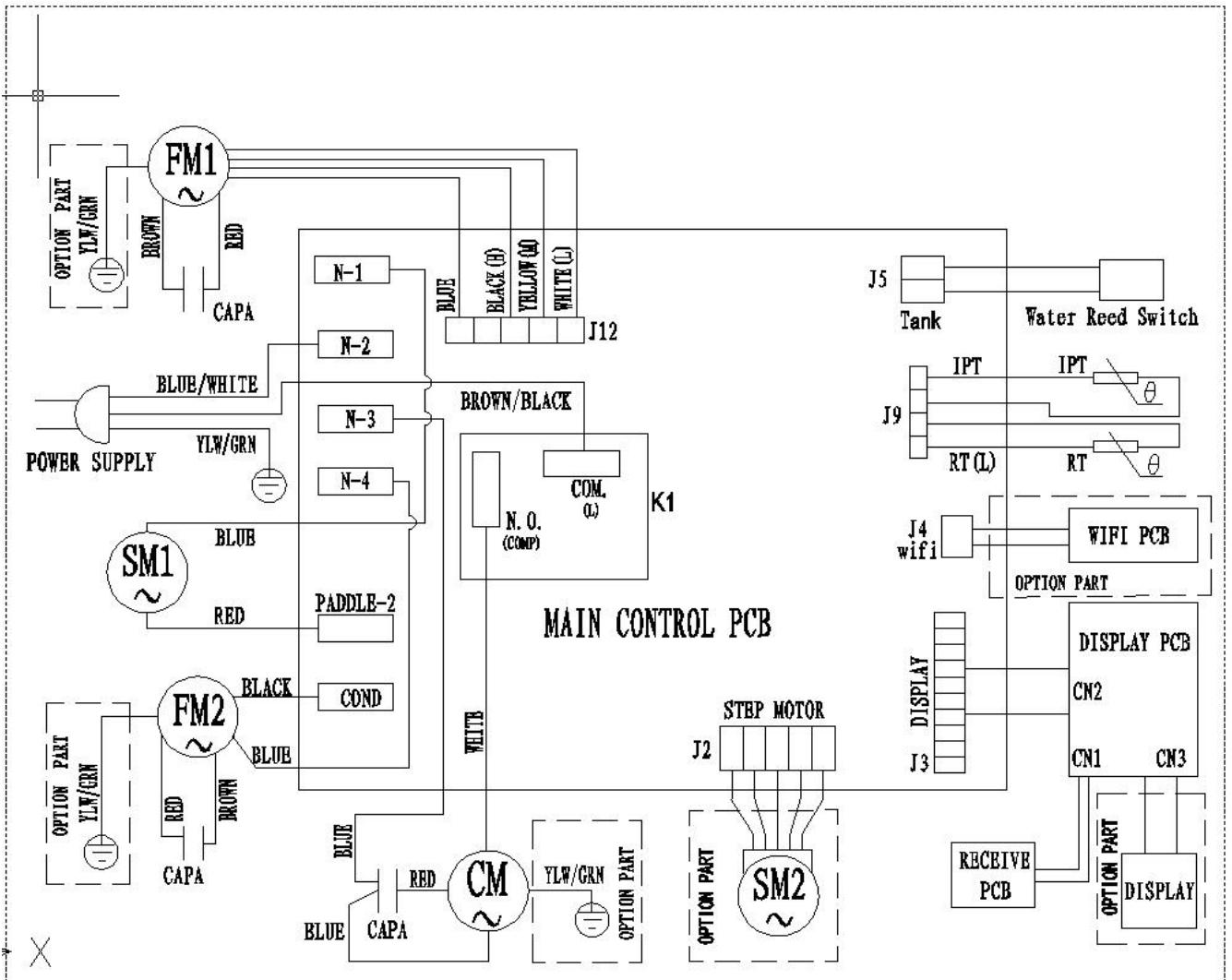

6. EXPLOSION VIEW AND PARTS

EXPLOSION VIEW

MODEL: TAC-08CPA/HA /, TAC-10CPA/HA

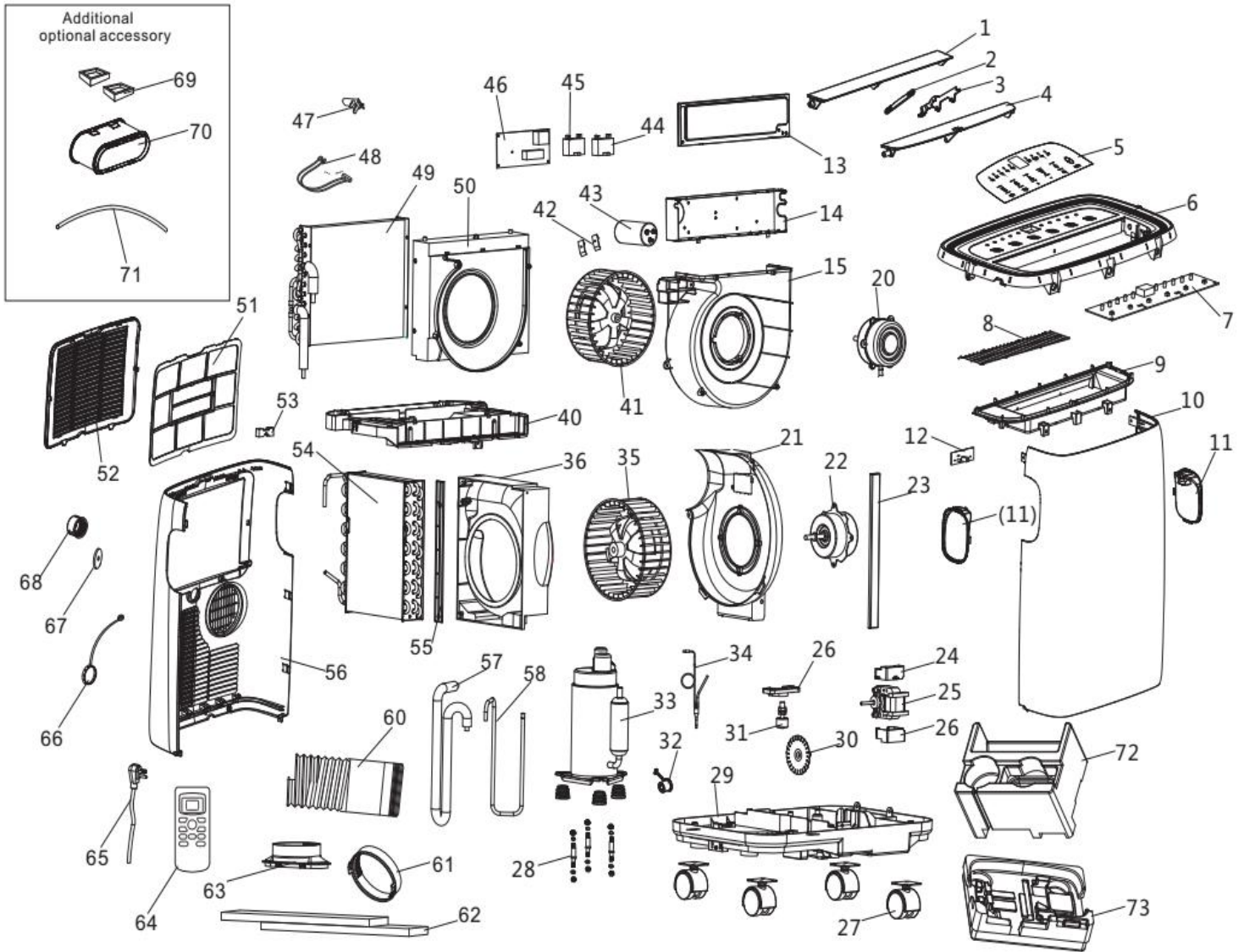

PART LIST

No.	Chinese name	English name	No.	Chinese name	English name
1	水平导风叶2	Horizon deflector 2	41	蒸发器离心风扇	Centrifugal fan of evaporator
2	导风叶连杆	Deflector link	42	电容固定卡	Capacitor clamp
3	导风叶支架	Support of deflector	43	压机运行电容	Capacitor of compressor
4	水平导风叶1	Horizon deflector 1	44	风扇电容6uF	Capacitor of fan motor 6uF
5	控制面膜	Panel sticker	45	风扇电容8uF	Capacitor of fan motor 8uF
6	顶盖	Top panel	46	控制电路板	Control circuit board
7	显示电路板	Display board	47	感温支架	Sensor fixer
8	保护网	Protect net	48	热敏电阻	Sensor resistance
9	出风口	Outlet duct	49	蒸发器部件	Evaporator
10	前面板	Front panel	50	蒸发器风道前部	Front duct of evaporator
11	提手	Handle	51	蒸发器过滤网	Filter of evaporator
12	接收电路板	Receiver board	52	蒸发器格栅	Grill of evaporator
13	电控盒盖	Electrical box cover	53	压线夹	Clamp
14	电控盒	Electrical box	54	冷凝器部件	Condenser
15	蒸发器风道后部	Rear duct of evaporator	55	挡水板	lead of water
20	蒸发器风扇电机	Fan Motor of evaporator	56	后面板	Back panel
21	冷凝器风道后部	Rear duct of condenser	57	回气管组件	Suction pipe
22	冷凝器风扇电机	Fan Motor of condenser	58	排气管	Discharge pipe
23	支撑条	Support	60	排风管	Hose pipe
24	打水电机左护罩	Splash motor left cover	61	风管接头	Hose inlet
25	罩极电机	Splash motor	62	窗架组件	Window slider
26	浮子安装板	Float fix panel	62	无孔外窗架	No-hole window slider
26	打水电机右护罩	Splash moter right cover	63	风管出口	Hose outlet
27	滑轮组件	Castor	64	遥控器组件	Remote controller
28	大平垫圈	Gasket	65	电源线	Power cord
28	压缩机固定螺栓	Bolt for compressor	66	密封盖锁套	Fixer of drainage cover
28	法兰面螺母	Nut	67	外接排水盖密封圈	Seal
28	弹簧垫圈	Gasket	68	水咀密封盖	Cover of drainage hose
28	六角螺母	Nut	69	滑轮锁定板	Stop-wheel
29	底盘	Base	70	窗架接头	Window adapter
30	打水轮	Splash disk	71	排水管	Drainage pipe
31	磁簧开关	Float switch	72	上泡沫垫	Upper foam
32	水塞	Stopper	73	下泡沫垫	Bottom foam
33	压缩机	Compressor			
34	毛细管组件	Capillary			
35	冷凝器离心风扇	Centrifugal fan of condenser			
36	冷凝器风道前部	Front duct of condenser			
40	中隔板	Middle metal panel			

Before installing and using your portable air conditioner, please read this owner's manual carefully. Store this manual in a safe place for future reference.

- 1) Always place the unit on a level surface.
- 2) Never use or store gasoline or other flammable vapor or liquid near this unit unless instructed by this manual.
- 3) Maintain at least 10 inches (25 cm) clearance space around this unit. Do not block or cover air inlet or outlet grilles.
- 4) The unit must be connected to a correctly grounded power supply.
- 5) Do not start or stop the unit by inserting or pulling out the power plug.
- 6) Do not use an adapter plug or extension cord.
- 7) Do not use the unit in the immediate surroundings of a bath, a shower or a swimming pool.
- 8) Do not insert anything into the air outlet. Do not obstruct air inlet or outlet grills unless instructed by this manual.
- 9) Do not let children play near this unit.
- 10) Always inspect the cord for signs of damage before use. If the power cord is damaged, it must be replaced by the manufacturer or a qualified service technician.
- 11) When cleaning the unit, always turn the unit off and unplug the power cord.
- 12) Do not mix old and new batteries in the remote control.

Do not mix Alkaline, Standard (Carbon - Zinc) or Rechargeable (Nickel - Cadmium) Batteries.

8. NAMES OF PARTS

1. Air Outlet Grill
2. Control Panel
3. Carry Handle
4. Casters
5. Power cord
6. Air Filter
7. Middle drainage
8. Air Exhaust
9. Air Intake Grill
10. Condensation Drain hole
11. Exhaust Hose
12. Window Kit Adapter
13. Exhaust hose connector
14. Window Kit Adapter Extension
15. Window Kit
- *16. Caster Locks
- *17. Drainage Hose connector
- *18. Washer
19. Remote Controller
- *20. Drainage Hose
21. Product manual(Not Shown)

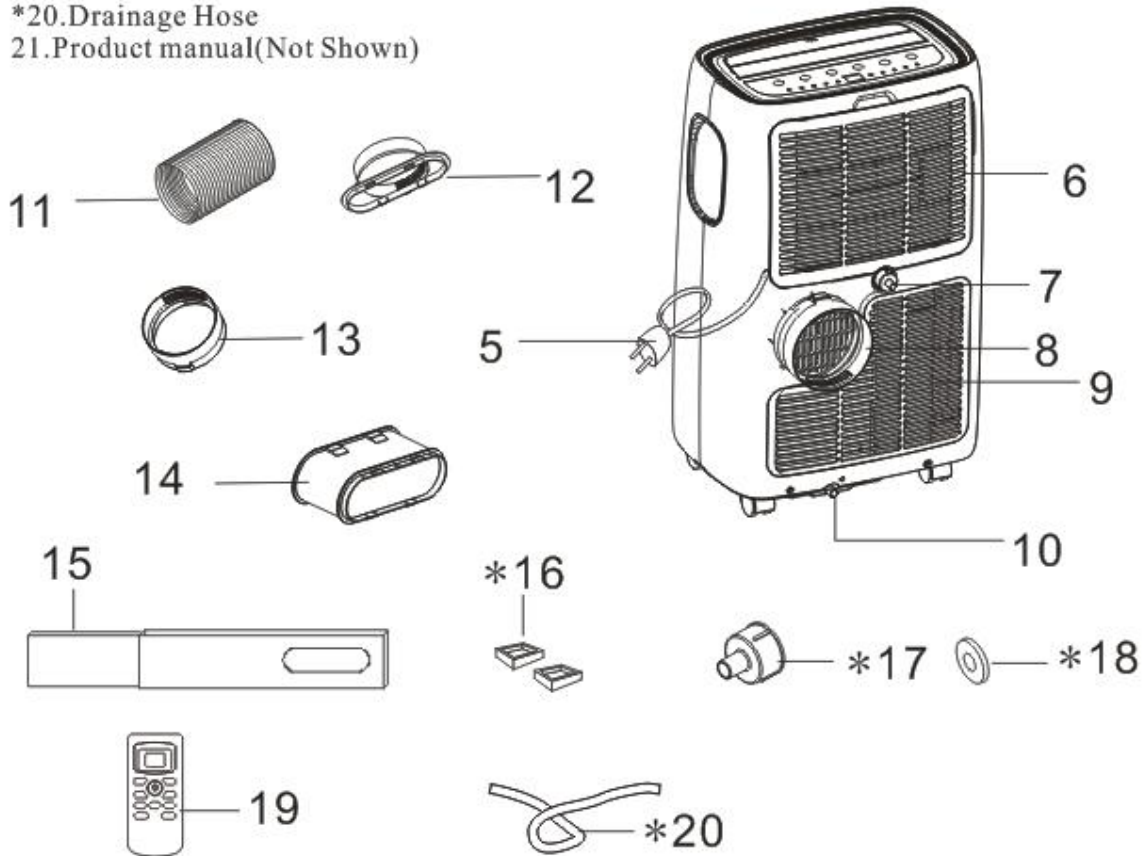
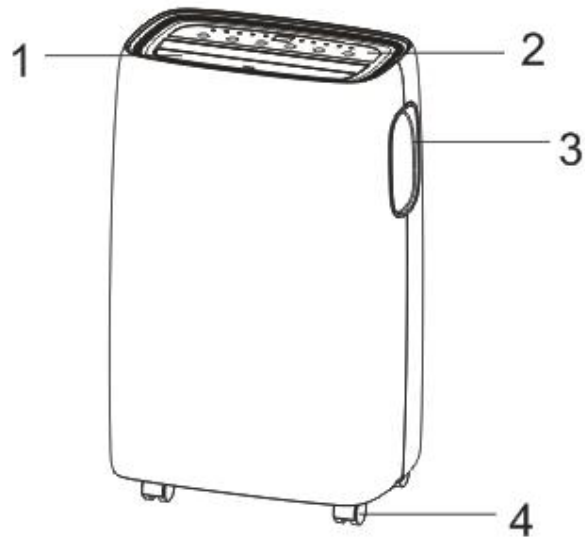

Note: Parts marked with "*" are selected items.

EXHAUST HOSE

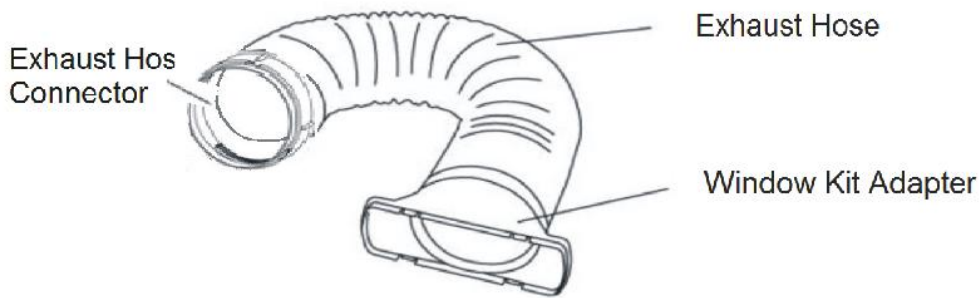

WINDOW KIT

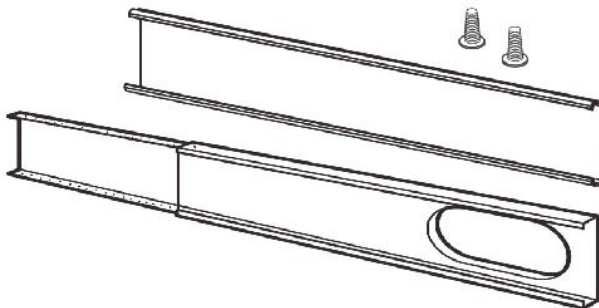

9. INSTALLATION MANUAL

INSTALLATION

When the unit is operating as an air conditioner or dehumidifier, the unit draws in indoor air and exhausts hot air out of the room to complete the air exchange. When the unit is operating in fan mode no outdoor air exchange takes place. The window kit and exhaust hose do not need to be installed when the unit is used as a fan.

NOTE: The supplied window kit can be installed in sliding windows and sliding glass doors up to 4.6 ft. long (approximate length).

MOUNTING THE EXHAUST HOSE

- Choose a suitable location, near a grounded electrical outlet and suitable window or door. Remove packaging and locate components.
- Extend both ends of the exhaust hose approximately 6 inches.
- Screw the window kit adapter onto one end of the exhaust hose counter-clockwise.
- Screw the exhaust hose connector onto the other end of the exhaust hose counter-clockwise.
- Connect the exhaust hose over the Air Exhaust Hose Discharge Opening on the back of the unit.
- Open the window or door and adjust the length of window kit to fit the opening. Then make the kit fixed.

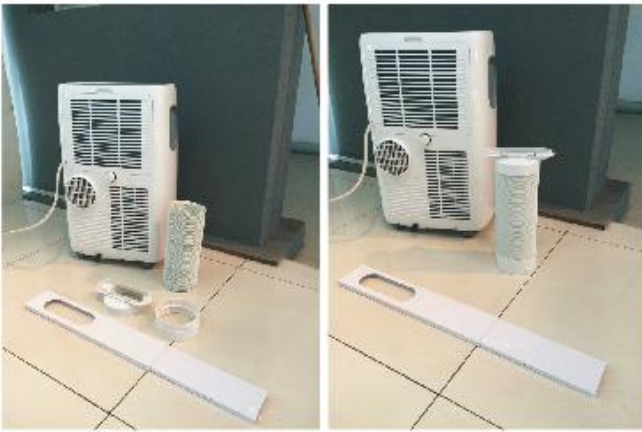

The venting kit must be installed in order for the unit to work correctly in the air conditioning mode, dehumidifying mode, and auto mode. The venting kit should not be used while the unit is fanning.

The window kit has been designed to fit into most vertical and horizontal window openings.

1. Choose a suitable location, near a grounded electrical outlet and a suitable window. Remove packaging and locate components. (Figure a)
2. Screw the exhaust hose connector onto one end of the exhaust hose. (Figure b)
3. Connect the exhaust hose over the discharge opening on back of the unit. (Figure c)
4. Open the window or door and adjust the length of the window kit to fit the opening. (Figure d)
If necessary, mark the kit and cut the end down to properly fit the opening. (Figures e & f)
5. Attach the window kit adapter to the window kit. (Figure g)
6. Place the window kit back into the window and attach the exhaust hose to the window kit adapter. (Figures h & I)
Your Portable Air Conditioner is now ready to use.

NOTE: When using the venting system, keep the exhaust hose as straight as possible. The exhaust hose can be shortened, but it is not recommended to increase the length of the exhaust hose. Do not use an extension cord with your portable air conditioner.

NOTE: The Portable Air Conditioner above may differ from the unit described in this manual. The above directions and images show general directions for Soleus Air single hose portable air conditioners.

WINDOW KIT ASSEMBLY GUIDE

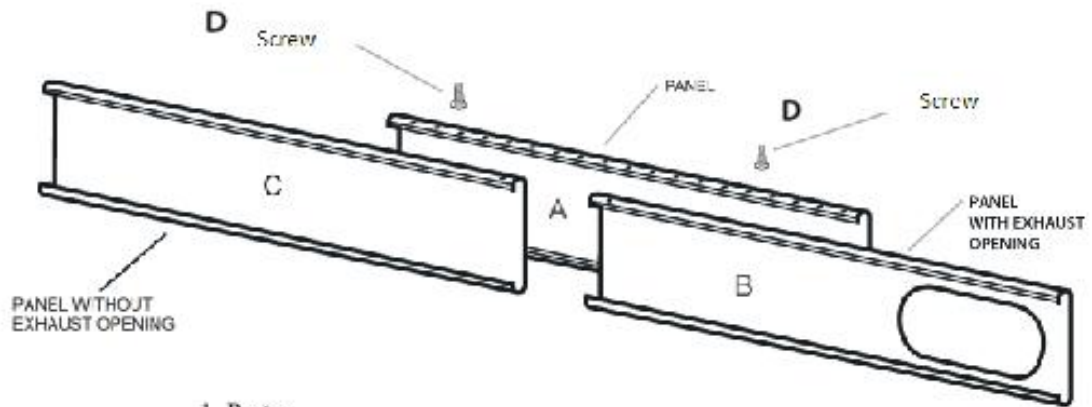

1. Parts:

- A) Panel
- B) Panel with one exhaust hose opening
- C) Panel without exhaust hose opening
- D) Screw to lock window kit in place

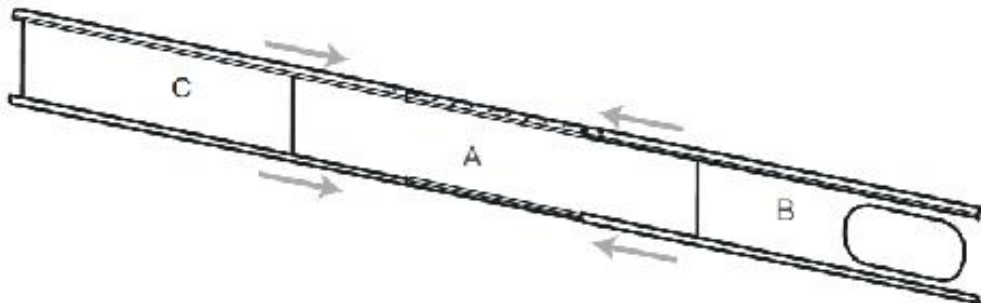

2. Assembly:

Slide Panel B and C into Panel A and size to window width. Windows sizes vary. When sizing the window width, be sure that the window kit assembly is free from gaps and/or air pockets when taking measurements.

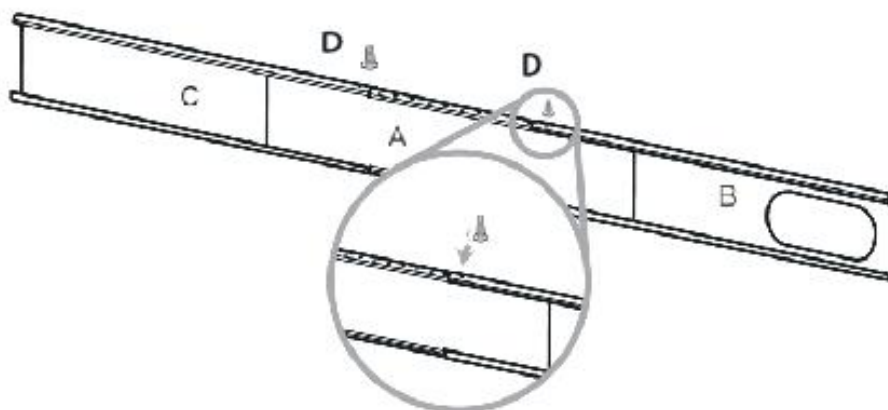

3. Lock the screw into the holes that correspond with the width that your window requires to ensure that there are no gaps or air pockets in the window kit assembly after installation.

10. MAINTENANCE

MAINTENANCE

Note: Make sure power is off and the power cord is not plugged into an electrical outlet prior to performing any maintenance on the unit.

Clean or replace filter - If the air filter is blocked with a dust, the airflow volume may reduce. It is recommended to clean the filter once every two weeks or as needed.

- 1) Remove the filter from the filter compartment on the left of the unit.
- 2) Wash the air filter by immersing it gently into warm water with a neutral detergent. Rinse the filter and dry it thoroughly out of sunlight.
- 3) Slide the filter back into the filter compartment after it is thoroughly dried.
- 4) If the filter is torn or unusable, order a new filter by calling the customer service number on the warranty page of this manual.

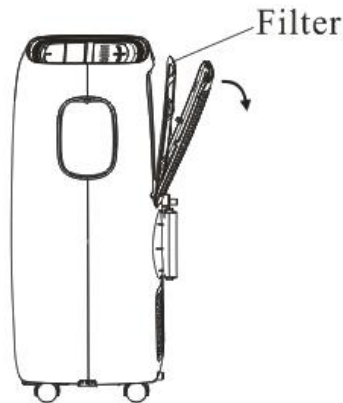

Clean the unit Housing

- 1) Keep the unit from being exposed directly to the sun to prevent color fading.
- 2) Clean the surface with a damp cloth and dry it with a soft towel.

Storing the Unit for an Extended Period of Time or Transporting the unit

- 1) Empty any excess water by unplugging the water drainage stop in the back of the unit (located at the bottom).
- 2) Unplug the unit.
- 3) The unit should be stored in a cool dry place.



DISCLAIMER

ALL INFORMATION AND THE TECHNICAL SPECIFICATIONS PRESENTED IN THIS USER'S MANUAL ARE THE PRESENTATION OF THE MANUFACTURER. SOLEUS HOME COMFORT HAS NOT CONDUCTED INDEPENDENT TEST TO THE INFORMATION AND THE SPECIFICATIONS PRESENTED HEREWITHIN.





11. TROUBLE SHOOTING

TROUBLESHOOTING

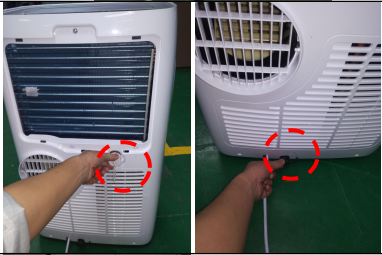

PROBLEM	CAUSE	SOLUTION
Air conditioner does not power on	<ul style="list-style-type: none"> • Unit is not plugged in. • No electric current to outlet. • Internal safety device has tripped. 	<ul style="list-style-type: none"> • Plug unit in. • Check electric breaker box for a trip. • Wait 30 minutes for safety device to reset.
Air conditioner works for a limited amount of time	<ul style="list-style-type: none"> • There are bends in the exhaust hose. • Something is blocking the air from being discharged. 	<ul style="list-style-type: none"> • Position the air exhaust hose correctly, keeping it as short and free of curves as possible. • Check and remove anything obstructing air discharge.
During operation, there is an unpleasant smell in the room	<ul style="list-style-type: none"> • Air filter is dirty. 	<ul style="list-style-type: none"> • Remove air filters, clean and re-install.
Air conditioner does not operate after restarting the unit	<ul style="list-style-type: none"> • The internal compressor safety device prevents the unit from being restarted until three minutes have elapsed since it was last turned off. 	<ul style="list-style-type: none"> • Wait for compressor to turn on.
The control panel display shows Lt/PF/Ft codes	<ul style="list-style-type: none"> • The unit has a self diagnosis system to identify a number of malfunctions. 	<ul style="list-style-type: none"> • See page 17 to diagnosis the code.

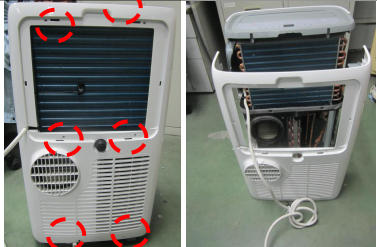
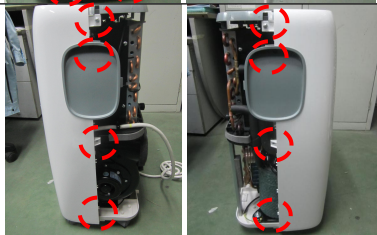



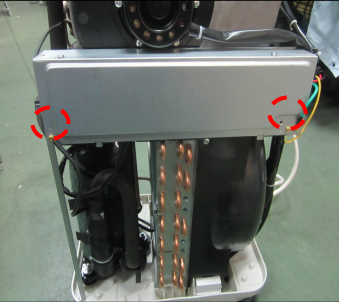
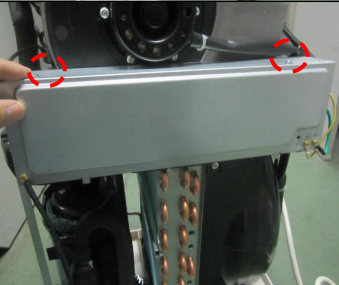
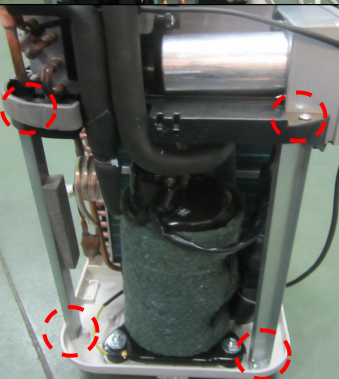
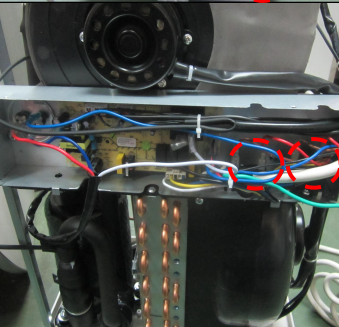
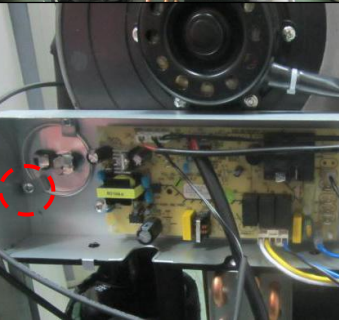
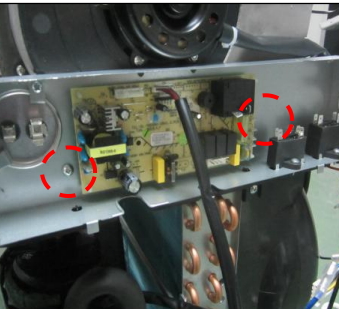

IF IS DISPLAYED,	WHAT SHOULD I DO?
 <p>LOW TEMPERATURE (frost prevention)</p>	<p>The appliance is fitted with a frost protection device to avoid excessive formation of ice. The appliance starts up again automatically when the defrosting process is completed.</p>
 <p>PROBE FAILURE (sensor damaged)</p>	<p>If this is displayed, contact your local authorised service centre.</p>
 <p>FULL TANK (safety tank full)</p>	<p>Empty the internal safety tank. See the CONDENSATION EVAPORATION section on Page 13</p>

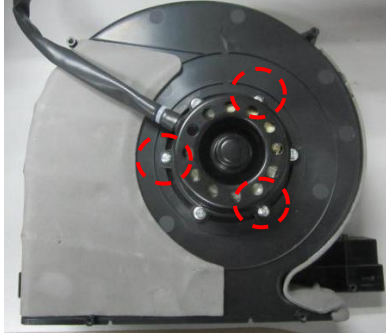
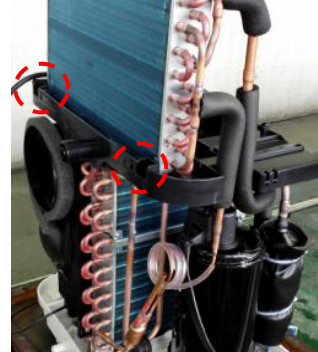
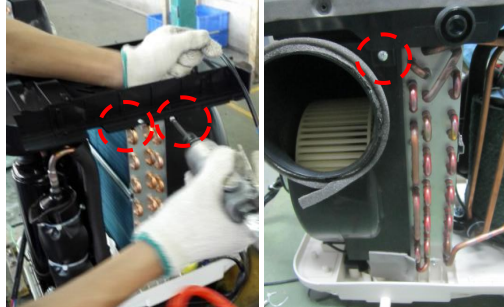
12. DISASSEMBLY PROCEDURE

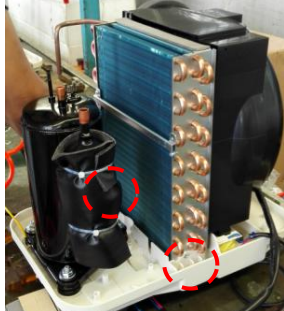
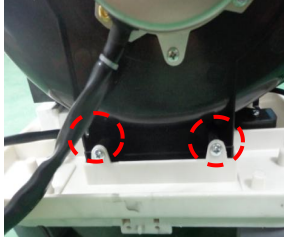
No.	Content	Picture
1	Remove grill of evaporator	
2	Remove cover of drainage hose & Rubber stopper	
3	Unscrew 2 screws between front panel & rear panel	
4	Unscrew 6 screws of rear panel Then remove the rear panel	
5	Unscrew 8 screws of front panel (4 in left side and 4 in right side)	
6	Separate the connectors of the display PCB	
7	Remove top panel	

<p>8</p>	<p>Unscrew 2 ground screws</p>	
<p>9</p>	<p>Unscrew 2 screws To remove the electrical box cover</p>	
<p>10</p>	<p>Unscrew 4 screws To remove the support bars</p>	
<p>11</p>	<p>Unscrew 1 screw of each capacitor (Left for evaporator fan motor and right for condenser)</p>	
<p>12</p>	<p>Unscrew 1 screw, then take out compressor capacitor</p>	
<p>13</p>	<p>Unscrew 2 screws to take out electrical box</p>	

<p>14</p>	<p>Unscrew 6 screws to remove air duct of evaporator</p>	
<p>15</p>	<p>Unscrew 4 screws to remove rear duct of evaporator</p>	
<p>16</p>	<p>Unscrew 1 hexagon nut with flange to remove centrifugal fan of evaporator</p>	
<p>17</p>	<p>Unscrew 3 screws to remove fan motor of evaporator</p>	
<p>18</p>	<p>Unscrew 2 screws of partition panel</p>	
<p>19</p>	<p>Unscrew another 3 screws to remove partition panel</p>	

<p>20</p>	<p>Unscrew 2 screws to remove condenser</p>	
<p>21</p>	<p>Unscrew 2 screws to remove air duct of condenser</p>	
<p>22</p>	<p>Unscrew 2 screws to remove seal bar of condenser</p>	
<p>23</p>	<p>Unscrew 4 screws to remove rear duct of condenser</p>	
<p>24</p>	<p>Unscrew 1 screw nut to remove Centrifugal fan of condenser</p>	
<p>25</p>	<p>Unscrew 4 screws to remove fan motor of condenser</p>	
<p>26</p>	<p>Unscrew 2 screws to remove Float switch</p>	

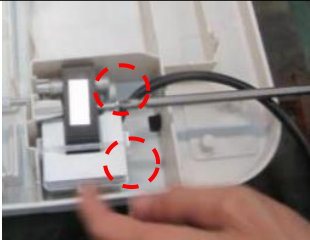
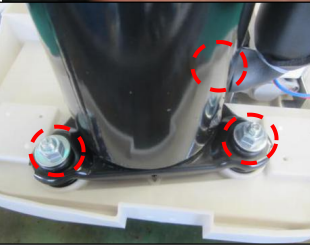
27	Unscrew 2 screws to remove Splash motor		
28	Unscrew 3 screws to remove compressor		



The Creative life



hao.tcl.com

www.tcl.com

www.tcl.com

hao.tcl.com

TCL Home Appliances (Hongkong) Co.,Ltd

H.K.Office:13/F.,TCL Tower,8 Tai Chung Road,Tsuen Wan,Hong Kong

Tel:+852 2437 7315 Fax:+852 2405 8440

TCL Air Conditioner (ZhongShan) Co.,Ltd.

Factory add: No. 59,Nantou Road West,Nantou,Zhongshan.Guangdong,P.R.China

Tel:+86 760 8782 1666 Fax:+86 760 8782 1725

Business Contact: omc@tcl.com/+86 760 2819 7721

Technical Service: ac_tech_service@tcl.com/+86 760 2819 7715

Free Manuals Download Website

<http://myh66.com>

<http://usermanuals.us>

<http://www.somanuals.com>

<http://www.4manuals.cc>

<http://www.manual-lib.com>

<http://www.404manual.com>

<http://www.luxmanual.com>

<http://aubethermostatmanual.com>

Golf course search by state

<http://golfingnear.com>

Email search by domain

<http://emailbydomain.com>

Auto manuals search

<http://auto.somanuals.com>

TV manuals search

<http://tv.somanuals.com>