

# Electronic Deadbolt Installation Instructions

## Package Contents

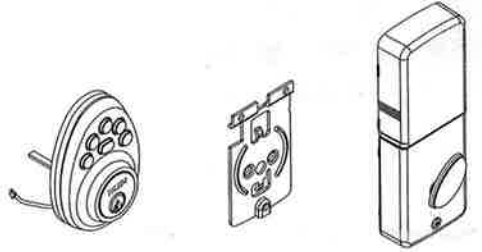

Exterior Assembly      Mounting Plate      Interior Assembly

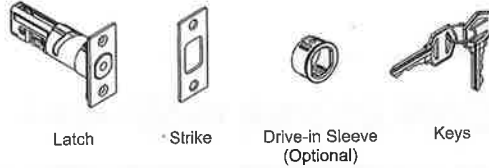

Latch      Strike      Drive-in Sleeve (Optional)      Keys

### Mounting Screws Specifications

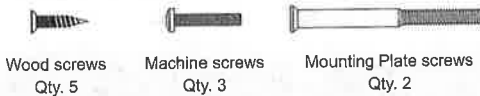

Wood screws Qty. 5      Machine screws Qty. 3      Mounting Plate screws Qty. 2

## Latch Adjustment

Determine if the latch needs to be adjusted to the 2-3/4" (70 mm) backset. To adjust, rotate the latch until it stops. Reverse the direction to return to the 2-3/8" (60 mm) backset.

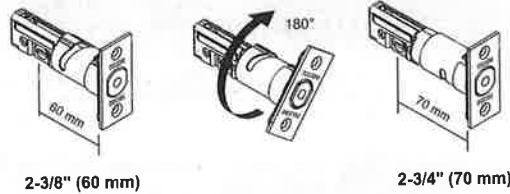

2-3/8" (60 mm)

2-3/4" (70 mm)

## Change Latch Face

Determine which latch mounting method will be used and make necessary adjustments.

- No adjustment required for square latch face plate.  
 a. Use a flat screwdriver to separate the face plate.  
 b. Snap selected latch face onto back plate.

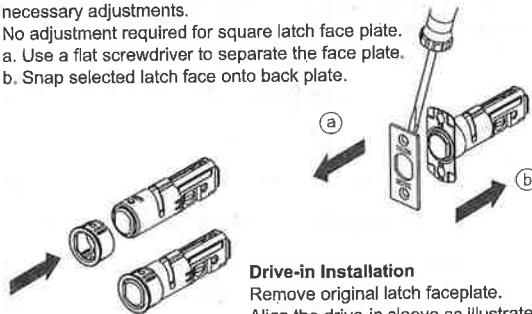

Drive-In Latch

**Drive-in Installation**  
 Remove original latch faceplate. Align the drive-in sleeve as illustrated and snap into the latch case.

## 1. Backset Determination

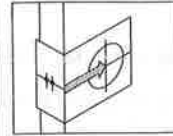

Backset is a distance from door edge to centre of hole on door face. Adjustable latch fits both backset of 2-3/8" (60 mm) and 2-3/4" (70 mm).

## 2. Mark The Door With Template

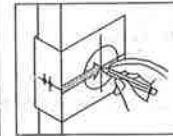

Select the height and backset as desired on the door face; use the TEMPLATE as an indication to mark the centre of the circle on the door face and the centre of the door edge.

## 3. Drill Holes

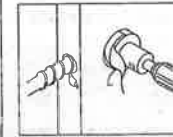

Using the marks as a guide to drill a hole Ø2-1/8" (54 mm) through the door face for the lockset, then a hole of Ø1" (25.4 mm) for latch.

## 4. Install Latch

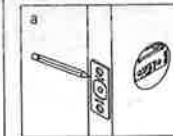

Insert the latch and ensure it is parallel to the door face. Mark the outline of the faceplate, then take out the latch.

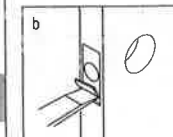

Chisel 5/32" (4 mm) deep along the outline to allow the faceplate to be aligned with the door edge.

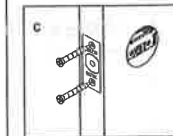

Insert the latch into the door. Use 2 wood screws to secure latch. Please do not fully tighten the screws until lock is completely installed.

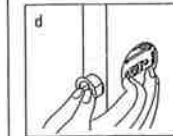

**Install Drive-in Latch**  
 Drive the latch into the hole on edge of door.

## 5. Install Strike

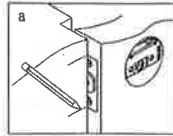

To identify the centre of strike: close the door to lay the latchbolt against the door frame. Mark the centre line on the doorframe exactly opposite the latch hole in the door edge.

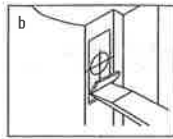

Measure one half of door thickness from door stop and vertically mark centre line of strike. Drill 1" (25.4 mm) hole, 1" (25.4 mm) deep at intersection of horizontal and vertical line of strike. Chisel 5/64" (2 mm) deep along the strike outline to allow the strike to be aligned with the doorframe.

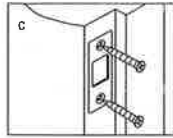

Install the strike plate into your door frame and tighten with wood screws.

## 6. Install Keypad Assembly

Install cylinder into the deadbolt keypad assembly with tailpiece in horizontal position inserted through hub of the latch. Pass the IC wire under the latch to the interior side of the door.

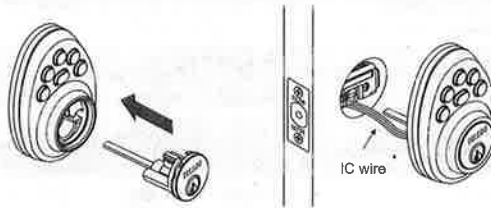

## 7. Install Inside Mounting Plate

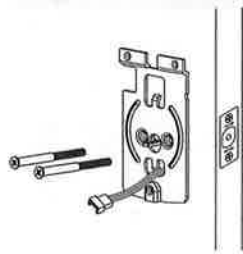

Pass the IC wire through the wire hole of the mounting plate. Fix the mounting plate with screws. If outside lock assembly is lopsided, please loosen the screws to adjust its position and tighten the screws again.

## 8. Identify Door Handing

Face the door from the outside. The door is left-handed if the hinges are on the left side of the door, whereas the door is right-handed if the hinges are on the right side of the door.

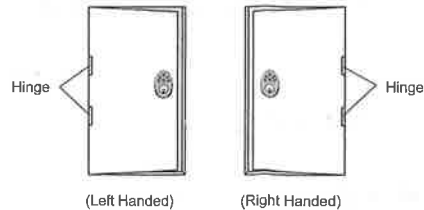

## 9. Adjust Thumb Turn Piece

Rotate the thumb turn piece to the LEFT at 45 degrees for right-handed doors. Rotate the thumb turn piece to the RIGHT at 45 degrees for left-handed doors.

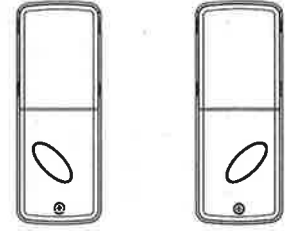

For right-handed door

For left-handed door

## 10. Install Receiver Module

Remove the battery cover (push it up first then pull it out).

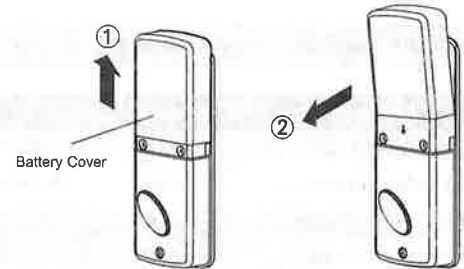

Connect the IC wire into the back of the receiver module. Ensure that the deadbolt tailpiece is engaged with turn piece, then attach receiver module to the door with screw. Use the optional wood screw to secure the receiver module to wood doors only.

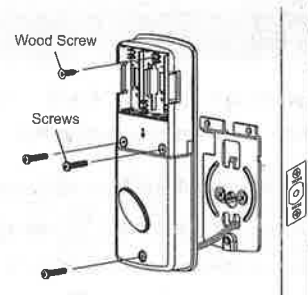

## 8. Identify Door Handing

Face the door from the outside. The door is left-handed if the hinges are on the left side of the door, whereas the door is right-handed if the hinges are on the right side of the door.

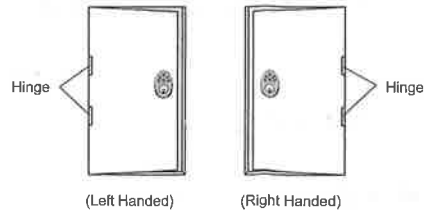

## 11. Insert Batteries

Insert 4 (AA) 1.5 V alkaline batteries and slide the battery cover back onto the receiver module.

Remarks:

(1) Alkaline batteries are recommended in order to stabilize the power supply. If you don't use alkaline, battery performance will be reduced greatly.

(2) All settings will be retained in the memory even if the batteries are completed dead.

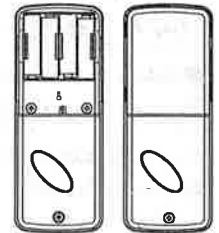

## Instructions

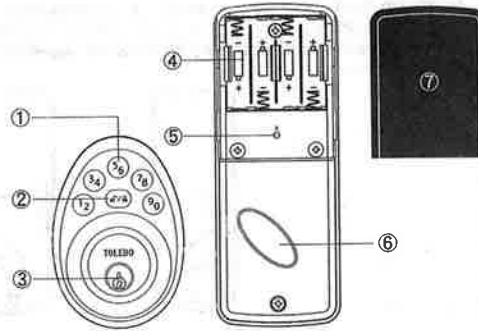

### Remark

1. We recommend to use alkaline battery in order to stabilize the power supply.
2. Do not mix alkaline battery with regular zinc-carbon ones or mixed brands.
3. Do not use any chemical liquid or lubricating oil with additives to clean the lock body, it will damage the surface or even mainboard.

- ① **Number Buttons**  
Input the pass codes, each pass code is 4-10 digits in length.
- ② **Programming Button**  
Function setup & Lock and unlock.
- ③ **Cylinder**  
Retract / Extend the latch bolt by key from exterior.
- ④ **Battery Holder**  
Four AA (1.5 V) alkaline batteries.
- ⑤ **R Button (Reset)**  
Restore default settings.
- ⑥ **Turn-piece**  
To lock/unlock the lockset from inside.
- ⑦ **Battery Lid**  
Slide the lid to change the batteries.

## Operation Indicator Sounds and Lights

Lights	Sounds	Meaning	Troubleshooting
Flashes Green Once	1 Beep	Successful Operation	
Flashes Green Twice	2 Beeps	Successful Programming	
Flashes Green 3 Times	3 Long Beeps	Default Setting Restored	Repeat Setting
Flashes Red 3 Times	3 Beeps	Operation Error	Repeat Operating
Flashes Red 5 Times	5 Beeps	Code Input Error, System Shuts Down	Waiting for 45 seconds Repeat Operating
Flashes Red 10 Times	10 Rapid Beeps	Low Battery Power	Chang the Battery
Flashes Orange Slowly		In Programming Mode	

## Settings

**Programming Code (PC) : 0000    User Code (UC) : 1234**

Your new programming codes (PC) \_\_\_\_\_ Your new User Code (UC) \_\_\_\_\_

### ■ Door Handing Identification Process

Enter PC → \* / # → 90 → \* / #

Note : New installation or restoring default setting, you must run the door handing identification process first.

### ■ Create new User Code (UC)

Enter PC → \* / # → 12 → \* / # → Enter New UC → \* / #

Note : Up to 6 sets of User Codes can be saved. User Codes should be 4-10 digits in length.

### ■ Delete individual User Code (UC)

Enter PC → \* / # → 34 → \* / # → Enter New UC → \* / #

### ■ Delete all User Codes (UC) at once

Enter PC → \* / # → 56 → \* / #

Note : Keypad locking functions will be invalld when User Codes are deleted. The lock can only be operated by key during that time.

### ■ Change Programming Code (PC)

Enter PC → \* / # → 78 → \* / # → Enter New PC → \* / #

### ■ Toggle Auto-Lock On/Off



Note : Default is Off, once you enable it the default auto-lock delay time is 30 seconds. If you want to change the auto-lock delay time, please refer to function setting of Auto-Lock Delay Time. If you want to disable the auto-lock function, please repeat the function setting of Auto-Lock On/Off.

### ■ Auto-Lock Delay Time



Note : Auto-lock delay time code: 1 - 10 seconds, 3 - 20 seconds, 5 - 30 seconds, 7 - 40 seconds, 9 - 50 seconds

### ■ Toggle Mute On/Off



Note : Even the lock is mute while the mute setting is on, the LED lights are still functional. If you want to turn off the mute setting, please repeat the function setting of Mute On/Off.

### ■ Enable/Disable All User Codes



Note : Auto-locking and keypad locking functions will be invalid when user codes are disabled. The lock can only be operated by key during the time. Repeat the steps to enable the user codes again.

### ■ Create a One-Time User Code



Note : The one-time user code will automatically cancel after it is used one time.

### ■ Restore Default Settings

Note : Insert a pin into the hole under the bottom opening for 5 seconds. Three long beeps will indicate the restoration is completed.

## Trouble Shooting

PROBLEM	POSSIBLE CAUSE	CORRECTIVE ACTION
After installing the lockset and batteries, the door can't be locked and three short beeps are emitted when you press the lock button.	The door-handing identification process isn't yet complete.	Refer to settings step1.
You've installed the lockset and batteries, but you still get no response when you press any button.	Batteries were installed incorrectly and cable connect incorrectly.	Check to see if the battery polarities have been reversed or if the battery is dead. If so, re-install or change the battery. If not, please check to see if the cable is properly connected.
When you are in the door-handing identifying process, you get the red light flashing three times, and three short beeps.	Wrong door-handing or change of the door-handing in the memory.	Press the R button to restore the system to factory default setting and re-execute door-handing identifying process (Refer to settings step 1)
While the door is locked, you hear the latch bolt coming out when you press the to lock the door, however, three short beeps are emitted. Conversely, while the door is open, no beeps are emitted when locking the latch bolt.	(1) The depth of the latch bolt hole is insufficient. (2) The latch bolt is not aimed at the opening of the strike.	(1) Dig the latch bolt hole for the strike deeper. The minimum depth is 1" (2.5 cm). (2) Adjust the strike to the appropriate position.

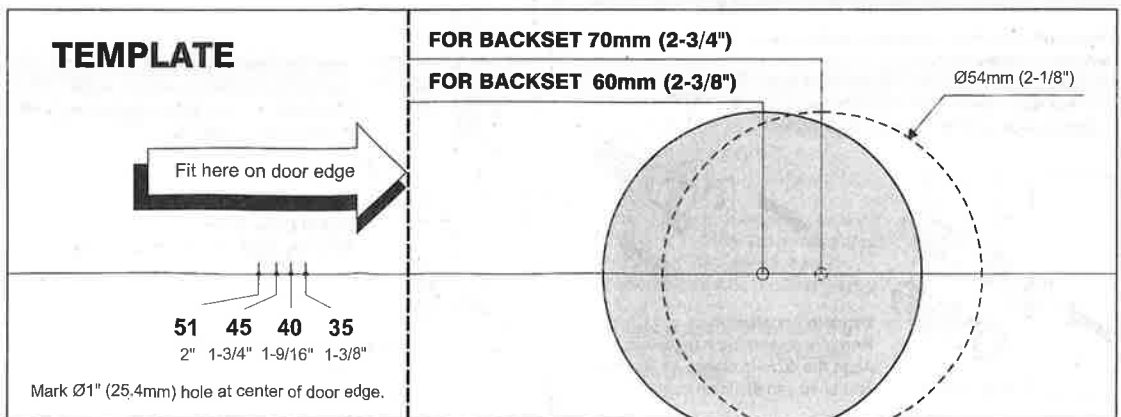

## Free Manuals Download Website

<http://myh66.com>

<http://usermanuals.us>

<http://www.somanuals.com>

<http://www.4manuals.cc>

<http://www.manual-lib.com>

<http://www.404manual.com>

<http://www.luxmanual.com>

<http://aubethermostatmanual.com>

Golf course search by state

<http://golfingnear.com>

Email search by domain

<http://emailbydomain.com>

Auto manuals search

<http://auto.somanuals.com>

TV manuals search

<http://tv.somanuals.com>