



**Self cleaning  
Hot & Cold Hidden  
Bottle Water Cooler  
with Display**

**Model # 8LDIECH-SC-WFC-SSF**

## **USER MANUAL**

### **⚠ WARNING**

TO REDUCE THE RISK OF INJURY AND PROPERTY DAMAGE, USER MUST READ THIS MANUAL BEFORE ASSEMBLING, INSTALLING & OPERATING DISPENSER.

**SAVE THIS MANUAL FOR  
FUTURE USE**

# SAFETY PRECAUTIONS

---

## WARNING

**To reduce risk of injury and property damage, user must read this entire manual before assembling, installing & operating dispenser.**

**Failure to execute the instructions in this manual can cause personal injury or property damage.**

**This product dispenses water at very high temperatures. Failure to use properly can cause personal injury.**

**When operating this dispenser, always exercise basic safety precautions, including the following:**

- Prior to use, this dispenser must be properly assembled and installed in accordance with this manual.
- This dispenser is intended for water dispensing only. Do NOT use other liquids. Do NOT use for other purposes. Never use any other liquid in the dispenser other than known and microbiologically safe bottled water. Warranty is void if used for any other liquids including coffee, tea, juices, beer or wine.
- For indoor use only. Keep water dispenser in a dry place away from direct sunlight. Do NOT use outdoors.
- Install and use only on a hard, flat and level surface.
- Do NOT place dispenser into an enclosed space or cabinet.
- Do NOT operate dispenser in the presence of explosive fumes.
- Position back of dispenser no closer than 4 inches from wall and permit free airflow between wall and dispenser. There must be at least 4 inches clearance on the sides of the dispenser to permit airflow.
- Use only properly grounded outlets.
- Do not use an extension cord with your water dispenser.
- Always grasp plug and pull straight out from outlet. Never unplug by pulling on power cord.
- Do NOT use dispenser if cord becomes frayed or otherwise damaged.
- To protect against electric shock, do NOT immerse cord, plug, or any other part of cooler in water or other liquids.
- Ensure dispenser is unplugged prior to cleaning.
- Never allow children to dispense hot water without proper and direct supervision. Unplug unit to prevent unsupervised use by children.
- Service should be performed only by a certified technician. Please contact us at 888-828-1426 for assistance.

**IMPORTANT: Do NOT Return Dispenser To Store.**  
If you have a question or problem, please contact 888-828-1426 for assistance.

# SAFETY PRECAUTIONS --Electrical Requirements

## **WARNING**

### **Electrical Shock Hazard**

Plug into a grounded 3 prong outlet.  
Do not remove ground prong.  
Do not use an adapter.  
Do not use an extension cord.  
Failure to follow these instructions can result in death, fire, or electrical shock.

A 120 volt, 60 Hz., AC only, 15 amp, fused electrical supply is required. A time-delay fuse or circuit breaker is recommended. Do not overload the circuit, provide separate circuit, if required, to serve only this appliance.

This water cooler is equipped with a power supply cord having a 3 prong grounding plug.

To minimize possible shock hazard, the cord must be plugged into a mating, 3 prong, grounding-type outlet, grounded in accordance with local codes and ordinances, a mating outlet is not available, it is the personal responsibility and obligation of the customer to have the properly grounded outlet installed by a qualified electrician.

If codes permit and a separate ground wire is used, it is recommended that a qualified electrician determine that the ground path is adequate.

Do not ground to a gas pipe.

Check with a qualified electrician if you are not sure the water cooler is properly grounded.

Do not have a fuse in the neutral or ground circuit.

### **GROUNDING INSTRUCTIONS**

For a grounded, cord-connected water cooler:

This water cooler must be grounded. In the event of a malfunction or breakdown, grounding will reduce the risk of electrical shock by providing a path of least resistance for electric current. This water cooler is equipped with a cord having an equipment-grounding conductor and a grounding plug. The plug must be plugged into an appropriate outlet that is properly installed and grounded in accordance with all local codes and ordinances.

## **WARNING**

Improper connection of the equipment-grounding conductor can result in a risk of electric shock. Check with a qualified electrician or serviceman if you are in doubt as to whether the appliance is properly grounded.

Do not modify the plug provided with the appliance-if it will not fit the outlet, have a proper outlet installed by a qualified electrician.

**“Please make sure that ELECTRICAL OUTLET IS PROPERLY WIRED TO CORRECT SIZED CIRCUIT BREAKER OR FUSE AND PROPERLY GROUNDED. MUST BE WIRED TO HAVE CORRECT POLARITY.”**

**IMPORTANT: Do NOT Return Dispenser To Store.**  
If you have a question or problem, please contact 888-828-1426 for assistance.

# TABLE OF CONTENTS

---

Safety Precautions .....	2
Safety Precautions-Electrical Requirements .....	3
Key Information for Future Use .....	4
Specifications .....	5
Parts & Features .....	5
Assembly .....	6
Cleaning Prior to Initial Use .....	6
Installation .....	7
Operation .....	8
Proper Care & Cleaning .....	12
Display's Operation explanation .....	14
Troubleshooting .....	16
Limited Warranty .....	17

## KEY INFORMATION FOR FUTURE USE

---



Please register your dispenser immediately at [www.electrotemp.com](http://www.electrotemp.com)

For future support please record your serial number (located on label on back of dispenser) and date purchased. Staple your receipt to manual.

You will need this information to obtain warranty service.

Product **Self Cleaning Hot & Cold Hidden Bottle Water Cooler With Display**

Model Number **8LDIECH-SC-WFC-SSF**

Serial ID Number \_\_\_\_\_

Date of Purchase \_\_\_\_\_

**IMPORTANT: Do NOT Return Dispenser To Store.**  
If you have a question or problem, please contact 888-828-1426 for assistance.

# SPECIFICATIONS



Power Supply	5 AMPs
Refrigerant Type	R-134A
Cold Water Power	< 100Watts
Cold Capacity / Peak Hour	1 Gallon / 3.79 L
Cold Temp Range	3°C – 10°C / 37.4°F - 50°F
Hot Water Power	425 Watts
Hot Capacity / Peak Hour	1 Gallon / 3.79 L
Hot Temp Range	80°C – 92°C / 176°F - 197.6°F
Dimensions	102.8 cm H x 32 cm W x 38.2 cm D 40.8 inch H x 12.6 inch W x 15 inch D
Net Weight	37.5 lbs / 17Kg

# PARTS & FEATURES

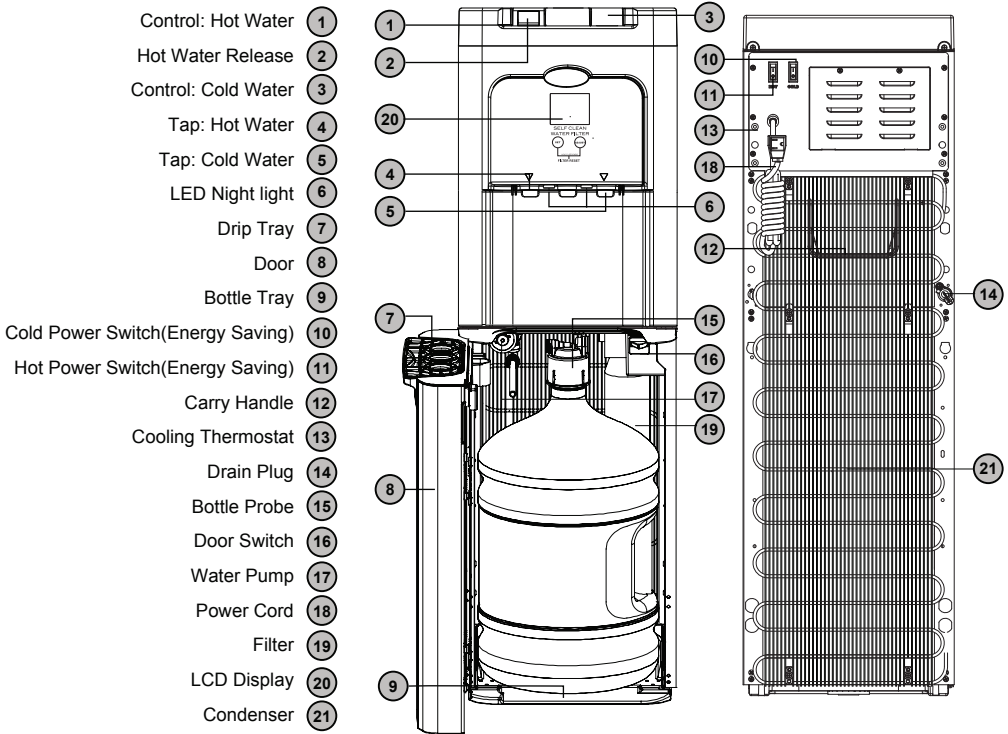

**IMPORTANT: Do NOT Return Dispenser To Store.**  
 If you have a question or problem, please contact 888-828-1426 for assistance.

# ASSEMBLY

## **⚠ WARNING**

**Keep plastic bags away from children.**

1. Remove dispenser from packaging.
2. Unpack drip tray and insert into dispenser.
3. Remove protective packaging from around probe.
4. Properly dispose all of packaging.

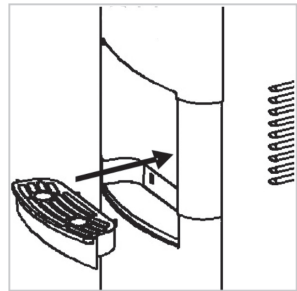

## CLEANING PRIOR TO INITIAL USE

**To remove any odors or dust that may collect during shipment, you must clean dispenser prior to first use.**

Time Required: 45 minutes.

1. Move dispenser away from wall and turn it 90° in either direction.
2. Turn power switches to OFF.
3. Unplug power cord from wall outlet.
4. Remove water bottle and probe from water bottle.
5. Place a 2 gallon or larger bucket under the probe assembly.
6. Dis-assemble probe assembly wash probe parts by hand in soapy water or in the dishwasher.
7. Remove air filter and wash in soapy water.
8. Submerge probe hand in the soapy water and rinse properly.
9. Assemble back all parts of probe assembly.
10. spray dispensing nozzles of water faucets with chlorine solution (1 teaspoon of unscented bleach in one glass of water ).

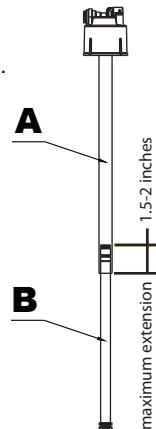

**IMPORTANT: Do NOT Return Dispenser To Store.**  
If you have a question or problem, please contact 888-828-1426 for assistance.

11. Place a 2 gallon or larger bucket under the drain plug in the rear of the dispenser.

### **⚠ CAUTION HOT WATER**

Remove drain cap and silicon plug. Cool water will immediately flow into the bucket. Several seconds later hot water will dispense. Be mindful to avoid injury.

12. Once the unit has drained, replace the silicon plug and drain cap.
13. Remove the remaining water from the reservoirs by dispensing from the cold tap into a pitcher.

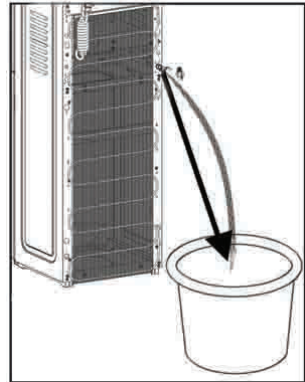

### **Rinsing**

14. Repeat steps 2 to 13, but this time using clean tap water. During the rinsing procedure step 8 only requires 3 minutes or until the pump stops.
15. Complete the installation and operation instructions within this manual. If your water has an off taste. Do not return to store. Call 888-828-1426 for assistance.

## **INSTALLATION**

---

1. Place dispenser upright.
2. Locate dispenser on a hard and level surface in a cool shaded location near a grounded wall outlet.  
Notice: Do NOT plug in power cord yet.
3. Position dispenser so the back is at least 4 inches from wall and there are at least 4 inches of clearance on both sides.
4. To minimize vibration and noise, make sure dispenser is level.

**Notice: Do NOT plug in power cord yet.**

**IMPORTANT: Do NOT Return Dispenser To Store.**  
If you have a question or problem, please contact 888-828-1426 for assistance.

# OPERATION

## ⚠ CAUTION

This dispenser is intended for water dispensing only. Do NOT use other liquids. Do NOT use for other purposes. Warranty is void if used for any other liquids including coffee, tea, juices, beer or wine.

This dispenser has been designed to use water bottles with a 3, 5 or 5.2 gallon capacity. Do NOT use alternative bottles.

### Initial Set Up

Do NOT plug in until steps 1-3 are completed.

1. Allow unit to sit upright for 4 hours.
2. This model uses an pump to force water from the bottle to the reservoirs:
  - a. Please do the following:
    - i. Clean bottle cap and neck.
    - ii. Remove entire plastic cap from bottle.
    - iii. Adjust length of probe by pulling B portion of tube to its maximum extension. Insert probe into bottle and push down. Probe will self adjust to appropriate length. See illustration on right.
    - iv. Push down on probe head until it is seated.
    - vi. Insert power plug into wall outlet.
  - b. At initial start-up it will take about 3 minutes for the reservoirs to load.
3. Install bottle.
  - Open door and place fresh bottle in front of tray.
  - Clean fresh bottle with a soft cloth and warm soapy water then rinse.
  - **Remove entire plastic cap from top of bottle.**
  - Insert probe into bottle.
  - Push down on probe until it is seated.

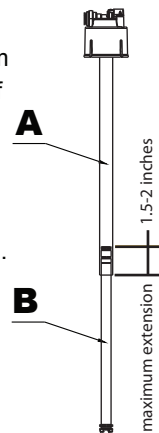

**IMPORTANT: Do NOT Return Dispenser To Store.**  
If you have a question or problem, please contact 888-828-1426 for assistance.



**NOTICE:** When using a 5 gallon rectangular bottle, slide into place as shown in illustration below.

- If the probe tube A and B are not sealed, pump will run few minutes and night lights will flash. To correct - open door, re-attach probe and close door.
- If the lights continue to flash, your bottle may be empty or there may be an issue with water tube lines. Call 888-828-1426 for assistance.

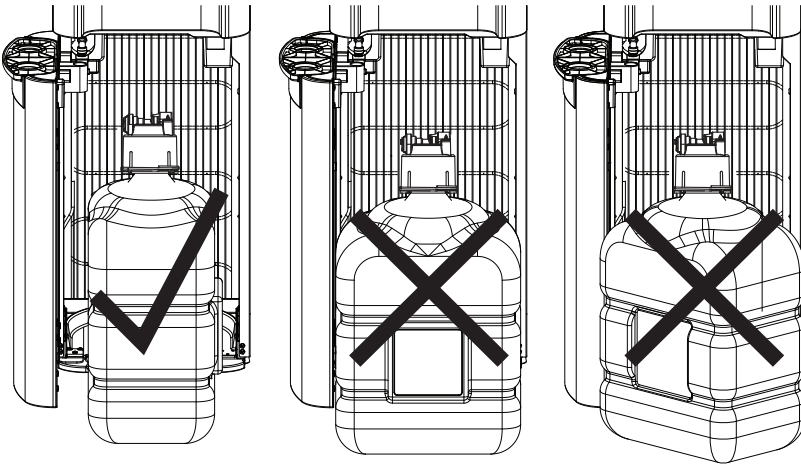

4. Plug cord into a properly grounded wall outlet.
  - Water will be pumped into the hot and cold water reservoirs from the bottle.
5. Turn energy saving switches on back of dispenser to ON.
  - The red switch controls the heating of water. If you do not want hot water, leave this switch OFF
  - The blue switch controls the cooling of water. If you do not want cold water, leave this switch OFF.

**Notice:**

- For unit to operate properly the probe head must be seated on the bottle and the door must be fully closed.
- It will take up to 3 minutes for the reservoirs to load. During this time the pump will run on and off. This is normal.
- Each time you dispense water from the taps, the pump will come on to refill the tanks. This is normal.

**IMPORTANT: Do NOT Return Dispenser To Store.**  
If you have a question or problem, please contact 888-828-1426 for assistance.

## Initial Rinsing of Water Lines

This unit has been tested and sanitized prior to packing and shipping. During transit dust and odors can accumulate in the tank and lines. You must dispense and dispose at least one quart of water prior to drinking any water.

## Dispense Cold Water

Note: After setup, it will take 1 hour to get water to maximum cold temperature. During this time the compressor may run continuously. This is normal.

1. Position bottle, glass, pitcher or cooking pot securely below cold water tap.
  - The right triangle below the cold water control indicates the location of the cold water tap.
  - The circular shapes in the drip plate help align the flow of water. This unit dispenses water at a fast rate. To avoid splashes, hold cup as close to the tap as possible.
2. Depress right control downward to start flow.
3. Release control once desired fill level is achieved.

## Dispense Hot Water



**This unit dispenses water at temperatures that can cause severe burns. Avoid direct contact with hot water. Keep children and pets away from unit while dispensing. Never allow children to dispense hot water without proper and direct supervision.**

Note: After setup, hot water will be available in 15-20 minutes.

1. Position bottle, glass, pitcher or cooking pot securely below hot water tap.
  - The left triangle below the hot water control indicates the location of the hot water tap.
  - The circular shapes in the drip plate help align the flow of water. This unit dispenses water at a fast rate. To avoid splashes, hold cup as close to the tap as possible.
2. Push hot water release button (red) inward and depress control downward to start flow.
3. Release control once desired fill level is achieved.

**IMPORTANT: Do NOT Return Dispenser To Store.**  
If you have a question or problem, please contact 888-828-1426 for assistance.

## **Replace an Empty Bottle**

Notice: When your bottle is empty the dispenser will beep intermittently and the LED nightlights will blink until a fresh bottle is connected.

You may also hear a sucking sound when the bottle empties. This is normal and is another way to be alerted that your bottle is empty.

Replace empty bottle as soon as you notice it is empty. If unavailable, leave door ajar or unplug cooler to stop beeping noise and flashing lights.

There may be a small amount of water left in the bottle. This is normal, if you need assistance please contact customer service.

1. Open door and slide bottle out.
2. Remove probe from bottle:
  - Pull probe straight up until completely out of bottle.
3. Install fresh bottle:
  - Place fresh bottle in front of tray.
  - Clean fresh bottle with a soft cloth and warm soapy water then rinse.
  - Remove entire plastic cap from top of bottle.
  - Insert probe into bottle.
  - Push down on probe until it is seated.
  - Slide bottle onto tray and close door completely.

**IMPORTANT: Do NOT Return Dispenser To Store.**  
If you have a question or problem, please contact 888-828-1426 for assistance.

# PROPER CARE & CLEANING

---

## General Cleaning

Perform: As needed

Time Required: 5 minutes.

Note: Do NOT use abrasive materials or chemical cleaners.

1. Clean cabinet surfaces with a soft cloth and warm soapy water.
2. Wipe dust from back of dispenser to improve efficiency.
3. Remove drip tray assembly by sliding it forward. Remove cover. Place tray and cover in dishwasher or wipe parts clean with a soft cloth and warm soapy water.

## Sanitizing

Perform: Every 3 months or whenever an off-taste occurs.

Time Required: 30 minutes.

Note: Best to do prior to loading a fresh bottle.

### Step A: Remove Existing Water

1. Move dispenser away from wall and turn it 90° in either direction.
2. Turn energy saving switches to OFF.
3. Unplug power cord from wall outlet.
4. Remove water bottle and probe from water bottle.
5. Place a 2 gallon or larger bucket under the drain plug in the rear of the dispenser.

### **⚠ CAUTION HOT WATER**

6. Remove drain cap and silicon plug. Cold water will immediately flow into the bucket. Several seconds later hot water will dispense.  
Reminder - Place drain cap and silicon plug in a safe location so they are not lost.
7. Once unit has drained, replace silicon plug and drain cap.

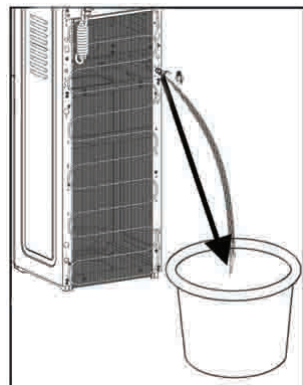

**IMPORTANT: Do NOT Return Dispenser To Store.**  
If you have a question or problem, please contact 888-828-1426 for assistance.

8. Remove remaining water from reservoir by dispensing from the cold tap into a pitcher.

### **Step B: Sanitize Probe and Taps**

1. In a clean bucket, make a sanitizing solution of 1.5 gallons of tap water and 3 tablespoons of unscented household bleach.
2. Wipe probe and area around all taps with a soft cloth moistened with the sanitizing solution.

### **Step C: Sanitize Reservoirs**

1. Remove the cap from a spare empty 5 gallon bottle.
2. Fill the bottle with the water and bleach mixture.
3. Insert probe into bottle .
4. Slide bottle into cabinet and close door.
5. Plug power cord into a grounded wall outlet.
6. Turn energy saving switches ON.
7. Allow the water and bleach mixture to fill the empty reservoirs.
8. Wait 10 minutes then turn energy saving switches OFF and unplug the power cord.
9. Dispense 1 cup of the water/bleach solution through each tap to clean out the water ways.
10. Place a 2 gallon or larger bucket under the drain plug in the rear of the dispenser.

### **CAUTION HOT WATER**

11. Remove drain cap and silicon plug. Cold water will immediately flow into the bucket. Several seconds later hot water will dispense.  
Reminder - Place drain cap and silicon plug in a safe location so they are not lost.
12. Once unit has drained, replace silicon plug and drain cap.
13. Remove remaining water from reservoir by dispensing from the cold tap into a pitcher.

### **Step D: Rinse Reservoirs**

1. Dispose of the water and bleach mixture and rinse bottle with tap water.
2. Fill the bottle with tap water and insert probe into bottle.
3. Push down on probe until it is seated.
4. Slide bottle into cabinet and close door.
5. Plug power cord into a grounded wall outlet.
6. Turn energy saving switches ON.

**IMPORTANT: Do NOT Return Dispenser To Store.**  
If you have a question or problem, please contact 888-828-1426 for assistance.

7. Allow the water to fill the empty reservoirs.
8. Wait 10 minutes then turn energy saving switches OFF and unplug the power cord.
9. Place a 2 gallon or larger bucket under the drain plug in the rear of the dispenser.

### **⚠ CAUTION HOT WATER**

10. Remove drain cap and silicon plug. Cold water will immediately flow into the bucket. Several seconds later hot water will dispense.  
Reminder - Place drain cap and silicon plug in a safe location so they are not lost.
11. Once unit has drained, replace silicon plug and drain cap.
12. Remove remaining water from reservoir by dispensing from the cold tap into a pitcher.
13. Return the unit to its location, install a fresh water bottle, plug the power cord back into the grounded wall outlet and turn the energy saving switches ON.
14. Display shows time of the day, every 30 seconds it will flash time of next self cleaning, When self cleaning occurs it will flash words: "SELF CLEANING" Display time setting.
15. How to switch Off Beeping signal:  
Bottle icon on the display will flash and beep when bottle is empty.  
To turn beeper off touch for 3 seconds words on the panel marked BEEP ON/OFF  
Beep ON or OFF markings are shown here.

## Display's Operation explanation

---

### SET the clock

- System just electricity, the clock default from 12:00 PM start the timer.
- Hold SET key for 3 seconds until hours digital started to flash.
- At this time to press the buttons ADJUST can adjust an hour, continued hold can quickly setting hours Numbers.
- SET to complete press SET key sure to save, then minutes digital started to flash.
- At this time to press the buttons ADJUST can adjust a minute, continued hold can quickly set up minutes Numbers.
- SET to complete and press SET key sure to save, withdraw from the clock SET condition.
- The clock will correct operation, unless the machine power supply to be cut, the clock will return to 12:00 PM start the timer.

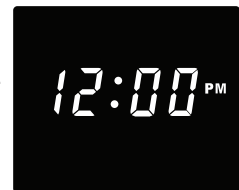

**IMPORTANT: Do NOT Return Dispenser To Store.**  
If you have a question or problem, please contact 888-828-1426 for assistance.

### Since the cleaning function

- Since the cleaning function every 4 hours to be automatic operation time.
- 6 times for one Day, time were 12 PM, 4 PM, 8 PM, 12 AM, 4 AM, 8 AM.
- Execution since before and after CLEANING function 1 minute, the screen prompt SELF CLEANING, said it was the CLEANING.

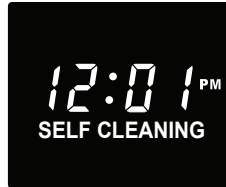
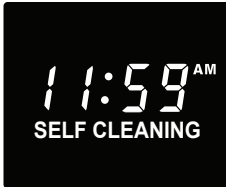

### Self cleaning forecast function

- Display the clock 30 seconds after appear a self-cleaning forecast, remind users from cleaning in the next time.

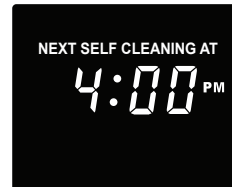

### FILTER CHANGE counting function

Your filter has life of 3 months from the time of use or 300 liters of bottled water, whichever comes first.

Display will show 15 bottles after you place first bottle into your dispenser. It will show one less each time you change the bottle.

To make counter run properly you must change bottle only after EMPTY Bottle alarm is shown on the display. (Flashing picture of the water bottle). Your display will show "0" bottles either after you had used 15 bottles of water, or after the expiry of 3 month's time.

"FILTER CHANGE" will flash to reminder you to change new filter.

Counter Reset:

After changing filter, hold two sensors, SET + ADJUST together for 3 seconds to reset filter counter again.

Normally display shows time of the day. Every 30 seconds there will be display of bottles left until the change of filter. This display will be on for 5 seconds.

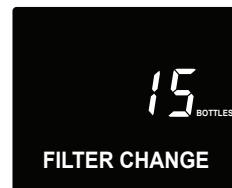

**IMPORTANT: Do NOT Return Dispenser To Store.**  
If you have a question or problem, please contact 888-828-1426 for assistance.

# TROUBLESHOOTING

---

## **Dispenser does not operate.**

- Make sure the power cord is properly connected to a working outlet.

## **Water is leaking.**

- Bottle may have a leak. Remove bottle and replace with new bottle.
- If leak remains, remove probe from bottle and call 888-828-1426 for assistance.

## **Push buttons are stuck and/or faucets are leaking.**

- Apply mineral oil (baby oil) to button slides to reduce friction.

## **No water is coming from the taps.**

- Make sure the bottle is not empty. If so, replace it. If not, adjust probe to an appropriate length. Refer to page 7 point 2 for instructions.
- Make sure to push the water controls in fully.
- Make sure the probe connection with the water bottle forms a complete seal.
- Make sure the door is closed.

## **Cold water is not cold.**

- It takes up to one hour after setup to dispense cold water.
- Make sure the back of the dispenser is at least 4 inches from a wall and there is free airflow on all 4 sides of the dispenser.
- Make sure energy saving switch is ON.
- Adjust thermostat by turning clockwise. Adjust in a single increment of 30 degrees of a circle (the equivalent of 1 hour on a standard analog clock face). Wait 1 hour for results. If unsatisfactory, adjust another 30 degrees clockwise, wait, then assess results. Thermostat is located at back of unit.

## **Hot water is not hot.**

- It takes 15-20 minutes after setup to dispense hot water.
- Make sure the power cord is properly connected to a working outlet.
- Make sure energy saving switch is ON.

## **LED nightlights are flashing and dispenser is making beeping noises.**

- Replace empty bottle. If unavailable, leave door ajar or unplug cooler to stop beeping noise and flashing lights.
- There may be an air leak. Check air hose connections.

## **Dispenser is noisy.**

- Make sure dispenser is positioned on a level surface.

## **Water tastes bad.**

- Drain water from reservoirs and replace bottle with a fresh one.
- Clean dispenser per Proper Care & Cleaning instructions.

**IMPORTANT: Do NOT Return Dispenser To Store.**  
If you have a question or problem, please contact 888-828-1426 for assistance.



## LIMITED WARRANTY

---

Electrotemp Technologies Inc., (“Vendor”) warrants to the original purchaser of this dispenser, and to no other person, that if this dispenser is assembled and operated in accordance with the printed instructions accompanying it, then for a period of one (1) year from the date of purchase, all parts in such dispenser shall be free from defects in material and workmanship. Vendor may require reasonable proof of your date of purchase from an authorized retailer or distributor. Therefore, you should retain your sales slip or invoice. The Limited Warranty shall be limited to repair or replacement of parts, which prove defective under normal use and service and which Vendor shall determine in its reasonable discretion upon examination to be defective. Before returning any parts, you should contact Vendor’s Customer Service Department using the contact information listed below. If Vendor confirms, after examination, a defect covered by this Limited Warranty in any returned part, and if Vendor approves claim, Vendor will replace such defective part without charge. If you return defective parts, transportation charges must be prepaid by you. Vendor will return replacement parts to original purchaser, freight or postage prepaid.

The Limited Warranty does not cover any failures or operating difficulties due to accident, abuse, misuse, alteration, misapplication, improper installation or improper maintenance or service by you or any third party, or failure to perform normal and routine maintenance on the dispenser, as set out in the User’s Manual. In addition, the Limited Warranty does not cover damages to the finish, such as scratches, dents, discoloration or rust after purchase.

The Limited Warranty is in lieu of all other express warranties. Vendor disclaims all warranties for products that are purchased from seller other than authorized retailers or distributors. AFTER THE PERIOD OF THE ONE (1) YEAR EXPRESS WARRANTY, VENDOR DISCLAIMS ANY AND ALL IMPLIED WARRANTIES, INCLUDING WITHOUT LIMITATION THE IMPLIED WARRANTIES OF MERCHANTABILITY AND FITNESS FOR A PARTICULAR PURPOSE. FURTHER, VENDOR SHALL HAVE NO LIABILITY WHATSOEVER TO PURCHASER OR ANY THIRD PARTY FOR ANY SPECIAL, INDIRECT, PUNITIVE, INCIDENTAL, OR CONSEQUENTIAL DAMAGES. Vendor assumes no responsibility for any defects caused by third parties. This Limited Warranty gives the purchaser specific legal rights; a purchaser may have other rights depending upon where he or she lives. Some jurisdictions do not allow exclusion or limitation of special, incidental or consequential damages, or limitations on how long a warranty lasts, so the above exclusion and limitations may not apply to you.

Warranty is void if electrical outlet is improperly wired to incorrectly sized circuit breaker or fuse, if not grounded properly, or wires do not have correct polarity.

Electrotemp Technologies Inc.  
406 Watline Avenue  
Mississauga, Ontario, L4Z-1X2  
888-828-1426  
www.electrotemp.com

**IMPORTANT: Do NOT Return Dispenser To Store.**  
If you have a question or problem, please contact 888-828-1426 for assistance.

名称：网销说明书8LDIECH-SC-WFC-SSF(GLACIAL)-English  
图号：5M009433X1

技术要求：

- 1、尺寸：143 × 210mm
- 2、单色印刷
- 3、产品符合Rosh要求
- 4、批量生产前一定要样品确认，  
不得擅自更改图纸

设计：

审核：

批准：

## Free Manuals Download Website

<http://myh66.com>

<http://usermanuals.us>

<http://www.somanuals.com>

<http://www.4manuals.cc>

<http://www.manual-lib.com>

<http://www.404manual.com>

<http://www.luxmanual.com>

<http://aubethermostatmanual.com>

Golf course search by state

<http://golfingnear.com>

Email search by domain

<http://emailbydomain.com>

Auto manuals search

<http://auto.somanuals.com>

TV manuals search

<http://tv.somanuals.com>