



User Manual

Avigilon Network Video Recorder

HD-NVR4-PRM-64TB, HD-NVR4-PRM-96TB, HD-NVR4-PRM-128TB and HD-NVR4-PRM-157TB

© 2020, Avigilon Corporation. All rights reserved. AVIGILON, the AVIGILON logo, AVIGILON CONTROL CENTER and AVIGILON APPEARANCE SEARCH are trademarks of Avigilon Corporation. Other names or logos mentioned herein may be the trademarks of their respective owners. The absence of the symbols ™ and ® in proximity to each trademark in this document or at all is not a disclaimer of ownership of the related trademark. Avigilon Corporation protects its innovations with patents issued in the United States of America and other jurisdictions worldwide (see [avigilon.com/patents](https://www.avigilon.com/patents)). Unless stated explicitly and in writing, no license is granted with respect to any copyright, industrial design, trademark, patent or other intellectual property rights of Avigilon Corporation or its licensors.

This document has been compiled and published using product descriptions and specifications available at the time of publication. The contents of this document and the specifications of the products discussed herein are subject to change without notice. Avigilon Corporation reserves the right to make any such changes without notice. Neither Avigilon Corporation nor any of its affiliated companies: (1) guarantees the completeness or accuracy of the information contained in this document; or (2) is responsible for your use of, or reliance on, the information. Avigilon Corporation shall not be responsible for any losses or damages (including consequential damages) caused by reliance on the information presented herein.

Avigilon Corporation
avigilon.com

PDF-NVR4PRM-A

Revision: 3 - EN

20200110

Table of Contents

Introduction	1
Before You Start	1
Overview	1
Front View	1
Back View	2
Installation	4
Package Contents	4
Installing the Rack Rails and Cable Management Arm	4
Connecting Cables	4
Installing the Bezel	5
Configuring Windows 10	5
Activating and Configuring ACC™ Software	6
Troubleshooting	6
Network Configuration	6
Checking System Health	6
Operating System Recovery By Avigilon Recovery Partition	6
Operating System Recovery By External USB	8
Advanced Features	9
Checking System Health	9
Replacing a Hard Drive Blank	10
Replacing Hard Drives	11
Replacing Front or Back Hard Drives	12
Replacing Center Hard Drives	12
LED Indicators	15
Diagnostic Indicators	15
Power Status Indicators	15
Network Link Status Indicators	16
Hard Drive RAID Status Indicators	17
For More Information	18

Introduction

The Avigilon Network Video Recorder is preloaded with the Avigilon Control Center software and is configured for maximum performance and reliability. The Network Video Recorder can be easily integrated into any existing Avigilon security system, or act as the base of a new site.

Before You Start

Avigilon recommends the use of an uninterruptible power supply (UPS) system to protect your video surveillance system hardware. A UPS system is used to protect critical equipment from mains supply problems, including spikes, voltage dips, fluctuations and complete power failures using a dedicated battery. It can also be used to power equipment during the time it takes for a standby generator to be started and synchronized.

Any UPS connection must include configuration to shut down the Windows operating system on the appliance when battery power is low or there is 15 minutes of power remaining.

It is recommended that cameras not be connected to the appliance until after the appropriate network configuration has been set up.

Overview

Front View

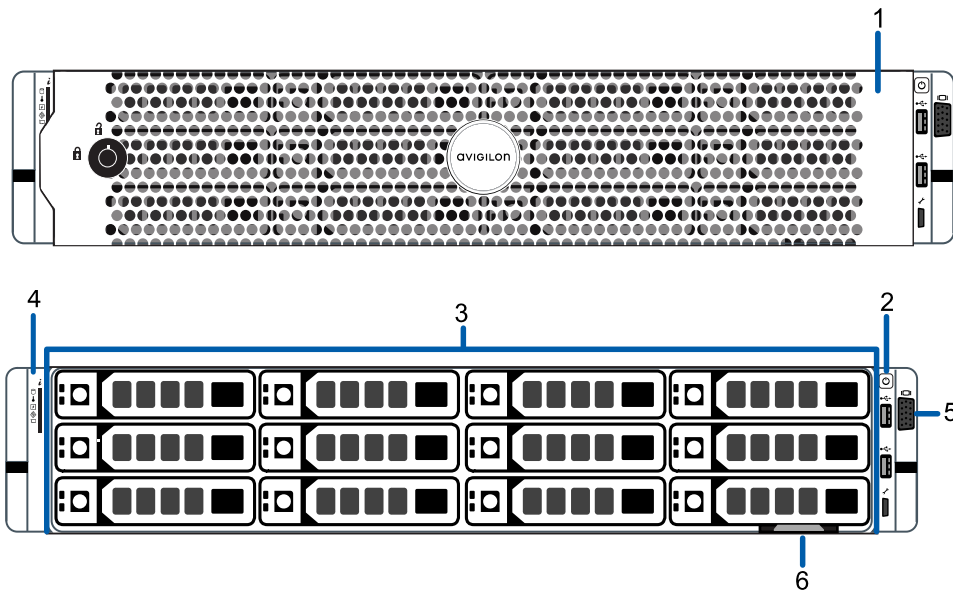

1. **Bezel**
Protects against unauthorized physical access to the hard drives.
2. **Power button**
Controls the power supply to the recorder.
3. **Hard drives**
Provides access to hot-swappable hard drives. There are LED indicators on each hard drive.
Some drives may contain an empty hard drive tray.
4. **Diagnostic indicators**
Provides information about system operations.
For more information, see *LED Indicators* on page 15.
5. **Video connector**
Accepts a VGA monitor connection.
6. **Information tag**
Provides the product service details and support information.

Back View

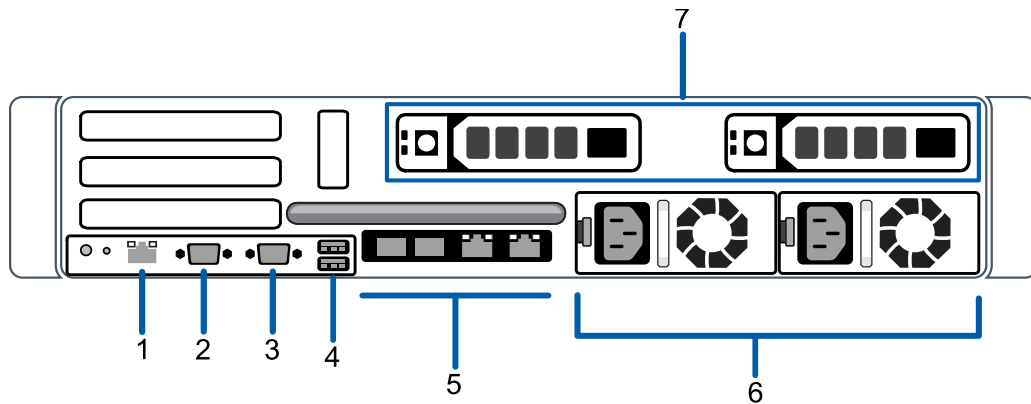

1. **Out-of-Band Management (OOBM) connector**
Accepts an OOBM RJ-45 connection.
2. **Serial connector**
Accepts connections to serial devices.
3. **Video connector**
Accepts a VGA monitor connection.
4. **USB connectors**
Accepts USB connections to external devices.

5. **Two(2) SFP+ 10 Gbps and Two(2) RJ-45 1 Gbps Ethernet ports**

Accepts Ethernet connections to multiple networks.

6. **Power supply**

Two hot swappable redundant power supply.

7. **Hot-swappable hard drives**

Two hot-swappable hard drives that are part of the storage array.

Installation

Package Contents

Ensure the package contains the following:

- Avigilon Network Video Recorder
- Rack sliding rail assembly kit
- Cable management arm assembly kit
- Bezel and key
- Power cables (may be provided in a separate box)

Installing the Rack Rails and Cable Management Arm

If the recorder will be kept in a server rack, install the Rack Sliding Rails and the Cable Management Arm provided in the recorder package. Follow the procedures outlined in the *Rack Installation Instructions* and the *CMA Installation Instructions* provided in the assembly kits.

Note: The supplied Rack Sliding Rails are compatible with square and round hole racks.

Connecting Cables

Refer to the diagrams in the Overview section for the location of the different connectors. Make the following connections as required:

1. Connect a KVM switch or separate keyboard, mouse and monitor to the recorder.
 - The keyboard and mouse can be connected to any USB port on the recorder.
 - The monitor can be connected to any video connector at the front or back of the recorder.
2. Connect the recorder to your network using an Ethernet cable.
3. For out-of-band management access and functionality, connect Ethernet cable to the OOBM connector.
4. Connect a power cable to each power supply at the back of the recorder.
5. Press the power button on the front of the recorder. Check that the recorder LED indicators display the correct status.

Installing the Bezel

The bezel can be installed on the front of the recorder to help protect the hard drives against unauthorized access.

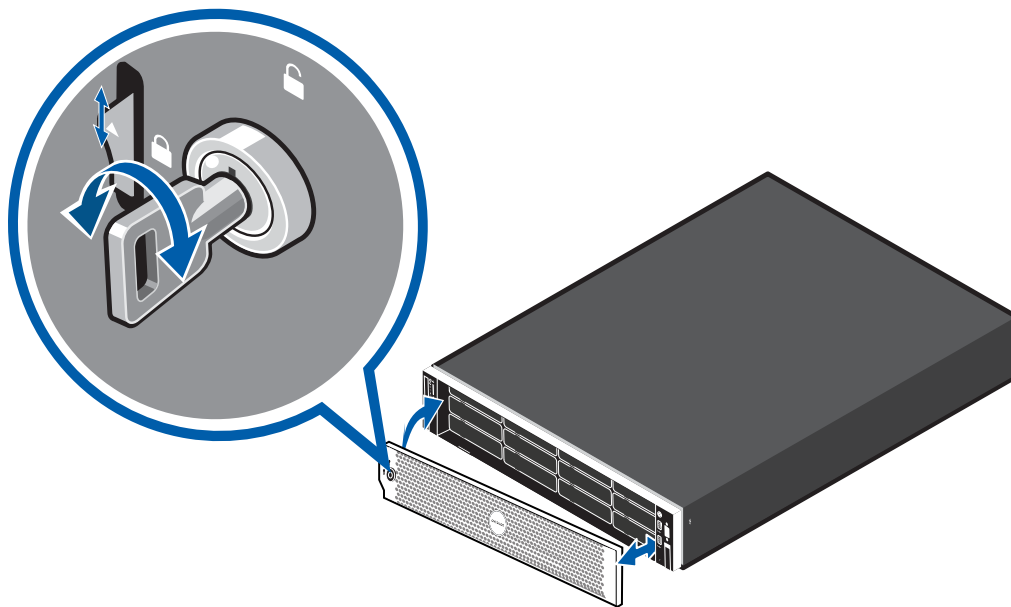

1. Align and insert the right end of the bezel until it clicks into place.
2. Push the left end of the bezel into the front of the unit until it clicks into place.
3. Use the provided key to lock the bezel.

Configuring Windows 10

After the recorder starts, you will need to configure the Windows operating system for the first time.

1. On the first screen, the MICROSOFT SOFTWARE LICENSE TERMS and AVIGILON CONTROL CENTER™ SOFTWARE END USER LICENSE AGREEMENT are displayed. Review the terms and click **Accept**.
2. Select **Join a local Active Directory domain**.

Note: This prompt appears only if an Active Directory is present on the network. See the *Windows Help and Support* files for more information.

3. Enter a user name for accessing the Windows software.
4. Enter a password and password hint for the user name and click **Next**.

5. After a minute, choose the ACC version in use at your site.

You are logged in to the Windows environment. The Avigilon Control Center Admin Tool automatically starts up.

Note: If you are performing operating system recovery, the Avigilon Control Center Admin Tool does not automatically start up. For more information about running the local ACC installer, see *Operating System Recovery By Avigilon Recovery Partition* below.

Proceed to activate the license for the Avigilon Control Center software on your Network Video Recorder.

Activating and Configuring ACC™ Software

For information about activating licenses, configuring sites, logging in to a site, and administering your version of the Avigilon ACC software, see the following guides:

- *Avigilon ACC Initial System Setup and Workflow Guide*
- *Avigilon ACC Client User Guide*

These guides are available on the Avigilon website: [avigilon.com/support-and-downloads](https://www.avigilon.com/support-and-downloads).

Troubleshooting

Network Configuration

By default, the Network Video Recorder acquires an IP address on the network through DHCP. If you need to set up the recorder to use a static IP address or any specific network configuration, see the *Windows Help and Support* files for more information.

Checking System Health



You can check on the health of the system components in the Site Health in the ACC Client software. See the *Windows Help and Support* files for more information.

Operating System Recovery By Avigilon Recovery Partition

If you need to recover the Windows operating system, the NVR4 Value includes an onboard Avigilon recovery partition that is separate from the operating system partition. The advantage of using the Avigilon recovery partition is that you do not need an internet connection.

Important: Your operating system drive will be erased and restored to factory settings. Before you proceed with operating system recovery, complete any necessary backups of custom ACC configuration and video recordings. For more information about ACC software backups, see <http://avigilon.com/recovery>.

Note: Depending on when your NVR4 Value was shipped, it is recommended that you connect to the network when possible to install updates for Windows and ACC Client software after system recovery is completed. For more information about ACC software installations, see <http://avigilon.com/recovery>.

1. Start operating system recovery in one of the following ways:
 - On your Windows desktop, select  and then hold down the Shift key and select **Restart**.
 - On your locked Windows screen, select  and then hold down the Shift key and select **Restart**.
 - During direct boot of the operating system, repeatedly press the down-arrow key and select the partition.
2. On the **Choose an option** screen, select **Use another operating system**.
3. Select the **OS Recovery** partition.
4. On the **Avigilon Recovery** window, select **Recover**.

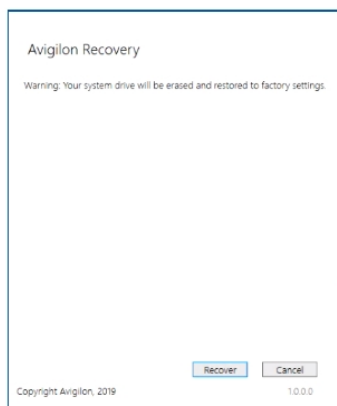

Allow up to half an hour for the recovery to complete.

5. After system reboot, complete the Windows setup process. For more information, see *Configuring Windows 10* on page 5.
6. Navigate to `C:\Avigilon\Control Center Installation Files`, and run the ACC installer for the version of ACC software in use at your site.

Operating System Recovery By External USB

Alternatively if you need to recover the Windows operating system on the and you have access to the internet, it is recommended that you download the latest Avigilon Recovery Image from <http://avigilon.com/recovery> and refer to Support and Downloads for the following information:

If you need to recover the Windows operating system on the Network Video Recorder and you have access to the internet, download the latest Avigilon Recovery Image from <http://avigilon.com/recovery> and refer to Support and Downloads for the following information:

- Minimum size of the USB recovery device
- Creating an external USB recovery device
- Recovering the operating system from an external USB recovery device

The general steps are:

1. Load the Avigilon Recovery Image onto a USB recovery device.
2. Plug the USB recovery device into the workstation.
3. Repeatedly press the F12 key while booting the workstation.
4. On the UEFI Boot menu, select the USB recovery device.

Advanced Features

Checking System Health

The Server Administrator software is pre-installed on the recorder. The software provides information about the recorder's system operation status, and gives you remote access to the recorder for recovery operations.

If one of the LED indicators on the recorder is flashing an error warning, the Server Administrator will display details about the problem. For more information about the LED indicators, see *LED Indicators* on page 15.

1. Open the Server Administrator.
 - To open the Server Administrator locally, double-click the **Server Administrator** shortcut icon on the desktop.
 - To open the Server Administrator remotely, open a web browser and enter this address:
`https://<recorder IP Address>:1311/`.

For example: `https://192.168.1.32:1311/` or `https://localhost:1311/`.

If you are using an intranet connection, your browser may display an error message. Allow the browser to ignore the certificate warnings.

2. If asked to log in, enter the Windows software administrator username and password that was configured for the recorder.
3. On the Server Administrator home page, the health of the system components are displayed in the workspace on the right.
 - To see the health of other system components, expand and select a different component from the System Tree on the left.
 - The table displayed in the workspace lists system components and their status:
 -  The system component is running normally.

 -  The system component has a non-critical warning.

 -  The system component has a critical failure.

 -  The system component status is unknown.
 - To see the details of a system component, select the system component from the workspace.

The Server Administrator is also used to customize the Redundant Array of Independent Disks (RAID) settings, assign a hot spare and remotely monitor the system health. For more information about the features in the Server Administrator, see the Help system provided in the software.

Replacing a Hard Drive Blank

The hard drives on the Network Video Recorder are set up in a RAID configuration. This allows information to be recorded across several hard drives.

If one or two hard drives fail, there is enough information on the other hard drives for the recorder to continue recording video.

Depending on the recorder model, there may be hard drive blanks at the front of the recorder. You can replace the blanks with hard drives as required.

1. Remove the bezel.

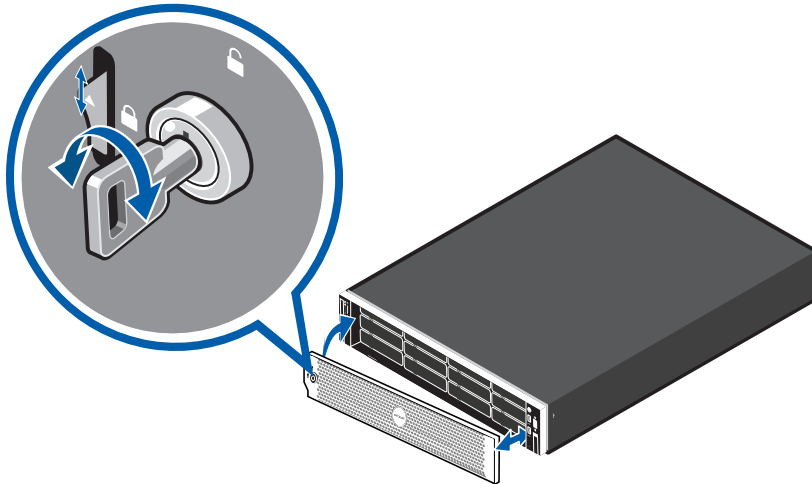

- a. Unlock the bezel.
 - b. Push the release button next to the lock.
 - c. Pull the left end of the bezel then unhook the right end to remove the bezel.
2. Press the release button and slide the blank out of the hard drive slot.

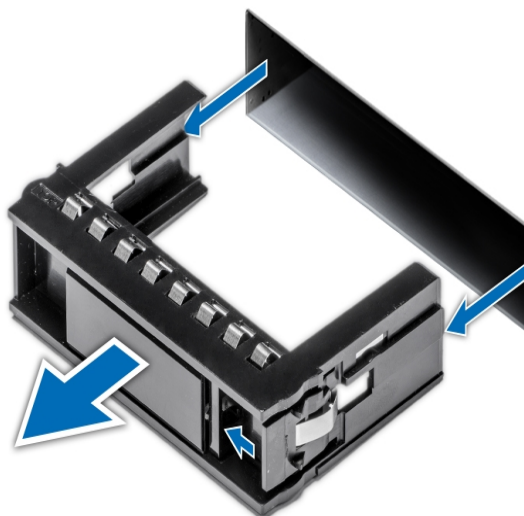

3. Insert the hard drive all the way into the recorder then push the handle against the hard drive to lock it into place.
4. Open the Server Administrator application and expand the System Tree.

The new hard drive should be automatically added to the Physical Disks list. The list is typically available here: **System > Storage > PERC H740P Mini (Embedded) > Connector 0 (RAID) > Enclosure (Backplane) > Physical Disks.**

5. Assign a task to the new hard drive or allow it to exist as an extra storage drive.

It is recommended to use the new hard drive as a hot spare. Hot spares are hard drives that are available on standby in the event of a hard drive failure in the RAID. If that occurs, you can configure the system to automatically redirect recording to the unused hard drive.

To assign the new hard drive as a hot spare:

- a. In the Task list, select **Assign and Unassign Global Hot Spare.**
- b. Click **Execute.**

If the new hard drive is not displayed in the Server Administrator, try one of the following:

- Refresh the browser.
- Reboot the recorder.

Replacing Hard Drives

The operating system and the Avigilon Control Center software are mirrored on two hard drives at the back of the recorder. If one of the hard drives fail, you can replace the failed drive while the recorder continues to run from the other.

If your recorder is still under warranty, contact Avigilon Technical Support to replace the failed hard drive.

If more than two hard drives fail at the same time, contact Avigilon Technical Support immediately for recovery instructions.

Only replace a hard drive if the hard drive LED indicator and the Server Administrator displays an error.

1. Open the Server Administrator.
2. Check which hard drive has failed, then disconnect the drive through the Server Administrator software.

Hard drives are installed at the front, back and in the middle of the recorder. Be sure you can identify which hard drive needs to be replaced.

3. If you are replacing a hard drive at the center of the recorder, shut down the recorder then disconnect all cables.

Note: Skip this step if you plan to hot-swap a hard drive at the front or back of the recorder.

4. Remove the bezel.
5. Depending on where the hard drive is located, perform one of the following procedures:

Replacing Front or Back Hard Drives

1. Locate the failed hard drive at the front or back of the recorder.

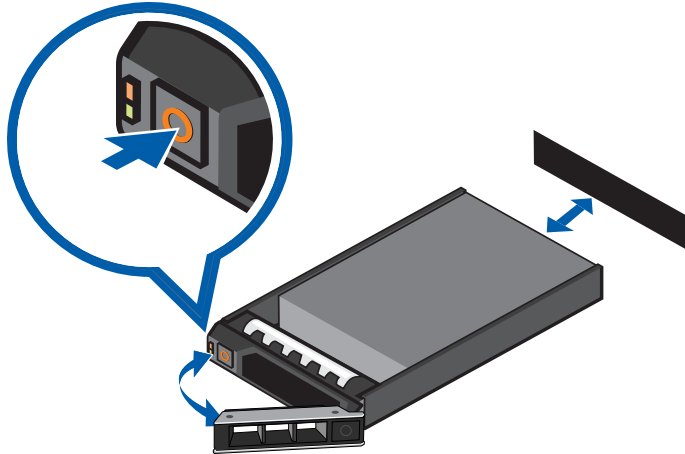

2. Press the release button on the front left of the hard drive.
3. When the handle is released, pull the hard drive out of the recorder.
4. Remove the four screws from the side of the hard drive carrier.
5. Lift the failed hard drive out of the carrier.
6. Insert a new hard drive into the carrier then screw it into place. The hard drive connectors should face the back.
7. When the hard drive is secured in the carrier, insert the hard drive back into the recorder.
8. Once the hard drive is inserted all the way in, push the handle against the hard drive to lock it into place.

The recorder immediately starts rebuilding the hard drive. The progress is displayed in the Server Administrator. This may take several hours.

Replacing Center Hard Drives

To replace a hard drive stored in the middle of the recorder, complete the following steps:

1. At the top of the recorder, unlock the latch release then lift and rotate the latch towards the back of the recorder.

The cover slides back and is released from the recorder body.

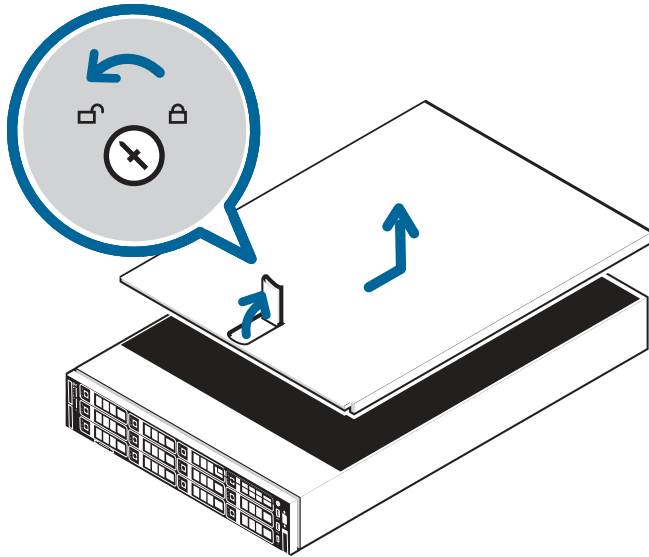

2. Hold the cover from both sides and lift it off the recorder.
3. Locate the failed hard drive on the center hard drive tray.
4. Lift the handles on either side of the hard drive tray.

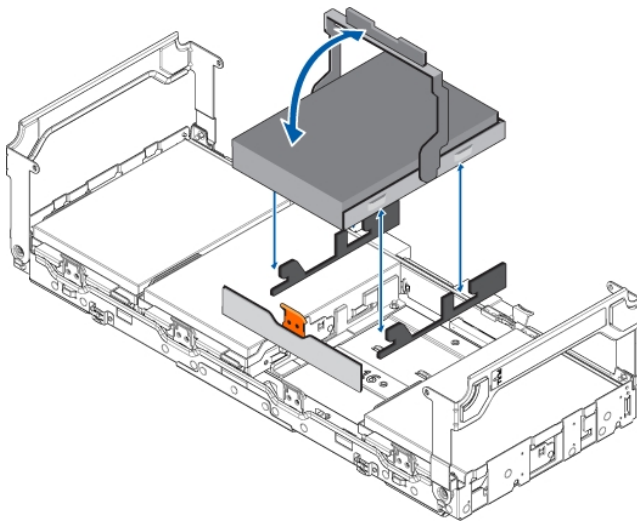

5. Press the orange release tab on the hard drive tray then lift up the hard drive carrier handle to release the hard drive.
6. Hold the handle and lift the hard drive out of the tray.
7. While holding the handle, pull the edges of the carrier away from the hard drive to remove the failed hard drive from the carrier.
8. Align the slots on the new hard drive to the tabs on the hard drive carrier.





9. Pull the edges of the carrier over the slots on the hard drive.
10. Place the new hard drive into the tray and push the handle down until the hard drive clicks into place.
11. Fold down the handles on the hard drive tray. Close and lock the recorder cover.
12. Reconnect all the cables to the recorder and power it.

After the operating system starts up, the recorder immediately starts rebuilding the hard drive. The progress is displayed in the Server Administrator. This may take several hours.

LED Indicators

Diagnostic Indicators

The diagnostic indicators on the front panel highlight system issues during system startup.

LED Indicator	Description
 Hard drive	<ul style="list-style-type: none">Blinks orange — the hard drive is experiencing an error.
 Temperature	<ul style="list-style-type: none">Blinks orange — there is a thermal error. Errors include:<ul style="list-style-type: none">temperature out of rangefan failure <p>Check that the fans are functioning correctly and the air vents are not blocked.</p>
 Electrical	<ul style="list-style-type: none">Blinks orange — there is an electrical error. Errors include:<ul style="list-style-type: none">voltage out of rangefailed power supplyvoltage regulator <p>Check the power status indicator to confirm if it is an issue with the power supply.</p>
 Memory	<ul style="list-style-type: none">Blinks orange — there is a memory error.
 PCIe	<ul style="list-style-type: none">Blinks orange — there is a PCIe card error. Restart then upgrade the device firmware if the error persists.
System health and System ID	<ul style="list-style-type: none">Blue — powered and in good healthBlinking blue — System ID mode activeOrange — fail-safe modeBlinks orange — there is an error

Power Status Indicators

The power button on the front lights up when power is on.

Additional information about the power supply is provided by the power status indicator on the power supplies at the back. The following table describes what the LEDs indicate:

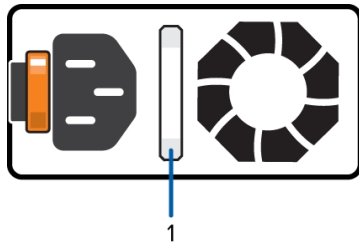

Figure 1: (1) The power status indicator.

LED Indicator	Description
Off	Power is not connected.
Green	Power is supplied.
Flashing green	The firmware update is being applied to the power supply unit.
Flashing green then turns off	The redundant power supply is mismatched. This only occurs if you have a secondary redundant power supply installed.
Flashing orange	There is a problem with the power supply.

Network Link Status Indicators

When the recorder is connected to the network, the recorder's connection status LEDs above the Ethernet port display the recorder's connection status to the network. The following table describes what the LEDs indicate:



Figure 2: (1) Link LED. (2) Connection activity LED.

LED Indicator	Description
Off	The recorder is not connected to a network.
Link LED — green Connection Activity LED — blinking green	The recorder is connected to a network at the maximum port speed.
Link LED — orange Connection Activity LED — blinking green	The recorder is connected to a network at less than the maximum port speed.
Link LED — green Connection Activity LED — off	The recorder is connected to a network at the maximum port speed and data is not being sent or received.
Link LED — orange	The recorder is connected to a network at less than the

LED Indicator	Description
Connection Activity LED — off	maximum port speed and data is not being sent or received.

Hard Drive RAID Status Indicators

Each hard drive has its own set of LED indicators to show its activity and status.

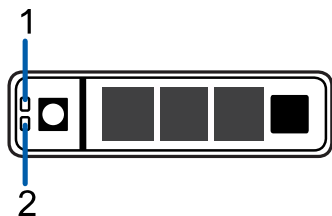

Figure 3: (1) Status LED. (2) Activity LED.

The Activity LED flashes green when the hard drives are working. The following table describes what the Status LEDs indicate:

LED Indicator	Description
Green	The hard drive is online.
Off	The hard drive is disconnected from the recorder.
Two short green flashes every second	The system is identifying a new hard drive, or preparing a hard drive for removal.
Flashes green, orange, then off	The hard drive is predicted to fail.
Four short orange flashes per second	The hard drive has failed.
Flashes green slowly	The hard drive is rebuilding.
Blinks green for three seconds, orange for three seconds, and off for six seconds	The hard drive rebuild has been aborted.

Limited Warranty and Technical Support

Avigilon warranty terms for this product are provided at [avigilon.com/warranty](https://www.avigilon.com/warranty).

Warranty service and technical support can be obtained by contacting Avigilon Technical Support: [avigilon.com/contact-us/](https://www.avigilon.com/contact-us/).

For More Information

Visit [avigilon.com](https://www.avigilon.com) for additional product documentation.

Technical Support

To contact Avigilon Technical Support, go to [avigilon.com/contact-us](https://www.avigilon.com/contact-us).

Upgrades

Software and firmware upgrades will be made available for download as they become available. Check for available upgrades on the [Avigilon Partner Resource Center](#).

Free Manuals Download Website

<http://myh66.com>

<http://usermanuals.us>

<http://www.somanuals.com>

<http://www.4manuals.cc>

<http://www.manual-lib.com>

<http://www.404manual.com>

<http://www.luxmanual.com>

<http://aubethermostatmanual.com>

Golf course search by state

<http://golfingnear.com>

Email search by domain

<http://emailbydomain.com>

Auto manuals search

<http://auto.somanuals.com>

TV manuals search

<http://tv.somanuals.com>