

# User Manual

Avi igonNet or Video Recorder

HD-NVR4-PRM-64TB, HD-NVR4-PRM-96TB, HD-NVR4-PRM-128TB and HD-NVR4-PRM-157TB

[avigilon.com/patents](http://avigilon.com/patents)

yvo vt l p u lo o vtup p vlyt lp l k uv yy o ly  
vtu r vtvS l w yvo

euv p o ul n o vj p nyv u pr t ppo o v l p ovrvol l vlyl nyl  
u v r nyvol eu o r up o l p u ovrvol vr u p p o p  
u lv nw oul t v u vo vtvS l v u vtu lx l ou  
oul t v u vo v u vtvS l v w lrrvyvl op l v t l l u  
o y loo lo r uv r lo v lv v p p o (v r vny  
r yvl o uv r l v vtvS l uyy n r lvny pl lt  
v oy p v t pl lt vlyol rp yvl o uv r l v u p

vtvS l v  
l vtv o

aTV gc ac

c v y U

( (

# Table of Contents

Introduction .....	1
Before you Start.....	1
Overview .....	1
Front View .....	1
Back View .....	2
Installation .....	4
Package Contents .....	4
Installing the Rack Rails and Cable Management Arm .....	4
Connecting Cables .....	4
Installing the Bezel.....	5
Configuring Windows1 .....	5
Activating and Configuring ACC Software .....	6
Troubleshooting .....	6
Network Configuration.....	6
Checking System Health .....	6
Performing System Recovery By AviatorRecovery Partition .....	6
Performing System Recovery By ExternalUSB .....	8
Advanced Features .....	9
Checking System Health .....	9
Replacing a Hard Drive Blank .....	11
Replacing Hard Drives .....	11
Replacing Front or Back Hard Drives .....	12
Replacing Center Hard Drives .....	12
LED Indicators .....	15
Diagnostic Indicators .....	15
Power Status Indicators .....	15
Network or Line Status Indicators .....	16
Hard Drive RAID Status Indicators .....	17
For More Information .....	18

# Introduction

The AvigilonNet or Video Recorder is preloaded with the AvigilonControl Center software and is configured for maximum performance and reliability. The Net or Video Recorder can be easily integrated into any existing Avigilon security system, or act as the base of a new site.

## Before You Start

vtvy o up t v vny yad o vp  
vvyi o ul p l fad v p o voly v r lv y  
ny v oy pv tvx y tv ry o l lv po y rlv y vl p pvol p  
nl ol ly n p v p v t v v lx r l l pt l n  
l l pp ou v p  
fad o o v v oy p rvt l v up uhv p l v t u  
l yvl o u nl vy u v + v r lv v t  
v o plop l n o o pl yvl o lr vy ul vl x  
o rvt lul vn

## Overview

### V gv

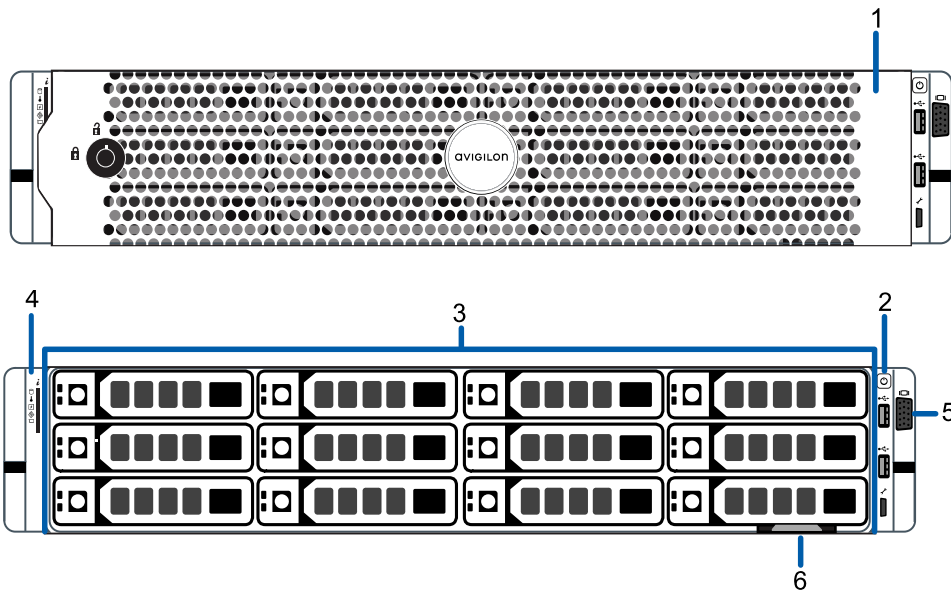

### Bezel

a ltlv l u u ploty uul pp v

( Power button

S uy y u o p

) Hard drives

a vpo u l lnyl pp v eu l Uv pvol louul pp v

d p v l o llv ul pp v l

### Diagnostic indicators

a vpr llnv l v

V v r l v *LED Indicators on page 1*

### Video connector

oo l gW vo o v

, Information tag

a vpu p o pvo lly p v r l v

## Rlox gv

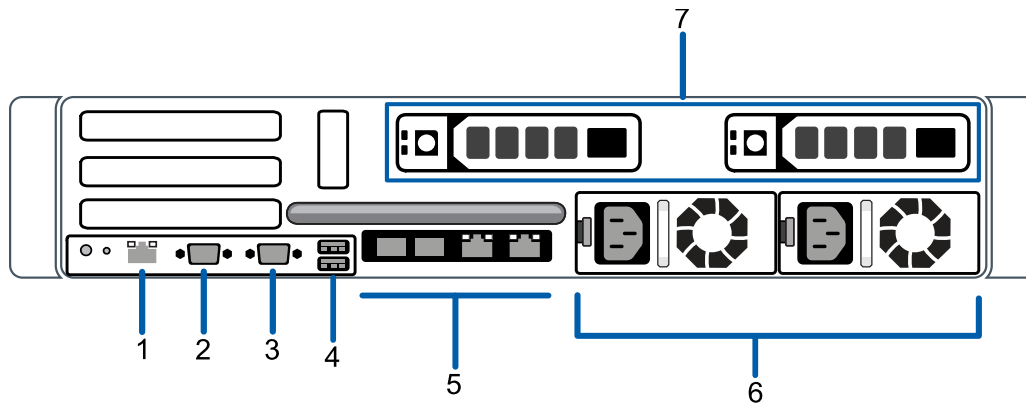

### Out-of-Band Management (OOBM) connector

oo l R c to o v

( Serial connector

oo o o v pily vo

) Video connector

oo l gW vo o v

### USB connectors

oo fdR o o v p lyo

Two(2) SFP+ 10 Gbps and Two(2) RJ-45 1 Gbps Ethernet ports

oo U u o o v y v y x

, Power supply

e u l lny p pl y

- Hot-swappable hard drives

e u l lnyl pp v ull l r u llt l

# Installation

## Package Contents

U u loxlt o lv ur yy v t

- 
- 
- 
- 
- 

## Installing the Rack Rails and Cable Management Arm

r u o pvyx v l loxv lylox dyvpv ctvy l p uSiny l lt  
wp p o ploxt V yy u o p yw upRack Installation Instructions and  
t eCMA Installation Instructions provided in t eassem lykits

**Note:** eu ylox dyvpv ctvy l o l vny u ll p u py lox

## Connecting Cables

c r upvlt l v u v o w uy ol v r upvrr o o lx u  
r yy ø t olv v p

S log v ou l x n l p l p v u o p

- 
-

# Installing the Bezel

eu n olyn v lyy pur r u o pu y ual pp v ltlv l u v p loo

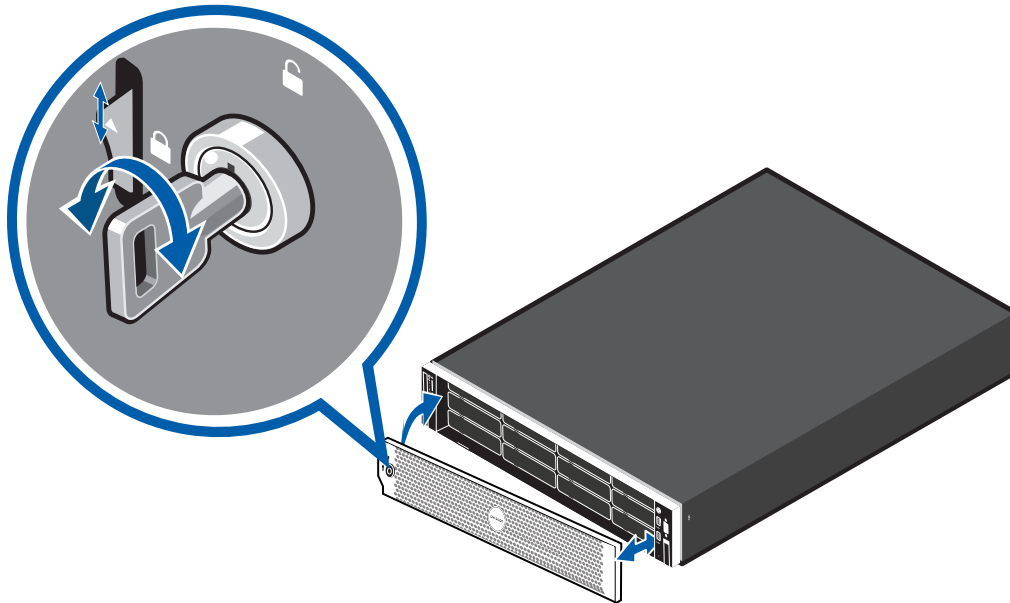

yvtl pv u vtu pr un y veyvoxv ylo  
 ( a uuy r pr un vy ur r u v veyvoxv ylo  
 ) f u wp py ox un y

# Configuring Windows 10

r u o p l vyy po rvt uhv p l v t r urv v  
 urv o u Sc d Ve Veh cU SU eUc dl p g W S ec  
 SU eUcd Veh cUU TfdUc SU dWcUU Ulep v y l c p v u l poyvox  
 Accept

( d y Join a local Active Directory domain

**Note:** eu v l l yrl o vTv o v u d x u  
 Windows Help and Support files for more information

) U l l r loo v thv p r l  
 U l l l pp l uv p u l l poyvoNext



**Note:** This document is for the Avigilon ACC Initial System Setup and Workflow Guide. For more information, see the Avigilon ACC Client User Guide.

## Activating and Configuring ACC™ Software

This document provides information on how to activate and configure the ACC software.

- *Avigilon ACC Initial System Setup and Workflow Guide*
- *Avigilon ACC Client User Guide*

Additional guides are available on the Avigilon website at [avigilon.com/support-and-downloads](https://www.avigilon.com/support-and-downloads)

## Troubleshooting

### System Health

For more information on how to check the system health, see the Windows Help and Support files for more information.

### Checking System Health

You can check the health of the system components in the Site Health in the ACC Client software. See the Windows Help and Support files for more information.

## Operating System Recovery By Avigilon Recovery Partition

If you need to recover the Windows operating system, the Recovery Partition includes an on-board Avigilon recovery partition that is separate from the operating system partition. The advantage of using the Avigilon recovery partition is that you do not need an internet connection.

Important: <http://avigilon.com/recovery>

Note: <http://avigilon.com/recovery>

- Restart
- Restart
- Choose an option or Use another operating system
- Windows Recovery Environment
- Avigilon Recovery

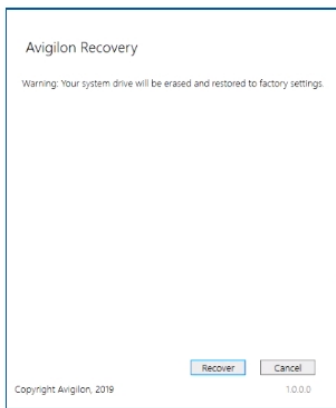

Windows 10 on page

avigateto C:\Avigilon\Control Center Installation Files

<http://avigilon.com/recovery> l p r d l pT y lp ur yy w it l v

r p o uhv p l v t u gvp x c o p p ul loo  
uv p y l p y l v t v y c o l t r <http://avigilon.com/recovery> l p r  
d l pT y lp ur yy w it l v

- 
- 
-

# Advanced Features

## Checking System Health

eu d p v v lr v v lyy pu o ep r l vpr llnv  
u o p l v l l pvt loo u o rp o  
l v

r r u UT pvol u o vpyl uv lt l v tud p v v vly yl  
p Np u nyV v r llnv u UT pvol *LED Indicators on page 1*

1 Open the Server Administrator

- **Server Administrator** u vø  
up x

• <https://<recorder IP Address>:1311/>

o <https://192.168.1.32:1311/> <https://localhost:1311/>

p o t it o o tl o nt o o ro so  
l dr so o tpt r

p von tro o so t n p n t o n s n  
ptrp oso o no

so o on t t s o ro so p so o o nt t o  
v so trs

- 
- 
- 
- 

# Replacing a Hard Drive Blank

eu ul pp v u gvp xc o p v l c ð rvt lew ly v r l v  
n o lp p ul pp v

r ul pp v rlv y u v vtur l v u uul pp v r u o p  
o v o pwpt

T pv tu o p p yu l n ul pp v nyl xl ur r u o p ol  
ylo unyl x v ul pp v l v p

c un y

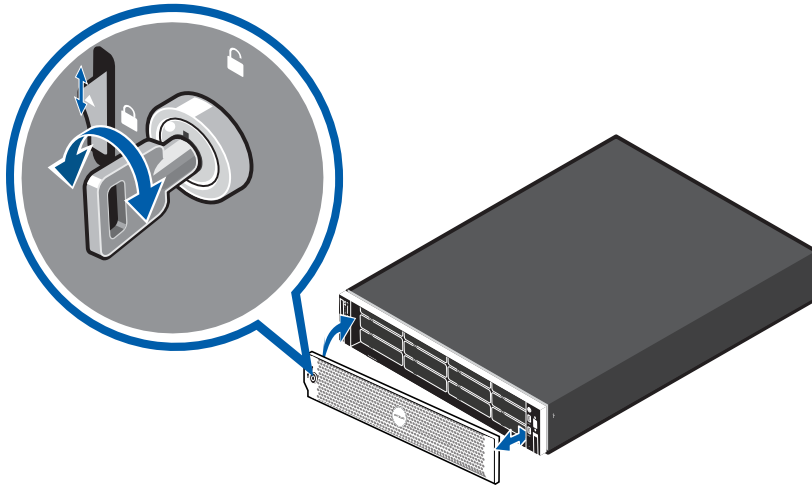

l f y oxun y

n a u u y h uy ox

o a yyuy r pr un y u m vtu p un y

( a u y h l p yvp unyl x r uul pp v y

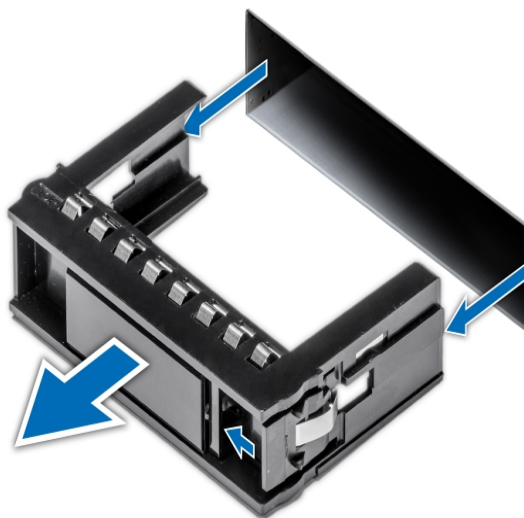

System > Storage > PERC H740P Mini (Embedded) > Connector 0 (RAID) > Enclosure (Backplane) > Physical Disks

+ vt l x u ul pp v lyy v v l l pt v  
v o p p u ul pp v l l u l Y l l ul pp v ull  
l lvylny l pn u f ul pp v rlvv v uc T r ul oo ol o rvt  
u l l volyypv oo pv t ul pp v  
e l vt u ul pp v l l u l  
l uel xyv y Assign and Unassign Global Hot Spare  
n SyvoExecute  
r u ul pp v v pv yl v pud p v v l r ur yy v t  
.  
.

## Replacing Hard Drives

eu l v t l p u vtvys S y r ll v pul pp v l unlox  
r u o pr r uul pp v rlvv ol ylourlvy p v uvy u o op v  
r u u  
r o vp vyyp l l o lo vtvye ou vdy ylourlvy pl pp v  
r ul ul pp v rlvv u l v o lo vtvye ou vdy v pvl r y  
o v o v  
y yloul pp v vr uul pp v UTv pvol l p ud p v v pvl yll  
ud p v v l  
( Su ox uvoul pp v ul rlvv p u pv o up v u tud p v v l  
r l  
Yl pp v l v lyy pr nlox l pv u vppy r u o Rp ol vp vr  
uvoul pp v pn ylo p  
) r l ylovlult pp v l uo r u o pu p u o pu  
pv o lyyoany

Note: dxv uv vr yl u l l ul pp v l ur nlox r u o p

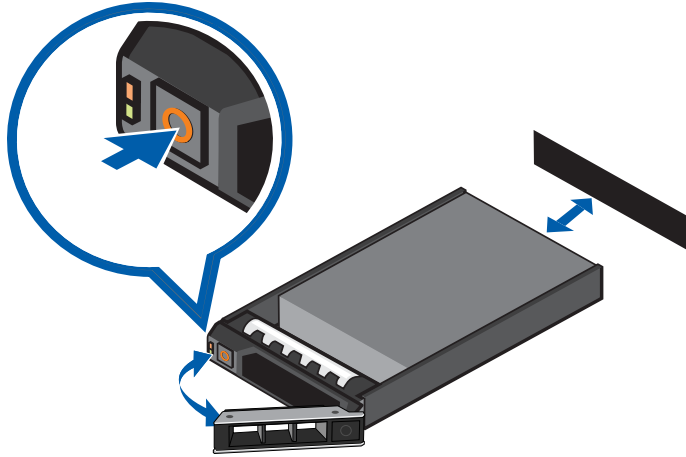

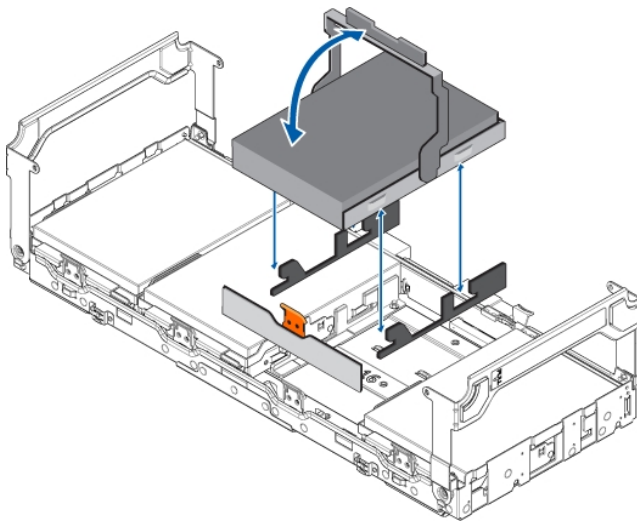
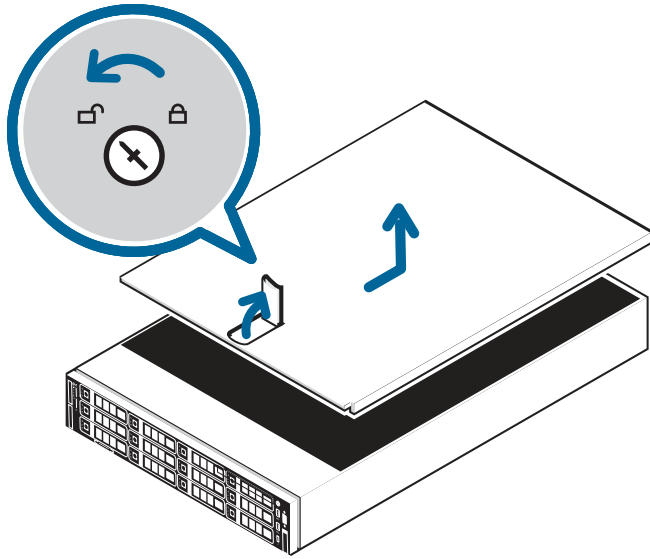









# LED Indicators

## Diagnostic Indicators

LED Indicator	Description
 Hard drive	•
 Temperature	• •
 Electrical	• • •
 Memory	•
 PCIe	•
System health and System ID	• • • •

## Power Status Indicators

eu n ur yvtu u v  
 ppv v v ty llnv u v y vp pu l v pvol u  
 lyv unlox eu r yy v lny p o vn ul u UTv pvol

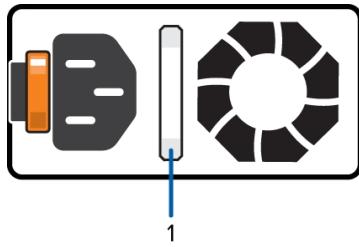

Figure 1: eu l v pvol

LED Indicator	Description
Off	a v o o p
Green	a v yv p
Flashing green	eu rv l pl v n v lt yv p u y v
Flashing green then turns off	eu p pl v y v l oueup y oo vr ul l o pl p pl v y lyy p
Flashing orange	eu v l ny v uu y

## Network Link Status Indicators

hu u o vpo o p ux o p o v l UTIn uU u  
pv yl u o p o v l u eu κ yy v lntyp o vnul u UT  
v pvol



Figure 2: v xUT (S olov v v UT

LED Indicator	Description
Off	eu o vpo o l p x
Link LED — green Connection Activity LED — blinking green	eu o vpo o l p l κ l v p
Link LED — orange Connection Activity LED — blinking green	eu o vpo o l p l y x ul u l v p
Link LED — green Connection Activity LED — off	eu o vpo o l p l κ l v l ppl lv n v t o v p
Link LED — orange	eu o vpo o l p l y x ul u

LED Indicator	Description
Connection Activity LED — off	I v I p p l lv n v t o v p

## Hard Drive RAID Status Indicators

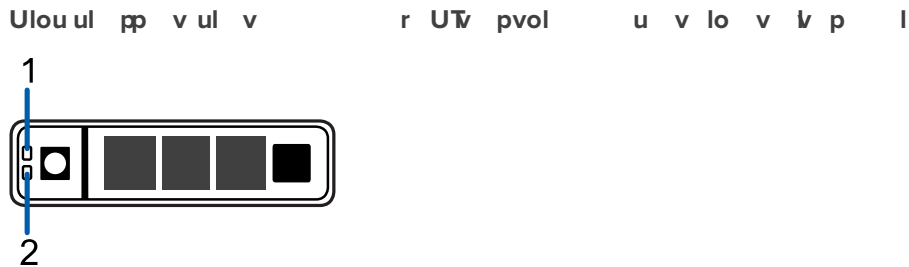

Figure 3: d I UT ( o v WT

eu o v vUTyl u t u uul p v I xveut r yy v lny p o vn ul u d I UTv pvol

LED Indicator	Description
Green	eu ul p v v yv
Off	eu ul p v v pv o ro pi o p
Two short green flashes every second	eu v vp vrl v tul p v ll ul tp p v r ly
Flashes green, orange, then off	eu ul p v v pvo rlv p
Four short orange flashes per second	eu ul p v ul rlv p
Flashes green slowly	eu ul p v v n vvpv t
Blinks green for three seconds, orange for three seconds, and off for six seconds	eu ul p v n utypn ln p

## Limited Warranty and Technical Support

Avi ilon arrantyterms for this product are provided at [avigilon.com/warranty](https://www.avigilon.com/warranty)

hl I l v p ou voly ol n n lv n p lo v vtvye ou vdy [avigilon.com/contact-us/](https://www.avigilon.com/contact-us/)

# For More Information

Visit [avigilon.com](http://avigilon.com) for more information.

## Technical Support

For technical support, visit [avigilon.com/contact-us](http://avigilon.com/contact-us).

## Upgrades

For more information on upgrading your Avigilon system, visit [Avigilon Partner Resource Center](#).

## Free Manuals Download Website

<http://myh66.com>

<http://usermanuals.us>

<http://www.somanuals.com>

<http://www.4manuals.cc>

<http://www.manual-lib.com>

<http://www.404manual.com>

<http://www.luxmanual.com>

<http://aubethermostatmanual.com>

Golf course search by state

<http://golfingnear.com>

Email search by domain

<http://emailbydomain.com>

Auto manuals search

<http://auto.somanuals.com>

TV manuals search

<http://tv.somanuals.com>