



USER MANUAL

Model:

A8CTBOTTLELESSWHT

A8CTBOTTLELESSBLK

Countertop Water Dispenser Bottleless

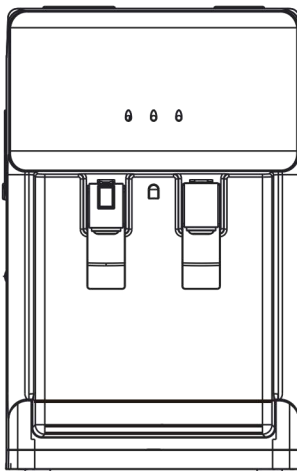

Please read the manual carefully before operating your water dispenser. Retain it for future reference.

DIRECTORY

A: PART NAME	1
B: SAFETY PRECAUTIONS	2
C: GETTING STARTED	3
D: TROUBLE SHOOTING	6
E: WATER PURIFIER	8
F: CLEANING	8
G: MACHINE INSTALLATION	10

A: PART NAME

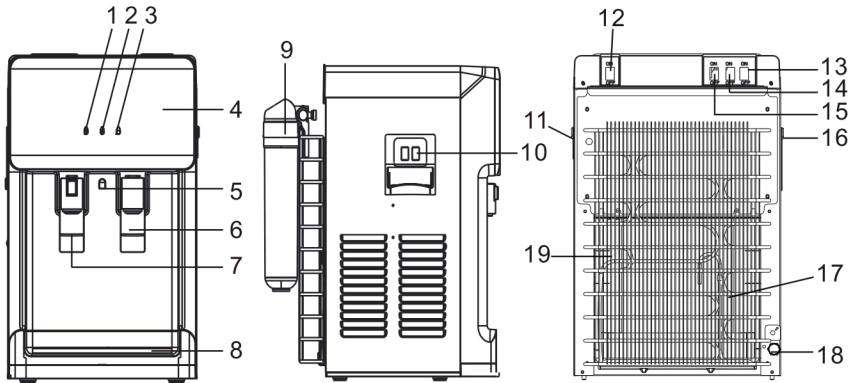

NO.	PART NAME	NO.	PART NAME
1	Ozone and Power Indicator Lamp	11	Right handle
2	Heating Pilot Lamp	12	Ozone Switch
3	Cooling Pilot Lamp	13	Heating Switch
4	Front Shell Decorative Panel	14	Cooling Switch
5	Night Light	15	Night Light Switch
6	Tap of Cold Water	16	Left Handle
7	Tap of Hot Water	17	Hot Tank
8	Water Collector	18	Outlet of Hot Water
9	NSF Carbon Filter	19	Refrigeration Compressor
10	Filter Reset Switch		

NOTE:

Please use the product in a place with temperature of 39-100°F .

3. Hold this filter with A4 System filter flushing adapter over a sink and turn on the valve near the water source. Let water to flow out of the filter and A4 System filter flushing adapter for 5 minutes to flush the new filter.
4. Shut off the valve at the water source.

Finishing the Water Cooler Installation

1. Remove the end of the PE Tube from the A4 System filter flushing adapter by pressing on the blue ring and pulling out the PE Tube.
2. Twist out the filter from the A4 system filter flushing adapter.
3. Clip the black filter adapter mounting bracket onto the top of the condenser by inserting the longer pegs upward as in figure 5 and then by clicking the lower shorter pegs into the condenser as in figure 6.
4. Slide the filter adapter down into the mounting bracket as in figure 7.
5. Take the "Mechanical valve and tube assembly" and connect the tube end into the left hole of the filter adapter as in figure 8. Then connect the other end to the long PE tube coming from the water source as in figure 9. Then connect one side of the short tube to the right side of the filter hole and connect the other side to the inlet of the machine as in figure 10.

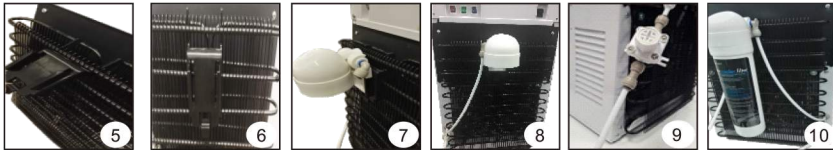

6. Twist the filter into the A4 system adapter in the back of the unit by rotating it clockwise.

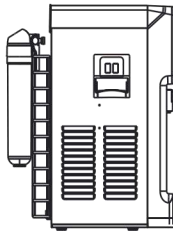

7. Turn back on the valve from the water source.
8. Turn on the valve to the left of the filter.
9. Flowchart of water generation

B: SAFETY PRECAUTIONS

WARNING

To reduce risk of injury and property damage, user must read this entire guide before assembling, installing, operating the dispenser.

Failure to execute the instructions in this manual can cause personal injury or property damage.

This product dispenses water at very high temperatures. Failure to use properly can cause personal injury.

When operating this dispenser, always exercise basic safety precautions, including the following:

- Prior to use, this dispenser must be properly assembled and installed in accordance with this manual.
- This dispenser is intended for water dispensing only. Do NOT use other liquids. Do NOT use for other purposes. Never use any other liquid in the dispenser other than known and microbiologically safe tap water.
- For indoor use only. Keep water dispenser in a dry place away from direct sunlight. Do NOT use outdoors.
- Install and use only on a hard, flat, and level surface.
- Do NOT place dispenser in an enclosed space or cabinet.
- Do NOT operate dispenser in the presence of explosive fumes.
- Position back of dispenser no closer than 20cm from wall and permit free airflow between wall and dispenser. There must be at least 20cm clearance on the sides of the dispenser to permit airflow.
- Use only properly grounded outlets.
- Do not use an extension cord with your water dispenser.
- Always grasp plug and pull straight out from outlet. Never unplug by pulling on power cord.
- Do NOT use dispenser if cord becomes frayed or otherwise damaged.
- To protect against electric shock, do NOT immerse cord, plug, or any other part of dispenser in water or other liquids.
- Ensure dispenser is unplugged prior to cleaning.
- Never allow children to dispense hot water without proper and direct supervision. Unplug unit to prevent unsupervised use by children.
- Service should be performed only by a certified technician.
- Warning: Do not damage the refrigerant circuit.

- This appliance can be used by children aged from 8 years and above if they have been given supervision or instruction concerning use of the appliance in a safe way and if they understand the hazards involved. Cleaning and user maintenance shall not be made by children unless they are older than 8 and supervised. Keep the appliance and its cord out of reach of children aged less than 8 years.
- Appliances can be used by persons with reduced physical, sensory, or mental capabilities or lack of experience and knowledge if they have been given supervision or instruction concerning use of the appliance in a safe way and understand the hazards involved. Children shall not play with the appliance.
- This appliance is intended to be used in household and similar applications such as: kitchen areas in shops, offices, and other working environments, hotels, motels, and other residential type environments, bed and breakfast type environments, catering, and similar non-retail applications.
- Do not store explosive substances such as aerosol cans with a flammable propellant in this appliance.
- If the supply cord is damaged, it must be replaced by a special cord assembly available from the manufacturer or its service agent.
- Never turn the machine upside down or lean it more than 45°.
- Thermostat has been adjusted. No need to adjust it by yourself. When the machine is below the freezing point and blocked by ice, the cooling switch be turned off for 4 hours before turning it on again to continue its operation.
- This machine should not be turned on until 3 minutes after turning off the power switch.

C: GETTING STARTED

Locate Dispenser

1. Place dispenser upright.
2. Locate dispenser on a hard and level surface in a cool shaded location near a grounded wall outlet.

Notice: Do NOT plug in power cord yet.

3. Position dispenser so the back is at least 20cm from wall and there are at least 20cm of clearance on both sides.

Assemble

1. Open the top of the packing case, take out the top foam and its accessories.
2. Put the accessories aside.

3. Take out the quick joint adapter with valve and install it on the water pipe.

Intall the adapter:

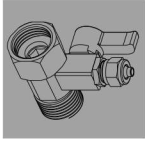

Metal Adapter with Valve



PE Tube (3m)



Extra Filter Flushing Adapter

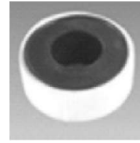

Tape and Tools (not included)



Mechanical valve and tube assembly



Tube



Mounting Bracket

Tape and Tools (not included)

1. Disconnect the current cold water supply line, as in figure 1.
2. Connect the adapter with valve to the cold water supply line, as in figure 2.
3. Connect the nut on the side of the metal adapter and insert the PE Tube pipe through the nut. Stick the PE Tube pipe over the side part of the adapter where the nut was originally, as in figure 3.
4. Screw the nut tightly into place keeping the PE Tube pipe securely connected to the adapter with valve, as in figure 4.
5. Note: Do not connect this water line to hot water supply line.

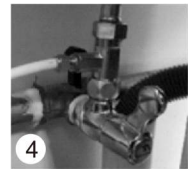
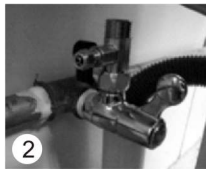

Filter Flushing Instructions Prior to the First Use

1. Before connecting the other end of the PE tubing to the back of the water cooler, connect it to the provided A4 System filter flushing adapter into the left inlet hole in the direction of the arrow on the adapter.
2. Twist the replacement filter into this A4 System filter flushing adapter until it is in place.

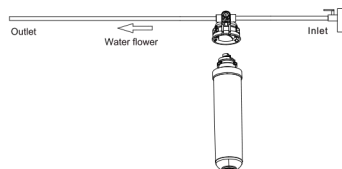

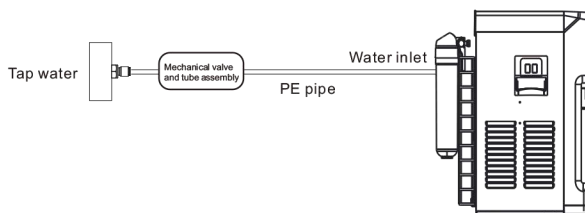

10. After installation of water line and filter, plug the power cord into a grounded power supply and begin to use machine normally.

Filter replacement cycle

replacement	function
6 Months or 1500 gallons	Reduce Chlorine, Taste and odor, Nominal particular class I, Lead and Cysts.

Special hints :

The total flow above is for reference only. It is based on normal water use. The specific cycle for replacement of filters varies with local water quality and water amount consumed.

D: TROUBLE SHOOTING

No water is coming from the spout.

- Make sure to completely depress the push button controls.

Cold water is not cold.

- It takes up to one hour after setup to dispense cold water.
- Make sure the power cord is properly connected to a working outlet.
- Make sure the back of the dispenser is at least 20 cm from a wall and there is free airflow on all 20cm sides of the dispenser.
- Make sure green power switch on back of dispenser is ON.
- If water still isn't cold, please ask a service agent for assistance.

Hot water is not hot.

- It takes 15-20 minutes after setup to dispense hot water.
- Make sure the power cord is properly connected to a working outlet.
- Make sure red power switch on back of dispenser in ON.

Nightlight isn't working.

- Make sure the power cord is properly connected to a working outlet.
- Make sure nightlight power switch on back of dispenser is ON.

Dispenser is noisy.

- Make sure the dispenser is positioned on a level surface.

Small water flow.

- Low water pressure.
- Check the water inlet.
- The filter exceeded it's usage time.
- Please contact the manufacturer to replace the filter

Water leakage.

- If the appliance is making a sound, there should be leakage. Please check the PCB on the palte. Repair the machine and dry the PCB, and then power on agin.
- Pipe not connected properly.
- Inspect the adapter to connect the pipe properly.
- Water pipe and PE pipe bursting.
- Replace the water pipe.

Activate Heating & Cooling

Notice: This unit will not dispense hot or cold water until the switches are activated.

To activate, push top side of power switches in to start heating and cooling water.

Please allow 15 minutes for the hot water to be heated. During this time the green heating pilot lamp will be steady. The light will turn off when the heating process is complete. Please allow 90 minutes for the cold water to be cooled. During this time the green cooling pilot lamp will be steady. The light will be turned off when the cooling process is complete. If any error occurs in the heating or cooling process, the indicator light will blink.

- If you do not want to heat water, push bottom side of red switch in.
- If you do not want to cool water, push bottom side of green switch in.

Activate Nightlight

Push top side of blue power switch in to turn light on. Push bottom side in to turn light off.

E: WATER PURIFIER

This unit has been tested and sanitized prior to packing and shipping. During transit, dust and odors can accumulate in the tank and lines. Dispense and dispose at least one quart of water prior to drinking any water.

Dispensing Cold Water

After setup, it will take up to 1 hour to get water to maximum cold temperature. During this time the compressor could run continuously. This is normal.

1. Position bottle glass, pitcher, or cooking pot below spout.
2. Depress cold water push button downward to start cold water flow.
3. Release push button once desired fill level is achieved.

Dispensing Hot Water

After setup, hot water will be available in 15-20 minutes.

1. Position bottle, glass, pitcher, or cooking pot below spout.
2. Slide red button away from you and depress hot water push button downward to start hot water flow.
3. Release push button once desired fill level is achieved.

F: CLEANING

1. To avoid accidents, cut off the power supply before operation according to the following instructions.

- 1) Make sure the power switch in the O(off) position and unplug the water dispenser before cleaning.
- 2) Unscrew the two screws from the back of the unit as in figure 1.
- 3) Remove the top cover, cold tank cover, and separator as in figure 2.
- 4) Fill 1L of pure water into cold tank (the open cylinder that the cover was removed from) to clean it.
- 5) Place a large water bucket beneath the outlet of hot water which is in the back of the water dispenser, then remove the drain cover and drain the water as in figure 3.
- 6) Reposition the drain cover, separator, cold tank cover, and top cover after draining. Ensure the pipe and wires are connected properly, then you can use the machine normally.

2. Attention:

- 1) Cleaning must be performed by someone with experience or an authorized service agent.

- 2) The dispenser heats water to a temperature of approximately 185 F. It can cause severe burns. Please operate it carefully.

3. Sanitizing

This machine should be sanitized with a disinfectant and then cleaned with water every three months. (See cleaning and draining instructions.)

4. To Remove Mineral Deposits

Mix 4 L of water with 200 g of citric acid crystals, putting the mixture into the machine making sure the water can flow out of the hot water tap. Switch on the power and heat it for about 10 minutes. 30 minutes later, drain the liquid, then clean it with water two or three times. Never disassemble by yourself to avoid damaging machine. Generally this should be done every six months.

5. Maintenance of Filtration System

- 1) When lifetime of the filter is near its end, either by means of water flow or by means of 6 months time, the middle and right indicator lights on the front panel will blink together as a warning to change the filter.
- 2) Shut off the valve at the water source or the valve in the back of the unit.
- 3) Twist out the old filter from the A4 system on the back of the water cooler.
- 4) Twist the new filter into the A4 system on the back of the water cooler.
- 5) Turn back on the valve from the water source or the valve to the left of the filter on the back of the water cooler.
- 6) Only replace the filter with a new Avalon filter designed for this water cooler. Any other type of filter will damage the machine and void any warranty.
- 7) After replacing the filter, press the filter reset button on the right side of the water cooler, until the blinking lights turn off.
- 8) Allow water to flow from the cold water spout for approximately 5 minutes to flush the new filter.
- 9) Please refer to the additional filter instructions for further details.

6. Activate Self-Cleaning Function

Every week use the self-cleaning feature to sanitize tanks and water lines. To activate, press in the self-cleaning switch, hold for 5 seconds and release. The green indicator light on the left will begin blinking, indicating the cleaning process is underway. Ozone will be produced and injected into the water system. It will kill bacteria and bio-films typically found in water dispensers. By the end of the cycle the ozone will convert to harmless oxygen and be emitted into the air.

CAUTION: The cycle takes 90 minutes to complete. During this time do not dispense and drink the water. We recommend you do this during a period when the dispenser will not be in use like overnight or when staff is away from the office. During the cycle you may smell some ozone.

G: MACHINE INSTALLATION

Instructions for installation:

1. Loosen the screw of the right bottom angle just as the picture shown.
2. Make a hole on the floor's (or the desk's) surface where the water dispenser will be installed.
3. Fix the bracket on the floor by screw tightly.
4. Tighten the screw.

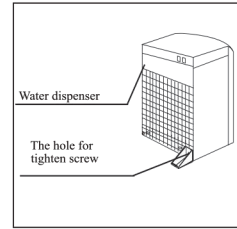

WARNING! To avoid a hazard due to instability of the appliance, it must be fixed in accordance with the instructions.

If you encounter any issues or have any concerns,
please email us at support@avalonproducts.com
or call 1800-256-0695.

Please see our website to learn more about our products
www.avalonproducts.com

Free Manuals Download Website

<http://myh66.com>

<http://usermanuals.us>

<http://www.somanuals.com>

<http://www.4manuals.cc>

<http://www.manual-lib.com>

<http://www.404manual.com>

<http://www.luxmanual.com>

<http://aubethermostatmanual.com>

Golf course search by state

<http://golfingnear.com>

Email search by domain

<http://emailbydomain.com>

Auto manuals search

<http://auto.somanuals.com>

TV manuals search

<http://tv.somanuals.com>