

# Refrigerator

User manual

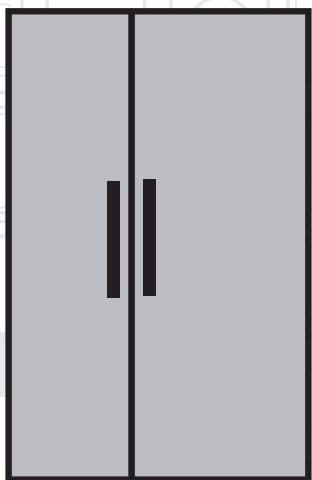

**ASL1331PX**  
**ASL1331B**

**EN**

**beko**



In the interest of your safety and to ensure the correct use, before installing and first using the appliance, read this user manual carefully, including its hints and warnings. To avoid unnecessary mistakes and accidents, it is important to ensure that all people using the appliance are thoroughly familiar with its operation and safety features. Save these instructions and make sure that they remain with the appliance if it is moved or sold, so that everyone using it through its life will be properly informed on appliance use and safety.

For the safety of life and property keep the precautions of these user's instructions as the manufacturer is not responsible for damages caused by omission.

### **Children and vulnerable people safety**

- This appliance can be used by children aged from 8 years and above and persons with reduced physical, sensory or mental capabilities or lack of experience and knowledge if they have been given supervision or instruction concerning use of the appliance in a safe way and understand the hazards involved.
- Children aged from 3 to 8 years are allowed to load and unload this appliance.
- Children should be supervised to ensure that they do not play with the appliance.
- Cleaning and user maintenance shall not be made by children unless they are aged from 8 years and above and supervised.
- Keep all packaging well away from children. There is risk of suffocation.
- If you are discarding the appliance pull the plug out of the socket, cut the connection cable (as close to the appliance as you can) and remove the door to prevent playing children from suffering a electric shock or closing themselves in it.
- If this appliance featuring magnetic door seals is to replace an older appliance having a spring lock (latch) on the door or lid, be sure to make that spring lock unusable before you discard the old appliance. This will prevent it from becoming dangerous for a child.

### **General safety**

-  **WARNING!** Keep ventilation openings, in the appliance enclosure or in the built-in structure, clear of obstruction.
-  **WARNING!** Do not use mechanical devices or other means to accelerate the defrosting process, other than those recommended by the manufacturer.
-  **WARNING!** Do not damage the refrigerant circuit.

- ⚠ WARNING!** Do not use other electrical appliances (such as ice cream makers) inside of refrigerating appliances, unless they are approved for this purpose by the manufacture.
- ⚠ WARNING!** Do not touch the light bulb if it has been on for a long period of time because it could be very hot.<sup>1)</sup>
- ⚠ WARNING!** When positioning the appliance, ensure the supply cord is not trapped or damaged.
- ⚠ WARNING!** Do not locate multiple portable socket-outlets or portable power supplies at the rear of the appliance.
- Do not store explosive substances such as aerosol cans with a flammable propellant in this appliance.
  - The refrigerant isobutane (R-600a) is contained within the refrigerant circuit of the appliance, a natural gas with a high level of environmental compatibility, which is nevertheless flammable.
  - During transportation and installation of the appliance, be certain that none of the components of the refrigerant circuit become damaged.
    - avoid open flames and sources of ignition
    - thoroughly ventilate the room in which the appliance is situated
  - It is dangerous to alter the specifications or modify this product in any way. Any damage to the cord may cause a short circuit, fire and/or electric shock.
  - This appliance is intended to be used in household and similar applications such as
    - staff kitchen areas in shops, offices and other working environments;
    - farm houses and by clients in hotels, motels and other residential type environments;
    - bed and breakfast type environments;
    - catering and similar non-retail applications.
- ⚠ WARNING!** Any electrical components(plug, power cord, compressor and etc.) must be replaced by a certified service agent or qualified service personnel.
- ⚠ WARNING!** The light bulb supplied with this appliance is a “special use lamp bulb” usable only with the appliance supplied. This “special use lamp” is not usable for domestic lighting.<sup>1)</sup>

<sup>1)</sup> If there is a light in the compartment.

- Power cord must not be lengthened.
- Make sure that the power plug is not squashed or damaged by the back of the appliance. A squashed or damaged power plug may overheat and cause a fire.
- Make sure that the mains plug of the appliance is accessible.
- Do not pull the mains cable.
- If the power plug socket is loose, do not insert the power plug. There is a risk of electric shock or fire.
- You must not operate the appliance without the lamp.
- This appliance is heavy. Care should be taken when moving it.
- Do not remove nor touch items from the freezer compartment if you hands are damp/wet, as this could cause skin abrasions or frost/freezer burns.
- Avoid prolonged exposure of the appliance to direct sunlight.

## Daily use

- Do not put hot objects on the plastic parts in the appliance.
- Do not place food products directly against the rear wall.
- Frozen food must not be re-frozen once it has been thawed out.<sup>1)</sup>
- Store pre-packed frozen food in accordance with the frozen food manufacturer's instructions<sup>1)</sup>
- Manufacturer's storage recommendations should be strictly adhered to. Refer to relevant instructions.
- Do not place carbonated or fizzy drinks in the freezer compartment as it creates pressure on the container, which may cause it to explode, resulting in damage to the appliance.<sup>1)</sup>
- Ice lollies can cause frost burns if consumed straight from the appliance.<sup>1)</sup>

To avoid contamination of food, please respect the following instructions

- Opening the door for long periods can cause a significant increase of the temperature in the compartments of the appliance.
- Clean regularly surfaces that can come in contact with food and accessible drainage systems.
- Clean water tanks if they have not been used for 48h; flush the water system connected to a water supply if water has not been drawn for 5 days.
- Store raw meat and fish in suitable containers in the refrigerator, so that it is not in contact with other food.
- Two-star frozen-food compartments(if they are presented in the appliance) are suitable for storing pre-frozen food, storing or making ice-cream and making ice cubes.

1) If there is a freezer compartment.

2) If there is a fresh-food storage compartment.

- One-, two- and three -star compartments (if they are presented in the appliance) are not suitable for the freezing of fresh food.
- If the appliance is left empty for long periods, switch off, defrost, clean, dry and leave the door open to prevent mould developing within the appliance.

### **Care and cleaning**

- Before maintenance, switch off the appliance and disconnect the mains plug from the mains socket.
- Do not clean the appliance with metal objects.
- Do not use sharp objects to remove frost from the appliance. Use a plastic scraper.<sup>1)</sup>
- Regularly examine the drain in the refrigerator for defrosted water. If necessary, clean the drain. If the drain is blocked, water will collect in the bottom of the appliance.<sup>2)</sup>

### **Installation**

**Important!** For electrical connection carefully follow the instructions given in specific paragraphs.

- Unpack the appliance and check if there are damages on it. Do not connect the appliance if it is damaged. Report possible damages immediately to the place you bought it. In that case retain packing.
- It is advisable to wait at least four hours before connecting the appliance to allow the oil to flow back in the compressor.
- Adequate air circulation should be around the appliance, lacking this leads to overheating. To achieve sufficient ventilation follow the instructions relevant to installation.
- Wherever possible the spacers of the product should be against a wall to avoid touching or catching warm parts (compressor, condenser) to prevent possible burn.
- The appliance must not be located close to radiators or cookers.
- Make sure that the mains plug is accessible after the installation of the appliance.

### **Service**

- Any electrical work required to do the servicing of the appliance should be carried out by a qualified electrician or competent person.
- This product must be serviced by an authorized Service Center, and only genuine spare parts must be used.

### **Energy saving**



- Don't put hot food in the appliance;
- Don't pack food close together as this prevents air circulating;
- Make sure food don't touch the back of the compartment(s);

1) If there is a freezer compartment.

2) If there is a fresh-food storage compartment.

- If electricity goes off, don't open the door(s);
- Don't open the door(s) frequently;
- Don't keep the door(s) open for too long time;
- Don't set the thermostat on exceeding cold temperatures;
- All accessories, such as drawers, shelves balconies, should be kept there for lower energy consumption

### Environment Protection

 This appliance does not contain gasses which could damage the ozone layer, in either its refrigerant circuit or insulation materials. The appliance shall not be discarded together with the urban refuse and rubbish. The insulation foam contains flammable gases: the appliance shall be disposed according to the appliance regulations to obtain from your local authorities. Avoid damaging the cooling unit, especially the heat exchanger. The materials used on this appliance marked by the symbol  are recyclable.



The symbol on the product or on its packaging indicates that this product may not be treated as household waste. Instead it should be taken to the appropriate collection point for the recycling of electrical and electronic equipment. By ensuring this product is disposed of correctly, you will help prevent potential negative consequences for the environment and human health, which could otherwise be caused by inappropriate waste handling of this product. For more detailed information about recycling of this product, please contact your local council, your household waste disposal service or the shop where you purchased the product.

### Packaging materials

The materials with the symbol are recyclable. Dispose the packaging in a suitable collection containers to recycle it.

### Disposal of the appliance

1. Disconnect the mains plug from the mains socket.
2. Cut off the mains cable and discard it.



 **WARNING!** During using, service and disposal the appliance, please pay attention to symbol as left side, which is located on rear of appliance (rear panel or compressor).

It's risk of fire warning symbol. There are flammable materials in refrigerant pipes and compressor.

Please be far away fire source during using, service and disposal.

# Overview

---

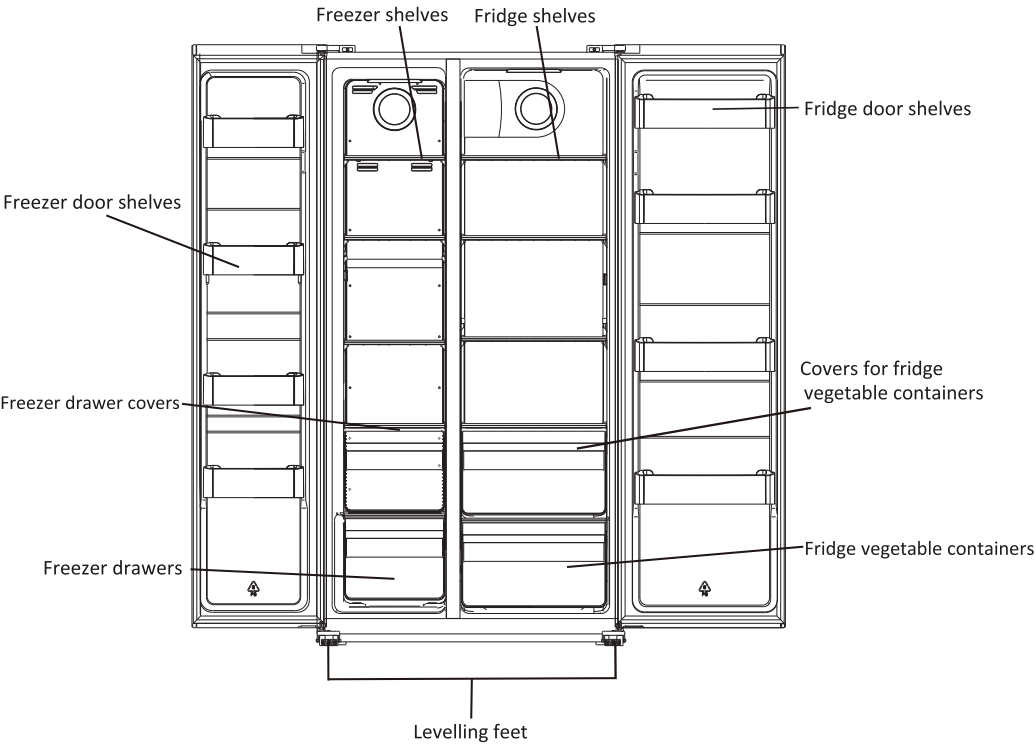

Note: Above picture is for reference only. Real appliance probably is different.

# Installation

---

If the kitchen door is not wide enough to pass the refrigerator through, the handles and doors can be removed according to the below process

## Remove the handles

Tool required: Hex wrench in accessory bag.

- Ensure the unit is unplugged and empty.
- All parts removed must be saved to do the reinstallation of the door.

1. Unscrew handles with Hex wrench.

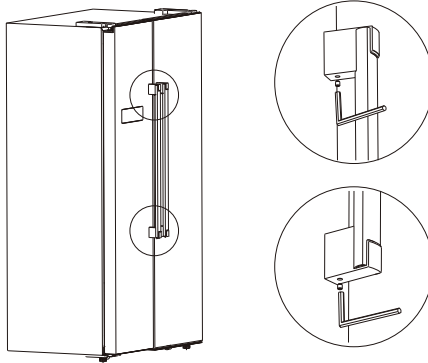

2. Pull the handles to remove them.

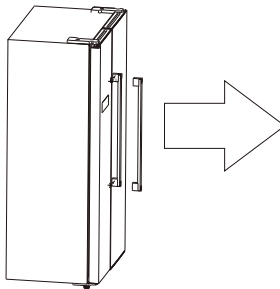

3. After the appliance is positioned, install the handles as reversed process.



# Installation

---

## Remove the doors

**Tool required:** Philips screwdriver, Flat bladed screwdriver.

- Ensure the unit is unplugged and empty.
- To take the door off, it is necessary to tilt the unit backwards. You should rest the unit on something solid so that it will not slip during the door removing process.
- All parts removed must be saved to do the reinstallation of the door.
- Do not lay the unit flat as this may damage the coolant system.
- It's better that 2 people handle the unit during assembly.

1. Unscrew hinge cover by Philips screwdriver.

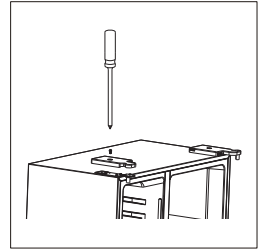

2. Disconnect the harness.

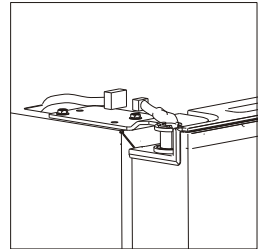

3. Unscrew top hinge.

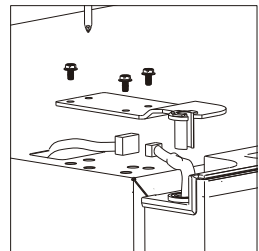

# Installation

---

4. Lift the door and place it on a soft pad. Then remove another door as same process.

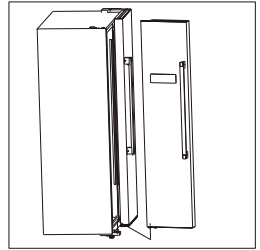

5. Unscrew bottom hinges.

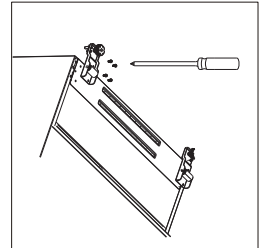

6. After the appliance is positioned, install the doors as reversed process.

# Installation

## Space Requirement

- Select a location without direct exposure to sunlight;
- Select a location with enough space for the refrigerator doors to open easily;
- Select a location with level (or nearly level) flooring;
- Allow sufficient space to install the refrigerator on a flat surface;
- Allow clearance to the right, left, back and top when installing. This will help reduce power consumption and keep your energy bills lower.

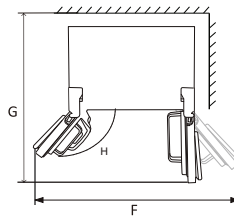
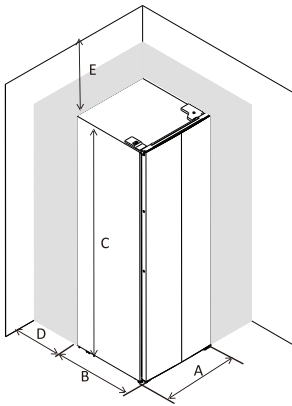

A	900
B	660
C	1770
D	min=50
E	min=50
F	1800
G	1560
H	135°

## Levelling the refrigerator

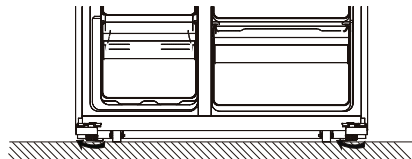
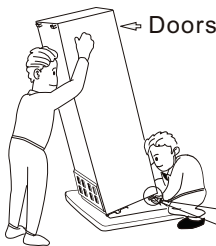

- Levelling and anchor the refrigerator by adjust the feet.
- Clockwise rotate feet to heighten them by hand.
- Anticlockwise rotate feet to lower them by hand.

# Installation

---

## Positioning

Install this appliance at a location where the ambient temperature corresponds to the climate class indicated on the rating plate of the appliance:

for refrigerating appliances with climate class:

- extended temperate: this refrigerating appliance is intended to be used at ambient temperatures ranging from 10 °C to 32 °C; (SN)
- temperate: this refrigerating appliance is intended to be used at ambient temperatures ranging from 16 °C to 32 °C;(N)
- subtropical: this refrigerating appliance is intended to be used at ambient temperatures ranging from 16 °C to 38 °C;(ST)
- tropical: this refrigerating appliance is intended to be used at ambient temperatures ranging from 16 °C to 43 °C;(T)

## Location

The appliance should be installed well away from sources of heat such as radiators, boilers, direct sunlight etc. Ensure that air can circulate freely around the back of the cabinet. To ensure best performance, if the appliance is positioned below an overhanging wall unit, the minimum distance between the top of the cabinet and the wall unit must be at least 100 mm. Ideally, however, the appliance should not be positioned below overhanging wall units. Accurate leveling is ensured by one or more adjustable feet at the base of the cabinet.

This refrigerating appliance is not intended to be used as a built-in appliance;



**Warning!** It must be possible to disconnect the appliance from the mains power supply; the plug must therefore be easily accessible after installation.

## Electrical connection

Before plugging in, ensure that the voltage and frequency shown on the rating plate correspond to your domestic power supply. The appliance must be earthed. The power supply cable plug is provided with a contact for this purpose. If the domestic power supply socket is not earthed, connect the appliance to a separate earth in compliance with current regulations, consulting a qualified electrician.

The manufacturer declines all responsibility if the above safety precautions are not observed.

This appliance complies with the E.E.C. Directives.

## Daily Use

---

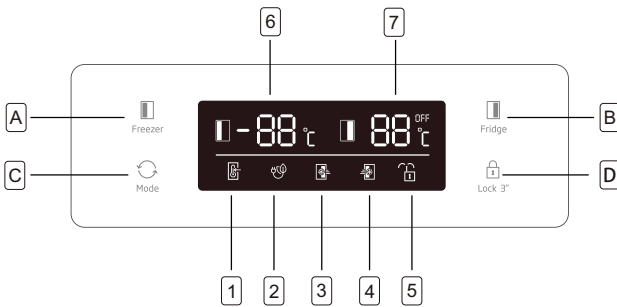

### Buttons

- A** Press to adjust temperature of freezer compartment (left side) from -14°C to -22°C.
- B** Press to adjust temperature of fridge compartment (right side) from 2°C to 8°C and "OFF". If select "OFF", fridge compartment will be turned off.
- C** Press to select running mode from **SMART**, **ECO**, **SUPER COOLING**, **SUPER FREEZING** and **USER'S SETTING** (no symbol in display).
- D** Press Lock 3 , button and hold for 3 seconds to lock other three buttons.  
Press it and hold for 1 second to unlock other three buttons.

### Display

- 1** **SMART** mode, the refrigerator sets the temperature of two compartments automatically according to internal temperature and ambient temperature.
- 2** **ECO** mode, the refrigerator runs in lowest energy consumption setting.
- 3** **SUPER COOLING** cools the fridge compartment to the lowest temperature for approx. 2 hours. Then the temperature set before super cooling is automatically restored.
- 4** **SUPER FREEZING** cools the freezer compartment to the lowest temperature for approx. 6 hours. Then the temperature set before super mode is automatically restored.
- 5** **LOCK**, the symbol will light on if buttons are locked.
- 6** Display the setting temperature of freezer compartment.
- 7** Display the setting temperature of fridge compartment.

### Door Open Alarm

If one door keeps open for 90 seconds, a periodical alarm will sound until the door is closed.

# Daily Use

---

## First use

### Cleaning the interior

Before using the appliance for the first time, wash the interior and all internal accessories with lukewarm water and some neutral soap so as to remove the typical smell of a brand new product, then dry thoroughly.

**Important!** Do not use detergents or abrasive powders, as these will damage the finish.

## Daily use

Position different food in different compartments according to be below table

Refrigerator compartments	Type of food
Door or balconies of fridge compartment	<ul style="list-style-type: none"><li>• Foods with natural preservatives, such as jams, juices, drinks, condiments.</li><li>• Do not store perishable foods.</li></ul>
Crisper drawer (salad drawer)	<ul style="list-style-type: none"><li>• Fruits, herbs and vegetables should be placed separately in the crisper bin.</li><li>• Do not store bananas, onions, potatoes, garlic in the refrigerator.</li></ul>
Fridge shelf – middle	<ul style="list-style-type: none"><li>• Dairy products, eggs</li></ul>
Fridge shelf – top	<ul style="list-style-type: none"><li>• Foods that do not need cooking, such as ready-to-eat foods, deli meats, leftovers.</li></ul>
Freezer drawer(s)/shelf	<ul style="list-style-type: none"><li>• Foods for long-term storage.</li><li>• Bottom drawer/shelf for raw meat, poultry, fish.</li><li>• Middle drawer/shelf for frozen vegetables, chips.</li><li>• Top drawer/shelf for ice cream, frozen fruit, frozen baked goods.</li></ul>

## EN Guidance for storing fresh food:

### **Storing into the fresh food compartment:**

- Keep your fridge at recommended temperature level as 4°C.
- Food to be stored should be properly sealed to avoid odour or taste alterations.
- Do not store excessive quantities of food inside your refrigerator. Leave spaces between foods to allow cold air flowing around them to achieve a better and more homogeneous cooling.
- To allow shorter door openings, foods eaten daily should be stored at the front of the shelf.
- Leave a gap between foods and the inner walls, allowing air to flow. If you store foods against the rear wall foods could freeze against rear wall.
- Hot, cooked food must be cooled down at room temperature before storing in the appliance. Then, warm food can be stored in the lower shelves of your fridge. Please do not put warm food nearby highly perishable foods.
- Thaw your frozen food in the fresh food compartment. This way, you can use the frozen food to cool down the fresh food compartment and save energy.
- If unripe tropical fruits (mango, melons, papaya, banana, pineapple) are stored in refrigerator, ageing process can be accelerated and it is not advisable since it causes shorter storage times. However, the ripening of strongly green fruits (apple, pear) can be promoted for a certain period in fridge compartment.
- Onions, garlic, ginger and other root vegetables should be stored at dark and cool room conditions, not in the fridge.
- When a spoiled food inside refrigerator is realized, it should be disposed. When rotten food is noticed, please clean inner liner or accessories which were in contact to prevent contamination.
- Large pots of food, such as soups or stews can be divided into shallow containers to quickly cool in the refrigerator. Large pieces of cooked meat and whole poultry should be divided into smaller pieces for the same purpose.

- Do not store unpacked foods nearby eggs.
- Keep fruits and vegetables separate and store like with like: apples with apples, carrots with carrots. Fruits and vegetables give off different gases that can cause others to deteriorate.
- Take leafy greens out of plastic bags, wrap them in a paper towel or tea towel before stored in refrigerator. Do not forget to dry them if they are rinsed or wet before storing.
- Store fruits and vegetables susceptible to drying out in perforated or unsealed plastic bags to maintain a moist environment yet still allow air to circulate.
- Different foods should be placed in different areas according to their properties:

“Please check appropriate Climate Class of your appliance rated on the rating plate. One of below information is valid for your appliance according to rated Climate Class.”

- SN: Extended Temperate: This refrigerating appliance is intended to be used at ambient temperatures ranging from 10°C to 32°C
- N: Temperate: This refrigerating appliance is intended to be used at ambient temperatures ranging from 16°C to 32°C
- ST: Subtropical: This refrigerating appliance is intended to be used at ambient temperatures ranging from 16°C to 38°C
- T: Tropical: This refrigerating appliance is intended to be used at ambient temperatures ranging from 16°C to 43°C

“This refrigerating appliance is not suitable for freezing foodstuffs”

### **EN Storing into the freezer compartment:**

- It is recommended to keep freezer setting at -20°C except extreme ambient conditions.
  - 4-6 hours before freezing switch on the Fast Freeze function to provide faster freezing.
  - Hot food must be cooled to room temperature before storing in the freezer compartment.
  - Food cut into small portions will freeze faster and be easier to defrost and cook.
  - It is better to pack food before putting it into the freezer.
  - In order to avoid expiry of storage periods, please note the freezing date, time limit and name of the food on the packaging according to the storage periods of different foods.
  - Do not exceed the food storage times recommended by the food manufacturers. Only take the required amount of food out of the freezer.
  - Consume defrosted food quickly. Defrosted food cannot be re-frozen unless it is cooked. It is not safe to consume uncooked re-frozen fresh food.
  - When freezing fresh food, avoid bringing it in contact with already frozen food. It may cause thawing of already frozen pieces.
- With the exception of extreme conditions in ambient, if temperature is set to recommended values as +4°C/-20°C, overall freshness will be prolonged within fresh food and freezer compartments. If temperature of fresh food compartment is set to cooler, fresh fruits and vegetables may be partially frozen or exposed to cold injury, while warmer temperature level may cause faster spoilage of highly perishable foods (dairy products, meat products).

### **When storing commercially frozen foods, please follow these guidelines:**

Always follow manufacturers' guidelines for the length of time you should store the food for. Do not exceed these guidelines!

- Try to keep the length of time between purchase and storage as short as possible to preserve food quality.
- Buy frozen foods, which have been stored at a temperature of -18 °C or below.
- Avoid buying food which has ice or frost on the packaging – This indicates that the products might have been partially defrosted and refrozen at some point – temperature rises affect the quality of food.
- We recommend a temperature setting of 4°C for fresh food compartment and -20°C for freezer compartment to achieve better food preservation.



# Daily Use

---

## Freezing fresh food

- The freezer compartment is suitable for freezing fresh food and storing frozen and deep-frozen food for a long time.
- Place the fresh food to be frozen in the bottom compartment.
- The maximum amount of food that can be frozen in 24 hours is specified on the rating plate.
- The freezing process lasts 24 hours: during this period do not add other food to be frozen.

## Storing frozen food

When first starting-up or after a period out of use, before putting the product in the compartment let the appliance run at least 2 hours on the higher settings.

**Important!** In the event of accidental defrosting, for example the power has been off for longer than the value shown in the technical characteristics chart under "rising time", the defrosted food must be consumed quickly or cooked immediately and then re-frozen ( after cooked).

## Thawing

Deep-frozen or frozen food, prior to be used, can be thawed in the fridge compartment or at room temperature, depending on the time available for this operation.

Small pieces may even be cooked still frozen, directly from the freezer. In this case, cooking will take longer.

## Accessories

### Movable shelves

The walls of the refrigerator are equipped with a series of runners so that the shelves can be positioned as desired.

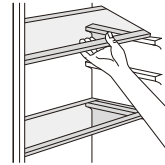

### Positioning the door balconies

To permit storage of food packages of various sizes, the door balconies can be placed at different heights. To make these adjustments proceed as follows: gradually pull the balcony in the direction of the arrows until it comes free, then reposition as required.



# Daily Use

---

## Helpful hints and tips

### Hints for freezing

To help you make the most of the freezing process, here are some important hints:

- the maximum quantity of food which can be frozen in 24 hrs. is shown on the rating plate;
- the freezing process takes 24 hours. No further food to be frozen should be added during this period;
- only freeze top quality, fresh and thoroughly cleaned, foodstuffs;
- prepare food in small portions to enable it to be rapidly and completely frozen and to make it possible subsequently to thaw only the quantity required;
- wrap up the food in aluminium foil or polythene and make sure that the packages are airtight;
- do not allow fresh, unfrozen food to touch food which is already frozen, thus avoiding a rise in temperature of the latter;
- lean foods store better and longer than fatty ones; salt reduces the storage life of food;
- water ices, if consumed immediately after removal from the freezer compartment, can possibly cause the skin to be freeze burnt;
- it is advisable to show the freezing in date on each individual pack to enable you removal from the freezer compartment, can possibly cause the skin to be freeze burnt;
- it is advisable to show the freezing in date on each individual pack to enable you to keep tab of the storage time.

### Hints for storage of frozen food

To obtain the best performance from this appliance, you should:

make sure that the commercially frozen foodstuffs were adequately stored by the retailer;

be sure that frozen foodstuffs are transferred from the food store to the freezer in the shortest possible time;

not open the door frequently or leave it open longer than absolutely necessary.

Once defrosted, food deteriorates rapidly and cannot be refrozen.

Do not exceed the storage period indicated by the food manufacture.

### Hints for fresh food refrigeration

To obtain the best performance:

- Do not store warm food or evaporating liquids in the refrigerator
- Do cover or wrap the food, particularly if it has a strong flavour

### Hints for refrigeration

Useful hints:

- Make (all types): wrap in polythene bags and place on the glass shelves above the vegetable drawer.
- For safety, store in this way only one or two days at the most.
- Cooked foods, cold dishes, etc...: these should be covered and may be placed on any shelf.
- Fruit and vegetables: these should be thoroughly cleaned and placed in the special drawer(s) provided.
- butter and cheese: these should be placed in special airtight containers or wrapped in aluminum foil or polythene bags to exclude as much air as possible.
- Milk bottle: these should have a cap and should be stored in the balconies on the door.
- Bananas, potatoes, onions and garlic, if not packed, must not be kept in the fridge.

## Cleaning

For hygienic reasons the appliance interior, including interior accessories, should be cleaned regularly.



**Caution!** The appliance may not be connected to the mains during cleaning. Danger of electrical shock! Before cleaning switch the appliance off and remove the plug from the mains, or switch off or turn out the circuit breaker or fuse. Never clean the appliance with a steam cleaner. Moisture could accumulate in electrical components, danger of electrical shock! Hot vapors can lead to the damage of plastic parts. The appliance must be dry before it is placed back into service.

**Important!** Ethereal oils and organic solvents can damage plastic parts, e.g. lemon juice or the juice form orange peel, butyric acid, cleanser that contain acetic acid.

# Daily Use

- Do not allow such substances to come into contact the appliance parts.
- Do not use any abrasive cleaners
- Remove the food from the freezer. Store them in a cool place, well covered.
- Switch the appliance off and remove the plug from the mains, or switch off or turn out the circuit breaker of fuse.
- Clean the appliance and the interior accessories with a cloth and lukewarm water. After cleaning wipe with fresh water and rub dry.
- After everything is dry place appliance back into service.

## Troubleshooting

 **Caution!** Before troubleshooting, disconnect the power supply. Only a qualified electrician or competent person must do the troubleshooting that is not in this manual.

**Important!** There are some sounds during normal use (compressor, refrigerant circulation).

Problem	Possible cause	Solution
Appliance does not work	Mains plug is not plugged in or is loose	Insert mains plug.
	Fuse has blown or is defective	Check fuse, replace if necessary.
	Socket is defective	Mains malfunctions are to be corrected by an electrician.
The food is too warm.	Temperature is not properly adjusted.	Please look in the initial Temperature Setting section.
	Door was open for an extended period.	Open the door only as long as necessary.
	A large quantity of warm food was placed in the appliance within the last 24 hours.	Turn the temperature regulation to a colder setting temporarily.
	The appliance is near a heat source.	Please look in the installation location section.
Appliance cools too much	Temperature is set too cold.	Turn the temperature regulation knob to a warmer setting temporarily.
Unusual noises	Appliance is not level.	Re-adjust the feet.
	The appliance is touching the wall or other objects.	Move the appliance slightly.
	A component, e.g. a pipe, on the rear of the appliance is touching another part of the appliance or the wall.	If necessary, carefully bend the component out of the way.
Water on the floor	Water drain hole is blocked.	See the Cleaning and Care section.
Side panels are hot	It's normal. Heat exchange is in the side panels	Take gloves to touch side panels if need.

If the malfunction shows again, contact the Service Center.

## **DISPOSAL**



This symbol indicates that this product shall not be disposed with other household wastes at the end of its service life. Used device must be returned to official collection point for recycling of electrical and electronic devices. To find these collection systems please contact to your local authorities or retailer where the product was purchased. Each household performs important role in recovering and recycling of old appliance. Appropriate disposal of used appliance helps prevent potential negative consequences for the environment and human health.

## **Please read these instructions first before using your appliance**

Thank you for choosing a Beko appliance.

Please take some time to read this user manual before using your appliance, to ensure you know how to safely operate the controls and functions.

Carefully follow all unpacking and installation instructions to ensure the appliance is correctly connected and fitted prior to use.

Please write your product model and serial number on the last page of this user manual, and store in a safe location close to the appliance for easy future reference.

This user manual may also be applicable for several other models. Differences between models will be listed.

If you have any questions or concerns, please call our contact centre or find help and information online at [www.beko.co.uk](http://www.beko.co.uk)

## BEKO UK AND IRELAND STANDARD MANUFACTURER GUARANTEE TERMS AND CONDITIONS

Your new Beko product is guaranteed against faulty materials, defective components or manufacturing defects.

**The standard guarantee starts from the date of original purchase of the product, and lasts for a period of twelve (12) months unless Beko plc (the "Manufacturer") agrees to extend the guarantee for the product in writing.**

**If you have purchased an American style Fridge freezer, the standard guarantee starts from the date of original purchase of the product, and lasts for a period of twenty-four (24) months unless Beko plc (the "Manufacturer") agrees to extend the guarantee for the product in writing.**

If you have any questions about the guarantee on your product (including how long it is valid), please contact your retailer or our contact centre on **0333 207 9710** (UK and Northern Ireland) or **01 862 3411** (Republic of Ireland)

This guarantee does not in any way diminish or affect your statutory rights in connection with the product. This guarantee is in addition to your statutory rights as a consumer. If you have any questions about these rights, please contact the retailer from which you purchased the product. In certain circumstances, it is possible that your statutory rights may offer additional or higher levels of protection than those offered under the terms of this guarantee.

### What is covered by this guarantee?

- Repairs to the product required as a result of faulty materials, defective components or manufacturing defects.
- Functional replacement parts to repair a product.
- The costs of a Beko Approved Engineer to carry out the repair.

### What is not covered?

- Transit and delivery damage.
- Cabinet or appearance parts, including but not limited to control knobs, flaps and handles.
- Accessories and/or consumable items including but not limited to ice trays, scrapers, cutlery baskets, filters and light bulbs.
- Repairs necessary as a direct or indirect result of:
  - Accidental damage, misuse or abuse of a product.
  - An attempted repair of a product by anyone other than a Beko Approved Engineer (the "Engineer").
  - Installation or use of a product where such installation or use fails to meet the requirements contained in this guarantee or the User Instructions Booklet.
- Repairs to a product operated at any time on commercial or non-residential household premises (unless we have previously agreed to the installation environment).

This guarantee is limited to the cost of repairing the product. To the extent permitted by law, the Manufacturer does not accept and will not be held liable for any financial loss incurred in connection with the failure of any product to operate in accordance with the expected standards. Such financial loss includes but is not limited to loss arising from:

- Time taken off work.
- Damaged food, clothing or other items.
- Meals taken at restaurants or from takeaways.
- General compensation for inconvenience.

### Important Notes

1. Your product is designed and built for domestic household use only.
2. The guarantee will automatically be void if the product is installed or is used in commercial or non-residential domestic household premises, unless we have previously agreed to the installation environment.
3. The product must be correctly installed, located and operated in accordance with the instructions contained in the User Instructions Booklet provided with your product.
4. Professional installation by a qualified Electrical Domestic Appliance Installer is recommended for all Washing Machines, Dishwashers and Electric Cookers (as incorrect installation may result in you having to pay for the cost of repairing the product).
5. Gas Cookers must be professionally installed by a Gas Safe (or Gas Networks Ireland for Republic of Ireland) registered gas installer.
6. This guarantee is given in respect of products purchased and used within the United Kingdom and the Republic of Ireland.
7. This guarantee is effective from the initial date of purchase of a new product from an authorised retailer and will be void if the product is resold.
8. This guarantee does not apply to graded sales (where the product is purchased as a "second").

9. Possession of a copy of these terms and conditions does not necessarily mean that a product has the benefit of this guarantee. If you have any questions, please call our Call Centre on the number set out above.
10. The Manufacturer reserves the right to terminate the guarantee if its staff or representatives are subjected to physical or verbal abuse in the course of carrying out their duties.
11. Optional extras, where available (i.e. extendable feet) are supplied on a chargeable basis only.

#### **Does Beko offer replacements?**

This is a repair-only guarantee. On occasion, the Manufacturer may at its sole discretion, replace your product with a new product instead of carrying out a repair. Where a replacement is offered, this would normally be an identical model but when this is not possible, a model of similar specification will be provided. The Manufacturer will cover the costs and arrange for the delivery of the new product and for the return of the old product. Any costs related to disconnecting the faulty product and installing the replacement product will not be borne by the Manufacturer unless previously agreed to in writing. The original guarantee will continue to apply to the replacement product; the new product will not come with a new guarantee.

#### **When will the repair take place?**

Our Engineers work Monday to Friday 9.00am to 5.00pm. Appointments outside these hours may be possible at the sole discretion of the Manufacturer but cannot be guaranteed. Whilst our Engineers will endeavour to minimize inconvenience and to meet requests for specific timed appointments, this cannot be guaranteed. We will not be liable for delays or if it is unable to carry out a repair because a convenient appointment cannot be arranged.

#### **Will there be any charge for the repairs?**

It is your responsibility to provide evidence to the Engineer that your product is covered by this guarantee with a proof of purchase. The Manufacturer reserves the right to charge for the reasonable cost of any service call if:

- You cannot provide evidence that your product is covered by this guarantee.
- Where a service call has been made and the engineer finds that there is no fault with your product.
- That your product has not been installed or operated in accordance with the User Instructions Booklet.
- That the fault was caused by something other than faulty materials, defective components or manufacturing defects.
- For missed appointments.

Payment of these costs are due immediately upon the Engineer providing you with an invoice. The Manufacturer reserves the right to terminate the guarantee if you fail to pay the costs for the service call in a timely manner.

If you are a resident of the United Kingdom, this guarantee will be governed by English law and subject to the English Courts, save where you live in another part of the United Kingdom, in which case the law and courts of that location will apply.

If you are resident in the Republic of Ireland, this guarantee will be governed by Irish law and the Irish courts will have jurisdiction.

This guarantee is provided by Beko plc. Beko House, 1 Greenhill Crescent, Watford, Hertfordshire. WD18 8QU.

Beko plc is registered in England and Wales with company registration number 02415578.

**BEKO UK AND IRELAND BUILT-IN APPLIANCES GUARANTEE TERMS AND CONDITIONS**

**If you have purchased a built-in or integrated appliance, and registered it within 90 days of purchase by completing the online registration form, then the standard 12 month guarantee will be extended to 24 months, under the same terms and conditions as detailed in our Standard Guarantee Terms and Conditions.**



## BEKO UK AND IRELAND PROSMART INVERTER MOTOR GUARANTEE TERMS AND CONDITIONS

**This 10 year guarantee relates to Beko products that feature the ProSmart Inverter Motor.**

The ProSmart Motor guarantee terms and conditions are in addition to our Standard guarantee terms and conditions detailed in the previous section.

**In order to activate the 10 year guarantee you MUST register the appliance within 90 days of the original purchase date. You can register by first visiting [Beko.co.uk/register](http://Beko.co.uk/register) and by following the online instructions.**

Beko Free standing appliances come with a 12 month parts and labour guarantee as standard,

Beko Built-in appliances come with a 12 month parts and labour guarantee as standard. This is extended to 24 months, free of charge, upon registration of the appliance. When you register your appliance for additional guarantee, you will automatically activate the ProSmart Motor 10 year guarantee. You do not need to register twice. ([beko.co.uk/guarantee-terms](http://beko.co.uk/guarantee-terms)).

To make a claim against your Beko ProSmart Inverter Motor Guarantee (the "Guarantee"), all customer and product details must be registered with Beko plc using the procedure outlined below.

1. This extra 9 years (for free standing appliances) or 8 years (for built-in or integrated appliances) guarantee is only effective after the expiration of the standard manufacturer's guarantee.
2. It is only valid for the ProSmart Inverter motors of selected washing machines, washer-dryers, tumble dryers and dishwashers. It does not cover any labour charge or any other components of the product. In addition, it is only valid for one replacement of the ProSmart motor during the extra 9-year (for free standing appliances) or 8 year (for built-in appliances) guarantee period.
3. To activate your guarantee, you MUST register your appliance within 90 days of the original purchase date, by visiting [beko.co.uk/register](http://beko.co.uk/register).
4. Customers will receive a unique reference code as proof of guarantee validation by email or post, which must be quoted at the time of a claim being made.
5. Any repair/replacement of the ProSmart Inverter motor must only be carried out by an authorised Beko Service Agent (the "Service Agent").
6. Labour for the repair/replacement of the ProSmart Inverter motor is not included in this guarantee and is chargeable directly by the Service Agent.
7. Any additional components fitted to the product at any time will not be covered by this guarantee and will be chargeable directly by the Service Agent.
8. The guarantee is not transferable and cannot be exchanged for cash.
9. There are no alternative or additional offers to this Guarantee.
10. The guarantee is exclusive of the manufacturer's standard guarantee
11. The Terms and Conditions shown above are in addition to the standard terms and conditions of your product guarantee. Please read and refer to such Terms and Conditions when making any claim.
12. We may use the information you provide for marketing purposes and to analyse your purchasing preferences. We may keep your information for a reasonable period for these purposes in accordance with the applicable Data Protection Laws and General Data Protection Regulations (GDPR). You can opt into this service during the registration process. Further details are available at <http://www.beko.co.uk/cookie-and-privacy>.
13. These Terms and Conditions are governed by the laws of England and Wales; manufacturer: Beko plc, Beko House, 1 Greenhill Crescent, Watford WD18 8QU. Company Registration Number: 02415578.

## HOW TO OBTAIN SERVICE FOR YOUR APPLIANCE

Please keep your purchase receipt or other proof of purchase details in a safe place; you will need to have this documentation available should the product require attention under guarantee.

Please take a few moments to complete the details below, as you will need this information when you call us, or to use our online services. When you call us you may be required to input your serial number into your telephone keypad. For help please visit [beko.co.uk/support/model-finder](http://beko.co.uk/support/model-finder)

- The product model number is printed on the Operating Instruction Booklet/ User guide
- The product model and serial number is printed on the Rating Label affixed to the appliance.
- The Retailer (Purchased from) and Date of purchase will be printed on your purchase receipt or other proof of purchase paperwork

Recording of these details alone will not count as proof of purchase. A valid proof of purchase is required for requesting service under guarantee.

Model number	Serial number	Purchased from	Date of purchase

### For service under guarantee or for product advice please call our Contact centre

Before requesting service please check the troubleshooting guide in the Operating Instructions booklet, as a charge may be levied where no fault is found, and even though your product may still be under guarantee.

After arranging service the area around the product must be easily accessible to the Engineer, without the need for cabinets or furniture to be removed or moved.

It is your responsibility to ensure our Engineers have a clean and safe environment to carry out any repairs.

Please have your Model number and Serial number available when you call us, as you may be required to input your serial number into your telephone keypad during your call.

**UK Mainland & Northern Ireland:**

**0333 207 9710**

*Landline or mobile calls to 0333 numbers cost no more than calls to geographic numbers 01 or 02, and are charged at the basic rate. Calls from landlines and mobiles are included in free call packages but please check with your telephone service provider for exact call charges.*

**Republic of Ireland:**

**01 862 3411**

### Service once the manufacturers guarantee has expired

*If you have purchased an extended guarantee please refer to the instructions contained within the extended guarantee agreement document, otherwise please call us using the appropriate number above, where service can be obtained at a charge.*

Should you experience any difficulty in obtaining service please call us on **0333 207 9710** or **01 862 3411**

### Contact us through our website

Send us a secure message through our online contact us form. Please visit our website, click Contact Us and choose a product support topic from the list of options. Complete the required details and click send message.

### Product registrations

For UK registrations please visit [beko.co.uk/register](http://beko.co.uk/register) and for the Republic of Ireland visit [beko.ie/register](http://beko.ie/register).

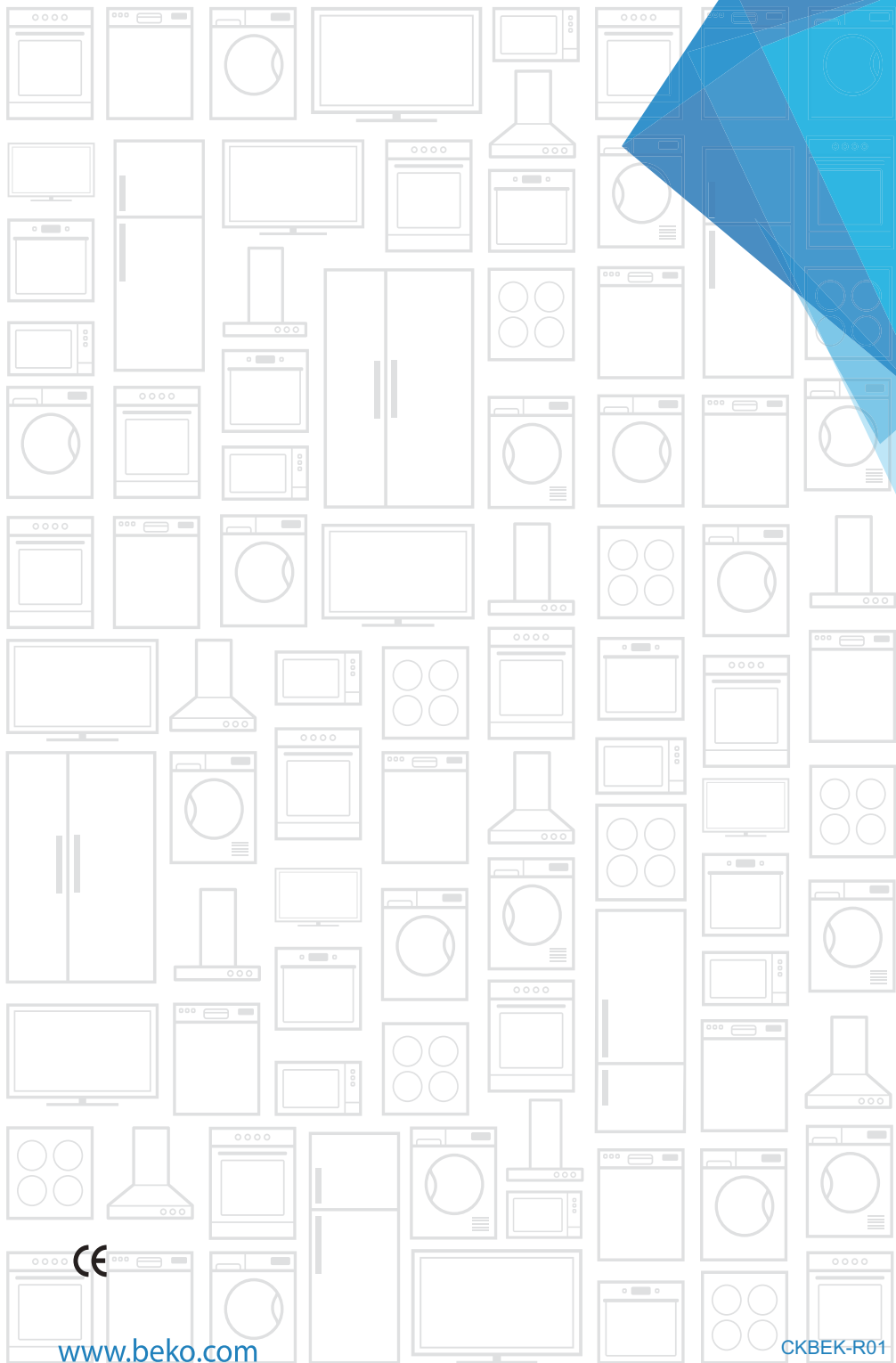

## Free Manuals Download Website

<http://myh66.com>

<http://usermanuals.us>

<http://www.somanuals.com>

<http://www.4manuals.cc>

<http://www.manual-lib.com>

<http://www.404manual.com>

<http://www.luxmanual.com>

<http://aubethermostatmanual.com>

Golf course search by state

<http://golfingnear.com>

Email search by domain

<http://emailbydomain.com>

Auto manuals search

<http://auto.somanuals.com>

TV manuals search

<http://tv.somanuals.com>