



# OVEN

## User Manual

Beko plc  
Beko House  
Caxton Way  
Watford  
Herts WD1 8UF  
Tel: 0845 6004904

Printed in Turkey  
Part no.485.9211.65  
Revision no.AA / 08.10.2010

# OVEN

## User Manual

Beko plc  
Beko House  
Caxton Way  
Watford  
Herts WD1 8UF  
Tel: 0845 6004904

Printed in Turkey  
Part no.485.9211.65  
Revision no.AA / 08.10.2010



**Introduction**

Welcome/Safety symbols	2
Safety in the home	4

**Installation**

Know your cooker/Specification	6
Location/Ventilation	7
Installation	8
Assembling the grill and splash back/	9
Electrical connection	10
Gas connection	11
Gas conversion	12

**For the very first time**

Preparation and burning off	13
-----------------------------	----

**Operating**

Operating the hob	14
Saucepans/Deep fat frying	15
Operating the grill	16
Operating the oven	17
Guide to cooking temperatures	18

**Cooker care**

Care & cleaning	19
Trouble shooting	20
Replacing the oven lamp	20
Future transportation	20
Guarantee/Service	21

**If the cooker does not work**

If the appliance does not operate check whether:

- The power and gas supply are on.
- The fuse has blown/circuit breaker has tripped/main distribution switch has been turned off.
- The temperature control has been set correctly.

If the appliance is still not operating after the above checks, please refer to the section on how to obtain service.

**Please ensure that the above checks have been made as a charge will be made if no fault is found.**

**Performance characteristics when in use**

- **When using your appliance for the first few times, an odour and/or smoke may be emitted which is normal** - see page 12.
- It is normal for the metal parts to produce noise when in use, this is due to expansion and contraction.
- When in use, steam may be produced which is normal and not a fault of the cooker.
- At the end of a cooking session, it is normal to have a momentary puff of steam when the oven door is opened. This should disperse in a few seconds.
- If, whilst cooking, steam produced comes in to contact with cool surface's on the outside of the appliance, it will condense and produce water droplets. This is quite normal and is not a fault.

replacing the oven lamp

**Switch off at the mains.**

- 1 Remove the glass cover of the lamp by turning it anti-clockwise.
- 2 Remove the bulb by turning it anti-clockwise.
- 3 After installing the correct bulb, reinstall the glass cover.

Replacement light bulbs can be easily obtained from a good local electrical or DIY store.

future transportation

Keep the original carton and other packaging material in a safe place. Transport the cooker in its original carton. Follow the instructions that are printed on the carton.

To prevent the accessories inside the oven from damaging the oven door, tape a strip of cardboard onto the inside of the oven door that lines up with the position of the trays. Tape the oven door to the side walls.

**If you do not have the original carton**

Take the necessary precautions in order to prevent the exterior panels, and the glass surfaces of the oven from being damaged.

Pack the oven in bubble wrap or thick cardboard and tape it securely in order to prevent damage during transportation.

The oven must be transported upright. Do not place other items on the top of the cooker.



**Introduction**

Welcome/Safety symbols	2
Safety in the home	4

**Installation**

Know your cooker/Specification	6
Location/Ventilation	7
Installation	8
Assembling the grill and splash back/	9
Electrical connection	10
Gas connection	11
Gas conversion	12

**For the very first time**

Preparation and burning off	13
-----------------------------	----

**Operating**

Operating the hob	14
Saucepans/Deep fat frying	15
Operating the grill	16
Operating the oven	17
Guide to cooking temperatures	18

**Cooker care**

Care & cleaning	19
Trouble shooting	20
Replacing the oven lamp	20
Future transportation	20
Guarantee/Service	21

**If the cooker does not work**

If the appliance does not operate check whether:

- The power and gas supply are on.
- The fuse has blown/circuit breaker has tripped/main distribution switch has been turned off.
- The temperature control has been set correctly.

If the appliance is still not operating after the above checks, please refer to the section on how to obtain service.

**Please ensure that the above checks have been made as a charge will be made if no fault is found.**

**Performance characteristics when in use**

- **When using your appliance for the first few times, an odour and/or smoke may be emitted which is normal** - see page 12.
- It is normal for the metal parts to produce noise when in use, this is due to expansion and contraction.
- When in use, steam may be produced which is normal and not a fault of the cooker.
- At the end of a cooking session, it is normal to have a momentary puff of steam when the oven door is opened. This should disperse in a few seconds.
- If, whilst cooking, steam produced comes in to contact with cool surface's on the outside of the appliance, it will condense and produce water droplets. This is quite normal and is not a fault.

replacing the oven lamp

**Switch off at the mains.**

- 1 Remove the glass cover of the lamp by turning it anti-clockwise.
- 2 Remove the bulb by turning it anti-clockwise.
- 3 After installing the correct bulb, reinstall the glass cover.

Replacement light bulbs can be easily obtained from a good local electrical or DIY store.

future transportation

Keep the original carton and other packaging material in a safe place. Transport the cooker in its original carton. Follow the instructions that are printed on the carton.

To prevent the accessories inside the oven from damaging the oven door, tape a strip of cardboard onto the inside of the oven door that lines up with the position of the trays. Tape the oven door to the side walls.

**If you do not have the original carton**

Take the necessary precautions in order to prevent the exterior panels, and the glass surfaces of the oven from being damaged.

Pack the oven in bubble wrap or thick cardboard and tape it securely in order to prevent damage during transportation.

The oven must be transported upright. Do not place other items on the top of the cooker.

Your Beko product is guaranteed against the cost of breakdown repairs for twelve months from the date of the original purchase.

## What is covered?

- All repairs necessary as a result of faulty materials, defective components or manufacturing defect.
- The cost of all functional replacement parts.
- The labour costs of a Beko approved repairer to carry out the repair.

## What is not covered?

- Transit or delivery damage
  - Accidental damage
  - Misuse, or abuse.
  - Cabinet or appearance parts, including knobs and flaps
  - Accessory items, including ice trays, scrapers, cutlery baskets,
  - Repairs required as a result of unauthorised repairs or inexpert installation that fails to meet the requirements contained in the user instruction book.
- Repairs to products used on commercial or non-residential

household premises.

## Important notes.

- The product is guaranteed for domestic household use only.
- The guarantee will be void if the product is installed or used in commercial or non-residential household premises.
- The product must be correctly installed, located and operated in accordance with the instructions contained in the User Instructions Booklet provided.
- Professional Installation by a qualified plumber/electrical appliance installer is recommended for all Washing & Dishwashing Machines and Electric Cookers
- Gas Cookers must only be installed by a Gas Safe (or BORD GAIS) registered Gas Installer.
- The guarantee is given only within the boundaries of the United Kingdom.
- The guarantee is not transferable if the product is resold.
- Beko plc disclaims any liability for incidental or consequential damages.
- The guarantee does not in anyway diminish your statutory or legal rights.

## HOW TO OBTAIN SERVICE UNDER THE MANUFACTURERS GUARANTEE

Please keep your purchase receipt or other proof of purchase in a safe place; you will need to have it should the product require attention in the guarantee period

You should also complete the details below; it will help us assist you quicker when requesting service. (The model number is printed on the Instruction Booklet)

Model Number: \_\_\_\_\_ Purchased From: \_\_\_\_\_ Date of purchase: \_\_\_\_\_

For service under guarantee simply telephone the appropriate number below

LOCATION	TELEPHONE
----------	-----------

UK Mainland & Northern Ireland

Fridges & Freezers	0845 600 4903
Electric Cookers	0845 600 4902
Gas & Dual Fuel Cookers	0845 600 4905
Washing Machines & Dishwashers	0845 600 4906

Republic of Ireland	
All Refrigeration, Cooking, Washing & Dishwashing Machines	01 862 3411

Before requesting service please check the trouble-shooting guide in the Operating Instructions as a charge may be levied where no fault is found even though your product may still be under guarantee.

Service once the manufacturers guarantee has expired.

If you have purchased an extended guarantee please refer to the instructions contained within the extended guarantee agreement document. Otherwise please call the above numbers where service can be obtained at a charge.

Should you experience any difficulty in obtaining service please call the

**Beko Customer Help-Line on 0845 600 4911**

**Beko House, Caxton Way, Watford, Herts, WD18 8UF, Tel: 0845 600 4911**

Your Beko product is guaranteed against the cost of breakdown repairs for twelve months from the date of the original purchase.

## What is covered?

- All repairs necessary as a result of faulty materials, defective components or manufacturing defect.
- The cost of all functional replacement parts.
- The labour costs of a Beko approved repairer to carry out the repair.

## What is not covered?

- Transit or delivery damage
  - Accidental damage
  - Misuse, or abuse.
  - Cabinet or appearance parts, including knobs and flaps
  - Accessory items, including ice trays, scrapers, cutlery baskets,
  - Repairs required as a result of unauthorised repairs or inexpert installation that fails to meet the requirements contained in the user instruction book.
- Repairs to products used on commercial or non-residential

household premises.

## Important notes.

- The product is guaranteed for domestic household use only.
- The guarantee will be void if the product is installed or used in commercial or non-residential household premises.
- The product must be correctly installed, located and operated in accordance with the instructions contained in the User Instructions Booklet provided.
- Professional Installation by a qualified plumber/electrical appliance installer is recommended for all Washing & Dishwashing Machines and Electric Cookers
- Gas Cookers must only be installed by a Gas Safe (or BORD GAIS) registered Gas Installer.
- The guarantee is given only within the boundaries of the United Kingdom.
- The guarantee is not transferable if the product is resold.
- Beko plc disclaims any liability for incidental or consequential damages.
- The guarantee does not in anyway diminish your statutory or legal rights.

## HOW TO OBTAIN SERVICE UNDER THE MANUFACTURERS GUARANTEE

Please keep your purchase receipt or other proof of purchase in a safe place; you will need to have it should the product require attention in the guarantee period

You should also complete the details below; it will help us assist you quicker when requesting service. (The model number is printed on the Instruction Booklet)

Model Number: \_\_\_\_\_ Purchased From: \_\_\_\_\_ Date of purchase: \_\_\_\_\_

For service under guarantee simply telephone the appropriate number below

LOCATION	TELEPHONE
----------	-----------

UK Mainland & Northern Ireland

Fridges & Freezers	0845 600 4903
Electric Cookers	0845 600 4902
Gas & Dual Fuel Cookers	0845 600 4905
Washing Machines & Dishwashers	0845 600 4906

Republic of Ireland	
All Refrigeration, Cooking, Washing & Dishwashing Machines	01 862 3411

Before requesting service please check the trouble-shooting guide in the Operating Instructions as a charge may be levied where no fault is found even though your product may still be under guarantee.

Service once the manufacturers guarantee has expired.

If you have purchased an extended guarantee please refer to the instructions contained within the extended guarantee agreement document. Otherwise please call the above numbers where service can be obtained at a charge.

Should you experience any difficulty in obtaining service please call the

**Beko Customer Help-Line on 0845 600 4911**

**Beko House, Caxton Way, Watford, Herts, WD18 8UF, Tel: 0845 600 4911**

Dear customer

Congratulations on your choice of a Beko quality cooker which has been designed to give you lasting service.

The cooker must be installed by a suitably person e.g. licensed gasfitter accordance with current local regulations and used in a well ventilated space.

Please read these instructions thoroughly before installing or using - and keep for handy reference. Make sure you understand the controls prior to using your appliance. This cooker must only be used for its intended purpose, ie the cooking of food in the home. Failure to observe these instructions may invalidate your right to free service during the guarantee period.

If you have any questions, or if you are not sure about any information contained in this booklet please contact us - details are on the back cover.

The use of any appliance and cookers in particular (which use gas and high temperatures) require the following of basic common sense safety rules.

There is a danger of injury to the person and of damage to the cooker, the kitchen and your home.

These are itemised in the first section 'Safety in the home'. Where accidents are most common, we repeat these warnings in the main text using the following symbols:



**Where you, other people, toddlers and children are at risk**



**Where there is a danger of damage to the cooker, utensils, surrounding areas and property**

Please note them for your own safety.

Printed in Turkey

Part no.485.9211.65

Revision no.AA / 08.10.2010

Dear customer

Congratulations on your choice of a Beko quality cooker which has been designed to give you lasting service.

The cooker must be installed by a suitably person e.g. licensed gasfitter accordance with current local regulations and used in a well ventilated space.

Please read these instructions thoroughly before installing or using - and keep for handy reference. Make sure you understand the controls prior to using your appliance. This cooker must only be used for its intended purpose, ie the cooking of food in the home. Failure to observe these instructions may invalidate your right to free service during the guarantee period.

If you have any questions, or if you are not sure about any information contained in this booklet please contact us - details are on the back cover.

The use of any appliance and cookers in particular (which use gas and high temperatures) require the following of basic common sense safety rules.

There is a danger of injury to the person and of damage to the cooker, the kitchen and your home.

These are itemised in the first section 'Safety in the home'. Where accidents are most common, we repeat these warnings in the main text using the following symbols:



**Where you, other people, toddlers and children are at risk**



**Where there is a danger of damage to the cooker, utensils, surrounding areas and property**

Please note them for your own safety.

Printed in Turkey

Part no.485.9211.65

Revision no.AA / 08.10.2010

# safety in the home

## Look after your cooker and home

- Clean your cooker regularly, ideally after each use. Always turn off the mains electricity supply and make sure pan supports, burners and other surfaces are cool before touching them.
- Spillage should be dealt with as soon as it occurs, taking due care as the hob surface may be hot. Any spillage left on the surface after cooking should be cleaned off before the hob is turned on again to prevent baking on.
- Don't use biological washing powder or bleach products, harsh abrasives or chemical cleaners for cleaning the oven inner panels.
- Don't allow anyone to sit or stand on the cooker or door.
- Don't move the cooker by pulling by the door and/or handle.
- Ensure that no flammable materials are adjacent to the cooker as the sides become hot during use.
- Don't store flammable materials, aerosols etc in adjacent cabinets.
- Don't place flammable or plastic items on or near the hob, and never place wet cloths etc. on the hob or grill hood to dry.
- Keep all ventilation slots clear of obstructions.
- Don't leave a burner on for long periods when not covered by a pan.
- Don't cover shelves with metal foil as the air circulation in the oven will be disrupted.
- Don't place dishes, pans, trays directly on the oven compartment base.
- Don't line the grill pan with aluminium foil this will result in an increase in temperature and could result in damage to your cooker or increased risk of fire.
- Don't use the cooker with glass windows removed.

## Don't use the cooker for

- Hanging towels and dish cloths etc on the handles.
- Warming plates under or on the grill hood.
- Heating the kitchen.
- Drying.

## Food hygiene

- Ensure meat and poultry is thoroughly defrosted before cooking.
- Check food is thoroughly cooked and is piping hot.
- **Always refer servicing to a qualified appliance service engineer.**



5

## Guide to cooking temperatures

### 'S' (Slow) cooking

The 'S' setting is a low temperature setting. You can cook on 'S' throughout, or use a 30 minute 'boost' period at gas mark 6 and then 'S' cook.

When roasting joints, poultry or pot roasting, always cook at Mark 6 for 30 minutes at the beginning of the cooking period.

### Guide to thermostat settings

Because there are different ways of recording oven temperatures no direct conversion can be given from Gas Mark to temperature measured in the oven. The following chart shows the relationship between Gas Mark and the commonly used temperatures.

Gas Mark	Oven heat	Temperature
S, 1/4, 1/2	Very cool	105°C - 120°C 225°F - 250°F
1	Cool or slow	135°C 275°F
2	Cool or slow	150°C 300°F
3	Warm oven	160°C 325°F
4	Moderate	175°C 350°F
5	Fairly hot oven	190°C 375°F
6	Hot oven	200°C 400°F
7	Hot oven	220°C 425°F
8	Very hot oven	230°C 450°F
9	Very hot oven	240°C 460°F

## operating the minute minder

The mechanical timer is adjustable up to 120 minutes.

To obtain 120 timer setting turn the knob clockwise until the end and then turn the knob anti-clockwise to the bar mark.

1- Turn the knob clockwise until the end.

2- Turn the knob anti-clockwise to the desired time.

3- At the end of the preset time a buzzer sounds which goes off after a while.

**This timer is for timing any process and does not cut the gas off.**

18

# safety in the home

## Look after your cooker and home

- Clean your cooker regularly, ideally after each use. Always turn off the mains electricity supply and make sure pan supports, burners and other surfaces are cool before touching them.
- Spillage should be dealt with as soon as it occurs, taking due care as the hob surface may be hot. Any spillage left on the surface after cooking should be cleaned off before the hob is turned on again to prevent baking on.
- Don't use biological washing powder or bleach products, harsh abrasives or chemical cleaners for cleaning the oven inner panels.
- Don't allow anyone to sit or stand on the cooker or door.
- Don't move the cooker by pulling by the door and/or handle.
- Ensure that no flammable materials are adjacent to the cooker as the sides become hot during use.
- Don't store flammable materials, aerosols etc in adjacent cabinets.
- Don't place flammable or plastic items on or near the hob, and never place wet cloths etc. on the hob or grill hood to dry.
- Keep all ventilation slots clear of obstructions.
- Don't leave a burner on for long periods when not covered by a pan.
- Don't cover shelves with metal foil as the air circulation in the oven will be disrupted.
- Don't place dishes, pans, trays directly on the oven compartment base.
- Don't line the grill pan with aluminium foil this will result in an increase in temperature and could result in damage to your cooker or increased risk of fire.
- Don't use the cooker with glass windows removed.

## Don't use the cooker for

- Hanging towels and dish cloths etc on the handles.
- Warming plates under or on the grill hood.
- Heating the kitchen.
- Drying.

## Food hygiene

- Ensure meat and poultry is thoroughly defrosted before cooking.
- Check food is thoroughly cooked and is piping hot.
- **Always refer servicing to a qualified appliance service engineer.**



5

## Guide to cooking temperatures

### 'S' (Slow) cooking

The 'S' setting is a low temperature setting. You can cook on 'S' throughout, or use a 30 minute 'boost' period at gas mark 6 and then 'S' cook.

When roasting joints, poultry or pot roasting, always cook at Mark 6 for 30 minutes at the beginning of the cooking period.

### Guide to thermostat settings

Because there are different ways of recording oven temperatures no direct conversion can be given from Gas Mark to temperature measured in the oven. The following chart shows the relationship between Gas Mark and the commonly used temperatures.

Gas Mark	Oven heat	Temperature
S, 1/4, 1/2	Very cool	105°C - 120°C 225°F - 250°F
1	Cool or slow	135°C 275°F
2	Cool or slow	150°C 300°F
3	Warm oven	160°C 325°F
4	Moderate	175°C 350°F
5	Fairly hot oven	190°C 375°F
6	Hot oven	200°C 400°F
7	Hot oven	220°C 425°F
8	Very hot oven	230°C 450°F
9	Very hot oven	240°C 460°F

## operating the minute minder

The mechanical timer is adjustable up to 120 minutes.

To obtain 120 timer setting turn the knob clockwise until the end and then turn the knob anti-clockwise to the bar mark.

1- Turn the knob clockwise until the end.

2- Turn the knob anti-clockwise to the desired time.

3- At the end of the preset time a buzzer sounds which goes off after a while.

**This timer is for timing any process and does not cut the gas off.**

18

- Turn OFF at the mains before cleaning.**
- Before switching on again ensure that all gas controls are in the OFF position.
  - **Make sure that the oven, grill and burners are sufficiently cool before you start cleaning.**
  - A residual heat will remain after you switch off the cooker so take care not to touch hot surfaces.

**Exterior**

Use a damp cloth to clean the outside. Never use any sharp instruments, abrasive household cleaner, or detergents for cleaning. For hard stains use suitable washing liquid.

**Burners**

The pan supports can be removed and the top burner plate can be cleaned with soapy water and rinsed with a dry cloth. Wash and rinse the gas burner caps and the pan supports with soapy water. Never wash them in a dishwasher. For the dirt and stains on the burner heads that does not wash off, use a proprietary metal surface cleaner.

**Hob surround**

Clean with a cloth wrung out in soapy water. Stubborn stains can be removed with a cream, paste or liquid cleaner. Check that the cleaning agent used is approved by the Vitreous Enamel Development Council.

**Control panel**

Wipe over the control panel with a damp cloth and polish with a dry cloth. Do not use oven cleaners or aerosol sprays, scouring pads or abrasive powder for cleaning the plastic knobs or end caps as damage will occur. Take extreme care when removing and re-fitting control knobs. Never operate the appliance without all control knobs fitted. The correct control knob must be fitted to the corresponding control.

**Grill and oven interiors**

Take out all trays and pans. Clean out the interior with a piece of moist, soapy cloth. Then, clean it once more with a wet piece of cloth and leave it to dry. We recommend that grill elements be wiped with a damp cloth to remove any fat splashes. This will prevent fumes from any fat being burned off when the cooker is next used.

**Never clean the inside of the grill or oven and trays with hard brushes, steel pads or knives.**

Do not use cleaning agents containing acid or chlorine on the handle. Cleaning can be performed using a soft piece of cloth and soapy water or commercially available special surface cleaners. Catalytic liners should never require cleaning if very hot temperatures are used regularly.

**Grill and oven doors**

Wipe over the door outer panel with a cloth wrung out in hot soapy water, then after wiping with a cloth wrung out in clean water, dry with a soft clean cloth. Do not use scouring pads or abrasive powder which may scratch the surface. Take care during cleaning not to damage or distort the door seal.

Ensure that the door seal is dry after cleaning. Do not lift the door seal.

**Models with removeable inner glass panels**

When you wish to clean the interior glass of the oven door, use a screwdriver to remove the top and bottom washers that secures the interior glass to the door, remove the glass with care. Clean as above, but do not use house hold detergents, bleach, scouring pads or rust removers. After drying, position the gasket back into its place, reinstall the glass panels carefully preventing sudden shocks.

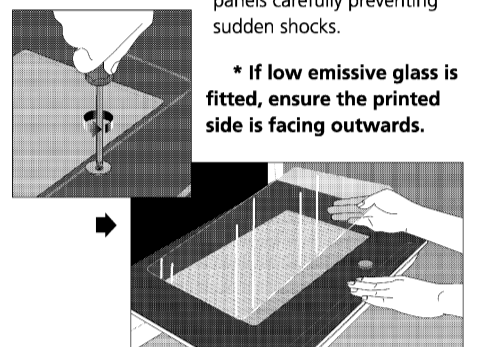

**\* If low emissive glass is fitted, ensure the printed side is facing outwards.**

**Over time...**

- Slight discolouration of liners and other surfaces may occur in time. This does not affect the functioning of the appliance.
- \* Model dependant.**

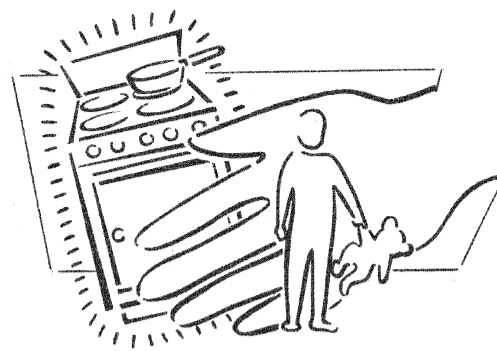

**Look after yourself, family and friends**

- **Ensure that children are kept away whilst the cooker is in use and until it has cooled as parts become very hot. Don't leave them unsupervised.**
- During use surfaces get hot. Don't touch hot surfaces during use.
- Close supervision while cooking is essential at all times.
- Never use when judgement or co-ordination is impaired by the use of alcohol and/or drugs.
- Don't use aerosol sprays near the cooker as most are highly inflammable.
- Special care should be taken when cooking oily and fatty food as overheating of such food can cause them to catch fire.
- Always use good quality oven gloves when removing hot utensils and the oven pan from the handy rack.
- Ensure handles of pans can not accidentally be caught or knocked and do not get heated by adjacent burners.
- Check all controls on the appliance are switched off after use.
- Take care when opening the door. Let steam and hot air escape before removing the food.
- Select the correct shelf position before turning the oven or grill on - don't move oven shelves when hot.
- Don't use water to extinguish oil or fat fires.
- Don't heat up unopened food containers as pressure can build up causing the container to burst.

- Don't use round-bottomed traditional woks. Use flat-bottomed types.
- Don't store items above the cooker that children may try to reach.

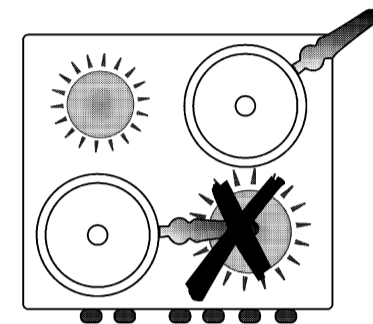

**This appliance is not intended for use by person with reduced physical, sensory or mental capabilities or lack of experience and knowledge unless they have been given supervision or instruction concerning use of the appliance by a person responsible for their safety. Children should be supervised to ensure that they do not play with the appliance.**

- Turn OFF at the mains before cleaning.**
- Before switching on again ensure that all gas controls are in the OFF position.
  - **Make sure that the oven, grill and burners are sufficiently cool before you start cleaning.**
  - A residual heat will remain after you switch off the cooker so take care not to touch hot surfaces.

**Exterior**

Use a damp cloth to clean the outside. Never use any sharp instruments, abrasive household cleaner, or detergents for cleaning. For hard stains use suitable washing liquid.

**Burners**

The pan supports can be removed and the top burner plate can be cleaned with soapy water and rinsed with a dry cloth. Wash and rinse the gas burner caps and the pan supports with soapy water. Never wash them in a dishwasher. For the dirt and stains on the burner heads that does not wash off, use a proprietary metal surface cleaner.

**Hob surround**

Clean with a cloth wrung out in soapy water. Stubborn stains can be removed with a cream, paste or liquid cleaner. Check that the cleaning agent used is approved by the Vitreous Enamel Development Council.

**Control panel**

Wipe over the control panel with a damp cloth and polish with a dry cloth. Do not use oven cleaners or aerosol sprays, scouring pads or abrasive powder for cleaning the plastic knobs or end caps as damage will occur. Take extreme care when removing and re-fitting control knobs. Never operate the appliance without all control knobs fitted. The correct control knob must be fitted to the corresponding control.

**Grill and oven interiors**

Take out all trays and pans. Clean out the interior with a piece of moist, soapy cloth. Then, clean it once more with a wet piece of cloth and leave it to dry. We recommend that grill elements be wiped with a damp cloth to remove any fat splashes. This will prevent fumes from any fat being burned off when the cooker is next used.

**Never clean the inside of the grill or oven and trays with hard brushes, steel pads or knives.**

Do not use cleaning agents containing acid or chlorine on the handle. Cleaning can be performed using a soft piece of cloth and soapy water or commercially available special surface cleaners. Catalytic liners should never require cleaning if very hot temperatures are used regularly.

**Grill and oven doors**

Wipe over the door outer panel with a cloth wrung out in hot soapy water, then after wiping with a cloth wrung out in clean water, dry with a soft clean cloth. Do not use scouring pads or abrasive powder which may scratch the surface. Take care during cleaning not to damage or distort the door seal.

Ensure that the door seal is dry after cleaning. Do not lift the door seal.

**Models with removeable inner glass panels**

When you wish to clean the interior glass of the oven door, use a screwdriver to remove the top and bottom washers that secures the interior glass to the door, remove the glass with care. Clean as above, but do not use house hold detergents, bleach, scouring pads or rust removers. After drying, position the gasket back into its place, reinstall the glass panels carefully preventing sudden shocks.

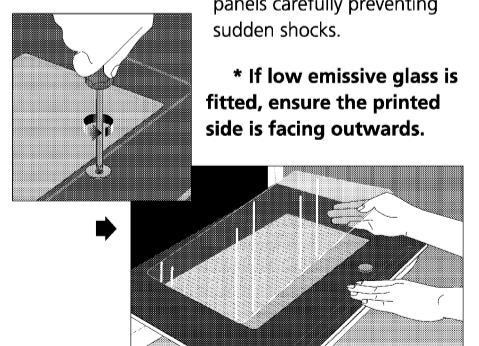

**\* If low emissive glass is fitted, ensure the printed side is facing outwards.**

**Over time...**

- Slight discolouration of liners and other surfaces may occur in time. This does not affect the functioning of the appliance.
- \* Model dependant.**

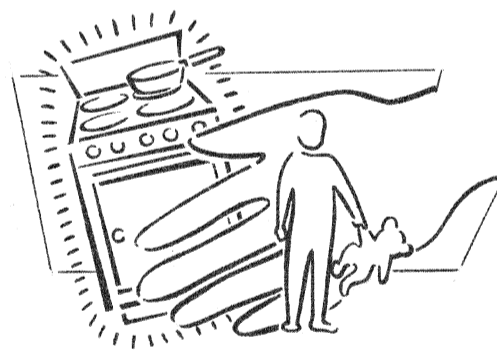

**Look after yourself, family and friends**

- **Ensure that children are kept away whilst the cooker is in use and until it has cooled as parts become very hot. Don't leave them unsupervised.**
- During use surfaces get hot. Don't touch hot surfaces during use.
- Close supervision while cooking is essential at all times.
- Never use when judgement or co-ordination is impaired by the use of alcohol and/or drugs.
- Don't use aerosol sprays near the cooker as most are highly inflammable.
- Special care should be taken when cooking oily and fatty food as overheating of such food can cause them to catch fire.
- Always use good quality oven gloves when removing hot utensils and the oven pan from the handy rack.
- Ensure handles of pans can not accidentally be caught or knocked and do not get heated by adjacent burners.
- Check all controls on the appliance are switched off after use.
- Take care when opening the door. Let steam and hot air escape before removing the food.
- Select the correct shelf position before turning the oven or grill on - don't move oven shelves when hot.
- Don't use water to extinguish oil or fat fires.
- Don't heat up unopened food containers as pressure can build up causing the container to burst.

- Don't use round-bottomed traditional woks. Use flat-bottomed types.
- Don't store items above the cooker that children may try to reach.

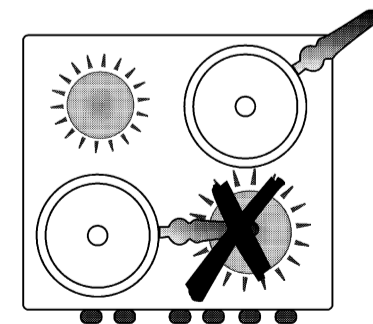

**This appliance is not intended for use by person with reduced physical, sensory or mental capabilities or lack of experience and knowledge unless they have been given supervision or instruction concerning use of the appliance by a person responsible for their safety. Children should be supervised to ensure that they do not play with the appliance.**

## location

- The cooker is designed to fit between kitchen cabinets spaced over 500 mm apart. The space either side of the cooker need only be sufficient to allow withdrawal of the cooker for servicing. It can be used with cabinets on one side or both sides as well as in a corner setting. It can also be used free-standing.
- Adjacent side walls above the appliance must not be nearer to the cooker than 150mm and should be of heat resistant material. Leave at least 550 mm clearance above the grill.
- Excess steam from the oven is expelled at the rear of the appliance therefore the wall behind the cooker needs to be protected against grease and moisture.

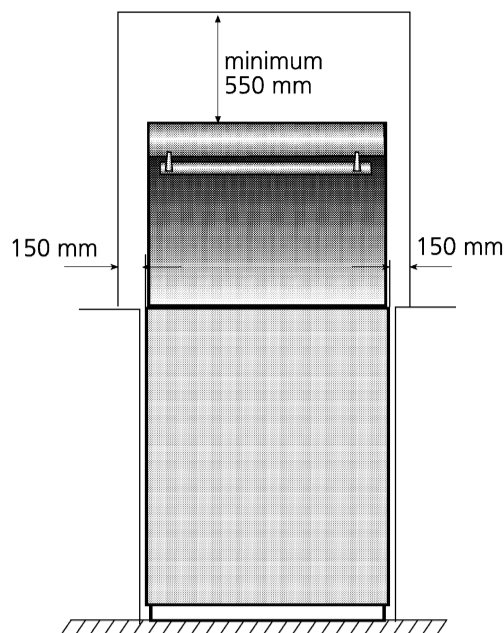

### LP Gas only

**Do not install this appliance in a room below ground level** unless it is open to ground level on at least one side.

**Failure to install appliances correctly is dangerous and could result in prosecution.**

## ventilation



**Natural ventilation is important for the correct functioning of the appliance and your own safety.**

Prolonged intensive use of the appliance may call for additional ventilation, for example the opening of a window, or the use of permanent fixed mechanical ventilation system, for example, an extractor fan or cooker hood that ventilates to the outside.

### Room considerations and built-in ventilation

The appliance must not be installed in a room without a window or other controllable opening. If it is installed in a room without a door which opens directly to the outside, a permanent opening is required. The size of the free area of a permanent opening must be as follows:

Room volume	Opening
Up to 5m <sup>3</sup>	100cm <sup>2</sup>
5m <sup>3</sup> to 10m <sup>3</sup>	50cm <sup>2</sup>
Above 10m <sup>3</sup>	None
In cellar or basement	65cm <sup>2</sup>

These requirements apply for a full cooker equivalent, however if there are other fuel burning appliances in the same room. The regulations in force for the UK and Ireland should be consulted.

7

## location

- The cooker is designed to fit between kitchen cabinets spaced over 500 mm apart. The space either side of the cooker need only be sufficient to allow withdrawal of the cooker for servicing. It can be used with cabinets on one side or both sides as well as in a corner setting. It can also be used free-standing.
- Adjacent side walls above the appliance must not be nearer to the cooker than 150mm and should be of heat resistant material. Leave at least 550 mm clearance above the grill.
- Excess steam from the oven is expelled at the rear of the appliance therefore the wall behind the cooker needs to be protected against grease and moisture.

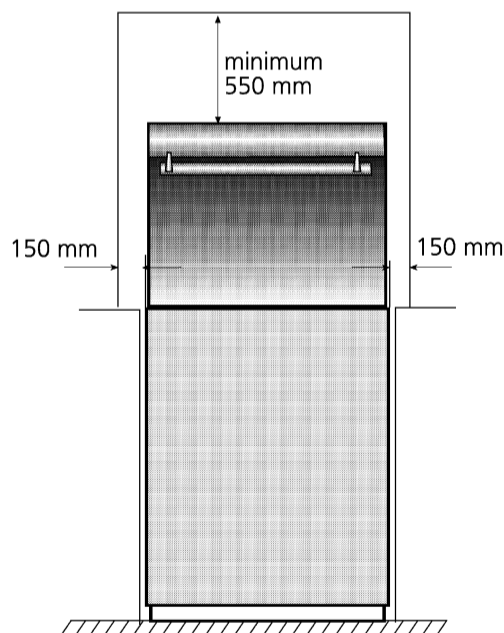

### LP Gas only

**Do not install this appliance in a room below ground level** unless it is open to ground level on at least one side.

**Failure to install appliances correctly is dangerous and could result in prosecution.**

## ventilation



**Natural ventilation is important for the correct functioning of the appliance and your own safety.**

Prolonged intensive use of the appliance may call for additional ventilation, for example the opening of a window, or the use of permanent fixed mechanical ventilation system, for example, an extractor fan or cooker hood that ventilates to the outside.

### Room considerations and built-in ventilation

The appliance must not be installed in a room without a window or other controllable opening. If it is installed in a room without a door which opens directly to the outside, a permanent opening is required. The size of the free area of a permanent opening must be as follows:

Room volume	Opening
Up to 5m <sup>3</sup>	100cm <sup>2</sup>
5m <sup>3</sup> to 10m <sup>3</sup>	50cm <sup>2</sup>
Above 10m <sup>3</sup>	None
In cellar or basement	65cm <sup>2</sup>

These requirements apply for a full cooker equivalent, however if there are other fuel burning appliances in the same room. The regulations in force for the UK and Ireland should be consulted.

7

## operating the grill

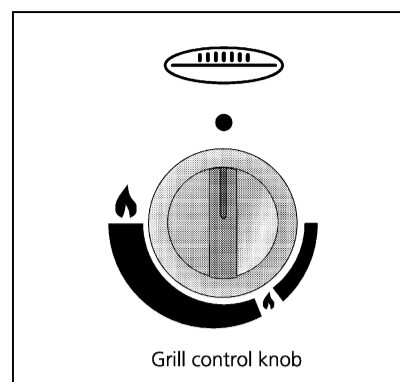

**Parts may become hot when the grill is in use, children must be kept away.**  
**The maximum load must not exceed 2.5 kg (5.5 lbs).**

### Using the grill

- 1 Position the rack in a suitable position.
- 2 Press and turn the control knob anticlockwise to the large flame symbol.
- 3 Push the ignition button to light the burner.
- 4 Allow the grill to preheat for 2 minutes.
- 5 The grill can be operated at the variable setting.
- 6 To switch off turn the knob clockwise to the ● off position.

### Use of grill pan



**Warning! Always use an oven glove to protect your hand when using the grill as all metal parts can become very hot.**

**Always take care not to touch hot surfaces when using the grill pan.**

### Grilling guidelines

For thicker foods requiring longer cooking, turn the control to a lower setting after the initial sealing on both sides. The thicker the food, the lower the control should be set. When grilling thicker food, the grill rack should be turned over to its lowest position.

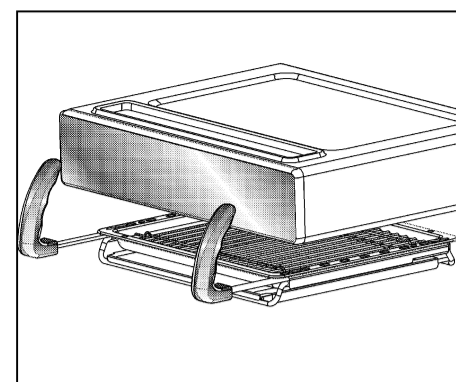

- If the burner doesn't light the first time, press the ignition button once or twice again. If it still doesn't light, turn off and wait for 1 minute to allow gas to disperse before trying again.
- Do not hold the control in for more than 15 seconds.
- Ensure the food is correctly positioned on the grill pan under the grill burner.
- Oiling the grill rack prevents meat sticking on the wires.
- Do not line the grill pan with aluminium foil. This will result in an increase in temperatures and could result in damage to your cooker or increased risk of fire.
- Always remove the grill pan from the compartment as soon as you have finished grilling, it makes the pan much easier to clean. When grilling, if meat is placed too near the grill burner, the fat may ignite.

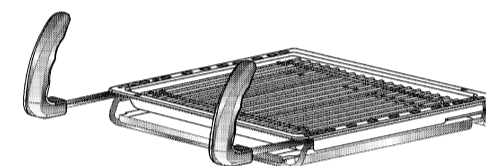

16

## operating the grill

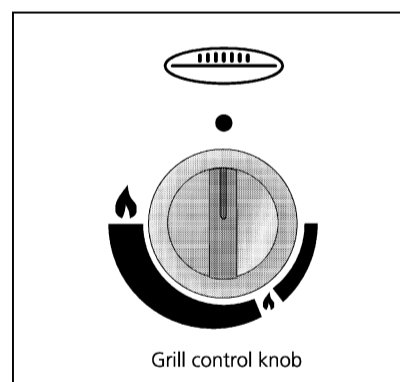

**Parts may become hot when the grill is in use, children must be kept away.**  
**The maximum load must not exceed 2.5 kg (5.5 lbs).**

### Using the grill

- 1 Position the rack in a suitable position.
- 2 Press and turn the control knob anticlockwise to the large flame symbol.
- 3 Push the ignition button to light the burner.
- 4 Allow the grill to preheat for 2 minutes.
- 5 The grill can be operated at the variable setting.
- 6 To switch off turn the knob clockwise to the ● off position.

### Use of grill pan



**Warning! Always use an oven glove to protect your hand when using the grill as all metal parts can become very hot.**

**Always take care not to touch hot surfaces when using the grill pan.**

### Grilling guidelines

For thicker foods requiring longer cooking, turn the control to a lower setting after the initial sealing on both sides. The thicker the food, the lower the control should be set. When grilling thicker food, the grill rack should be turned over to its lowest position.

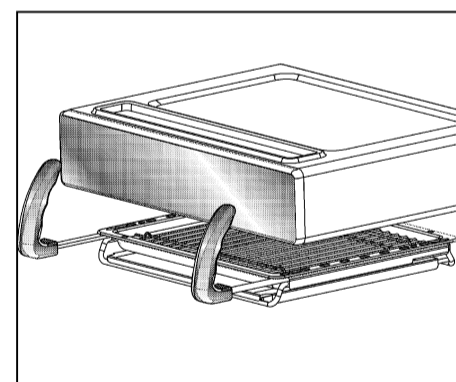

- If the burner doesn't light the first time, press the ignition button once or twice again. If it still doesn't light, turn off and wait for 1 minute to allow gas to disperse before trying again.
- Do not hold the control in for more than 15 seconds.
- Ensure the food is correctly positioned on the grill pan under the grill burner.
- Oiling the grill rack prevents meat sticking on the wires.
- Do not line the grill pan with aluminium foil. This will result in an increase in temperatures and could result in damage to your cooker or increased risk of fire.
- Always remove the grill pan from the compartment as soon as you have finished grilling, it makes the pan much easier to clean. When grilling, if meat is placed too near the grill burner, the fat may ignite.

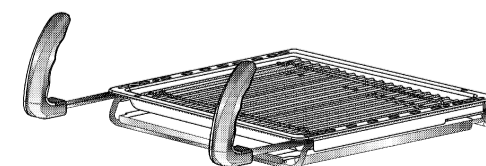

16

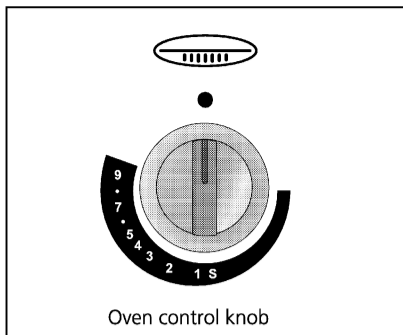

Oven control knob

**Parts may become hot when the oven is in use, children must be kept away.**

There is a safety device that prevents the build-up of gas inside the cavity if the burner doesn't light or goes out for any reason.

- 1 Open the door.
- 2 Adjust the shelves to the positions required.
- 3 Press and turn the control anti-clockwise to gas mark 8.
- 4 While keeping it depressed, press the ignition button to light the burner.
- 5 Keep the control depressed for 15 seconds after the burner has lit to over-ride the safety device.
- 6 Close the door.
- 7 Allow 10 minutes for pre-heating.
- 8 Set the knob as required or as recommended in the chart.
- 9 To switch off turn the knob clockwise to the ● off position.

- If the burner doesn't light the first time, press the ignition button once or twice again. If it still doesn't light, turn off and wait for 1 minute to allow gas to disperse before trying again.
- Do not hold the control in for more than 15 seconds.
- Ensure you stand back from the appliance when opening the oven door to allow any build up of steam or heat to escape.
- Open the door carefully to prevent spillage of hot liquids from the handyrack
- Check food is thoroughly cooked and is piping hot.
- Do not heat an unopened glass or metal container in the oven.
- Do not allow spillovers to accumulate as these may present a fire hazard.
- The oven has several openings and vents designed in. They must not be blocked or covered.
- Do not use aluminium foil on the oven bottom.

**\*Light button**

Switches the oven light on or off.

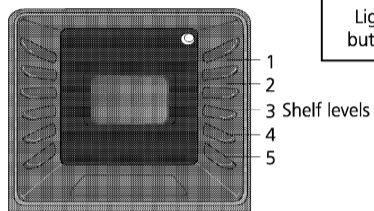

\*Dependant on model

**Oven temperature chart**

This chart is for guidance only, follow food manufacturers recommendations whenever available.

Food	Gas mark	Cooking time	Shelf position	Preheat	Gas mark
Beef	4 - 5	25-30 mins per 450g + 30 mins	4	10 mins	7
Lamb	4 - 5	25-30 mins per 450g + 30 mins	4	10 mins	7
Pork	4 - 5	30-35 mins per 450g + 30 mins	4	10 mins	7
Poultry	4 - 5	25-30 mins per 450g + 25 mins	3- 4	10 mins	7
Casseroles	2 - 3	1.5-2 hours, dependant on quantity	3- 4	No	
Fruit cake	2 - 3	Dependent on size	2-3	10 mins	7
Small cakes	4 - 5	20-25 minutes	2-3	10 mins	7
Victoria sandwich	4 - 5	22-28 minutes	4	10 mins	7

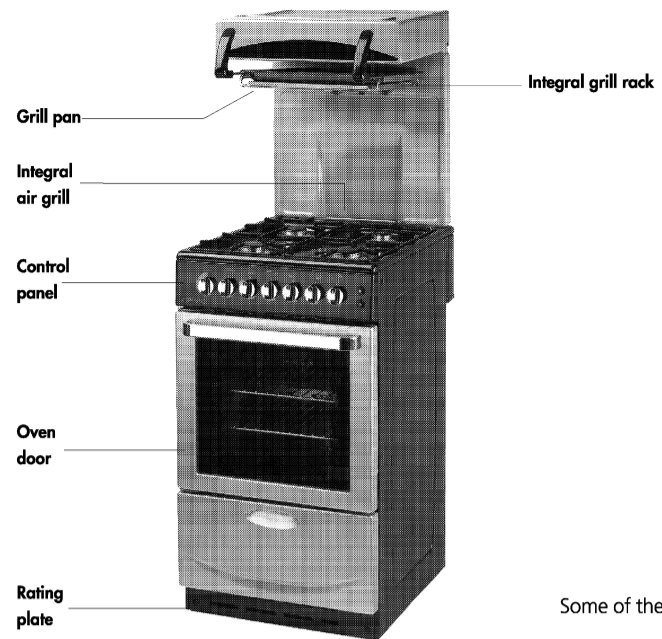

Some of the illustrated details may vary

## specification

External dimensions width x depth x height	500mm x 600mm x 1460mm
Front-right rapid burner capacity	Nominal rate 2.9 kW
Rear-left semi-rapid burner capacity	Nominal rate 2.0 kW
Rear-right burner capacity	Nominal rate 1.0 kW
Front-left semi-rapid burner capacity	Nominal rate 2.0 kW
Supply voltage	230V~ 50Hz
Main oven burner	Nominal rate 2.5 kW
Grill burner	2.5 kW

Lamp*	25W
Total power (gas)	12.9 kW
Ignition	Auto electric on all burners
Safety device	Gas valves are lockable

Gas	Supply Pressure	Destination Countries
G20	20 mbar	GB, IE
G31	37 mbar	GB, IE

I2H AT 20 mbar and I3P AT 37 mbar  
Cat II 2H3P

For Cooker set up condition please refer to rating label

Because we continually strive to improve our products, we may change our specifications and designs without prior notice.

\*Dependant on model.

**Accuracy**

Note that times and temperatures in this book are for guidance only.

Burner Injector	Natural gas mark	LPG mark
2,9 kW	115	87
2,0 kW	103	72
1,0 kW	72	50
Oven 2.5 kW	110	76
Grill 2.5 kW	119	81

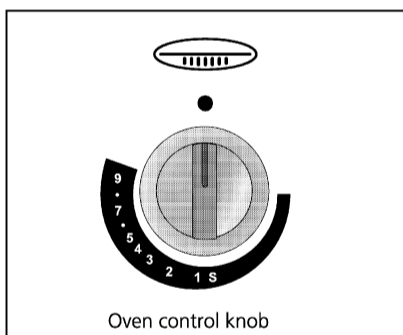

Oven control knob

**Parts may become hot when the oven is in use, children must be kept away.**

There is a safety device that prevents the build-up of gas inside the cavity if the burner doesn't light or goes out for any reason.

- 1 Open the door.
- 2 Adjust the shelves to the positions required.
- 3 Press and turn the control anti-clockwise to gas mark 8.
- 4 While keeping it depressed, press the ignition button to light the burner.
- 5 Keep the control depressed for 15 seconds after the burner has lit to over-ride the safety device.
- 6 Close the door.
- 7 Allow 10 minutes for pre-heating.
- 8 Set the knob as required or as recommended in the chart.
- 9 To switch off turn the knob clockwise to the ● off position.

- If the burner doesn't light the first time, press the ignition button once or twice again. If it still doesn't light, turn off and wait for 1 minute to allow gas to disperse before trying again.
- Do not hold the control in for more than 15 seconds.
- Ensure you stand back from the appliance when opening the oven door to allow any build up of steam or heat to escape.
- Open the door carefully to prevent spillage of hot liquids from the handyrack
- Check food is thoroughly cooked and is piping hot.
- Do not heat an unopened glass or metal container in the oven.
- Do not allow spillovers to accumulate as these may present a fire hazard.
- The oven has several openings and vents designed in. They must not be blocked or covered.
- Do not use aluminium foil on the oven bottom.

**\*Light button**

Switches the oven light on or off.

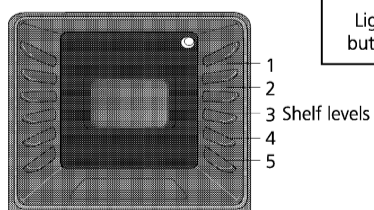

\*Dependant on model

**Oven temperature chart**

This chart is for guidance only, follow food manufacturers recommendations whenever available.

Food	Gas mark	Cooking time	Shelf position	Preheat	Gas mark
Beef	4 - 5	25-30 mins per 450g + 30 mins	4	10 mins	7
Lamb	4 - 5	25-30 mins per 450g + 30 mins	4	10 mins	7
Pork	4 - 5	30-35 mins per 450g + 30 mins	4	10 mins	7
Poultry	4 - 5	25-30 mins per 450g + 25 mins	3- 4	10 mins	7
Casseroles	2 - 3	1.5-2 hours, dependant on quantity	3- 4	No	
Fruit cake	2 - 3	Dependent on size	2-3	10 mins	7
Small cakes	4 - 5	20-25 minutes	2-3	10 mins	7
Victoria sandwich	4 - 5	22-28 minutes	4	10 mins	7

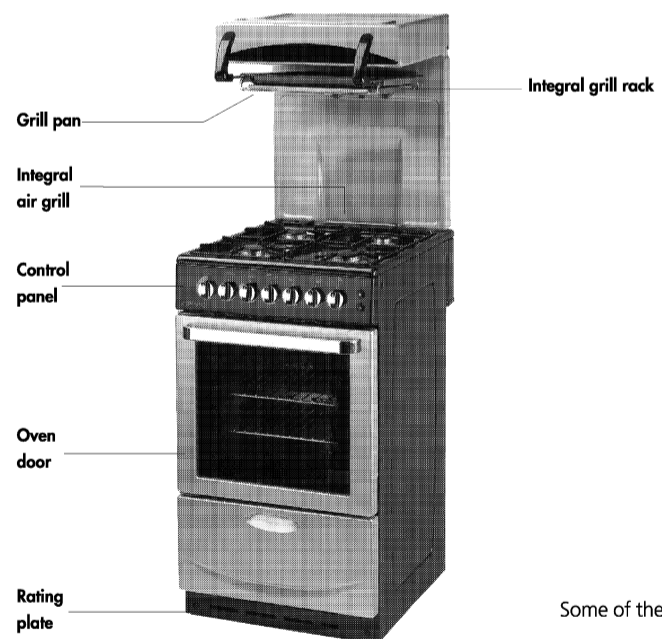

Some of the illustrated details may vary

## specification

External dimensions width x depth x height	500mm x 600mm x 1460mm
Front-right rapid burner capacity	Nominal rate 2.9 kW
Rear-left semi-rapid burner capacity	Nominal rate 2.0 kW
Rear-right burner capacity	Nominal rate 1.0 kW
Front-left semi-rapid burner capacity	Nominal rate 2.0 kW
Supply voltage	230V~ 50Hz
Main oven burner	Nominal rate 2.5 kW
Grill burner	2.5 kW

Lamp*	25W
Total power (gas)	12.9 kW
Ignition	Auto electric on all burners
Safety device	Gas valves are lockable

Gas	Supply Pressure	Destination Countries
G20	20 mbar	GB, IE
G31	37 mbar	GB, IE

I2H AT 20 mbar and I3P AT 37 mbar  
Cat II 2H3P

For Cooker set up condition please refer to rating label

Because we continually strive to improve our products, we may change our specifications and designs without prior notice.

\*Dependant on model.

**Accuracy**

Note that times and temperatures in this book are for guidance only.

Burner Injector	Natural gas mark	LPG mark
2,9 kW	115	87
2,0 kW	103	72
1,0 kW	72	50
Oven 2.5 kW	110	76
Grill 2.5 kW	119	81



## Fitting the grill and splash back

- Carefully lower the grill and splash back support arms into the slots and support brackets 'A' at the rear of the cooker.
- Secure in position with the two screw 'B'.

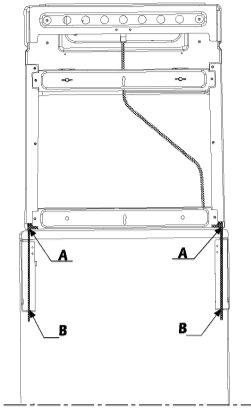

- Assemble the grill rack shelf on to the splash back using the wing nuts provided (the grill rack shelf is packed with the accessories in the oven compartment).
- Place the silver metal tray on the grill rack shelf with the flange facing downwards.
- Connect the grill feed pipe 'C'.
- Thread the ignition cable 'D' and the FFD tube 'E' through the back supports and hole in the rear left hand corner of the grill hood assembly. Connect the cable to the spark plug assembly which is positioned on the top right hand rear corner of the grill burner. Secure the sensor in the bracket as shown.

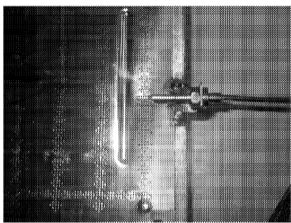

- Please note that** the positioning and vertical distance between the sensor and the grill burner surface are critical for a sound operation. Therefore maximum attention should be paid to adjust the indicated gap to 5-6 mm after mounting the sensor.

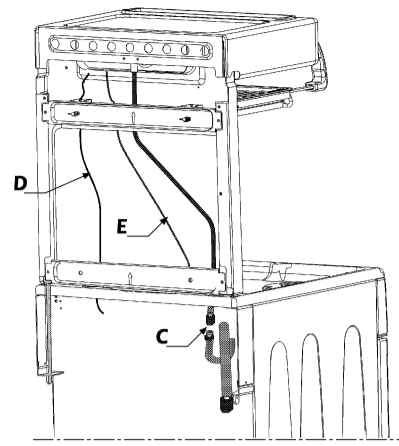
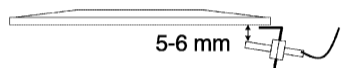

## Safety checks.

1. Check that the grill gas connection is gas sound when you have completed connecting the cooker to the gas supply.

A safety device fitted to the grill prevents a build up of gas if the burner doesn't light or goes out for any reason.

2. Press and turn the grill control to the large flame symbol.

3. While keeping the control depressed press the ignition button to light the burner.

4. Keep the knob depressed for 15 seconds after the burner has lit to override the safety device.

5. After 2 minutes at maximum setting, reduce to the small flame symbol and operate for 3 minutes. Check to ensure to flame is maintained during reduced rate operation.

6. Switch off the grill by turning the knob to the O position.

7. When the flame has extinguished, press and turn the grill control to the large flame symbol and release the knob. Do not press the ignition button.

8. The safety device will cut off the gas to the grill within 60 seconds.

\* If the flame goes out during the reduced rate operation, check the FFD position has not been disturbed during installation, also the reduced rate flame condition.

\* If auto cut off is not actuated as stated please check that the FFD pipe has not been damaged during installation.

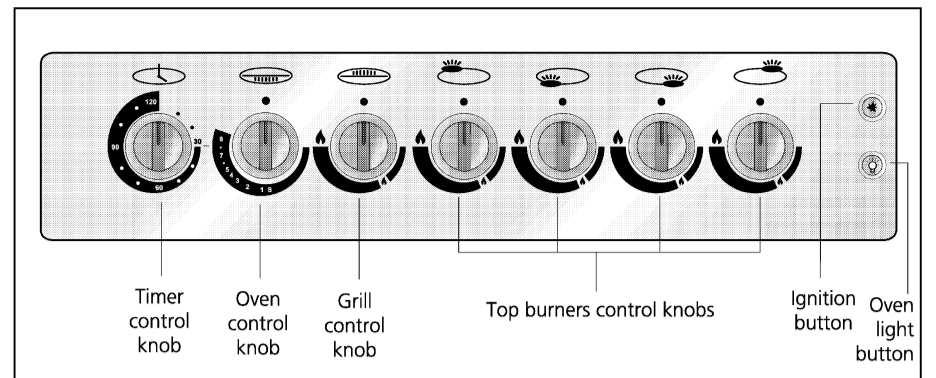

## Turning on and off

All burners are protected by flame failure devices, if the flames are extinguished for any reason the gas will automatically be cut off.

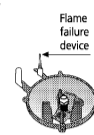

The burner control knobs have a safety feature.

1. Push the appropriate knob in slightly and turn anti-clockwise to the required setting.

2. While keeping the knob depressed press the ignition button.



3. Keep the knob depressed for 15 seconds after the burner has lit to override the safety device.

4. To switch a burner off turn the corresponding knob to ●.

• Turning the control knob fully anti-clockwise to the small flame symbol enables you to simmer without accidentally switching off.

## Ignition button

• Pressing this button provides a spark at all burners, only the one turned on will light.

• If a hob burner doesn't light, press again until it does.

## Flame control

• When turning on a hotplate burner, stay and make sure that it has lit, and adjust the flame immediately.

• **Selection of the correct flame height is especially important to safety.** Adjust the burner flame so that it does not extend beyond the bottom of the pan, any higher and the flame becomes inefficient and can be a potential fire hazard.

• To make sure that the cooker is operating safely, periodic checks are advised.

• At low settings, do not leave the burners unattended for long periods of time.

• The burner flames should burn with a visible bluish cone within the main flame, and with no sign of yellowness. If at the first lighting they are very noisy and yellow, turn out at once and check that the burner cap has been correctly replaced. If on re-lighting there is no improvement, ask your supplier to check them. The inner portions of the flames as described above may not be very clear, but this is not detrimental in anyway.

The pan supports are not interchangeable.

## \*Oven light

• Pressing this button will turn the light on.

• Press again to turn the light off.

\* Dependant on model.

## Fitting the grill and splash back

- Carefully lower the grill and splash back support arms into the slots and support brackets 'A' at the rear of the cooker.
- Secure in position with the two screw 'B'.

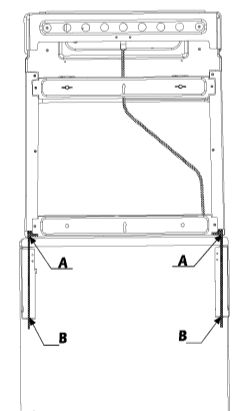

- Assemble the grill rack shelf on to the splash back using the wing nuts provided (the grill rack shelf is packed with the accessories in the oven compartment).
- Place the silver metal tray on the grill rack shelf with the flange facing downwards.
- Connect the grill feed pipe 'C'.
- Thread the ignition cable 'D' and the FFD tube 'E' through the back supports and hole in the rear left hand corner of the grill hood assembly. Connect the cable to the spark plug assembly which is positioned on the top right hand rear corner of the grill burner. Secure the sensor in the bracket as shown.

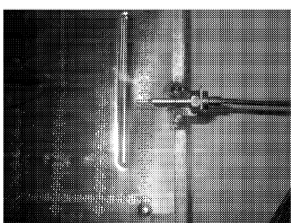

- Please note that** the positioning and vertical distance between the sensor and the grill burner surface are critical for a sound operation. Therefore maximum attention should be paid to adjust the indicated gap to 5-6 mm after mounting the sensor.

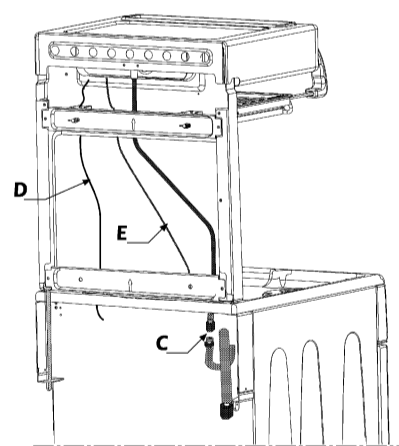
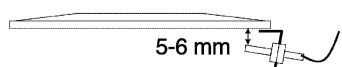

## Safety checks.

1. Check that the grill gas connection is gas sound when you have completed connecting the cooker to the gas supply.

A safety device fitted to the grill prevents a build up of gas if the burner doesn't light or goes out for any reason.

2. Press and turn the grill control to the large flame symbol.

3. While keeping the control depressed press the ignition button to light the burner.

4. Keep the knob depressed for 15 seconds after the burner has lit to override the safety device.

5. After 2 minutes at maximum setting, reduce to the small flame symbol and operate for 3 minutes. Check to ensure to flame is maintained during reduced rate operation.

6. Switch off the grill by turning the knob to the O position.

7. When the flame has extinguished, press and turn the grill control to the large flame symbol and release the knob. Do not press the ignition button.

8. The safety device will cut off the gas to the grill within 60 seconds.

\* If the flame goes out during the reduced rate operation, check the FFD position has not been disturbed during installation, also the reduced rate flame condition.

\* If auto cut off is not actuated as stated please check that the FFD pipe has not been damaged during installation.

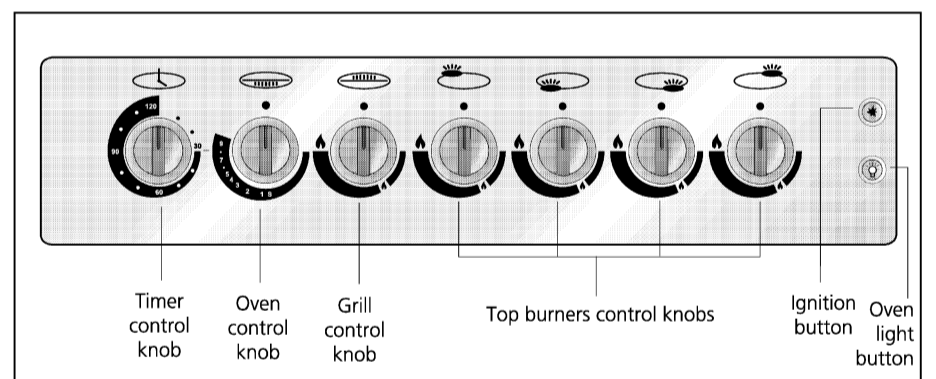

## Turning on and off

All burners are protected by flame failure devices, if the flames are extinguished for any reason the gas will automatically be cut off.

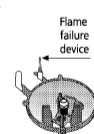

The burner control knobs have a safety feature.

1. Push the appropriate knob in slightly and turn anti-clockwise to the required setting.

2. While keeping the knob depressed press the ignition button.



3. Keep the knob depressed for 15 seconds after the burner has lit to override the safety device.

4. To switch a burner off turn the corresponding knob to ●.

• Turning the control knob fully anti-clockwise to the small flame symbol enables you to simmer without accidentally switching off.

## Ignition button

• Pressing this button provides a spark at all burners, only the one turned on will light.

• If a hob burner doesn't light, press again until it does.

## Flame control

• When turning on a hotplate burner, stay and make sure that it has lit, and adjust the flame immediately.

• **Selection of the correct flame height is especially important to safety.** Adjust the burner flame so that it does not extend beyond the bottom of the pan, any higher and the flame becomes inefficient and can be a potential fire hazard.

• To make sure that the cooker is operating safely, periodic checks are advised.

• At low settings, do not leave the burners unattended for long periods of time.

• The burner flames should burn with a visible bluish cone within the main flame, and with no sign of yellowness. If at the first lighting they are very noisy and yellow, turn out at once and check that the burner cap has been correctly replaced. If on re-lighting there is no improvement, ask your supplier to check them. The inner portions of the flames as described above may not be very clear, but this is not detrimental in anyway.

The pan supports are not interchangeable.

## \*Oven light

• Pressing this button will turn the light on.

• Press again to turn the light off.

\* Dependant on model.

**Pan choice**

In choosing pans, look for pan handles that can be held easily and will stay cool. Avoid pans that are unstable and easily tipped. Pans that are too heavy to move easily when filled can also be a hazard. Only use flat bottomed pots or pans.

**Pan size**

- For maximum efficiency and safety, use the recommended pan sizes for each burner.
- Use pans which have sufficient capacity for the amount of food being cooked so they don't boil over and cause unnecessary cleaning.
- Do not place lids on the burners.

Always position pans centrally over the burners. When transferring pans from one burner to another always lift the pans do not slide them.

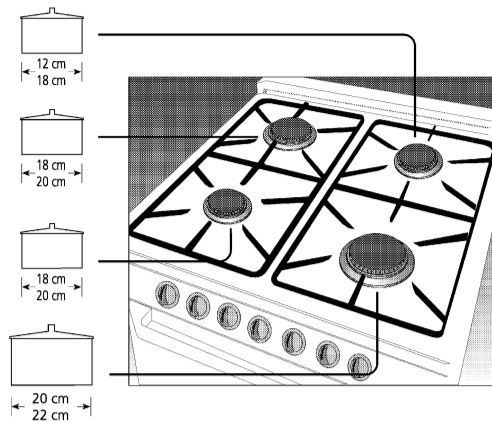

deep fat frying



- Never fill the pan more than the one-third full of fat or oil.
- Never leave unattended during heating or cooking.
- Do not fry too much food at the same time especially frozen food. This only lowers the temperature of the oil or fat too much resulting in greasy food.
- Always dry food thoroughly before frying and lower it slowly into the hot oil or fat. Frozen foods in particular will cause frothing and spitting if added too quickly.
- Never heat fat or fry with a lid on the pan.
- Keep the outside of the pan clean and free from streaks of oil or fat.

**In the event of a chip pan or other pan fire**

- 1 Turn off the cooker.
- 2 Smother flames with a fire blanket or damp cloth.
- 3 Do not try to remove a burning pan from the hob.

Burns and injuries are caused almost invariably by picking up the burning pan and rushing outside with it.



**Do not use water on the fire. Leave the pan to cool for at least 30 minutes.**

**Pan choice**

In choosing pans, look for pan handles that can be held easily and will stay cool. Avoid pans that are unstable and easily tipped. Pans that are too heavy to move easily when filled can also be a hazard. Only use flat bottomed pots or pans.

**Pan size**

- For maximum efficiency and safety, use the recommended pan sizes for each burner.
- Use pans which have sufficient capacity for the amount of food being cooked so they don't boil over and cause unnecessary cleaning.
- Do not place lids on the burners.

Always position pans centrally over the burners. When transferring pans from one burner to another always lift the pans do not slide them.

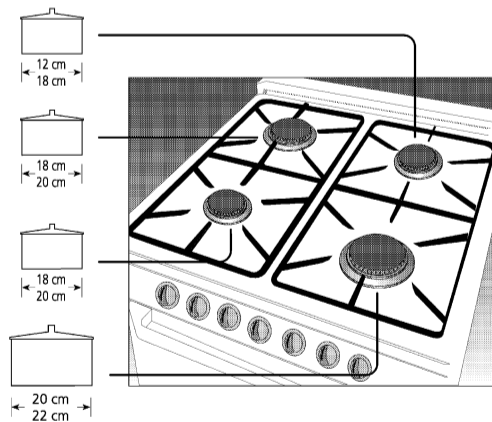

deep fat frying



- Never fill the pan more than the one-third full of fat or oil.
- Never leave unattended during heating or cooking.
- Do not fry too much food at the same time especially frozen food. This only lowers the temperature of the oil or fat too much resulting in greasy food.
- Always dry food thoroughly before frying and lower it slowly into the hot oil or fat. Frozen foods in particular will cause frothing and spitting if added too quickly.
- Never heat fat or fry with a lid on the pan.
- Keep the outside of the pan clean and free from streaks of oil or fat.

**In the event of a chip pan or other pan fire**

- 1 Turn off the cooker.
- 2 Smother flames with a fire blanket or damp cloth.
- 3 Do not try to remove a burning pan from the hob.

Burns and injuries are caused almost invariably by picking up the burning pan and rushing outside with it.



**Do not use water on the fire. Leave the pan to cool for at least 30 minutes.**

**Unpacking**

All packing materials, protective film and transit protectors must be removed.

**Installers**



**The appliance must only be installed by a competent person.**

In the UK, CORGI registered installers (including the Regions of British Gas) undertake to work to safe and satisfactory standards.

**Regulations**

The cooker must be installed in accordance with the Gas Safety (Installation and Use) Regulations and the relevant Building Regulations in force.

**Ireland only**

This appliance must be installed in accordance with the Domestic installation of gas (Irish Standard) in force

Failure to install the appliance correctly could invalidate the warranty and lead to liability claims and prosecution.

**Levelling**

The appliance should be located on a level surface. The two front and rear feet can be adjusted as required. To ensure that your appliance is standing level adjust the two front or rear feet by turning clockwise or anticlockwise until the product is in firm contact with the floor.

**Stability Chain**

The cooker must be secured by the security chain to the wall or partition behind the cooker.

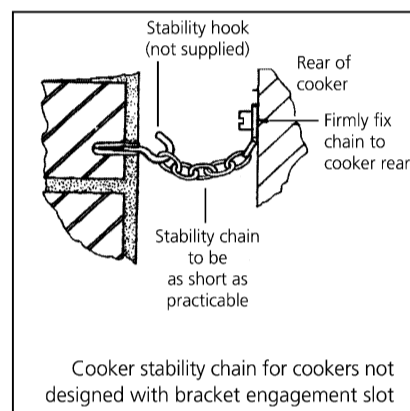

**Moving your cooker**

If your cooker is fitted with a flexible hose the cooker can be moved for cleaning. Make sure that the floor covering is firmly fixed or removed to prevent it being disturbed.

**TAKE CARE NOT TO STRAIN OR DAMAGE THE GAS HOSE (OR ELECTRICITY SUPPLY CABLE) WHEN MOVING THE COOKER.**

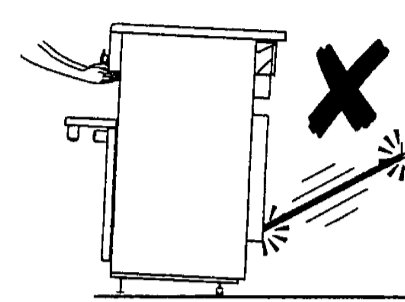

Release the stability chain as you ease the cooker out. Don't forget to refit it when you replace the cooker.

Lift the front feet clear off the floor by lifting at the ends of the hotplate fascia. Do not move by pulling the door handle or knobs.

Move the cooker a bit at a time, checking behind it to make sure that the gas hose has sufficient slack to allow the cooker to move forward as you go along.

When you replace the cooker, again check behind to make sure that the gas hose or cable are not caught or trapped. Take care not to twist it within the gap between the kitchen units as damage may occur to the cooker or the units.

Check that the cooker stability chain has been reconnected.

**Unpacking**

All packing materials, protective film and transit protectors must be removed.

**Installers**



**The appliance must only be installed by a competent person.**

In the UK, CORGI registered installers (including the Regions of British Gas) undertake to work to safe and satisfactory standards.

**Regulations**

The cooker must be installed in accordance with the Gas Safety (Installation and Use) Regulations and the relevant Building Regulations in force.

**Ireland only**

This appliance must be installed in accordance with the Domestic installation of gas (Irish Standard) in force

Failure to install the appliance correctly could invalidate the warranty and lead to liability claims and prosecution.

**Levelling**

The appliance should be located on a level surface. The two front and rear feet can be adjusted as required. To ensure that your appliance is standing level adjust the two front or rear feet by turning clockwise or anticlockwise until the product is in firm contact with the floor.

**Stability Chain**

The cooker must be secured by the security chain to the wall or partition behind the cooker.

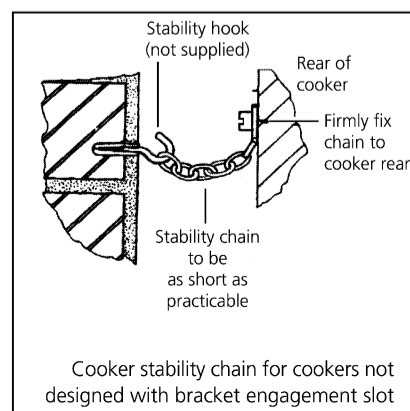

**Moving your cooker**

If your cooker is fitted with a flexible hose the cooker can be moved for cleaning. Make sure that the floor covering is firmly fixed or removed to prevent it being disturbed.

**TAKE CARE NOT TO STRAIN OR DAMAGE THE GAS HOSE (OR ELECTRICITY SUPPLY CABLE) WHEN MOVING THE COOKER.**

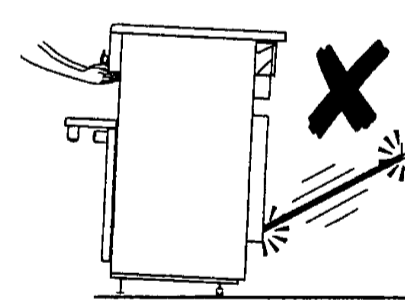

Release the stability chain as you ease the cooker out. Don't forget to refit it when you replace the cooker.

Lift the front feet clear off the floor by lifting at the ends of the hotplate fascia. Do not move by pulling the door handle or knobs.

Move the cooker a bit at a time, checking behind it to make sure that the gas hose has sufficient slack to allow the cooker to move forward as you go along.

When you replace the cooker, again check behind to make sure that the gas hose or cable are not caught or trapped. Take care not to twist it within the gap between the kitchen units as damage may occur to the cooker or the units.

Check that the cooker stability chain has been reconnected.

## Gas supply

Your oven must only be used on natural gas or LP gas.

## Natural Gas

The cooker is designed for UK and Ireland installation using a flexible connection with tubing in accordance with the regulations in force. Length of 900mm is recommended (Ireland 600 mm).

## LP Gas

For flexible connections use a bayonet type hose, suitable for use on LP Gas up to 50 mbar pressure rise. The flexible hose should be coloured black with a red stripe, band or label.

## Gas flexible hose

If a flexible hose is used it must not come into contact with the top 150mm/6 inches (the shaded area on the diagram) of the rear of the appliance.

Do not pass the hose through the hot region behind the oven.

## Connection

Connect the flexible gas hose to the oven as follows.

- 1 Use nonsetting gas sealant on the connection to the cooker.
- 2 Connect to the gas supply pipe at the rear of the cooker (1/2 in BSP).
- 3 Assemble burner caps and rings fit pan supports in position. (left and right sides)
- 4 Turn on the gas supply and check for soundness.
- 5 Light two burners and check that the pressure is correct.



## Gas leaks

If you smell gas, turn off all gas controls and extinguish any open flame. Open a window to ventilate the room. Don't touch any electrical switches. Contact your local Gas Supplier immediately.

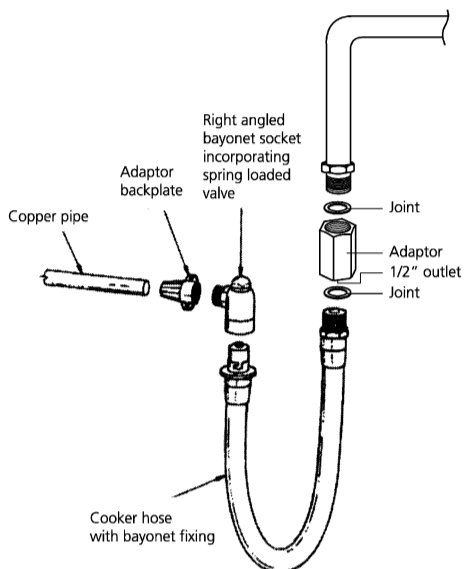
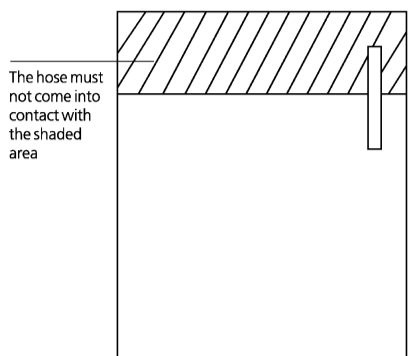

Ensure that the local distribution and adjustment conditions are compatible.

Check the rating plate to identify cooker preset condition.

**Conversion from natural gas to LPG**  
The conversion must only be implemented by a qualified engineer.

1. Replace the natural gas orifices by the LPG equivalents.
2. Check gas soundness.
3. Take out the top lid, remove the burners' plate and remove the control panel as explained on the previous page.
4. Ignite the burner that should be adjusted, turn the knob to the reduced position, pull and take the knob off.
5. Adjust the reduced rates of the burners.

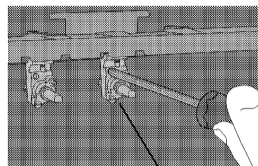

### A. Hob burners

- \* Adjust screw "A" 1-1 1/2 turns clockwise to obtain flame length of about 5 mm.
- \* Adjust each burner separately.

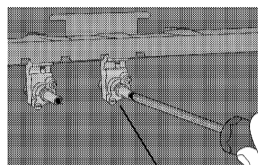

### A. Hob burners

- \* Adjust screw "A" 1-1 1/2 turns clockwise to obtain flame length of about 5 mm.
- \* Adjust each burner separately.

### B. Oven burner

- \* Adjust screw "B" 1/2 turn clockwise.
- \* Set oven thermostat to "1".
- \* Ignite oven burner.
- \* Close oven door and wait for thermostat to operate 10-15 minutes (reduced rate).
- \* Adjust screw "B" to obtain a flame length of 2-3 mm (rotation of screw "B" clockwise will decrease, anti-clockwise will increase the flame length).

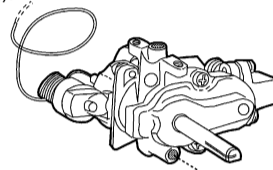

B: Oven thermostat

## 6. Apply the following labels;

- \* Overstick current rating plate with modified cut out label ensuring serial number is still visible.
- \* Tick appropriate LPG gas box and fix adjacent to the rating plate label.

**Conversion from LPG gas to NG**  
The conversion must only be implemented by a qualified engineer.

1. Replace the gas orifices by the NG equivalents.
2. Check gas soundness.
3. Take out the top lid, remove the burners' plate and remove the control panel as explained on the previous page.
4. Ignite the burner that should be adjusted, turn the knob to the reduced position, pull and take the knob off.
5. Adjust the reduced rates of the burners.

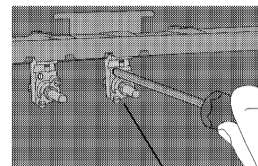

### A. Hob burners

- \* Adjust screw "A" 1-1 1/2 turns anti clockwise to obtain flame length of about 5 mm.
- \* Adjust each burner separately.

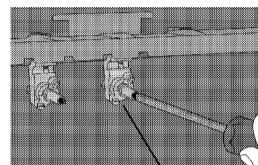

### A. Hob burners

- \* Adjust screw "A" 1-1 1/2 turns anti clockwise to obtain flame length of about 5 mm.
- \* Adjust each burner separately.

### B. Oven burner

- \* Adjust screw "B" 1/2 turn anticlockwise.
- \* Set oven thermostat to "1".
- \* Ignite oven burner.
- \* Close oven door and wait for thermostat to operate 10-15 minutes (reduced rate).
- \* Adjust screw "B" to obtain a flame length of 2-3 mm (rotation of screw "B" clockwise will decrease, anti-clockwise will increase the flame length).

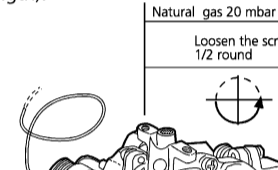

B: Oven thermostat

## 6. Apply the following labels;

- \* Overstick current rating plate with modified cut out label ensuring serial number is still visible.
- \* Tick appropriate NG gas box and fix adjacent to the rating plate label.

## Gas supply

Your oven must only be used on natural gas or LP gas.

## Natural Gas

The cooker is designed for UK and Ireland installation using a flexible connection with tubing in accordance with the regulations in force. Length of 900mm is recommended (Ireland 600 mm).

## LP Gas

For flexible connections use a bayonet type hose, suitable for use on LP Gas up to 50 mbar pressure rise. The flexible hose should be coloured black with a red stripe, band or label.

## Gas flexible hose

If a flexible hose is used it must not come into contact with the top 150mm/6 inches (the shaded area on the diagram) of the rear of the appliance.

Do not pass the hose through the hot region behind the oven.

## Connection

Connect the flexible gas hose to the oven as follows.

- 1 Use nonsetting gas sealant on the connection to the cooker.
- 2 Connect to the gas supply pipe at the rear of the cooker (1/2 in BSP).
- 3 Assemble burner caps and rings fit pan supports in position. (left and right sides)
- 4 Turn on the gas supply and check for soundness.
- 5 Light two burners and check that the pressure is correct.



## Gas leaks

If you smell gas, turn off all gas controls and extinguish any open flame. Open a window to ventilate the room. Don't touch any electrical switches. Contact your local Gas Supplier immediately.

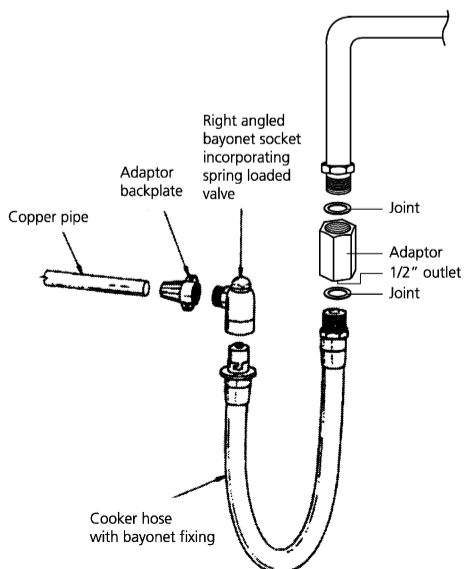
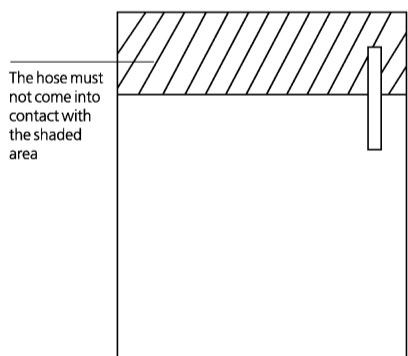

Ensure that the local distribution and adjustment conditions are compatible.

Check the rating plate to identify cooker preset condition.

**Conversion from natural gas to LPG**  
The conversion must only be implemented by a qualified engineer.

1. Replace the natural gas orifices by the LPG equivalents.
2. Check gas soundness.
3. Take out the top lid, remove the burners' plate and remove the control panel as explained on the previous page.
4. Ignite the burner that should be adjusted, turn the knob to the reduced position, pull and take the knob off.
5. Adjust the reduced rates of the burners.

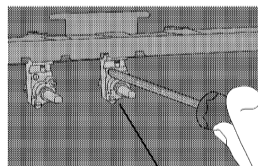

### A. Hob burners

- \* Adjust screw "A" 1-1 1/2 turns clockwise to obtain flame length of about 5 mm.
- \* Adjust each burner separately.

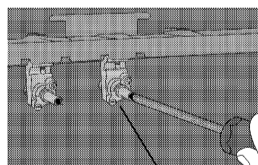

### A. Hob burners

- \* Adjust screw "A" 1-1 1/2 turns clockwise to obtain flame length of about 5 mm.
- \* Adjust each burner separately.

### B. Oven burner

- \* Adjust screw "B" 1/2 turn clockwise.
- \* Set oven thermostat to "1".
- \* Ignite oven burner.
- \* Close oven door and wait for thermostat to operate 10-15 minutes (reduced rate).
- \* Adjust screw "B" to obtain a flame length of 2-3 mm (rotation of screw "B" clockwise will decrease, anti-clockwise will increase the flame length).

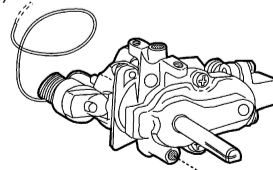

B: Oven thermostat

## 6. Apply the following labels;

- \* Overstick current rating plate with modified cut out label ensuring serial number is still visible.
- \* Tick appropriate LPG gas box and fix adjacent to the rating plate label.

**Conversion from LPG gas to NG**  
The conversion must only be implemented by a qualified engineer.

1. Replace the gas orifices by the NG equivalents.
2. Check gas soundness.
3. Take out the top lid, remove the burners' plate and remove the control panel as explained on the previous page.
4. Ignite the burner that should be adjusted, turn the knob to the reduced position, pull and take the knob off.
5. Adjust the reduced rates of the burners.

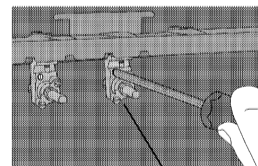

### A. Hob burners

- \* Adjust screw "A" 1-1 1/2 turns anti clockwise to obtain flame length of about 5 mm.
- \* Adjust each burner separately.

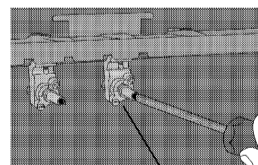

### A. Hob burners

- \* Adjust screw "A" 1-1 1/2 turns anti clockwise to obtain flame length of about 5 mm.
- \* Adjust each burner separately.

### B. Oven burner

- \* Adjust screw "B" 1/2 turn anticlockwise.
- \* Set oven thermostat to "1".
- \* Ignite oven burner.
- \* Close oven door and wait for thermostat to operate 10-15 minutes (reduced rate).
- \* Adjust screw "B" to obtain a flame length of 2-3 mm (rotation of screw "B" clockwise will decrease, anti-clockwise will increase the flame length).

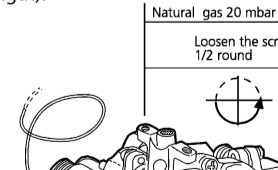

B: Oven thermostat

## 6. Apply the following labels;

- \* Overstick current rating plate with modified cut out label ensuring serial number is still visible.
- \* Tick appropriate NG gas box and fix adjacent to the rating plate label.

# preparation and burning off



## Important for asthmatic sufferers

Before using for the first time, protective coatings need to be burnt off. Fumes will be emitted but this is quite normal.

**Ensure the room is very well ventilated during the burning off process. Avoid directly inhaling the fumes during this process.**

## Grill

Open the grill door. Remove grill tray, wire rack and detachable handle and operate the grill for about 15 minutes.

## Oven

Remove baking tray and shelf racks and operate the oven at gas mark 8 for 30 minutes.

## Cleaning

Before you start using your cooker, clean the appliance as recommended under Care and cleaning on page 19.

## Shelf racks

The shelf racks with a heat deflection sheet should be positioned with the heat deflection sheet at the rear of the oven.

## Oven burner heat shield positioning

Before you start using your cooker please ensure the main oven burner heatshield is positioned as shown.

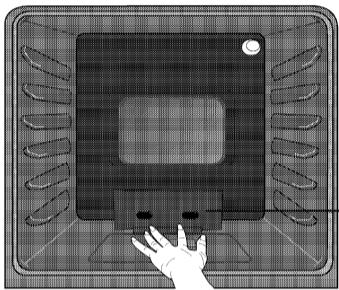

Oven heatshield

To locate press in the direction indicated above.

# preparation and burning off



## Important for asthmatic sufferers

Before using for the first time, protective coatings need to be burnt off. Fumes will be emitted but this is quite normal.

**Ensure the room is very well ventilated during the burning off process. Avoid directly inhaling the fumes during this process.**

## Grill

Open the grill door. Remove grill tray, wire rack and detachable handle and operate the grill for about 15 minutes.

## Oven

Remove baking tray and shelf racks and operate the oven at gas mark 8 for 30 minutes.

## Cleaning

Before you start using your cooker, clean the appliance as recommended under Care and cleaning on page 19.

## Shelf racks

The shelf racks with a heat deflection sheet should be positioned with the heat deflection sheet at the rear of the oven.

## Oven burner heat shield positioning

Before you start using your cooker please ensure the main oven burner heatshield is positioned as shown.

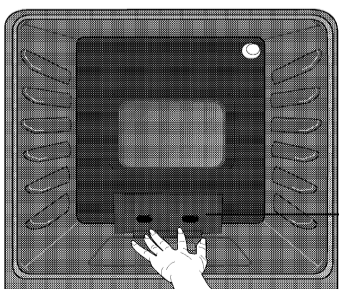

Oven heatshield

To locate press in the direction indicated above.

# electrical connection



## Important

### Fitting a different plug

As the colours of the wires in the mains lead of this appliance may not correspond with the coloured markings identifying the terminals on your plug, proceed as follows:

- 1 Connect the green - yellow or green (earth) wire to the terminal in the plug marked 'E' or with the symbol  $\perp$  or coloured green and yellow or green.
- 2 Connect the blue (neutral) wire to the terminal in the plug marked 'N' or coloured black.
- 3 Connect the brown (live) wire to the terminal in the plug marked 'L' or coloured red.

With the alternative plugs a 13A fuse must be fitted either in the plug or adaptor or in the main fuse box. If in doubt contact a qualified electrician.

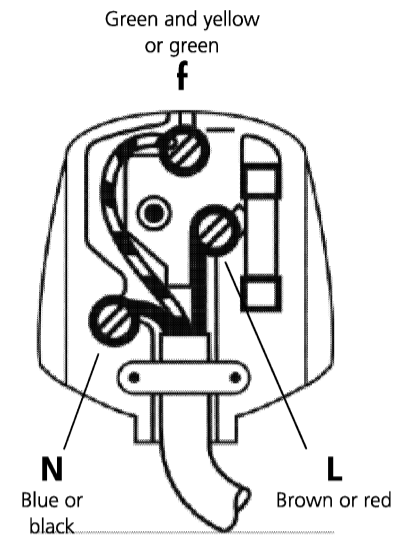

### Mains cable routing

The mains cable should be routed away from the appliance, the ventilation slots and the vent outlet. It should not be obstructed when pushed in to position between the appliance and the wall.

## \*Electrical requirements

Before you insert the plug into the wall socket make sure that the voltage and the frequency shown in the rating label corresponds to your electricity supply.

We recommend that this appliance be connected to the mains supply via a suitable switched and fused socket in a readily accessible position.

Should the mains lead of the appliance become damaged or need replacing at any time, it must be replaced by a special purpose made mains lead which can only be obtained from a Leisure consumer products Authorised Service Agent.



## Warning

### This appliance must be earthed

If the fitted moulded plug is not suitable for your socket, then the plug should be cut off and an appropriate plug fitted.

Destroy the old plug, which is cut off as a plug with a bared cord could cause a shock hazard if inserted into a socket elsewhere in the house.

The moulded plug on this appliance incorporates a 13A fuse. Should the fuse need to be replaced an ASTA approved BS1362 fuse of the same rating must be used. Do not forget to refit the fuse cover. In the event of losing the fuse cover, the plug must not be used until a replacement fuse cover has been fitted. Colour of the replacement fuse cover must be the same colour as that visible on the pin face of the plug. Fuse covers are available from any good electrical store.

\*Dependant on model.

## \*Electrical requirements

Before you insert the plug into the wall socket make sure that the voltage and the frequency shown in the rating label corresponds to your electricity supply.

We recommend that this appliance be connected to the mains supply via a suitable switched and fused socket in a readily accessible position.

Should the mains lead of the appliance become damaged or need replacing at any time, it must be replaced by a special purpose made mains lead which can only be obtained from a Leisure consumer products Authorised Service Agent.



## Warning

### This appliance must be earthed

If the fitted moulded plug is not suitable for your socket, then the plug should be cut off and an appropriate plug fitted.

Destroy the old plug, which is cut off as a plug with a bared cord could cause a shock hazard if inserted into a socket elsewhere in the house.

The moulded plug on this appliance incorporates a 13A fuse. Should the fuse need to be replaced an ASTA approved BS1362 fuse of the same rating must be used. Do not forget to refit the fuse cover. In the event of losing the fuse cover, the plug must not be used until a replacement fuse cover has been fitted. Colour of the replacement fuse cover must be the same colour as that visible on the pin face of the plug. Fuse covers are available from any good electrical store.

\*Dependant on model.

# electrical connection



## Important

### Fitting a different plug

As the colours of the wires in the mains lead of this appliance may not correspond with the coloured markings identifying the terminals on your plug, proceed as follows:

- 1 Connect the green - yellow or green (earth) wire to the terminal in the plug marked 'E' or with the symbol  $\perp$  or coloured green and yellow or green.
- 2 Connect the blue (neutral) wire to the terminal in the plug marked 'N' or coloured black.
- 3 Connect the brown (live) wire to the terminal in the plug marked 'L' or coloured red.

With the alternative plugs a 13A fuse must be fitted either in the plug or adaptor or in the main fuse box. If in doubt contact a qualified electrician.

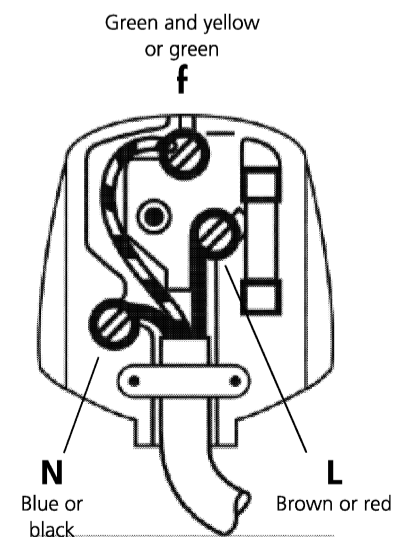

### Mains cable routing

The mains cable should be routed away from the appliance, the ventilation slots and the vent outlet. It should not be obstructed when pushed in to position between the appliance and the wall.

## Free Manuals Download Website

<http://myh66.com>

<http://usermanuals.us>

<http://www.somanuals.com>

<http://www.4manuals.cc>

<http://www.manual-lib.com>

<http://www.404manual.com>

<http://www.luxmanual.com>

<http://aubethermostatmanual.com>

Golf course search by state

<http://golfingnear.com>

Email search by domain

<http://emailbydomain.com>

Auto manuals search

<http://auto.somanuals.com>

TV manuals search

<http://tv.somanuals.com>